



Mr. Steven Scharf, P.E.
New York State Department of Environmental Conservation
Remedial Action, Bureau A
Division of Environmental Remediation
625 Broadway
Albany, NY 12233-7015

Subject:

Operable Unit 3 - Interim Operation, Maintenance, and Monitoring Report and Startup Summary for February 2008 to June 2008, Operable Unit 3 (Former Grumman Settling Ponds), Bethpage, New York, NYSDEC Site #1-30-003A.

Dear Steve:

Enclosed is one copy of the Operable Unit 3 – Interim Operation, Maintenance, and Monitoring Report and Startup Summary for February 2008 to June 2008, Former Grumman Settling Ponds, Bethpage, New York, NYSDEC Site #1-30-003A on CD.

In general, the system is operating as designed. As you recall, the Operable Unit 3 Soil Gas Interim Remedial Measure is equipped with a single 10,000 lb vapor phase granular activated carbon (VPGAC) unit to remove volatile organic compounds (VOCs [primarily trichloroethylene]) from the recovered soil-gas prior to discharge to the atmosphere. The VPGAC unit was provided for in the system design based on the results of initial air modeling that indicated treatment of the collected soil gas (specifically treatment of trichloroethylene) would be required to meet applicable discharge criteria during system startup based on the assumed design variables. However, it was anticipated that the concentrations in the collected soil gas would drop down to levels below applicable discharge criteria within a short time period. Furthermore, it was recommended in the approved 95% Design Report that the temporary VPGAC unit be taken off-line upon confirmation (through laboratory analytical results for the influent vapor stream) that the actual influent concentration of VOCs were below applicable standards.

Total influent vapor analytical data collected during the initial 28-day and extended startup periods are consistent with the design values presented in the Operable Unit 3 Soil Gas Interim Remedial Measure 95% Design Report. In addition, as expected, the concentration of trichloroethylene decreased significantly during the operating period. Specifically, the concentration of trichloroethylene decreased by greater than

Imagine the result

ARCADIS
Two Huntington Quadrangle
Suite 1S10
Melville
New York 11747
Tel 631.249.7600
Fax 631.249.7610
www.arcadis-us.com

ENVIRONMENT

Date:
August 7, 2008

Contact:
Carlo San Giovanni

Phone:
631-391-5259

Email:
Carlo.SanGiovanni@arcadis-us.com

Our ref:
NY001464.0908.00004

90-percent between February 18, 2008 and June 2, 2008. To determine the current regulatory status of influent vapor quality (e.g., the regulatory status of emissions prior to treatment), influent laboratory analytical results were compared to a site-specific annual maximum allowable stack concentration. The annual maximum allowable stack concentration (MASC) was calculated during each monitoring event for individual compounds using the output from a United States Environmental Protection Agency (USEPA) Screen 3 model in conjunction with the NYSDEC DAR-1 Annual Guideline Concentrations (AGCs). A detailed summary of the model inputs and outputs is provided in the attached monitoring report. A summary of the instantaneous percent (e.g., not time-weighted) of the site-specific annual MASC for detected compounds is provided in Attachment A-1. A summary of the cumulative percent (e.g., time-weighted) of the site-specific MASC for detected compounds is also provided on Attachment A-1. As shown in Attachment A-1, the instantaneous percent (e.g., not time-weighted) of the site-specific annual MASC for each of the detected compounds was less than 10-percent of their respective MASCs during the last three monitoring events. Likewise, the time-weighted site-specific cumulative percent of the annual MASC is well below the calculated discharge criteria. It is expected that influent vapor concentrations will continue to be stable to declining based on engineering experience at similar sites. Specifically, this trend is typical for depressurization systems due to continuous flushing/recovery of the pore vapors and generation of ambient air flow paths into the subsurface as a result of the negative pressure gradient established through depressurization.

Based on the analysis provided, Northrop Grumman Systems Corporation (NGC) requests approval to remove the temporary VPGAC unit. As a conservative measure, the VPGAC would be taken offline and removed in a phased approach. Specifically, it is proposed to take the VPGAC offline (e.g., bypassed) by no later than August 29, 2008. The VPGAC unit would remain on-site as a contingent measure for an additional three (3) months. If laboratory analytical data from the November 2008 monitoring event continue to indicate stable to decreasing analytical trends, the VPGAC would be removed from the site during December 2008.

ARCADIS

Mr. Steven Scharf, P.E.
August 7, 2008

If you have any questions, please do not hesitate to contact us at any time.

Sincerely,

ARCADIS

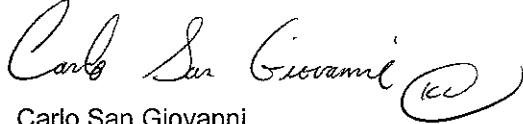

Carlo San Giovanni
Project Manager

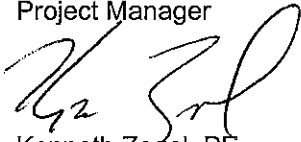

Kenneth Zegel, PE
Senior Engineer

Copies:

Steven Scharf – NYSDEC - 1 Hard copy and 1 Electronic copy
Jacquelyn Nealon, NYS Dept. of Health – 1 Hard copy.
Robert Weitzman, Nassau County Dept. of Health – 1 Hard copy.
John Cofman, NGC – 1 Hard copy and 1 Electronic copy
Kent Smith, NGC – 1 Electronic copy only
Jay Tolle, NGC – 1 Electronic copy only
Matt Russo, Town of Oyster Bay – 1 Hard copy
Jill Palmer, NGC – Electronic copy
File

Northrop Grumman Systems Corporation

**Operable Unit 3- Interim Operation,
Maintenance and Monitoring Report and
Startup Summary**

February 2008 to June 2008

Operable Unit 3 – Soil Gas Interim Remedial Measure
Former Grumman Settling Ponds
Bethpage, New York

NYSDEC ID # 1-30-003A

ARCADIS

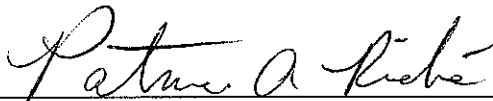

Patricia Riche
Environmental Engineering Specialist 2



Kenneth Zege, PE
Senior Engineer

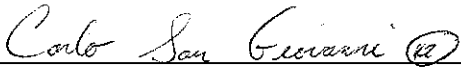

Carlo San Giovanni
Project Manager

**Operable Unit 3 – Interim Operation,
Maintenance, and Monitoring Report
and Startup Summary**

February 2008 to June 2008

Operable Unit 3 Soil Gas Interim
Remedial Measure

Former Grumman Settling Ponds
Bethpage, New York

NYSDEC ID# 1-30-003A

Prepared for:
Northrop Grumman Systems Corporation

Prepared by:
ARCADIS
Two Huntington Quadrangle
Suite 1S10
Melville
New York 11747
Tel 631.249.7600
Fax 631.249.7610

Our Ref.:
NY001464.0908.00004

Date:
August 7, 2008

This document is intended only for the use of the individual or entity for which it was prepared and may contain information that is privileged, confidential and exempt from disclosure under applicable law. Any dissemination, distribution or copying of this document is strictly prohibited.

1. Introduction	1
2. Soil Gas Interim Remedial Measure System Description	1
3. Operation and Maintenance Activities	3
3.1 System Mechanical Startup/Shakedown	3
3.2 Routine Operation and Maintenance	4
4. Monitoring Activities	5
4.1 System Startup/Shakedown Monitoring	5
4.1.1 System Operating Parameters	5
4.1.2 Vapor Samples	5
4.1.3 Condensate Samples	6
4.2 Routine Performance Monitoring	6
4.2.1 System Operating Parameters	6
4.2.2 Vapor Samples	7
4.3 Routine Compliance Monitoring	7
4.3.1 System Operating Parameters	7
4.3.2 Vapor Samples	7
4.3.3 Condensate Samples	7
5. Monitoring Results and Discussion	8
5.1 System Startup/Shakedown Monitoring	8
5.1.1 System Operating Parameters	8
5.1.2 Vapor Samples	10
5.1.3 Condensate Samples	12
5.2 Routine Performance Monitoring	13
5.2.1 System Operating Parameters	13
5.2.2 Vapor Samples	13
5.3 Routine Compliance Monitoring	14

5.3.1	Induced Vacuum Measurements	14
5.3.2	Vapor Samples	14
5.3.3	Condensate Samples	15
6.	Air Emissions Model	15
7.	System Construction Soil Management Summary	16
8.	Conclusions and Recommendations	16
8.1	Conclusions	16
8.2	Recommendations	18
9.	References	19

Tables

- Table 1 Summary of General System Operating Parameters, Northrop Grumman Operable Unit 3 Soil Gas Interim Remedial Measure, Former Grumman Settling Ponds, Bethpage, New York.
- Table 2 Summary of Induced Vacuum Readings, Northrop Grumman Operable Unit 3 Soil Gas Interim Remedial Measure, Former Grumman Settling Ponds, Bethpage, New York.
- Table 3 Summary of System Startup Vapor Sample Analytical Results, Northrop Grumman Operable Unit 3 Soil Gas Interim Remedial Measure, Former Grumman Settling Ponds, Bethpage, New York.
- Table 4 Summary of Total Influent and Effluent Vapor Sample Analytical Results, Northrop Grumman Operable Unit 3 Soil Gas Interim Remedial Measure, Former Grumman Settling Ponds, Bethpage, New York.
- Table 5 Summary of Condensate Sample Analytical Results, Northrop Grumman Operable Unit 3 Soil Gas Interim Remedial Measure, Former Grumman Settling Ponds, Bethpage, New York.
- Table 6 Air Emissions Model Output Summary, Northrop Grumman Operable Unit 3 Soil Gas Interim Remedial Measure, Former Grumman Settling Ponds, Bethpage, New York.

Figures

- Figure 1 Site Location Map, Northrop Grumman Operable Unit 3 Soil Gas Interim Remedial Measure, Former Grumman Settling Ponds, Bethpage, New York.
- Figure 2 General Site Plan, Northrop Grumman Operable Unit 3 Soil Gas Interim Remedial Measure, Former Grumman Settling Ponds, Bethpage, New York.
- Figure 3 Process Flow Diagram, Northrop Grumman Operable Unit 3 Soil Gas Interim Remedial Measure, Former Grumman Settling Ponds, Bethpage, New York.

Appendices

- A Summary of Vapor Sample Analytical Results Including Tentatively Identified Compounds
- B Summary of Condensate Sample Analytical Results Including Tentatively Identified Compounds
- C Air Modeling Calculations
- D Soil Management Summary

1. Introduction

This Operable Unit 3 (OU3) Soil Gas Interim Remedial Measure (soil gas IRM) Interim Operation, Maintenance, and Monitoring Report and Startup Summary were prepared by ARCADIS of New York, Inc. (ARCADIS) on behalf of Northrop Grumman Systems Corporation (Northrop Grumman). This report is being submitted pursuant to the Order On Consent (Consent Order or CO) Index # W1-0018-04-01 that was executed by the New York State Department of Environmental Conservation (NYSDEC) and Northrop Grumman, effective July 4, 2005 (NYSDEC 2005). The present day Bethpage Community Park property (Park), which the NYSDEC has termed the "Former Grumman Settling Ponds Area" and designated as OU3, is referred to herein as the Site. A site location map is provided on Figure 1.

This report summarizes the startup/shakedown, troubleshooting, and routine operation, maintenance and monitoring (OM&M) activities for the soil gas IRM performed from January 28 through June 2, 2008. System startup/shakedown was completed between January 28, 2008 and May 19, 2008 in accordance with the System Startup Plan, which was provided to the NYSDEC on February 8, 2008 as Attachment C-2 of the Soil Gas Interim Remedial Measure Sampling and Analysis Plan (ARCADIS 2008). The Sampling and Analysis Plan was provided to the NYSDEC as Appendix C of the Soil Gas Interim Remedial Measure 95% Design Report and Design Drawings dated September 7, 2007 (ARCADIS 2007). The Sampling and Analysis Plan was approved by the NYSDEC in a letter dated August 1, 2008 (NYSDEC 2008). In addition, this report provides a brief summary of the soil management activities and analytical results that were completed during the construction of the soil gas IRM. The Soil Management Plan and addendums were approved by the NYSDEC on November 16, 2007, December 7, 2007, and January 7, 2008 in accordance with the Soil Management Plan dated November 9, 2007, as amended by letters to NYSDEC dated November 27, 2007 and January 4, 2008.

A description of the soil gas IRM system startup/shakedown and OM&M activities completed during the reporting period is provided below.

2. Soil Gas Interim Remedial Measure System Description

The OU3 soil gas IRM was constructed in accordance with the Soil Gas Interim Remedial Measure 95% Design Report and Design Drawings which was approved by the NYSDEC on September 19, 2007. A general site plan that shows the major process equipment, depressurization, and monitoring well locations is provided on

Figure 2. A process flow diagram that shows sampling and monitoring locations is provided on Figure 3. A complete set of as-built drawings will be provided, under separate cover, as part of the Operation, Maintenance and Monitoring Manual.

In summary, the soil gas IRM consists of the following major components:

- 18 depressurization wells and 47 associated induced vacuum monitoring wells at the locations shown on Figure 2.
- Two (2) "dry-van" type storage containers, which contain the following equipment:
 - Three (3) 52-gallon moisture separators to remove condensate from the influent vapor stream;
 - Two (2) 20-horsepower(hp) and one (1) 30-hp regenerative type depressurization blowers;
 - A programmable logic controller (PLC) based control system;
 - An autodialer;
 - Associated piping, valves, sample ports, gauges, electrical equipment, and other devices necessary to safely control, operate, and monitor the system.
- One (1) heat exchanger to condition the effluent vapor stream prior to treatment; and,
- One (1) 10,000 pound (lb) vapor phase granular activated carbon bed (VPGAC).

A detailed description of the system will be provided in the Operations, Maintenance, and Monitoring Manual to be provided to the NYSDEC under separate cover. A description of the soil gas IRM system startup/shakedown and OM&M activities completed during the current reporting period is provided below.

3. Operation and Maintenance Activities

The following section provides a summary of the operation and maintenance activities completed during the referenced reporting period. A summary of the system startup/shakedown methodology and results is also provided.

3.1 System Mechanical Startup/Shakedown

System mechanical startup/shakedown was completed, in accordance with the System Startup Plan (ARCADIS 2008), during the weeks of January 28, 2008 and February 4, 2008. In summary, system mechanical startup/shakedown consisted of the following major components:

- Off-site testing of all major mechanical equipment, alarms, interlocks, and controls to ensure proper operation and motor rotation (in accordance with the specifications and manufacturer's requirements); this initial testing was completed by the equipment supplier within their construction yard prior to shipment to the Site;
- On-site testing of all major mechanical equipment, alarms, interlocks, and controls to ensure proper operation and motor rotation (in accordance with the specifications and manufacturer's requirements) prior to connecting the system to the depressurization wells;
- On-site testing of all electrical controls (i.e., level switches, transmitters, alarms etc.) to ensure proper operation (in accordance with the specifications and manufacturer's requirements) prior to connecting the system to the depressurization wells; and
- Final on-site troubleshooting and shakedown of the Main Control Panel (MCP).

A copy of the completed mechanical startup/shakedown testing forms will be provided in the Operation, Maintenance and Monitoring Plan to be provided under separate cover. In summary, the offsite and onsite mechanical startup/shakedown testing described above confirmed that the system mechanical and electrical components, including system alarms, were constructed and operated as designed.

The final phase of the mechanical startup/shakedown period was completed on February 6, 2008 and consisted of a brief operating period with the depressurization

February 2008 to June 2008

wells connected to the system. During this final phase of mechanical startup/shakedown, the depressurization wells were balanced for vacuum and flow in accordance with their initial design parameters provided in the 95% Design Report (ARCADIS 2007). Full time system operation began on February 18, 2008.

During the first two months of system operation, it was observed that the system performance was exceeding the design objectives. Specifically, induced vacuum monitoring data indicated that the combined capture zone of individual depressurization wells was far greater than anticipated based on the results of the pneumatic conductivity testing. The extended capture zone resulted in the recovery of vinyl chloride (VC) from areas outside of the design/target area. To evaluate the situation, ARCADIS petitioned the NYSDEC to extend the startup/troubleshooting period and NYSDEC granted approval. Accordingly, ARCADIS conducted a series of "extended" startup/troubleshooting OM&M site visits between March 18, 2008 and May 19, 2008 to troubleshoot and rebalance the depressurization wells in accordance with design objectives. The final depressurization well set points were established on April 10, 2008. The adjusted depressurization well capture zones resulted in an immediate decline in the recovery of VC. Furthermore, because the depressurization wells operated more efficiently than anticipated, the design capture zone was achieved through operation of 20 hp Blower BL-300 only. Accordingly, Blowers BL-200 and BL-400 were put on standby and have been offline since April 10, 2008.

Discussion of the system startup monitoring program and results is provided in subsequent sections of this report.

3.2 Routine Operation and Maintenance

The soil gas IRM operated continuously during the reporting period with only brief system shutdowns to perform routine maintenance or troubleshooting activities. Routine O&M activities were completed on a monthly basis following full time system operation on February 18, 2008. Routine O&M activities included inspection of all piping, appurtenances, and mechanical equipment for leaks, defects, or other problems and maintenance of equipment in accordance with the manufacturers' specifications.

Discussion of the routine OM&M program and results is provided in the subsequent sections of this report.

4. Monitoring Activities

The following sections summarize the methodology used for system startup/shutdown monitoring, routine performance monitoring, and routine compliance monitoring during the current reporting period.

4.1 System Startup/Shutdown Monitoring

System startup/shutdown monitoring was completed in accordance with the System Startup Plan, which was provided as Attachment C-2 of the Soil Gas Interim Remedial Measure Sampling and Analysis Plan dated February 8, 2008 (ARCADIS 2008). A discussion of deviations from the methodology described in the System Startup Plan, including the extended startup monitoring period for system rebalancing, is provided below.

4.1.1 System Operating Parameters

System operating parameters were collected in accordance with Table C-1.1 and Attachments C-1.1 through C-1.3 of the System Startup Plan. The primary deviation from the methodology described for the first 28 days of system startup was that due to time restraints caused by troubleshooting activities, system operating parameters were only collected once during Day 1 of startup.

Extended system startup operating parameter collection events were conducted on April 16 and May 19, 2008 to evaluate and confirm the system rebalancing troubleshooting activities described previously. Operating parameters were generally collected in accordance with the same criteria referenced in Attachments C-1.1 through C-1.3 of the System Startup Plan.

4.1.2 Vapor Samples

System vapor samples were collected in accordance with Table C-1.1 of the System Startup Plan for both qualitative (photoionization detector [PID]) and quantitative analysis (laboratory analysis). The primary deviation of the methodology described for the first 28 days of system startup was that, due to a sampling error, the Depressurization Well DW-3S sample for laboratory analysis was collected on February 25 instead of during Day 1 of startup (i.e., February 18, 2008).

February 2008 to June 2008

Extended system vapor sample collection events were conducted on April 16 and May 19, 2008 to evaluate and confirm the system rebalancing troubleshooting activities described previously. Similar to the first 28 days of startup, the additional sampling included the collection of vapor samples for both qualitative and quantitative analysis. Specifically, qualitative samples were collected from the individual depressurization wells and from the total influent and total effluent from the VPGAC. Total influent (VSP-601) and total effluent (VSP-602) vapor samples were submitted for laboratory analysis of site related constituents of concern (COCs) using EPA Method TO-15+, as outlined in the Sampling and Analysis Plan. In addition, vapor samples were collected and submitted for laboratory analysis from individual Depressurization Wells DW-3S, DW-7S, DW-4D, and DW-3D. These four samples were submitted to Air Toxics, Ltd. located in Folsom, California and analyzed for VOCs using their proprietary-modified EPA Method TO-15.

4.1.3 Condensate Samples

System condensate samples were collected from Moisture Separators KO-200 and KO-300 and Condensate Storage Tank ST-510 on March 17, 2008 in accordance with Table C-1.1 of the System Startup Plan. A condensate sample could not be collected from Moisture Separator KO-400 due to the lack of water generation during the reporting period.

4.2 Routine Performance Monitoring

Routine performance monitoring was completed on June 2, 2008, in accordance with Table C-1 of the Sampling and Analysis Plan. A brief discussion of the routine performance monitoring methodology and/or deviations from the methodology described in the Sampling and Analysis Plan is provided below.

4.2.1 System Operating Parameters

System operating parameters that fall under the performance monitoring program include the parameters listed in Attachments C-3.2 and C-3.3 of the Sampling and Analysis Plan. There were no significant deviations from the recording of these parameters during the routine monitoring event.

February 2008 to June 2008

4.2.2 Vapor Samples

One (1) routine performance monitoring vapor sample was collected for laboratory analysis from the total influent sample location (VSP-601) during the June 2, 2008 monitoring event. The sample was collected and submitted to the laboratory in accordance with the requirements set forth in the Sampling and Analysis Plan. In addition, supplemental performance monitoring vapor samples were collected from all individual depressurization wells for quantitative analysis using a PID.

4.3 Routine Compliance Monitoring

Routine compliance monitoring was completed on June 2, 2008 in accordance with Table C-1 of the Sampling and Analysis Plan. A brief discussion of the routine compliance monitoring methodology and/or deviations from the methodology described in the Sampling and Analysis Plan is provided below.

4.3.1 System Operating Parameters

System operating parameters that fall under the compliance monitoring program include the compliance related induced vacuum measurements listed in Attachments C-3.1 of the Sampling and Analysis Plan. There were no significant deviations from the recording of these parameters during the routine monitoring event.

4.3.2 Vapor Samples

One (1) routine compliance monitoring vapor sample was collected for laboratory analysis from the total effluent sample location (VSP-602) during the June 2, 2008 monitoring event. The sample was collected and submitted for laboratory analysis in accordance with the requirements set forth in the Sampling and Analysis Plan.

4.3.3 Condensate Samples

A compliance monitoring condensate sample was not collected for laboratory analysis between May 19, 2008 and June 2, 2008 due to a lack of water generation. However, the system startup/shakedown sample that was collected on March 17, 2008 from Storage Tank ST-510 will be used to satisfy the requirements set forth in the County of Nassau Department of Public Works discharge approval letter dated October 16, 2007 (County of Nassau, 2007). The sample was collected and submitted to the laboratory in accordance with the requirements set forth in the Sampling and Analysis Plan.

5. Monitoring Results and Discussion

The following sections summarize and briefly discuss the results for system startup/shutdown monitoring, routine performance monitoring, and routine compliance monitoring during the current reporting period.

5.1 System Startup/Shutdown Monitoring

This following section summarizes the results of the system startup/shutdown monitoring program.

5.1.1 System Operating Parameters

A summary of the system performance monitoring startup/shutdown operating parameters and water-level measurements for February 18, 2008 through May 19, 2008 is provided in Table 1. A summary of the system startup/shutdown induced vacuum measurements is provided in Table 2.

Except as described below, the system generally operated as anticipated and designed during the initial 28-day startup period (i.e., February 18, 2008 through March 17, 2008 [see Tables 1 and 2]). The primary deviation from the 95% design assumptions observed during the initial 28-day startup period was that the depressurization well network operated significantly more efficient (i.e., larger capture zones with a lower required flowrate and wellhead vacuum) than anticipated. This observation, combined with the observation of VC at elevated levels in the influent vapor stream (discussed further in Section 5.1.2), prompted rebalancing of the depressurization wells during the extended startup period, as previously discussed. Key data and observations are as follows:

- The observed wellhead vacuum and extraction flowrate at deep Depressurization Wells DW-7D, DW-3D, DW-5D, DW-6D, DW-1D, and DW-2D were similar to their design parameters during the initial 28-day startup period.
- The observed wellhead vacuum at deep Depressurization Well DW-4D was lower than anticipated during the initial 28-day startup period. Specifically, the design wellhead vacuum was -33.5 inches of water column (iwc) whereas the actual observed vacuum ranged from -3 iwc to -1.5 iwc.

February 2008 to June 2008

- The observed wellhead vacuum and extraction flowrate at shallow Depressurization Wells DW-1S, DW-2S, DW-3S, DW-4S, DW-6S, DW-7S, DW-8S, DW-9S, DW-10S, and DW-11S were similar to their design parameters during the initial 28-day startup period.
- The observed extraction flowrate at shallow Depressurization Well DW-5S was generally lower than anticipated during the initial 28-day startup period. Specifically, the design flowrate was 150 standard cubic feet per minute (scfm) at -3.9 iwc whereas the actual observed parameters were typically 20 scfm at -2.5 iwc to -1.5 iwc.
- The average induced vacuum reading for compliance-related monitoring points (for discussion purposes herein, compliance-related monitoring points are those monitoring points that are located the furthest lateral distance away from a respective depressurization well and include Monitoring Wells VMWC-3A, 3B, 3C, 3D, 7A, 7B, 11B, 12D, 13D, 14A, 14B, 14D, 15A, 15B, 15D, 16A, 16B, 16D, 17D, 18A, and 18B) measured during the initial 28-day startup period was approximately -0.317 iwc. This value is higher than the design induced vacuum of -0.1 iwc.
- The average induced vacuum reading at non-compliance monitoring points (non-compliance monitoring points include all monitoring points that are not designated as compliance monitoring points) measured during the initial 28-day startup period, was approximately -0.64 iwc.
- The average induced vacuum reading for compliance-related monitoring points measured during the extended startup period was approximately -0.137 iwc.
- The average induced vacuum reading at non-compliance related monitoring points measured during the extended startup period was approximately -0.35 iwc.
- The depressurization blowers operated in accordance with their respective blower curves based on their respective total influent vacuum, total effluent pressure, and total extraction flowrates.
- Condensate water was generated at a rate lower than the anticipated design generation rate. Specifically, approximately 178 gallons of condensate water was generated from Condensate Knockout Tanks KO-200 (99 gallons), KO-300

February 2008 to June 2008

(79 gallons), and KO-400 (0-gallons), respectively during the initial and extended startup/shutdown period.

- Perched water was not encountered in induced vacuum monitoring wells VMWC-1C or VMWC-5B.
- The heat exchanger influent temperature was lower than the design influent temperature of 150 degrees Fahrenheit (deg F) during the initial and extended startup period and ranged from 104 deg F to 85 deg F. The lower observed temperature is the direct result of more efficient system operation (e.g., lower required vacuum, flowrate, and pressure to achieve the design capture zone). Specifically, the depressurization blowers operate lower on their respective blower curves resulting in less motor heat generation and transfer. Accordingly, the heat exchanger was put on standby (e.g., not operational) because the vapor stream required no additional conditioning prior to entering the VPGAC unit.

A summary of system startup vapor and condensate sample field and laboratory analytical results is provided below.

5.1.2 Vapor Samples

A summary of the system startup/shutdown qualitative vapor sample analytical results (i.e., PID readings) is provided in Table 1. A summary of the system startup/shutdown individual depressurization well vapor sample laboratory analytical results for detected compounds is provided in Table 3. A summary of the system startup/shutdown total influent and total effluent vapor sample laboratory analytical results for detected compounds is provided in Table 4. A summary of all vapor sample analytical results (including detected, non-detect, and tentatively identified compounds [TICs]) is provided in Appendix A.

In general, depending on the specific location sampled, the individual depressurization well influent quantitative and qualitative volatile organic compound (VOC) analytical results varied (i.e., higher or lower) compared to their respective design concentrations. However, the overall combined total influent concentration was generally consistent with the design concentrations during the initial and extended startup/shutdown period. As discussed previously, VC was unexpectedly observed at elevated concentrations beginning with the March 2, 2008 startup monitoring event and ending with the May 19, 2008 extended startup monitoring event. The decrease in VC observed during the May 19, 2008 event is attributed to the system

February 2008 to June 2008

troubleshooting/rebalancing activities completed during the extended startup period. Specific observations from applicable laboratory analytical data are as follows:

- Total VOCs (TVOC) concentrations for Depressurization Wells DW-7S (44,510 micrograms per meter cubed [ug/m³]), DW-7D (137,380 ug/m³), DW-3S (3,844 ug/m³), and DW-1D (1,907 ug/m³) were higher than their respective design concentrations.
- TVOC concentrations for Depressurization Wells DW-3D (74,448 ug/m³), DW-5S (471 ug/m³), DW-5D (1,676 ug/m³), DW-6S (674 ug/m³), DW-6D (1,994 ug/m³), DW-8S (1,189 ug/m³), DW-9S (349 ug/m³), DW-10S (214 ug/m³), and DW-11S (282 ug/m³) were lower than their respective design concentrations.
- TVOC concentrations for Depressurization Wells DW-1S (778 ug/m³), DW-4S (1,669 ug/m³), DW-4D (1,832 ug/m³), DW-2S (1,328 ug/m³), and DW-2D (987 ug/m³) were consistent with their respective design concentrations.
- The TVOC concentration for the total influent sampling location (i.e., VSP-601) was slightly higher than its' respective design concentration for Day 1 of system startup/shakedown (20,622 ug/m³) but steadily declined to below its' respective design concentration thereafter. Specifically, the TVOC concentration was 2,118 ug/m³ during the final monitoring event (May 19, 2008) conducted during the extended startup period. This trend is typical for depressurization systems due to continuous flushing/recovery of the pore vapors and generation of ambient air flow paths into the subsurface as a result of the negative pressure gradient established through depressurization.
- The TVOC concentration for the total effluent sampling location (i.e., VSP-602 – located after treatment through the VPGAC unit) was as expected and ranged from below the limits of detection during Day 1 of system startup to a maximum of 920 ug/m³ observed during the March 17, 2008 monitoring event. The increase in TVOCs during the March 17, 2008 monitoring event was a direct result of the capture of VC discussed above. However, the concentration of VC dropped significantly as a result of the system troubleshooting/rebalancing activities completed during the extended startup period. Specifically, the concentration of VC was 65 ug/m³ during the May 19, 2008 monitoring event. Despite the presence of VC in the effluent air stream, the cumulative air emissions for VC is still significantly lower than its respective emissions limit. A

description of the air emissions modeling results are provided in Section 6 of this report.

- Several TICs were detected in individual depressurization wells with cumene being detected most consistently.
- Several TICs were also identified in the total influent and total effluent vapor samples. Currently, ARCADIS does not believe that further investigation is warranted based on the TIC data. However, TICs will continue to be evaluated in future monitoring events. It should be noted that cumene was not detected in the total influent and total effluent vapor samples.

A summary of system startup condensate sample laboratory analytical results is provided below.

5.1.3 Condensate Samples

A summary of the system startup/shakedown condensate sample laboratory analytical results for detected compounds is provided in Table 5. A summary of laboratory analytical results for all compounds (including detected, non-detect, and TICs) is provided in Appendix B.

Except as described below, condensate sample laboratory analytical results were as anticipated and contained generally low levels of site-related VOCs. 2-Butanone (MEK) was detected at a comparatively elevated concentration of 1 milligrams per liter (mg/L) and 1.3 mg/L for Moisture Separators KO-200 and KO-300, respectively. It is unclear if the presence of this compound is the result of system construction activities (e.g., PVC glue/primer, etc.) or if it is a site-related COC.

Laboratory analytical results for Storage Tank ST-510 (i.e., sample ID WSP-510) generally contained the same suite of compounds observed within individual Moisture Separators KO-200 and KO-300 but at comparatively lower concentrations. The lower concentration observed in the storage tank is likely the result of volatilization.

Several TICs were identified in the condensate samples. Currently, ARCADIS does not believe that the data warrant additional investigation at this time. ARCADIS will continue to monitor TIC data during future sampling events.

5.2 Routine Performance Monitoring

This following section summarizes the results of the routine system performance monitoring event completed on June 2, 2008.

5.2.1 System Operating Parameters

A summary of the performance monitoring system operating parameters for the June 2, 2008 monitoring event is provided in Table 1. A summary of non-compliance (e.g., performance monitoring) induced vacuum measurements is provided in Table 2.

As shown in Table 1, system operating parameters recorded in June 2008 remained consistent with operating parameters recorded during the final extended startup/shutdown monitoring event conducted in May 2008. These data suggest that the system is running as designed and is maintaining a negative pressure curtain along the southern and western property boundaries. Additional key data and observations are as follows:

- The observed wellhead vacuum and extraction flowrate remained generally consistent in all depressurization wells when comparing May 19, 2008 to June 2, 2008 monitoring data.
- The average induced vacuum reading at non-compliance monitoring points was approximately -0.312 iwc for all monitoring points measured during the June 2008 monitoring event.
- Condensate water was not generated between May 19, 2008 and June 2, 2008.
- Perched water was not encountered in induced vacuum monitoring wells VMWC-1C or VMWC-5B.
- The heat exchanger influent temperature (85 deg F) remained lower than the design influent temperature of 150 degrees. Accordingly, the heat exchanger was kept on standby between May 19, 2008 and June 2, 2008.

5.2.2 Vapor Samples

A summary of the June 2008 qualitative vapor sample analytical results is provided in Table 1. A summary of the June 2008 total influent vapor sample laboratory analytical

February 2008 to June 2008

results for detected compounds is provided in Table 4. A summary of all vapor sample analytical results (including detected, non-detect, and tentatively identified compounds [TICs]) is provided in Appendix A.

Qualitative vapor analyses (e.g., PID) were consistent with startup/shutdown data and were generally below the limits of detection for all samples collected. Total influent (VSP-601) laboratory analytical results for the June 2, 2008 monitoring event were consistent with analytical results from May 19, 2008. Specifically, TVOC concentrations were 2,232 ug/m³) during the June 2008 monitoring event. VC concentration was below the limits of detection.

Chlorodifluoromethane and an unknown CFC were reported as TICs by the laboratory during the June 2008 monitoring event. However, ARCADIS does not believe that further investigation is warranted at this time.

5.3 Routine Compliance Monitoring

This following section summarizes the results of the routine system compliance monitoring event completed on June 2, 2008.

5.3.1 Induced Vacuum Measurements

Induced vacuum measurements collected during the June 2, 2008 monitoring event are summarized in Table 2. As referenced in the 95% Design Report, the soil gas IRM was designed to maintain a negative pressure of -0.1 iwc on a time-weighted rolling average within all monitoring points. Accordingly, the time-weighted rolling average for all induced vacuum monitoring points has been provided in Table 2. As shown on Table 2, the rolling average for all individual monitoring points was greater than -0.1 iwc as of June 2, 2008. Specifically, the average induced vacuum for compliance monitoring wells during the June 2, 2008 monitoring event was -0.146 iwc which indicate that the soil gas IRM is operating as designed.

5.3.2 Vapor Samples

A summary of the June 2008 qualitative vapor sample analytical results is provided in Table 1. A summary of the June 2008 total effluent vapor sample laboratory analytical results for detected compounds is provided in Table 4. A summary of all vapor sample analytical results (including detected, non-detect, and tentatively identified compounds [TICs]) is provided in Appendix A.

Qualitative vapor analyses (e.g., PID) were consistent with startup/shakedown data and were below the limits of detection. Total effluent (VSP-602) laboratory analytical results for the June 2, 2008 monitoring event were consistent with analytical results from May 19, 2008. Specifically, the TVOC concentration was 274 ug/m³ during the June 2008 monitoring event. VC detected at a concentration (13 ug/m³) that is slightly above the limits of detection. A summary of the air emissions model completed to confirm compliance with applicable air discharge standards is provided in Section 6.

5.3.3 Condensate Samples

As discussed previously, laboratory analytical results for Storage Tank ST-510 collected on March 17, 2008 will be used for compliance monitoring purposes during the current reporting period. TVOC were detected at a concentration of 0.515 mg/L, which is below the discharge standard of 1 mg/L set forth by the Town of Oyster Bay.

6. Air Emissions Model

Effluent vapor laboratory analytical results were compared to the NYSDEC Division of Air Resources Air Guide-1 (DAR-1) Short-term Guideline Concentrations (SGCs). In addition, effluent vapor laboratory analytical results were compared to a site-specific modeled annual maximum allowable stack concentration. The annual maximum allowable stack concentration (MASC) was calculated during each monitoring event for individual compounds using the output from a United States Environmental Protection Agency (USEPA) Screen 3 model in conjunction with the NYSDEC DAR-1 Annual Guideline Concentrations (AGCs). Specifically, a scaling factor was calculated using the SCREEN3 model with site-specific physical layout (e.g., building dimension, stack height, terrain, etc.) and operating data (e.g., discharge flowrate, temperature, etc.) inputs for each monitoring event. The scaling factor was then used to adjust (scale) the NYSDEC DAR-1 AGC to a site-specific annual MASC. A summary of the instantaneous percent (e.g., not time-weighted) of the site-specific annual MASC for detected compounds is provided in Table 6. A summary of the cumulative annual percent (e.g., time-weighted) of the site-specific MASC for detected compounds is also provided on Table 6. A summary of the model input, outputs, and backup calculations is provided in Appendix C.

In summary, the soil gas IRM effluent vapor met applicable air discharge criteria based on the following:

- The actual concentrations of individual VOCs in the vapor effluent did not exceed their respective SGCs during all monitoring events (Table 3). It should also be noted that all influent (e.g., prior to treatment) individual VOC concentrations were also below their respective SGCs.
- The actual concentration of individual VOCs in the vapor effluent did not exceed their respective instantaneous MASCs as calculated using the USEPA SCREEN 3 Model (Table 6). Similarly, the time-weighted rolling average for all detected compounds is currently well below the MASCs. It should be noted that the instantaneous percent of the site-specific annual MASC for all detected compounds was less than 1-percent during the June 2008 monitoring event and has been declining since the March 17, 2008 monitoring event. It is anticipated that this trend will continue based on the system rebalancing/troubleshooting activities described previously.

7. System Construction Soil Management Summary

As discussed in Section 1 of this report, soils containing constituent concentrations (e.g., VOCs, metals, and polychlorinated biphenyls [PCBs]) above applicable cleanup standards were encountered and managed during the construction of the soil gas IRM. Soils were managed in accordance with the NYSDEC approved Soil Management Plan. A summary of the laboratory analytical results (i.e., waste profile) and waste manifests has been provided in Appendix D. Additionally, a summary of analytical results and delivery tickets for imported recycled concrete aggregate (RCA) and backfill that was used as structural fill during system construction has also been provided.

8. Conclusions and Recommendations

Based on the information provided herein, ARCADIS makes the following conclusions:

8.1 Conclusions

- The off-site and on-site mechanical soil gas IRM system startup/shutdown testing confirmed that the system mechanical and electrical components, including system alarms, were constructed and operate as designed.
- System startup operating parameters collected during the initial 28-day system startup period indicate that the depressurization wells operate more efficiently

February 2008 to June 2008

than anticipated resulting in large capture zones that exceeded design parameters. This resulted in the recovery of VC from on-site locations outside of the design capture zone. Accordingly, the system startup period was extended and additional troubleshooting/well rebalancing was performed.

- Induced vacuum measurements and influent vapor analytical data collected during the extended system startup period indicated that the rebalancing efforts were successful in achieving its' objectives. Specifically, the capture zones were lowered to their respective design values. To achieve the reduced recovery rates, Blowers BL-200 and BL-400 were taken offline and the depressurization well flowrates were rebalanced.
- VPGAC influent temperature data indicate that the heat exchanger is currently not required to condition the air prior to treatment. Accordingly, the heat exchanger was taken offline and is currently on standby.
- VPGAC effluent data indicate that the VPGAC unit is removing trichloroethylene from the influent vapor stream as designed.
- Condensate water analytical data from Storage Tank ST-510 indicate that the condensate water is in compliance with the discharge requirements set forth by the Town of Oyster Bay POTW.
- June 2008 compliance monitoring results indicate that the system continues to operate as designed. Specifically, a time-weight average induced vacuum of greater than -0.1 iwc was achieved in all induced vacuum monitoring points.
- The actual concentrations of individual VOCs in the vapor effluent did not exceed their respective SGCs during the reporting period.
- The actual concentration of individual VOCs in the vapor effluent did not exceed their respective MASCs as calculated using the USEPA SCREEN 3 model. In addition, the instantaneous percent of the site-specific annual MASC for all detected compounds was less than 1-percent during the June 2008 monitoring event.

8.2 Recommendations

Based on the information provided herein, ARCADIS makes the following recommendations:

- Continue operating the system in accordance with system operating parameters implemented during the extended system startup period.
- Continue to collect system operational data and influent and effluent vapor samples for laboratory analysis on a monthly basis for the next two operating months (e.g., July and August 2008). If data is favorable and continue to indicate a stable trend for all operating parameters and vapor analytical data, perform performance and compliance monitoring on a quarterly basis thereafter.
- Collect induced vacuum measurements from the list of compliance related induced vacuum monitoring wells only during future monitoring events. Non-compliance related induced vacuum monitoring data shall only be collected when system troubleshooting is required, based on the results of compliance related induced vacuum data.

9. References

ARCADIS of New York, Inc. 2007. 95% Design Report, Operable Unit 3 Soil Gas Interim Remedial Measure, Former Grumman Settling Ponds, Bethpage, New York, Site #1-30-003A September 7, 2007.

ARCADIS of New York, Inc. 2008. 95% Design Report, Appendix C, Sampling and Analysis Plan, Operable Unit 3 Soil Gas Interim Remedial Measure, Former Grumman Settling Ponds, Bethpage, New York, Site #1-30-003A February 8, 2008.

ARCADIS of New York, Inc. 2008. 95% Design Report, Attachment C-2, System Startup Plan, Operable Unit 3, Soil Gas Interim Remedial Measure, Former Grumman Settling Ponds, Bethpage, New York, Site #1-30-003A January 29, 2008.

ARCADIS 2007. Letter to Steve Scharf re: Soil Management Plan dated November 9, 2007

ARCADIS 2008. Letter to Steve Scharf re: Addendum to Soil Management Plan dated November 27, 2008.

ARCADIS 2008. Letter to Steve Scharf re: Addendum to Soil Management Plan dated January 4, 2008.

New York State Department of Environmental Conservation (NYSDEC), 2008, Approval Letter regarding Former Grumman Settling Ponds, NYSDEC Nassau County Site No. 1-30-003A OU3 (Bethpage Community Park), August 1, 2008.

New York State Department of Environmental Conservation (NYSDEC), 2005, Order on Consent Index #WI-0018-04-01, Site # 1-30-003A, July 4, 2005.

New York State Department of Environmental Conservation, Division of Air Resources-1 (DAR-1) Guidelines for the Control of Toxic Ambient Air Contaminants dated 1991 and the AGC/SGC Tables dated December 22, 2003.

County of Nassau Department of Public Works Letter, Discharge IRM Condensate Water Northrop, Grumman, OU3 Site, Bethpage, New York. October 16, 2007.

Table 1. Summary of General System Operating Parameters, Northrop Grumman Operable Unit 3, Soil Gas Interim Remedial Measure, Former Grumman Settling Ponds, Bethpage, New York.

Date	Extraction Well DW-7S Parameters					Extraction Well DW-7D Parameters					Extraction Well DW-3S Parameters					Extraction Well DW-3D Parameters					Extraction Well DW-5S Parameters					Extraction Well DW-5D Parameters				
	Flow Rate at Manifold	Vacuum at Manifold	Temperature at Manifold	PID Measured Concentration	Wellhead Vacuum	Flow Rate at Manifold	Vacuum at Manifold	Temperature at Manifold	PID Measured Concentration	Wellhead Vacuum	Flow Rate at Manifold	Vacuum at Manifold	Temperature at Manifold	PID Measured Concentration	Wellhead Vacuum	Flow Rate at Manifold	Vacuum at Manifold	Temperature at Manifold	PID Measured Concentration	Wellhead Vacuum	Flow Rate at Manifold	Vacuum at Manifold	Temperature at Manifold	PID Measured Concentration	Wellhead Vacuum	Flow Rate at Manifold	Vacuum at Manifold	Temperature at Manifold	PID Measured Concentration	Wellhead Vacuum
	(scfm)	(iwc)	(°F)	(ppmv)	(iwc)	(scfm)	(iwc)	(°F)	(ppmv)	(iwc)	(scfm)	(iwc)	(°F)	(ppmv)	(iwc)	(scfm)	(iwc)	(°F)	(ppmv)	(iwc)	(scfm)	(iwc)	(°F)	(ppmv)	(iwc)	(scfm)	(iwc)	(°F)	(ppmv)	(iwc)
2/18/08 ⁽¹⁾	58	-3.55	55.7	7.2	-2.0	76	-7.2	56.1	29.3	-2.5	80	-7.3	55.7	2.8	-2.5	113	-15.43	53.9	13.3	-4.5	100	-4.6	57.2	0.0	-3.0	52	-16.1	56.8	0.0	-13.5
2/19/08 ⁽¹⁾	53	-3.80	NM	9.7	-2.0	78	-7.4	NM	26.7	-2.5	45	-2.5	NM	6.5	-1.75	108	-16.3	NM	16.4	-3.5	57	-2.5	NM	0.0	-2.0	52	-18	NM	0.0	-13.5
2/25/08 ⁽¹⁾	55	-5.5	NM	4.2	-2.0	74	-13	NM	5.8	-2.7	37	-2.03	NM	2.1	-1.5	71	-26	NM	6.6	-2.7	20	-1.05	NM	0.4	-1.5	56	-24.1	NM	0.0	-17.5
3/3/08 ⁽¹⁾	53	-6	NM	2.8	-2.0	84	-13.0	NM	0.8	-2.7	45	-2.5	NM	1.2	-1.5	88	-16	NM	1.9	-2.7	20	-1.4	NM	0.8	-1.5	66	-27	NM	0.0	-15.2
3/17/08 ⁽¹⁾	76	-9	NM	2.6	-2.5	50	-8.00	NM	0.4	-2.0	45	-2.8	NM	1.1	-2.0	83	-16	NM	0.1	-2.7	20	-1.5	NM	0.0	-2.5	70	-32	NM	0.0	-25.0
04/16/08	84.97	-10.46	50.3	2.7	NM	41.10	-2	55.4	2.0	NM	15.48	-0.41	58.6	0.6	NM	28.56	-1.07	57.0	4.6	NM	34.44	-0.77	55.0	0.0	NM	33.95	-0.22	57.5	0.6	NM
05/19/08	72.43	-5.0	57.0	5.0	-4.0	19.76	-0.800	62.2	2.1	-1.5	14.98	-0.45	62.2	0.0	-2.0	23.35	-2.0	59.3	3.5	-3.0	77.92	-2.5	59.9	2.5	-2.5	19.73	-14.0	59.0	0.0	-10.5
06/02/08	86.01	-5.8	65.8	0.0	-1.8	23.40	-0.7	72.8	0.0	-0.9	16.09	-0.4	71.0	0.0	-1.1	26.95	-2.0	71.7	0.0	-1.3	86.18	-2.3	65.4	0.0	-2.8	16.56	-14.0	74.3	0.0	-10.0

Notes and Abbreviations:

- *F - Degrees Fahrenheit
- DW- Depressurization well
- ft bmp - Feet below measuring point
- iwc - Inches of water column
- NM -Not measured
- scfm - Standard cubic feet per minute
- ppmv - Parts per million by volume
- VMWC - Vapor monitoring well cluster

1. Flow rate at manifold on associated dates quantified using venturi flow meter and associated flow chart. Remaining flow rates measured with a hotwire anemometer and calculated to standard conditions using the formula below.
2. Access point covered by insulation no measurement taken during this round.
3. Blowers BL-200 and BL-400 were taken off-line on April 10th during system rebalancing.
4. Field recording error suspected.

Standard Conditions Calculation:

$$scfm = Flowrate \cdot Area \cdot (Ts/Tm) \cdot (Pm/Ps)$$

- Flowrate in feet per minute
- Area in square feet
- Ts - Standard Temperature in Rankine
- Tm - Measured Temperature in Rankine
- Pm - Measured Pressure in pounds per square inch
- Ps - Standard Pressure in pounds per square inch

Table 1. Summary of General System Operating Parameters, Northrop Grumman Operable Unit 3, Soil Gas Interim Remedial Measure, Former Grumman Settling Ponds, Bethpage, New York.

Date	Extraction Well DW-6S Parameters					Extraction Well DW-6D Parameters					Extraction Well DW-1S Parameters					Extraction Well DW-1D Parameters					Extraction Well DW-4S Parameters					Extraction Well DW-4D Parameters					
	Flow Rate at Manifold	Vacuum at Manifold	Temperature at Manifold	PID Measured Concentration	Wellhead Vacuum	Flow Rate at Manifold	Vacuum at Manifold	Temperature at Manifold	PID Measured Concentration	Wellhead Vacuum	Flow Rate at Manifold	Vacuum at Manifold	Temperature at Manifold	PID Measured Concentration	Wellhead Vacuum	Flow Rate at Manifold	Vacuum at Manifold	Temperature at Manifold	PID Measured Concentration	Wellhead Vacuum	Flow Rate at Manifold	Vacuum at Manifold	Temperature at Manifold	PID Measured Concentration	Wellhead Vacuum	Flow Rate at Manifold	Flow Rate at Manifold	Vacuum at Manifold	Temperature at Manifold	PID Measured Concentration	Wellhead Vacuum
	(scfm)	(iwc)	(°F)	(ppmv)	(iwc)	(scfm)	(iwc)	(°F)	(ppmv)	(iwc)	(scfm)	(iwc)	(°F)	(ppmv)	(iwc)	(scfm)	(iwc)	(°F)	(ppmv)	(iwc)	(scfm)	(iwc)	(°F)	(ppmv)	(iwc)	(scfm)	(fpm)	(iwc)	(°F)	(ppmv)	(iwc)
2/18/08 ⁽¹⁾	170	-13.1	55.0	0.0	-6.0	44	-16.0	60.2	0.0	-14.0	160	-11.8	54.1	0.0	-5.0	20	-16.8	62.4	0.0	-15.0	170	-12.0	54.6	0.0	-2.0	8	268	-2.0	60.8	0.0	-3.0
2/19/08 ⁽¹⁾	167	-13.6	NM	0.0	-6.0	48	-17.5	NM	0.0	-14.0	235	-19.78	NM	0.0	-8.0	20	-18	NM	0.0	-16.0	155	-13.5	NM	0.0	-5.5	8	253	-1.95	NM	0.0	-1.5
2/25/08 ⁽¹⁾	167	-16.0	NM	0.0	-6.0	94	-23.5	NM	0.0	-20.5	228	-25.4	NM	NM	-7.2	28	-24.25	NM	0.0	-25.0	160	-16.0	NM	0.0	-5.5	8	160	-1.1	NM	0.0	-2.0
3/3/08 ⁽¹⁾	170	-16.0	NM	0.5	-5.5	55	-25.2	NM	0.0	-20	208	-26.79	NM	0.1	-7.0	32	-26.5	NM	0.0	-25.0	160	-16.0	NM	1.1	-5.70	8	110	-1.0	NM	0.0	-2.0
3/17/08 ⁽¹⁾	185	-22	NM	0.0	-6.0	65	-31	NM	1.2	-22	208	-29	NM	0.0	-7.5	32	-32.6	NM	0.0	-30	176	-26	NM	0.0	-6.0	8	124	-1.25	NM	0.0	-1.75
4/16/2008	49.50	-1.44	53.6	0.2	NM	10.55	-1.86	57.5	1.9	NM	89.48	-3.31	52.3	0.0	NM	3.97	-0.79	61.3	0.0	NM	48.16	-1.43	55.5	0.0	NM	9.27	214	-0.48	60.6	0.0	NM
05/19/08	42.93	-1.2	61.8	2.5	-1.3	11.47	-2.6	60.0	0.0	-2.0	147.62	-10.5	55.5	0.0	-4.5	6.60	-1.8	64.4	0.3	-2.5	32.14	-1.0	61.7	1.7	-2.7	15.01	349	-1.1	63.3	0.6	-2.2
06/02/08	48.18	-1.2	68.0	0.0	-1.2	14.88	-2.2	72.5	0.0	-2.5	179.95	-10.3	61.3	0.0	-4.2	8.54	-1.8	74.1	0.0	-5.1	30.98	-0.7	66.2	0.0	-2.1	17.44	412	-1.2	71.6	0.0	-2.7

Notes and Abbreviations:

- *F - Degrees Fahrenheit
- DW- Depressurization well
- ft bmp - Feet below measuring point
- iwc - Inches of water column
- NM -Not measured
- scfm - Standard cubic feet per minute
- ppmv - Parts per million by volume
- VMWC - Vapor monitoring well cluster

1. Flow rate at manifold on associated dates quantified using venturi flow meter and associated flow chart. Remaining flow rates measured with a hotwire anemometer and calculated to standard conditions using the formula below.
2. Access point covered by insulation no measurement taken during this round.
3. Blowers BL-200 and BL-400 were taken off-line on April 10th during system rebalancing.
4. Field recording error suspected.

Standard Conditions Calculation:

$$scfm = Flowrate * Area * (Ts/Tm) * (Pm/Ps)$$

- Flowrate in feet per minute
- Area in square feet
- Ts - Standard Temperature in Rankine
- Tm - Measured Temperature in Rankine
- Pm - Measured Pressure in pounds per square inch
- Ps - Standard Pressure in pounds per square inch

Table 1. Summary of General System Operating Parameters, Northrop Grumman Operable Unit 3, Soil Gas Interim Remedial Measure, Former Grumman Setting Ponds, Bethpage, New York.

Date	Extraction Well DW-8S Parameters					Extraction Well DW-9S Parameters					Extraction Well DW-2S Parameters					Extraction Well DW-2D Parameters					Extraction Well DW-10S Parameters					Extraction Well DW-11S Parameters				
	Flow Rate at Manifold	Vacuum at Manifold	Temperature at Manifold	PID Measured Concentration	Wellhead Vacuum	Flow Rate at Manifold	Vacuum at Manifold	Temperature at Manifold	PID Measured Concentration	Wellhead Vacuum	Flow Rate at Manifold	Vacuum at Manifold	Temperature at Manifold	PID Measured Concentration	Wellhead Vacuum	Flow Rate at Manifold	Vacuum at Manifold	Temperature at Manifold	PID Measured Concentration	Wellhead Vacuum	Flow Rate at Manifold	Vacuum at Manifold	Temperature at Manifold	PID Measured Concentration	Wellhead Vacuum	Flow Rate at Manifold	Vacuum at Manifold	Temperature at Manifold	PID Measured Concentration	Wellhead Vacuum
	(scfm)	(iwc)	(°F)	(ppmv)	(iwc)	(scfm)	(iwc)	(°F)	(ppmv)	(iwc)	(scfm)	(iwc)	(°F)	(ppmv)	(iwc)	(scfm)	(iwc)	(°F)	(ppmv)	(iwc)	(scfm)	(iwc)	(°F)	(ppmv)	(iwc)	(scfm)	(iwc)	(°F)	(ppmv)	(iwc)
2/18/08 ⁽¹⁾	135	-9.1	55.0	0.0	-3.0	72	-10.0	57.3	0.0	-4.5	45	-5.1	61.1	0.0	-2.5	80	-11.9	55.2	0.0	-7.0	75	-13.5	57.5	0.0	-5.0	80	-1.5	55.2	0.0	-13.0
2/19/08 ⁽¹⁾	140	-12.0	NM	0.0	-3.5	72	-10.4	NM	0.0	-4.5	65	-10	NM	0.0	-3.6	82	-12.7	NM	0.0	-8.0	75	-13.7	NM	0.0	-5.2	70	-16.04	NM	0.0	-10
2/25/08 ⁽¹⁾	138	-14.90	NM	0.3	-3.5	72	-12.3	NM	0.4	-4.7	67	-12.2	NM	0.4	-4.0	40	-6.2	NM	0.0	-5.7	75	-16.0	NM	0.4	-5.5	77	-19.5	NM	0.3	-9.0
3/3/08 ⁽¹⁾	140	-18.2	NM	0.9	-3.7	76	-13.4	NM	0.1	-5.0	67	-13.85	NM	0.0	-4.5	40	-5.1	NM	0.0	-4.9	78	-17.16	NM	0.2	-5.5	72	-21	NM	0.0	-9.8
3/17/08 ⁽¹⁾	140	-18	NM	0.2	-4.0	76	-12.0	NM	0.1	-5.5	65	-15.2	NM	0.0	-4.5	50	-6	NM	0.0	-5.0	77	-17.6	NM	0.1	-5.5	77	-20	NM	0.0	-9.0
04/16/08	35.32	-2.13	55.4	0.2	NM	28.89	-1.47	56.1	0.2	NM	34.18	-2.2	56.8	0.1	NM	19.24	-0.8	58.6	0.0	NM	24.42	-1.64	57.3	0.0	NM	32.38	-3.14	55.2	0.4	NM
05/19/08	65.68	-9.0	59.1	2.2	-3.5	64.77	-6.8	59.0	0.8	-4.2	33.64	-3.5	61.7	0.8	-1.7	46.61	-4.3	59.3	1.2	-4.0	48.22	-7.2	59.0	0.7	-3.5	42.94	-6.0	59.9	1.1	-3.7
06/02/08	72.85	-9.2	62.0	0.0	-3.9	68.01	-6.8	62.4	0.0	-4.5	34.15	-4.1	67.6	0.0	-1.8	50.56	-4.4	66.3	0.0	-4.1	52.84	-9.0	65.8	0.0	-3.8	46.34	-6.0	66.3	0.0	-3.7

Notes and Abbreviations:

- *F - Degrees Fahrenheit
- DW- Depressurization well
- ft bmp - Feet below measuring point
- iwc - Inches of water column
- NM -Not measured
- scfm - Standard cubic feet per minute
- ppmv - Parts per million by volume
- VMWC - Vapor monitoring well cluster

1. Flow rate at manifold on associated dates quantified using venturi flow meter and associated flow chart. Remaining flow rates measured with a hotwire anemometer and calculated to standard conditions using the formula below.
2. Access point covered by insulation no measurement taken during this round.
3. Blowers BL-200 and BL-400 were taken off-line on April 10th during system rebalancing.
4. Field recording error suspected.

Standard Conditions Calculation:

$$scfm = Flowrate \cdot Area \cdot (Ts/Tm) \cdot (Pm/Ps)$$

- Flowrate in feet per minute
- Area in square feet
- Ts - Standard Temperature in Rankine
- Tm - Measured Temperature in Rankine
- Pm - Measured Pressure in pounds per square inch
- Ps - Standard Pressure in pounds per square inch

Table 1. Summary of General System Operating Parameters, Northrop Grumman Operable Unit 3, Soil Gas Interim Remedial Measure, Former Grumman Settling Ponds, Bethpage, New York.

Date	Knock Out Tank Parameters						Blower Parameters ⁽³⁾ BL-200				Blower Parameters ⁽³⁾ BL-300				Blower Parameters BL-400				Combined Effluent Parameters VSP-601					Stack Parameters VSP-602			Water levels in Wells							
	Vacuum			Totalizer			Influent Vacuum	Effluent Pressure	Effluent Flow Rate	Effluent PID	Influent Vacuum	Effluent Pressure	Effluent Flow Rate	Effluent PID	Influent Vacuum	Effluent Pressure	Effluent Flow Rate	Effluent PID	Total Effluent Flow Rate	Total Effluent PID	Heat Exchanger Influent Temp.	Total Effluent Pressure	VPGAC Influent Temperature	VPGAC Effluent PID	Discharge Temperature	Effluent Relative Humidity	VMWC-1D	VMWC-5D	B2MMV-3	VMWC-1C	VMWC-3B			
	Influent KO-200	Influent KO-300	Influent KO-400	Effluent KO-200	Effluent KO-300	Effluent KO-400																										(iwc)	(iwc)	(iwc)
2/18/08 ⁽¹⁾	-17.9	-37.9	-34.8	33.66	9,996,124	35.99	-19.5	6.2	499.59	6.4	-40	12.0	594.88	0.0	-38	11.5	643.39	0.0	1963.69	0.9	100	9.6	93	0.0	NM	NM	52.13	Dry	53.75	Dry	Dry			
2/19/08 ⁽¹⁾	-19.5	-39.5	-36.0	33.66	9,996,124	35.99	-20.5	9.0	432.20	2.7	-40.6	12.0	841.92	1.6	-38.5	10.0	604.74	1.3	1673.81	NM	95	9.8	84	NM	NM	52.17	Dry	53.77	Dry	Dry				
2/25/08 ⁽¹⁾	-27.4	-42.0	-39.8	57.34	9,996,124	35.99	-28.3	8.2	433.60	NM	-42.9	10.4	821.99	NM	-42.1	10.2	653.35	NM	1678.65	2.4	94	9.0	94	0.0	NM	NM	52.19	49.12	53.89	38.20	Dry			
3/3/08 ⁽¹⁾	-26.5	-44.0	-42.0	128.57	9,996,124	35.99	-28.5	7.6	391.71	NM	-45.2	10.1	752.16	NM	-43.9	10.0	685.41	NM	1792.84	0.5	104	8.6	94	0.0	NM	NM	Dry	Dry	53.90	Dry	Dry			
3/17/08 ⁽¹⁾	-33	-43	-41	132.70	9,996,272.5 ⁽⁴⁾	35.99	-34.3	7.6	411.73	NM	-45.4	10.1	717.83	NM	-43.8	10.0	805.36	NM	1773.50	0.0	102.5	8.0	96	0.0	NM	NM	Dry	Dry	53.62	Dry	Dry			
04/16/08	0	-32	0	132.67	9,996,202.72	35.94	0	0	0	NM	-35	1	641	1.0	0	0	0	NM	NM	1.0	90	0.9	82	0.7	NM	NM	51.55	48.47	53.25	Dry	Dry			
05/19/08	0	-18	0	132.67	9996202.72	35.94	0	0	NM	NM	-19.5	1.5	666	3.1	0	0	NM	NM	NM ⁽²⁾	4.6	85	1.4	74	1.7	NM	NM	51.53	48.50	53.20	Dry	Dry			
06/02/08	0	-15.5	0	132.67	9996202.72	35.94	0	0	NM	NM	-19.5	1.2	746	0.0	0	0	NM	NM	NM ⁽²⁾	0.0	85	1.6	85	0.0	NM	NM	51.71	50.55	53.33	Dry	Dry			

Notes and Abbreviations:

- *F - Degrees Fahrenheit
- DW- Depressurization well
- ft bmp - Feet below measuring point
- iwc - Inches of water column
- NM -Not measured
- scfm - Standard cubic feet per minute
- ppmv - Parts per million by volume
- VMWC - Vapor monitoring well cluster

1. Flow rate at manifold on associated dates quantified using venturi flow meter and associated flow chart. Remaining flow rates measured with a hotwire anemometer and calculated to standard conditions using the formula below.
2. Access point covered by insulation no measurement taken during this round.
3. Blowers BL-200 and BL-400 were taken off-line on April 10th during system rebalancing.
4. Field recording error suspected.

Standard Conditions Calculation:

$$scfm = Flowrate * Area * (Ts/Tm) * (Pm/Ps)$$

- Flowrate in feet per minute
- Area in square feet
- Ts - Standard Temperature in Rankine
- Tm - Measured Temperature in Rankine
- Pm - Measured Pressure in pounds per square inch
- Ps - Standard Pressure in pounds per square inch

Table 2. Summary of Induced Vacuum Readings, Northrop Grumman Operable Unit 3, Soil Gas Interim Remedial Measure, Former Grumman Settling Ponds, Bethpage, New York⁽¹⁾.

Well ID:	DW-7S			DW-7D	DW-3S				DW-3D			DW-5S			DW-5D	DW-1S									
Date	VMWC-14A ⁽⁴⁾	VMWC-14B ⁽⁴⁾	VMWC-14D ⁽⁴⁾	VMWC-9A	VMWC-9B	VMWC-10B	VMWC-11B ⁽⁴⁾	VMWC-10D	VMWC-11D	VMWC-12D ⁽⁴⁾	VMWC-15A ⁽⁴⁾	VMWC-15B ⁽⁴⁾	VMWC-15D ⁽⁴⁾	VMWC-1A	VMWC-2A	VMWC-4A	VMWC-3A ⁽⁴⁾	VMWC-1B	VMWC-4B	VMWC-3B ⁽⁴⁾	VMWC-1C	VMWC-2C	VMWC-4C	VMWC-3C ⁽⁴⁾	
02/18/08	-0.05	-0.26	-0.31	-0.51	-0.67	-0.50	-0.41	-0.57	-0.43	-0.34	-0.52	-0.41	-0.35	-0.12	-0.10	-0.07	-0.07	-0.15	-0.08	-0.08	-0.11	-0.11	-0.09	-0.08	
02/19/08	-0.09	-0.27	-0.30	-0.42	-0.53	-0.40	-0.33	-0.48	-0.40	-0.31	-0.30	-0.30	-0.35	-0.74	-0.61	-0.50	-0.42	-0.93	-0.58	-0.42	-0.78	-0.66	-0.61	-0.46	
02/25/08	-0.09	-0.26	-0.31	-0.39	-0.49	-0.39	-0.34	-0.44	-0.36	-0.31	-0.23	-0.23	-0.27	-0.70	-0.58	-0.44	-0.40	-0.88	-0.54	-0.42	-0.74	-0.62	-0.55	-0.44	
03/03/08	-0.11	-0.28	-0.31	-0.38	-0.44	-0.37	-0.31	-0.41	-0.33	-0.27	-0.19	-0.21	-0.25	-0.62	-0.48	-0.40	-0.32	-0.78	-0.46	-0.38	-0.66	-0.54	-0.49	-0.39	
03/17/08	-0.11	-0.28	-0.31	-0.39	-0.50	-0.36	-0.29	-0.39	-0.36	-0.54	-0.25	-0.25	-0.28	-0.70	-0.60	-0.44	-0.38	-0.89	-0.50	-0.40	-0.68	-0.60	-0.52	-0.43	
04/16/08	-0.11	-0.16	-0.18	-0.15	-0.17	-0.14	-0.13	-0.14	-0.13	-0.11	-0.09	-0.09	-0.08	-0.20	-0.16	-0.16	-0.11	-0.24	-0.16	-0.11	-0.19	-0.16	-0.16	-0.11	
05/19/08	-0.099	-0.143	-0.163	-0.170	-0.199	-1.490	-0.154	-0.083	-0.219	-0.143	-0.159	-0.125	-0.159	-0.425	-0.369	-1.377	-0.221	-0.410	-0.299	-0.283	-0.423	-0.372	-0.333	-0.218	
06/02/08	-0.095	-0.146	-0.148	-0.165	-0.171	-0.165	-0.165	-0.142	-0.135	-0.127	-0.150	-0.140	-0.133	-0.437	-0.339	-0.492	-0.200	-0.505	-0.299	-0.213	-0.408	-0.335	-0.313	-0.212	

Time Weighted
 Rolling Average: -0.106 -0.223 -0.250 -0.288 -0.352 -0.450 -0.233 -0.285 -0.269 -0.287 -0.185 -0.182 -0.202 -0.496 -0.413 -0.476 -0.269 -0.606 -0.367 -0.292 -0.497 -0.427 -0.384 -0.297

Gross Average Non Compliance points

2/18-3/17 -0.640
 4/16-5/19 -0.353
 6/2/08 -0.312

Gross Average Compliance Points

2/18-3/17 -0.317
 4/16-5/19 -0.137
 6/2/08 -0.146

Notes and Abbreviations:

DW Depressurization Well
 NM Not measured due to temporary inaccessibility
 VMWC Vapor monitoring well cluster

- All induced vacuum measurements units in inches of water column (iwc).
- Data point appears to be erroneous based on vacuum readings at further vapor point greater than that recorded at the closer location.
- Data point is average of readings taken which fluctuated between -0.22 and -0.29 iwc.
- Compliance vapor monitoring point.

Table 2. Induced Vacuum Measurements, Northrop Grumman Operable Unit 3, Soil Gas Interim Remedial Measure, Former Grumman Settling Ponds, Bethpage, New York ⁽¹⁾.

Well ID:	DW-1D				DW-4D	DW-8S		DW-2S								DW-2D				DW-11S			
Date	VMWC-1D	VMWC-2D	VMWC-4D	VMWC-3D ⁽⁴⁾	VMWC-16D ⁽⁴⁾	VMWC-16A ⁽⁴⁾	VMWC-16B ⁽⁴⁾	VMWC-5A	VMWC-6A	VMWC-8A	VMWC-7A ⁽⁴⁾	VMWC-5B	VMWC-6B	VMWC-8B	VMWC-7B ⁽⁴⁾	VMWC-5D	VMWC-6D	VMWC-8D	VMWC-7D	VMWC-13D ⁽⁴⁾	VMWC-17D ⁽⁴⁾	VMWC-18A ⁽⁴⁾	VMWC-18B ⁽⁴⁾
02/18/08	-1.16	-0.99	-0.16	-0.90	-0.51	-0.04	-0.10	-0.07	-0.04	-0.40	-0.08	-0.10	-0.05	-0.02	-0.03	-1.91	-1.47	-0.03 ⁽²⁾	-1.03	-0.17	-0.39	-0.05	-0.07
02/19/08	-1.31	-1.08	-0.86	-0.96	-0.54	-0.26	-0.26	-0.62	-0.37	-0.29	-0.22	-0.74	-1.73	-0.33	-0.23	-2.19	-0.37 ⁽²⁾	-1.88	-1.4	-0.44	-0.53	-0.25	-0.26 ⁽³⁾
02/25/08	-1.56	-1.23	-0.97	-1.07	-0.39	-0.29	-0.30	-0.70	-0.42	-0.31	-0.28	-0.82	-0.46	-0.35	-0.29	-1.21	-1.09	-0.88	-0.89	-0.39	-0.22	-0.24	-0.3
03/03/08	-1.56	-1.20	-0.90	-0.98	-0.27	-0.26	-0.27	-0.68	-0.40	-0.31	-0.27	-0.83	-0.44	-0.35	-0.30	-0.90	-0.72	-0.65	-0.53	-0.24	-0.16	-0.24	-0.27
03/17/08	-1.72	-1.51	-0.96	-1.15	-0.43	-0.31	-0.35	-0.69	-0.41	-0.33	-0.25	-0.78	-0.42	-0.36	-0.28	-1.15	-0.92	-0.82	-0.65	NM	-0.25	-0.29	-0.34
04/16/08	-0.18	-0.15	-0.18	-0.13	-0.09	-0.08	-0.08	-0.26	-0.14	NM	-0.09	-0.22	-0.15	NM	-0.09	-0.23	-0.21	NM	-0.17	NM	-0.08	-0.08	-0.09
05/19/08	-0.424	-0.391	-0.309	-0.310	-0.147	-0.162	-0.170	-0.328	-0.209	-0.180	-0.157	-0.327	-0.213	-0.156	-0.164	-1.097	-0.879	-0.763	-0.694	-0.223	-0.237	-0.139	-0.163
06/02/08	-0.345	-0.283	-0.253	-0.227	-0.195	-0.159	-0.168	-0.310	-0.190	-0.148	-0.142	-0.311	-0.199	-0.169	-0.141	-1.047	-0.838	-0.730	-0.743	-0.180	NM	-0.129	-0.151
Time Weighted Rolling Average:	-1.006	-0.847	-0.610	-0.678	-0.270	-0.206	-0.221	-0.499	-0.294	-0.306	-0.190	-0.547	-0.386	-0.327	-0.204	-0.901	-0.658	-0.854	-0.559	-0.260	-0.200	-0.191	-0.220

Notes & Abbreviations:

- DW Depressurization Well
- NM Not measured due to temporary inaccessibility
- VMWC Vapor monitoring well cluster

1. All induced vacuum measurements units in inches of water column (iwc).
2. Data point appears to be erroneous based on vacuum readings at further vapor point greater than that recorded at the closer location.
3. Data point is average of readings taken which fluctuated between -0.22 and -0.29 iwc.
4. Compliance vapor monitoring point.

Table 3. Summary of System Startup Vapor Sample Analytical Results, Northrop Grumman Operable Unit 3 Soil Gas Interim Remedial Measure, Former Grumman Settling Ponds, Bethpage, New York⁽⁴⁾.

Compound ⁽²⁾ (units in ug/m3)	Location ID: Sample Date:	Well-7S 2/18/2008	Well-7D 2/18/2008	Well-3S ⁽³⁾ 2/25/2008
	CAS No.			
1,1,1-Trichloroethane	71-55-6	< 120	< 530	16
1,1-Dichloroethane	75-34-3	< 120	< 530	4.6
1,1-Dichloroethene	75-35-4	< 120	< 530	< 3.2
2-Butanone	78-93-3	< 120	< 530	10
Acetone	67-64-1	< 1200	< 5300	< 32
Benzene	71-43-2	< 120	< 530	< 3.2
Carbon Tetrachloride	56-23-5	< 120	< 530	< 3.2
CFC-11	75-69-4	< 120	< 530	< 3.2
Chlorobenzene	108-90-7	< 120	< 530	< 3.2
Chloroform	67-66-3	< 120	< 530	6.7
Chloromethane	74-87-3	< 120	< 530	< 3.2
cis-1,2-Dichloroethene	156-59-2	18000	48000	320
Freon 113	76-13-1	< 120	< 530	< 3.2
Freon 12	75-71-8	< 120	< 530	< 3.2
Tetrachloroethene	127-18-4	1200	1700	33
Toluene	108-88-3	< 120	< 530	1600
trans-1,2-Dichloroethene	156-60-5	310	680	8.4
Trichloroethylene	79-01-6	25000	87000	1500
Xylene-o	95-47-6	< 120	< 530	250
Xylenes - m,p	179601-23-1	< 250	< 1100	95
TVOC⁽¹⁾		44,510	137,380	3,844

Notes and Abbreviations:

Bold - Compound detected above method detection limit

CAS No. - Chemical abstracts service list number

TVOC - Total volatile organic compounds

ug/m³ - Micrograms per cubic meter

1. Total Volatile organic compounds determined by summing the individual detections and rounding to the nearest whole number.
2. Table summarizes detected compounds only.
3. Depressurization well 3S analytical sample was collected on 2/25 instead of 2/18 due to a sampling error.
4. Samples were collected by O&M personnel on the dates shown and submitted to Columbia Analytical Services Laboratory (Simi Valley, CA or Rochester, NY locations) for VOC analyses using USEPA Method TO-15 modified in accordance with the project Sampling and Analysis Plan (ARCADIS, 2008). Data presented in this table corresponds to the period February - June 2008.

Table 3. Summary of System Startup Vapor Sample Analytical Results, Northrop Grumman Operable Unit 3 Soil Gas Interim Remedial Measure, Former Grumman Settling Ponds, Bethpage, New York⁽⁴⁾.

Compound ⁽²⁾ (units in ug/m3)	Location ID: Sample Date:	Well-3D 2/18/2008	Well-5S 2/18/2008	Well-5D 2/18/2008
	CAS No.			
1,1,1-Trichloroethane	71-55-6	360	23	150
1,1-Dichloroethane	75-34-3	160	2.3	16
1,1-Dichloroethene	75-35-4	< 66	< 1.3	< 6.7
2-Butanone	78-93-3	< 66	28	45
Acetone	67-64-1	< 660	68	< 67
Benzene	71-43-2	68	140	33
Carbon Tetrachloride	56-23-5	< 66	< 1.3	< 6.7
CFC-11	75-69-4	< 66	1.7	< 6.7
Chlorobenzene	108-90-7	< 66	< 1.3	< 6.7
Chloroform	67-66-3	< 66	16	66
Chloromethane	74-87-3	< 66	4.9	< 6.7
cis-1,2-Dichloroethene	156-59-2	16000	< 1.3	8.2
Freon 113	76-13-1	< 66	1.6	< 6.7
Freon 12	75-71-8	< 66	2.5	< 6.7
Tetrachloroethene	127-18-4	550	12	58
Toluene	108-88-3	< 66	1.3	< 6.7
trans-1,2-Dichloroethene	156-60-5	310	< 1.3	< 6.7
Trichloroethylene	79-01-6	57000	170	1300
Xylene-o	95-47-6	< 66	< 1.3	< 6.7
Xylenes - m,p	179601-23-1	< 130	< 2.6	< 13
TVOC⁽¹⁾		74,448	471	1,676

Notes and Abbreviations:

Bold - Compound detected above method detection limit

CAS No. - Chemical abstracts service list number

TVOC - Total volatile organic compounds

ug/m³ - Micrograms per cubic meter

1. Total Volatile organic compounds determined by summing the individual detections and rounding to the nearest whole number.
2. Table summarizes detected compounds only.
3. Depressurization well 3S analytical sample was collected on 2/25 instead of 2/18 due to a sampling error.
4. Samples were collected by O&M personnel on the dates shown and submitted to Columbia Analytical Services Laboratory (Simi Valley, CA or Rochester, NY locations) for VOC analyses using USEPA Method TO-15 modified in accordance with the project Sampling and Analysis Plan (ARCADIS, 2008). Data presented in this table corresponds to the period February - June 2008.

Table 3. Summary of System Startup Vapor Sample Analytical Results, Northrop Grumman Operable Unit 3 Soil Gas Interim Remedial Measure, Former Grumman Settling Ponds, Bethpage, New York⁽⁴⁾.

Compound ⁽²⁾ (units in ug/m3)	Location ID:	Well-6S	Well-6D	Well-1S
	Sample Date:	2/18/2008	2/18/2008	2/18/2008
	CAS No.			
1,1,1-Trichloroethane	71-55-6	37	100	25
1,1-Dichloroethane	75-34-3	21	72	< 2.5
1,1-Dichloroethene	75-35-4	< 2.3	25	< 2.5
2-Butanone	78-93-3	29	16	22
Acetone	67-64-1	29	< 81	87
Benzene	71-43-2	43	23	69
Carbon Tetrachloride	56-23-5	< 2.3	< 8.1	13
CFC-11	75-69-4	< 2.3	< 8.1	< 2.5
Chlorobenzene	108-90-7	< 2.3	< 8.1	< 2.5
Chloroform	67-66-3	9.3	30	11
Chloromethane	74-87-3	< 2.3	< 8.1	3.5
cis-1,2-Dichloroethene	156-59-2	3.8	< 8.1	6.7
Freon 113	76-13-1	3.4	42	3.3
Freon 12	75-71-8	5.8	12	2.8
Tetrachloroethene	127-18-4	23	61	25
Toluene	108-88-3	< 2.3	13	< 2.5
trans-1,2-Dichloroethene	156-60-5	< 2.3	< 8.1	< 2.5
Trichloroethylene	79-01-6	470	1600	510
Xylene-o	95-47-6	< 2.3	< 8.1	< 2.5
Xylenes - m,p	179601-23-1	< 4.7	< 16	< 5.1
TVOC⁽¹⁾		674	1,994	778

Notes and Abbreviations:

Bold - Compound detected above method detection limit

CAS No. - Chemical abstracts service list number

TVOC - Total volatile organic compounds

ug/m³ - Micrograms per cubic meter

1. Total Volatile organic compounds determined by summing the individual detections and rounding to the nearest whole number.
2. Table summarizes detected compounds only.
3. Depressurization well 3S analytical sample was collected on 2/25 instead of 2/18 due to a sampling error.
4. Samples were collected by O&M personnel on the dates shown and submitted to Columbia Analytical Services Laboratory (Simi Valley, CA or Rochester, NY locations) for VOC analyses using USEPA Method TO-15 modified in accordance with the project Sampling and Analysis Plan (ARCADIS, 2008). Data presented in this table corresponds to the period February - June 2008.

Table 3. Summary of System Startup Vapor Sample Analytical Results, Northrop Grumman Operable Unit 3 Soil Gas Interim Remedial Measure, Former Grumman Settling Ponds, Bethpage, New York⁽⁴⁾.

Compound ⁽²⁾ (units in ug/m3)	Location ID: Sample Date:	Well-1D 2/18/2008	Well-4S 2/18/2008	Well-4D 2/18/2008
	CAS No.			
1,1,1-Trichloroethane	71-55-6	69	99	170
1,1-Dichloroethane	75-34-3	< 8.1	22	29
1,1-Dichloroethene	75-35-4	8.6	< 4.2	< 6.4
2-Butanone	78-93-3	31	27	58
Acetone	67-64-1	< 81	130	< 64
Benzene	71-43-2	19	440	62
Carbon Tetrachloride	56-23-5	34	< 4.2	< 6.4
CFC-11	75-69-4	< 8.1	< 4.2	< 6.4
Chlorobenzene	108-90-7	< 8.1	< 4.2	< 6.4
Chloroform	67-66-3	28	6.5	9.4
Chloromethane	74-87-3	< 8.1	< 4.2	< 6.4
cis-1,2-Dichloroethene	156-59-2	29	14	17
Freon 113	76-13-1	20	< 4.2	< 6.4
Freon 12	75-71-8	< 8.1	< 4.2	< 6.4
Tetrachloroethene	127-18-4	68	42	79
Toluene	108-88-3	< 8.1	< 4.2	< 6.4
trans-1,2-Dichloroethene	156-60-5	< 8.1	8.8	7.6
Trichloroethylene	79-01-6	1600	880	1400
Xylene-o	95-47-6	< 8.1	< 4.2	< 6.4
Xylenes - m,p	179601-23-1	< 16	< 8.4	< 13
TVOC⁽¹⁾		1,907	1,669	1,832

Notes and Abbreviations:

Bold - Compound detected above method detection limit

CAS No. - Chemical abstracts service list number

TVOC - Total volatile organic compounds

ug/m³ - Micrograms per cubic meter

1. Total Volatile organic compounds determined by summing the individual detections and rounding to the nearest whole number.
2. Table summarizes detected compounds only.
3. Depressurization well 3S analytical sample was collected on 2/25 instead of 2/18 due to a sampling error.
4. Samples were collected by O&M personnel on the dates shown and submitted to Columbia Analytical Services Laboratory (Simi Valley, CA or Rochester, NY locations) for VOC analyses using USEPA Method TO-15 modified in accordance with the project Sampling and Analysis Plan (ARCADIS, 2008). Data presented in this table corresponds to the period February - June 2008.

Table 3. Summary of System Startup Vapor Sample Analytical Results, Northrop Grumman Operable Unit 3 Soil Gas Interim Remedial Measure, Former Grumman Settling Ponds, Bethpage, New York⁽⁴⁾.

Compound ⁽⁴⁾ (units in ug/m3)	Location ID: Sample Date:	Well-8S 2/18/2008	Well-9S 2/18/2008	Well-2S 2/18/2008
	CAS No.			
1,1,1-Trichloroethane	71-55-6	84	3.6	< 4.6
1,1-Dichloroethane	75-34-3	9.4	< 1.7	< 4.6
1,1-Dichloroethene	75-35-4	< 3.3	< 1.7	< 4.6
2-Butanone	78-93-3	33	32	45
Acetone	67-64-1	150	82	140
Benzene	71-43-2	470	210	580
Carbon Tetrachloride	56-23-5	< 3.3	< 1.7	< 4.6
CFC-11	75-69-4	< 3.3	< 1.7	< 4.6
Chlorobenzene	108-90-7	< 3.3	1.7	< 4.6
Chloroform	67-66-3	< 3.3	< 1.7	< 4.6
Chloromethane	74-87-3	4	3.2	5.5
cis-1,2-Dichloroethene	156-59-2	8.6	< 1.7	390
Freon 113	76-13-1	< 3.3	< 1.7	< 4.6
Freon 12	75-71-8	< 3.3	2.4	< 4.6
Tetrachloroethene	127-18-4	54	8.1	7.2
Toluene	108-88-3	< 3.3	< 1.7	< 4.6
trans-1,2-Dichloroethene	156-60-5	6.2	< 1.7	< 4.6
Trichloroethylene	79-01-6	370	6.2	160
Xylene-o	95-47-6	< 3.3	< 1.7	< 4.6
Xylenes - m,p	179601-23-1	< 6.6	< 3.3	< 9.1
TVOC⁽¹⁾		1,189	349	1,328

Notes and Abbreviations:

Bold - Compound detected above method detection limit

CAS No. - Chemical abstracts service list number

TVOC - Total volatile organic compounds

ug/m³ - Micrograms per cubic meter

1. Total Volatile organic compounds determined by summing the individual detections and rounding to the nearest whole number.
2. Table summarizes detected compounds only.
3. Depressurization well 3S analytical sample was collected on 2/25 instead of 2/18 due to a sampling error.
4. Samples were collected by O&M personnel on the dates shown and submitted to Columbia Analytical Services Laboratory (Simi Valley, CA or Rochester, NY locations) for VOC analyses using USEPA Method TO-15 modified in accordance with the project Sampling and Analysis Plan (ARCADIS, 2008). Data presented in this table corresponds to the period February - June 2008.

Table 3. Summary of System Startup Vapor Sample Analytical Results, Northrop Grumman Operable Unit 3 Soil Gas Interim Remedial Measure, Former Grumman Settling Ponds, Bethpage, New York⁽⁴⁾.

Compound ⁽²⁾ (units in ug/m3)	Location ID: Sample Date:	Well-2D 2/18/2008	Well-10S 2/18/2008	Well-11S 2/18/2008
	CAS No.			
1,1,1-Trichloroethane	71-55-6	93	< 1.3	1.2
1,1-Dichloroethane	75-34-3	< 7.5	< 1.3	< 0.67
1,1-Dichloroethene	75-35-4	< 7.5	< 1.3	< 0.67
2-Butanone	78-93-3	150	86	11
Acetone	67-64-1	< 75	66	43
Benzene	71-43-2	14	44	16
Carbon Tetrachloride	56-23-5	< 7.5	< 1.3	< 0.67
CFC-11	75-69-4	29	< 1.3	1.7
Chlorobenzene	108-90-7	< 7.5	< 1.3	< 0.67
Chloroform	67-66-3	< 7.5	< 1.3	1.2
Chloromethane	74-87-3	< 7.5	< 1.3	< 0.67
cis-1,2-Dichloroethene	156-59-2	360	< 1.3	< 0.67
Freon 113	76-13-1	< 7.5	< 1.3	< 0.67
Freon 12	75-71-8	37	2.3	2.7
Tetrachloroethene	127-18-4	24	10	25
Toluene	108-88-3	< 7.5	1.5	0.68
trans-1,2-Dichloroethene	156-60-5	< 7.5	< 1.3	< 0.67
Trichloroethylene	79-01-6	280	4	180
Xylene-o	95-47-6	< 7.5	< 1.3	< 0.67
Xylenes - m,p	179601-23-1	< 15	< 2.6	< 1.3
TVOC⁽¹⁾		987	214	282

Notes and Abbreviations:

Bold - Compound detected above method detection limit

CAS No. - Chemical abstracts service list number

TVOC - Total volatile organic compounds

ug/m³ - Micrograms per cubic meter

1. Total Volatile organic compounds determined by summing the individual detections and rounding to the nearest whole number.
2. Table summarizes detected compounds only.
3. Depressurization well 3S analytical sample was collected on 2/25 instead of 2/18 due to a sampling error.
4. Samples were collected by O&M personnel on the dates shown and submitted to Columbia Analytical Services Laboratory (Simi Valley, CA or Rochester, NY locations) for VOC analyses using USEPA Method TO-15 modified in accordance with the project Sampling and Analysis Plan (ARCADIS, 2008). Data presented in this table corresponds to the period February - June 2008.

Table 4. Summary of Total Influent and Effluent Vapor Sample Analytical Results, Northrop Grumman Operable Unit 3 Soil Gas Interim Remedial Measure, Former Grumman Settling Ponds, Bethpage, New York⁽²⁾.

Compound ⁽³⁾ (units in ug/m3)	Location ID: Sample Date:	VSP-601 2/18/2008	VSP-602 2/18/2008	VSP-601 2/19/2008	VSP-602 2/19/2008	VSP-601 2/25/2008	VSP-602 2/25/2008
	CAS No. SGC						
1,1,1-Trichloroethane	71-55-6 6,800	110	< 0.62	71	< 0.61	35	< 0.63
1,1-Dichloroethane	75-34-3 NS	43	< 0.62	33	< 0.61	45	< 0.63
2-Butanone	78-93-3 59,000	16	< 0.62	< 11	< 0.61	< 25	< 0.63
Acetone	67-64-1 180,000	< 140	< 6.2	< 110	< 6.1	< 250	< 6.3
Benzene	71-43-2 1,300	67	< 0.62	22	< 0.61	< 25	< 0.63
Chloroform	67-66-3 150	34	< 0.62	24	< 0.61	< 25	< 0.63
cis-1,2-Dichloroethene	156-59-2 190,000 ⁽¹⁾	5800	< 0.62	4600	< 0.61	2900	< 0.63
Freon 12	75-71-8 NS	< 14	< 0.62	< 11	0.71	< 25	5.7
Tetrachloroethene	127-18-4 1,000	340	< 0.62	200	< 0.61	82	< 0.63
Toluene	108-88-3 37,000	92	< 0.62	98	< 0.61	34	< 0.63
Trans-1,2-Dichloroethene	156-60-5 NS	120	< 0.62	71	< 0.61	< 25	< 0.63
Trichloroethylene	79-01-6 54,000	14000	< 0.62	9400	< 0.61	5100	< 0.63
Vinyl Chloride	75-01-4 180,000	< 14	< 0.62	< 11	< 0.61	< 25	1.1
TVOC		20,622	0.0	14,519	0.71	8,196	6.8

Notes and abbreviations on last page

ARCADIS

Table 4. Summary of Total Influent and Effluent Vapor Sample Analytical Results, Northrop Grumman Operable Unit 3 Soil Gas Interim Remedial Measure, Former Grumman Settling Ponds, Bethpage, New York ⁽²⁾.

Compound (units in ug/m3)	Location ID: Sample Date:	VSP-601 3/3/2008	VSP-602 3/3/2008	VSP-601 3/17/2008	VSP-602 3/17/2008	VSP-601 4/16/2008	VSP-602 4/16/2008
	CAS No. SGC						
1,1,1-Trichloroethane	71-55-6 6,800	26	< 0.63	35	< 14	<25	< 15
1,1-Dichloroethane	75-34-3 NS	47	< 0.63	59	< 11	31	< 11
2-Butanone	78-93-3 59,000	< 13	< 0.63	< 16	< 16	< 16	< 16
Acetone	67-64-1 180,000	< 130	< 6.3	< 31	< 31	< 31	< 31
Benzene	71-43-2 1,300	< 13	< 0.63	< 8.4	< 8.4	< 8.4	< 8.4
Chloroform	67-66-3 150	27	< 0.63	35	< 13	<22	< 13
cis-1,2-Dichloroethene	156-59-2 190,000 ⁽¹⁾	1600	< 0.63	1400 D	< 10	1100	78
Freon 12	75-71-8 NS	13	8.3	46	< 26	<46	< 26
Tetrachloroethene	127-18-4 1,000	45	< 0.63	39	< 3.6	54	< 3.7
Toluene	108-88-3 37,000	61	< 0.63	140	< 10	37	< 10
Trans-1,2-Dichloroethene	156-60-5 NS	< 13	< 0.63	10	< 10	<19	< 10
Trichloroethylene	79-01-6 54,000	2500	< 0.63	1500 D	< 2.8	1300	< 2.9
Vinyl Chloride	75-01-4 180,000	200	40	980 D	920 D	120	710
TVOC		4,519	48.3	4,244	920	2,642	788

Notes and abbreviations on last page

ARCADIS

Table 4. Summary of Total Influent and Effluent Vapor Sample Analytical Results, Northrop Grumman Operable Unit 3 Soil Gas Interim Remedial Measure, Former Grumman Settling Ponds, Bethpage, New York ⁽²⁾.

Compound (units in ug/m3)			Location ID: Sample Date:	VSP-601 5/19/2008	VSP-602 5/19/2008	VSP-601 6/2/2008	VSP-602 6/2/2008
	CAS No.	SGC					
1,1,1-Trichloroethane	71-55-6	6,800		38	< 2.7	44	< 2.5
1,1-Dichloroethane	75-34-3	NS		25	5.8	27	7.6
2-Butanone	78-93-3	59,000		< 28	< 2.9	28	< 2.7
Acetone	67-64-1	180,000		< 57	< 5.8	< 55	8.4
Benzene	71-43-2	1,300		19	< 1.6	< 15	< 1.5
Chloroform	67-66-3	150		44	< 2.4	55	3
cis-1,2-Dichloroethene	156-59-2	190,000 ⁽¹⁾		950	180	930	230 D
Freon 12	75-71-8	NS		< 48	< 4.9	< 45	< 4.5
Tetrachloroethene	127-18-4	1,000		42	< 0.67	48	2.2
Toluene	108-88-3	37,000		< 18	< 1.8	< 17	< 1.7
Trans-1,2-Dichloroethene	156-60-5	NS		< 19	< 1.9	< 18	2.8
Trichloroethylene	79-01-6	54,000		1000	5.3	1100	6.5
Vinyl Chloride	75-01-4	180,000		< 12	65	< 12	13
TVOC				2,118	256.1	2,232	273.5

Notes and abbreviations on last page

Table 4. Summary of Total Influent and Effluent Vapor Sample Analytical Results, Northrop Grumman Operable Unit 3 Soil Gas Interim Remedial Measure, Former Grumman Settling Ponds, Bethpage, New York ⁽²⁾.

Notes and Abbreviations:

- Bold** Compound detected above method detection limit
- CAS No. Chemical abstracts service list number
- D Compound detected at a secondary dilution
- NS Guideline concentrations not specified in the NYSDEC DAR-1 AGC/SGC tables revised December 22, 2005.
- SGC Short-term guideline concentrations specified in the NYSDEC DAR-1 AGC/SGC tables revised December 22, 2005.
- TVOC Total volatile organic compounds
- ug/m³ Micrograms per cubic meter

1. An SGC was not provided in the DAR-1 AGC/SGC Tables, dated December 22, 2003. An interim SGC was developed based on guidance provided in Section IV.A.2.b.1 of the New York State DAR-1 Guidelines for the Control of Toxic Ambient Air Contaminants, 1991 edition. Specifically for cis-1,2 dichloroethene, which is not defined as a high-toxicity compound, the interim SGC = (smaller of Time Weighted Average [TWA] =- threshold Limit Value or TWA - Recommended Exposure Limit)/4.2 or 793,000 ug/m³ / 4.2 = 190,000 ug/m³.
2. Samples were collected by O&M personnel on the dates shown and submitted to Columbia Analytical Services Laboratory (Simi Valley, CA or Rochester, NY locations) for VOC analyses using USEPA Method TO-15 modified in accordance with the project Sampling and Analysis Plan (ARCADIS,2008) . Data presented in this table corresponds to the period February - June 2008.
3. Table summarizes detected compounds only.

ARCADIS

Table 5. Summary of Condensate Sample Analytical Results, Northrop Grumman Operable Unit 3 Soil Gas Interim Remedial Measure, Former Grumman Settling Ponds, Bethpage, New York ⁽²⁾.

Compound ⁽³⁾ (units in ug/L)	Location ID: Sample Date:	KO-200 3/17/2008	KO-300 3/17/2008	WSP-510 3/17/2008
	CAS No.			
1,1-Dichloroethane	75-34-3	1.4	< 1	<2.5
2-Butanone	78-93-3	1000 D	1300 D	440 D
Acetone	67-64-1	17	40	44
cis-1,2-Dichloroethene	156-59-2	40	4	15
Isopropylbenzene	98-82-8	< 1	< 1	6.6
Toluene	108-88-3	2.2	< 1	<2.5
trans-1,2-Dichloroethene	156-60-5	1.1	< 1	<2.5
Trichloroethylene	79-01-6	22	3	9
Vinyl Chloride	75-01-4	4.8	1.7	<2.5
TVOC ⁽¹⁾		1089	1349	515

Notes and Abbreviations:

Bold	Compound detected above method detection limit
CAS No.	Chemical abstracts service list number
D	Compound detected at a secondary dilution
TVOC	Total volatile organic compounds
ug/L	Micograms per liter

1. Total volatile organic compounds determined by summing individual detections and rounding to the nearest whole number.
2. Samples were collected by O&M personnel on the dates shown and submitted to Columbia Analytical Services Laboratory (Rochester, NY) for VOC analyses using Method 8260 in accordance with the project Sampling and Analysis Plan (ARCADIS,2008) . Data presented in this table corresponds to the period February - June 2008.
3. Table summarizes detected compounds only.

ARCADIS

Table 6. Air Emissions Model Output Summary, Northrop Grumman Operable Unit 3 Soil Gas Interim Remedial Measure, Former Grumman Settling Ponds, Bethpage, New York.

Compound ⁽¹⁾	AGC ⁽²⁾ ($\mu\text{g}/\text{m}^3$)	Percent of MASC Per Event ⁽³⁾								Cumulative % MASC ⁽⁴⁾
		2/18/2008	2/19/2008	2/25/2008	3/3/2008	3/17/2008	4/16/2008	5/19/2008	6/2/2008	
Vinyl chloride	0.11	0.00%	0.00%	0.04%	1.60%	36.84%	20.63%	1.91%	0.41%	11.01%
1,1-Dichloroethene	0.63	0.00%	0.00%	0.00%	0.00%	0.00%	0.00%	0.03%	0.04%	0.00%
Trichloroethylene	0.5	0.00%	0.00%	0.00%	0.00%	0.00%	0.00%	0.03%	0.05%	0.01%
Tetrachloroethylene	1	0.00%	0.00%	0.00%	0.00%	0.00%	0.00%	0.00%	0.01%	0.00%
cis-1,2-Dichloroethylene	1,900	0.00%	0.00%	0.00%	0.00%	0.00%	0.00%	0.00%	0.00%	0.00%
Dichlorodifluoromethane (Freon 12)	12,000	0.00%	0.00%	0.00%	0.00%	0.00%	0.00%	0.00%	0.00%	0.00%
Acetone	28,000	0.00%	0.00%	0.00%	0.00%	0.00%	0.00%	0.00%	0.00%	0.00%
Chloroform	0.043	0.00%	0.00%	0.00%	0.00%	0.00%	0.00%	0.00%	0.24%	0.00%
trans-1,2-Dichloroethene	1,900	0.00%	0.00%	0.00%	0.00%	0.00%	0.00%	0.00%	0.00%	0.00%

Notes:

1. Compounds listed include all compounds detected in the system effluent vapor stream.
2. AGC refers to the compound-specific annual guideline concentration per the NYSDEC DAR-1 AGC/SGC tables, revised December 22, 2003. NYSDEC DAR-1 AGCs were scaled using the results of a site-specific annual USEPA SCREEN 3 model to calculate the annual maximum allowable stack concentration (MASC) per monitoring event.
3. Percent of AGC was calculated by dividing the actual effluent concentration by the site-specific annual MASC. Detailed calculations are included in Appendix C.
4. Cumulative percent of the MASC was calculated using a time-weighted average of the percent MASC per event.

$\mu\text{g}/\text{m}^3$ - Micrograms per cubic meter.

AGC - Annual guideline concentration.

PROJECTNAME: NY001464-0908-00004
 IMAGES: site4.jpg
 site5.jpg
 site6.jpg
 site7.jpg
 site8.jpg
 site9.jpg

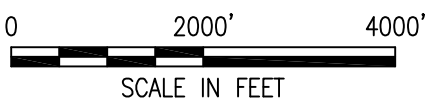
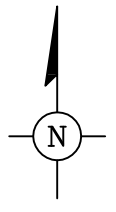
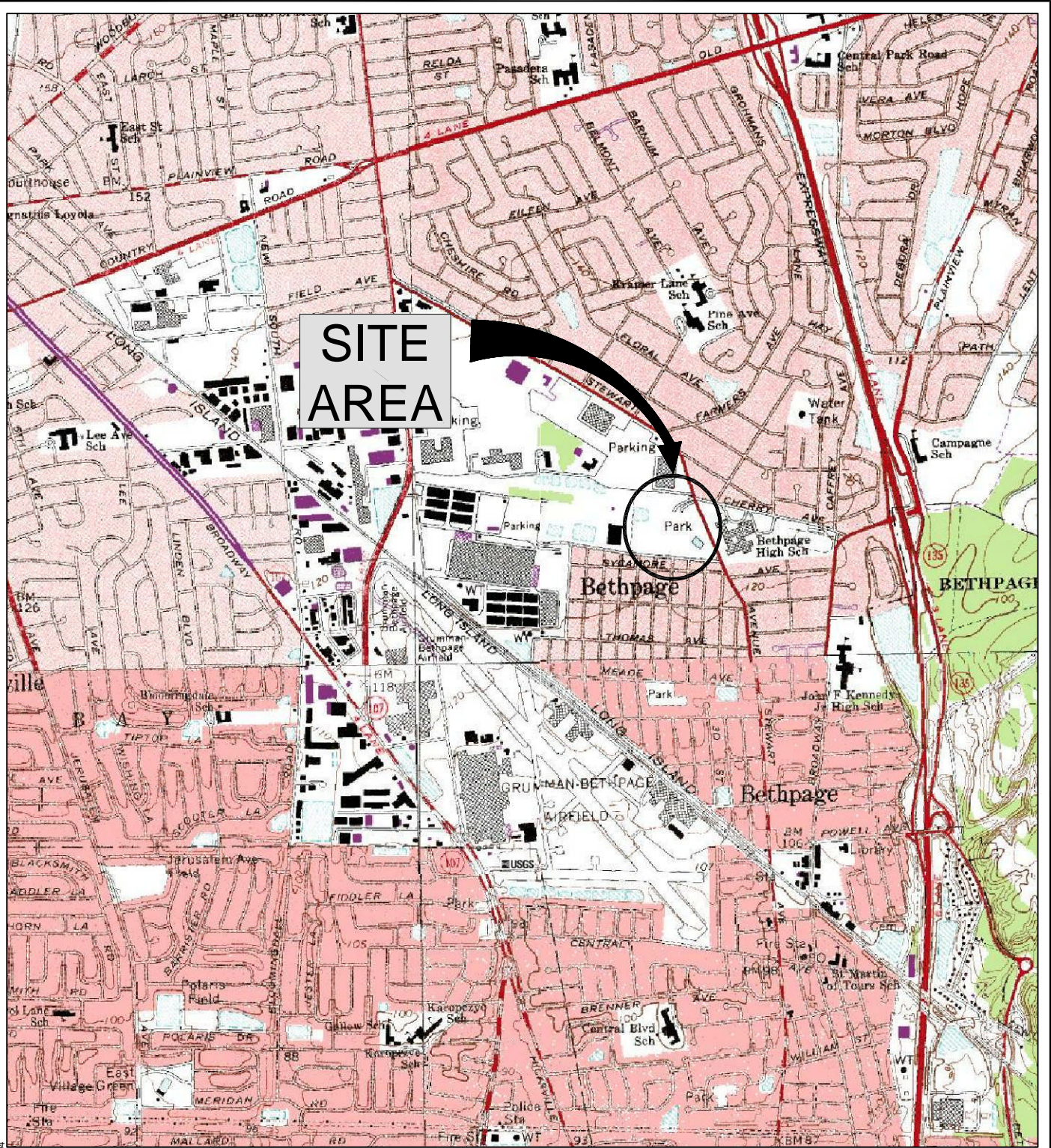

SOURCE:
 USGS 7.5 MIN. AMITYVILLE QUADRANGLE, AMITYVILLE, NY, 1994
 USGS 7.5 MIN. FREEPORT QUADRANGLE, FREEPORT, NY, 1994
 USGS 7.5 MIN. HICKSVILLE QUADRANGLE, HICKSVILLE, NY, 1967, PHOTOREVISED 1979
 USGS 7.5 MIN. HUNTINGTON QUADRANGLE, HUNTINGTON, NY, 1967, PHOTOREVISED 1979

**NORTHROP GRUMMAN CORPORATION
 BETHPAGE, NEW YORK
 OPERABLE UNIT 3
 FORMER GRUMMAN SETTLING PONDS**

**SITE LOCATION MAP
 SOIL GAS INTERIM REMEDIAL MEASURE**

ARCADIS

FIGURE
1

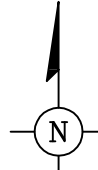
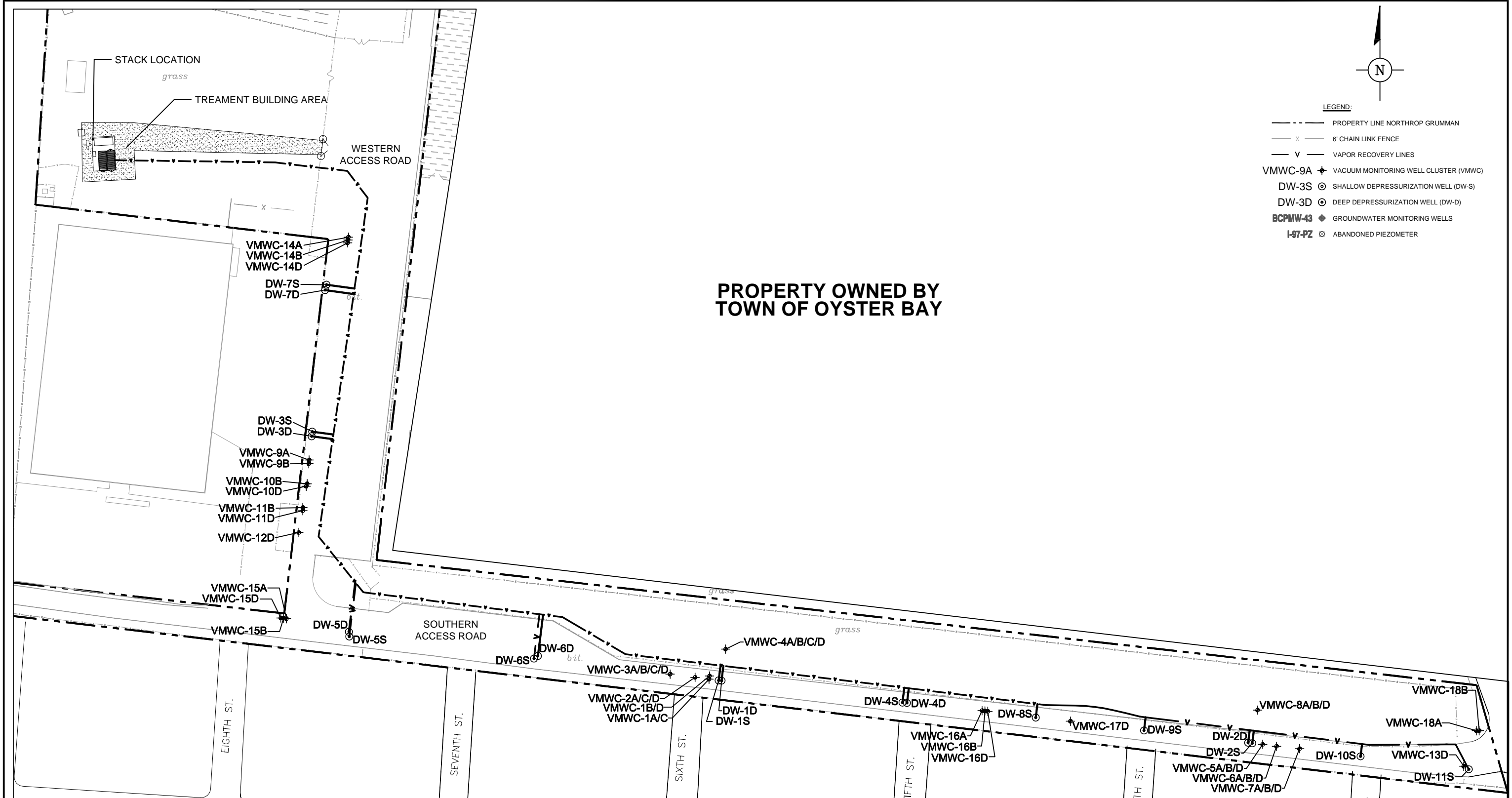

- LEGEND:
- PROPERTY LINE NORTHROP GRUMMAN
 - X - 6" CHAIN LINK FENCE
 - V - VAPOR RECOVERY LINES
 - VMWC-9A ◆ VACUUM MONITORING WELL CLUSTER (VMWC)
 - DW-3S ⊙ SHALLOW DEPRESSURIZATION WELL (DW-S)
 - DW-3D ⊙ DEEP DEPRESSURIZATION WELL (DW-D)
 - BCPMW-43 ◆ GROUNDWATER MONITORING WELLS
 - I-97-PZ ⊙ ABANDONED PIEZOMETER

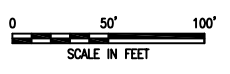

NORTHROP GRUMMAN CORPORATION
BETHPAGE, NEW YORK
OPERABLE UNIT 3
FORMER GRUMMAN SETTLING PONDS

**GENERAL SITE PLAN
SOIL GAS INTERIM REMEDIAL MEASURE**

FIGURE
2

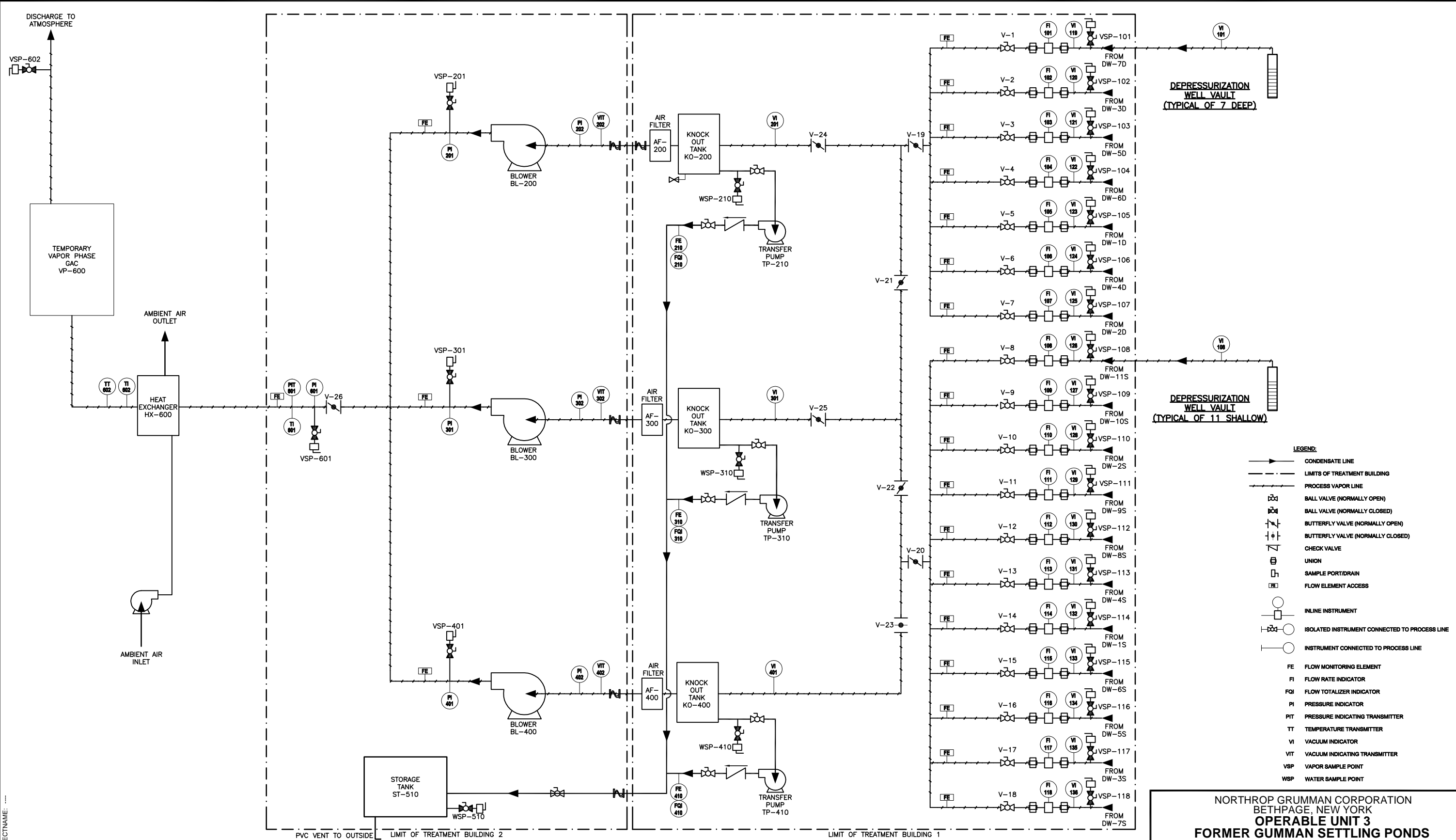

LEGEND:

- CONDENSATE LINE
- - - LIMITS OF TREATMENT BUILDING
- PROCESS VAPOR LINE
- BALL VALVE (NORMALLY OPEN)
- BALL VALVE (NORMALLY CLOSED)
- BUTTERFLY VALVE (NORMALLY OPEN)
- BUTTERFLY VALVE (NORMALLY CLOSED)
- CHECK VALVE
- UNION
- SAMPLE PORT/DRAIN
- FEA FLOW ELEMENT ACCESS
- INLINE INSTRUMENT
- ISOLATED INSTRUMENT CONNECTED TO PROCESS LINE
- INSTRUMENT CONNECTED TO PROCESS LINE
- FE FLOW MONITORING ELEMENT
- FI FLOW RATE INDICATOR
- FOI FLOW TOTALIZER INDICATOR
- PI PRESSURE INDICATOR
- PIT PRESSURE INDICATING TRANSMITTER
- TT TEMPERATURE TRANSMITTER
- VI VACUUM INDICATOR
- VIT VACUUM INDICATING TRANSMITTER
- VSP VAPOR SAMPLE POINT
- WSP WATER SAMPLE POINT

NORTHROP GRUMMAN CORPORATION
BETHPAGE, NEW YORK
OPERABLE UNIT 3
FORMER GUMMAN SETTLING PONDS

PROCESS FLOW DIAGRAM
SOIL GAS INTERIM REMEDIAL MEASURE

 **ARCADIS**

FIGURE
3

ARCADIS

Appendix A

Summary of Vapor Sample
Analytical Results Including
Tentatively Identified Compounds

ARCADIS

Appendix A-1. Summary of System Startup Vapor Sample Analytical Results, Northrop Grumman Operable Unit 3
Soil Gas Interim Remedial Measure, Former Grumman Settling Ponds, Bethpage, New York⁽³⁾.

Compound (units in ug/m3)	Location ID:	Well-7S	Well-7D	Well 3S ⁽²⁾
	Sample Date:	2/18/2008	2/18/2008	2/25/2008
	CAS No.			
1,1,1-Trichloroethane	71-55-6	< 120	< 530	16
1,1,2,2-Tetrachloroethane	79-34-5	< 120	< 530	< 3.2
1,1,2-Trichloroethane	79-00-5	< 120	< 530	< 3.2
1,1-Dichloroethane	75-34-3	< 120	< 530	4.6
1,1-Dichloroethene	75-35-4	< 120	< 530	< 3.2
1,2-Dichloroethane	107-06-2	< 120	< 530	< 3.2
1,2-Dichloropropane	78-87-5	< 120	< 530	< 3.2
1,3-Butadiene	106-99-0	< 120	< 530	< 3.2
2-Butanone	78-93-3	< 120	< 530	10
2-Hexanone	591-78-6	< 120	< 530	< 3.2
4-Methyl-2-Pentanone	108-10-1	< 120	< 530	< 3.2
Acetone	67-64-1	< 1200	< 5300	< 32
Benzene	71-43-2	< 120	< 530	< 3.2
Bromodichloromethane	75-27-4	< 120	< 530	< 3.2
Bromoform	75-25-2	< 120	< 530	< 3.2
Bromomethane	74-83-9	< 120	< 530	< 3.2
Carbon Disulfide	75-15-0	< 120	< 530	< 3.2
Carbon Tetrachloride	56-23-5	< 120	< 530	< 3.2
CFC-11	75-69-4	< 120	< 530	< 3.2
Chlorobenzene	108-90-7	< 120	< 530	< 3.2
Chlorodibromomethane	124-48-1	< 120	< 530	< 3.2
Chloroethane	75-00-3	< 120	< 530	< 3.2
Chloroform	67-66-3	< 120	< 530	6.7
Chloromethane	74-87-3	< 120	< 530	< 3.2
cis-1,2-Dichloroethene	156-59-2	18000	48000	320
cis-1,3-Dichloropropene	10061-01-5	< 120	< 530	< 3.2
Ethylbenzene	100-41-4	< 120	< 530	< 3.2
Freon 113	76-13-1	< 120	< 530	< 3.2
Freon 12	75-71-8	< 120	< 530	< 3.2
Methyl tert-butyl ether	1634-04-4	< 120	< 530	< 3.2
Methylene Chloride	75-09-2	< 120	< 530	< 3.2
Styrene	100-42-5	< 120	< 530	< 3.2
Tetrachloroethene	127-18-4	1200	1700	33
Toluene	108-88-3	< 120	< 530	1600
trans-1,2-Dichloroethene	156-60-5	310	680	8.4
trans-1,3-Dichloropropene	10061-02-6	< 120	< 530	< 3.2
Trichloroethylene	79-01-6	25000	87000	1500
Vinyl Chloride	75-01-4	< 120	< 530	< 3.2
Xylene-o	95-47-6	< 120	< 530	250
Xylenes - m,p	179601-23-1	< 250	< 1100	95
TVOC		44,510	137,380	3,844

Notes and abbreviations on last page

ARCADIS

Appendix A-1. Summary of System Startup Vapor Sample Analytical Results, Northrop Grumman Operable Unit 3
Soil Gas Interim Remedial Measure, Former Grumman Settling Ponds, Bethpage, New York⁽³⁾.

Compound (units in ug/m3)	Location ID: Sample Date:	Well-3D 2/18/2008	Well-5S 2/18/2008	Well-5D 2/18/2008
	CAS No.			
1,1,1-Trichloroethane	71-55-6	360	23	150
1,1,2,2-Tetrachloroethane	79-34-5	< 66	< 1.3	< 6.7
1,1,2-Trichloroethane	79-00-5	< 66	< 1.3	< 6.7
1,1-Dichloroethane	75-34-3	160	2.3	16
1,1-Dichloroethene	75-35-4	< 66	< 1.3	< 6.7
1,2-Dichloroethane	107-06-2	< 66	< 1.3	< 6.7
1,2-Dichloropropane	78-87-5	< 66	< 1.3	< 6.7
1,3-Butadiene	106-99-0	< 66	< 1.3	< 6.7
2-Butanone	78-93-3	< 66	28	45
2-Hexanone	591-78-6	< 66	< 1.3	< 6.7
4-Methyl-2-Pentanone	108-10-1	< 66	< 1.3	< 6.7
Acetone	67-64-1	< 660	68	< 67
Benzene	71-43-2	68	140	33
Bromodichloromethane	75-27-4	< 66	< 1.3	< 6.7
Bromoform	75-25-2	< 66	< 1.3	< 6.7
Bromomethane	74-83-9	< 66	< 1.3	< 6.7
Carbon Disulfide	75-15-0	< 66	< 1.3	< 6.7
Carbon Tetrachloride	56-23-5	< 66	< 1.3	< 6.7
CFC-11	75-69-4	< 66	1.7	< 6.7
Chlorobenzene	108-90-7	< 66	< 1.3	< 6.7
Chlorodibromomethane	124-48-1	< 66	< 1.3	< 6.7
Chloroethane	75-00-3	< 66	< 1.3	< 6.7
Chloroform	67-66-3	< 66	16	66
Chloromethane	74-87-3	< 66	4.9	< 6.7
cis-1,2-Dichloroethene	156-59-2	16000	< 1.3	8.2
cis-1,3-Dichloropropene	10061-01-5	< 66	< 1.3	< 6.7
Ethylbenzene	100-41-4	< 66	< 1.3	< 6.7
Freon 113	76-13-1	< 66	1.6	< 6.7
Freon 12	75-71-8	< 66	2.5	< 6.7
Methyl tert-butyl ether	1634-04-4	< 66	< 1.3	< 6.7
Methylene Chloride	75-09-2	< 66	< 1.3	< 6.7
Styrene	100-42-5	< 66	< 1.3	< 6.7
Tetrachloroethene	127-18-4	550	12	58
Toluene	108-88-3	< 66	1.3	< 6.7
trans-1,2-Dichloroethene	156-60-5	310	< 1.3	< 6.7
trans-1,3-Dichloropropene	10061-02-6	< 66	< 1.3	< 6.7
Trichloroethylene	79-01-6	57000	170	1300
Vinyl Chloride	75-01-4	< 66	< 1.3	< 6.7
Xylene-o	95-47-6	< 66	< 1.3	< 6.7
Xylenes - m,p	179601-23-1	< 130	< 2.6	< 13
TVOC		74,448	471	1,676

Notes and abbreviations on last page

Appendix A-1. Summary of System Startup Vapor Sample Analytical Results, Northrop Grumman Operable Unit 3
Soil Gas Interim Remedial Measure, Former Grumman Settling Ponds, Bethpage, New York⁽³⁾.

Compound (units in ug/m3)	Location ID: Sample Date:	Well-6S 2/18/2008	Well-6D 2/18/2008	Well-1S 2/18/2008
	CAS No.			
1,1,1-Trichloroethane	71-55-6	37	100	25
1,1,2,2-Tetrachloroethane	79-34-5	< 2.3	< 8.1	< 2.5
1,1,2-Trichloroethane	79-00-5	< 2.3	< 8.1	< 2.5
1,1-Dichloroethane	75-34-3	21	72	< 2.5
1,1-Dichloroethene	75-35-4	< 2.3	25	< 2.5
1,2-Dichloroethane	107-06-2	< 2.3	< 8.1	< 2.5
1,2-Dichloropropane	78-87-5	< 2.3	< 8.1	< 2.5
1,3-Butadiene	106-99-0	< 2.3	< 8.1	< 2.5
2-Butanone	78-93-3	29	16	22
2-Hexanone	591-78-6	< 2.3	< 8.1	< 2.5
4-Methyl-2-Pentanone	108-10-1	< 2.3	< 8.1	< 2.5
Acetone	67-64-1	29	< 81	87
Benzene	71-43-2	43	23	69
Bromodichloromethane	75-27-4	< 2.3	< 8.1	< 2.5
Bromoform	75-25-2	< 2.3	< 8.1	< 2.5
Bromomethane	74-83-9	< 2.3	< 8.1	< 2.5
Carbon Disulfide	75-15-0	< 2.3	< 8.1	< 2.5
Carbon Tetrachloride	56-23-5	< 2.3	< 8.1	13
CFC-11	75-69-4	< 2.3	< 8.1	< 2.5
Chlorobenzene	108-90-7	< 2.3	< 8.1	< 2.5
Chlorodibromomethane	124-48-1	< 2.3	< 8.1	< 2.5
Chloroethane	75-00-3	< 2.3	< 8.1	< 2.5
Chloroform	67-66-3	9.3	30	11
Chloromethane	74-87-3	< 2.3	< 8.1	3.5
cis-1,2-Dichloroethene	156-59-2	3.8	< 8.1	6.7
cis-1,3-Dichloropropene	10061-01-5	< 2.3	< 8.1	< 2.5
Ethylbenzene	100-41-4	< 2.3	< 8.1	< 2.5
Freon 113	76-13-1	3.4	42	3.3
Freon 12	75-71-8	5.8	12	2.8
Methyl tert-butyl ether	1634-04-4	< 2.3	< 8.1	< 2.5
Methylene Chloride	75-09-2	< 2.3	< 8.1	< 2.5
Styrene	100-42-5	< 2.3	< 8.1	< 2.5
Tetrachloroethene	127-18-4	23	61	25
Toluene	108-88-3	< 2.3	13	< 2.5
trans-1,2-Dichloroethene	156-60-5	< 2.3	< 8.1	< 2.5
trans-1,3-Dichloropropene	10061-02-6	< 2.3	< 8.1	< 2.5
Trichloroethylene	79-01-6	470	1600	510
Vinyl Chloride	75-01-4	< 2.3	< 8.1	< 2.5
Xylene-o	95-47-6	< 2.3	< 8.1	< 2.5
Xylenes - m,p	179601-23-1	< 4.7	< 16	< 5.1
TVOC		674	1,994	778

Notes and abbreviations on last page

ARCADIS

Appendix A-1. Summary of System Startup Vapor Sample Analytical Results, Northrop Grumman Operable Unit 3
Soil Gas Interim Remedial Measure, Former Grumman Settling Ponds, Bethpage, New York⁽³⁾.

Compound (units in ug/m3)	Location ID: Sample Date:	Well-1D 2/18/2008	Well-4S 2/18/2008	Well-4D 2/18/2008
	CAS No.			
1,1,1-Trichloroethane	71-55-6	69	99	170
1,1,2,2-Tetrachloroethane	79-34-5	< 8.1	< 4.2	< 6.4
1,1,2-Trichloroethane	79-00-5	< 8.1	< 4.2	< 6.4
1,1-Dichloroethane	75-34-3	< 8.1	22	29
1,1-Dichloroethene	75-35-4	8.6	< 4.2	< 6.4
1,2-Dichloroethane	107-06-2	< 8.1	< 4.2	< 6.4
1,2-Dichloropropane	78-87-5	< 8.1	< 4.2	< 6.4
1,3-Butadiene	106-99-0	< 8.1	< 4.2	< 6.4
2-Butanone	78-93-3	31	27	58
2-Hexanone	591-78-6	< 8.1	< 4.2	< 6.4
4-Methyl-2-Pentanone	108-10-1	< 8.1	< 4.2	< 6.4
Acetone	67-64-1	< 8.1	130	< 6.4
Benzene	71-43-2	19	440	62
Bromodichloromethane	75-27-4	< 8.1	< 4.2	< 6.4
Bromoform	75-25-2	< 8.1	< 4.2	< 6.4
Bromomethane	74-83-9	< 8.1	< 4.2	< 6.4
Carbon Disulfide	75-15-0	< 8.1	< 4.2	< 6.4
Carbon Tetrachloride	56-23-5	34	< 4.2	< 6.4
CFC-11	75-69-4	< 8.1	< 4.2	< 6.4
Chlorobenzene	108-90-7	< 8.1	< 4.2	< 6.4
Chlorodibromomethane	124-48-1	< 8.1	< 4.2	< 6.4
Chloroethane	75-00-3	< 8.1	< 4.2	< 6.4
Chloroform	67-66-3	28	6.5	9.4
Chloromethane	74-87-3	< 8.1	< 4.2	< 6.4
cis-1,2-Dichloroethene	156-59-2	29	14	17
cis-1,3-Dichloropropene	10061-01-5	< 8.1	< 4.2	< 6.4
Ethylbenzene	100-41-4	< 8.1	< 4.2	< 6.4
Freon 113	76-13-1	20	< 4.2	< 6.4
Freon 12	75-71-8	< 8.1	< 4.2	< 6.4
Methyl tert-butyl ether	1634-04-4	< 8.1	< 4.2	< 6.4
Methylene Chloride	75-09-2	< 8.1	< 4.2	< 6.4
Styrene	100-42-5	< 8.1	< 4.2	< 6.4
Tetrachloroethene	127-18-4	68	42	79
Toluene	108-88-3	< 8.1	< 4.2	< 6.4
trans-1,2-Dichloroethene	156-60-5	< 8.1	8.8	7.6
trans-1,3-Dichloropropene	10061-02-6	< 8.1	< 4.2	< 6.4
Trichloroethylene	79-01-6	1600	880	1400
Vinyl Chloride	75-01-4	< 8.1	< 4.2	< 6.4
Xylene-o	95-47-6	< 8.1	< 4.2	< 6.4
Xylenes - m,p	179601-23-1	< 16	< 8.4	< 13
TVOC		1,907	1,669	1,832

Notes and abbreviations on last page

ARCADIS

Appendix A-1. Summary of System Startup Vapor Sample Analytical Results, Northrop Grumman Operable Unit 3
Soil Gas Interim Remedial Measure, Former Grumman Settling Ponds, Bethpage, New York⁽³⁾.

Compound (units in ug/m3)	Location ID: Sample Date:	Well-8S 2/18/2008	Well-9S 2/18/2008	Well-2S 2/18/2008
	CAS No.			
1,1,1-Trichloroethane	71-55-6	84	3.6	< 4.6
1,1,2,2-Tetrachloroethane	79-34-5	< 3.3	< 1.7	< 4.6
1,1,2-Trichloroethane	79-00-5	< 3.3	< 1.7	< 4.6
1,1-Dichloroethane	75-34-3	9.4	< 1.7	< 4.6
1,1-Dichloroethene	75-35-4	< 3.3	< 1.7	< 4.6
1,2-Dichloroethane	107-06-2	< 3.3	< 1.7	< 4.6
1,2-Dichloropropane	78-87-5	< 3.3	< 1.7	< 4.6
1,3-Butadiene	106-99-0	< 3.3	< 1.7	< 4.6
2-Butanone	78-93-3	33	32	45
2-Hexanone	591-78-6	< 3.3	< 1.7	< 4.6
4-Methyl-2-Pentanone	108-10-1	< 3.3	< 1.7	< 4.6
Acetone	67-64-1	150	82	140
Benzene	71-43-2	470	210	580
Bromodichloromethane	75-27-4	< 3.3	< 1.7	< 4.6
Bromoform	75-25-2	< 3.3	< 1.7	< 4.6
Bromomethane	74-83-9	< 3.3	< 1.7	< 4.6
Carbon Disulfide	75-15-0	< 3.3	< 1.7	< 4.6
Carbon Tetrachloride	56-23-5	< 3.3	< 1.7	< 4.6
CFC-11	75-69-4	< 3.3	< 1.7	< 4.6
Chlorobenzene	108-90-7	< 3.3	1.7	< 4.6
Chlorodibromomethane	124-48-1	< 3.3	< 1.7	< 4.6
Chloroethane	75-00-3	< 3.3	< 1.7	< 4.6
Chloroform	67-66-3	< 3.3	< 1.7	< 4.6
Chloromethane	74-87-3	4	3.2	5.5
cis-1,2-Dichloroethene	156-59-2	8.6	< 1.7	390
cis-1,3-Dichloropropene	10061-01-5	< 3.3	< 1.7	< 4.6
Ethylbenzene	100-41-4	< 3.3	< 1.7	< 4.6
Freon 113	76-13-1	< 3.3	< 1.7	< 4.6
Freon 12	75-71-8	< 3.3	2.4	< 4.6
Methyl tert-butyl ether	1634-04-4	< 3.3	< 1.7	< 4.6
Methylene Chloride	75-09-2	< 3.3	< 1.7	< 4.6
Styrene	100-42-5	< 3.3	< 1.7	< 4.6
Tetrachloroethene	127-18-4	54	8.1	7.2
Toluene	108-88-3	< 3.3	< 1.7	< 4.6
trans-1,2-Dichloroethene	156-60-5	6.2	< 1.7	< 4.6
trans-1,3-Dichloropropene	10061-02-6	< 3.3	< 1.7	< 4.6
Trichloroethylene	79-01-6	370	6.2	160
Vinyl Chloride	75-01-4	< 3.3	< 1.7	< 4.6
Xylene-o	95-47-6	< 3.3	< 1.7	< 4.6
Xylenes - m,p	179601-23-1	< 6.6	< 3.3	< 9.1
TVOC		1,189	349	1,328

Notes and abbreviations on last page

ARCADIS

Appendix A-1. Summary of System Startup Vapor Sample Analytical Results, Northrop Grumman Operable Unit 3
Soil Gas Interim Remedial Measure, Former Grumman Settling Ponds, Bethpage, New York⁽⁹⁾.

Compound (units in ug/m3)	Location ID: Sample Date:	Well-2D 2/18/2008	Well-10S 2/18/2008	Well-11S 2/18/2008
	CAS No.			
1,1,1-Trichloroethane	71-55-6	93	< 1.3	1.2
1,1,2,2-Tetrachloroethane	79-34-5	< 7.5	< 1.3	< 0.67
1,1,2-Trichloroethane	79-00-5	< 7.5	< 1.3	< 0.67
1,1-Dichloroethane	75-34-3	< 7.5	< 1.3	< 0.67
1,1-Dichloroethene	75-35-4	< 7.5	< 1.3	< 0.67
1,2-Dichloroethane	107-06-2	< 7.5	< 1.3	< 0.67
1,2-Dichloropropane	78-87-5	< 7.5	< 1.3	< 0.67
1,3-Butadiene	106-99-0	< 7.5	< 1.3	< 0.67
2-Butanone	78-93-3	150	86	11
2-Hexanone	591-78-6	< 7.5	< 1.3	< 0.67
4-Methyl-2-Pentanone	108-10-1	< 7.5	< 1.3	< 0.67
Acetone	67-64-1	< 7.5	66	43
Benzene	71-43-2	14	44	16
Bromodichloromethane	75-27-4	< 7.5	< 1.3	< 0.67
Bromoform	75-25-2	< 7.5	< 1.3	< 0.67
Bromomethane	74-83-9	< 7.5	< 1.3	< 0.67
Carbon Disulfide	75-15-0	< 7.5	< 1.3	< 0.67
Carbon Tetrachloride	56-23-5	< 7.5	< 1.3	< 0.67
CFC-11	75-69-4	29	< 1.3	1.7
Chlorobenzene	108-90-7	< 7.5	< 1.3	< 0.67
Chlorodibromomethane	124-48-1	< 7.5	< 1.3	< 0.67
Chloroethane	75-00-3	< 7.5	< 1.3	< 0.67
Chloroform	67-66-3	< 7.5	< 1.3	1.2
Chloromethane	74-87-3	< 7.5	< 1.3	< 0.67
cis-1,2-Dichloroethene	156-59-2	360	< 1.3	< 0.67
cis-1,3-Dichloropropene	10061-01-5	< 7.5	< 1.3	< 0.67
Ethylbenzene	100-41-4	< 7.5	< 1.3	< 0.67
Freon 113	76-13-1	< 7.5	< 1.3	< 0.67
Freon 12	75-71-8	37	2.3	2.7
Methyl tert-butyl ether	1634-04-4	< 7.5	< 1.3	< 0.67
Methylene Chloride	75-09-2	< 7.5	< 1.3	< 0.67
Styrene	100-42-5	< 7.5	< 1.3	< 0.67
Tetrachloroethene	127-18-4	24	10	25
Toluene	108-88-3	< 7.5	1.5	0.68
trans-1,2-Dichloroethene	156-60-5	< 7.5	< 1.3	< 0.67
trans-1,3-Dichloropropene	10061-02-6	< 7.5	< 1.3	< 0.67
Trichloroethylene	79-01-6	280	4	180
Vinyl Chloride	75-01-4	< 7.5	< 1.3	< 0.67
Xylene-o	95-47-6	< 7.5	< 1.3	< 0.67
Xylenes - m,p	179601-23-1	< 15	< 2.6	< 1.3
TVOC		987	214	282

Notes and abbreviations on last page

ARCADIS

Appendix A-1. Summary of System Startup Vapor Sample Analytical Results, Northrop Grumman Operable Unit 3 Soil Gas Interim Remedial Measure, Former Grumman Settling Ponds, Bethpage, New York⁽³⁾.

Notes and Abbreviations:

Bold - Compound detected above method detection limit

CAS No. - Chemical abstracts service list number

TVOC - Total volatile organic compounds

ug/m³ - Micrograms per cubic meter

1. Total Volatile organic compounds determined by summing the individual detections and rounding to the nearest whole number.
2. Depressurization well 3S analytical sample was collected on 2/25 instead of 2/18 due to a sampling error.
3. Samples were collected by O&M personnel on the dates shown and submitted to Columbia Analytical Services Laboratory (Simi Valley, CA or Rochester, NY locations) for VOC analyses using USEPA Method TO-15 modified in accordance with the project Sampling and Analysis Plan (ARCADIS, 2008). Data presented in this table corresponds to the period February - June 2008.

ARCADIS

Appendix A-2. Summary of System Startup Vapor Sample Analytical Results, Tentatively Identified Compounds, Northrop Grumman Operable Unit 3 Soil Gas Interim Remedial Measure, Former Grumman Settling Ponds, Bethpage, New York⁽⁴⁾.

	Well Sampled: Sample Date:	Well 1D 2/18/08	Well 2D 2/18/08	Well 3D 2/18/08	Well 4D 2/18/08	Well 5D 2/18/08	Well 6D 2/18/08
Tentatively Identified Compounds ^(1,3) (units in ug/m3)							
Acetaldehyde		--	--	--	--	--	--
Isopropyl Alcohol		--	800	--	--	200	90
Tetrahydrofuran		70	200	--	100	60	--
C ₈ H ₁₀ O ₂		--	--	--	--	--	--
C ₈ H ₁₀ O ₂		--	--	--	--	--	--
Cyclohexanone		50	2,000	--	50	--	--
Cumene		--	400	500	600	400	--
Benzaldehyde		--	--	--	--	--	--
alpha-Methylstyrene		--	--	--	--	--	--
Acetophenone		--	200	--	80	200	--
C ₉ H ₁₂ O		--	200	--	40	200	--
Dodecene Isomer		--	70	--	70	--	--
Tetradecene Isomer		--	50	--	--	--	--
Chlorodifluoromethane		NF	NF	NF	NF	NF	NF
Chlorodifluoromethane + Propene + Propane + Carbonyl Sulfide		--	--	--	--	--	--
2-Butoxyethanol		100	5,000	--	--	30	--
Ethanol		--	2,000	--	--	--	--
2-Butanol		--	70	--	--	--	--
1,2-Ethanediol		--	40	--	--	--	--
Propylene Glycol		--	200	--	--	--	--
Cyclohexanol		--	90	--	--	--	--
2,5-Hexanedione		--	--	--	--	--	--
Hexamethylcyclotrisiloxane		--	--	--	--	--	--
1-Butanol		--	--	--	--	--	--
2-Ethyl-1-hexanol		--	--	--	--	--	--
Acetaldehyde + Isobutane		--	--	--	--	--	50
Carbonyl Sulfide		--	--	400	--	--	--
C ₁₀ H ₂₀ Compound		--	--	--	40	--	--
C ₅ H ₈ O		--	--	--	--	--	--
alpha-Pinene		--	--	--	--	--	--
Decene Isomer		--	--	--	--	--	--
2,5-Dimethylfuran		--	--	--	--	--	--
Octamethylcyclotrasiloxane		--	--	--	--	--	--
Decene Isomer + Octamethylcyclotrasiloxane		--	--	--	--	--	--
C ₇ H ₁₂ O ₃ + C ₈ H ₁₆ O		--	--	--	--	--	--
Acetaldehyde + Isobutane		--	--	--	--	--	--
C ₇ H ₁₂ O ₃		--	--	--	--	--	--
C ₇ H ₁₂ O ₃		--	--	--	--	--	--
Methylcyclohexane		--	--	--	--	--	--
C ₇ H ₁₄		--	--	--	--	--	--
C ₉ H ₂₀ Branched Alkane		--	--	--	--	--	--
C ₈ H ₁₈ Branched Alkane		--	--	--	--	--	--
C ₈ H ₁₆		--	--	--	--	--	--
C ₁₁ H ₂₄ Branched Alkane		--	--	--	--	--	--
C ₁₁ H ₂₄ Branched Alkane		--	--	--	--	--	--
C ₁₂ H ₂₆ Branched Alkane		--	--	--	--	--	--

Notes and Abbreviations on Last Page

Appendix A-2. Summary of System Startup Vapor Sample Analytical Results, Tentatively Identified Compounds, Northrop Grumman Operable Unit 3 Soil Gas Interim Remedial Measure, Former Grumman Settler Bethpage, New York⁽⁴⁾.

Tentatively Identified Compounds ^(1,3) (units in ug/m3)	Well Sampled: Sample Date:	Well 7D 2/18/08	Well 1S 2/18/08	Well 2S 2/18/08	Well 3S ⁽²⁾ 2/25/08	Well 4S 2/18/08	Well 5S 2/18/08
Acetaldehyde	--	--	30	30	--	--	20
Isopropyl Alcohol	--	--	200	80	--	--	30
Tetrahydrofuran	--	--	10	--	--	50	100
C ₅ H ₁₀ O ₂	--	--	30	100	--	90	40
C ₅ H ₁₀ O ₂	--	--	20	70	--	60	20
Cyclohexanone	--	--	--	50	--	20	20
Cumene	--	--	600	1,000	--	1,000	500
Benzaldehyde	--	--	30	--	--	--	20
alpha-Methylstyrene	--	--	20	20	--	20	--
Acetophenone	--	--	300	200	70	200	200
C ₉ H ₁₂ O	--	--	100	300	100	200	300
Dodecene Isomer	--	--	--	50	--	20	100
Tetradecene Isomer	--	--	--	--	--	50	100
Chlorodifluoromethane	NF	NF	NF	NF	NF	NF	NF
Chlorodifluoromethane + Propene + Propane + Carbonyl Sulfide	--	--	--	--	--	--	--
2-Butoxyethanol	--	--	--	100	--	--	80
Ethanol	--	--	--	--	--	--	--
2-Butanol	--	--	--	--	--	--	--
1,2-Ethanediol	--	--	--	--	--	--	--
Propylene Glycol	--	--	--	--	--	--	--
Cyclohexanol	--	--	--	--	--	--	--
2,5-Hexanedione	--	--	--	--	--	--	--
Hexamethylcyclotrisiloxane	--	--	--	90	--	--	--
1-Butanol	--	--	--	--	--	--	--
2-Ethyl-1-hexanol	--	--	--	--	--	--	--
Acetaldehyde + Isobutane	--	--	--	--	--	--	--
Carbonyl Sulfide	--	--	--	--	--	--	--
C ₁₀ H ₂₀ Compound	--	--	--	--	--	--	--
C ₅ H ₈ O	--	--	--	--	--	--	--
alpha-Pinene	--	--	--	--	--	--	--
Decene Isomer	--	--	--	--	--	--	--
2,5-Dimethylfuran	--	--	20	--	--	--	--
Octamethylcyclotrasiloxane	--	--	--	50	--	--	--
Decene Isomer + Octamethylcyclotrasiloxane	--	--	--	--	--	--	20
C ₇ H ₁₂ O ₃ + C ₈ H ₁₈ O	--	--	--	--	--	--	20
Acetaldehyde + Isobutane	--	--	--	--	--	--	--
C ₇ H ₁₂ O ₃	--	--	--	--	--	--	--
C ₇ H ₁₂ O ₃	--	--	--	--	--	--	--
Methylcyclohexane	--	--	--	--	80	--	--
C ₇ H ₁₄	--	--	--	--	30	--	--
C ₉ H ₂₀ Branched Alkane	--	--	--	--	20	--	--
C ₈ H ₁₈ Branched Alkane	--	--	--	--	30	--	--
C ₈ H ₁₆	--	--	--	--	20	--	--
C ₁₁ H ₂₄ Branched Alkane	--	--	--	--	30	--	--
C ₁₁ H ₂₄ Branched Alkane	--	--	--	--	20	--	--
C ₁₂ H ₂₆ Branched Alkane	--	--	--	--	40	--	--

Notes and Abbreviations on Last Page

ARCADIS

Appendix A-2. Summary of System Startup Vapor Sample Analytical Results, Tentatively Identified Compounds, Northrop Grumman Operable Unit 3 Soil Gas Interim Remedial Measure, Former Grumman Settling Ponds, Bethpage, New York⁽⁴⁾.

Tentatively Identified Compounds ^(1,3) (units in ug/m3)	Well Sampled: Sample Date:	Well 6S 2/18/08	Well 7S 2/18/08	Well 8S 2/18/08	Well 9S 2/18/08	Well 11S 2/18/08	Well 10S 2/18/08
Acetaldehyde		--	--	30	20	--	--
Isopropyl Alcohol		30	800	90	100	40	500
Tetrahydrofuran		20	--	50	10	10	50
C ₅ H ₁₀ O ₂		--	--	100	50	8	--
C ₅ H ₁₀ O ₂		--	--	50	30	--	--
Cyclohexanone		40	--	40	50	20	300
Cumene		200	--	1,000	700	300	500
Benzaldehyde		10	--	20	10	6	--
alpha-Methylstyrene		10	--	20	10	--	--
Acetophenone		200	--	200	100	50	400
C ₉ H ₁₂ O		500	--	200	100	60	400
Dodecene Isomer		--	--	40	10	--	30
Tetradecene Isomer		--	--	40	20	--	--
Chlorodifluoromethane		NF	NF	NF	NF	--	NF
Chlorodifluoromethane + Propene + Propane + Carbonyl Sulfide		--	--	--	--	5	--
2-Butoxyethanol		70	2,000		10	8	800
Ethanol		40	1,000			7	2,000
2-Butanol		--	--	--	--	--	10
1,2-Ethanediol		--	--	--	--	--	10
Propylene Glycol		--	--	--	--	10	30
Cyclohexanol		--	--	--	--	--	20
2,5-Hexanedione		--	--	--	10	20	--
Hexamethylcyclotrisiloxane		--	--	--	--	4	--
1-Butanol		--	--	--	--	--	8
2-Ethyl-1-hexanol		--	--	--	--	--	10
Acetaldehyde + Isobutane		10	--	--	--	--	--
Carbonyl Sulfide		--	--	--	--	--	--
C ₁₀ H ₂₀ Compound		--	--	--	--	--	--
C ₅ H ₈ O		--	--	--	--	8	--
alpha-Pinene		--	--	--	--	4	--
Decene Isomer		--	--	--	--	4	10
2,5-Dimethylfuran		--	--	--	--	--	--
Octamethylcyclotrasiloxane		--	--	--	--	--	--
Decene Isomer + Octamethylcyclotrasiloxane		--	--	--	--	--	--
C ₇ H ₁₂ O ₃ + C ₈ H ₁₈ O		--	--	--	--	--	--
Acetaldehyde + Isobutane		--	--	--	--	--	--
C ₇ H ₁₂ O ₃		100	--	--	--	--	--
C ₇ H ₁₂ O ₃		50	--	--	--	--	--
Methylcyclohexane		--	--	--	--	--	--
C ₇ H ₁₄		--	--	--	--	--	--
C ₉ H ₂₀ Branched Alkane		--	--	--	--	--	--
C ₈ H ₁₈ Branched Alkane		--	--	--	--	--	--
C ₈ H ₁₆		--	--	--	--	--	--
C ₁₁ H ₂₄ Branched Alkane		--	--	--	--	--	--
C ₁₁ H ₂₄ Branched Alkane		--	--	--	--	--	--
C ₁₂ H ₂₆ Branched Alkane		--	--	--	--	--	--

Notes and Abbreviations on Last Page

Appendix A-2. Summary of System Startup Vapor Sample Analytical Results, Tentatively Identified Compounds, Northrop Grumman Operable Unit 3 Soil Gas Interim Remedial Measure, Former Grumman Settling Ponds, Bethpage, New York⁽⁴⁾.

Notes and Abbreviations:

-- Not Reported during this sampling event.

NF Compound was searched for, but not found.

ug/m³ micrograms per cubic meter

1. Tentatively Identified Compounds (TICs) are identified based on review of mass spectrometry results via a comprehensive library search of all organic compounds.
2. Depressurization well 3S analytical sample was collected on 2/25 instead of 2/18 due to a sampling error.
3. All results are estimated.
4. Samples were collected by O&M personnel on the dates shown and submitted to Columbia Analytical Services Laboratory (Simi Valley, CA or Rochester, NY locations) for VOC analyses using USEPA Method TO-15 modified in accordance with the project Sampling and Analysis Plan (ARCADIS,2008) . Data presented in this table corresponds to the period February - June 2008.

ARCADIS

Appendix A-3. Summary of Total Influent and Effluent Vapor Sample Analytical Results, Northrop Grumman Operable Unit 3
Soil Gas Interim Remedial Measure, Former Grumman Settling Ponds, Bethpage, New York⁽¹⁾.

Compound (units in ug/m3)	Location ID: Sample Date:	VSP-601 2/18/2008	VSP-602 2/18/2008	VSP-601 2/19/2008	VSP-602 2/19/2008
1,1,1-Trichloroethane		110	< 0.62	71	< 0.61
1,1,2,2-Tetrachloroethane		< 14	< 0.62	< 11	< 0.61
1,1,2-Trichloroethane		< 14	< 0.62	< 11	< 0.61
1,1-Dichloroethane		43	< 0.62	33	< 0.61
1,1-Dichloroethene		< 14	< 0.62	< 11	< 0.61
1,2-Dichloroethane		< 14	< 0.62	< 11	< 0.61
1,2-Dichloropropane		< 14	< 0.62	< 11	< 0.61
1,3-Butadiene		< 14	< 0.62	< 11	< 0.61
2-Butanone		16	< 0.62	< 11	< 0.61
2-Hexanone		< 14	< 0.62	< 11	< 0.61
4-Methyl-2-Pentanone		< 14	< 0.62	< 11	< 0.61
Acetone		< 140	< 6.2	< 110	< 6.1
Benzene		67	< 0.62	22	< 0.61
Bromodichloromethane		< 14	< 0.62	< 11	< 0.61
Bromoform		< 14	< 0.62	< 11	< 0.61
Bromomethane		< 14	< 0.62	< 11	< 0.61
Carbon Disulfide		< 14	< 0.62	< 11	< 0.61
Carbon Tetrachloride		< 14	< 0.62	< 11	< 0.61
CFC-11		< 14	< 0.62	< 11	< 0.61
Chlorobenzene		< 14	< 0.62	< 11	< 0.61
Chlorodibromomethane		< 14	< 0.62	< 11	< 0.61
Chloroethane		< 14	< 0.62	< 11	< 0.61
Chloroform		34	< 0.62	24	< 0.61
Chloromethane		< 14	< 0.62	< 11	< 0.61
cis-1,2-Dichloroethene		5800	< 0.62	4600	< 0.61
cis-1,3-Dichloropropene		< 14	< 0.62	< 11	< 0.61
Ethylbenzene		< 14	< 0.62	< 11	< 0.61
Freon 113		< 14	< 0.62	< 11	< 0.61
Freon 12		< 14	< 0.62	< 11	0.71
Methyl Tert-Butyl Ether		< 14	< 0.62	< 11	< 0.61
Methylene Chloride		< 14	< 0.62	< 11	< 0.61
Styrene		< 14	< 0.62	< 11	< 0.61
Tetrachloroethene		340	< 0.62	200	< 0.61
Toluene		92	< 0.62	98	< 0.61
Trans-1,2-Dichloroethene		120	< 0.62	71	< 0.61
Trans-1,3-Dichloropropene		< 14	< 0.62	< 11	< 0.61
Trichloroethylene		14000	< 0.62	9400	< 0.61
Vinyl Chloride		< 14	< 0.62	< 11	< 0.61
Xylene-O		< 14	< 0.62	< 11	< 0.61
Xylenes - M,P		< 28	< 1.2	< 21	< 1.2
TVOC		20,622	0.0	14,519	0.71

Notes and Abbreviations on Last Page

ARCADIS

Appendix A-3. Summary of Total Influent and Effluent Vapor Sample Analytical Results, Northrop Grumman Operable Unit 3
Soil Gas Interim Remedial Measure, Former Grumman Settling Ponds, Bethpage, New York⁽¹⁾.

Compound (units in ug/m3)	Location ID: Sample Date:	VSP-601 2/25/2008	VSP-602 2/25/2008	VSP-601 3/3/2008	VSP-602 3/3/2008
1,1,1-Trichloroethane		35	< 0.63	26	< 0.63
1,1,2,2-Tetrachloroethane		< 25	< 0.63	< 13	< 0.63
1,1,2-Trichloroethane		< 25	< 0.63	< 13	< 0.63
1,1-Dichloroethane		45	< 0.63	47	< 0.63
1,1-Dichloroethene		< 25	< 0.63	< 13	< 0.63
1,2-Dichloroethane		< 25	< 0.63	< 13	< 0.63
1,2-Dichloropropane		< 25	< 0.63	< 13	< 0.63
1,3-Butadiene		< 25	< 0.63	< 13	< 0.63
2-Butanone		< 25	< 0.63	< 13	< 0.63
2-Hexanone		< 25	< 0.63	< 13	< 0.63
4-Methyl-2-Pentanone		< 25	< 0.63	< 13	< 0.63
Acetone		< 250	< 6.3	< 130	< 6.3
Benzene		< 25	< 0.63	< 13	< 0.63
Bromodichloromethane		< 25	< 0.63	< 13	< 0.63
Bromoform		< 25	< 0.63	< 13	< 0.63
Bromomethane		< 25	< 0.63	< 13	< 0.63
Carbon Disulfide		< 25	< 0.63	< 13	< 0.63
Carbon Tetrachloride		< 25	< 0.63	< 13	< 0.63
CFC-11		< 25	< 0.63	< 13	< 0.63
Chlorobenzene		< 25	< 0.63	< 13	< 0.63
Chlorodibromomethane		< 25	< 0.63	< 13	< 0.63
Chloroethane		< 25	< 0.63	< 13	< 0.63
Chloroform		< 25	< 0.63	27	< 0.63
Chloromethane		< 25	< 0.63	< 13	< 0.63
cis-1,2-Dichloroethene		2900	< 0.63	1600	< 0.63
cis-1,3-Dichloropropene		< 25	< 0.63	< 13	< 0.63
Ethylbenzene		< 25	< 0.63	< 13	< 0.63
Freon 113		< 25	< 0.63	< 13	< 0.63
Freon 12		< 25	5.7	13	8.3
Methyl Tert-Butyl Ether		< 25	< 0.63	< 13	< 0.63
Methylene Chloride		< 25	< 0.63	< 13	< 0.63
Styrene		< 25	< 0.63	< 13	< 0.63
Tetrachloroethene		82	< 0.63	45	< 0.63
Toluene		34	< 0.63	61	< 0.63
Trans-1,2-Dichloroethene		< 25	< 0.63	< 13	< 0.63
Trans-1,3-Dichloropropene		< 25	< 0.63	< 13	< 0.63
Trichloroethylene		5100	< 0.63	2500	< 0.63
Vinyl Chloride		< 25	1.1	200	40
Xylene-O		< 25	< 0.63	< 13	< 0.63
Xylenes - M,P		< 51	< 1.3	< 13	< 0.63
TVOC		8,196	6.8	4,519	48.3

Notes and Abbreviations on Last Page

ARCADIS

Appendix A-3. Summary of Total Influent and Effluent Vapor Sample Analytical Results, Northrop Grumman Operable Unit 3 Soil Gas Interim Remedial Measure, Former Grumman Settling Ponds, Bethpage, New York⁽¹⁾.

Compound (units in ug/m3)	Location ID: Sample Date:	VSP-601 3/17/2008	VSP-602 3/17/2008	VSP-601 4/16/2008	VSP-602 4/16/2008
1,1,1-Trichloroethane		35	< 14	<25	< 15
1,1,2,2-Tetrachloroethane		< 3.6	< 3.6	< 3.6	< 3.6
1,1,2-Trichloroethane		< 14	< 14	< 14	< 14
1,1-Dichloroethane		59	< 11	31	< 11
1,1-Dichloroethene		< 10	< 10	< 10	< 10
1,2-Dichloroethane		< 11	< 11	< 11	< 11
1,2-Dichloropropane		< 12	< 12	< 12	< 12
1,3-Butadiene		< 12	< 12	< 12	< 12
2-Butanone		< 16	< 16	< 16	< 16
2-Hexanone		< 11	< 11	< 11	< 11
4-Methyl-2-Pentanone		< 22	< 22	< 22	< 22
Acetone		< 31	< 31	< 31	< 31
Benzene		< 8.4	< 8.4	< 8.4	< 8.4
Bromodichloromethane		< 3.5	< 3.5	< 3.5	< 3.5
Bromoform		< 27	< 27	< 27	< 27
Bromomethane		< 10	< 10	< 10	< 10
Carbon Disulfide		< 8.2	< 8.2	< 8.2	< 8.2
Carbon Tetrachloride		< 3.3	< 3.3	< 3.3	< 3.3
CFC-11		< 15	< 15	< 15	< 15
Chlorobenzene		< 12	< 12	< 12	< 12
Chlorodibromomethane		< 4.5	< 4.5	< 4.5	< 4.5
Chloroethane		< 14	< 14	< 14	< 14
Chloroform		35	< 13	<22	< 13
Chloromethane		< 11	< 11	< 11	< 11
cis-1,2-Dichloroethene		1400 D	< 10	1100	78
cis-1,3-Dichloropropene		< 24	< 24	< 24	< 24
Ethylbenzene		< 23	< 23	< 23	< 23
Freon 113		< 4	< 4	< 4	< 4
Freon 12		46	< 26	<46	< 26
Methyl Tert-Butyl Ether		< 19	< 19	< 19	< 19
Methylene Chloride		< 9.2	< 9.2	< 9.2	< 9.2
Styrene		< 22	< 22	< 22	< 22
Tetrachloroethene		39	< 3.6	54	< 3.7
Toluene		140	< 10	37	< 10
Trans-1,2-Dichloroethene		10	< 10	<19	< 10
Trans-1,3-Dichloropropene		< 12	< 12	< 12	< 12
Trichloroethylene		1500 D	< 2.8	1300	< 2.9
Vinyl Chloride		980 D	920 D	120	710
Xylene-O		< 23	< 23	< 23	< 23
Xylenes - M,P		< 46	< 46	< 46	< 46
TVOC		4,244	920	2,642	788

Notes and Abbreviations on Last Page

ARCADIS

Appendix A-3. Summary of Total Influent and Effluent Vapor Sample Analytical Results, Northrop Grumman Operable Unit 3
Soil Gas Interim Remedial Measure, Former Grumman Settling Ponds, Bethpage, New York⁽¹⁾.

Compound (units in ug/m3)	Location ID: Sample Date:	VSP-601 5/19/2008	VSP-602 5/19/2008	VSP-601 6/2/2008	VSP-602 6/2/2008
1,1,1-Trichloroethane		38	< 2.7	44	< 2.5
1,1,2,2-Tetrachloroethane		< 6.6	< 0.67	< 6.3	< 0.63
1,1,2-Trichloroethane		< 26	< 2.7	< 25	< 2.5
1,1-Dichloroethane		25	5.8	27	7.6
1,1-Dichloroethene		< 19	< 1.9	< 18	< 1.8
1,2-Dichloroethane		< 20	< 2	< 19	< 1.9
1,2-Dichloropropane		< 22	< 2.3	< 21	< 2.1
1,3-Butadiene		< 21	< 2.2	< 20	< 2
2-Butanone		< 28	< 2.9	28	< 2.7
2-Hexanone		< 20	< 2	< 19	< 1.9
4-Methyl-2-Pentanone		< 39	< 4	< 38	< 3.8
Acetone		< 57	< 5.8	< 55	8.4
Benzene		19	< 1.6	< 15	< 1.5
Bromodichloromethane		< 6.5	< 0.66	< 6.2	< 0.62
Bromoform		< 50	< 5.1	< 48	< 4.8
Bromomethane		< 19	< 1.9	< 18	< 1.8
Carbon Disulfide		< 15	< 1.5	< 14	< 1.4
Carbon Tetrachloride		< 6.1	< 0.62	< 5.8	< 0.58
CFC-11		< 27	< 2.8	< 26	< 2.6
Chlorobenzene		< 22	< 2.3	< 21	< 2.1
Chlorodibromomethane		< 8.2	< 0.84	< 7.8	< 0.78
Chloroethane		< 25	< 2.6	< 24	< 2.4
Chloroform		44	< 2.4	55	3
Chloromethane		< 20	< 2	< 19	< 1.9
cis-1,2-Dichloroethene		950	180	930	230 D
cis-1,3-Dichloropropene		< 44	< 4.5	< 42	< 4.2
Ethylbenzene		< 42	< 4.3	< 40	< 4
Freon 113		< 7.4	< 0.75	< 7	< 0.7
Freon 12		< 48	< 4.9	< 45	< 4.5
Methyl Tert-Butyl Ether		< 35	< 3.5	< 33	< 3.3
Methylene Chloride		< 17	< 1.7	< 16	< 1.6
Styrene		< 41	< 4.2	< 39	< 3.9
Tetrachloroethene		42	< 0.67	48	2.2
Toluene		< 18	< 1.8	< 17	< 1.7
Trans-1,2-Dichloroethene		< 19	< 1.9	< 18	2.8
Trans-1,3-Dichloropropene		< 22	< 2.2	< 21	< 2.1
Trichloroethylene		1000	5.3	1100	6.5
Vinyl Chloride		< 12	65	< 12	13
Xylene-O		< 42	< 4.3	< 40	< 4
Xylenes - M,P		< 84	< 8.5	< 80	< 8
TVOC		2,118	256	2,232	274

Notes and Abbreviations on Last Page

Appendix A-3. Summary of Total Influent and Effluent Vapor Sample Analytical Results, Northrop Grumman Operable Unit 3 Soil Gas Interim Remedial Measure, Former Grumman Settling Ponds, Bethpage, New York⁽¹⁾.

Notes and Abbreviations:

Bold	Compound detected above method detection limit
D	Compound detected at a secondary dilution
TVOC	Total volatile organic compounds
ug/m³	Micrograms per cubic meter

1. Samples were collected by O&M personnel on the dates shown and submitted to Columbia Analytical Services Laboratory (Simi Valley, CA or Rochester, NY locations) for VOC analyses using USEPA Method TO-15 modified in accordance with the project Sampling and Analysis Plan (ARCADIS,2008) . Data presented in this table corresponds to the period February - June 2008.

ARCADIS

Appendix A-4. Summary of Total Influent and Effluent Vapor Sample Analytical Results, Tentatively Identified Compounds, Northrop Grumman Operable Unit 3, Soil Gas Interim Remedial Measure, Former Grumman Settling Ponds, Bethpage, New York(2).

Tentatively Identified Compounds ^(3,4)	Date Sampled:	Carbon Influent - VSP-601							
		02/18/08 (ppbv)	02/19/08 (ppbv)	02/25/08 (ppbv)	03/03/08 (ppbv)	3/17/2008 ⁽⁶⁾ (ppbv)	04/16/08 (ppbv)	05/19/08 (ppbv)	6/2/2008 ⁽⁶⁾ (ppbv)
Chlorodifluoromethane + Propene + Propane	--	--	--	--	--	--	--	--	--
Hexamethylcyclotrisiloxane ⁽¹⁾	--	--	--	--	--	--	--	--	--
2-Ethyl-1-hexanol	--	--	--	--	--	--	--	--	--
n-Nonanal	--	--	--	--	--	--	--	--	--
Chlorodifluoromethane (Freon 22)	NF	NF	NF	30	170	110	250	260	
Ethanol	1000	400	--	--	--	--	--	--	
Acetophenone	20	--	--	--	--	--	--	--	
alpha-Cumyl Alcohol	--	10	--	--	--	--	--	--	
Chloroethene	--	--	--	30	--	--	--	--	
Methylcyclohexane	--	--	--	20	62	--	--	--	
Propane	--	--	--	--	--	--	--	--	
Acetaldehyde	--	--	--	--	--	--	--	--	
Unknown CFC	--	--	--	--	--	400	220	250	
3-Methyl-Hexane	--	--	--	--	6	--	--	--	
Heptane	--	--	--	--	11	--	--	--	
Unknown cyclic hydrocarbon	--	--	--	--	9	--	--	--	
1,2,4-trimethylcyclopentane	--	--	--	--	6	--	--	--	
Unknown aliphatic hydrocarbon	--	--	--	--	7	--	--	--	
Unknown aliphatic hydrocarbon	--	--	--	--	6	--	--	--	
1,3-dimethyl-cis-cyclohexane	--	--	--	--	6	--	--	--	

Notes and abbreviations on last page

ARCADIS

Appendix A-4. Summary of Total Influent and Effluent Vapor Sample Analytical Results, Tentatively Identified Compounds, Northrop Grumman Operable Unit 3, Soil Gas Interim Remedial Measure, Former Grumman Settling Ponds, Bethpage, New York(2).

Tentatively Identified Compounds ^(3,4)	Carbon Effluent - VSP 602								
	Date Sampled:	02/18/08	02/19/08	02/25/08	03/03/08	3/17/2008 ⁽⁶⁾	04/16/08	05/19/08	6/2/2008 ⁽⁶⁾
	(ppbv)	(ppbv)	(ppbv)	(ppbv)	(ppbv)	(ppbv)	(ppbv)	(ppbv)	(ppbv)
Chlorodifluoromethane + Propene + Propane	± ⁽⁵⁾	± ⁽⁵⁾	--	--	--	--	--	--	--
Hexamethylcyclotrisiloxane ⁽¹⁾	0.60	--	--	--	--	--	--	--	--
2-Ethyl-1-hexanol	3	--	--	--	--	--	--	--	--
n-Nonanal	0.7	--	--	--	--	--	--	--	--
Chlorodifluoromethane (Freon 22)	NF	NF	5	20	110	220	120	140	
Ethanol	--	30	400	700	14	9	3	4	
Acetophenone	--	--	--	--	--	--	--	--	
alpha-Cumyl Alcohol	--	--	--	--	--	--	--	--	
Chloroethene	--	--	--	8	--	--	--	--	
Methylcyclohexane	--	--	--	--	--	--	--	--	
Propane	--	--	10	9	--	--	--	--	
Acetaldehyde	--	--	--	3	--	--	--	--	
Unknown CFC	--	--	--	--	--	110	180	160	
3-Methyl-Hexane	--	--	--	--	--	--	--	--	
Heptane	--	--	--	--	--	--	--	--	
Unknown cyclic hydrocarbon	--	--	--	--	--	--	--	--	
1,2,4-trimethylcyclopentane	--	--	--	--	--	--	--	--	
Unknown aliphatic hydrocarbon	--	--	--	--	--	--	--	--	
Unknown aliphatic hydrocarbon	--	--	--	--	--	--	--	--	
1,3-dimethyl-cis-cyclohexane	--	--	--	--	--	--	--	--	

Notes and abbreviations on last page

ARCADIS

Appendix A-4. Summary of Total Influent and Effluent Vapor Sample Analytical Results, Tentatively Identified Compounds, Northrop Grumman Operable Unit 3, Soil Gas Interim Remedial Measure, Former Grumman Settling Ponds, Bethpage, New York(2).

Notes and Abbreviations:

- Not Reported during this sampling event.
- NF Compound was searched for, but not found.
- ppbv Parts per billion by volume.

- 1. Possible laboratory artifact.
- 2. Samples were collected by O&M personnel on the dates shown and submitted to Columbia Analytical Services Laboratory (Simi Valley, CA or Rochester, NY locations) for VOC analyses using USEPA Method TO-15 modified in accordance with the project Sampling and Analysis Plan (ARCADIS, 2008). Data presented in this table corresponds to the period February - June 2008.
- 3. Tentatively Identified Compounds (TICs) are identified based on review of mass spectrometry results via a comprehensive library search of all organic compounds.
- 4. All results are estimated.
- 5. ± = Analyte was detected, but cannot be calculated to ppbv because molecular weight is unknown.
- 6. Compounds identified in an analysis at a secondary dilution factor.

ARCADIS

Appendix A-5

Supplemental Vinyl Chloride
Screening Analytical Data



AN ENVIRONMENTAL ANALYTICAL LABORATORY

Air Toxics Ltd. Introduces the Electronic Report

Thank you for choosing Air Toxics Ltd. To better serve our customers, we are providing your report by e-mail. This document is provided in Portable Document Format which can be viewed with Acrobat Reader by Adobe.

This electronic report includes the following:

- Work order Summary;
- Laboratory Narrative;
- Results; and
- Chain of Custody (copy).

180 BLUE RAVINE ROAD, SUITE B FOLSOM, CA - 95630

**(916) 985-1000 .FAX (916) 985-1020
Hours 8:00 A.M to 6:00 P.M. Pacific**



AN ENVIRONMENTAL ANALYTICAL LABORATORY

WORK ORDER #: 0804388

Work Order Summary

CLIENT:	Ms. Christina Tuohy ARCADIS, Inc. Two Huntington Quadrangle Suite 1S10 Melville, NY 11747	BILL TO:	Ms. Patricia Riche ARCADIS, Inc. Two Huntington Quadrangle Suite 1S10 Melville, NY 11747
PHONE:	631-249-7600	P.O. #	NJ001464.0908.00001
FAX:		PROJECT #	NJ001464.0908.00001
DATE RECEIVED:	04/17/2008	CONTACT:	Bryanna Langley
DATE COMPLETED:	04/18/2008		

<u>FRACTION #</u>	<u>NAME</u>	<u>TEST</u>	<u>RECEIPT VAC./PRES.</u>	<u>FINAL PRESSURE</u>
01A	DW-3S	Modified TO-14A/15 (5&20 p	Tedlar Bag	Tedlar Bag
02A	DW-7S	Modified TO-14A/15 (5&20 p	Tedlar Bag	Tedlar Bag
03A	DW-4D	Modified TO-14A/15 (5&20 p	Tedlar Bag	Tedlar Bag
03AA	DW-4D Lab Duplicate	Modified TO-14A/15 (5&20 p	Tedlar Bag	Tedlar Bag
04A	DW-3D	Modified TO-14A/15 (5&20 p	Tedlar Bag	Tedlar Bag
05A	Lab Blank	Modified TO-14A/15 (5&20 p	NA	NA
06A	CCV	Modified TO-14A/15 (5&20 p	NA	NA
07A	LCS	Modified TO-14A/15 (5&20 p	NA	NA

CERTIFIED BY:

Laboratory Director

DATE: 04/18/08

Certification numbers: CA NELAP - 02110CA, LA NELAP/LELAP- AI 30763, NJ NELAP - CA004
NY NELAP - 11291, UT NELAP - 9166389892

Name of Accrediting Agency: NELAP/Florida Department of Health, Scope of Application: Clean Air Act,
Accreditation number: E87680, Effective date: 07/01/07, Expiration date: 06/30/08

Air Toxics Ltd. certifies that the test results contained in this report meet all requirements of the NELAC standards

This report shall not be reproduced, except in full, without the written approval of Air Toxics Ltd.

180 BLUE RAVINE ROAD, SUITE B FOLSOM, CA - 95630
(916) 985-1000 . (800) 985-5955 . FAX (916) 985-1020

LABORATORY NARRATIVE
Modified TO-15 Soil Gas
ARCADIS, Inc.
Workorder# 0804388

Four 1 Liter Tedlar Bag samples were received on April 17, 2008. The laboratory performed analysis via modified EPA Method TO-15 using GC/MS in the full scan mode. The method involves concentrating up to 50 mLs of air. The concentrated aliquot is then flash vaporized and swept through a water management system to remove water vapor. Following dehumidification, the sample passes directly into the GC/MS for analysis.

This workorder was independently validated prior to submittal using 'USEPA National Functional Guidelines' as generally applied to the analysis of volatile organic compounds in air. A rules-based, logic driven, independent validation engine was employed to assess completeness, evaluate pass/fail of relevant project quality control requirements and verification of all quantified amounts.

Method modifications taken to run these samples are summarized in the table below. Specific project requirements may over-ride the ATL modifications.

<i>Requirement</i>	<i>TO-15</i>	<i>ATL Modifications</i>
Daily CCV	+/- 30% Difference	<= 30% Difference with two allowed out up to <=40%.; flag and narrate outliers
Sample collection media	Summa canister	ATL recommends use of summa canisters to insure data defensibility, but will report results from Tedlar bags at client request
Method Detection Limit	Follow 40CFR Pt.136 App. B	The MDL met all relevant requirements in Method TO-15 (statistical MDL less than the LOQ). The concentration of the spiked replicate may have exceeded 10X the calculated MDL in some cases

Receiving Notes

There were no receiving discrepancies.

Analytical Notes

There were no analytical discrepancies.

Definition of Data Qualifying Flags

Eight qualifiers may have been used on the data analysis sheets and indicates as follows:

- B - Compound present in laboratory blank greater than reporting limit (background subtraction not performed).
- J - Estimated value.
- E - Exceeds instrument calibration range.
- S - Saturated peak.
- Q - Exceeds quality control limits.



AN ENVIRONMENTAL ANALYTICAL LABORATORY

- U - Compound analyzed for but not detected above the reporting limit.
- UJ- Non-detected compound associated with low bias in the CCV
- N - The identification is based on presumptive evidence.

File extensions may have been used on the data analysis sheets and indicates as follows:

- a-File was requantified
- b-File was quantified by a second column and detector
- r1-File was requantified for the purpose of reissue



AN ENVIRONMENTAL ANALYTICAL LABORATORY

Summary of Detected Compounds MODIFIED EPA METHOD TO-15 GC/MS

Client Sample ID: DW-3S

Lab ID#: 0804388-01A

No Detections Were Found.

Client Sample ID: DW-7S

Lab ID#: 0804388-02A

No Detections Were Found.

Client Sample ID: DW-4D

Lab ID#: 0804388-03A

No Detections Were Found.

Client Sample ID: DW-4D Lab Duplicate

Lab ID#: 0804388-03AA

No Detections Were Found.

Client Sample ID: DW-3D

Lab ID#: 0804388-04A

No Detections Were Found.



AN ENVIRONMENTAL ANALYTICAL LABORATORY

Client Sample ID: DW-3S

Lab ID#: 0804388-01A

MODIFIED EPA METHOD TO-15 GC/MS

File Name:	c041709	Date of Collection:	4/16/08
Dil. Factor:	1.00	Date of Analysis:	4/17/08 02:09 PM

Compound	Rpt. Limit (ppbv)	Amount (ppbv)	Rpt. Limit (uG/m3)	Amount (uG/m3)
Vinyl Chloride	5.0	Not Detected	13	Not Detected

Container Type: 1 Liter Tedlar Bag

Surrogates	%Recovery	Method Limits
1,2-Dichloroethane-d4	106	70-130
Toluene-d8	100	70-130
4-Bromofluorobenzene	103	70-130



AN ENVIRONMENTAL ANALYTICAL LABORATORY

Client Sample ID: DW-7S

Lab ID#: 0804388-02A

MODIFIED EPA METHOD TO-15 GC/MS

File Name:	c041710	Date of Collection:	4/16/08
Dil. Factor:	1.00	Date of Analysis:	4/17/08 02:38 PM

Compound	Rpt. Limit (ppbv)	Amount (ppbv)	Rpt. Limit (uG/m3)	Amount (uG/m3)
Vinyl Chloride	5.0	Not Detected	13	Not Detected

Container Type: 1 Liter Tedlar Bag

Surrogates	%Recovery	Method Limits
1,2-Dichloroethane-d4	106	70-130
Toluene-d8	100	70-130
4-Bromofluorobenzene	108	70-130



AN ENVIRONMENTAL ANALYTICAL LABORATORY

Client Sample ID: DW-4D

Lab ID#: 0804388-03A

MODIFIED EPA METHOD TO-15 GC/MS

File Name:	c041711	Date of Collection:	4/16/08
Dil. Factor:	1.00	Date of Analysis:	4/17/08 03:05 PM

Compound	Rpt. Limit (ppbv)	Amount (ppbv)	Rpt. Limit (uG/m3)	Amount (uG/m3)
Vinyl Chloride	5.0	Not Detected	13	Not Detected

Container Type: 1 Liter Tedlar Bag

Surrogates	%Recovery	Method Limits
1,2-Dichloroethane-d4	105	70-130
Toluene-d8	98	70-130
4-Bromofluorobenzene	106	70-130



AN ENVIRONMENTAL ANALYTICAL LABORATORY

Client Sample ID: DW-4D Lab Duplicate

Lab ID#: 0804388-03AA

MODIFIED EPA METHOD TO-15 GC/MS

File Name:	c041712	Date of Collection:	4/16/08
Dil. Factor:	1.00	Date of Analysis:	4/17/08 03:31 PM

Compound	Rpt. Limit (ppbv)	Amount (ppbv)	Rpt. Limit (uG/m3)	Amount (uG/m3)
Vinyl Chloride	5.0	Not Detected	13	Not Detected

Container Type: 1 Liter Tedlar Bag

Surrogates	%Recovery	Method Limits
1,2-Dichloroethane-d4	106	70-130
Toluene-d8	99	70-130
4-Bromofluorobenzene	105	70-130



AN ENVIRONMENTAL ANALYTICAL LABORATORY

Client Sample ID: DW-3D

Lab ID#: 0804388-04A

MODIFIED EPA METHOD TO-15 GC/MS

File Name:	c041713	Date of Collection:	4/16/08
Dil. Factor:	1.00	Date of Analysis:	4/17/08 04:03 PM

Compound	Rpt. Limit (ppbv)	Amount (ppbv)	Rpt. Limit (uG/m3)	Amount (uG/m3)
Vinyl Chloride	5.0	Not Detected	13	Not Detected

Container Type: 1 Liter Tedlar Bag

Surrogates	%Recovery	Method Limits
1,2-Dichloroethane-d4	105	70-130
Toluene-d8	100	70-130
4-Bromofluorobenzene	106	70-130



AN ENVIRONMENTAL ANALYTICAL LABORATORY

Client Sample ID: Lab Blank

Lab ID#: 0804388-05A

MODIFIED EPA METHOD TO-15 GC/MS

File Name:	c041706	Date of Collection:	NA
Dil. Factor:	1.00	Date of Analysis:	4/17/08 12:15 PM

Compound	Rpt. Limit (ppbv)	Amount (ppbv)	Rpt. Limit (uG/m3)	Amount (uG/m3)
Vinyl Chloride	5.0	Not Detected	13	Not Detected

Container Type: NA - Not Applicable

Surrogates	%Recovery	Method Limits
1,2-Dichloroethane-d4	105	70-130
Toluene-d8	100	70-130
4-Bromofluorobenzene	104	70-130



AN ENVIRONMENTAL ANALYTICAL LABORATORY

Client Sample ID: CCV

Lab ID#: 0804388-06A

MODIFIED EPA METHOD TO-15 GC/MS

File Name:	c041703	Date of Collection: NA
Dil. Factor:	1.00	Date of Analysis: 4/17/08 10:46 AM

Compound	%Recovery
----------	-----------

Vinyl Chloride	110
----------------	-----

Container Type: NA - Not Applicable

Surrogates	%Recovery	Method Limits
1,2-Dichloroethane-d4	104	70-130
Toluene-d8	100	70-130
4-Bromofluorobenzene	104	70-130



AN ENVIRONMENTAL ANALYTICAL LABORATORY

Client Sample ID: LCS

Lab ID#: 0804388-07A

MODIFIED EPA METHOD TO-15 GC/MS

File Name:	c041705	Date of Collection: NA
Dil. Factor:	1.00	Date of Analysis: 4/17/08 11:42 AM

Compound	%Recovery
Vinyl Chloride	99

Container Type: NA - Not Applicable

Surrogates	%Recovery	Method Limits
1,2-Dichloroethane-d4	107	70-130
Toluene-d8	101	70-130
4-Bromofluorobenzene	103	70-130

ARCADIS

Appendix B

Summary of Condensate Sample
Analytical Results Including
Tentatively Identified Compounds

ARCADIS

Appendix B-1. Summary of Condensate Sample Analytical Results, Northrop Grumman Operable Unit 3 Soil Gas Interim Remedial Measure, Former Grumman Settling Ponds, Bethpage, New York ⁽²⁾.

Compound (units in ug/L)	Location ID: Sample Date:	KO-200 3/17/2008	KO-300 3/17/2008	WSP-510 3/17/2008	Trip Blank 3/17/2008
	CAS No.				
1,1,1-Trichloroethane	71-55-6	< 1	< 1	<2.5	< 1
1,1,2,2-Tetrachloroethane	79-34-5	< 1	< 1	<2.5	< 1
1,1,2-Trichloroethane	79-00-5	< 1	< 1	<2.5	< 1
1,1-Dichloroethane	75-34-3	1.4	< 1	<2.5	< 1
1,1-Dichloroethene	75-35-4	< 1	< 1	<2.5	< 1
1,2,4-Trichlorobenzene	120-82-1	< 1	< 1	<2.5	< 1
1,2-Dibromo-3-Chloropropane (DBCP)	96-12-8	< 2	< 2	< 5	< 2
1,2-Dibromoethane (EDB)	106-93-4	< 1	< 1	<2.5	< 1
1,2-Dichlorobenzene	95-50-1	< 1	< 1	<2.5	< 1
1,2-Dichloroethane	107-06-2	< 1	< 1	<2.5	< 1
1,2-Dichloropropane	78-87-5	< 1	< 1	<2.5	< 1
1,4-Dichlorobenzene	106-46-7	< 1	< 1	<2.5	< 1
2-Butanone	78-93-3	1000 D	1300 D	440 D	< 5
2-Hexanone	591-78-6	< 5	< 5	< 13	< 5
4-Methyl-2-Pentanone	108-10-1	< 5	< 5	< 13	< 5
Acetone	67-64-1	17	40	44	< 10
Benzene	71-43-2	< 1	< 1	<2.5	< 1
Bromodichloromethane	75-27-4	< 1	< 1	<2.5	< 1
Bromoform	75-25-2	< 1	< 1	<2.5	< 1
Bromomethane	74-83-9	< 2	< 2	< 5	< 2
Carbon Disulfide	75-15-0	< 1	< 1	<2.5	< 1
Carbon Tetrachloride	56-23-5	< 1	< 1	<2.5	< 1
CFC-11	75-69-4	< 1	< 1	<2.5	< 1
Chlorobenzene	108-90-7	< 1	< 1	<2.5	< 1
Chlorodibromomethane	124-48-1	< 1	< 1	<2.5	< 1
Chloroethane	75-00-3	< 2	< 2	< 5	< 2
Chloroform	67-66-3	< 1	< 1	<2.5	< 1
Chloromethane	74-87-3	< 2	< 2	< 5	< 2
cis-1,2-Dichloroethene	156-59-2	40	4	15	< 1
cis-1,3-Dichloropropene	10061-01-5	< 1	< 1	<2.5	< 1
Cyclohexane	110-82-7	< 1	< 1	<2.5	< 1
Ethylbenzene	100-41-4	< 1	< 1	<2.5	< 1
Freon 113	76-13-1	< 1	< 1	<2.5	< 1
Freon 12	75-71-8	< 1	< 1	<2.5	< 1
Isopropylbenzene	98-82-8	< 1	< 1	6.6	< 1
m-Dichlorobenzene	541-73-1	< 1	< 1	<2.5	< 1
Methyl Acetate	79-20-9	< 10	< 10	< 25	< 10
Methyl tert-butyl ether	1634-04-4	< 10	< 1	<2.5	< 1
Methylcyclohexane	108-87-2	< 1	< 1	<2.5	< 1
Methylene Chloride	75-09-2	< 1	< 1	<2.5	< 1
Styrene	100-42-5	< 1	< 1	<2.5	< 1
Tetrachloroethene	127-18-4	< 1	< 1	<2.5	< 1
Toluene	108-88-3	2.2	< 1	<2.5	< 1
trans-1,2-Dichloroethene	156-60-5	1.1	< 1	<2.5	< 1
trans-1,3-Dichloropropene	10061-02-6	< 1	< 1	<2.5	< 1
Trichloroethylene	79-01-6	22	3	9	< 1
Vinyl Chloride	75-01-4	4.8	1.7	<2.5	< 1
Xylene-o	95-47-6	< 1	< 1	<2.5	< 1
Xylenes - m,p	179601-23-1	< 1	< 1	<2.5	< 1
TVOC		1089	1349	515	0

Notes and abbreviations on next page

Appendix B-1. Summary of Condensate Sample Analytical Results, Northrop Grumman Operable Unit 3 Soil Gas Interim Remedial Measure, Former Grumman Settling Ponds, Bethpage, New York ⁽²⁾.

Notes and Abbreviations:

Bold	Compound detected above method detection limit
CAS No.	Chemical abstracts service list number
D	Compound detected at a secondary dilution
TVOC	Total volatile organic compounds
ug/L	Micograms per liter

1. Total volatile organic compounds determined by summing individual detections and rounding to the nearest whole number.
2. Samples were collected by O&M personnel on the dates shown and submitted to Columbia Analytical Services Laboratory (Rochester, NY) for VOC analyses using Method 8260 in accordance with the project Sampling and Analysis Plan (ARCADIS,2008) . Data presented in this table corresponds to the period February - June 2008.

ARCADIS

Appendix B-2. Summary of Condensate Sample Analytical Results, Tentatively Identified Compounds (TICs), Northrop Grumman Operable Unit 3 Soil Gas Interim Remedial Measure, Former Grumman Settling Ponds, Bethpage, New York⁽²⁾.

Tentatively Identified Compound (units in ug/L)	Sample ID: Date:	WSP-200 3/17/2008	WSP-300 3/17/2008	WSP-510 3/17/2008
Unknown		--	--	21 J
Ethanol		--	--	1200 JN
Furan, tetrahydro-		130 JN	140 JN	73 JN
Unknown alcohol		--	14 J	21 J
Cyclohexanone		17 JN	13 JN	--
Isopropyl Alcohol		--	22 JN	--
Butanal		--	5 JN	--
Heptanal		--	9 JN	--
1-Hexanol, 2-ethyl-		--	14 JN	--

Notes and Abbreviations:

- Not Reported
- Bold** Detected
- J Estimated value
- N Presumptive evidence of this constituent. Calibrations were not run for these constituents; therefore, the results should be used for qualitative purposes only.
- ug/L Micograms per liter

1. TICs are identified based on review of mass spectrometry results via a comprehensive library search of all organic compounds.
2. Samples were collected by O&M personnel on the dates shown and submitted to Columbia Analytical Services Laboratory (Rochester, NY) for VOC analyses using Method 8260 in accordance with the project Sampling and Analysis Plan (ARCADIS,2008) . Data presented in this table corresponds to the period February - June 2008.

ARCADIS

Appendix C

Air Modeling Calculations

Table C-1. Summary of SCREEN3 Model Input and Outputs, Northrop Grumman Operable Unit 3 Soil Gas Interim Remedial Measure, Former Grumman Settling Ponds, Bethpage, New York.

Parameters	Date Sampled:	2/18/2008	2/19/2008	2/25/2008	3/3/2008	3/17/2008	4/16/2008	5/19/2008	6/2/2008
SCREEN3 Model Input									
Source Type		Point	Point	Point	Point	Point	Point	Point	Point
Emission Rate (g/s)		1	1	1	1	1	1	1	1
Stack Height (ft)		33	33	33	33	33	33	33	33
Stack Height (m)		10.1	10.1	10.1	10.1	10.1	10.1	10.1	10.1
Stack Inside Diameter (m)		0.41	0.41	0.41	0.41	0.41	0.41	0.41	0.41
Air Flow Rate (scfm) ⁽¹⁾		1,964	1,674	1,679	1,793	1,774	641	666	746
Air Flow Rate (acfm @ stack temp) ⁽²⁾		2,048	1,717	1,754	1,873	1,859	655	671	766
Stack Gas Exit Temperature (K) ⁽¹⁾		307	302	308	308	309	301	296	303
Ambient Air Temperature (K) ⁽³⁾		283	275	274	275	276	281	284	294
Receptor Height (m) ⁽⁴⁾		1.5	1.5	1.5	1.5	1.5	1.5	1.5	1.5
Urban/Rural		Urban	Urban	Urban	Urban	Urban	Urban	Urban	Urban
Building Height (m)		2.4	2.4	2.4	2.4	2.4	2.4	2.4	2.4
Min Horizontal Bldg Dim (m)		4.9	4.9	4.9	4.9	4.9	4.9	4.9	4.9
Max Horizontal Bldg Dim (m)		5.0	5.0	5.0	5.0	5.0	5.0	5.0	5.0
Consider Bldg Downwash?		Yes	Yes	Yes	Yes	Yes	Yes	Yes	Yes
Simple/Complex Terrain Above Stack		Simple	Simple	Simple	Simple	Simple	Simple	Simple	Simple
Simple/Complex Terrain Above Stack Base		Simple	Simple	Simple	Simple	Simple	Simple	Simple	Simple
Meteorology		Full	Full	Full	Full	Full	Full	Full	Full
Automated Distances Array		Yes	Yes	Yes	Yes	Yes	Yes	Yes	Yes
Terrain Height Above Stack Base		0	0	0	0	0	0	0	0
SCREEN3 Model Output									
1-HR Max		596.3	698.3	638.3	622.9	627.6	1,292	1,278	1,200
Annualization Factor ⁽⁶⁾		0.08	0.08	0.08	0.08	0.08	0.08	0.08	0.08
Average Annual Concentration at Receptor Height (ug/m ³) ⁽⁷⁾		47.7	55.9	51.1	49.8	50.2	103.4	102.2	96
Distance To Max Concentration (m) ⁽⁸⁾		66	61	64	64	64	45	45	47

See notes last page.

Table C-1. Summary of SCREEN3 Model Input and Outputs, Northrop Grumman Operable Unit 3 Soil Gas Interim Remedial Measure, Former Grumman Settling Ponds, Bethpage, New York.

Notes

1. The stack air flow rate (in scfm) and temperature were measured using a handheld thermo-anemometer. Values were measured immediately prior to where the effluent air stream enters the vapor-phase carbon unit.
2. The stack air flow rate at the stack temperature (in acfm) was calculated by dividing the stack air flow rate in scfm by the ratio of the standard temperature to the actual stack gas exit temperature.
3. The ambient temperature was recorded from the weather.newday.com website for Islip, New York. The mean actual temperature from the website was used in model calculation.
4. The receptor height corresponds to the average inhalation level.
5. SCREEN3 calculated constituent concentration at listed conditions at the specified inhalation level.
6. A USEPA time averaging conversion factor of 1/0.08 was used to convert the 1-hour maximum concentration output to an annual average.
7. Average annual constituent concentration at the receptor height was calculated by multiplying the one hour maximum concentration by the annualization factor.
8. SCREEN3 calculated distance to the 1-hour maximum concentration.

g/s - Grams per second

ft - Feet

m - Meters

scfm - Standard cubic feet per minute

acfm - Actual cubic feet per minute

K - Kelvin

$\mu\text{g}/\text{m}^3$ - Micrograms per cubic meter

Table C-2. Summary of Annual Maximum Allowable Stack Concentration Calculations, Northrop Grumman Operable Unit 3 Soil Gas Interim Remedial Measure, Former Grumman Settling Ponds, Bethpage, New York.

Constituent	Actual Effluent Concentrations ⁽¹⁾ (µg/m ³)							
	2/18/2008	2/19/2008	2/25/2008	3/3/2008	3/17/2008	4/16/2008	5/19/2008	6/2/2008
Vinyl chloride	0	0	1.1	40	920	710	65	13
1,1-Dichloroethane	0	0	0	0	0	0	5.8	7.6
Trichloroethylene	0	0	0	0	0	0	5.3	6.5
Tetrachloroethylene	0	0	0	0	0	0	0	2.2
cis-1,2-Dichloroethylene	0	0	0	0	0	78	180	230
Dichlorodifluoromethane (Freon 12)	0	0.71	5.7	8.3	0	0	0	0
Acetone	0	0	0	0	0	0	0	8.4
Chloroform	0	0	0	0	0	0	0	3
trans-1,2-Dichloroethene	0	0	0	0	0	0	0	2.8

Constituent	AGC ⁽²⁾ (µg/m ³)	Annual Maximum Allowable Stack Concentration (µg/m ³)							
		2/18/2008	2/19/2008	2/25/2008	3/3/2008	3/17/2008	4/16/2008	5/19/2008	6/2/2008
Vinyl chloride	0.11	2.39E+03	2.43E+03	2.60E+03	2.50E+03	2.50E+03	3.44E+03	3.40E+03	3.17E+03
1,1-Dichloroethane	0.63	1.37E+04	1.39E+04	1.49E+04	1.43E+04	1.43E+04	1.97E+04	1.95E+04	1.82E+04
Trichloroethylene	0.5	1.08E+04	1.10E+04	1.18E+04	1.14E+04	1.14E+04	1.56E+04	1.54E+04	1.44E+04
Tetrachloroethylene	1	2.17E+04	2.21E+04	2.36E+04	2.27E+04	2.27E+04	3.13E+04	3.09E+04	2.88E+04
cis-1,2-Dichloroethylene	1,900	4.12E+07	4.19E+07	4.49E+07	4.32E+07	4.31E+07	5.94E+07	5.87E+07	5.47E+07
Dichlorodifluoromethane (Freon 12)	12,000	2.60E+08	2.65E+08	2.84E+08	2.73E+08	2.72E+08	3.75E+08	3.71E+08	3.46E+08
Acetone	28,000	6.07E+08	6.18E+08	6.62E+08	6.36E+08	6.36E+08	8.76E+08	8.65E+08	8.07E+08
Chloroform	0.043	9.33E+02	9.49E+02	1.02E+03	9.77E+02	9.76E+02	1.35E+03	1.33E+03	1.24E+03
trans-1,2-Dichloroethene	1,900	4.12E+07	4.19E+07	4.49E+07	4.32E+07	4.31E+07	5.94E+07	5.87E+07	5.47E+07

See notes last page.

ARCADIS

Table C-2. Summary of Annual Maximum Allowable Stack Concentration Calculations, Northrop Grumman Operable Unit 3 Soil Gas Interim Remedial Measure, Former Grumman Settling Ponds, Bethpage, New York.

Constituent	Percent of Annual Maximum Allowable Stack Concentration ⁽⁴⁾							
	2/18/2008	2/19/2008	2/25/2008	3/3/2008	3/17/2008	4/16/2008	5/19/2008	6/2/2008
Vinyl chloride	0.00%	0.00%	0.04%	1.60%	36.84%	20.63%	1.91%	0.41%
1,1-Dichloroethane	0.00%	0.00%	0.00%	0.00%	0.00%	0.00%	0.03%	0.04%
Trichloroethylene	0.00%	0.00%	0.00%	0.00%	0.00%	0.00%	0.03%	0.05%
Tetrachloroethylene	0.00%	0.00%	0.00%	0.00%	0.00%	0.00%	0.00%	0.01%
cis-1,2-Dichloroethylene	0.00%	0.00%	0.00%	0.00%	0.00%	0.00%	0.00%	0.00%
Dichlorodifluoromethane (Freon 12)	0.00%	0.00%	0.00%	0.00%	0.00%	0.00%	0.00%	0.00%
Acetone	0.00%	0.00%	0.00%	0.00%	0.00%	0.00%	0.00%	0.00%
Chloroform	0.00%	0.00%	0.00%	0.00%	0.00%	0.00%	0.00%	0.24%
trans-1,2-Dichloroethene	0.00%	0.00%	0.00%	0.00%	0.00%	0.00%	0.00%	0.00%

Notes:

1. Actual effluent concentrations are analytical results from air samples collected on the dates shown.
2. AGC refers to the compound-specific annual guideline concentration per the NYSDEC DAR-1 AGC/SGC tables, revised December 22, 2003.
3. Annual maximum allowable stack concentrations were calculated by dividing the product of the annual guideline concentration of a constituent and the ratio of the SCREEN3 gas emission rate and the SCREEN 3 average annual concentration at receptor height by the air flow rate at the stack temperature and multiplying by the appropriate conversion factors.
4. Percent of MASC was calculated by dividing the actual effluent concentration by the MASC for a given monitoring event.

µg/m³ - Micrograms per cubic meter

AGC - Annual guideline concentration

ARCADIS

Appendix D

Soil Management Summary



ARCADIS
6723 Towpath Road
P.O. Box 66
Syracuse
New York 13214-0066
Tel 315.449.3105
Fax 315.446.5807

MEMO

To:
File

Copies:

From:
Lucas Cullen

Date:
August 4, 2008

ARCADIS Project No.:
NY001464.1907

Subject:
Soil Management Summary
Operable Unit 3 Soil Gas Interim Remedial Measure Construction
Former Grumman Settling Ponds, Bethpage New York

This memorandum has been prepared to provide a summary of soils exported and material imported during the construction of the Soil Gas Interim Remedial Measure (IRM) for Operable Unit Three (OU3) at the Former Grumman Settling Ponds in Bethpage, New York. In general there were three different waste streams that were exported from the site and two different import materials that were imported to the site. The three different waste streams exported from the site are as follows:

- Pre-construction characterized polychlorinated biphenyls (PCB) impacted soils.
- Volatile organic compound (VOC) and chromium impacted soils; and,
- PCB impacted soils discovered during construction.

The two different import material imported to the site are as follows:

- Common backfill; and
- Recycled concrete aggregate (RCA).

ARCADIS

Pre-Construction Characterized Impacted Soils

Prior to mobilization for construction, a pre-characterization program was completed to identify soils that would require off-site disposal from the areas within or just adjacent to the proposed trench alignment. The pre-characterization sample locations, analytical results, and estimated extent of soils removed are identified on Figures D1 and D2. In general these included:

- A zero to four foot excavation within the area where the western leg and southern leg meet.
- A zero to ten foot excavation within the area around boring PC-3-2.
- A zero to eight foot excavation within the area around boring PC-03; and,
- A zero to four foot excavation with the area from approximately B-16W10 to DW-11S.

These soils were shipped to CWM Chemical Services, Inc. Model City Landfill under approved Waste Profile NY296605. Summary tables that present the analytical results for pre-construction laboratory analytical data is provided in Tables D1, D2, D3 and D4. Summary tables that quantify all PCB containing material sent to CWM Chemical Services, Inc. Model City Landfill under Waste Profile NY296605 is provided in Table D1. Copies of manifests for waste transported to CWM Chemical Services, Inc. Model City Landfill are also attached herein.

VOC and Chrome Impacted Soils

On December 17, 2007, during excavation of the trench for the OU3 soil gas IRM, the excavation contractor observed what he characterized as visibly-stained soils along the western leg of the trench. As excavation continued, the visibly-stained soils were removed from the trench and stockpiled. However, shortly after uncovering the visibly-stained materials, the contractor reported an odor that he compared to VOCs. Simultaneous, the community air monitoring equipment used to monitor for VOCs down wind of the excavation indicated the presences of VOCs above the Community Air Monitoring Plan (ARCADIS, March 2006) (CAMP) action level of 5 parts per million (ppm), based on a fifteen minute time-weighted average (TWA). In accordance with the CAMP, excavation activities were halted, the contractor removed equipment from the area, and covered the stock pile and excavation area with polyethylene sheeting.

Soil Sampling Activities

To identify the constituents of concern (COCs) causing the VOC vapors, ARCADIS collected samples of the staged, visibly-stained soils on December 18, 2007. A back hoe was used to dig approximately one foot into the visibly-stained staged soil pile. The uncovered soil from one location was then placed into a stainless steel bowl. The VOC sample was taken directly from the bowl using a

ARCADIS

stainless steel spoon. The remaining soil was then homogenized and used to fill containers for additional sample analyses (i.e., semi volatile organic compounds [SVOCs], PCBs, Toxicity Characteristic Leaching Procedure [TCLP], and Metals). Samples were packaged and sent to Columbia Analytical Services, Inc. of Rochester, New York (Columbia) for laboratory analysis.

Analytical results obtained from the soil sample collected on December 18, 2007 are presented in Tables D6, D7, D8, D9, and D10. Results are summarized below:

- No VOCs, SVOCs, PCBs or Metals were detected in the characterization soil sample at concentrations above the Industrial Soil Cleanup Standards presented in New York State Department of Environmental Conservation (NYSDEC) Part 375.
- No TCLP VOCs were detected in the characterization soil sample.

Response

Based on the results of the characterization sample, excavation activities in connection with the Soil Gas IRM continued. Visibly-stained material were removed (where encountered) to the depth of the trench excavation proposed for the respective area. Visibly-stained material were segregated and staged adjacent to the excavation and covered for off-site transportation.

Disposal

On February 7, 2008 waste characterization samples were collected to provide the required information to prepare a profile for off-site disposal of the impacted soils. Samples indicated elevated levels of VOCs and chromium. As a result, a new profile for disposal of these soils were required due the difference in constituents identified from the original profile prepared for the site. These soils were shipped to CWM Chemical Services, Inc. Model City Landfill during on April 1 and 4, 2008 under approved Waste Profile NY296709. A summary table that quantifies the disposal volume of these soils sent to CWM Chemical Services, Inc. Model City Landfill under Waste Profile NY296709 is provided in Table D11. Copies of manifests for waste transported to CWM Chemical Services, Inc. Model City Landfill are also attached herein.

PCB Impacted Soils Discovered during Construction

In a November 16, 2007 letter from the New York State Department of Environmental Conservation (NYSDEC), the NYSDEC provided acceptance of the approach for soil management provided in the November 9, 2007 soil management plan submittal. The NYSDEC requested the uppermost interval of the post-compacted back fill materials be sampled at the rate of one sample for every 2,000 yards for SVOCs, PCBs, TAL metals and cyanide. Accordingly, soil samples were collected from a stockpile that

ARCADIS

was to be used for backfill from the zero to two feet below grade surface (bgs) and were analyzed in accordance with the November 16, 2007 letter from the NYSDEC. On January 9, 2008, a soil sample collected from the zero to two feet bgs stockpile indicated the presence of PCBs at 290 parts per million (ppm) within the stockpile approximately 510 feet west of the fence adjacent to Stewart Avenue. This stockpile had a definitive end at approximately 475 feet west of the fence adjacent to Stewart Avenue. To better define the extent of impacted soils, additional samples were collected on January 16, 2008. Samples were collected and analyzed from this stockpile at approximately 510 feet, 580 feet, 650 feet, and 720 feet west of the fence adjacent to Stewart Avenue. Analytical results indicated that no more than 110 feet of this stock pile were impacted with PCBs greater than 1 ppm. As such, 110 feet of this stockpile were identified for removal from the site as PCB impacted soils. These soils were shipped to CWM Chemical Services, Inc. Model City Landfill during the weeks of March 17 and March 24, 2008 under approved Waste Profile NY296605. A summary table that quantifies all PCB impacted soils sent to CWM Chemical Services, Inc. Model City Landfill under Waste Profile NY296605 provided in Table D1. Copies of manifests for waste transported to CWM Chemical Services, Inc. Model City Landfill is also attached. Tables D6, D7, D8, D9, and D10 summarize the laboratory analytical results for impacted soils encountered during construction.

Common Backfill

As required, common backfill and pipe bedding were imported to the site from 110 Sand Company located in Melville, New York. 110 Sand Company is a New York State Department of Transportation approved aggregate source. On February 20, 2008 a sample of the 110 Sand aggregate was submitted for analysis for VOCs, SVOCs, PCBs, Pesticides, and TAL Metals. Analytical results indicated that there were no exceedences to the industrial standards for all compounds. During the construction a total of approximately 1,086 tons of aggregate was imported to the site from 110 Sand Company. A summary of the imported material quantities from 110 Sand Company is attached to this memo in Table D12. A summary of the analytical data for common backfill is provided in Attachment D-2.

Recycled Concrete Aggregate

During construction of the soil gas IRM a substitution of RCA was made for Dense Graded Aggregate (DGA) due to the limited availability of DGA. In addition, this substitution was made to reduce cost and maintain schedule. The RCA was used in areas as indicated on the contract drawings and within the road crossing areas. The RCA was imported from South Island Industries, Inc. (South Island) of Inwood, New York. South Island is a NYSDOT approved source for Type 2 material and a New York State Department of Environmental Conservation (NYSDEC) approved recycling facility. Samples of the RCA were collected on March 10, 2008 from six locations within a stockpile identified for the soil gas IRM. Samples were analyzed for VOCs, SVOCs, PCBs, Pesticides, TAL Metals, and % moisture. Sample results indicated that there were no exceedences to the industrial standards for those analysis completed. During the construction a total of 280 cubic yards of RCA was imported to the site from South Island Industries,

ARCADIS

Inc. A summary of the imported material quantities from South Island Industries, Inc. is attached to this memo in Table D13. A summary of the analytical data for RCA is provided in Attachment D-2.

Table D1. Concentrations of Volatile Organic Compounds in Soil Samples from Soil Gas IRM Trench Area, Northrop Grumman Systems Corporation, Operable Unit 3 (Former Grumman Settling Ponds), Bethpage, New York.

Constituents mg/kg	Part 375 Industrial Use Soil Cleanup Objective	Sample ID: Sample Depth (ft bls): Sample Date:	PC-01	PC-01	PC-02	PC-02	PC-03
			0-4 9/13/2007	4-8 9/13/2007	0-4 9/13/2007	4-8 9/13/2007	0-4 9/13/2007
1,1,1-Trichloroethane	1000		< 0.0055	< 0.0053	< 0.006	< 0.0053	< 0.0055
1,1,2,2-Tetrachloroethane	--		< 0.0055	< 0.0053	< 0.006	< 0.0053	< 0.0055
1,1,2-Trichloroethane	--		< 0.0055	< 0.0053	< 0.006	< 0.0053	< 0.0055
1,1-Dichloroethane	480		< 0.0055	< 0.0053	< 0.006	< 0.0053	.0011 J
1,1-Dichloroethene	1000		< 0.0055	< 0.0053	< 0.006	< 0.0053	< 0.0055
1,2-Dichloroethane	60		< 0.0055	< 0.0053	< 0.006	< 0.0053	< 0.0055
1,2-Dichloropropane	--		< 0.0055	< 0.0053	< 0.006	< 0.0053	< 0.0055
2-Butanone	1000		< 0.055	.00082 J	< 0.06	< 0.053	< 0.055
2-Hexanone	--		< 0.055	< 0.053	< 0.06	< 0.053	< 0.055
4-Methyl-2-Pentanone	--		< 0.055	< 0.053	< 0.06	< 0.053	< 0.055
Acetone	1000		< 0.055	< 0.053	< 0.06	< 0.053	< 0.055
Benzene	89		< 0.0055	< 0.0053	< 0.006	< 0.0053	< 0.0055
Bromoform	--		< 0.0055	< 0.0053	< 0.006	< 0.0053	< 0.0055
Bromomethane	--		< 0.0055	< 0.0053	< 0.006	< 0.0053	< 0.0055
Carbon Disulfide	--		< 0.055	< 0.053	< 0.06	< 0.053	< 0.055
Carbon Tetrachloride	44		< 0.0055	< 0.0053	< 0.006	< 0.0053	< 0.0055
Chlorobenzene	1000		< 0.0055	< 0.0053	< 0.006	< 0.0053	< 0.0055
Chlorodibromomethane	--		< 0.0055	< 0.0053	< 0.006	< 0.0053	< 0.0055
Chloroethane	--		< 0.0055	< 0.0053	< 0.006	< 0.0053	< 0.0055
Chloroform	700		< 0.0055	< 0.0053	< 0.006	< 0.0053	< 0.0055
Chloromethane	--		.00033 J	< 0.0053	< 0.006	< 0.0053	< 0.0055
cis-1,2-Dichloroethene	1000		< 0.0055	< 0.0053	< 0.006	< 0.0053	0.072
cis-1,3-Dichloropropene	--		< 0.0055	< 0.0053	< 0.006	< 0.0053	< 0.0055
Ethylbenzene	780		< 0.0055	< 0.0053	< 0.006	< 0.0053	< 0.0055
Freon 12	--		< 0.0055	< 0.0053	< 0.006	< 0.0053	< 0.0055
Methylene Chloride	1000		< 0.0055	< 0.0053	< 0.006	< 0.0053	< 0.0055
Styrene	--		< 0.0055	< 0.0053	< 0.006	< 0.0053	< 0.0055
Tetrachloroethene	300		< 0.0055	< 0.0053	< 0.006	< 0.0053	< 0.0055
Toluene	1000		.00075 J	.0031 J	.0036 J	< 0.0053	.00099 J
trans-1,2-Dichloroethene	1000		< 0.0055	< 0.0053	< 0.006	< 0.0053	0.013
trans-1,3-Dichloropropene	--		< 0.0055	< 0.0053	< 0.006	< 0.0053	< 0.0055
Trichloroethene	400		< 0.0055	< 0.0053	.0018 J	< 0.0053	0.023
Vinyl Chloride	27		< 0.0055	< 0.0053	< 0.006	< 0.0053	< 0.0055
TVOC			0.00108	0.00392	0.0054	0	0.02399

See last page for notes.

ARCADIS

Table D1. Concentrations of Volatile Organic Compounds in Soil Samples from SVE IRM Trench Area, Northrop Grumman Systems Corporation, Operable Unit 3 (Former Grumman Settling Ponds), Bethpage, New York.

Constituents mg/kg	Part 375 Industrial Use Soil Cleanup Objective	Sample ID:	PC-03	PC-04	PC-04	PC-05	PC-06
		Sample Depth (ft bls): Sample Date:	4-8 9/13/2007	0-4 9/13/2007	4-8 9/13/2007	4-8 9/13/2007	4-8 9/13/2007
1,1,1-Trichloroethane	1000		< 0.0052	< 0.0056	< 0.0056	< 0.0055	< 0.0055
1,1,2,2-Tetrachloroethane	--		< 0.0052	< 0.0056	< 0.0056	< 0.0055	< 0.0055
1,1,2-Trichloroethane	--		< 0.0052	< 0.0056	< 0.0056	< 0.0055	< 0.0055
1,1-Dichloroethane	480		.00051 J	< 0.0056	< 0.0056	< 0.0055	< 0.0055
1,1-Dichloroethene	1000		< 0.0052	< 0.0056	< 0.0056	< 0.0055	< 0.0055
1,2-Dichloroethane	60		< 0.0052	< 0.0056	< 0.0056	< 0.0055	< 0.0055
1,2-Dichloropropane	--		< 0.0052	< 0.0056	< 0.0056	< 0.0055	< 0.0055
2-Butanone	1000		.0012 J	< 0.056	.0012 J	.001 J	< 0.055
2-Hexanone	--		< 0.052	< 0.056	< 0.056	< 0.055	< 0.055
4-Methyl-2-Pentanone	--		< 0.052	< 0.056	< 0.056	< 0.055	< 0.055
Acetone	1000		< 0.052	< 0.056	< 0.056	< 0.055	< 0.055
Benzene	89		< 0.0052	< 0.0056	< 0.0056	< 0.0055	< 0.0055
Bromoform	--		< 0.0052	< 0.0056	< 0.0056	< 0.0055	< 0.0055
Bromomethane	--		< 0.0052	< 0.0056	< 0.0056	< 0.0055	< 0.0055
Carbon Disulfide	--		.00033 J	< 0.056	< 0.056	< 0.055	< 0.055
Carbon Tetrachloride	44		< 0.0052	< 0.0056	< 0.0056	< 0.0055	< 0.0055
Chlorobenzene	1000		< 0.0052	< 0.0056	< 0.0056	< 0.0055	< 0.0055
Chlorodibromomethane	--		< 0.0052	< 0.0056	< 0.0056	< 0.0055	< 0.0055
Chloroethane	--		< 0.0052	< 0.0056	< 0.0056	< 0.0055	< 0.0055
Chloroform	700		< 0.0052	< 0.0056	< 0.0056 J	< 0.0055	< 0.0055
Chloromethane	--		< 0.0052	.00045 J	< 0.0056	< 0.0055	< 0.0055
cis-1,2-Dichloroethene	1000		0.047	< 0.0056	< 0.0056	.00063 J	< 0.0055
cis-1,3-Dichloropropene	--		< 0.0052	< 0.0056	< 0.0056	< 0.0055	< 0.0055
Ethylbenzene	780		.00079 J	< 0.0056	< 0.0056	< 0.0055	< 0.0055
Freon 12	--		< 0.0052	< 0.0056	< 0.0056	< 0.0055	< 0.0055
Methylene Chloride	1000		< 0.0052	< 0.0056	< 0.0056	< 0.0055	< 0.0055
Styrene	--		< 0.0052	< 0.0056	< 0.0056	< 0.0055	< 0.0055
Tetrachloroethene	300		< 0.0052	< 0.0056	< 0.0056	< 0.0055	< 0.0055
Toluene	1000		0.0054	.00035 J	< 0.0056	0.0071	.0024 J
trans-1,2-Dichloroethene	1000		0.0066	< 0.0056	< 0.0056	< 0.0055	< 0.0055
trans-1,3-Dichloropropene	--		< 0.0052	< 0.0056	< 0.0056	< 0.0055	< 0.0055
Trichloroethene	400		0.024	.00044 J	< 0.0056	.0024 J	< 0.0055
Vinyl Chloride	27		< 0.0052	< 0.0056	< 0.0056	< 0.0055	< 0.0055
			0.02683	0.00089	0.0012	0.01113	0.0024

See last page for notes.

ARCADIS

Table D1. Concentrations of Volatile Organic Compounds in Soil Samples from SVE IRM Trench Area, Northrop Grumman Systems Corporation, Operable Unit 3 (Former Grumman Settling Ponds), Bethpage, New York.

Constituents mg/kg	Part 375	Sample ID:	PC-07
	Industrial Use Soil Cleanup Objective	Sample Depth (ft bls): Sample Date:	4-8 9/13/2007
1,1,1-Trichloroethane	1000		< 0.0053
1,1,2,2-Tetrachloroethane	--		< 0.0053
1,1,2-Trichloroethane	--		< 0.0053
1,1-Dichloroethane	480		< 0.0053
1,1-Dichloroethene	1000		< 0.0053
1,2-Dichloroethane	60		< 0.0053
1,2-Dichloropropane	--		< 0.0053
2-Butanone	1000		.001 J
2-Hexanone	--		< 0.053
4-Methyl-2-Pentanone	--		< 0.053
Acetone	1000		< 0.053
Benzene	89		< 0.0053
Bromoform	--		< 0.0053
Bromomethane	--		< 0.0053
Carbon Disulfide	--		< 0.053
Carbon Tetrachloride	44		< 0.0053
Chlorobenzene	1000		< 0.0053
Chlorodibromomethane	--		< 0.0053
Chloroethane	--		< 0.0053
Chloroform	700		< 0.0053
Chloromethane	--		< 0.0053
cis-1,2-Dichloroethene	1000		< 0.0053
cis-1,3-Dichloropropene	--		< 0.0053
Ethylbenzene	780		< 0.0053
Freon 12	--		< 0.0053
Methylene Chloride	1000		< 0.0053
Styrene	--		< 0.0053
Tetrachloroethene	300		< 0.0053
Toluene	1000		< 0.0053
trans-1,2-Dichloroethene	1000		< 0.0053
trans-1,3-Dichloropropene	--		< 0.0053
Trichloroethene	400		< 0.0053
Vinyl Chloride	27		< 0.0053
			0.001

Notes:

- 1. All samples analyzed on a dry weight basis.
- ft bls feet below land surface
- IRM Interim Remedial Measure
- mg/kg milligrams per kilogram
- TVOC Total Volatile Organic Compounds
- J Value is estimated

ARCADIS

Table D2. Concentrations of Semi-Volatile Organic Compounds in Soil Samples from Soil Gas IRM Trench Area, Northrop Grumman Systems Corporation, Operable Unit 3 (Former Grumman Settling Ponds), Bethpage, New York.

Constituents mg/kg	Part 375 Industrial Use Soil Cleanup Objective	Sample ID: Sample Depth (ft bls): Sample Date:	PC-01	PC-01	PC-02	PC-02	PC-03	PC-03
			0-4 9/13/2007	4-8 9/13/2007	0-4 9/13/2007	4-8 9/13/2007	0-4 9/13/2007	4-8 9/13/2007
1,2-Benzphenanthracene	--		2.2	2	0.41	< 0.35	< 7.3	< 3.4
2,4,5-Trichlorophenol	--		< 4.5	< 4.4	< 1	< 0.87	< 18	< 8.6
2,4,6-Trichlorophenol	--		< 1.8	< 1.8	< 0.4	< 0.35	< 7.3	< 3.4
2,4-Dichlorophenol	--		< 1.8	< 1.8	< 0.4	< 0.35	< 7.3	< 3.4
2,4-Dimethylphenol	--		< 1.8	< 1.8	< 0.4	< 0.35	< 7.3	< 3.4
2,4-Dinitrophenol	--		< 4.5	< 4.4	< 1	< 0.87	< 18	< 8.6
2,4-Dinitrotoluene	--		< 1.8	< 1.8	< 0.4	< 0.35	< 7.3	< 3.4
2,6-Dinitrotoluene	--		< 1.8	< 1.8	< 0.4	< 0.35	< 7.3	< 3.4
2-Chloronaphthalene	--		< 1.8	< 1.8	< 0.4	< 0.35	< 7.3	< 3.4
2-Chlorophenol	--		< 1.8	< 1.8	< 0.4	< 0.35	< 7.3	< 3.4
2-Methylnaphthalene	--		1.6 J	2.3	< 0.4	< 0.35	< 7.3	< 3.4
2-Methylphenol	--		< 1.8	< 1.8	< 0.4	< 0.35	< 7.3	< 3.4
2-Nitroaniline	--		< 4.5	< 4.4	< 1	< 0.87	< 18	< 8.6
2-Nitrophenol	--		< 1.8	< 1.8	< 0.4	< 0.35	< 7.3	< 3.4
3,3'-Dichlorobenzidine	--		< 1.8	< 1.8	< 0.4	< 0.35	< 7.3	< 3.4
3,5,5-Trimethyl-2-Cyclohexene-1-One	--		< 1.8	< 1.8	< 0.4	< 0.35	< 7.3	< 3.4
3-Nitroaniline	--		< 4.5	< 4.4	< 1	< 0.87	< 18	< 8.6
4,6-Dinitro-2-Methylphenol	--		< 4.5	< 4.4	< 1	< 0.87	< 18	< 8.6
4-Bromophenylphenylether	--		< 1.8	< 1.8	< 0.4	< 0.35	< 7.3	< 3.4
4-Chloro-3-Methylphenol	--		< 1.8	< 1.8	< 0.4	< 0.35	< 7.3	< 3.4
4-Chlorophenylphenylether	--		< 1.8	< 1.8	< 0.4	< 0.35	< 7.3	< 3.4
4-Methylphenol	--		< 1.8	< 1.8	< 0.4	< 0.35	< 7.3	< 3.4
4-Nitrophenol	--		< 4.5	< 4.4	< 1	< 0.87	< 18	< 8.6
Acenaphthene	1000		0.33 J	0.21 J	0.066 J	< 0.35	< 7.3	< 3.4
Acenaphthylene	1000		0.8 J	1.2 J	< 0.4	< 0.35	< 7.3	< 3.4
Acetophenone	--		< 1.8	< 1.8	< 0.4	< 0.35	< 7.3	< 3.4
Anthracene	1000		1.7 J	2	0.1 J	< 0.35	< 7.3	< 3.4
Benzo(a)anthracene	11		2.2	2	0.36 J	< 0.35	< 7.3	< 3.4
Benzo(a)pyrene	1.1		1.7 J	1.7 J	0.35 J	< 0.35 J	< 7.3	< 3.4
Benzo(b)fluoranthene	11		0.83 J	0.7 J	0.35 J	< 0.35	< 7.3	< 3.4
Benzo(g,h,i)perylene	1000		0.99 J	1 J	0.24 J	< 0.35	< 7.3	< 3.4
Benzo(k)fluoranthene	110		1.2 J	1.1 J	0.33 J	< 0.35	< 7.3	< 3.4
Benzyl butyl phthalate	--		< 1.8	< 1.8	< 0.4	< 0.35	< 7.3	< 3.4
Bis(2-chloroethoxy)methane	--		< 1.8	< 1.8	< 0.4	< 0.35	< 7.3	< 3.4
Bis(2-chloroethyl)ether	--		< 1.8	< 1.8	< 0.4	< 0.35	< 7.3	< 3.4
Bis(2-chloroisopropyl)ether	--		< 1.8	< 1.8	< 0.4	< 0.35	< 7.3	< 3.4
Bis(2-ethylhexyl)phthalate	--		< 1.8	< 1.8	< 0.4	0.13 J	< 7.3	< 3.4
Dibezo(a,h)anthracene	1.1		0.32 J	0.32 J	0.079 J	< 0.35	< 7.3	< 3.4
Dibenzofuran	--		0.21 J	0.19 J	0.023 J	< 0.35	< 7.3	< 3.4
Diethylphthalate	--		< 1.8	< 1.8	< 0.4	< 0.35	< 7.3	< 3.4
Dimethylphthalate	--		< 1.8	< 1.8	< 0.4	< 0.35	< 7.3	< 3.4
Di-n-butylphthalate	--		< 1.8	< 1.8	< 0.4	< 0.35	< 7.3	< 3.4
Di-n-Octylphthalate	--		< 1.8	< 1.8	< 0.4	< 0.35	< 7.3	< 3.4
Fluoranthene	1000		3.6	3.1	1	< 0.35	< 7.3	< 3.4
Fluorene	1000		1.7 J	2.2	0.056 J	< 0.35	< 7.3	< 3.4
Hexachloro-1,3-Butadiene	--		< 1.8	< 1.8	< 0.4	< 0.35	< 7.3	< 3.4
Hexachlorobenzene	--		< 1.8	< 1.8	< 0.4	< 0.35	< 7.3	< 3.4
Hexachlorocyclopentadiene	--		< 1.8	< 1.8	< 0.4	< 0.35	< 7.3	< 3.4
Hexachloroethane	--		< 1.8	< 1.8	< 0.4	< 0.35	< 7.3	< 3.4
Indeno(1,2,3-CD)Pyrene	11		0.86 J	0.85 J	0.23 J	< 0.35	< 7.3	< 3.4
Naphthalene	1000		1.3 J	2	< 0.4	< 0.35	0.17 J	< 3.4
Nitrobenzene	--		< 1.8	< 1.8	< 0.4	< 0.35	< 7.3	< 3.4
n-Nitrosodi-n-propylamine	--		< 1.8	< 1.8	< 0.4	< 0.35	< 7.3	< 3.4
n-Nitrosodiphenylamine	--		< 1.8	< 1.8	< 0.4	< 0.35	< 7.3	< 3.4

Footnotes on next page.

ARCADIS

Table D2. Concentrations of Semi-Volatile Organic Compounds in Soil Samples from Soil Gas IRM Trench Area, Northrop Grumman Systems Corporation, Operable Unit 3 (Former Grumman Settling Ponds), Bethpage, New York.

Constituents mg/kg	Part 375 Industrial Use Soil Cleanup Objective	Sample ID: Sample Depth (ft bls): Sample Date:	PC-01	PC-01	PC-02	PC-02	PC-03	PC-03
			0-4 9/13/2007	4-8 9/13/2007	0-4 9/13/2007	4-8 9/13/2007	0-4 9/13/2007	4-8 9/13/2007
4-Chloroaniline	--		< 1.8	< 1.8	< 0.4	< 0.35	< 7.3	< 3.4
Pentachlorophenol	55		< 4.5	< 4.4	< 1	< 0.87	< 18	< 8.6
Phenanthrene	1000		7.4	8.1	0.71	< 0.35	0.35 J	0.2 J
Phenol	1000		< 1.8	< 1.8	< 0.4	< 0.35	< 7.3	< 3.4
4-Nitroaniline	--		< 4.5	< 4.4	< 1	< 0.87	< 18	< 8.6
Pyrene	1000		4.6	4.3	0.77	< 0.35	< 7.3	< 3.4
TSVOC			33.54	35.27	5.074	0.13	0.52	0.2

Notes:

- 1. All samples analyzed on a dry weight basis.
- ft bls feet below land surface
- IRM Interim Remedial Measure
- mg/kg milligrams per kilogram
- TSVOC Total semi-volatile organic compound
- J Value is estimated

ARCADIS

Table D2. Concentrations of Semi-Volatile Organic Compounds in Soil Samples from Soil Gas IRM Trench Area, Northrop Grumman Systems Corporation, Operable Unit 3 (Former Grumman Settling Ponds), Bethpage, New York.

Constituents mg/kg	Part 375 Industrial Use Soil Cleanup Objective	Sample ID:	PC-04	PC-04	PC-05	PC-06	PC-07
		Sample Depth (ft bls): Sample Date:	0-4 9/13/2007	4-8 9/13/2007	4-8 9/13/2007	4-8 9/13/2007	4-8 9/13/2007
1,2-Benzphenanthracene	--		0.049 J	0.033 J	0.034 J	< 0.36	< 0.35
2,4,5-Trichlorophenol	--		< 0.93	< 0.93	< 0.92	< 0.92	< 0.88
2,4,6-Trichlorophenol	--		< 0.37	< 0.37	< 0.37	< 0.36	< 0.35
2,4-Dichlorophenol	--		< 0.37	< 0.37	< 0.37	< 0.36	< 0.35
2,4-Dimethylphenol	--		< 0.37	< 0.37	< 0.37	< 0.36	< 0.35
2,4-Dinitrophenol	--		< 0.93	< 0.93	< 0.92	< 0.92	< 0.88
2,4-Dinitrotoluene	--		< 0.37	< 0.37	< 0.37	< 0.36	< 0.35
2,6-Dinitrotoluene	--		< 0.37	< 0.37	< 0.37	< 0.36	< 0.35
2-Chloronaphthalene	--		< 0.37	< 0.37	< 0.37	< 0.36	< 0.35
2-Chlorophenol	--		< 0.37	< 0.37	< 0.37	< 0.36	< 0.35
2-Methylnaphthalene	--		< 0.37	< 0.37	< 0.37	< 0.36	< 0.35
2-Methylphenol	--		< 0.37	< 0.37	< 0.37	< 0.36	< 0.35
2-Nitroaniline	--		< 0.93	< 0.93	< 0.92	< 0.92	< 0.88
2-Nitrophenol	--		< 0.37	< 0.37	< 0.37	< 0.36	< 0.35
3,3'-Dichlorobenzidine	--		< 0.37	< 0.37	< 0.37	< 0.36	< 0.35
3,5,5-Trimethyl-2-Cyclohexene-1-One	--		< 0.37	< 0.37	< 0.37	< 0.36	< 0.35
3-Nitroaniline	--		< 0.93	< 0.93	< 0.92	< 0.92	< 0.88
4,6-Dinitro-2-Methylphenol	--		< 0.93	< 0.93	< 0.92	< 0.92	< 0.88
4-Bromophenylphenylether	--		< 0.37	< 0.37	< 0.37	< 0.36	< 0.35
4-Chloro-3-Methylphenol	--		< 0.37	< 0.37	< 0.37	< 0.36	< 0.35
4-Chlorophenylphenylether	--		< 0.37	< 0.37	< 0.37	< 0.36	< 0.35
4-Methylphenol	--		< 0.37	< 0.37	< 0.37	< 0.36	< 0.35
4-Nitrophenol	--		< 0.93	< 0.93	< 0.92	< 0.92	< 0.88
Acenaphthene	1000		< 0.37	< 0.37	< 0.37	< 0.36	< 0.35
Acenaphthylene	1000		< 0.37	< 0.37	< 0.37	< 0.36	< 0.35
Acetophenone	--		< 0.37	< 0.37	< 0.37	< 0.36	< 0.35
Anthracene	1000		< 0.37	< 0.37	< 0.37	< 0.36	< 0.35
Benzo(a)anthracene	11		< 0.37 J	< 0.37 J	< 0.37 J	< 0.36	< 0.35
Benzo(a)pyrene	1.1		< 0.37 J	< 0.37 J	< 0.37 J	< 0.36	< 0.35
Benzo(b)fluoranthene	11		< 0.37	< 0.37	< 0.37	< 0.36	< 0.35
Benzo(g,h,i)perylene	1000		0.11 J	0.08 J	0.064 J	< 0.36	< 0.35
Benzo(k)fluoranthene	110		< 0.37	< 0.37	< 0.37	< 0.36	< 0.35
Benzyl butyl phthalate	--		< 0.37	< 0.37	< 0.37	< 0.36	< 0.35
Bis(2-chloroethoxy)methane	--		< 0.37	< 0.37	< 0.37	< 0.36	< 0.35
Bis(2-chloroethyl)ether	--		< 0.37	< 0.37	< 0.37	< 0.36	< 0.35
Bis(2-chloroisopropyl)ether	--		< 0.37	< 0.37	< 0.37	< 0.36	< 0.35
Bis(2-ethylhexyl)phthalate	--		0.18 J	0.22 J	0.22 J	0.058 J	< 0.35
Dibenzo(a,h)anthracene	1.1		0.073 J	0.062 J	0.047 J	< 0.36	< 0.35
Dibenzofuran	--		< 0.37	< 0.37	< 0.37	< 0.36	< 0.35
Diethylphthalate	--		< 0.37	< 0.37	< 0.37	< 0.36	< 0.35
Dimethylphthalate	--		< 0.37	< 0.37	< 0.37	< 0.36	< 0.35
Di-n-butylphthalate	--		< 0.37	< 0.37	< 0.37	< 0.36	< 0.35
Di-n-Octylphthalate	--		< 0.37	< 0.37	< 0.37	< 0.36	< 0.35
Fluoranthene	1000		0.092 J	< 0.37	< 0.37	< 0.36	< 0.35
Fluorene	1000		< 0.37	< 0.37	< 0.37	< 0.36	< 0.35
Hexachloro-1,3-Butadiene	--		< 0.37	< 0.37	< 0.37	< 0.36	< 0.35
Hexachlorobenzene	--		< 0.37	< 0.37	< 0.37	< 0.36	< 0.35
Hexachlorocyclopentadiene	--		< 0.37	< 0.37	< 0.37	< 0.36	< 0.35
Hexachloroethane	--		< 0.37	< 0.37	< 0.37	< 0.36	< 0.35
Indeno(1,2,3-CD)Pyrene	11		0.094 J	0.069 J	0.056 J	< 0.36	< 0.35
Naphthalene	1000		< 0.37	< 0.37	< 0.37	< 0.36	< 0.35
Nitrobenzene	--		< 0.37	< 0.37	< 0.37	< 0.36	< 0.35
n-Nitrosodi-n-propylamine	--		< 0.37	< 0.37	< 0.37	< 0.36	< 0.35
n-Nitrosodiphenylamine	--		< 0.37	< 0.37	< 0.37	< 0.36	< 0.35

Footnotes on next page.

ARCADIS

Table D2. Concentrations of Semi-Volatile Organic Compounds in Soil Samples from Soil Gas IRM Trench Area, Northrop Grumman Systems Corporation, Operable Unit 3 (Former Grumman Settling Ponds), Bethpage, New York.

Constituents mg/kg	Part 375 Industrial Use Soil Cleanup Objective	Sample ID:	PC-04	PC-04	PC-05	PC-06	PC-07
		ample Depth (ft bls): Sample Date:	0-4 9/13/2007	4-8 9/13/2007	4-8 9/13/2007	4-8 9/13/2007	4-8 9/13/2007
4-Chloroaniline	--		< 0.37	< 0.37	< 0.37	< 0.36	< 0.35
Pentachlorophenol	55		< 0.93	< 0.93	< 0.92	< 0.92	< 0.88
Phenanthrene	1000		0.053 J	0.024 J	0.025 J	0.015 J	< 0.35
Phenol	1000		< 0.37	< 0.37	< 0.37	< 0.36	< 0.35
4-Nitroaniline	--		< 0.93	< 0.93	< 0.92	< 0.92	< 0.88
Pyrene	1000		< 0.37	< 0.37	< 0.37	< 0.36	< 0.35
TSVOC			0.651	0.488	0.446	0.073	0

Notes:

- 1. All samples analyzed on a dry weight basis.
- ft bls feet below land surface
- IRM Interim Remedial Measure
- mg/kg milligrams per kilogram
- TSVOC Total semi-volatile organic compound
- J Value is estimated

ARCADIS

Table D3. Concentrations of Total and TCLP Chromium in Soil Samples from Soil Gas IRM Trench Area, Northrop Grumman Systems Corporation, Operable Unit 3 (Former Grumman Settling Ponds), Bethpage, New York.

Constituents	Part 375	RCRA	Sample ID:	PC-01	PC-01	PC-02	PC-02	PC-03	PC-03	PC-04	PC-04	PC-05	PC-06	PC-07
	Industrial Use Soil Cleanup Objective	Haz. Waste Criterion	Sample Depth (ft bls): Sample Date:	0-4 9/13/2007	4-8 9/13/2007	0-4 9/13/2007	4-8 9/13/2007	0-4 9/13/2007	4-8 9/13/2007	0-4 9/13/2007	4-8 9/13/2007	4-8 9/13/2007	4-8 9/13/2007	4-8 9/13/2007
Chromium, total, in mg/kg	6800	--		12.9 J	6.9 J	20.1 J	4.4 J	22.1 J	6.1 J	27.3 J	25.4 J	249 J	9.5 J	12.7 J
Chromium, TCLP, in mg/L	--	5		--	--	--	--	--	--	--	--	< 0.1	--	--

Notes:

- 1. All samples analyzed on a dry weight basis.
- ft bls feet below land surface
- IRM Interim Remedial Measure
- mg/kg milligrams per kilogram
- mg/L milligrams per liter
- TCLP Toxicity Characteristic Leaching Procedure
- J Value is estimated
- Not Analyzed
- RCRA Resource Conservation and Recovery Act

ARCADIS

Table D4. Concentrations of Polychlorinated Biphenyls in Soil Samples from Soil Gas IRM Trench Area, Northrop Grumman Systems Corporation, Operable Unit 3 (Former Grumman Settling Ponds), Bethpage, New York.

Constituents mg/kg	TSCA Criterion (1)	Part 375 Industrial Use Soil Cleanup Objective (1)	Sample ID: Sample Depth (ft bls): Sample Date:	PC-01	PC-01	PC-03	PC-03	PC-03	PC-03	PC-3-1	PC-3-1	PC-3-1	PC-3-1
				0-4 9/13/2007	4-8 9/13/2007	0-4 9/13/2007	4-8 9/13/2007	8-10 10/24/2007	10-12 10/24/2007	0-4 10/24/2007	4-8 10/24/2007	8-10 10/24/2007	10-12 10/24/2007
Aroclor-1016	50	25		< 0.36	< 0.035	< 360	< 34	<3.7	< 0.035	<0.75	< 0.35	< 0.35	< 0.034
Aroclor-1221	50	25		< 0.73	< 0.071	< 740	< 69	<7.5	< 0.070	<1.5	< 0.71	< 0.70	< 0.070
Aroclor-1232	50	25		< 0.36	< 0.035	< 360	< 34	<3.7	< 0.035	<0.75	< 0.35	< 0.35	< 0.034
Aroclor-1242	50	25		< 0.36	< 0.035	1500	280	17	0.29	<0.75	< 0.35	< 0.35	< 0.034
Aroclor-1248	50	25		2	< 0.035	< 360	< 34	<3.7	< 0.035	5.4	3.3	2.1	< 0.034
Aroclor-1254	50	25		< 0.36	< 0.035	< 360	< 34	<3.7	< 0.035	<0.75	< 0.35	< 0.35	< 0.034
Aroclor-1260	50	25		< 0.36	< 0.035	< 360	< 34	<3.7	< 0.035	<0.75	< 0.35	< 0.35	< 0.034

Constituents mg/kg	TSCA Criterion (1)	Part 375 Industrial Use Soil Cleanup Objective (1)	Sample ID: Sample Depth (ft bls): Sample Date:	PC-3-2	PC-3-2	PC-3-2	PC-3-2	PC-3-3	PC-3-3	PC-3-3	PC-3-3	PC-3-4	PC-3-4
				0-4 10/24/2007	4-8 10/24/2007	8-10 10/24/2007	10-12 10/24/2007	0-4 10/24/2007	4-8 10/24/2007	8-10 10/24/2007	10-12 10/24/2007	0-4 10/24/2007	4-8 10/24/2007
Aroclor-1016	50	25		< 38	< 0.034	< 35	< 0.034	< 3.9	<0.033	<0.34	< 0.034	< 3.9	<0.17
Aroclor-1221	50	25		< 77	< 0.069	< 72	< 0.068	< 7.9	<0.068	<0.70	< 0.069	< 7.9	<0.35
Aroclor-1232	50	25		< 38	< 0.034	< 35	< 0.034	< 3.9	<0.033	<0.34	< 0.034	< 3.9	<0.17
Aroclor-1242	50	25		200	120	220	< 0.034	< 3.9	<0.033	<0.34	< 0.034	< 3.9	<0.17
Aroclor-1248	50	25		< 38	< 0.034	< 35	< 0.034	23	0.065	3.3	< 0.034	17	0.78
Aroclor-1254	50	25		< 38	< 0.034	< 35	< 0.034	< 3.9	<0.033	<0.34	< 0.034	< 3.9	<0.17
Aroclor-1260	50	25		< 38	< 0.034	< 35	< 0.034	< 3.9	<0.033	<0.34	< 0.034	< 3.9	<0.17

See last page for notes.

Table D4. Concentrations of Polychlorinated Biphenyls in Soil Samples from Soil Gas IRM Trench Area, Northrop Grumman Systems Corporation, Operable Unit 3 (Former Grumman Settling Ponds), Bethpage, New York.

Constituents mg/kg	TSCA Criterion (1)	Part 375 Industrial Use Soil Cleanup Objective (1)	Sample ID:	PC-3-4	PC-3-4	PC-3-5	PC-3-5	PC-3-5	PC-3-5	PC-3-6	PC-3-6	PC-3-6	PC-3-6
			Sample Depth (ft bls):	8-10	10-12	0-4	4-8	8-10	10-12	0-4	4-8	8-10	10-12
			Sample Date:	10/24/2007	10/24/2007	10/24/2007	10/24/2007	10/24/2007	10/24/2007	10/24/2007	10/24/2007	10/24/2007	10/24/2007
Aroclor-1016	50	25		< 0.36	<0.034	<2	<0.034	<0.034	< 0.035	< 3.9	<0.038	< 0.035	<0.038
Aroclor-1221	50	25		< 0.73	<0.069	<4	<0.069	<0.069	< 0.071	< 7.9	<0.077	< 0.071	<0.077
Aroclor-1232	50	25		< 0.36	<0.034	<2	<0.034	<0.034	< 0.035	< 3.9	<0.038	< 0.035	<0.038
Aroclor-1242	50	25		< 0.36	<0.034	<2	<0.034	<0.034	< 0.035	< 3.9	<0.038	< 0.035	<0.038
Aroclor-1248	50	25		3.4	<0.034	10	0.06	<0.034	0.2	19	<0.038	0.33	<0.038
Aroclor-1254	50	25		< 0.36	<0.034	<2	<0.034	<0.034	< 0.035	< 3.9	<0.038	< 0.035	<0.038
Aroclor-1260	50	25		< 0.36	<0.034	<2	<0.034	<0.034	< 0.035	< 3.9	<0.038	< 0.035	<0.038

Constituents mg/kg	TSCA Criterion (1)	Part 375 Industrial Use Soil Cleanup Objective (1)	Sample ID:	PC-3-7	PC-3-7	PC-3-7	PC-3-7	PC-3-8	PC-3-8	PC-3-8	PC-3-8
			Sample Depth (ft bls):	0-4	4-8	8-10	10-12	0-4	4-8	8-10	10-12
			Sample Date:	10/24/2007	10/24/2007	10/24/2007	10/24/2007	10/24/2007	10/24/2007	10/24/2007	10/24/2007
Aroclor-1016	50	25		<0.039	< 0.036	<0.18	<0.034	<0.19	<0.076	<0.034	<0.034
Aroclor-1221	50	25		<0.079	< 0.074	<0.36	<0.069	<0.39	<0.15	<0.07	<0.07
Aroclor-1232	50	25		<0.039	< 0.036	<0.18	<0.034	<0.19	<0.076	<0.034	<0.034
Aroclor-1242	50	25		<0.039	< 0.036	<0.18	<0.034	<0.19	<0.076	<0.034	<0.034
Aroclor-1248	50	25		0.33	0.21	0.71	<0.034	1.2	0.67	0.23	<0.034
Aroclor-1254	50	25		<0.039	< 0.036	<0.18	<0.034	<0.19	<0.076	<0.034	<0.034
Aroclor-1260	50	25		<0.039	< 0.036	<0.18	<0.034	<0.19	<0.076	<0.034	<0.034

Notes:

1. Criterion/objective applies to total PCBs.
2. All samples analyzed on a dry weight basis.

ft bls feet below land surface
 IRM Interim Remedial Measure
 mg/kg milligrams per kilogram
 PCB polychlorinated biphenyls
 TSCA Toxic Substances Control Act

ARCADIS

Table D-5. Transportation and Disposal Summary of PCB Containing Soils Profile NY296605, Operable Unit 3, Soil Gas IRM, Former Grumman Settling Ponds, Bethpage, New York.

Date	Manifest Tracking Number	Transport Tickets #	Pounds	Tons
12/26/2007	000364561 GBF	158469	70380	35.19
12/26/2007	000364554 GBF	158472	70340	35.17
12/26/2007	000364558 GBF	158477	52520	26.26
12/26/2007	00036559 GBF	158478	68320	34.16
12/26/2007	000364560 GBF	158479	59740	29.87
12/26/2007	000364557 GBF	158480	74820	37.41
12/26/2007	000364555 GBF	158485	69660	34.83
12/26/2007	000364556 GBF	158488	70420	35.21
12/27/2007	000364562 GBF	158500	64700	32.35
12/27/2007	000364563 GBF	158545	70640	35.32
12/28/2007	000364566 GBF	158549	64920	32.46
12/28/2007	000364570 GBF	158584	69820	34.91
12/28/2007	000364565 GBF	158586	68020	34.01
12/28/2007	000364568 GBF	158597	70420	35.21
12/28/2007	000364567 GBF	158598	69280	34.64
12/28/2007	000364569 GBF	158603	73100	36.55
1/3/2008	000364573 GBF	158715	62600	31.3
1/3/2008	000364574 GBF	158716	69360	34.68
1/3/2008	000364571 GBF	158717	74740	37.37
1/3/2008	000364572 GBF	158756	69240	34.62
1/4/2008	000364577 GBF	158808	68380	34.19
1/4/2008	000364578 GBF	158810	65440	32.72
3/19/2008	000364581 GBF	160890	68940	34.47
3/19/2008	000364582 GBF	160901	59200	29.6
3/19/2008	000364580 GBF	160904	80460	40.23
3/19/2008	000364579 GBF	160909	77560	38.78
3/20/2008	000364584 GBF	160922	71820	35.91
3/20/2008	000364587 GBF	160932	60940	30.47
3/20/2008	000364583 GBF	160959	70480	35.24
3/20/2008	000364585 GBF	160967	75140	37.57
3/24/2008	000364589 GBF	160948	69800	34.9
3/24/2008	000364590 GBF	160957	75900	37.95
3/24/2008	000364591 GBF	160958	71620	35.81
3/24/2008	000364592 GBF	160961	66440	33.22
3/26/2008	000364593 GBF	160994	75840	37.92
3/26/2008	000364594 GBF	160997	68260	34.13
4/1/2008	000364596 GBF	161056	65100	32.55
4/1/2008	000364595 GBF	161060	69940	34.97
4/4/2008	000364598 GBF	161103	71320	35.66
4/4/2008	000364597 GBF	161217	49480	24.74
TOTAL TONNAGE				1,372.55

ARCADIS

Table D6. Concentrations of VOCs in Soil from Soil Pile Samples, Northrop Grumman Systems Corporation Operable Unit 3 Former Grumman Settling Ponds, Bethpage, New York.

CONSTITUENT ug/kg	Sample Location:		WLT-ST	WL-TB	WLT-ST (2)
	Sample Date:		12/18/2007	1/29/2008	2/7/2008
	<u>NYSDEC Part 375</u>				
<u>VOCs</u>	<u>Industrial</u>	<u>RCRA</u>			
1,1,1-Trichloroethane	1,000,000	NE	< 2800	<5.3	<5
1,1,2,2-Tetrachloroethane	NE	NE	< 2800	<5.3	<5
1,1,2-Trichloroethane	NE	NE	< 2800	<5.3	<5
1,1-Dichloroethane	480,000	NE	< 2800	<5.3	<5
1,1-Dichloroethene	1,000,000	700	< 2800	<5.3	<5
1,2-Dichloroethane	60,000	500	< 2800	<5.3	<5
1,2-Dichloropropane	NE	NE	< 2800	<5.3	<5
2-Butanone	1,000,000	NE	< 28000	<11	<10
2-Hexanone	NE	NE	< 28000	<11	<10
4-Methyl-2-pentanone	NE	NE	< 28000	<11	<10
Acetone	1,000,000	NE	< 28000	<21	<20
Benzene	89,000	500	< 2800	<5.3	<5
Bromodichloromethane	NE	NE	< 2800	<5.3	<5
Bromoform	NE	NE	< 2800	<5.3	<5
Bromomethane	NE	NE	< 2800	<5.3	<5
Carbon disulfide	NE	NE	< 28000	<11	<10
Carbon tetrachloride	44,000	NE	< 2800	<5.3	<5
Chlorobenzene	1,000,000	100,000	< 2800	<5.3	<5
Chloroethane	NE	NE	< 2800	<5.3	<5
Chloroform	700,000	6,000	< 2800	<5.3	<5
Chloromethane	NE	NE	< 2800	<5.3	<5
cis-1,2-Dichloroethene	1,000,000	NE	< 2800	<5.3	<5
cis-1,3-Dichloropropene	NE	NE	< 2800	<5.3	<5
Dibromochloromethane	NE	NE	< 2800	<5.3	<5
Dichlorodifluoromethane (Freon 12)	NE	NE	< 2800	<5.3	<5
Ethylbenzene	780,000	NE	6,600	<5.3	18,000
Freon 113	NE	NE	< 2800	<5.3	<5
Methylene chloride	1,000,000	NE	< 2800	<5.3	<5
Styrene	NE	NE	< 2800	<5.3	<5
Tetrachloroethene	300,000	700	< 2800	<5.3	<5
Toluene	1,000,000	NE	160,000	E 37	52,000
trans-1,2-Dichloroethene	1,000,000	NE	< 2800	<5.3	<5
trans-1,3-Dichloropropene	NE	NE	< 2800	<5.3	<5
Trichloroethene	400,000	500	390	J <5.3	<5
Vinyl Chloride	27,000	200	< 2800	<5.3	<5
Xylene-O	1,000,000	NE	7,300	<5.3	47,000
Xylene-M&P	1,000,000	NE	23,000	<5.3	83,000
TVOC			197,290	37.0	200,000

Notes and Abbreviations:

Bold value indicates a detection

[Redacted] Result exceeds NYSDEC Part 375 Industrial Soil Cleanup Standards

[Redacted] Result exceeds 40 CFR Part 261 Toxicity Characteristics Concentrations

NYSDEC New York State Department of Environmental Conservation

ug/kg milligrams per kilogram

NE Not Established

ARCADIS

Table D7. Concentrations of VOCs from TCLP Analysis in Soil from Soil Pile Samples, Northrop Grumman Systems Corporation, Operable Unit 3 (Former Grumman Settling Ponds), Bethpage, New York.

CONSTITUENT	Sample Location: Sample Date:	WLT-ST 12/18/2007	WLT-ST 12/18/2007	WLT-ST(2) 2/7/2008
ug/kg				
VOCs				
1,1-Dichloroethene		< 50	< 50	--
1,2-Dichloroethane		< 50	< 50	--
2-Butanone		< 100	< 100	--
Benzene		< 50	< 50	--
Carbon tetrachloride		< 50	< 50	--
Chlorobenzene		< 50	< 50	--
Tetrachloroethene		< 50	< 50	--
Trichloroethene		< 50	< 50	--
Vinyl Chloride		< 50	< 50	--

Notes and Abbreviations:

ug/kg milligrams per kilogram

ARCADIS

Table D8. Concentrations of SVOCs in Soil from Soil Pile Samples, Northrop Grumman Systems Corporation, Operable Unit 3 (Former Grumman Settling Ponds), Bethpage, New York.

CONSTITUENT ug/kg	Sample Location:		WLT-ST	MFT	WLT-1	WLT-ST
	Sample Date:		12/18/2007	12/6/2007 0-2	12/14/2007 0-2	12/18/2007
	<u>NYSDEC Part 375</u>					
		<u>Industrial</u>	<u>RCRA</u>			
2,4,5-Trichlorophenol		NE	400,000	< 370	< 370	< 370
2,4,6-Trichlorophenol		NE	2,000	< 370	< 370	< 370
2,4-Dichlorophenol		NE	NE	< 370	< 370	< 370
2,4-Dimethylphenol		NE	NE	< 370	< 370	< 370
2,4-Dinitrophenol		NE	NE	< 370	<1900	<1900
2,4-Dinitrotoluene		NE	130	<1900	< 370	< 370
2,6-Dinitrotoluene		NE	NE	< 370	< 370	< 370
2-Chloronaphthalene		NE	NE	< 370	< 370	< 370
2-Chlorophenol		NE	NE	< 370	< 370	< 370
2-Methylnaphthalene		NE	NE	180	< 370	28
2-Methylphenol		NE	NE	< 370	< 370	< 370
2-Nitroaniline		NE	NE	<1900	<1900	<1900
2-Nitrophenol		NE	NE	< 370	< 370	< 370
3,3-Dichlorobenzidine		NE	NE	< 370	< 370	< 370
3-Nitroaniline		NE	NE	<1900	<1900	<1900
4,6-Dinitro-2-methylphenol		NE	NE	<1900	<1900	<1900
4-Bromophenyl phenyl ether		NE	NE	< 370	< 370	< 370
4-Nitroaniline		NE	NE	<1900	<1900	<1900
4-Nitrophenol		NE	NE	<1900	<1900	<1900
4-Chlorophenyl phenyl ether		NE	NE	< 370	< 370	< 370
4-Chloroaniline		NE	NE	< 370	< 370	< 370
4-Chloro-3-methylphenol		NE	NE	< 370	< 370	< 370
4-Methylphenol		NE	NE	< 370	< 370	< 370
Acenaphthene	1,000,000	NE	NE	27	28	27
Acenaphthylene	1,000,000	NE	NE	< 370	< 370	< 370
Acetophenone		NE	NE	930	< 370	930
Anthracene	1,000,000	NE	NE	43	60	43
Atrazine		NE	NE	< 370	< 370	< 370
Benzaldehyde		NE	NE	< 370	< 370	< 370
Benzo(a)anthracene	11,000	NE	NE	180	150	40
Benzo(a)pyrene	1,100	NE	NE	180	140	44
Benzo(b)fluoranthene	11,000	NE	NE	220	110	43
Benzo(ghi)perylene	1,000,000	NE	NE	160	86	39
Benzo(k)fluoranthene	110,000	NE	NE	190	120	39
Biphenyl		NE	NE	< 370	< 370	< 370
Bis(2-chloro-1-methylethyl) ether		NE	NE	< 370	< 370	< 370
Bis(2-chloroethoxy)methane		NE	NE	< 370	< 370	< 370
Bis(2-chloroethyl)ether		NE	NE	< 370	< 370	< 370
Bis(2-ethylhexyl)phthalate (BEHP)		NE	NE	< 370	27	< 370
Butyl benzyl phthalate		NE	NE	< 370	< 370	< 370
Caprolactam		NE	NE	< 370	< 370	< 370
Carbazole		NE	NE	< 370	32	< 370
Chrysene	110,000	NE	NE	250	150	50
Dibenzo(a,h)anthracene	1,100	NE	NE	39	32	< 370
Dibenzofuran		NE	NE	37	< 370	< 370
Diethyl phthalate		NE	NE	< 370	< 370	< 370
Dimethyl phthalate		NE	NE	< 370	< 370	< 370
Di-n-butyl phthalate		NE	NE	230	< 370	< 370
Di-n-octyl phthalate		NE	NE	< 370	< 370	< 370
Fluoranthene	1,000,000	NE	NE	480	370	81
Fluorene	1,000,000	NE	NE	25	< 370	25
Hexachlorobenzene		NE	130	< 370	< 370	< 370
Hexachlorobutadiene		NE	500	< 370	< 370	< 370
Hexachlorocyclopentadiene		NE	NE	< 370	< 370	< 370
Hexachloroethane		NE	3,000	< 370	< 370	< 370
Indeno(1,2,3-cd)pyrene	11,000	NE	NE	150	83	27

Footnotes on next page.

ARCADIS

Table D8. Concentrations of SVOCs in Soil from Soil Pile Samples, Northrop Grumman Systems Corporation, Operable Unit 3 (Former Grumman Settling Ponds), Bethpage, New York.

CONSTITUENT ug/kg	Sample Location: WLT-ST		MFT	WLT-1	WLT-ST
	Sample Date: 12/18/2007		12/6/2007 0-2	12/14/2007 0-2	12/18/2007
SVOCs	NYSDEC Part 375		RCRA		
Isophorone	NE	NE	< 370	< 370	< 370
Naphthalene	1,000,000	NE	180 J	< 370	< 370 180 J
Nitrobenzene	NE	2,000	< 370	< 370	< 370
N-Nitrosodiphenylamine	NE	NE	< 370	< 370	< 370
N-Nitrosodipropylamine	NE	NE	< 370	< 370	< 370
Pentachlorophenol	55,000	100,000	< 1900	< 1900	< 1900
Phenanthrene	1,000,000	NE	280 J	250 J	59 J 280 J
Phenol	1,000,000	NE	< 370	< 370	< 370
Pyrene	1,000,000	NE	320 J	260 J	58 J 320 J

Notes and Abbreviations:

Bold value indicates a detection

- Result exceeds NYSDEC Part 375 Industrial Soil Cleanup Standards
- Result exceeds 40 CFR Part 261 Toxicity Characteristics Concentrations
- NYSDEC New York State Department of Environmental Conservation
- ug/kg milligrams per kilogram
- NE Not Established

ARCADIS

Table D8. Concentrations of SVOCs in Soil from Soil Pile Samples, Northrop Grumman Systems Corporation, Operable Unit 3 (Former Grumman Settling Ponds), Bethpage, New York.

CONSTITUENT ug/kg	Sample Location:		EWLT-E	EWLT-C	EWLT-W	WLT-ST
	Sample Date:		1/9/2008	1/9/2008	1/9/2008	2/7/2008
	<u>NYSDEC Part 375</u>					
SVOCs	Industrial	RCRA				
2,4,5-Trichlorophenol	NE	400,000	< 360	< 370	< 360	<1500
2,4,6-Trichlorophenol	NE	2,000	< 360	< 370	< 360	<1500
2,4-Dichlorophenol	NE	NE	< 360	< 370	< 360	<1500
2,4-Dimethylphenol	NE	NE	< 360	< 370	< 360	<1500
2,4-Dinitrophenol	NE	NE	<1800	<1900	<1900	<7700
2,4-Dinitrotoluene	NE	130	< 360	< 370	< 360	<1500
2,6-Dinitrotoluene	NE	NE	< 360	< 370	< 360	<1500
2-Chloronaphthalene	NE	NE	< 360	< 370	< 360	<1500
2-Chlorophenol	NE	NE	< 360	< 370	< 360	<1500
2-Methylnaphthalene	NE	NE	< 360	< 370	< 360	<1500
2-Methylphenol	NE	NE	< 360	< 370	< 360	<1500
2-Nitroaniline	NE	NE	< 1800	<1900	<1900	<7700
2-Nitrophenol	NE	NE	< 360	< 370	< 360	<1500
3,3-Dichlorobenzidine	NE	NE	< 360	< 370	< 360	<1500
3-Nitroaniline	NE	NE	< 1800	<1900	<1900	<7700
4,6-Dinitro-2-methylphenol	NE	NE	< 1800	<1900	<1900	<7700
4-Bromophenyl phenyl ether	NE	NE	< 360	< 370	< 360	<1500
4-Nitroaniline	NE	NE	< 1800	<1900	<1900	<7700
4-Nitrophenol	NE	NE	< 1800	<1900	<1900	<7700
4-Chlorophenyl phenyl ether	NE	NE	< 360	< 370	< 360	<1500
4-Chloroaniline	NE	NE	< 360	< 370	< 360	<1500
4-Chloro-3-methylphenol	NE	NE	< 360	< 370	< 360	<1500
4-Methylphenol	NE	NE	< 360	< 370	< 360	<1500
Acenaphthene	1,000,000	NE	< 360	< 370	< 360	<1500
Acenaphthylene	1,000,000	NE	< 360	< 370	< 360	<1500
Acetophenone	NE	NE	< 360	< 370	< 360	<1500
Anthracene	1,000,000	NE	< 360	< 370	< 360	<1500
Atrazine	NE	NE	< 360	< 370	< 360	<1500
Benzaldehyde	NE	NE	< 360	< 370	< 360	<1500
Benzo(a)anthracene	11,000	NE	74	J 58	J 60	J <1500
Benzo(a)pyrene	1,100	NE	72	J 47	J 62	J <1500
Benzo(b)fluoranthene	11,000	NE	73	J 56	J 57	J <1500
Benzo(ghi)perylene	1,000,000	NE	55	J 43	J 49	J <1500
Benzo(k)fluoranthene	110,000	NE	68	J 55	J 55	J <1500
Biphenyl	NE	NE	< 360	< 370	< 360	<1500
Bis(2-chloro-1-methylethyl) ether	NE	NE	< 360	< 370	< 360	<1500
Bis(2-chloroethoxy)methane	NE	NE	< 360	< 370	< 360	<1500
Bis(2-chloroethyl)ether	NE	NE	< 360	< 370	< 360	<1500
Bis(2-ethylhexyl)phthalate (BEHP)	NE	NE	34	J < 370	< 360	<1500
Butyl benzyl phthalate	NE	NE	< 360	< 370	< 360	<1500
Caprolactam	NE	NE	< 360	< 370	< 360	<1500
Carbazole	NE	NE	< 360	< 370	< 360	<1500
Chrysene	110,000	NE	97	J 71	J 72	J <1500
Dibenzo(a,h)anthracene	1,100	NE	< 360	< 370	< 360	<1500
Dibenzofuran	NE	NE	< 360	< 370	< 360	<1500
Diethyl phthalate	NE	NE	< 360	< 370	< 360	<1500
Dimethyl phthalate	NE	NE	< 360	< 370	< 360	<1500
Di-n-butyl phthalate	NE	NE	< 360	< 370	< 360	<1500
Di-n-octyl phthalate	NE	NE	< 360	< 370	< 360	<1500
Fluoranthene	1,000,000	NE	170	J 130	J 130	J <1500
Fluorene	1,000,000	NE	< 360	< 370	< 360	<1500
Hexachlorobenzene	NE	130	< 360	< 370	< 360	<1500
Hexachlorobutadiene	NE	500	< 360	< 370	< 360	<1500
Hexachlorocyclopentadiene	NE	NE	< 360	< 370	< 360	<1500
Hexachloroethane	NE	3,000	< 360	< 370	< 360	<1500
Indeno(1,2,3-cd)pyrene	11,000	NE	45	J 38	J 36	J <1500

Footnotes on next page.



ARCADIS

Table D8. Concentrations of SVOCs in Soil from Soil Pile Samples, Northrop Grumman Systems Corporation, Operable Unit 3 (Former Grumman Settling Ponds), Bethpage, New York.

CONSTITUENT ug/kg	Sample Location:		EWLT-E	EWLT-C	EWLT-W	WLT-ST
	Sample Date:		1/9/2008	1/9/2008	1/9/2008	2/7/2008
	<u>NYSDEC Part 375</u>					
<u>SVOCs</u>	<u>Industrial</u>	<u>RCRA</u>				
Isophorone	NE	NE	< 360	< 370	< 360	<1500
Naphthalene	1,000,000	NE	< 360	< 370	< 360	<1500
Nitrobenzene	NE	2,000	< 360	< 370	< 360	<1500
N-Nitrosodiphenylamine	NE	NE	< 360	< 370	< 360	<1500
N-Nitrosodipropylamine	NE	NE	< 360	< 370	< 360	<1500
Pentachlorophenol	55,000	100,000	< 1800	< 370	< 360	<1500
Phenanthrene	1,000,000	NE	53 J	85 J	59 J	<1500
Phenol	1,000,000	NE	< 360	< 370	< 360	<1500
Pyrene	1,000,000	NE	140 J	110 J	110 J	<1500

Notes and Abbreviations:

Bold value indicates a detection

-  Result exceeds NYSDEC Part 375 Industrial Soil Cleanup Standards
-  Result exceeds 40 CFR Part 261 Toxicity Characteristics Concentrations
- NYSDEC New York State Department of Environmental Conservation
- ug/kg milligrams per kilogram
- NE Not Established

ARCADIS

Table D9. Concentrations of PCBs in Soil from Soil Pile Samples, Northrop Grumman Systems Corporation, Operable Unit 3 (Former Grumman Settling Ponds), Bethpage, New York.

CONSTITUENT (ug/kg)	Sample Location: Sample Date: Sample Depth (ft bls):	WLT-ST	MFT	WLT-1	WLT-ST	EWLT-E	EWLT-C	EWLT-W	EWLTC (4TB)	
		12/18/2007	12/6/2007	12/14/2007	12/18/2007	1/9/2008	1/9/2008	1/9/2008	1/16/2008	
<u>NYSDEC Part 375</u>										
<u>Polychlorinated Biphenyls</u>	<u>Industrial</u>	<u>RCRA</u>								
Aroclor-1016	25,000	50,000	< 37	< 37	< 370	< 37	< 360	< 37000	< 73	<84
Aroclor-1221	25,000	50,000	< 76	< 76	< 750	< 76	< 720	< 75000	< 150	<84
Aroclor-1232	25,000	50,000	< 37	< 37	< 370	< 37	< 360	< 37000	< 73	<84
Aroclor-1242	25,000	50,000	< 37	< 37	< 370	< 37	< 360	< 37000	< 73	1100
Aroclor-1248	25,000	50,000	330	140	2500	330	3000	290000	420	<84
Aroclor-1254	25,000	50,000	260	< 37	< 370	260	780	< 37000	510	<84
Aroclor-1260	25,000	50,000	< 37	< 37	< 370	< 37	< 360	< 37000	210	<84

Notes and Abbreviations:

Bold value indicates a detection

- NYSDEC New York State Department of Environmental Conservation
- ug/kg micrograms per kilogram
- PCB Polychlorinated biphenyl

ARCADIS

Table D9. Concentrations of PCBs in Soil from Soil Pile Samples, Northrop Grumman Systems Corporation, Operable Unit 3 (Former Grumman Settling Ponds), Bethpage, New York.

CONSTITUENT (ug/kg)	Sample Location: EWLTC (4TM) EWLTC (4TT) EWLTC (4P) EWLTC (3TB) EWLTC (3TM) EWLTC (3TT) EWLTC (3P) EWLTC (2TB)									
	Sample Date: 1/16/2008 1/16/2008 1/16/2008 1/16/2008 1/16/2008 1/16/2008 1/16/2008 1/16/2008									
	Sample Depth (ft bls):									
	<u>NYSDEC Part 375</u>									
<u>Polychlorinated Biphenyls</u>	<u>Industrial</u>	<u>RCRA</u>								
Aroclor-1016	25,000	50,000	< 24	< 22	< 11000	< 21	< 26	< 21	< 22	< 22
Aroclor-1221	25,000	50,000	< 24	< 22	< 11000	< 21	< 26	< 21	< 22	< 22
Aroclor-1232	25,000	50,000	< 24	< 22	< 11000	< 21	< 26	< 21	< 22	< 22
Aroclor-1242	25,000	50,000	< 24	< 22	160000	87	< 26	< 21	< 22	180
Aroclor-1248	25,000	50,000	< 24	< 22	< 11000	< 21	< 26	< 21	< 22	< 22
Aroclor-1254	25,000	50,000	< 24	100	< 11000	< 21	< 26	< 21	120	200
Aroclor-1260	25,000	50,000	< 24	< 22	< 11000	< 21	< 26	< 21	< 22	< 22

Notes and Abbreviations:

Bold value indicates a detection

- NYSDEC New York State Department of Environmental Conservation
- ug/kg micrograms per kilogram
- PCB Polychlorinated biphenyl

ARCADIS

Table D9. Concentrations of PCBs in Soil from Soil Pile Samples, Northrop Grumman Systems Corporation, Operable Unit 3 (Former Grumman Settling Ponds), Bethpage, New York.

CONSTITUENT (ug/kg)	Sample Location: EWLTC (2TM) EWLTC (2TT) EWLTC (2P) EWLTC (1TB) EWLTC (1TM) EWLTC (1TT) EWLTC (1P)								
	Sample Date: 1/16/2008 1/16/2008 1/16/2008 1/16/2008 1/16/2008 1/16/2008 1/16/2008								
	Sample Depth (ft bls):								
	<u>NYSDEC Part 375</u>								
<u>Polychlorinated Biphenyls</u>	<u>Industrial</u>	<u>RCRA</u>							
Aroclor-1016	25,000	50,000	<78	< 21	< 24	< 22	< 24	< 22	< 570
Aroclor-1221	25,000	50,000	<78	< 21	< 24	< 22	< 24	< 22	< 570
Aroclor-1232	25,000	50,000	<78	< 21	< 24	< 22	< 24	< 22	< 570
Aroclor-1242	25,000	50,000	700	< 21	< 24	170	< 24	< 22	< 570
Aroclor-1248	25,000	50,000	<78	< 21	< 24	< 22	< 24	< 22	< 570
Aroclor-1254	25,000	50,000	<78	110	76	190	< 24	220	2300
Aroclor-1260	25,000	50,000	<78	< 21	< 24	< 22	< 24	< 22	< 570

Notes and Abbreviations:

Bold value indicates a detection

- NYSDEC New York State Department of Environmental Conservation
- ug/kg micrograms per kilogram
- PCB Polychlorinated biphenyl

ARCADIS

Table D10. Concentrations of Metals in Soil from Soil Pile Samples, Northrop Grumman Systems Corporation, Operable Unit 3 (Former Grumman Settling Ponds), Bethpage, New York.

CONSTITUENT mg/kg	Sample Location: Sample Date: Sample Depth (ft bls):	WLT-ST	MFT	WLT-1	WLT-ST	EWLT-E	EWLT-C	EWLT-W		
		12/18/2007	12/6/2007	12/14/2007	12/18/2007	1/9/2008	1/9/2008	1/9/2008		
		<u>NYSDEC Part 375</u>								
Metals		<u>Industrial</u>	<u>RCRA</u>							
Arsenic		16	5	4.09	4.43	1.85	4.09	1.89	3.14	1.28
Barium		10,000	100	42.7	16.10	16.8	42.7	10.3	18.6	13.1
Beryllium		2,700	NE	< 0.568	< 0.567	< 0.561	< 0.568	< 0.539	< 0.56	< 0.552
Cadmium		60	1	1.87	< 0.567	< 0.561	1.87	2.06	0.86	< 0.552
Chromium		6,800	5	377	11.3	22	377	93.3	25.8	59.8
Chromium (Hexavalent)		800	NE	75	< 4.54	6.33	75	19.6	6.25	14.7
Copper		10,000	NE	15.6	11.1	7.1	15.6	28.4	10.6	6.28
Cyanide		10,000	NE	< 1.14	< 1.13	< 1.12	< 1.14	< 1.08	< 1.12	< 1.10
Lead		3,900	5	36.4	18.6	23.1	36.4	30.8	23.1	13.8
Manganese		10,000	NE	65.5	71.7	59.8	65.5	78.8	127	70.7
Mercury		5.7	0.2	0.0797	0.0457	0.0402	0.0797	0.0669	< 0.105	0.0556
Nickel		10,000	NE	6.8	< 4.54	4.9	6.8	< 4.31	4.73	< 4.42
Selenium		6,800	1	1.5	< 1.13	< 1.12	1.5	< 1.08	< 1.12	< 1.10
Silver		6,800	5	< 1.14	1.32	< 1.12	< 1.14	2.55	< 1.12	< 1.10
Zinc		10,000	NE	537	26.6	25.4	537	51.9	21.3	89.3

Notes and Abbreviations:

Bold value indicates a detection

- Result exceeds NYSDEC Part 375 Industrial Soil Cleanup Standards
- Result exceeds 40 CFR Part 261 Toxicity Characteristics Concentrations
- NYSDEC New York State Department of Environmental Conservation
- mg/kg milligrams per kilogram
- NE Not Established

ARCADIS

Table D11. Transportation and Disposal Summary of VOC Containing Soils Profile NY296709
Operable Unit 3 Soil Gas IRM Former Grumman Settling Ponds, Bethpage New York.

Date	Manifest Tracking Number	Transport Tickets #	Pounds	Tons
4/1/2008	002551488 JJK	161055	71260	35.63
4/1/2008	002551489 JJK	161054	71240	35.62
4/4/2008	002551485 JJK	161097	71780	35.89
4/4/2008	002551487 JJK	161102	77240	38.62
			TOTAL TONS	145.76

ARCADIS

Table D12. Common Backfill Summary Source - 110 Sand Company
Operable unit 3 - Soil Gas IRM,
Former Grumman Settling Ponds, Bethpage, New York.

Date	Tons
1/29/2008	41.10
3/5/2008	40.00
3/6/2008	40.99
3/6/2008	41.05
3/6/2008	39.42
3/6/2008	41.08
3/6/2008	40.95
3/10/2008	42.56
3/10/2008	41.29
3/10/2008	40.70
3/10/2008	39.47
3/10/2008	40.69
3/19/2008	39.70
3/19/2008	40.34
3/19/2008	39.48
3/19/2008	40.61
3/19/2008	40.29
3/19/2008	39.47
3/19/2008	38.78
3/19/2008	41.19
3/19/2008	38.56
3/24/2008	41.12
3/24/2008	38.91
3/24/2008	36.96
3/24/2008	41.55
3/24/2008	39.22
3/24/2008	40.66
Total Tons	1,086.14

ARCADIS

Table D13. Recycled Concrete Aggregate Summary Source
Operable Unit 3, Former Grumman Settling Ponds,
Bethpage, New York.

Date	Ticket No.	Yards
4/1/2008	2643	140
4/2/2008	2644	35
4/2/2008	2646	35
4/2/2008	2647	35
4/3/2008	2648	35
Total		280

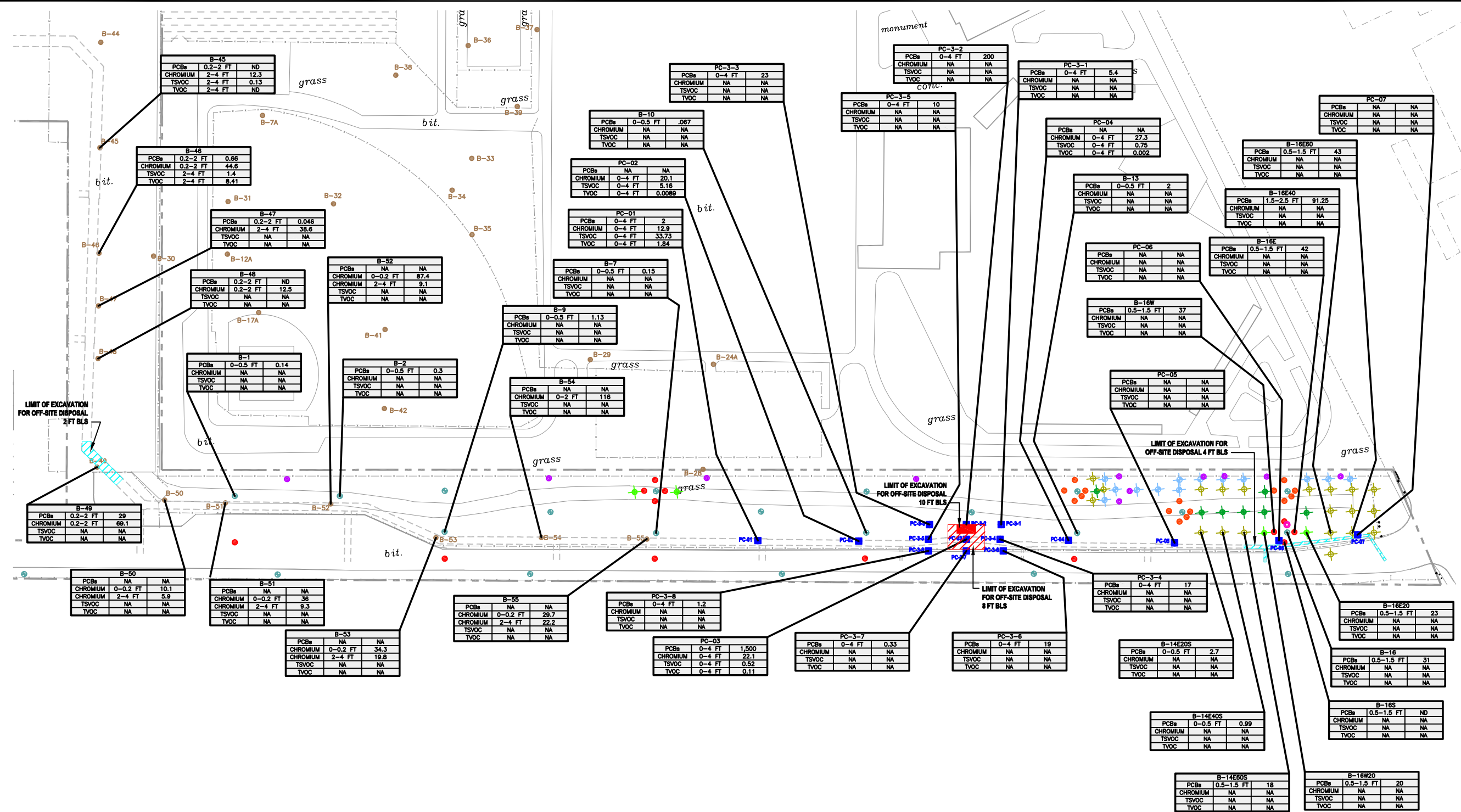
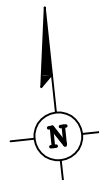

EXPLANATION:

- NORTHROP GRUMMAN PROPERTY LINE
- x- FENCE
- - - - - APPROXIMATE LIMITS OF OU-3 SOIL GAS INTERIM REMEDIAL MEASURE TRENCH
- PHASE 1 SOIL BORING
- PHASE 2 SOIL BORING (ADVANCED TO A DEPTH OF 3.5 FT BLS)
- PHASE 2 SOIL BORING (ADVANCED TO A DEPTH OF 7.5 FT BLS)
- PHASE 3 SOIL BORING (ADVANCED TO A DEPTH OF 4.5 FT BLS)
- PHASE 3 SOIL BORING (ADVANCED TO A DEPTH OF 5.5 FT BLS)
- PHASE 4 SOIL BORING (ADVANCED TO A DEPTH OF 5.5 FT BLS)
- PHASE 5 SOIL BORING (ADVANCED TO A DEPTH OF 5.5 FT BLS)
- PHASE 6 SOIL BORING (ADVANCED TO A DEPTH OF 5.5 FT BLS)
- PHASE 6 SOIL BORING (ADVANCED TO A DEPTH OF 7.5 FT BLS)
- OU-3 RI SOIL BORING
- PC-02 COMPLETED OU-3 IRM PRE-CONSTRUCTION BORING (SEPTEMBER, 2007 BY ARCADIS)
- OFF-SITE DISPOSAL, TSCA
- OFF-SITE DISPOSAL, NON-TSCA

NOTES:

1. PHASE 1 TO 6 SOIL BORING LOCATIONS ARE APPROXIMATE (DVIKA & BARTILUCCI PCB INVESTIGATION/DELINEATION PROGRAM, JULY 2001).
2. SAMPLE RESULTS DEEPER THEN 8 FEET FOR LOCATIONS PC-03 TO PC-3-8 SHOWN IN TABLE 4.
3. HIGHEST CONCENTRATION BETWEEN 0 TO 0.2 FT AND 0.2 TO 2 FT BLS IS SHOWN.
4. PHASE 1 TO 6 SOIL BORINGS PROVIDED IN JULY 2007 REPORT, PREPARED BY DVIKA & BARTILUCCI.
5. SOILS IN REMAINDER OF TRENCH AREA WILL BE STOCKPILED AND RE-USED AS BACKFILL.

PC-03	
PCBs	0-4 FT 1,500
CHROMIUM	0-4 FT 22.1
TSVOC	0-4 FT 0.52
TVOC	0-4 FT 0.11

CONSTITUENT(S) BORING OR SAMPLE DESIGNATION

SAMPLE INTERVAL IN FT BLS CONCENTRATION IN MILLIGRAMS PER KILOGRAM (mg/kg)

ND - NOT DETECTED
 NA - NOT ANALYZED
 PCBs - POLYCHLORINATED BIPHENYLS
 TSVOC - TOTAL SEMI-VOLATILE ORGANIC COMPOUNDS
 TVOC - TOTAL VOLATILE ORGANIC COMPOUNDS
 TSCA - TOXIC SUBSTANCE CONTROL ACT
 FT - FEET
 BLS - BELOW LAND SURFACE

NORTHROP GRUMMAN SYSTEMS CORPORATION
 BETHPAGE, NEW YORK
OPERABLE UNIT 3
 (FORMER GRUMMAN SETTLING PONDS)

SOIL QUALITY DATA IN TRENCH AREA
 (0 - 4 FEET BELOW LAND SURFACE)

ARCADIS

FIGURE
D1

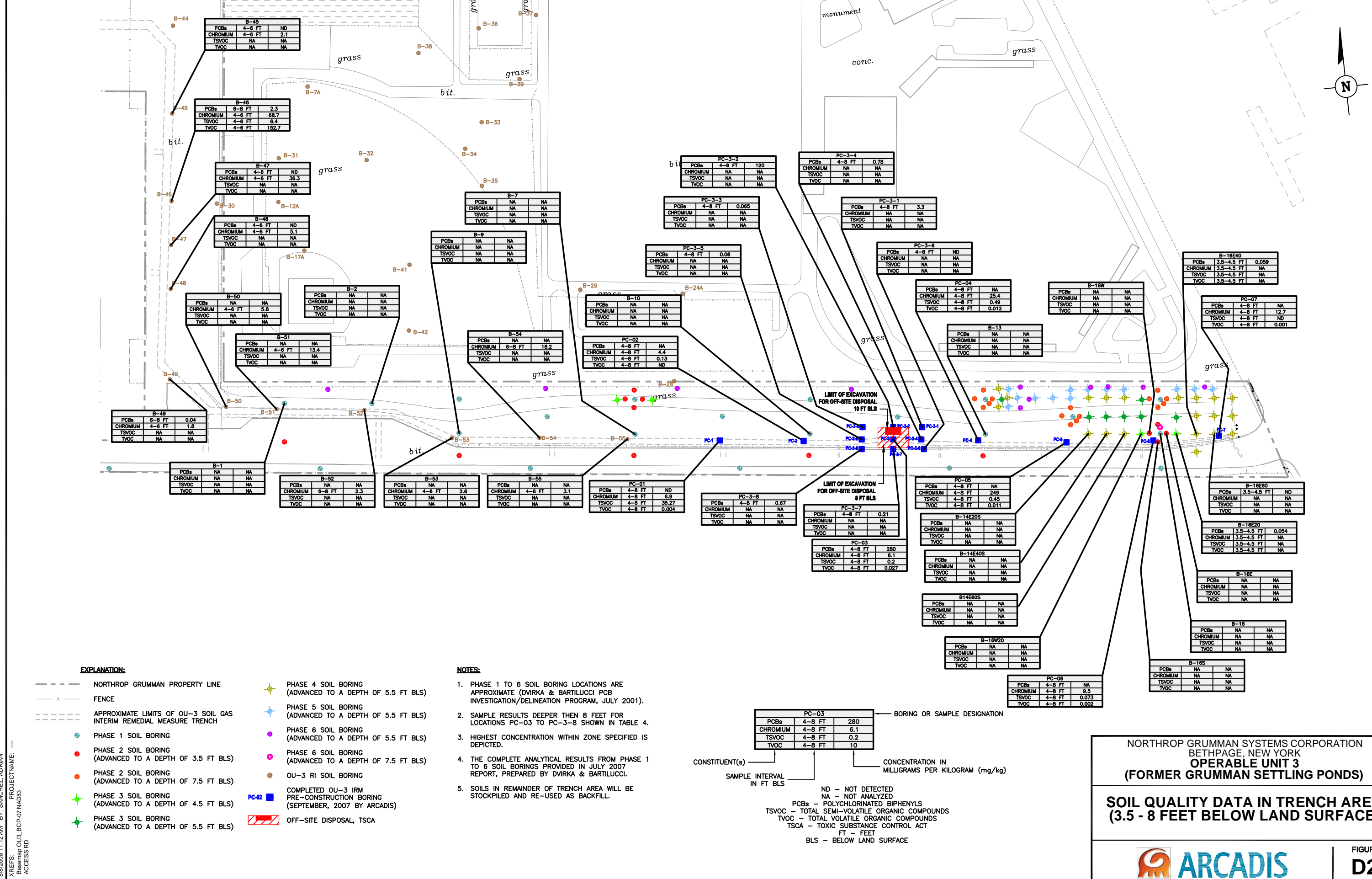

EXPLANATION:

- NORTHROP GRUMMAN PROPERTY LINE
- x- FENCE
- - - - APPROXIMATE LIMITS OF OU-3 SOIL GAS INTERIM REMEDIAL MEASURE TRENCH
- PHASE 1 SOIL BORING
- PHASE 2 SOIL BORING (ADVANCED TO A DEPTH OF 3.5 FT BLS)
- PHASE 2 SOIL BORING (ADVANCED TO A DEPTH OF 7.5 FT BLS)
- PHASE 3 SOIL BORING (ADVANCED TO A DEPTH OF 4.5 FT BLS)
- PHASE 3 SOIL BORING (ADVANCED TO A DEPTH OF 5.5 FT BLS)
- PHASE 4 SOIL BORING (ADVANCED TO A DEPTH OF 5.5 FT BLS)
- PHASE 5 SOIL BORING (ADVANCED TO A DEPTH OF 5.5 FT BLS)
- PHASE 6 SOIL BORING (ADVANCED TO A DEPTH OF 5.5 FT BLS)
- PHASE 6 SOIL BORING (ADVANCED TO A DEPTH OF 7.5 FT BLS)
- OU-3 RI SOIL BORING
- PC-02 COMPLETED OU-3 IRM PRE-CONSTRUCTION BORING (SEPTEMBER, 2007 BY ARCADIS)
- OFF-SITE DISPOSAL, TSCA

NOTES:

1. PHASE 1 TO 6 SOIL BORING LOCATIONS ARE APPROXIMATE (DVIKA & BARTILUCCI PCB INVESTIGATION/DELINEATION PROGRAM, JULY 2001).
2. SAMPLE RESULTS DEEPER THEN 8 FEET FOR LOCATIONS PC-03 TO PC-3-8 SHOWN IN TABLE 4.
3. HIGHEST CONCENTRATION WITHIN ZONE SPECIFIED IS DEPICTED.
4. THE COMPLETE ANALYTICAL RESULTS FROM PHASE 1 TO 6 SOIL BORINGS PROVIDED IN JULY 2007 REPORT, PREPARED BY DVIKA & BARTILUCCI.
5. SOILS IN REMAINDER OF TRENCH AREA WILL BE STOCKPILED AND RE-USED AS BACKFILL.

CONSTITUENT(S)	SAMPLE INTERVAL IN FT BLS	CONCENTRATION IN MILLIGRAMS PER KILOGRAM (mg/kg)
PCBs	4-8 FT	280
CHROMIUM	4-8 FT	6.1
TSVOC	4-8 FT	0.2
TVOC	4-8 FT	10

ND - NOT DETECTED
 NA - NOT ANALYZED
 PCBs - POLYCHLORINATED BIPHENYLS
 TSVOC - TOTAL SEMI-VOLATILE ORGANIC COMPOUNDS
 TVOC - TOTAL VOLATILE ORGANIC COMPOUNDS
 TSCA - TOXIC SUBSTANCE CONTROL ACT
 FT - FEET
 BLS - BELOW LAND SURFACE

NORTHROP GRUMMAN SYSTEMS CORPORATION
 BETHPAGE, NEW YORK
OPERABLE UNIT 3
 (FORMER GRUMMAN SETTLING PONDS)
SOIL QUALITY DATA IN TRENCH AREA
 (3.5 - 8 FEET BELOW LAND SURFACE)



ARCADIS

Attachment D-1

Soil Gas IRM Construction
Waste Manifests



Transporter Log
CWM Chemical Services, Inc.
 Model City, NY

158469

Cubic Yards

81621035

AN36125

Receipt #

Trailer License Plate # and State

SCALE 1 107780 LB G

09:00 AM 12/27/07 T1

Service Req. #

Profile #

Permit #

mangialdi Bros

48/30

Transporter Name

Tractor/Trailer/Roll-off #

Tom Vieta

NORTHROP GUMBRICH corp

Driver's Name

Generator

SCALE 2 37400 LB G

11:04 AM 12/27/07 I2

Scheduled Arrival:

8:48

Date

Time

Actual Arrival:

Date

Time In

Time Out

Arrived during Blackout? Y / N

Notified DEC? Y / N

Leaker Permit Violation Placarding/Veh. I.D. Violation

Other (specify)

Bulk to Landfill No wet line Flatbed Stabilization Drums Tanker Transformers

Receiving:

Initials

Comments

703801
31224K

Laboratory

Time In

Time Out

Initials

Comments

Stabilization

Time In

Time Out

Initials

Gross Wt.

Comments

Landfill

Time In

Time Out

Initials

Comments

Other

Time In

Time Out

Initials

Comments

Aqueous Treatment

Time In

Time Out

Signature (NO Initials)

Comments

Facility Personnel (please initial)

Smoking or eating in prohibited areas

Leaving truck unattended

Failure to obey instructions of facility personnel

Failure to display overweight flag

Failure to wear appropriate PPE

Improper tarping or detarpin

Unsafe driving practices

Overweight upon arrival

Other (specify)

Security Guard Initials:

(Indicating receipt of Wash Bay pass, if necessary)

Driver's Comments

White: Records

Green & Canary: Accts Rec.

Pink: Environmental

Goldenrod: Driver

Please print or type. (Form designed for use on elite (12-pitch) typewriter.)

Form Approved. OMB No. 2050-0039

UNIFORM HAZARDOUS WASTE MANIFEST		1. Generator ID Number NYR000058347	2. Page 1 of 1	3. Emergency Response Phone 800-421-9300	4. Manifest Tracking Number 000364561GBF	
5. Generator's Name and Mailing Address NORTHROP GRUMMAN CORP 925 SOUTH OYSTER BAY RD, MAIL STOP W16-35 BETHPAGE NY 11714			Generator's Site Address (if different than mailing address) NORTHROP GRUMMAN AEROSPACE BLVD BETHPAGE NY 11714			
Generator's Phone: (516) 575-4680						
6. Transporter 1 Company Name MANGIARDI TRUCKING				U.S. EPA ID Number NYR00097972		
7. Transporter 2 Company Name				U.S. EPA ID Number		
8. Designated Facility Name and Site Address CWM CHEMICAL SERVICES, L.L.C. 1550 BALMER RD. MODEL CITY NY 14107					U.S. EPA ID Number NYD049836679	
Facility's Phone: (716) 754-8231						
9a. HM	9b. U.S. DOT Description (including Proper Shipping Name, Hazard Class, ID Number, and Packing Group (if any))	10. Containers		11. Total Quantity	12. Unit Wt./Vol.	13. Waste Codes
		No.	Type			
X	1. RQ, POLYCHLORINATED BIPHENYLS, SOLID MIXTURE, 9, UN3432, III NY296605	001	DT	EST 2725K	K	B007
	2.					
	3.					
	4.					
14. Special Handling Instructions and Additional Information 1. NY296605 PCB Soil ERG # 171 PCB Out of Service Date 12/26/07 Weight is Section 11 is Estimated. SR# 81621035						
15. GENERATOR'S/OFFEROR'S CERTIFICATION: I hereby declare that the contents of this consignment are fully and accurately described above by the proper shipping name, and are classified, packaged, marked and labeled/placarded, and are in all respects in proper condition for transport according to applicable international and national governmental regulations. If export shipment and I am the Primary Exporter, I certify that the contents of this consignment conform to the terms of the attached EPA Acknowledgment of Consent. I certify that the waste minimization statement identified in 40 CFR 262.27(a) (if I am a large quantity generator) or (b) (if I am a small quantity generator) is true.						
Generator's/Offeror's Printed/Typed Name AGUST FOR NORTHROP GRUMMAN Signature BRUCE EULIAN Signature Agust For Northrop Grumman Signature Month Day Year 12 26 07						
16. International Shipments <input type="checkbox"/> Import to U.S. <input type="checkbox"/> Export from U.S. Port of entry/exit: Date leaving U.S.:						
17. Transporter Acknowledgment of Receipt of Materials Transporter 1 Printed/Typed Name Tom Vreke Signature Tom Vreke Signature Month Day Year 12 26 07						
18. Discrepancy 18a. Discrepancy Indication Space <input checked="" type="checkbox"/> Quantity <input type="checkbox"/> Type <input type="checkbox"/> Residue <input type="checkbox"/> Partial Rejection <input type="checkbox"/> Full Rejection qty not actual rec'd 31924K						
18b. Alternate Facility (or Generator) Manifest Reference Number: U.S. EPA ID Number						
Facility's Phone:						
18c. Signature of Alternate Facility (or Generator) Month Day Year						
19. Hazardous Waste Report Management Method Codes (i.e., codes for hazardous waste treatment, disposal, and recycling systems)						
1. H132		2.		3.		4.
20. Designated Facility Owner or Operator: Certification of receipt of hazardous materials covered by the manifest except as noted in Item 18a						
Printed/Typed Name ELLEN CARTER Signature Ellen Carter Signature Month Day Year 12 27 07						



Transporter Log
CWM Chemical Services, Inc.
 Model City, NY

158500

Cubic Yards

Receipt # 4621067 Trailer License Plate # and State AH 21662 NY
 Service Req. # NY296105 Profile # 44-200 Permit # 44-200
 Transporter Name MANSON Tractor/Trailer/Roll-off # 44-200
 Driver's Name Ken Generator WYNE GULLON

SCALE 1 102120 LB 0
 SCALE 2 37420 LB 0
 07:55 AM 12/28/07 12

Scheduled Arrival: _____
 Actual Arrival: _____
 Date Time In Time Out

64700P
2934JK

Arrived during Blackout? Y / N Notified DEC? Y / N

- Leaker Permit Violation Placarding/Veh. I.D. Violation
 Other (specify _____)

Receiving: ✓
 Initials Comments

- Bulk to Landfill No wet line Flatbed Stabilization Drums Tanker Transformers

Laboratory

Time In Time Out Initials Comments

Stabilization

Time In Time Out Initials Gross Wt. Comments

Landfill

Time In Time Out Initials Comments

Other

Time In Time Out Initials Comments

Aqueous Treatment

Time In Time Out Signature (NO Initials) Comments

Facility Personnel (please initial)

- _____ Smoking or eating in prohibited areas _____ Leaving truck unattended
 _____ Failure to obey instructions of facility personnel _____ Failure to display overweight flag
 _____ Failure to wear appropriate PPE _____ Improper tarping or detarpin
 _____ Unsafe driving practices _____ Overweight upon arrival
 _____ Other (specify _____)

Security Guard Initials: _____
 (Indicating receipt of Wash Bay pass, if necessary)

Driver's Comments

Please print or type. (Form designed for use on elite (12-pitch) typewriter.)

UNIFORM HAZARDOUS WASTE MANIFEST		1. Generator ID Number NYR000058347	2. Page 1 of 1	3. Emergency Response Phone 800-424-9300	4. Manifest Tracking Number 000364562GBF			
5. Generator's Name and Mailing Address NORTHROP GRUMMAN CORP 925 SOUTH OYSTER BAY RD, MAIL STOP W16-35 BETHPAGE NY 11714 (516) 575-4680				Generator's Site Address (if different than mailing address) NORTHROP GRUMMAN AEROSPACE BLVD BETHPAGE NY 11714				
6. Transporter 1 Company Name MANGIARDI TRUCKING					U.S. EPA ID Number NYR000097972			
7. Transporter 2 Company Name					U.S. EPA ID Number			
8. Designated Facility Name and Site Address CWM CHEMICAL SERVICES, L.L.C. 1550 BALMER RD. MODEL CITY NY 14107 (716) 754-8231					U.S. EPA ID Number NYD049836679			
Facility's Phone:					U.S. EPA ID Number			
9a. HM	9b. U.S. DOT Description (including Proper Shipping Name, Hazard Class, ID Number, and Packing Group (if any))		10. Containers No. Type		11. Total Quantity	12. Unit Wt./Vol.	13. Waste Codes	
X	1. RQ, POLYCHLORINATED BIPHENYLS, SOLID MIXTURE, 9,UN3432,III NY296605		001 DT		EST 2725K	K	B007	
	2.							
	3.							
	4.							
14. Special Handling Instructions and Additional Information 1. NY296605 PCB Soil ERG # 171 PCB Out of Service Date 12/27/07 Weight in Section 11 is Estimated. SR# 8/10/21067 Recd 29348K								
15. GENERATOR'S/OFFEROR'S CERTIFICATION: I hereby declare that the contents of this consignment are fully and accurately described above by the proper shipping name, and are classified, packaged, marked and labeled/placarded, and are in all respects in proper condition for transport according to applicable international and national governmental regulations. If export shipment and I am the Primary Exporter, I certify that the contents of this consignment conform to the terms of the attached EPA Acknowledgment of Consent. I certify that the waste minimization statement identified in 40 CFR 262.27(a) (if I am a large quantity generator) or (b) (if I am a small quantity generator) is true.								
Generator's/Offorer's Printed/Typed Name AGENT FOR NORTHROP GRUMMAN					Signature BRUCE EULIAN			Month Day Year 12/27/07
16. International Shipments <input type="checkbox"/> Import to U.S. <input type="checkbox"/> Export from U.S. Port of entry/exit: Date leaving U.S.:								
17. Transporter Acknowledgment of Receipt of Materials Transporter 1 Printed/Typed Name RON FERNETT Signature Ron Fennett Month Day Year 12/27/07 Transporter 2 Printed/Typed Name Signature								
18. Discrepancy 18a. Discrepancy Indication Space <input type="checkbox"/> Quantity <input type="checkbox"/> Type <input type="checkbox"/> Residue <input type="checkbox"/> Partial Rejection <input type="checkbox"/> Full Rejection Manifest Reference Number: U.S. EPA ID Number								
18b. Alternate Facility (or Generator) U.S. EPA ID Number								
18c. Signature of Alternate Facility (or Generator) Month Day Year								
19. Hazardous Waste Report Management Method Codes (i.e., codes for hazardous waste treatment, disposal, and recycling systems) 1. H132 2. 3. 4.								
20. Designated Facility Owner or Operator: Certification of receipt of hazardous materials covered by the manifest except as noted in Item 18a Printed/Typed Name ELLEN CARTON Signature Ellen Carton Month Day Year 12/28/07								

GENERATOR
INTL
TRANSPORTER
DESIGNATED FACILITY



Transporter Log
CWM Chemical Services, Inc.
 Model City, NY

158545

Cubic Yards

8162110
 Receipt # _____
 Service Req. # _____
 Transporter Name _____
 Driver's Name _____

AR27257 NY
 Trailer License Plate # and State
 Profile # _____
 Permit # _____
 Tractor/Trailer/Roll-off # _____
 Generator _____

SCALE 1 107000 LB S
 10:02 AM 12/28/07 12
 SCALE 2 36360 LB B
 11:12 AM 12/28/07 12
 70640P
 32042K

Scheduled Arrival: _____
 Date Time
 Actual Arrival: _____
 Date Time In Time Out

Arrived during Blackout? Y / N Notified DEC? Y / N

- Leaker
- Permit Violation
- Placarding/Veh. I.D. Violation
- Other (specify _____)
- Bulk to Landfill
- No wet line
- Flatbed
- Stabilization
- Drums
- Tanker
- Transformers

Receiving: _____	
Initials	Comments

Laboratory

Time In	Time Out	Initials	Comments

Stabilization

Time In	Time Out	Initials	Gross Wt.	Comments

Landfill

Time In	Time Out	Initials	Comments

Other

Time In	Time Out	Initials	Comments

Aqueous Treatment

Time In	Time Out	Signature (NO Initials)	Comments

Facility Personnel (please initial)

- _____ Smoking or eating in prohibited areas
- _____ Failure to obey instructions of facility personnel
- _____ Failure to wear appropriate PPE
- _____ Unsafe driving practices
- _____ Other (specify _____)
- _____ Leaving truck unattended
- _____ Failure to display overweight flag
- _____ Improper tarping or detarpin
- _____ Overweight upon arrival

Security Guard Initials: _____
 (Indicating receipt of Wash Bay pass, if necessary)

Driver's Comments

Please print or type. (Form designed for use on elite (12-pitch) typewriter.)

Form Approved. OMB No. 2050-0039

UNIFORM HAZARDOUS WASTE MANIFEST		1. Generator ID Number NYR000058347	2. Page 1 of 1	3. Emergency Response Phone 800-424-9300	4. Manifest Tracking Number 000364563GBF	
5. Generator's Name and Mailing Address NORTHROP GRUMMAN CORP 925 SOUTH OYSTER BAY RD, MAIL STOP W16-35 BETHPAGE NY 11714			Generator's Site Address (if different than mailing address) NORTHROP GRUMMAN AEROSPACE BLVD BETHPAGE NY 11714			
Generator's Phone: (516) 575-4680						
6. Transporter 1 Company Name MANGIARDI TRUCKING				U.S. EPA ID Number NYR000097972		
7. Transporter 2 Company Name				U.S. EPA ID Number		
8. Designated Facility Name and Site Address CWM CHEMICAL SERVICES, L.L.C. 1550 BALMER RD. MODEL CITY NY 14107			U.S. EPA ID Number NYD049836679			
Facility's Phone: (716) 754-8231						
9a. HM	9b. U.S. DOT Description (including Proper Shipping Name, Hazard Class, ID Number, and Packing Group (if any))	10. Containers		11. Total Quantity	12. Unit Wt./Vol.	13. Waste Codes
		No.	Type			
X	1. RO. POLYCHLORINATED BIPHENYLS, SOLID MIXTURE, 9,UN3432,III NY296605	001	DT	EST. 2725K		B007
	2.					
	3.					
	4.					
14. Special Handling Instructions and Additional Information 1. NY296605 PCB Soil ERG # 171 PCB Out of Service Date <u>12/27/07</u> Weight in Section 11 is Estimated. SR# _____ <u>8162110</u>						
15. GENERATOR'S/OFFEROR'S CERTIFICATION: I hereby declare that the contents of this consignment are fully and accurately described above by the proper shipping name, and are classified, packaged, marked and labeled/placarded, and are in all respects in proper condition for transport according to applicable international and national governmental regulations. If export shipment and I am the Primary Exporter, I certify that the contents of this consignment conform to the terms of the attached EPA Acknowledgment of Consent. I certify that the waste minimization statement identified in 40 CFR 262.27(a) (if I am a large quantity generator) or (b) (if I am a small quantity generator) is true.						
Generator's/Offeror's Printed/Typed Name AGENT FOR NORTHROP GRUMMAN BRUCE EULIAN Agent for Northrop Grumman				Signature <i>Bruce Eulian</i>		Month Day Year 12 27 07
16. International Shipments <input type="checkbox"/> Import to U.S. <input type="checkbox"/> Export from U.S. Port of entry/exit: _____ Transporter signature (for exports only): Date leaving U.S.: _____						
17. Transporter Acknowledgment of Receipt of Materials						
Transporter 1 Printed/Typed Name Chris Hebe				Signature <i>Chris Hebe</i>		Month Day Year 12 27 07
Transporter 2 Printed/Typed Name				Signature		Month Day Year
18. Discrepancy						
18a. Discrepancy Indication Space <input checked="" type="checkbox"/> Quantity <input type="checkbox"/> Type <input type="checkbox"/> Residue <input type="checkbox"/> Partial Rejection <input type="checkbox"/> Full Rejection qty est actual recd 32042K						
18b. Alternate Facility (or Generator)				Manifest Reference Number: _____ U.S. EPA ID Number		
Facility's Phone: _____						
18c. Signature of Alternate Facility (or Generator)						Month Day Year
19. Hazardous Waste Report Management Method Codes (i.e., codes for hazardous waste treatment, disposal, and recycling systems)						
1. H132		2.		3.		4.
20. Designated Facility Owner or Operator: Certification of receipt of hazardous materials covered by the manifest except as noted in Item 18a						
Printed/Typed Name Ellen Carter				Signature <i>Ellen Carter</i>		Month Day Year 12 28 07

DESIGNATED FACILITY TO DESTINATION STATE (IF REQUIRED)



Transporter Log
CWM Chemical Services, Inc.
 Model City, NY

158586

Cubic Yards

816 211 53

280283-VK

SCALE 2 103980 LB G

Receipt #

Trailer License Plate # and State

07:36 AM 12/31/07 12

NY296605 7A-025

Service Req. #

Profile #

Permit #

PRICE, RICKINS

13600-2450

Transporter Name

Tractor/Trailer/Roll-off #

SCALE 2 35960 LB G

KOKOV, TOSHAK

MDRT-ROP-GRUMMAN

09:59 AM 12/31/07 12

Driver's Name

Generator

Scheduled Arrival:

Date

Time

Actual Arrival:

Date

Time In

Time Out

68020P
30854K

Arrived during Blackout? Y / N

Notified DEC? Y / N

Leaker Permit Violation Placarding/Veh. I.D. Violation

Other (specify)

Bulk to Landfill No wet line Flatbed Stabilization Drums Tanker Transformers

Receiving: <u>J</u>	
Initials	Comments

Laboratory

Time In	Time Out	Initials	Comments
---------	----------	----------	----------

Stabilization

Time In	Time Out	Initials	Gross Wt.	Comments
---------	----------	----------	-----------	----------

Landfill

Time In	Time Out	Initials	Comments
---------	----------	----------	----------

Other

Time In	Time Out	Initials	Comments
---------	----------	----------	----------

Aqueous Treatment

Time In	Time Out	Signature (NO Initials)	Comments
---------	----------	-------------------------	----------

Facility Personnel (please initial)

- | | |
|--|--|
| _____ Smoking or eating in prohibited areas | _____ Leaving truck unattended |
| _____ Failure to obey instructions of facility personnel | _____ Failure to display overweight flag |
| _____ Failure to wear appropriate PPE | _____ Improper tarping or detarpin |
| _____ Unsafe driving practices | _____ Overweight upon arrival |
| _____ Other (specify) | |

Security Guard Initials: _____
 (Indicating receipt of Wash Bay pass, if necessary)

Driver's Comments

Please print or type. (Form designed for use on elite (12-pitch) typewriter.)

Form Approved. OMB No. 2050-0039

UNIFORM HAZARDOUS WASTE MANIFEST		1. Generator ID Number NYR000058347	2. Page 1 of 1	3. Emergency Response Phone 800-424-9300	4. Manifest Tracking Number 000364565GBF			
5. Generator's Name and Mailing Address NORTHROP GRUMMAN CORP 925 SOUTH OYSTER BAY RD, MAIL STOP W16-35 BETHPAGE NY 11714				Generator's Site Address (if different than mailing address) NORTHROP GRUMMAN AEROSPACE BLVD BETHPAGE NY 11714				
Generator's Phone: (516) 575-4680				6. Transporter 1 Company Name PRICE TRUCKING				
				U.S. EPA ID Number NYD046765574				
7. Transporter 2 Company Name				U.S. EPA ID Number				
8. Designated Facility Name and Site Address CWM CHEMICAL SERVICES, L.L.C. 1550 BALMER RD. MODEL CITY NY 14107				U.S. EPA ID Number NYD049836679				
Facility's Phone: (716) 754-8231								
GENERATOR	9a. HM	9b. U.S. DOT Description (including Proper Shipping Name, Hazard Class, ID Number, and Packing Group (if any))		10. Containers		11. Total Quantity	12. Unit Wt./Vol.	13. Waste Codes
	X	1. RQ, POLYCHLORINATED BIPHENYLS, SOLID MIXTURE, 9, UN3432, III NY296605		001	DT	EST 2745K	K	B007
		2.						
		3.						
		4.						
14. Special Handling Instructions and Additional Information 1. NY296605 PCB Soil ERG #171 PCB Out of Service Date 12/28/07 Weight in Section 11 is Estimated. SR# 81621153								
15. GENERATOR'S/OFFEROR'S CERTIFICATION: I hereby declare that the contents of this consignment are fully and accurately described above by the proper shipping name, and are classified, packaged, marked and labeled/placarded, and are in all respects in proper condition for transport according to applicable international and national governmental regulations. If export shipment and I am the Primary Exporter, I certify that the contents of this consignment conform to the terms of the attached EPA Acknowledgment of Consent. I certify that the waste minimization statement identified in 40 CFR 262.27(a) (if I am a large quantity generator) or (b) (if I am a small quantity generator) is true.								
Generator's/Offoror's Printed/Typed Name AGENT FOR NORTHROP GRUMMAN Signature BRUCE EULIAN Signature Agent for Northrop Grumman Signature Month Day Year 12 28 07								
TRANSPORTER	16. International Shipments <input type="checkbox"/> Import to U.S. <input type="checkbox"/> Export from U.S. Port of entry/exit: _____ Date leaving U.S.: _____							
	17. Transporter Acknowledgment of Receipt of Materials Transporter 1 Printed/Typed Name KOKOU TOSSAH Signature [Signature] Signature Month Day Year 12 28 07							
DESIGNATED FACILITY	18. Discrepancy							
	18a. Discrepancy Indication Space <input checked="" type="checkbox"/> Quantity <input type="checkbox"/> Type <input type="checkbox"/> Residue <input type="checkbox"/> Partial Rejection <input type="checkbox"/> Full Rejection qty not actual recd 30854K							
	18b. Alternate Facility (or Generator) Manifest Reference Number: _____ U.S. EPA ID Number _____							
Facility's Phone: _____								
18c. Signature of Alternate Facility (or Generator) Month Day Year								
19. Hazardous Waste Report Management Method Codes (i.e., codes for hazardous waste treatment, disposal, and recycling systems)								
1. H132		2.		3.		4.		
20. Designated Facility Owner or Operator: Certification of receipt of hazardous materials covered by the manifest except as noted in item 18a								
Printed/Typed Name EILEEN CARTER Signature Eileen Carter Signature Month Day Year 12 31 07								



Transporter Log
CWM Chemical Services, Inc.
 Model City, NY

158549

Cubic Yards

8162115

AC91628 NY

Receipt # _____ Trailer License Plate # and State _____

SCALE 2 103340 LB G

Service Req. # _____ Profile # _____ Permit # _____

06:12 AM 12/31/07 12

Transporter Name _____ Tractor/Trailer/Roll-off # _____

SCALE 2 39020 LB G

Driver's Name _____ Generator _____

07:45 AM 12/31/07 12

Scheduled Arrival: _____

Actual Arrival: _____
 Date _____ Time _____
 Date _____ Time In _____ Time Out _____

64920 P
 29448K

Arrived during Blackout? Y / N Notified DEC? Y / N

- Leaker Permit Violation Placarding/Veh. I.D. Violation
 Other (specify _____)

Receiving: _____	_____
Initials	Comments

- Bulk to Landfill No wet line Flatbed Stabilization Drums Tanker Transformers

Laboratory

Time In _____ Time Out _____ Initials _____ Comments _____

Stabilization

Time In _____ Time Out _____ Initials _____ Gross Wt. _____ Comments _____

Landfill

Time In _____ Time Out _____ Initials _____ Comments _____

Other

Time In _____ Time Out _____ Initials _____ Comments _____

Aqueous Treatment

Time In _____ Time Out _____ Signature (NO Initials) _____ Comments _____

Facility Personnel (please initial)

- | | |
|--|--|
| _____ Smoking or eating in prohibited areas | _____ Leaving truck unattended |
| _____ Failure to obey instructions of facility personnel | _____ Failure to display overweight flag |
| _____ Failure to wear appropriate PPE | _____ Improper tarping or detarpin |
| _____ Unsafe driving practices | _____ Overweight upon arrival |
| _____ Other (specify) _____ | |

Security Guard Initials: _____
 (Indicating receipt of Wash Bay pass, if necessary)

Driver's Comments

Please print or type. (Form designed for use on elite (12-pitch) typewriter.)

Form Approved. OMB No. 2050-0039

UNIFORM HAZARDOUS WASTE MANIFEST		1. Generator ID Number NYR000058347	2. Page 1 of 1	3. Emergency Response Phone 800-424-9300	4. Manifest Tracking Number 000364566GBF				
5. Generator's Name and Mailing Address NORTHROP GRUMMAN CORP 925 SOUTH OYSTER BAY RD, MAIL STOP W16-35 BETHPAGE NY 11714				Generator's Site Address (if different than mailing address) NORTHROP GRUMMAN AEROSPACE BLVD BETHPAGE NY 11714					
Generator's Phone: (516) 575-4680				U.S. EPA ID Number NYR060097973					
6. Transporter 1 Company Name MANGIARDI TRUCKING				U.S. EPA ID Number					
7. Transporter 2 Company Name				U.S. EPA ID Number					
8. Designated Facility Name and Site Address CWM CHEMICAL SERVICES, L.L.C. 1550 BALMER RD. MODEL CITY NY 14107				U.S. EPA ID Number NYD049836679					
Facility's Phone: (716) 754-8231									
9a. HM	9b. U.S. DOT Description (including Proper Shipping Name, Hazard Class, ID Number, and Packing Group (if any))			10. Containers No. Type		11. Total Quantity	12. Unit Wt./Vol.	13. Waste Codes	
X	1. RQ, POLYCHLORINATED BIPHENYLS, SOLID MIXTURE, 9,UN3432,III NY296605			001 DT		EST 33	K	B007	
	2.								
	3.								
	4.								
14. Special Handling Instructions and Additional Information 1. NY296605 PCB Soil ERG # 171 PCB Out of Service Date 12/28/07 Weight is Section 11 is Estimated. SR# 8162115									
15. GENERATOR'S/OFFEROR'S CERTIFICATION: I hereby declare that the contents of this consignment are fully and accurately described above by the proper shipping name, and are classified, packaged, marked and labeled/placarded, and are in all respects in proper condition for transport according to applicable international and national governmental regulations. If export shipment and I am the Primary Exporter, I certify that the contents of this consignment conform to the terms of the attached EPA Acknowledgment of Consent. I certify that the waste minimization statement identified in 40 CFR 262.27(a) (if I am a large quantity generator) or (b) (if I am a small quantity generator) is true.									
Generator's/Offoror's Printed/Typed Name ABOUT FORM NORTHROP GRUMMAN Signature BRUCE EDULIAN Date 12/28/07									
16. International Shipments <input type="checkbox"/> Import to U.S. <input type="checkbox"/> Export from U.S. Port of entry/exit: _____ Date leaving U.S.: _____									
17. Transporter Acknowledgment of Receipt of Materials Transporter 1 Printed/Typed Name GARRY DAWEY Signature Garry Dawey Date 12/28/07									
Transporter 2 Printed/Typed Name _____ Signature _____ Date _____									
18. Discrepancy 18a. Discrepancy Indication Space <input checked="" type="checkbox"/> Quantity <input type="checkbox"/> Type <input type="checkbox"/> Residue <input type="checkbox"/> Partial Rejection <input type="checkbox"/> Full Rejection qty est actual rec'd 29448K Manifest Reference Number: _____ U.S. EPA ID Number _____									
18b. Alternate Facility (or Generator) _____ U.S. EPA ID Number _____									
Facility's Phone: _____									
18c. Signature of Alternate Facility (or Generator) _____ Month Day Year _____									
19. Hazardous Waste Report Management Method Codes (i.e., codes for hazardous waste treatment, disposal, and recycling systems)									
1. H132			2. _____			3. _____			4. _____
20. Designated Facility Owner or Operator: Certification of receipt of hazardous materials covered by the manifest except as noted in Item 18a									
Printed/Typed Name ELLEN CARTER Signature Ellen Carter Date 12/31/07									



Transporter Log
CWM Chemical Services, Inc.
 Model City, NY

158472

Cubic Yards

91621038
 Receipt #
 Service Reg. # PRICE TRUCKING
 Transporter Name KOKOU TOSSAH
 Driver's Name

280953-1
 Trailer License Plate # and State
 Profile # 9A-725
 Permit # 13600-2450
 Tractor/Trailer/Roll-off #
 Generator NORTHROP GREENMAN

SCALE 1 (05740 LB G)
 01:20 AM 12/27/07 11
 SCALE 2 35400 LB G
 11:15 AM 12/27/07 12

Scheduled Arrival: _____
 Date Time
 Actual Arrival: 908
 Date Time In Time Out

70540P
 31906K

Arrived during Blackout? Y / N Notified DEC? Y / N
 Leaker Permit Violation Placarding/Veh. I.D. Violation
 Other (specify _____)

Receiving:
 Initials Comments

Bulk to Landfill No wet line Flatbed Stabilization Drums Tanker Transformers

Laboratory
 Time In Time Out Initials Comments

Stabilization
 Time In Time Out Initials Gross Wt. Comments

Landfill
 Time In Time Out Initials Comments

Other
 Time In Time Out Initials Comments

Aqueous Treatment
 Time In Time Out Signature (NO Initials) Comments

Facility Personnel (please initial)

Smoking or eating in prohibited areas
 Leaving truck unattended
 Failure to obey instructions of facility personnel
 Failure to display overweight flag
 Failure to wear appropriate PPE
 Improper tarping or detarpin
 Unsafe driving practices
 Overweight upon arrival
 Other (specify _____)

Security Guard Initials: _____
 (Indicating receipt of Wash Bay pass, if necessary)

Driver's Comments

Please print or type. (Form designed for use on elite (12-pitch) typewriter.)

Form Approved. OMB No. 2050-0039

UNIFORM HAZARDOUS WASTE MANIFEST	1. Generator ID Number NYR000058347	2. Page 1 of 1	3. Emergency Response Phone 800-424-9300	4. Manifest Tracking Number 000364554GBF
---	---	--------------------------	--	--

5. Generator's Name and Mailing Address NORTHROP GRUMMAN CORP 925 SOUTH OYSTER BAY RD, MAIL STOP W16-35 BETHPAGE NY 11714	Generator's Site Address (if different than mailing address) NORTHROP GRUMMAN AEROSPACE BLVD BETHPAGE NY 11714
---	--

Generator's Phone: (516) 575-4680	6. Transporter 1 Company Name PRICE TRUCKING INC	U.S. EPA ID Number NYD046765574
---	--	---

7. Transporter 2 Company Name	U.S. EPA ID Number
-------------------------------	--------------------

8. Designated Facility Name and Site Address CWM CHEMICAL SERVICES, L.L.C. 1550 BALMER RD. MODEL CITY NY 14107	U.S. EPA ID Number NYD049836679
--	---

Facility's Phone: (716) 754-8231
--

9a. HM	9b. U.S. DOT Description (including Proper Shipping Name, Hazard Class, ID Number, and Packing Group (if any))	10. Containers		11. Total Quantity	12. Unit Wt./Vol.	13. Waste Codes		
		No.	Type					
X	1. RQ, POLYCHLORINATED BIPHENYLS, SOLID MIXTURE, 9,UN3432,III NY296605	001	DT	EST 29000	K			B007
	2.							
	3.							
	4.							

14. Special Handling Instructions and Additional Information 1. NY296605 PCB Soil ERG # 171 PCB Out of Service Date 12, 26, 07 Weight is Section 11 Is Estimated. SR# 81621038
--

15. GENERATOR'S/OFFEROR'S CERTIFICATION: I hereby declare that the contents of this consignment are fully and accurately described above by the proper shipping name, and are classified, packaged, marked and labeled/placarded, and are in all respects in proper condition for transport according to applicable international and national governmental regulations. If export shipment and I am the Primary Exporter, I certify that the contents of this consignment conform to the terms of the attached EPA Acknowledgment of Consent. I certify that the waste minimization statement identified in 40 CFR 262.27(a) (if I am a large quantity generator) or (b) (if I am a small quantity generator) is true.

Generator's/Offoror's Printed/Typed Name AGENT FOR NORTHROP GRUMMAN	Signature <i>[Signature]</i>	Month Day Year 12 26 07
---	---------------------------------	-----------------------------------

16. International Shipments <input type="checkbox"/> Import to U.S. <input type="checkbox"/> Export from U.S.	Port of entry Date leaving U.S.:
--	-------------------------------------

17. Transporter Acknowledgment of Receipt of Materials		
Transporter 1 Printed/Typed Name KOKOU TOSSAH	Signature <i>[Signature]</i>	Month Day Year 12 26 07
Transporter 2 Printed/Typed Name	Signature	Month Day Year

18. Discrepancy
18a. Discrepancy Indication Space <input checked="" type="checkbox"/> Quantity <input type="checkbox"/> Type <input type="checkbox"/> Residue <input type="checkbox"/> Partial Rejection <input type="checkbox"/> Full Rejection

18b. Alternate Facility (or Generator) qty est actual recd 31906 K	Manifest Reference Number:	U.S. EPA ID Number
--	----------------------------	--------------------

Facility's Phone:	18c. Signature of Alternate Facility (or Generator)	Month Day Year
-------------------	---	----------------

19. Hazardous Waste Report Management Method Codes (i.e., codes for hazardous waste treatment, disposal, and recycling systems)

1. H132	2.	3.	4.
----------------	----	----	----

20. Designated Facility Owner or Operator: Certification of receipt of hazardous materials covered by the manifest except as noted in Item 18a		
Printed/Typed Name EILEEN CARTER	Signature <i>[Signature]</i>	Month Day Year 12 27 07



Transporter Log
CWM Chemical Services, Inc.
 Model City, NY

158485

50
 Cubic Yards

8/62/051
 Receipt #

287083-NY
 Trailer License Plate # and State

SCALE 1 30480 LB G
 10:12 AM 12/27/07 11

Service Req. # Profile # Permit #

Driver's Name: V. Z. [unclear] Tractor/Trailer/Roll-off #: [unclear]

Driver's Name: [unclear] Generator: [unclear]

SCALE 2 34480 LB G
 11:53 AM 12/27/07 12

Scheduled Arrival:

Actual Arrival: Date: [unclear] Time: 9:51
 Date: [unclear] Time In: [unclear] Time Out: [unclear]

6906 SP
 3157 PK

Arrived during Blackout? Y / N Notified DEC? Y / N

- Leaker
- Permit Violation
- Placarding/Veh. I.D. Violation
- Other (specify _____)

Receiving: <input checked="" type="checkbox"/>	Initials	Comments

- Bulk to Landfill
- No wet line
- Flatbed
- Stabilization
- Drums
- Tanker
- Transformers

Laboratory

Time In	Time Out	Initials	Comments

Stabilization

Time In	Time Out	Initials	Gross Wt.	Comments

Landfill

Time In	Time Out	Initials	Comments

Other

Time In	Time Out	Initials	Comments

Aqueous Treatment

Time In	Time Out	Signature (NO Initials)	Comments

Facility Personnel (please initial)

- _____ Smoking or eating in prohibited areas
- _____ Leaving truck unattended
- _____ Failure to obey instructions of facility personnel
- _____ Failure to display overweight flag
- _____ Failure to wear appropriate PPE
- _____ Improper tarping or detarpin
- _____ Unsafe driving practices
- _____ Overweight upon arrival
- _____ Other (specify _____)

Security Guard Initials: _____
 (Indicating receipt of Wash Bay pass, if necessary)

Driver's Comments

Please print or type. (Form designed for use on elite (12-pitch) typewriter.)

Form Approved. OMB No. 2050-0039

UNIFORM HAZARDOUS WASTE MANIFEST		1. Generator ID Number NYR000058347	2. Page 1 of 1	3. Emergency Response Phone 800-424-9306	4. Manifest Tracking Number 000364555GBF	
5. Generator's Name and Mailing Address NORTHROP GRUMMAN CORP 925 SOUTH OYSTER BAY RD. MAIL STOP W16-35 BETHPAGE NY 11714				Generator's Site Address (if different than mailing address) NORTHROP GRUMMAN AEROSPACE BLVD BETHPAGE NY 11714		
Generator's Phone: (516) 575-4680						
6. Transporter 1 Company Name PRICE TRUCKING				U.S. EPA ID Number NYD046765574		
7. Transporter 2 Company Name				U.S. EPA ID Number		
8. Designated Facility Name and Site Address CWM CHEMICAL SERVICES, L.L.C. 1550 BALMER RD. MODEL CITY NY 14107				U.S. EPA ID Number NYD049836679		
Facility's Phone: (716) 754-8231						
9a. HM	9b. U.S. DOT Description (including Proper Shipping Name, Hazard Class, ID Number, and Packing Group (if any))	10. Containers		11. Total Quantity	12. Unit Wt./Vol.	13. Waste Codes
		No.	Type			
X	RO, POLYCHLORINATED BIPHENYLS, SOLID MIXTURE, 9, UN3432, III NY296605	001	DT	EST 1950K	K	B007
14. Special Handling Instructions and Additional Information 1. NY296605 PCB Soil ERG # 171 PCB Out of Service Date 12/26/07 Weight is Section 11 Is Estimated. SR# 816-21051						
15. GENERATOR'S/OFFEROR'S CERTIFICATION: I hereby declare that the contents of this consignment are fully and accurately described above by the proper shipping name, and are classified, packaged, marked and labeled/placarded, and are in all respects in proper condition for transport according to applicable international and national governmental regulations. If export shipment and I am the Primary Exporter, I certify that the contents of this consignment conform to the terms of the attached EPA Acknowledgment of Consent. I certify that the waste minimization statement identified in 40 CFR 262.27(a) (if I am a large quantity generator) or (b) (if I am a small quantity generator) is true.						
Generator's/Offeror's Printed/Typed Name AGREIT FOR NORTHROP GRUMMAN EULIAN				Signature <i>[Signature]</i>		Month Day Year 12/26/07
16. International Shipments <input type="checkbox"/> Import to U.S. <input type="checkbox"/> Export from U.S. Port of entry/exit: _____ Transporter signature (for exports only): _____ Date leaving U.S.: _____						
17. Transporter Acknowledgment of Receipt of Materials						
Transporter 1 Printed/Typed Name Vasily Zinkiv				Signature <i>[Signature]</i>		Month Day Year 12/26/07
Transporter 2 Printed/Typed Name				Signature		Month Day Year
18. Discrepancy						
18a. Discrepancy Indication Space <input checked="" type="checkbox"/> Quantity <input type="checkbox"/> Type <input type="checkbox"/> Residue <input type="checkbox"/> Partial Rejection <input type="checkbox"/> Full Rejection						
qty list actual recd 31598K						Manifest Reference Number:
18b. Alternate Facility (or Generator)				U.S. EPA ID Number		
Facility's Phone:						
18c. Signature of Alternate Facility (or Generator)						Month Day Year
19. Hazardous Waste Report Management Method Codes (i.e., codes for hazardous waste treatment, disposal, and recycling systems)						
1. H132	2.	3.	4.			
20. Designated Facility Owner or Operator: Certification of receipt of hazardous materials covered by the manifest except as noted in Item 18a						
Printed/Typed Name EULIAN CARTON				Signature <i>[Signature]</i>		Month Day Year 12/27/07



Transporter Log
CWM Chemical Services, Inc.
 Model City, NY

158488

Cubic Yards

81621054

Receipt #

Trailer License Plate # and State

SCALE 1 105200 LB G
 10:54 AM 12/27/07 11

Service Req. # Profile # Permit #

Transporter Name Tractor/Trailer/Roll-off #

Driver's Name Generator

SCALE 2 34840 LB G
 12:13 PM 12/27/07 12

Scheduled Arrival:

Actual Arrival: Date Time
 Date Time In Time Out

704JOP
 31142K

Arrived during Blackout? Y / N Notified DEC? Y / N

- Leaker
- Permit Violation
- Placarding/Veh. I.D. Violation
- Other (specify _____)

Receiving: <u>V</u>	Initials	Comments
---------------------	----------	----------

- Bulk to Landfill
- No wet line
- Flatbed
- Stabilization
- Drums
- Tanker
- Transformers

Laboratory

Time In Time Out Initials Comments

Stabilization

Time In Time Out Initials Gross Wt. Comments

Landfill

Time In Time Out Initials Comments

Other

Time In Time Out Initials Comments

Aqueous Treatment

Time In Time Out Signature (NO Initials) Comments

Facility Personnel (please initial)

- _____ Smoking or eating in prohibited areas
- _____ Leaving truck unattended
- _____ Failure to obey instructions of facility personnel
- _____ Failure to display overweight flag
- _____ Failure to wear appropriate PPE
- _____ Improper tarping or detarpin
- _____ Unsafe driving practices
- _____ Overweight upon arrival
- _____ Other (specify _____)

Security Guard Initials: _____
 (Indicating receipt of Wash Bay pass, if necessary)

Driver's Comments

Please print or type. (Form designed for use on elite (12-pitch) typewriter.)

Form Approved. OMB No. 2050-0039

UNIFORM HAZARDOUS WASTE MANIFEST		1. Generator ID Number NYR000058347	2. Page 1 of 1	3. Emergency Response Phone 800-424-9300	4. Manifest Tracking Number 000364556GBF	
5. Generator's Name and Mailing Address NORTHROP GRUMMAN CORP 925 SOUTH OYSTER BAY RD, MAIL STOP W16-35 BETHPAGE NY 11714			Generator's Site Address (if different than mailing address) NORTHROP GRUMMAN AEROSPACE BLVD BETHPAGE NY 11714			
Generator's Phone: (516) 575-4680			U.S. EPA ID Number NYD046765574			
6. Transporter 1 Company Name PRICO TRUCKING			U.S. EPA ID Number			
7. Transporter 2 Company Name			U.S. EPA ID Number			
8. Designated Facility Name and Site Address CWM CHEMICAL SERVICES, L.L.C. 1550 BALMER RD. MODEL CITY NY 14107			U.S. EPA ID Number NYD049836679			
Facility's Phone: (716) 754-8231						
9a. HM	9b. U.S. DOT Description (including Proper Shipping Name, Hazard Class, ID Number, and Packing Group (if any))	10. Containers No.	Type	11. Total Quantity	12. Unit Wt./Vol.	13. Waste Codes
X	RO, POLYCHLORINATED BIPHENYLS, SOLID MIXTURE, 9,UN3432,III NY296605	001	DT	EST 19950K	K	B007
14. Special Handling Instructions and Additional Information 1. NY296605 PCB Sol ERG # 171 PCB Out of Service Date <u>12/26/07</u> Weight in Section 11 is Estimated. SR# _____ <u>81621054</u>						
15. GENERATOR'S/OFFEROR'S CERTIFICATION: I hereby declare that the contents of this consignment are fully and accurately described above by the proper shipping name, and are classified, packaged, marked and labeled/placarded, and are in all respects in proper condition for transport according to applicable International and national governmental regulations. If export shipment and I am the Primary Exporter, I certify that the contents of this consignment conform to the terms of the attached EPA Acknowledgment of Consent. I certify that the waste minimization statement identified in 40 CFR 262.27(a) (if I am a large quantity generator) or (b) (if I am a small quantity generator) is true.						
Generator's/Offeror's Printed/Typed Name AGENT FOR NORTHROP GRUMMAN Signature BRUCE ELLIEN Month Day Year 12 26 07						
16. International Shipments <input type="checkbox"/> Import to U.S. <input type="checkbox"/> Export from U.S. Port of entry/exit: _____ Transporter signature (for exports only): _____ Date leaving U.S.: _____						
17. Transporter Acknowledgment of Receipt of Materials						
Transporter 1 Printed/Typed Name Signature Month Day Year PAVEL ZINKIV PAVEL ZINKIV 12 26 07						
Transporter 2 Printed/Typed Name Signature Month Day Year						
18. Discrepancy						
18a. Discrepancy Indication Space <input checked="" type="checkbox"/> Quantity <input type="checkbox"/> Type <input type="checkbox"/> Residue <input type="checkbox"/> Partial Rejection <input type="checkbox"/> Full Rejection qty not actual recd 31942K Manifest Reference Number: _____						
18b. Alternate Facility (or Generator) U.S. EPA ID Number						
Facility's Phone: _____						
18c. Signature of Alternate Facility (or Generator) Month Day Year						
19. Hazardous Waste Report Management Method Codes (i.e., codes for hazardous waste treatment, disposal, and recycling systems)						
1. H132		2. _____		3. _____		4. _____
20. Designated Facility Owner or Operator: Certification of receipt of hazardous materials covered by the manifest except as noted in Item 18a						
Printed/Typed Name Signature Month Day Year ELLEN CARTER ELLEN CARTER 12 27 07						



Transporter Log
CWM Chemical Services, Inc.
 Model City, NY

158480

50
 Cubic Yards

81621046

2801B3 NJ

Receipt #

Trailer License Plate # and State

SCALE 1 11:50 AM 12/27/07 11
 11:50 AM 12/27/07 11

Service Req. #

Profile #

Permit #

PRICE

D800-2500

Transporter Name

Tractor/Trailer/Roll-off #

IUAN Z

Northrop Gummery

Driver's Name

Generator

SCALE 2 34240 LB G
 11:58 AM 12/27/07 12

Scheduled Arrival:

Date

Time

Actual Arrival:

Date

Time In

Time Out

9:32

74820 P

33938K

Arrived during Blackout? Y / N

Notified DEC? Y / N

Leaker Permit Violation Placarding/Veh. I.D. Violation

Other (specify _____)

Receiving:

Initials

Comments

Bulk to Landfill No wet line Flatbed Stabilization Drums Tanker Transformers

Laboratory

Time In

Time Out

Initials

Comments

Stabilization

Time In

Time Out

Initials

Gross Wt.

Comments

Landfill

Time In

Time Out

Initials

Comments

Other

Time In

Time Out

Initials

Comments

Aqueous Treatment

Time In

Time Out

Signature (NO Initials)

Comments

Facility Personnel (please initial)

_____ Smoking or eating in prohibited areas

_____ Leaving truck unattended

_____ Failure to obey instructions of facility personnel

_____ Failure to display overweight flag

_____ Failure to wear appropriate PPE

_____ Improper tarping or detarpin

_____ Unsafe driving practices

_____ Overweight upon arrival

_____ Other (specify _____)

Security Guard Initials: _____

(Indicating receipt of Wash Bay pass, if necessary)

Driver's Comments

White: Records

Green & Canary: Accs Rec.

Pink: Environmental

Goldenrod: Driver

Please print or type. (Form designed for use on elite (12-pitch) typewriter.)

Form Approved. OMB No. 2050-0039

UNIFORM HAZARDOUS WASTE MANIFEST		1. Generator ID Number NYR000058347	2. Page 1 of 1	3. Emergency Response Phone 800-424-9300	4. Manifest Tracking Number 000364557GBF		
5. Generator's Name and Mailing Address NORTHROP GRUMMAN CORP 925 SOUTH OYSTER BAY RD, MAIL STOP W16-35 BETHPAGE NY 11714			Generator's Site Address (if different than mailing address) NORTHROP GRUMMAN AEROSPACE BLVD BETHPAGE NY 11714				
Generator's Phone: (516) 575-4680							
6. Transporter 1 Company Name PRICE TRUCKING				U.S. EPA ID Number NYD046765574			
7. Transporter 2 Company Name				U.S. EPA ID Number			
8. Designated Facility Name and Site Address CWM CHEMICAL SERVICES, L.L.C. 1550 BALMER RD. MODEL CITY NY 14107				U.S. EPA ID Number NYD049836679			
Facility's Phone: (716) 754-8231							
9a. HM	9b. U.S. DOT Description (including Proper Shipping Name, Hazard Class, ID Number, and Packing Group (if any))	10. Containers		11. Total Quantity	12. Unit Wt./Vol.	13. Waste Codes	
		No.	Type				
X	1. RQ, POLYCHLORINATED BIPHENYLS, SOLID MIXTURE, 9, UN3432, III NY296605	001	DT	EST 27215	K	B007	
14. Special Handling Instructions and Additional Information 1. NY296605 PCB Soil ERG # 171 PCB Out of Service Date <u>12/26/07</u> Weight in Section 11 is Estimated. SR# <u>81621046</u> <u>Beed 33938K</u>							
15. GENERATOR'S/OFFEROR'S CERTIFICATION: I hereby declare that the contents of this consignment are fully and accurately described above by the proper shipping name, and are classified, packaged, marked and labeled/placarded, and are in all respects in proper condition for transport according to applicable international and national governmental regulations. If export shipment and I am the Primary Exporter, I certify that the contents of this consignment conform to the terms of the attached EPA Acknowledgment of Consent. I certify that the waste minimization statement identified in 40 CFR 262.27(a) (if I am a large quantity generator) or (b) (if I am a small quantity generator) is true.							
Generator's/Offeor's Printed/Typed Name ABOUT FOR NORTHROP GRUMMAN EULIAN			Signature <i>[Signature]</i>		Month 12	Day 26	Year 07
16. International Shipments <input type="checkbox"/> Import to U.S. <input type="checkbox"/> Export from U.S. Port of entry/exit: _____ Date leaving U.S.: _____							
17. Transporter Acknowledgment of Receipt of Materials							
Transporter 1 Printed/Typed Name IVAN ZUKIU			Signature <i>[Signature]</i>		Month 12	Day 26	Year 07
Transporter 2 Printed/Typed Name			Signature		Month	Day	Year
18. Discrepancy							
18a. Discrepancy Indication Space <input type="checkbox"/> Quantity <input type="checkbox"/> Type <input type="checkbox"/> Residue <input type="checkbox"/> Partial Rejection <input type="checkbox"/> Full Rejection							
Manifest Reference Number: _____							
18b. Alternate Facility (or Generator)				U.S. EPA ID Number			
Facility's Phone: _____							
18c. Signature of Alternate Facility (or Generator)					Month	Day	Year
19. Hazardous Waste Report Management Method Codes (i.e., codes for hazardous waste treatment, disposal, and recycling systems)							
1. H132	2.	3.	4.				
20. Designated Facility Owner or Operator. Certification of receipt of hazardous materials covered by the manifest except as noted in Item 18a							
Printed/Typed Name EULIAN CARTER			Signature <i>[Signature]</i>		Month 12	Day 27	Year 07



Transporter Log
CWM Chemical Services, Inc.
 Model City, NY

158477

Cubic Yards

81621043

AC96628 NY
 Trailer License Plate # and State

Receipt #

Service Req. #

Profile #

Permit #

Transporter Name

Tractor/Trailer/Roll-off #

Driver's Name

Generator

SCALE 1 30900 LB G

09:40 AM 12/27/07 D

SCALE 2 38300 LB G

11:31 AM 12/27/07 T2

52520P

23523K

Scheduled Arrival:

Date

Time

Actual Arrival:

Date

Time In

Time Out

Arrived during Blackout? Y / N

Notified DEC? Y / N

Leaker

Permit Violation

Placarding/Veh. I.D. Violation

Other (specify)

Bulk to Landfill

No wet line

Flatbed

Stabilization

Drums

Tanker

Transformers

Receiving:

Initials

Comments

Laboratory

Time In

Time Out

Initials

Comments

Stabilization

Time In

Time Out

Initials

Gross Wt.

Comments

Landfill

Time In

Time Out

Initials

Comments

Other

Time In

Time Out

Initials

Comments

Aqueous Treatment

Time In

Time Out

Signature (NO Initials)

Comments

Facility Personnel (please initial)

Smoking or eating in prohibited areas

Leaving truck unattended

Failure to obey instructions of facility personnel

Failure to display overweight flag

Failure to wear appropriate PPE

Improper tarping or detarplin

Unsafe driving practices

Overweight upon arrival

Other (specify)

Security Guard Initials:

(Indicating receipt of Wash Bay pass, if necessary)

Driver's Comments

White: Records

Green & Canary: Accts Rec.

Pink: Environmental

Goldenrod: Driver

Please print or type. (Form designed for use on elite (12-pitch) typewriter.)

Form Approved. OMB No. 2050-0039

UNIFORM HAZARDOUS WASTE MANIFEST		1. Generator ID Number NYR000058347	2. Page 1 of 1	3. Emergency Response Phone 800-424-9300	4. Manifest Tracking Number 000364558GBF	
5. Generator's Name and Mailing Address NORTHROP GRUMMAN CORP 925 SOUTH OYSTER BAY RD, MAIL STOP W16-35 BETHPAGE NY 11714			Generator's Site Address (if different than mailing address) NORTHROP GRUMMAN AEROSPACE BLVD BETHPAGE NY 11714			
Generator's Phone: (516) 575-4680						
6. Transporter 1 Company Name MANGIARDI TRUCKING			U.S. EPA ID Number NYR000097972			
7. Transporter 2 Company Name			U.S. EPA ID Number			
8. Designated Facility Name and Site Address CWM CHEMICAL SERVICES, L.L.C. 1550 BALMER RD. MODEL CITY NY 14107			U.S. EPA ID Number NYD049836679			
Facility's Phone: (716) 754-8231						
9a. HM	9b. U.S. DOT Description (including Proper Shipping Name, Hazard Class, ID Number, and Packing Group (if any))	10. Containers		11. Total Quantity	12. Unit Wt./Vol.	13. Waste Codes
		No.	Type			
X	1. RQ, POLYCHLORINATED BIPHENYLS, SOLID MIXTURE, 9, UN3432, III NY296605	001	DT	EST 2725K	K	B007
	2.					
	3.					
	4.					
14. Special Handling Instructions and Additional Information 1. NY296605 PCB Soil ERG # 171 PCB Out of Service Date 12/26/07 Weight in Section 11 is Estimated. SR# 81621043						
15. GENERATOR'S/OFFEROR'S CERTIFICATION: I hereby declare that the contents of this consignment are fully and accurately described above by the proper shipping name, and are classified, packaged, marked and labeled/placarded, and are in all respects in proper condition for transport according to applicable international and national governmental regulations. If export shipment and I am the Primary Exporter, I certify that the contents of this consignment conform to the terms of the attached EPA Acknowledgment of Consent. I certify that the waste minimization statement identified in 40 CFR 262.27(a) (if I am a large quantity generator) or (b) (if I am a small quantity generator) is true.						
Generator's/Offeror's Printed/Typed Name AGENT FOR NORTHROP GRUMMAN Signature BRUCE EOLIAN Signature Agent for Northrop Grumman Signature Month Day Year 12 26 07						
16. International Shipments <input type="checkbox"/> Import to U.S. <input type="checkbox"/> Export from U.S. Port of entry/exit: _____ Date leaving U.S.: _____						
17. Transporter Acknowledgment of Receipt of Materials						
Transporter 1 Printed/Typed Name GARRY DAURY			Signature Garry Daury		Month Day Year 12 26 07	
Transporter 2 Printed/Typed Name			Signature		Month Day Year	
18. Discrepancy						
18a. Discrepancy Indication Space <input checked="" type="checkbox"/> Quantity <input type="checkbox"/> Type <input type="checkbox"/> Residue <input type="checkbox"/> Partial Rejection <input type="checkbox"/> Full Rejection Qty est actual recd 23823K						
18b. Alternate Facility (or Generator) Manifest Reference Number: U.S. EPA ID Number						
Facility's Phone:						
18c. Signature of Alternate Facility (or Generator) Month Day Year						
19. Hazardous Waste Report Management Method Codes (i.e., codes for hazardous waste treatment, disposal, and recycling systems)						
1. H132		2.		3.		4.
20. Designated Facility Owner or Operator: Certification of receipt of hazardous materials covered by the manifest except as noted in Item 18a						
Printed/Typed Name ELLEN CARTER			Signature Ellen Carter		Month Day Year 12 27 07	



Transporter Log
CWM Chemical Services, Inc.
 Model City, NY

158478

Cubic Yards

81621044
 Receipt #

AC21075 NY
 Trailer License Plate # and State

M296055 4A-209
 Service Req. # Profile # Permit #

Maugeri Bros
 Transporter Name

Joe Bell
 Driver's Name

50-31
 Tractor/Trailer/Roll-off #

Northrop Grumman Corp
 Generator

SCALE 1 100100 LB G
 09:43 AM 12/27/07 11

SCALE 2 37700 LB G
 11:34 AM 12/27/07 12

69320P
 37790K

Scheduled Arrival: _____
 Date Time

Actual Arrival: _____
 Date Time In Time Out

Arrived during Blackout? Y / N Notified DEC? Y / N

- Leaker Permit Violation Placarding/Veh. I.D. Violation
- Other (specify _____)

Receiving: <input checked="" type="checkbox"/>
Initials _____
Comments _____

- Bulk to Landfill No wet line Flatbed Stabilization Drums Tanker Transformers

Laboratory

Time In	Time Out	Initials	Comments

Stabilization

Time In	Time Out	Initials	Gross Wt.	Comments

Landfill

Time In	Time Out	Initials	Comments

Other

Time In	Time Out	Initials	Comments

Aqueous Treatment

Time In	Time Out	Signature (NO Initials)	Comments

Facility Personnel (please initial)

- | | |
|--|--|
| _____ Smoking or eating in prohibited areas | _____ Leaving truck unattended |
| _____ Failure to obey instructions of facility personnel | _____ Failure to display overweight flag |
| _____ Failure to wear appropriate PPE | _____ Improper tarping or detarpin |
| _____ Unsafe driving practices | _____ Overweight upon arrival |
| _____ Other (specify) _____ | |

Security Guard Initials: _____
 (Indicating receipt of Wash Bay pass, if necessary)

Driver's Comments

Please print or type. (Form designed for use on elite (12-pitch) typewriter.)

Form Approved. OMB No. 2050-0039

UNIFORM HAZARDOUS WASTE MANIFEST		1. Generator ID Number NYR000058347	2. Page 1 of 1	3. Emergency Response Phone 800-421-9300	4. Manifest Tracking Number 000364559GBF		
5. Generator's Name and Mailing Address NORTHROP GRUMMAN CORP 925 SOUTH OYSTER BAY RD, MAIL STOP W16-35 BETHPAGE NY 11714				Generator's Site Address (if different than mailing address) NORTHROP GRUMMAN AEROSPACE BLVD BETHPAGE NY 11714			
Generator's Phone: (516) 575-4680							
6. Transporter 1 Company Name MANGIARDI TRUCKING					U.S. EPA ID Number NYR000099972		
7. Transporter 2 Company Name					U.S. EPA ID Number		
8. Designated Facility Name and Site Address CWM CHEMICAL SERVICES, L.L.C. 1550 BALMER RD. MODEL CITY NY 14107					U.S. EPA ID Number NYD049836679		
Facility's Phone: (716) 754-8231							
9a. HM	9b. U.S. DOT Description (including Proper Shipping Name, Hazard Class, ID Number, and Packing Group (if any))	10. Containers		11. Total Quantity	12. Unit Wt./Vol.	13. Waste Codes	
		No.	Type				
X	1. RQ, POLYCHLORINATED BIPHENYLS, SOLID MIXTURE, 9, UN3432, III NY296605	001	DT	EST 2725K	K		B007
	2.						
	3.						
	4.						
14. Special Handling Instructions and Additional Information 1. NY296605 PCB Soil ERG # 171 PCB Out of Service Date 12/26/07 Weight is Section 11 is Estimated. SR# 81621044							
15. GENERATOR'S/OFFEROR'S CERTIFICATION: I hereby declare that the contents of this consignment are fully and accurately described above by the proper shipping name, and are classified, packaged, marked and labeled/placarded, and are in all respects in proper condition for transport according to applicable international and national governmental regulations. If export shipment and I am the Primary Exporter, I certify that the contents of this consignment conform to the terms of the attached EPA Acknowledgment of Consent. I certify that the waste minimization statement identified in 40 CFR 262.27(a) (if I am a large quantity generator) or (b) (if I am a small quantity generator) is true.							
Generator's/Offeror's Printed/Typed Name AGENT FOR NORTHROP GRUMMAN BRUCE ELLIOTT					Signature <i>Bruce Elliott</i>		
					Month Day Year 12 26 07		
16. International Shipments <input type="checkbox"/> Import to U.S. <input type="checkbox"/> Export from U.S. Part of entry/exit: _____ Date leaving U.S.: _____							
17. Transporter Acknowledgment of Receipt of Materials							
Transporter 1 Printed/Typed Name Joe Bell					Signature <i>Joe Bell</i>		
Transporter 2 Printed/Typed Name					Month Day Year 12 26 07		
18. Discrepancy							
18a. Discrepancy Indication Space <input checked="" type="checkbox"/> Quantity <input type="checkbox"/> Type <input type="checkbox"/> Residue <input type="checkbox"/> Partial Rejection <input type="checkbox"/> Full Rejection							
qty est actual recd 30990K							
18b. Alternate Facility (or Generator)					U.S. EPA ID Number		
Facility's Phone:							
18c. Signature of Alternate Facility (or Generator)					Month Day Year		
19. Hazardous Waste Report Management Method Codes (i.e., codes for hazardous waste treatment, disposal, and recycling systems)							
1. H132		2.		3.		4.	
20. Designated Facility Owner or Operator: Certification of receipt of hazardous materials covered by the manifest except as noted in item 18a							
Printed/Typed Name EILEEN CARTER					Signature <i>Eileen Carter</i>		
					Month Day Year 12 27 07		



Transporter Log
CWM Chemical Services, Inc.
 Model City, NY

158598

50
 Cubic Yards

81621163 Receipt # 287083-11 Trailer License Plate # and State

SCALE 1 103440 LB G
 10:07 AM 12/31/07 12

NY210605 Service Req. # Profile # Permit #

Transporter Name Tractor/Trailer/Roll-off #

SCALE 2 34160 LB G
 11:32 AM 12/31/07 12

Driver's Name Generator

Scheduled Arrival: _____

Actual Arrival: _____
 Date Time Date Time In Time Out

69280P
 31425K

Arrived during Blackout? Y / N Notified DEC? Y / N

Leaker Permit Violation Placarding/Veh. I.D. Violation

Other (specify _____)

Receiving: _____
 Initials Comments

Bulk to Landfill No wet line Flatbed Stabilization Drums Tanker Transformers

Laboratory
 Time In Time Out Initials Comments

Stabilization
 Time In Time Out Initials Gross Wt. Comments

Landfill
 Time In Time Out Initials Comments

Other
 Time In Time Out Initials Comments

Aqueous Treatment
 Time In Time Out Signature (NO Initials) Comments

Facility Personnel (please initial)

- _____ Smoking or eating in prohibited areas
- _____ Failure to obey instructions of facility personnel
- _____ Failure to wear appropriate PPE
- _____ Unsafe driving practices
- _____ Other (specify) _____
- _____ Leaving truck unattended
- _____ Failure to display overweight flag
- _____ Improper tarping or detarpin
- _____ Overweight upon arrival

Security Guard Initials: _____
 (Indicating receipt of Wash Bay pass, if necessary)

Please print or type. (Form designed for use on elite (12-pitch) typewriter.)

Form Approved. OMB No. 2050-0039

UNIFORM HAZARDOUS WASTE MANIFEST		1. Generator ID Number NYR000058347	2. Page 1 of 1	3. Emergency Response Phone 800-424-9300	4. Manifest Tracking Number 000364567GBF	
5. Generator's Name and Mailing Address NORTHROP GRUMMAN CORP 925 SOUTH OYSTER BAY RD, MAIL STOP W16-35 BETHPAGE NY 11714			Generator's Site Address (if different than mailing address) NORTHROP GRUMMAN AEROSPACE BLVD BETHPAGE NY 11714			
Generator's Phone: (516) 575-4680						
6. Transporter 1 Company Name PRICE TRUCKING				U.S. EPA ID Number NYD046765574		
7. Transporter 2 Company Name				U.S. EPA ID Number		
8. Designated Facility Name and Site Address CWM CHEMICAL SERVICES, L.L.C. 1550 BALMER RD. MODEL CITY NY 14107			U.S. EPA ID Number NYD049836679			
Facility's Phone: (716) 754-8231						
9a. HM	9b. U.S. DOT Description (including Proper Shipping Name, Hazard Class, ID Number, and Packing Group (if any))	10. Containers		11. Total Quantity	12. Unit Wt./Vol.	13. Waste Codes
		No.	Type			
X	1. RQ. POLYCHLORINATED BIPHENYLS, SOLID MIXTURE, 9,UN3432,III NY296605	001	DT	EST 27215	K	B007
	2.					
	3.					
	4.					
14. Special Handling Instructions and Additional Information 1. NY296605 PCB Soil ERG #171 PCB Out of Service Date 12/28/07 Weight is Section 11 is Estimated. SR# 81621163						
15. GENERATOR'S/OFFEROR'S CERTIFICATION: I hereby declare that the contents of this consignment are fully and accurately described above by the proper shipping name, and are classified, packaged, marked and labeled/placarded, and are in all respects in proper condition for transport according to applicable international and national governmental regulations. If export shipment and I am the Primary Exporter, I certify that the contents of this consignment conform to the terms of the attached EPA Acknowledgment of Consent. I certify that the waste minimization statement identified in 40 CFR 262.27(a) (if I am a large quantity generator) or (b) (if I am a small quantity generator) is true.						
Generator's/Offeror's Printed/Typed Name AGENT FOR NORTHROP GRUMMAN Signature BRUCE ELLIEN Signature Northrop Grumman Signature Month Day Year 12 28 07						
16. International Shipments <input type="checkbox"/> Import to U.S. <input type="checkbox"/> Export from U.S. Port of entry/exit: _____ Date leaving U.S.: _____						
17. Transporter Acknowledgment of Receipt of Materials						
Transporter 1 Printed/Typed Name Vasily Zinkov Signature Vasily Zinkov Signature Month Day Year 12 28 07						
Transporter 2 Printed/Typed Name Signature Month Day Year						
18. Discrepancy						
18a. Discrepancy Indication Space <input checked="" type="checkbox"/> Quantity <input type="checkbox"/> Type <input type="checkbox"/> Residue <input type="checkbox"/> Partial Rejection <input type="checkbox"/> Full Rejection qty est actual recd						
18b. Alternate Facility (or Generator) Manifest Reference Number: _____ U.S. EPA ID Number _____						
Facility's Phone: _____						
18c. Signature of Alternate Facility (or Generator) Month Day Year						
19. Hazardous Waste Report Management Method Codes (i.e., codes for hazardous waste treatment, disposal, and recycling systems)						
1. H132		2.		3.		4.
20. Designated Facility Owner or Operator. Certification of receipt of hazardous materials covered by the manifest except as noted in Item 18a						
Printed/Typed Name EILEEN CARTON Signature Eileen Carton Signature Month Day Year 12 31 07						



Transporter Log
CWM Chemical Services, Inc.
 Model City, NY

158479

Cubic Yards

91621045 Receipt # AC 96590 NY Trailer License Plate # and State

Service Req. # Profile # Permit #
 Transporter Name/Tractor/Trailer/Roll-off #
 Driver's Name Generator

SCALE 1 37400 LB G
 09:40 AM 12/27/07 11
 SCALE 2 37660 LB G
 11:52 AM 12/27/07 12
 59740P
 27078K

Scheduled Arrival: _____
 Actual Arrival: _____
 Date Time Date Time In Time Out

Arrived during Blackout? Y / N Notified DEC? Y / N

- Leaker
- Permit Violation
- Placarding/Veh. I.D. Violation
- Other (specify _____)

Receiving: <input checked="" type="checkbox"/>	Initials	Comments

- Bulk to Landfill
- No wet line
- Flatbed
- Stabilization
- Drums
- Tanker
- Transformers

Laboratory
 Time In Time Out Initials Comments

Stabilization
 Time In Time Out Initials Gross Wt. Comments

Landfill
 Time In Time Out Initials Comments

Other
 Time In Time Out Initials Comments

Aqueous Treatment
 Time In Time Out Signature (NO Initials) Comments

Facility Personnel (please initial)

- _____ Smoking or eating in prohibited areas
- _____ Leaving truck unattended
- _____ Failure to obey instructions of facility personnel
- _____ Failure to display overweight flag
- _____ Failure to wear appropriate PPE
- _____ Improper tarping or detarplin
- _____ Unsafe driving practices
- _____ Overweight upon arrival
- _____ Other (specify _____)

Security Guard Initials: _____
 (Indicating receipt of Wash Bay pass, if necessary)

Driver's Comments

Please print or type. (Form designed for use on elite (12-pitch) typewriter.)

Form Approved. OMB No. 2050-0039

UNIFORM HAZARDOUS WASTE MANIFEST	1. Generator ID Number NYR000058347	2. Page 1 of 1	3. Emergency Response Phone 900-424-9300	4. Manifest Tracking Number 000364560GBF
---	---	--------------------------	--	--

5. Generator's Name and Mailing Address NORTHROP GRUMMAN CORP 925 SOUTH OYSTER BAY RD, MAIL STOP W16-35 BETHPAGE NY 11714	Generator's Site Address (if different than mailing address) NORTHROP GRUMMAN AEROSPACE BLVD BETHPAGE NY 11714
Generator's Phone: (516) 575-4680	

6. Transporter 1 Company Name MANGIARDI TRUCKING	U.S. EPA ID Number NYR000097772
--	---

7. Transporter 2 Company Name	U.S. EPA ID Number
-------------------------------	--------------------

8. Designated Facility Name and Site Address CWM CHEMICAL SERVICES, L.L.C. 1550 BALMER RD. MODEL CITY NY 14107	U.S. EPA ID Number NYD049836679
Facility's Phone: (716) 754-8231	

9a. HM	9b. U.S. DOT Description (including Proper Shipping Name, Hazard Class, ID Number, and Packing Group (if any))	10. Containers		11. Total Quantity	12. Unit Wt./Vol.	13. Waste Codes		
		No.	Type					
X	1. RQ, POLYCHLORINATED BIPHENYLS, SOLID MIXTURE, 9,UN3432,III NY296605	001	DT	EST 2705K	K	B007		
2.								
3.								
4.								

14. Special Handling Instructions and Additional Information 1. NY296605 PCB Soil ERG # 171	
PCB Out of Service Date 12/26/07	Weight in Section 11 is Estimated. SR# Beed 27098K

15. GENERATOR'S/OFFEROR'S CERTIFICATION: I hereby declare that the contents of this consignment are fully and accurately described above by the proper shipping name, and are classified, packaged, marked and labeled/placarded, and are in all respects in proper condition for transport according to applicable international and national governmental regulations. If export shipment and I am the Primary Exporter, I certify that the contents of this consignment conform to the terms of the attached EPA Acknowledgment of Consent. I certify that the waste minimization statement identified in 40 CFR 262.27(a) (if I am a large quantity generator) or (b) (if I am a small quantity generator) is true.

Generator's/Offeror's Printed/Typed Name AGENT FOR NORTHROP GRUMMAN ERG & ENVIRONMENTAL SERVICES	Signature <i>[Signature]</i>	Month 12	Day 26	Year 07
--	---------------------------------	--------------------	------------------	-------------------

16. International Shipments <input type="checkbox"/> Import to U.S. <input type="checkbox"/> Export from U.S.	Port of entry/exit: Date leaving U.S.:
--	---

17. Transporter Acknowledgment of Receipt of Materials				
Transporter 1 Printed/Typed Name Rich Dunham	Signature <i>[Signature]</i>	Month 12	Day 26	Year 07
Transporter 2 Printed/Typed Name	Signature	Month	Day	Year

18. Discrepancy					
18a. Discrepancy Indication Space	<input type="checkbox"/> Quantity	<input type="checkbox"/> Type	<input type="checkbox"/> Residue	<input type="checkbox"/> Partial Rejection	<input type="checkbox"/> Full Rejection

18b. Alternate Facility (or Generator)	Manifest Reference Number:	U.S. EPA ID Number
--	----------------------------	--------------------

Facility's Phone:	18c. Signature of Alternate Facility (or Generator)	Month	Day	Year
-------------------	---	-------	-----	------

19. Hazardous Waste Report Management Method Codes (i.e., codes for hazardous waste treatment, disposal, and recycling systems)			
1. H132	2.	3.	4.

20. Designated Facility Owner or Operator. Certification of receipt of hazardous materials covered by the manifest except as noted in item 18a				
Printed/Typed Name Ellen Carter	Signature <i>[Signature]</i>	Month 12	Day 27	Year 07



Transporter Log
CWM Chemical Services, Inc.
 Model City, NY

158597

30
 Cubic Yards

816211602 280123 NY
 Receipt # Trailer License Plate # and State
 NY 210665
 Service Req. # Profile # Permit #
 DRIVE 12800-2500
 Transporter Name Tractor/Trailer/Roll-off #
 NAN 2 Drummer
 Driver's Name Generator

SCALE 1 104460 LB G
 10:03 AM 12/31/07 12
 SCALE 2 34040 LB G
 11:13 AM 12/31/07 12

Scheduled Arrival: _____
 Actual Arrival: _____
 Date Time Date Time In Time Out

70470P
 31942K

Arrived during Blackout? Y / N Notified DEC? Y / N

- Leaker Permit Violation Placarding/Veh. I.D. Violation
 Other (specify _____)

Receiving: _____
 Initials Comments

- Bulk to Landfill No wet line Flatbed Stabilization Drums Tanker Transformers

Laboratory _____
 Time In Time Out Initials Comments

Stabilization _____
 Time In Time Out Initials Gross Wt. Comments

Landfill _____
 Time In Time Out Initials Comments

Other _____
 Time In Time Out Initials Comments

Aqueous Treatment _____
 Time In Time Out Signature (NO Initials) Comments

Facility Personnel (please initial)

- | | |
|--|--|
| _____ Smoking or eating in prohibited areas | _____ Leaving truck unattended |
| _____ Failure to obey instructions of facility personnel | _____ Failure to display overweight flag |
| _____ Failure to wear appropriate PPE | _____ Improper tarping or detarpin |
| _____ Unsafe driving practices | _____ Overweight upon arrival |
| _____ Other (specify _____) | |

Security Guard Initials: _____
 (Indicating receipt of Wash Bay pass, if necessary)

Driver's Comments

Please print or type. (Form designed for use on elite (12-pitch) typewriter.)

Form Approved. OMB No. 2050-0039

UNIFORM HAZARDOUS WASTE MANIFEST		1. Generator ID Number NYR000058347	2. Page 1 of 1	3. Emergency Response Phone 800-424-9300	4. Manifest Tracking Number 000364568GBF					
5. Generator's Name and Mailing Address NORTHROP GRUMMAN CORP 925 SOUTH OYSTER BAY RD, MAIL STOP W16-35 BETHPAGE NY 11714				Generator's Site Address (if different than mailing address) NORTHROP GRUMMAN AEROSPACE BLVD BETHPAGE NY 11714						
Generator's Phone: (516) 575-4680				6. Transporter 1 Company Name PRICE TRUCKING						
				U.S. EPA ID Number NYD046765574						
7. Transporter 2 Company Name				U.S. EPA ID Number						
8. Designated Facility Name and Site Address CWM CHEMICAL SERVICES, L.L.C. 1550 BALMER RD. MODEL CITY NY 14107				U.S. EPA ID Number NYD049836679						
Facility's Phone: (716) 754-8231										
GENERATOR	9a. HM	9b. U.S. DOT Description (including Proper Shipping Name, Hazard Class, ID Number, and Packing Group (if any))		10. Containers		11. Total Quantity	12. Unit Wt./Vol.	13. Waste Codes		
	X	1. RO, POLYCHLORINATED BIPHENYLS, SOLID MIXTURE, 9, UN3432, III NY296605		001	DT	EST 2215	K	B007		
		2.								
		3.								
		4.								
14. Special Handling Instructions and Additional Information 1. NY296605 PCB Soil ERG # 171 PCB Out of Service Date <u>12/28/07</u> Weight in Section 11 is Estimated. SR# _____ <u>81621162</u>										
15. GENERATOR'S/OFFEROR'S CERTIFICATION: I hereby declare that the contents of this consignment are fully and accurately described above by the proper shipping name, and are classified, packaged, marked and labeled/placarded, and are in all respects in proper condition for transport according to applicable international and national governmental regulations. If export shipment and I am the Primary Exporter, I certify that the contents of this consignment conform to the terms of the attached EPA Acknowledgment of Consent. I certify that the waste minimization statement identified in 40 CFR 262.27(a) (if I am a large quantity generator) or (b) (if I am a small quantity generator) is true.										
Generator's/Offor's Printed/Typed Name ABOUT FOR NORTHROP GRUMMAN Signature BRUCE EULIAN <i>Agent for Northrop Grumman</i> Month 12 Day 28 Year 07										
16. International Shipments <input type="checkbox"/> Import to U.S. <input type="checkbox"/> Export from U.S. Port of entry/exit: _____ Date leaving U.S.: _____										
TRANSPORTER	17. Transporter Acknowledgment of Receipt of Materials									
	Transporter 1 Printed/Typed Name IVAN ZISKU					Signature <i>[Signature]</i>			Month 12 Day 28 Year 07	
Transporter 2 Printed/Typed Name					Signature			Month Day Year		
DESIGNATED FACILITY	18. Discrepancy									
	18a. Discrepancy Indication Space <input checked="" type="checkbox"/> Quantity <input type="checkbox"/> Type <input type="checkbox"/> Residue <input type="checkbox"/> Partial Rejection <input type="checkbox"/> Full Rejection qty not actual rec'd 31942K Manifest Reference Number: _____									
	18b. Alternate Facility (or Generator) U.S. EPA ID Number									
	Facility's Phone: _____									
18c. Signature of Alternate Facility (or Generator)								Month Day Year		
19. Hazardous Waste Report Management Method Codes (i.e., codes for hazardous waste treatment, disposal, and recycling systems)										
1. H132			2.			3.		4.		
20. Designated Facility Owner or Operator: Certification of receipt of hazardous materials covered by the manifest except as noted in Item 18a										
Printed/Typed Name ELLEN CARTER					Signature <i>Ellen Carter</i>			Month 12 Day 31 Year 07		



Transporter Log
CWM Chemical Services, Inc.
 Model City, NY

158603

50
 Cubic Yards

81621169 Receipt #
 240 12 NY Trailer License Plate # and State
 NY 27605
 Service Req. # Profile # Permit #
 Transporter Name Tractor/Trailer/Roll-off #
 Driver's Name Generator

SCALE 1 107720 LB G
 10:48 AM 12/31/07 12
 SCALE 2 34620 LB G
 12:07 PM 12/31/07 12

Scheduled Arrival: _____
 Actual Arrival: _____
 Date Time Date Time In Time Out

73100P
 33158K

Arrived during Blackout? Y / N Notified DEC? Y / N

Receiving: _____
 Initials Comments

- Leaker Permit Violation Placarding/Veh. I.D. Violation
- Other (specify _____)
- Bulk to Landfill No wet line Flatbed Stabilization Drums Tanker Transformers

Laboratory
 Time In Time Out Initials Comments

Stabilization
 Time In Time Out Initials Gross Wt. Comments

Landfill
 Time In Time Out Initials Comments

Other
 Time In Time Out Initials Comments

Aqueous Treatment
 Time In Time Out Signature (NO Initials) Comments

Facility Personnel (please initial)

- _____ Smoking or eating in prohibited areas
- _____ Leaving truck unattended
- _____ Failure to obey instructions of facility personnel
- _____ Failure to display overweight flag
- _____ Failure to wear appropriate PPE
- _____ Improper tarping or detarpin
- _____ Unsafe driving practices
- _____ Overweight upon arrival
- _____ Other (specify _____)

Security Guard Initials: _____
 (Indicating receipt of Wash Bay pass, if necessary)

Driver's Comments

Please print or type. (Form designed for use on elite (12-pitch) typewriter.)

Form Approved. OMB No. 2050-0039

UNIFORM HAZARDOUS WASTE MANIFEST		1. Generator ID Number NYR000058347	2. Page 1 of 1	3. Emergency Response Phone 800-424-9300	4. Manifest Tracking Number 000364569GBF	
5. Generator's Name and Mailing Address NORTHROP GRUMMAN CORP 925 SOUTH OYSTER BAY RD, MAIL STOP W16-35 BETHPAGE NY 11714			Generator's Site Address (if different than mailing address) NORTHROP GRUMMAN AEROSPACE BLVD BETHPAGE NY 11714			
Generator's Phone: (516) 575-4680						
6. Transporter 1 Company Name PRICE TRUCKING				U.S. EPA ID Number NYD046765574		
7. Transporter 2 Company Name				U.S. EPA ID Number		
8. Designated Facility Name and Site Address CWM CHEMICAL SERVICES, L.L.C. 1550 BALMER RD. MODEL CITY NY 14107			U.S. EPA ID Number NYD049836679			
Facility's Phone: (716) 754-8231						
9a. HM	9b. U.S. DOT Description (including Proper Shipping Name, Hazard Class, ID Number, and Packing Group (if any))	10. Containers		11. Total Quantity	12. Unit Wt./Vol.	13. Waste Codes
		No.	Type			
X	1. RQ, POLYCHLORINATED BIPHENYLS, SOLID MIXTURE, 9, UN3432, III NY296605	001	DT	EST 27215	K	B007
	2.					
	3.					
	4.					
14. Special Handling Instructions and Additional Information 1. NY296605 PCB Soil ERG # 171 PCB Out of Service Date 12/28/07 Weight in Section 11 is Estimated. SR# 81621169						
15. GENERATOR'S/OFFEROR'S CERTIFICATION: I hereby declare that the contents of this consignment are fully and accurately described above by the proper shipping name, and are classified, packaged, marked and labeled/placarded, and are in all respects in proper condition for transport according to applicable international and national governmental regulations. If export shipment and I am the Primary Exporter, I certify that the contents of this consignment conform to the terms of the attached EPA Acknowledgment of Consent. I certify that the waste minimization statement identified in 40 CFR 262.27(a) (if I am a large quantity generator) or (b) (if I am a small quantity generator) is true.						
Generator's/Offeror's Printed/Typed Name AGOUT FOR NORTHROP GRUMMAN				Signature <i>Bruce Equian</i>		Month Day Year 12/28/07
16. International Shipments <input type="checkbox"/> Import to U.S. <input type="checkbox"/> Export from U.S. Port of entry/exit: _____ Date leaving U.S.: _____						
17. Transporter Acknowledgment of Receipt of Materials						
Transporter 1 Printed/Typed Name PAVEL Zinkiv				Signature <i>Pavel Zinkiv</i>		Month Day Year 12/28/07
Transporter 2 Printed/Typed Name				Signature		Month Day Year
18. Discrepancy						
18a. Discrepancy Indication Space <input checked="" type="checkbox"/> Quantity <input type="checkbox"/> Type <input type="checkbox"/> Residue <input type="checkbox"/> Partial Rejection <input type="checkbox"/> Full Rejection						
qty est actual recd 33158K						
18b. Alternate Facility (or Generator)				Manifest Reference Number: _____ U.S. EPA ID Number		
Facility's Phone:						
18c. Signature of Alternate Facility (or Generator)				Month Day Year		
19. Hazardous Waste Report Management Method Codes (i.e., codes for hazardous waste treatment, disposal, and recycling systems)						
1.	2.	3.	4.			
H132						
20. Designated Facility Owner or Operator: Certification of receipt of hazardous materials covered by the manifest except as noted in Item 18a						
Printed/Typed Name ETLEON CARTER				Signature <i>Eleon Carter</i>		Month Day Year 12/31/07



Transporter Log
CWM Chemical Services, Inc.
 Model City, NY

158584

Cubic Yards

81621151

AN-36425 NY
 Trailer License Plate # and State

SCALE 2 107180 LB G

07:32 AM 12/31/07 12

Receipt #

NY276605 - 4A-209

Service Req. #

Profile #

Permit #

mangialdi Bros.

48/30

Transporter Name

Tractor/Trailer/Roll-off #

Tom V. PTA

Northrop Corporation corp.

Driver's Name

Generator

SCALE 2 37360 LB G

09:23 AM 12/31/07 12

Scheduled Arrival:

Date Time

Actual Arrival:

Date Time In Time Out

6:39

69820P

31670K

Arrived during Blackout? Y / N

Notified DEC? Y / N

Receiving:

Initials Comments

Leaker Permit Violation Placarding/Veh. I.D. Violation

Other (specify _____)

Bulk to Landfill No wet line Flatbed Stabilization Drums Tanker Transformers

Laboratory

Time In Time Out Initials Comments

Stabilization

Time In Time Out Initials Gross Wt. Comments

Landfill

Time In Time Out Initials Comments

Other

Time In Time Out Initials Comments

Aqueous Treatment

Time In Time Out Signature (NO Initials) Comments

Facility Personnel (please initial)

_____ Smoking or eating in prohibited areas

_____ Leaving truck unattended

_____ Failure to obey instructions of facility personnel

_____ Failure to display overweight flag

_____ Failure to wear appropriate PPE

_____ Improper tarping or detarpin

_____ Unsafe driving practices

_____ Overweight upon arrival

_____ Other (specify _____)

Security Guard Initials: _____

(Indicating receipt of Wash Bay pass, if necessary)

Driver's Comments

White: Records

Green & Canary: Accts Rec.

Pink: Environmental

Goldenrod: Driver

Please print or type. (Form designed for use on elite (12-pitch) typewriter.)

Form Approved. OMB No. 2050-0039

UNIFORM HAZARDOUS WASTE MANIFEST		1. Generator ID Number NYR000058347	2. Page 1 of 1	3. Emergency Response Phone 800-424-9300	4. Manifest Tracking Number 000364570GBF	
5. Generator's Name and Mailing Address NORTHROP GRUMMAN CORP 925 SOUTH OYSTER BAY RD. MAIL STOP W16-35 BETHPAGE NY 11714				Generator's Site Address (if different than mailing address) NORTHROP GRUMMAN AEROSPACE BLVD BETHPAGE NY 11714		
Generator's Phone: (516) 575-4680						
6. Transporter 1 Company Name MANGIARDI TRUCKING				U.S. EPA ID Number NYR000097972		
7. Transporter 2 Company Name				U.S. EPA ID Number		
8. Designated Facility Name and Site Address CWM CHEMICAL SERVICES, L.L.C. 1550 BALMER RD. MODEL CITY NY 14107				U.S. EPA ID Number NYD049836679		
Facility's Phone: (716) 754-8231						
9a. HM	9b. U.S. DOT Description (including Proper Shipping Name, Hazard Class, ID Number, and Packing Group (if any))	10. Containers		11. Total Quantity	12. Unit Wt./Vol.	13. Waste Codes
		No.	Type			
X	1. RQ, POLYCHLORINATED BIPHENYLS, SOLID MIXTURE, 9,UN3432,III NY296605	001	DT	EST 27215	K	B007
14. Special Handling Instructions and Additional Information 1. NY296605 PCB Soil ERG # 171 PCB Out of Service Date <u>12/28/07</u> Weight in Section 11 is Estimated. SR# <u>81621151</u> Recd <u>31670K</u>						
15. GENERATOR'S/OFFEROR'S CERTIFICATION: I hereby declare that the contents of this consignment are fully and accurately described above by the proper shipping name, and are classified, packaged, marked and labeled/placarded, and are in all respects in proper condition for transport according to applicable international and national governmental regulations. If export shipment and I am the Primary Exporter, I certify that the contents of this consignment conform to the terms of the attached EPA Acknowledgment of Consent. I certify that the waste minimization statement identified in 40 CFR 262.27(a) (if I am a large quantity generator) or (b) (if I am a small quantity generator) is true.						
Generator's/Offeror's Printed/Typed Name ASST FOR NORTHROP GRUMMAN BRUCE EULIAN				Signature <i>Bruce Eulian</i>		Month Day Year 12 28 07
16. International Shipments <input type="checkbox"/> Import to U.S. <input type="checkbox"/> Export from U.S. Port of entry/exit: _____ Date leaving U.S.: _____						
17. Transporter Acknowledgment of Receipt of Materials						
Transporter 1 Printed/Typed Name Tom Vietz				Signature <i>Tom Vietz</i>		Month Day Year 12 28 07
Transporter 2 Printed/Typed Name				Signature		Month Day Year
18. Discrepancy						
18a. Discrepancy Indication Space <input checked="" type="checkbox"/> Quantity <input type="checkbox"/> Type <input type="checkbox"/> Residue <input type="checkbox"/> Partial Rejection <input type="checkbox"/> Full Rejection						
qty est actual recd 31670K						
18b. Alternate Facility (or Generator)				U.S. EPA ID Number		
Facility's Phone:						
18c. Signature of Alternate Facility (or Generator)						Month Day Year
19. Hazardous Waste Report Management Method Codes (i.e., codes for hazardous waste treatment, disposal, and recycling systems)						
1. H132		2.		3.		4.
20. Designated Facility Owner or Operator: Certification of receipt of hazardous materials covered by the manifest except as noted in item 18a						
Printed/Typed Name ETLON CARTER				Signature <i>Eileen Carter</i>		Month Day Year 12 31 07



Transporter Log
CWM Chemical Services, Inc.
 Model City, NY

158717

Cubic Yards

81621236

AC96628 NY

SCALE 2 113300 LB G

06:10 AM 01/04/08 12

Receipt # 855064-1NY870605 Trailer License Plate # and State 1A-209

Service Req. # MAngiardi Profile # 49/19 Permit # 49/19

Transporter Name GARY DAUITY Tractor/Trailer/Roll-off # NEATHRUP GRUMMAN Corp.
 Driver's Name GARY DAUITY Generator

SCALE 2 38560 LB G

07:53 AM 01/04/08 12

Scheduled Arrival: _____

Actual Arrival: _____
 Date _____ Time _____
 Date _____ Time In 5:02 Time Out _____

74740P
33902K

Arrived during Blackout? Y / N Notified DEC? Y / N

- Leaker Permit Violation Placarding/Veh. I.D. Violation
 Other (specify) _____

Receiving: <u>e</u>
Initials _____
Comments _____

- Bulk to Landfill No wet line Flatbed Stabilization Drums Tanker Transformers

Laboratory

Time In _____ Time Out _____ Initials JK Comments _____

Stabilization

Time In _____ Time Out _____ Initials _____ Gross Wt _____ Comments _____

Landfill

Time In _____ Time Out _____ Initials _____ Comments _____

Other

Time In _____ Time Out _____ Initials _____ Comments _____

Aqueous Treatment

Time In _____ Time Out _____ Signature (NO Initials) _____ Comments _____

Facility Personnel (please initial)

- | | |
|--|--|
| _____ Smoking or eating in prohibited areas | _____ Leaving truck unattended |
| _____ Failure to obey instructions of facility personnel | _____ Failure to display overweight flag |
| _____ Failure to wear appropriate PPE | _____ Improper tarping or detarpin |
| _____ Unsafe driving practices | _____ Overweight upon arrival |
| _____ Other (specify) _____ | |

Security Guard Initials: _____
 (Indicating receipt of Wash Bay pass, if necessary)

Driver's Comments

Please print or type. (Form designed for use on elite (12-pitch) typewriter.)

Form Approved. OMB No. 2050-0039

UNIFORM HAZARDOUS WASTE MANIFEST		1. Generator ID Number NYR000058347	2. Page 1 of 1	3. Emergency Response Phone 900-424-9300	4. Manifest Tracking Number 000364571GBF		
5. Generator's Name and Mailing Address NORTHROP GRUMMAN CORP 925 SOUTH OYSTER BAY RD, MAIL STOP W16-35 BETHPAGE NY 11714 (516) 575-4680				Generator's Site Address (if different than mailing address) NORTHROP GRUMMAN AEROSPACE BLVD BETHPAGE NY 11714			
6. Transporter 1 Company Name MANGIARDI TRUCKING		U.S. EPA ID Number NYR000097972					
7. Transporter 2 Company Name		U.S. EPA ID Number					
8. Designated Facility Name and Site Address CWM CHEMICAL SERVICES, L.L.C. 1550 BALMER RD. MODEL CITY NY 14107 (716) 754-8231				U.S. EPA ID Number NYD049836679			
Facility's Phone:							
9a. HM	9b. U.S. DOT Description (including Proper Shipping Name, Hazard Class, ID Number, and Packing Group (if any))	10. Containers		11. Total Quantity	12. Unit WL/Vol.	13. Waste Codes	
		No.	Type				
X	RO, POLYCHLORINATED BIPHENYLS, SOLID MIXTURE, 9,UN3432,III NY296605	001	DT	EST 27215	K	B007	
14. Special Handling Instructions and Additional Information 1. NY296605 PCB Soil ERG #171 PCB Out of Service Date 01/03/08 Weight is Section 11 is Estimated. SR# 8550621-1 81621286							
15. GENERATOR'S/OFFEROR'S CERTIFICATION: I hereby declare that the contents of this consignment are fully and accurately described above by the proper shipping name, and are classified, packaged, marked and labeled/placarded, and are in all respects in proper condition for transport according to applicable international and national governmental regulations. If export shipment and I am the Primary Exporter, I certify that the contents of this consignment conform to the terms of the attached EPA Acknowledgment of Consent. I certify that the waste minimization statement identified in 40 CFR 262.27(a) (if I am a large quantity generator) or (b) (if I am a small quantity generator) is true.							
Generator's/Offeror's Printed/Typed Name AGENT FOR NORTHROP GRUMMAN		Signature BRUCE EULIAN		Month Day Year 01/03/08			
16. International Shipments <input type="checkbox"/> Import to U.S. <input type="checkbox"/> Export from U.S. Port of entry/exit: _____ Date leaving U.S.: _____							
17. Transporter Acknowledgment of Receipt of Materials Transporter 1 Printed/Typed Name GARRY DANEY Signature Garry Daney Month Day Year 01/03/08 Transporter 2 Printed/Typed Name _____ Signature _____ Month Day Year _____							
18. Discrepancy 18a. Discrepancy Indication Space <input checked="" type="checkbox"/> Quantity <input type="checkbox"/> Type <input type="checkbox"/> Residue <input type="checkbox"/> Partial Rejection <input type="checkbox"/> Full Rejection qty est actual recd 33902K Manifest Reference Number: _____							
18b. Alternate Facility (or Generator) Facility's Phone: _____				U.S. EPA ID Number _____			
18c. Signature of Alternate Facility (or Generator) _____						Month Day Year _____	
19. Hazardous Waste Report Management Method Codes (i.e., codes for hazardous waste treatment, disposal, and recycling systems)							
1. H132		2. _____		3. _____		4. _____	
20. Designated Facility Owner or Operator: Certification of receipt of hazardous materials covered by the manifest except as noted in Item 18a Printed/Typed Name ELLEN CARTER Signature Ellen Carter Month Day Year 1/14/08							



Transporter Log
CWM Chemical Services, Inc.
 Model City, NY

158756

Cubic Yards

81621325

AR27257 NY

Receipt # 755064 Trailer License Plate # and State NY296605 4A-209
 Service Req. # Mangiardi Trucking Profile # 46-32 Permit # 46-32
 Transporter Name Chris Hule Tractor/Trailer/Roll-off # Northrop Brennan
 Driver's Name _____ Generator _____

SCALE 1 105340 LB G
 09:54 AM 01/04/08 12

SCALE 2 36100 LB G
 11:14 AM 01/04/08 12

69240P
31407K

Scheduled Arrival: _____
 Actual Arrival: _____
 Date _____ Time _____
 Date _____ Time In _____ Time Out _____

Arrived during Blackout? Y / N Notified DEC? Y / N

Leaker Permit Violation Placarding/Veh. I.D. Violation

Other (specify _____)

Bulk to Landfill No wet line Flatbed Stabilization Drums Tanker Transformers

Receiving: _____
 Initials _____ Comments _____

Laboratory _____
 Time In _____ Time Out _____ Initials _____ Comments _____

Stabilization _____
 Time In _____ Time Out _____ Initials _____ Gross Wt. _____ Comments _____

Landfill _____
 Time In _____ Time Out _____ Initials _____ Comments _____

Other _____
 Time In _____ Time Out _____ Initials _____ Comments _____

Aqueous Treatment _____
 Time In _____ Time Out _____ Signature (NO Initials) _____ Comments _____

Facility Personnel (please initial)

_____ Smoking or eating in prohibited areas _____ Leaving truck unattended
 _____ Failure to obey instructions of facility personnel _____ Failure to display overweight flag
 _____ Failure to wear appropriate PPE _____ Improper tarping or detarpin
 _____ Unsafe driving practices _____ Overweight upon arrival
 _____ Other (specify) _____

Security Guard Initials: _____
 (Indicating receipt of Wash Bay pass, if necessary)

Driver's Comments

Please print or type. (Form designed for use on elite (12-pitch) typewriter.)

Form Approved. OMB No. 2050-0039

UNIFORM HAZARDOUS WASTE MANIFEST		1. Generator ID Number NYR000058347	2. Page 1 of 1	3. Emergency Response Phone 800-424-9300	4. Manifest Tracking Number 000364572GBF	
5. Generator's Name and Mailing Address NORTHROP GRUMMAN CORP 925 SOUTH OYSTER BAY RD, MAIL STOP W16-35 BETHPAGE NY 11714			Generator's Site Address (if different than mailing address) NORTHROP GRUMMAN AEROSPACE BLVD BETHPAGE NY 11714			
Generator's Phone: (516) 575-4680			U.S. EPA ID Number NYR000097972			
6. Transporter 1 Company Name MANGIARDI TRUCKING			U.S. EPA ID Number			
7. Transporter 2 Company Name			U.S. EPA ID Number			
8. Designated Facility Name and Site Address CWM CHEMICAL SERVICES, L.L.C. 1550 BALMER RD. MODEL CITY NY 14107			U.S. EPA ID Number NYD049836679			
Facility's Phone: (716) 754-8231						
9a. HM	9b. U.S. DOT Description (including Proper Shipping Name, Hazard Class, ID Number, and Packing Group (if any))	10. Containers		11. Total Quantity	12. Unit Wt./Vol.	13. Waste Codes
		No.	Type			
X	1. RQ, POLYCHLORINATED BIPHENYLS, SOLID MIXTURE, 9, UN3432, III NY296605	001	DT	EST. 2725	K	B007
	2.					
	3.					
	4.					
14. Special Handling Instructions and Additional Information 1. NY296605 PCB Soil ERG # 171 PCB Out of Service Date 01/03/08 Weight in Section 11 is Estimated. SR# 855064 81621325						
15. GENERATOR'S/OFFEROR'S CERTIFICATION: I hereby declare that the contents of this consignment are fully and accurately described above by the proper shipping name, and are classified, packaged, marked and labeled/placarded, and are in all respects in proper condition for transport according to applicable international and national governmental regulations. If export shipment and I am the Primary Exporter, I certify that the contents of this consignment conform to the terms of the attached EPA Acknowledgment of Consent. I certify that the waste minimization statement identified in 40 CFR 262.27(a) (if I am a large quantity generator) or (b) (if I am a small quantity generator) is true.						
Generator's/Offeror's Printed/Typed Name AGENT FOR NORTHROP GRUMMAN Signature: BRUCE FULMER Date: 01/03/08						
16. International Shipments <input type="checkbox"/> Import to U.S. <input type="checkbox"/> Export from U.S. Port of entry/exit: _____ Date leaving U.S.: _____						
17. Transporter Acknowledgment of Receipt of Materials						
Transporter 1 Printed/Typed Name Chris Hale			Signature <i>Chris Hale</i>		Month Day Year 01/03/08	
Transporter 2 Printed/Typed Name			Signature		Month Day Year	
18. Discrepancy						
18a. Discrepancy Indication Space <input checked="" type="checkbox"/> Quantity <input type="checkbox"/> Type <input type="checkbox"/> Residue <input type="checkbox"/> Partial Rejection <input type="checkbox"/> Full Rejection qty est actual recd 31407 K						
18b. Alternate Facility (or Generator) Manifest Reference Number: _____ U.S. EPA ID Number _____						
Facility's Phone: _____						
18c. Signature of Alternate Facility (or Generator) _____ Month Day Year _____						
19. Hazardous Waste Report Management Method Codes (i.e., codes for hazardous waste treatment, disposal, and recycling systems)						
1. H132		2.		3.		4.
20. Designated Facility Owner or Operator: Certification of receipt of hazardous materials covered by the manifest except as noted in item 18a						
Printed/Typed Name ELDON CARTER			Signature <i>Eldon Carter</i>		Month Day Year 1/4/08	



Transporter Log
CWM Chemical Services, Inc.
 Model City, NY

158715

Cubic Yards

81621284

AH-1602 101

Receipt # _____ Trailer License Plate # and State _____
 Service Req. # _____ Profile # _____ Permit # _____
 Transporter Name _____ Tractor/Trailer/Roll-off # _____
 Driver's Name _____ Generator _____

SCALE 2 100520 LB G
 06:06 AM 01/04/08 12
 SCALE 2 37920 LB G
 07:48 AM 01/04/08 12

Scheduled Arrival: _____
 Actual Arrival: _____
 Date _____ Time _____
 Date _____ Time In _____ Time Out _____

62600 P
 23395K

Arrived during Blackout? Y / N Notified DEC? Y / N

Leaker Permit Violation Placarding/Veh. I.D. Violation

Other (specify _____)

Bulk to Landfill No wet line Flatbed Stabilization Drums Tanker Transformers

Receiving: _____
 Initials _____ Comments _____

Laboratory _____
 Time In _____ Time Out _____ Initials _____ Comments _____

Stabilization _____
 Time In _____ Time Out _____ Initials _____ Gross Wt. _____ Comments _____

Landfill _____
 Time In _____ Time Out _____ Initials _____ Comments _____

Other _____
 Time In _____ Time Out _____ Initials _____ Comments _____

Aqueous Treatment _____
 Time In _____ Time Out _____ Signature (NO Initials) _____ Comments _____

Facility Personnel (please initial)

- _____ Smoking or eating in prohibited areas
- _____ Leaving truck unattended
- _____ Failure to obey instructions of facility personnel
- _____ Failure to display overweight flag
- _____ Failure to wear appropriate PPE
- _____ Improper tarping or detarpin
- _____ Unsafe driving practices
- _____ Overweight upon arrival
- _____ Other (specify) _____

Security Guard Initials: _____
 (Indicating receipt of Wash Bay pass, if necessary)

Driver's Comments

Please print or type. (Form designed for use on elite (12-pitch) typewriter.)

Form Approved. OMB No. 2050-0039

UNIFORM HAZARDOUS WASTE MANIFEST		1. Generator ID Number NYR000058347	2. Page 1 of 1	3. Emergency Response Phone 800-424-9300	4. Manifest Tracking Number 000364573GBF				
5. Generator's Name and Mailing Address NORTHROP GRUMMAN CORP 925 SOUTH OYSTER BAY RD, MAIL STOP W16-35 BETHPAGE NY 11714 Generator's Phone: (516) 575-4680				Generator's Site Address (if different than mailing address) NORTHROP GRUMMAN AEROSPACE BLVD BETHPAGE NY 11714					
6. Transporter 1 Company Name MANGIARDI TRUCKING				U.S. EPA ID Number NYR000097972					
7. Transporter 2 Company Name				U.S. EPA ID Number					
8. Designated Facility Name and Site Address CWM CHEMICAL SERVICES, L.L.C. 1550 BALMER RD. MODEL CITY NY 14107 Facility's Phone: (716) 754-8231				U.S. EPA ID Number NYD049836679					
GENERATOR	9a. HM	9b. U.S. DOT Description (including Proper Shipping Name, Hazard Class, ID Number, and Packing Group (if any))		10. Containers		11. Total Quantity	12. Unit Wt./Vol.	13. Waste Codes	
	X	1. RQ, POLYCHLORINATED BIPHENYLS, SOLID MIXTURE, 9,UN3432,III NY296605		001	DT	EST. 27215	K	B007	
14. Special Handling Instructions and Additional Information 1. NY296605 PCB SOL ERG # 171 PCB Out of Service Date 01/03/08 Weight is Section 11 is Estimated. SR# 855064 816.21284 Reid 28395K									
15. GENERATOR'S/OFFEROR'S CERTIFICATION: I hereby declare that the contents of this consignment are fully and accurately described above by the proper shipping name, and are classified, packaged, marked and labeled/placarded, and are in all respects in proper condition for transport according to applicable international and national governmental regulations. If export shipment and I am the Primary Exporter, I certify that the contents of this consignment conform to the terms of the attached EPA Acknowledgment of Consent. I certify that the waste minimization statement identified in 40 CFR 262.27(a) (if I am a large quantity generator) or (b) (if I am a small quantity generator) is true.									
Generator's/Offoror's Printed/Typed Name ABOUT FOR NORTHROP GRUMMAN Signature: BRUCE EQUAN Month Day Year: 01/03/08									
16. International Shipments <input type="checkbox"/> Import to U.S. <input type="checkbox"/> Export from U.S. Port of entry/exit: _____ Date leaving U.S.: _____									
17. Transporter Acknowledgment of Receipt of Materials									
Transporter 1 Printed/Typed Name RON FERRETT Signature: Ron Ferrett Month Day Year: 01/03/08									
Transporter 2 Printed/Typed Name _____ Signature _____ Month Day Year _____									
18. Discrepancy									
18a. Discrepancy Indication Space <input type="checkbox"/> Quantity <input type="checkbox"/> Type <input type="checkbox"/> Residue <input type="checkbox"/> Partial Rejection <input type="checkbox"/> Full Rejection Manifest Reference Number: _____									
18b. Alternate Facility (or Generator) U.S. EPA ID Number _____									
Facility's Phone: _____									
18c. Signature of Alternate Facility (or Generator) _____ Month Day Year _____									
19. Hazardous Waste Report Management Method Codes (i.e., codes for hazardous waste treatment, disposal, and recycling systems)									
1. H132 2. _____ 3. _____ 4. _____									
20. Designated Facility Owner or Operator: Certification of receipt of hazardous materials covered by the manifest except as noted in Item 18a									
Printed/Typed Name: BILLIE CARTER Signature: Billie Carter Month Day Year: 1/4/08									



Transporter Log
CWM Chemical Services, Inc.
 Model City, NY

158716

Cubic Yards

81621285
 Receipt # 855064
 Service Req. # Tom Viola
 Transporter Name Tom Viola
 Driver's Name Tom Viola

AN36425 N.Y.
 Trailer License Plate # and State 4A-209
 Permit # 48/30
 Tractor/Trailer/Roll-off # 1011160P 9/11/14
 Generator

SCALE 1 106700 LB G
 06:05 AM 01/04/08 12

SCALE 2 37340 LB G
 07:50 AM 01/04/08 12

Scheduled Arrival: _____
 Date Time
 Actual Arrival: 5:01
 Date Time In Time Out

69360P
31461K

- Arrived during Blackout? Y / N Notified DEC? Y / N
- Leaker Permit Violation Placarding/Veh. I.D. Violation
- Other (specify _____)
- Bulk to Landfill No wet line Flatbed Stabilization Drums Tanker Transformers

Receiving: J
 Initials Comments

Laboratory
 Time In Time Out Initials Comments

Stabilization
 Time In Time Out Initials Gross Wt. Comments

Landfill
 Time In Time Out Initials Comments

Other
 Time In Time Out Initials Comments

Aqueous Treatment
 Time In Time Out Signature (NO Initials) Comments

Facility Personnel (please initial)

- _____ Smoking or eating in prohibited areas _____ Leaving truck unattended
- _____ Failure to obey instructions of facility personnel _____ Failure to display overweight flag
- _____ Failure to wear appropriate PPE _____ Improper tarping or detarpin
- _____ Unsafe driving practices _____ Overweight upon arrival
- _____ Other (specify _____)

Security Guard Initials: _____
 (Indicating receipt of Wash Bay pass, if necessary)

Driver's Comments

Please print or type. (Form designed for use on elite (12-pitch) typewriter.)

Form Approved. OMB No. 2050-0039

UNIFORM HAZARDOUS WASTE MANIFEST		1. Generator ID Number NYR000058347	2. Page 1 of 1	3. Emergency Response Phone 800-424-9300	4. Manifest Tracking Number 000364574GBF			
5. Generator's Name and Mailing Address NORTHROP GRUMMAN CORP 925 SOUTH OYSTER BAY RD, MAIL STOP W16-35 BETHPAGE NY 11714 (516) 575-4680				Generator's Site Address (if different than mailing address) NORTHROP GRUMMAN AEROSPACE BLVD BETHPAGE NY 11714				
6. Transporter 1 Company Name MANGIARDI TRUCKING		U.S. EPA ID Number NYR000097972		7. Transporter 2 Company Name				
8. Designated Facility Name and Site Address CWM CHEMICAL SERVICES, L.L.C. 1550 BALMER RD. MODEL CITY NY 14107 (716) 754-8231		U.S. EPA ID Number NYD049836679						
9a. HM	9b. U.S. DOT Description (including Proper Shipping Name, Hazard Class, ID Number, and Packing Group (if any))	10. Containers		11. Total Quantity	12. Unit WL/Vol.	13. Waste Codes		
X	1. RQ, POLYCHLORINATED BIPHENYLS, SOLID MIXTURE, 9,UN3432,III NY296605	001	DT	EST 2725	K	B007		
	2.							
	3.							
	4.							
14. Special Handling Instructions and Additional Information 1. NY296605 PCB Soil ERG # 171 PCB Out of Service Date <u>01/03/08</u> Weight Is Section 11 Is Estimated. SR# <u>855064</u> <u>81621285</u>								
15. GENERATOR'S/OFFEROR'S CERTIFICATION: I hereby declare that the contents of this consignment are fully and accurately described above by the proper shipping name, and are classified, packaged, marked and labeled/placarded, and are in all respects in proper condition for transport according to applicable international and national governmental regulations. If export shipment and I am the Primary Exporter, I certify that the contents of this consignment conform to the terms of the attached EPA Acknowledgment of Consent. I certify that the waste minimization statement identified in 40 CFR 262.27(a) (if I am a large quantity generator) or (b) (if I am a small quantity generator) is true.								
Generator's/Offoror's Printed/Typed Name AGENT FOR NORTHROP GRUMMAN		Signature BRUCE EULIAN		Month 01	Day 03	Year 08		
16. International Shipments <input type="checkbox"/> Import to U.S. <input type="checkbox"/> Export from U.S. Port of entry/exit: _____ Date leaving U.S.: _____								
17. Transporter Acknowledgment of Receipt of Materials								
Transporter 1 Printed/Typed Name Tom Viete		Signature Tom Viete		Month 1	Day 3	Year 08		
Transporter 2 Printed/Typed Name		Signature		Month	Day	Year		
18. Discrepancy								
18a. Discrepancy Indication Space <input checked="" type="checkbox"/> Quantity <input type="checkbox"/> Type <input type="checkbox"/> Residue <input type="checkbox"/> Partial Rejection <input type="checkbox"/> Full Rejection								
qty est actual recd 3461K								
18b. Alternate Facility (or Generator)				U.S. EPA ID Number				
Facility's Phone:				Manifest Reference Number:				
18c. Signature of Alternate Facility (or Generator)						Month	Day	Year
19. Hazardous Waste Report Management Method Codes (i.e., codes for hazardous waste treatment, disposal, and recycling systems)								
1.	2.	3.	4.					
H132								
20. Designated Facility Owner or Operator: Certification of receipt of hazardous materials covered by the manifest except as noted in item 18a								
Printed/Typed Name ELLEN CARTER		Signature Ellen Carter		Month 1	Day 4	Year 08		



Transporter Log
CWM Chemical Services, Inc.
 Model City, NY

158808

Cubic Yards

81621330

Receipt # _____ Trailer License Plate # and State _____
 Service Req. # _____ Profile # _____ Permit # _____
 Transporter Name _____ Tractor/Trailer/Roll-off # _____
 Driver's Name _____ Generator _____
 Scheduled Arrival: _____ Date _____ Time _____
 Actual Arrival: _____ Date _____ Time In _____ Time Out _____

SCALE 1 105700 LB G
 07:15 AM 01/07/08 12

SCALE 2 37320 LB G
 10:47 AM 01/07/08 12

68380P
 31019K

Arrived during Blackout? Y / N Notified DEC? Y / N

Leaker Permit Violation Placarding/Veh. I.D. Violation

Other (specify _____)

Bulk to Landfill No wet line Flatbed Stabilization Drums Tanker Transformers

Receiving: _____
 Initials _____ Comments _____

Laboratory _____
 Time In _____ Time Out _____ Initials _____ Comments _____

Stabilization _____
 Time In _____ Time Out _____ Initials _____ Gross Wt. _____ Comments _____

Landfill _____
 Time In _____ Time Out _____ Initials _____ Comments _____

Other _____
 Time In _____ Time Out _____ Initials _____ Comments _____

Aqueous Treatment _____
 Time In _____ Time Out _____ Signature (NO Initials) _____ Comments _____

Facility Personnel (please initial)

- _____ Smoking or eating in prohibited areas
- _____ Failure to obey instructions of facility personnel
- _____ Failure to wear appropriate PPE
- _____ Unsafe driving practices
- _____ Other (specify _____)
- _____ Leaving truck unattended
- _____ Failure to display overweight flag
- _____ Improper tarping or detarpin
- _____ Overweight upon arrival

Security Guard Initials: _____
 (Indicating receipt of Wash Bay pass, if necessary)

Driver's Comments

Please print or type. (Form designed for use on elite (12-pitch) typewriter.)

Form Approved. OMB No. 2050-0039

UNIFORM HAZARDOUS WASTE MANIFEST		1. Generator ID Number NYR000058347	2. Page 1 of 1	3. Emergency Response Phone 800-424-9300	4. Manifest Tracking Number 000364577GBF		
5. Generator's Name and Mailing Address NORTHROP GRUMMAN CORP 925 SOUTH OYSTER BAY RD, MAIL STOP W16-35 BETHPAGE NY 11714 (516) 575-4680				Generator's Site Address (if different than mailing address) NORTHROP GRUMMAN AEROSPACE BLVD BETHPAGE NY 11714			
6. Transporter 1 Company Name MANGIARDI TRUCKING					U.S. EPA ID Number NYR000097972		
7. Transporter 2 Company Name					U.S. EPA ID Number		
8. Designated Facility Name and Site Address CWM CHEMICAL SERVICES, L.L.C. 1550 BALMER RD. MODEL CITY NY 14107 (716) 754-8231					U.S. EPA ID Number NYD049836679		
Facility's Phone:							
9a. HM	9b. U.S. DOT Description (including Proper Shipping Name, Hazard Class, ID Number, and Packing Group (if any))	10. Containers		11. Total Quantity	12. Unit Wt./Vol.	13. Waste Codes	
		No.	Type				
X	1. RQ, POLYCHLORINATED BIPHENYLS, SOLID MIXTURE, 9,UN3432,III NY296605	001	DT	EST 2725	K	B007	
	2.						
	3.						
	4.						
14. Special Handling Instructions and Additional Information 1. NY296605 PCB Soil ERG #171 PCB Out of Service Date 01/07/08 Weight is Section 11 Is Estimated. SR# 81621380							
15. GENERATOR'S/OFFEROR'S CERTIFICATION: I hereby declare that the contents of this consignment are fully and accurately described above by the proper shipping name, and are classified, packaged, marked and labeled/placarded, and are in all respects in proper condition for transport according to applicable international and national governmental regulations. If export shipment and I am the Primary Exporter, I certify that the contents of this consignment conform to the terms of the attached EPA Acknowledgment of Consent. I certify that the waste minimization statement identified in 40 CFR 262.27(a) (if I am a large quantity generator) or (b) (if I am a small quantity generator) is true.							
Generator's/Offeror's Printed/Typed Name AGENT FOR NORTHROP GRUMMAN BRUCE EULIAN Signature Date: 01/07/08 Month Day Year							
16. International Shipments <input type="checkbox"/> Import to U.S. <input type="checkbox"/> Export from U.S. Port of entry/exit: _____ Date leaving U.S.: _____							
17. Transporter Acknowledgment of Receipt of Materials Transporter 1 Printed/Typed Name Josef Miasnik Signature Date: _____ Month Day Year Transporter 2 Printed/Typed Name Signature Date: _____ Month Day Year							
18. Discrepancy 18a. Discrepancy Indication Space <input checked="" type="checkbox"/> Quantity <input type="checkbox"/> Type <input type="checkbox"/> Residue <input type="checkbox"/> Partial Rejection <input type="checkbox"/> Full Rejection qty est actual recd 31017K Manifest Reference Number: _____							
18b. Alternate Facility (for Generator) _____ U.S. EPA ID Number _____ Facility's Phone: _____							
18c. Signature of Alternate Facility (or Generator) _____ Month Day Year							
19. Hazardous Waste Report Management Method Codes (i.e., codes for hazardous waste treatment, disposal, and recycling systems)							
1. H132		2.		3.		4.	
20. Designated Facility Owner or Operator: Certification of receipt of hazardous materials covered by the manifest except as noted in Item 18a Printed/Typed Name EILEEN CARTER Signature Eileen Carter Date: 1/7/08 Month Day Year							



Transporter Log
CWM Chemical Services, Inc.
 Model City, NY

158810

Cubic Yards

811021381

AC 96540 NY

SCALE 1 103140 LB G
 07:19 AM 01/07/08 T2

Receipt # _____ Trailer License Plate # and State _____

Service Req. # _____ Profile # _____ Permit # _____

Transporter Name _____ Tractor/Trailer/Roll-off # _____

Driver's Name _____ Generator _____

Scheduled Arrival: 1-7-08 10:30
 Date Time

SCALE 2 37700 LB G
 10:55 AM 01/07/08 T2

Actual Arrival: 6:19
 Date Time In Time Out

65440P
 29683K

Arrived during Blackout? Y / N Notified DEC? Y / N

- Leaker
- Permit Violation
- Placarding/Veh. I.D. Violation
- Other (specify _____)

Receiving: _____
Initials _____
Comments _____

- Bulk to Landfill
- No wet line
- Flatbed
- Stabilization
- Drums
- Tanker
- Transformers

Laboratory

Time In _____ Time Out _____ Initials _____ Comments _____

Stabilization

Time In _____ Time Out _____ Initials _____ Gross Wt. _____ Comments _____

Landfill

Time In _____ Time Out _____ Initials _____ Comments _____

Other

Time In _____ Time Out _____ Initials _____ Comments _____

Aqueous Treatment

Time In _____ Time Out _____ Signature (NO Initials) _____ Comments _____

Facility Personnel (please initial)

- _____ Smoking or eating in prohibited areas
- _____ Leaving truck unattended
- _____ Failure to obey instructions of facility personnel
- _____ Failure to display overweight flag
- _____ Failure to wear appropriate PPE
- _____ Improper tarping or detarpin
- _____ Unsafe driving practices
- _____ Overweight upon arrival
- _____ Other (specify _____)

Security Guard Initials: _____
 (Indicating receipt of Wash Bay pass, if necessary)

Driver's Comments

Please print or type. (Form designed for use on elite (12-pitch) typewriter.)

Form Approved. OMB No. 2050-0039

UNIFORM HAZARDOUS WASTE MANIFEST		1. Generator ID Number NYR000058347	2. Page 1 of 1	3. Emergency Response Phone 800-424-9300	4. Manifest Tracking Number 000364578GBF	
5. Generator's Name and Mailing Address NORTHROP GRUMMAN CORP 925 SOUTH OYSTER BAY RD, MAIL STOP W16-35 BETHPAGE NY 11714			Generator's Site Address (if different than mailing address) NORTHROP GRUMMAN AEROSPACE BLVD BETHPAGE NY 11714			
Generator's Phone: (516) 575-4680						
6. Transporter 1 Company Name MANGIARDI TRUCKING					U.S. EPA ID Number NYR000097972	
7. Transporter 2 Company Name						
8. Designated Facility Name and Site Address CWM CHEMICAL SERVICES, L.L.C. 1550 BALMER RD. MODEL CITY NY 14107					U.S. EPA ID Number NYD049836679	
Facility's Phone: (716) 754-8231						
9a. HM	9b. U.S. DOT Description (including Proper Shipping Name, Hazard Class, ID Number, and Packing Group (if any))	10. Containers		11. Total Quantity	12. Unit WL/Vol.	13. Waste Codes
		No.	Type			
X	1. RQ, POLYCHLORINATED BIPHENYLS, SOLID MIXTURE, 9, UN3432, III NY296605	001	DT	EST 27215	K	B007
	2.					
	3.					
	4.					
14. Special Handling Instructions and Additional Information 1. NY296605 PCB Soil ERG # 171 PCB Out of Service Date 01/07/08 Weight is Section 11 is Estimated. SR# 81621381 Recd 29683K						
15. GENERATOR'S/OFFEROR'S CERTIFICATION: I hereby declare that the contents of this consignment are fully and accurately described above by the proper shipping name, and are classified, packaged, marked and labeled/placarded, and are in all respects in proper condition for transport according to applicable international and national governmental regulations. If export shipment and I am the Primary Exporter, I certify that the contents of this consignment conform to the terms of the attached EPA Acknowledgment of Consent. I certify that the waste minimization statement identified in 40 CFR 262.27(a) (if I am a large quantity generator) or (b) (if I am a small quantity generator) is true.						
Generator's/Offor's Printed/Typed Name ALBERT FORNITHROP GRUMMAN PROCES EQUIPMENT						
Signature <i>[Signature]</i> Month Day Year 01/07/08						
16. International Shipments <input type="checkbox"/> Import to U.S. <input type="checkbox"/> Export from U.S. Port of entry/exit: _____ Date leaving U.S.: _____						
17. Transporter Acknowledgment of Receipt of Materials Transporter 1 Printed/Typed Name Rich Durham Signature <i>[Signature]</i> Month Day Year 1/7/08						
Transporter 2 Printed/Typed Name _____ Signature _____ Month Day Year _____ _____						
18. Discrepancy						
18a. Discrepancy Indication Space <input type="checkbox"/> Quantity <input type="checkbox"/> Type <input type="checkbox"/> Residue <input type="checkbox"/> Partial Rejection <input type="checkbox"/> Full Rejection						
Manifest Reference Number: _____						
18b. Alternate Facility (or Generator)					U.S. EPA ID Number	
Facility's Phone: _____						
18c. Signature of Alternate Facility (or Generator) _____ Month Day Year _____						
19. Hazardous Waste Report Management Method Codes (i.e., codes for hazardous waste treatment, disposal, and recycling systems)						
1. H132		2. _____		3. _____		4. _____
20. Designated Facility Owner or Operator: Certification of receipt of hazardous materials covered by the manifest except as noted in item 18a						
Printed/Typed Name EILEEN CARTON Signature <i>[Signature]</i> Month Day Year 1/7/08						



Transporter Log
CWM Chemical Services, Inc.
 Model City, NY

160909

Cubic Yards

Receipt # 23524
 Trailer License Plate # and State GA 025
 Service Req. # 11800 Profile # 12350 Permit # 11800/12350
 Transporter Name PRICE TRUCKING CORP. Tractor/Trailer/Roll-off #
 Driver's Name DENNIS SIMPSON Generator NORTHROP GRAMMAN CORP.

SCALE 1 108200 LB G
 11:59 AM 03/20/08 12
 SCALE 2 30840 LB G
 01:48 PM 03/20/08 12

Scheduled Arrival: _____
 Actual Arrival: Date _____ Time _____
 Date _____ Time In _____ Time Out _____

11500
 35181K

Arrived during Blackout? Y / N Notified DEC? Y / N

- Leaker Permit Violation Placarding/Veh. I.D. Violation
- Other (specify _____)
- Bulk to Landfill No wet line Flatbed Stabilization Drums Tanker Transformers

Receiving: <u>AL</u>	_____
Initials	Comments

Laboratory	Time In	Time Out	Initials	Comments	
			<u>M</u>		
Stabilization	Time In	Time Out	Initials	Gross Wt.	Comments
Landfill	Time In	Time Out	Initials	Comments	
Other	Time In	Time Out	Initials	Comments	
Aqueous Treatment	Time In	Time Out	Signature (NO Initials)	Comments	

Facility Personnel (please initial)

- _____ Smoking or eating in prohibited areas
- _____ Leaving truck unattended
- _____ Failure to obey instructions of facility personnel
- _____ Failure to display overweight flag
- _____ Failure to wear appropriate PPE
- _____ Improper tarping or detarpin
- _____ Unsafe driving practices
- _____ Overweight upon arrival
- _____ Other (specify _____)

Security Guard Initials: _____
 (Indicating receipt of Wash Bay pass, if necessary)

Driver's Comments _____

Please print or type. (Form designed for use on elite (12-pitch) typewriter.)

Form Approved. OMB No. 2050-0039

UNIFORM HAZARDOUS WASTE MANIFEST		1. Generator ID Number NYR000058347	2. Page 1 of 1	3. Emergency Response Phone 800-424-9300	4. Manifest Tracking Number 000364579GBF	
5. Generator's Name and Mailing Address NORTHROP GRUMMAN CORP 925 SOUTH OYSTER BAY RD, MAIL STOP W16-35 BETHPAGE NY 11714			Generator's Site Address (if different than mailing address) NORTHROP GRUMMAN AEROSPACE BLVD BETHPAGE NY 11714			
Generator's Phone: (516) 575-4680						
6. Transporter 1 Company Name PRICE TRUCKING				U.S. EPA ID Number NYD046765574		
7. Transporter 2 Company Name				U.S. EPA ID Number		
8. Designated Facility Name and Site Address CWM CHEMICAL SERVICES, L.L.C. 1550 BALMER RD. MODEL CITY NY 14107			U.S. EPA ID Number NYD049836679			
Facility's Phone: (716) 754-8231						
9a. HM	9b. U.S. DOT Description (including Proper Shipping Name, Hazard Class, ID Number, and Packing Group (if any))	10. Containers		11. Total Quantity	12. Unit Wt./Vol.	13. Waste Codes
		No.	Type			
X	1. RQ, POLYCHLORINATED BIPHENYLS, SOLID MIXTURE, 9,UN3432,III NY296605	001	DT	EST 27215	K	B007
14. Special Handling Instructions and Additional Information 1. NY296605 PCB Soil ERG #171 PCB Out of Service Date <u>03/19/08</u> Weight is Section 11 is Estimated. SR# <u>81623524</u>						
15. GENERATOR'S/OFFEROR'S CERTIFICATION: I hereby declare that the contents of this consignment are fully and accurately described above by the proper shipping name, and are classified, packaged, marked and labeled/placarded, and are in all respects in proper condition for transport according to applicable international and national governmental regulations. If export shipment and I am the Primary Exporter, I certify that the contents of this consignment conform to the terms of the attached EPA Acknowledgment of Consent. I certify that the waste minimization statement identified in 40 CFR 262.27(a) (if I am a large quantity generator) or (b) (if I am a small quantity generator) is true.						
Generator's/Offendor's Printed/Typed Name AGENT FOR NORTHROP GRUMMAN BRUCE EULIAN Agent for Northrop Grumman						
Signature <i>[Signature]</i> Month Day Year 03 19 08						
16. International Shipments <input type="checkbox"/> Import to U.S. <input type="checkbox"/> Export from U.S. Port of entry/exit: Transporter signature (for exports only): Date leaving U.S.:						
17. Transporter Acknowledgment of Receipt of Materials						
Transporter 1 Printed/Typed Name DENNIS SIMPSON						
Signature <i>[Signature]</i> Month Day Year 03 19 08						
Transporter 2 Printed/Typed Name Signature Month Day Year						
18. Discrepancy						
18a. Discrepancy Indication Space <input checked="" type="checkbox"/> Quantity <input type="checkbox"/> Type <input type="checkbox"/> Residue <input type="checkbox"/> Partial Rejection <input type="checkbox"/> Full Rejection						
Qty. est., actual rec'd. 35181K						
18b. Alternate Facility (or Generator) Manifest Reference Number: U.S. EPA ID Number						
Facility's Phone:						
18c. Signature of Alternate Facility (or Generator) Month Day Year						
19. Hazardous Waste Report Management Method Codes (i.e., codes for hazardous waste treatment, disposal, and recycling systems)						
1. H132		2.		3.		4.
20. Designated Facility Owner or Operator: Certification of receipt of hazardous materials covered by the manifest except as noted in Item 18a						
Printed/Typed Name Angela Cadwalader						
Signature <i>[Signature]</i> Month Day Year 03 20 08						



Transporter Log
CWM Chemical Services, Inc.
 Model City, NY

160904

50
 Cubic Yards

81623500

292 B3-MY

SCALE 1 115460 LB G

10:10 AM 03/20/08 12

Receipt #

Trailer License Plate # and State

Service Req. #

Profile #

Permit #

W.C. Trucking Corp.

132248

SCALE 2 35000 LB G

Transporter Name

Tractor/Trailer/Roll-off #

11:51 AM 03/20/08 12

Driver's Name

Generator

Scheduled Arrival:

Actual Arrival:

Date Time
 Date Time In Time Out
 9:59

80460P
 36496K

Arrived during Blackout? Y / N Notified DEC? Y / N

Leaker Permit Violation Placarding/Veh. I.D. Violation

Other (specify _____)

Receiving: 2
 Initials Comments

Bulk to Landfill No wet line Flatbed Stabilization Drums Tanker Transformers

Laboratory

Time In Time Out Initials Comments

Stabilization

Time In Time Out Initials Gross Wt. Comments

Landfill

Time In Time Out Initials Comments

Other

Time In Time Out Initials Comments

Aqueous Treatment

Time In Time Out Signature (NO Initials) Comments

Facility Personnel (please initial)

- _____ Smoking or eating in prohibited areas
- _____ Failure to obey instructions of facility personnel
- _____ Failure to wear appropriate PPE
- _____ Unsafe driving practices
- _____ Other (specify _____)
- _____ Leaving truck unattended
- _____ Failure to display overweight flag
- _____ Improper tarping or detarpin
- _____ Overweight upon arrival

Security Guard Initials: _____
 (Indicating receipt of Wash Bay pass, if necessary)

Driver's Comments: _____

TRL# 2450

CWMI

Please print or type. (Form designed for use on elite (12-pitch) typewriter.)

Form Approved. OMB No. 2050-0039

UNIFORM HAZARDOUS WASTE MANIFEST		1. Generator ID Number NYR000058347	2. Page 1 of 1	3. Emergency Response Phone 800-424-9300	4. Manifest Tracking Number 000364580GBF		
5. Generator's Name and Mailing Address NORTHROP GRUMMAN CORP 925 SOUTH OYSTER BAY RD, MAIL STOP W16-35 BETHPAGE NY 11714				Generator's Site Address (if different than mailing address) NORTHROP GRUMMAN AEROSPACE BLVD BETHPAGE NY 11714			
Generator's Phone: (516) 575-4680							
6. Transporter 1 Company Name PRICE TRUCKING				U.S. EPA ID Number NYD046765574			
7. Transporter 2 Company Name				U.S. EPA ID Number			
8. Designated Facility Name and Site Address CWM CHEMICAL SERVICES, L.L.C. 1550 BALMER RD. MODEL CITY NY 14107				U.S. EPA ID Number NYD049836679			
Facility's Phone: (716) 754-8231							
9a. HM	9b. U.S. DOT Description (including Proper Shipping Name, Hazard Class, ID Number, and Packing Group (if any))	10. Containers		11. Total Quantity	12. Unit Wt./Vol.	13. Waste Codes	
		No.	Type				
X	1. RQ, POLYCHLORINATED BIPHENYLS, SOLID MIXTURE, 9,UN3432,III NY296605	001	DT	EST. 2725	K	B007	
	2.						
	3.						
	4.						
14. Special Handling Instructions and Additional Information 1. NY296605 PCB Soln ERG # 171 PCB Out of Service Date 03/19/08 Weight in Section 11 is Estimated. SR# 81623520							
15. GENERATOR'S/OFFEROR'S CERTIFICATION: I hereby declare that the contents of this consignment are fully and accurately described above by the proper shipping name, and are classified, packaged, marked and labeled/placarded, and are in all respects in proper condition for transport according to applicable international and national governmental regulations. If export shipment and I am the Primary Exporter, I certify that the contents of this consignment conform to the terms of the attached EPA Acknowledgment of Consent. I certify that the waste minimization statement identified in 40 CFR 262.27(a) (if I am a large quantity generator) or (b) (if I am a small quantity generator) is true.							
Generator's/Offeror's Printed/Typed Name AGENT FOR NORTHROP GRUMMAN Signature: ERIKS Date: 03/19/08							
16. International Shipments <input type="checkbox"/> Import to U.S. <input type="checkbox"/> Export from U.S. Port of entry/exit: _____ Date leaving U.S.: _____							
17. Transporter Acknowledgment of Receipt of Materials Transporter 1 Printed/Typed Name: KOKOU TOSSAH Signature: _____ Month Day Year: 03/19/08 Transporter 2 Printed/Typed Name: _____ Signature: _____ Month Day Year: _____							
18. Discrepancy							
18a. Discrepancy Indication Space <input checked="" type="checkbox"/> Quantity <input type="checkbox"/> Type <input type="checkbox"/> Residue <input type="checkbox"/> Partial Rejection <input type="checkbox"/> Full Rejection Qty. est., actual rec'd. 36496L							
18b. Alternate Facility (or Generator) Manifest Reference Number: _____ U.S. EPA ID Number: _____							
Facility's Phone: _____							
18c. Signature of Alternate Facility (or Generator) _____ Month Day Year: _____							
19. Hazardous Waste Report Management Method Codes (i.e., codes for hazardous waste treatment, disposal, and recycling systems)							
1. H132		2.		3.		4.	
20. Designated Facility Owner or Operator: Certification of receipt of hazardous materials covered by the manifest except as noted in Item 18a Printed/Typed Name: Angela Cadwalader Signature: Angela Cadwalader Month Day Year: 03/20/08							



Transporter Log
CWM Chemical Services, Inc.
 Model City, NY

160890

50
 Cubic Yards

81623506 280233-NY
 Receipt # Trailer License Plate # and State

SCALE 1 103800 LB G
 06:14 AM 03/20/08 12

Service Req. # Profile # Permit #
 Transporter Name Tractor/Trailer/Roll-off #
 Driver's Name Generator

SCALE 2 34860 LB G
 08:04 AM 03/20/08 12

Scheduled Arrival: _____
 Actual Arrival: _____
 Date Time Date Time In Time Out

68940P
 31271K

Arrived during Blackout? Y / N Notified DEC? Y / N

Leaker Permit Violation Placarding/Veh. I.D. Violation

Other (specify _____)

Receiving: _____
Initials Comments

Bulk to Landfill No wet line Flatbed Stabilization Drums Tanker Transformers

Laboratory
 Time In Time Out Initials Comments

Stabilization
 Time In Time Out Initials Gross Wt. Comments

Landfill
 Time In Time Out Initials Comments

Other
 Time In Time Out Initials Comments

Aqueous Treatment
 Time In Time Out Signature (NO Initials) Comments

Facility Personnel (please initial)

- _____ Smoking or eating in prohibited areas
- _____ Leaving truck unattended
- _____ Failure to obey instructions of facility personnel
- _____ Failure to display overweight flag
- _____ Failure to wear appropriate PPE
- _____ Improper tarping or detarpin
- _____ Unsafe driving practices
- _____ Overweight upon arrival
- _____ Other (specify _____)

Security Guard Initials: _____
 (Indicating receipt of Wash Bay pass, if necessary)

Driver's Comments

Please print or type. (Form designed for use on elite (12-pitch) typewriter.)

Form Approved. OMB No. 2050-0039

UNIFORM HAZARDOUS WASTE MANIFEST	1. Generator ID Number NYR000058347	2. Page 1 of 1	3. Emergency Response Phone 800-424-9300	4. Manifest Tracking Number 000364581GBF
----------------------------------	--	-------------------	---	---

5. Generator's Name and Mailing Address NORTHROP GRUMMAN CORP 925 SOUTH OYSTER BAY RD, MAIL STOP W16-35 BETHPAGE NY 11714 Generator's Phone: (516) 575-4680	Generator's Site Address (if different than mailing address) NORTHROP GRUMMAN AEROSPACE BLVD BETHPAGE NY 11714
---	---

6. Transporter 1 Company Name PRICE TRUCKING	U.S. EPA ID Number NYD046765574
7. Transporter 2 Company Name	U.S. EPA ID Number

8. Designated Facility Name and Site Address CWM CHEMICAL SERVICES, L.L.C. 1550 BALMER RD. MODEL CITY NY 14107 Facility's Phone: (716) 754-8231	U.S. EPA ID Number NYD049836679
---	------------------------------------

9a. HM	9b. U.S. DOT Description (including Proper Shipping Name, Hazard Class, ID Number, and Packing Group (if any))	10. Containers		11. Total Quantity	12. Unit Wt./Vol.	13. Waste Codes		
		No.	Type					
X	1. RQ, POLYCHLORINATED BIPHENYLS, SOLID MIXTURE, 9, UN3432, III NY296605	001	DT	EST 27215	K			B007
	2.							
	3.							
	4.							

14. Special Handling Instructions and Additional Information 1. NY296605 PCB Soil PCB Out of Service Date 03/19/08 Weight in Section 11 is Estimated. SR# 81623506 ERG # 171

15. GENERATOR'S/OFFEROR'S CERTIFICATION: I hereby declare that the contents of this consignment are fully and accurately described above by the proper shipping name, and are classified, packaged, marked and labeled/placarded, and are in all respects in proper condition for transport according to applicable international and national governmental regulations. If export shipment and I am the Primary Exporter, I certify that the contents of this consignment conform to the terms of the attached EPA Acknowledgment of Consent. I certify that the waste minimization statement identified in 40 CFR 262.27(a) (if I am a large quantity generator) or (b) (if I am a small quantity generator) is true.

Generator's/Offeror's Printed/Typed Name AGENT FOR NORTHROP GRUMMAN Signature: BRUCE ELLIOTT Date: 03/19/08	Month Day Year 03 19 08
--	----------------------------

16. International Shipments <input type="checkbox"/> Import to U.S. <input type="checkbox"/> Export from U.S. Port of entry/exit: _____ Date leaving U.S.: _____
17. Transporter Acknowledgment of Receipt of Materials Transporter 1 Printed/Typed Name: Vasily Zinkiv Signature: Vasily Zinkiv Date: 03/19/08
Transporter 2 Printed/Typed Name: _____ Signature: _____ Date: _____

18. Discrepancy 18a. Discrepancy Indication Space <input checked="" type="checkbox"/> Quantity <input type="checkbox"/> Type <input type="checkbox"/> Residue <input type="checkbox"/> Partial Rejection <input type="checkbox"/> Full Rejection Qty list actual rec'd 31271K
--

18b. Alternate Facility (or Generator) Manifest Reference Number: _____ U.S. EPA ID Number: _____ Facility's Phone: _____
18c. Signature of Alternate Facility (or Generator) Month Day Year

19. Hazardous Waste Report Management Method Codes (i.e., codes for hazardous waste treatment, disposal, and recycling systems)
1. H132 2. 3. 4.

20. Designated Facility Owner or Operator: Certification of receipt of hazardous materials covered by the manifest except as noted in item 18a Printed/Typed Name: ELLIOTT CARTER Signature: Elliott Carter Date: 3/20/08	Month Day Year 3 20 08
--	---------------------------



Transporter Log
CWM Chemical Services, Inc.
 Model City, NY

160901

Cubic Yards

81623517

2801B3

Receipt #

Trailer License Plate # and State

SCALE 1 53280 LB G

09:49 AM 03/20/08 12

Service Req. #

Profile #

Permit #

PRICE Trucking

128001500

SCALE 2 34080 LB G

10:53 AM 03/20/08 12

Transporter Name

Tractor/Trailer/Roll-off #

George Acosta

NORTHROP

Driver's Name

Generator

59200P
26853K

Scheduled Arrival:

Date

Time

Actual Arrival:

Date

Time In

Time Out

Arrived during Blackout? Y / N

Notified DEC? Y / N

Leaker

Permit Violation

Placarding/Veh. I.D. Violation

Other (specify _____)

Receiving:

Initials

Comments

Bulk to Landfill

No wet line

Flatbed

Stabilization

Drums

Tanker

Transformers

Laboratory

Time In

Time Out

Initials

Comments

Stabilization

Time In

Time Out

Initials

Gross Wt.

Comments

Landfill

Time In

Time Out

Initials

Comments

Other

Time In

Time Out

Initials

Comments

Aqueous Treatment

Time In

Time Out

Signature (NO Initials)

Comments

Facility Personnel (please initial)

Smoking or eating in prohibited areas

Leaving truck unattended

Failure to obey instructions of facility personnel

Failure to display overweight flag

Failure to wear appropriate PPE

Improper tarping or detarpin

Unsafe driving practices

Overweight upon arrival

Other (specify _____)

Security Guard Initials: _____

(Indicating receipt of Wash Bay pass, if necessary)

Driver's Comments

Please print or type. (Form designed for use on elite (12-pitch) typewriter.)

Form Approved. OMB No. 2050-0039

UNIFORM HAZARDOUS WASTE MANIFEST		1. Generator ID Number NYR000058347	2. Page 1 of 1	3. Emergency Response Phone 800-424-9300	4. Manifest Tracking Number 000364582GBF	
5. Generator's Name and Mailing Address NORTHROP GRUMMAN CORP 925 SOUTH OYSTER BAY RD, MAIL STOP W16-35 BETHPAGE NY 11714			Generator's Site Address (if different than mailing address) NORTHROP GRUMMAN AEROSPACE BLVD BETHPAGE NY 11714			
Generator's Phone: (516) 575-4680						
6. Transporter 1 Company Name PRICE TRUCKING					U.S. EPA ID Number NYD046765574	
7. Transporter 2 Company Name					U.S. EPA ID Number	
8. Designated Facility Name and Site Address CWM CHEMICAL SERVICES, L.L.C. 1550 BALMER RD. MODEL CITY NY 14107					U.S. EPA ID Number NYD049836679	
Facility's Phone: (716) 754-8231						
9a. HM	9b. U.S. DOT Description (including Proper Shipping Name, Hazard Class, ID Number, and Packing Group (if any))	10. Containers		11. Total Quantity	12. Unit Wt./Vol.	13. Waste Codes
		No.	Type			
X	1. RQ, POLYCHLORINATED BIPHENYLS, SOLID MIXTURE, 9, UN3432, III NY296605	001	DT	EST 2725	K	B007
	2.					
	3.					
	4.					
14. Special Handling Instructions and Additional Information 1. NY296605 PCB Soil ERG # 171 PCB Out of Service Date 03/19/08 Weight is Section 11 is Estimated. SR# 81623517 Recd 26853K						
15. GENERATOR'S/OFFEROR'S CERTIFICATION: I hereby declare that the contents of this consignment are fully and accurately described above by the proper shipping name, and are classified, packaged, marked and labeled/placarded, and are in all respects in proper condition for transport according to applicable international and national governmental regulations. If export shipment and I am the Primary Exporter, I certify that the contents of this consignment conform to the terms of the attached EPA Acknowledgment of Consent. I certify that the waste minimization statement identified in 40 CFR 262.27(a) (if I am a large quantity generator) or (b) (if I am a small quantity generator) is true.						
Generator's/Offeror's Printed/Typed Name AGENT FOR NORTHROP GRUMMAN Signature BRUGS Signature Paula Month Day Year 03/19/08						
16. International Shipments: <input type="checkbox"/> Import to U.S. <input type="checkbox"/> Export from U.S. Port of entry/exit: _____ Date leaving U.S.: _____						
17. Transporter Acknowledgment of Receipt of Materials Transporter 1 Printed/Typed Name George Arnesen Signature [Signature] Month Day Year 03/19/08 Transporter 2 Printed/Typed Name _____ Signature _____ Month Day Year _____						
18. Discrepancy						
18a. Discrepancy Indication Space <input type="checkbox"/> Quantity <input type="checkbox"/> Type <input type="checkbox"/> Residue <input type="checkbox"/> Partial Rejection <input type="checkbox"/> Full Rejection						
18b. Alternate Facility (or Generator) Manifest Reference Number: _____ U.S. EPA ID Number _____						
Facility's Phone: _____						
18c. Signature of Alternate Facility (or Generator) _____ Month Day Year _____						
19. Hazardous Waste Report Management Method Codes (i.e., codes for hazardous waste treatment, disposal, and recycling systems)						
1. H132		2.		3.		4.
20. Designated Facility Owner or Operator: Certification of receipt of hazardous materials covered by the manifest except as noted in Item 18a Printed/Typed Name Elbert Carter Signature Elbert Carter Month Day Year 3/20/08						



Transporter Log
CWM Chemical Services, Inc.
 Model City, NY

160959

Cubic Yards

81623577

SCALE 1 106780 LB G

10:36 AM 03/25/08 12

Receipt #

Trailer License Plate # and State

NY296605 7A-025

Service Req. #

Profile #

Permit #

PRICE TRUCKING

13600-2300

Transporter Name

Tractor/Trailer/Roll-off #

KOKOU TOSEA H

NORTHROP-6211111111

Driver's Name

Generator

SCALE 2 36300 LB G

11:19 AM 03/25/08 12

Scheduled Arrival:

Date

Time

Actual Arrival:

Date

Time In

Time Out

1031

70480P

31970K

Arrived during Blackout? Y / N

Notified DEC? Y / N

Leaker

Permit Violation

Placarding/Veh. I.D. Violation

Other (specify)

Bulk to Landfill

No wet line

Flatbed

Stabilization

Drums

Tanker

Transformers

Receiving:

Initials

Comments

Laboratory

Time In

Time Out

Initials

Comments

Stabilization

Time In

Time Out

Initials

Gross Wt.

Comments

Landfill

Time In

Time Out

Initials

Comments

Other

Time In

Time Out

Initials

Comments

Aqueous Treatment

Time In

Time Out

Signature (NO Initials)

Comments

Facility Personnel (please initial)

Smoking or eating in prohibited areas

Leaving truck unattended

Failure to obey instructions of facility personnel

Failure to display overweight flag

Failure to wear appropriate PPE

Improper tarping or detarpin

Unsafe driving practices

Overweight upon arrival

Other (specify)

Security Guard Initials: _____

(Indicating receipt of Wash Bay pass, if necessary)

Driver's Comments

White: Records

Green & Canary: Accts Rec.

Pink: Environmental

Goldenrod: Driver

Please print or type. (Form designed for use on elite (12-pitch) typewriter.)

Form Approved. OMB No. 2050-0039

UNIFORM HAZARDOUS WASTE MANIFEST		1. Generator ID Number NYR000058347	2. Page 1 of 1	3. Emergency Response Phone 800-424-9300	4. Manifest Tracking Number 000364583GBF	
5. Generator's Name and Mailing Address NORTHROP GRUMMAN CORP 925 SOUTH OYSTER BAY RD, MAIL STOP W16-35 BETHPAGE NY 11714			Generator's Site Address (if different than mailing address) NORTHROP GRUMMAN AEROSPACE BLVD BETHPAGE NY 11714			
Generator's Phone: (516) 575-4680						
6. Transporter 1 Company Name PRICE TRUCKING			U.S. EPA ID Number NYD046765574			
7. Transporter 2 Company Name			U.S. EPA ID Number			
8. Designated Facility Name and Site Address CWM CHEMICAL SERVICES, L.L.C. 1550 BALMER RD. MODEL CITY NY 14107			U.S. EPA ID Number NYD049836679			
Facility's Phone: (716) 754-8231						
9a. HM	9b. U.S. DOT Description (including Proper Shipping Name, Hazard Class, ID Number, and Packing Group (if any))	10. Containers		11. Total Quantity	12. Unit Wt./Vol.	13. Waste Codes
		No.	Type			
X	1. RQ, POLYCHLORINATED BIPHENYLS, SOLID MIXTURE, 9,UN3432,III NY296605	001	DT	EST 27215	K	B007
	2.					
	3.					
	4.					
14. Special Handling Instructions and Additional Information 1. NY296605 PCB Soln ERG # 171 PCB Out of Service Date 03/20/08 Weight is Section 11 is Estimated. SR# 816 23577						
15. GENERATOR'S/OFFEROR'S CERTIFICATION: I hereby declare that the contents of this consignment are fully and accurately described above by the proper shipping name, and are classified, packaged, marked and labeled/placarded, and are in all respects in proper condition for transport according to applicable international and national governmental regulations. If export shipment and I am the Primary Exporter, I certify that the contents of this consignment conform to the terms of the attached EPA Acknowledgment of Consent. I certify that the waste minimization statement identified in 40 CFR 262.27(a) (if I am a large quantity generator) or (b) (if I am a small quantity generator) is true.						
Generator's/Offeror's Printed/Typed Name AGENT FOR NORTHROP GRUMMAN BRUCE EULAN <i>Agent for Northrop Grumman</i> 03/20/08						
16. International Shipments <input type="checkbox"/> Import to U.S. <input type="checkbox"/> Export from U.S. Port of entry/exit: _____ Date leaving: _____						
17. Transporter Acknowledgment of Receipt of Materials Transporter 1 Printed/Typed Name: KOKOU TOSSAH Signature: _____ Month Day Year: 03/20/08 Transporter 2 Printed/Typed Name: _____ Signature: _____ Month Day Year: _____						
18. Discrepancy						
18a. Discrepancy Indication Space <input checked="" type="checkbox"/> Quantity <input type="checkbox"/> Type <input type="checkbox"/> Residue <input type="checkbox"/> Partial Rejection <input type="checkbox"/> Full Rejection qty not actual recd 31970K						
18b. Alternate Facility (or Generator) _____ Manifest Reference Number: _____ U.S. EPA ID Number: _____						
Facility's Phone: _____						
18c. Signature of Alternate Facility (or Generator) _____ Month Day Year: _____						
19. Hazardous Waste Report Management Method Codes (i.e., codes for hazardous waste treatment, disposal, and recycling systems)						
1. H132		2. _____		3. _____		4. _____
20. Designated Facility Owner or Operator. Certification of receipt of hazardous materials covered by the manifest except as noted in Item 18a Printed/Typed Name: BILLY CARTER Signature: <i>Billy Carter</i> Month Day Year: 3/25/08						



Transporter Log
CWM Chemical Services, Inc.
 Model City, NY

160922

Cubic Yards

81623539

NY 2362B0

SCALE 1 103240 LB 6

Receipt #

Trailer License Plate # and State

06:17 AM 03/24/08 12

Service Req. #

Profile #

Permit #

PRICE TRUCKING CO

12612-2150

Transporter Name

Tractor/Trailer/Roll-off #

SCALE 2 31420 LB 6

Driver's Name

Generator

09:13 AM 03/24/08 12

Scheduled Arrival:

Date

Time

Actual Arrival:

Date

Time In

Time Out

Arrived during Blackout? Y / N

Notified DEC? Y / N

Leaker Permit Violation Placarding/Veh. I.D. Violation

Other (specify)

Bulk to Landfill No wet line Flatbed Stabilization Drums Tanker Transformers

Receiving: <u>[Signature]</u>
Initials _____ Comments _____

Laboratory

Time In

Time Out

Initials

Comments

Stabilization

Time In

Time Out

Initials

Gross Wt.

Comments

Landfill

Time In

Time Out

Initials

Comments

Other

Time In

Time Out

Initials

Comments

Aqueous Treatment

Time In

Time Out

Signature (NO Initials)

Comments

Facility Personnel (please initial)

Smoking or eating in prohibited areas

Leaving truck unattended

Failure to obey instructions of facility personnel

Failure to display overweight flag

Failure to wear appropriate PPE

Improper tarping or detarpin

Unsafe driving practices

Overweight upon arrival

Other (specify)

Security Guard Initials: _____

(Indicating receipt of Wash Bay pass, if necessary)

Driver's Comments: _____

White: Records

Green & Canary: Accts Rec.

Pink: Environmental

Goldenrod: Driver

Please print or type. (Form designed for use on elite (12-pitch) typewriter.)

UNIFORM HAZARDOUS WASTE MANIFEST		1. Generator ID Number NYR000058347	2. Page 1 of 1	3. Emergency Response Phone 800-424-9300	4. Manifest Tracking Number 000364584 GBF	
5. Generator's Name and Mailing Address NORTHROP GRUMMAN CORP 925 SOUTH OYSTER BAY RD, MAIL STOP W16-35 BETHPAGE NY 11714			Generator's Site Address (if different than mailing address) NORTHROP GRUMMAN AEROSPACE BLVD BETHPAGE NY 11714			
Generator's Phone: (516) 575-4680						
6. Transporter 1 Company Name PRICE TRUCKING					U.S. EPA ID Number NYD046765574	
7. Transporter 2 Company Name					U.S. EPA ID Number	
8. Designated Facility Name and Site Address CWM CHEMICAL SERVICES, L.L.C. 1550 BALMER RD. MODEL CITY NY 14107					U.S. EPA ID Number NYD049836679	
Facility's Phone: (716) 754-8231						
9a. HM	9b. U.S. DOT Description (including Proper Shipping Name, Hazard Class, ID Number, and Packing Group (if any))	10. Containers		11. Total Quantity	12. Unit Wt./Vol.	13. Waste Codes
		No.	Type			
X	1. RQ, POLYCHLORINATED BIPHENYLS, SOLID MIXTURE, 9, UN3432, III NY296605	001	DT	EST 27215	K	B007
	2.					
	3.					
	4.					
14. Special Handling Instructions and Additional Information 1. NY296605 PCB Soil ERG # 171 PCB Out of Service Date 03/20/08 Weight is Section 11 is Estimated. SR# 81623539						
15. GENERATOR'S/OFFEROR'S CERTIFICATION: I hereby declare that the contents of this consignment are fully and accurately described above by the proper shipping name, and are classified, packaged, marked and labeled/placarded, and are in all respects in proper condition for transport according to applicable international and national governmental regulations. If export shipment and I am the Primary Exporter, I certify that the contents of this consignment conform to the terms of the attached EPA Acknowledgment of Consent. I certify that the waste minimization statement identified in 40 CFR 262.27(a) (if I am a large quantity generator) or (b) (if I am a small quantity generator) is true.						
Generator's/Offlor's Printed/Typed Name ABOUT FOR NORTHROP GRUMMAN Signature: BRUCE EVANS Date: 03/20/08						
16. International Shipments: <input type="checkbox"/> Import to U.S. <input type="checkbox"/> Export from U.S. Port of entry/exit: _____ Date leaving U.S.: _____						
17. Transporter Acknowledgment of Receipt of Materials						
Transporter 1 Printed/Typed Name ANANI GOBZHANOV			Signature <i>[Signature]</i>		Month Day Year 03 20 08	
Transporter 2 Printed/Typed Name			Signature		Month Day Year	
18. Discrepancy						
18a. Discrepancy Indication Space <input checked="" type="checkbox"/> Quantity <input type="checkbox"/> Type <input type="checkbox"/> Residue <input type="checkbox"/> Partial Rejection <input type="checkbox"/> Full Rejection qty est actual recd 32571K						
18b. Alternate Facility (or Generator) Manifest Reference Number: _____ U.S. EPA ID Number _____						
Facility's Phone: _____						
18c. Signature of Alternate Facility (or Generator) _____ Month Day Year _____						
19. Hazardous Waste Report Management Method Codes (i.e., codes for hazardous waste treatment, disposal, and recycling systems)						
1. H132		2.		3.		4.
20. Designated Facility Owner or Operator: Certification of receipt of hazardous materials covered by the manifest except as noted in Item 18a						
Printed/Typed Name ELLEN CARTER			Signature <i>[Signature]</i>		Month Day Year 3 24 08	



Transporter Log
CWM Chemical Services, Inc.
 Model City, NY

160932

40
 Cubic Yards

81623549 Receipt # 262B2 N.Y. Trailer License Plate # and State

SCALE 1 96540 LB G
 09:38 AM 03/24/08 12

M221665 Profile # 9A-25 Permit #
Pine Trucking Corp. Service Req. # 13000, 2400 Tractor/Trailer/Roll-off #
Maude Miles Transporter Name Northrop Commercial Corp. Generator
Maude Miles Driver's Name

SCALE 2 35600 LB G
 11:03 AM 03/24/08 12

Scheduled Arrival: _____
 Actual Arrival: _____
 Date Time Date Time In Time Out

60940P
27642K

Arrived during Blackout? Y / N Notified DEC? Y / N

Leaker Permit Violation Placarding/Veh. I.D. Violation

Other (specify _____)

Sulk to Landfill No wet line Flatbed Stabilization Drums Tanker Transformers

Receiving:
 Initials Comments

Laboratory
 Time In Time Out Initials Comments

Stabilization
 Time In Time Out Initials Gross Wt. Comments

Landfill
 Time In Time Out Initials Comments

Other
 Time In Time Out Initials Comments

Aqueous Treatment
 Time In Time Out Signature (NO Initials) Comments

Facility Personnel (please initial)

- _____ Smoking or eating in prohibited areas
- _____ Failure to obey instructions of facility personnel
- _____ Failure to wear appropriate PPE
- _____ Unsafe driving practices
- _____ Other (specify) _____
- _____ Leaving truck unattended
- _____ Failure to display overweight flag
- _____ Improper tarping or detarpin
- _____ Overweight upon arrival

Security Guard Initials: _____
 (Indicating receipt of Wash Bay pass, if necessary)

Driver's Comments: _____

Please print or type. (Form designed for use on elite (12-pitch) typewriter.)

Form Approved. OMB No. 2050-0039

UNIFORM HAZARDOUS WASTE MANIFEST		1. Generator ID Number NYR000058347	2. Page 1 of 1	3. Emergency Response Phone 800-424-9300	4. Manifest Tracking Number 000364587GBF		
5. Generator's Name and Mailing Address NORTHROP GRUMMAN CORP 925 SOUTH OYSTER BAY RD, MAIL STOP W16-35 BETHPAGE NY 11714			Generator's Site Address (if different than mailing address) NORTHROP GRUMMAN AEROSPACE BLVD BETHPAGE NY 11714				
Generator's Phone: (516) 575-4680							
6. Transporter 1 Company Name PRICE TRUCKING			U.S. EPA ID Number NYD046765574				
7. Transporter 2 Company Name			U.S. EPA ID Number				
8. Designated Facility Name and Site Address CWM CHEMICAL SERVICES, L.L.C. 1550 BALMER RD. MODEL CITY NY 14107			U.S. EPA ID Number NYD049836679				
Facility's Phone: (716) 754-8231							
9a. HM	9b. U.S. DOT Description (including Proper Shipping Name, Hazard Class, ID Number, and Packing Group (if any))	10. Containers		11. Total Quantity	12. Unit Wt./Vol.	13. Waste Codes	
		No.	Type				
X	1. RO, POLYCHLORINATED BIPHENYLS, SOLID MIXTURE, 9, UN3432, III NY296605	001	DT	EST 27215	K		B007
	2.						
	3.						
	4.						
14. Special Handling Instructions and Additional Information 1. NY296605 PCB SOLID ERG #171 PCB Out of Service Date 03/20/08 Weight in Section 11 is Estimated. SR# 81623549 Recd 27642R							
15. GENERATOR'S/OFFEROR'S CERTIFICATION: I hereby declare that the contents of this consignment are fully and accurately described above by the proper shipping name, and are classified, packaged, marked and labeled/placarded, and are in all respects in proper condition for transport according to applicable international and national governmental regulations. If export shipment and I am the Primary Exporter, I certify that the contents of this consignment conform to the terms of the attached EPA Acknowledgment of Consent. I certify that the waste minimization statement identified in 40 CFR 262.27(a) (if I am a large quantity generator) or (b) (if I am a small quantity generator) is true. Generator's/Officer's Printed/Typed Name: AGENT FOR NORTHROP GRUMMAN Signature: EULIAN Month: 03 Day: 20 Year: 08							
16. International Shipments <input type="checkbox"/> Import to U.S. <input type="checkbox"/> Export from U.S. Port of entry/exit: _____ Date leaving U.S.: _____							
17. Transporter Acknowledgment of Receipt of Materials Transporter 1 Printed/Typed Name: Monte Miles Signature: Monte Miles Month: 03 Day: 20 Year: 08 Transporter 2 Printed/Typed Name: _____ Signature: _____ Month: _____ Day: _____ Year: _____							
18. Discrepancy							
18a. Discrepancy Indication Space <input type="checkbox"/> Quantity <input type="checkbox"/> Type <input type="checkbox"/> Residue <input type="checkbox"/> Partial Rejection <input type="checkbox"/> Full Rejection							
18b. Alternate Facility (or Generator) Manifest Reference Number: _____ U.S. EPA ID Number: _____							
Facility's Phone: _____							
18c. Signature of Alternate Facility (or Generator) _____ Month: _____ Day: _____ Year: _____							
19. Hazardous Waste Report Management Method Codes (i.e., codes for hazardous waste treatment, disposal, and recycling systems)							
1. H132		2.		3.		4.	
20. Designated Facility Owner or Operator: Certification of receipt of hazardous materials covered by the manifest except as noted in Item 18a Printed/Typed Name: EILEEN CARTON Signature: Eileen Carton Month: 3 Day: 24 Year: 08							



Transporter Log
CWM Chemical Services, Inc.
 Model City, NY

160948

Cubic Yards

81623565

2802B3-NY

Receipt #

Trailer License Plate # and State

SCALE 2 105140 LB G

06:21 AM 03/25/08 12

Service Req. #

Profile #

Permit #

PRICE, TRUCKING

13600-2450

SCALE 2 35340 LB G

08:08 AM 03/25/08 12

Transporter Name

Tractor/Trailer/Roll-off #

KOKOU TOSSAH

NORTHROP GRUNMAN CORP

Driver's Name

Generator

Scheduled Arrival:

Date

Time

Actual Arrival:

Date

Time In

Time Out

69800P

31661K

Arrived during Blackout? Y / N

Notified DEC? Y / N

Leaker Permit Violation Placarding/Veh. I.D. Violation

Other (specify _____)

Bulk to Landfill No wet line Flatbed Stabilization Drums Tanker Transformers

Receiving: <u> </u>
Initials Comments

Laboratory

Time In	Time Out	Initials	Comments

Stabilization

Time In	Time Out	Initials	Gross Wt.	Comments

Landfill

Time In	Time Out	Initials	Comments

Other

Time In	Time Out	Initials	Comments

Aqueous Treatment

Time In	Time Out	Signature (NO Initials)	Comments

Facility Personnel (please initial)

- | | |
|--|--|
| _____ Smoking or eating in prohibited areas | _____ Leaving truck unattended |
| _____ Failure to obey instructions of facility personnel | _____ Failure to display overweight flag |
| _____ Failure to wear appropriate PPE | _____ Improper tarping or detarpin |
| _____ Unsafe driving practices | _____ Overweight upon arrival |
| _____ Other (specify _____) | |

Security Guard Initials: _____
 (Indicating receipt of Wash Bay pass, if necessary)

Driver's Comments

Please print or type. (Form designed for use on elite (12-pitch) typewriter.)

Form Approved. OMB No. 2050-0039

UNIFORM HAZARDOUS WASTE MANIFEST	1. Generator ID Number NYR000058347	2. Page 1 of 1	3. Emergency Response Phone 800-424-9300	4. Manifest Tracking Number 000364589GBF
---	---	--------------------------	--	--

5. Generator's Name and Mailing Address NORTHROP GRUMMAN CORP 925 SOUTH OYSTER BAY RD, MAIL STOP W16-35 BETHPAGE NY 11714	Generator's Site Address (if different than mailing address) NORTHROP GRUMMAN AEROSPACE BLVD BETHPAGE NY 11714
Generator's Phone: (516) 575-4680	

6. Transporter 1 Company Name PRICE TRUCKING	U.S. EPA ID Number NYD046765574
--	---

7. Transporter 2 Company Name	U.S. EPA ID Number
-------------------------------	--------------------

8. Designated Facility Name and Site Address CWM CHEMICAL SERVICES, L.L.C. 1550 BALMER RD. MODEL CITY NY 14107	U.S. EPA ID Number NYD049836679
Facility's Phone: (716) 754-8231	

9a. HM	9b. U.S. DOT Description (including Proper Shipping Name, Hazard Class, ID Number, and Packing Group (if any))	10. Containers		11. Total Quantity	12. Unit WT./Vol.	13. Waste Codes		
		No.	Type					
X	1. RQ, POLYCHLORINATED BIPHENYLS, SOLID MIXTURE, 9, UN3432, III NY296605	001	DT	EST. 2715	K		B007	
	2.							
	3.							
	4.							

14. Special Handling Instructions and Additional Information 1. NY296605 PCB Soil ERG #171 PCB Out of Service Date 03/24/09 Weight is Section 11 is Estimated. SR# 81623565
--

15. GENERATOR'S/OFFEROR'S CERTIFICATION: I hereby declare that the contents of this consignment are fully and accurately described above by the proper shipping name, and are classified, packaged, marked and labeled/placarded, and are in all respects in proper condition for transport according to applicable international and national governmental regulations. If export shipment and I am the Primary Exporter, I certify that the contents of this consignment conform to the terms of the attached EPA Acknowledgment of Consent. I certify that the waste minimization statement identified in 40 CFR 262.27(a) (if I am a large quantity generator) or (b) (if I am a small quantity generator) is true.

Generator's/Offoror's Printed/Typed Name AGENT FOR NORTHROP GRUMMAN EVLIAN	Signature <i>[Signature]</i>	Month 03	Day 24	Year 08
--	---------------------------------	--------------------	------------------	-------------------

16. International Shipments <input type="checkbox"/> Import to U.S. <input type="checkbox"/> Export from U.S.	Port of entry/exit: Date leaving U.S.:
--	---

17. Transporter Acknowledgment of Receipt of Materials	Signature	Month	Day	Year
Transporter 1 Printed/Typed Name KOKOU TOSSAH	<i>[Signature]</i>	03	24	08
Transporter 2 Printed/Typed Name	Signature	Month	Day	Year

18. Discrepancy
18a. Discrepancy Indication Space <input checked="" type="checkbox"/> Quantity <input type="checkbox"/> Type <input type="checkbox"/> Residue <input type="checkbox"/> Partial Rejection <input type="checkbox"/> Full Rejection

18b. Alternate Facility (or Generator) qty est actual recd 31661K	Manifest Reference Number:	U.S. EPA ID Number
Facility's Phone:		

18c. Signature of Alternate Facility (or Generator)	Month	Day	Year
---	-------	-----	------

19. Hazardous Waste Report Management Method Codes (i.e., codes for hazardous waste treatment, disposal, and recycling systems)			
1. H132	2.	3.	4.

20. Designated Facility Owner or Operator: Certification of receipt of hazardous materials covered by the manifest except as noted in Item 18a				
Printed/Typed Name BILLEN CARTER	Signature <i>[Signature]</i>	Month 3	Day 25	Year 08



Transporter Log
CWM Chemical Services, Inc.
 Model City, NY

160957

50
 Cubic Yards

91623575
 Receipt #

2801R3-NY
 Trailer License Plate # and State

SCALE 1 110960 LB 6
 09:40 AM 03/25/08 12

Service Req. # P102 Profile # _____ Permit # _____
 Transporter Name TRAVIS Z Tractor/Trailer/Roll-off # R200-200
 Driver's Name _____ Generator 10/1/08

SCALE 2 35060 LB 6
 10:51 AM 03/25/08 12

Scheduled Arrival: _____
 Actual Arrival: _____
 Date _____ Time _____
 Date _____ Time In _____ Time Out _____

75900P
34428K

Arrived during Blackout? Y / N Notified DEC? Y / N

Leaker Permit Violation Placarding/Veh. I.D. Violation

Other (specify _____)

Receiving: _____	
Initials	Comments

Bulk to Landfill No wet line Flatbed Stabilization Drums Tanker Transformers

Laboratory
 Time In _____ Time Out _____ Initials _____ Comments _____

Stabilization
 Time In _____ Time Out _____ Initials _____ Gross Wt. _____ Comments _____

Landfill
 Time In _____ Time Out _____ Initials _____ Comments _____

Other
 Time In _____ Time Out _____ Initials _____ Comments _____

Aqueous Treatment
 Time In _____ Time Out _____ Signature (NO Initials) _____ Comments _____

Facility Personnel (please initial)

- | | |
|--|---|
| _____ Smoking or eating in prohibited areas | _____ Leaving truck unattended |
| _____ Failure to obey instructions of facility personnel | _____ Failure to display overweight flag |
| _____ Failure to wear appropriate PPE | _____ Improper tarping or detarpin |
| _____ Unsafe driving practices | <input checked="" type="checkbox"/> Overweight upon arrival |
| _____ Other (specify _____) | |

Security Guard Initials: _____
 (Indicating receipt of Wash Bay pass, if necessary)

Driver's Comments _____

Please print or type. (Form designed for use on elite (12-pitch) typewriter.)

Form Approved. OMB No. 2050-0039

UNIFORM HAZARDOUS WASTE MANIFEST		1. Generator ID Number NYR000058347	2. Page 1 of 1	3. Emergency Response Phone 800-424-9300	4. Manifest Tracking Number 000364590GBF	
5. Generator's Name and Mailing Address NORTHROP GRUMMAN CORP 925 SOUTH OYSTER BAY RD, MAIL STOP W16-35 BETHPAGE NY 11714			Generator's Site Address (if different than mailing address) NORTHROP GRUMMAN AEROSPACE BLVD BETHPAGE NY 11714			
Generator's Phone: (516) 575-4680						
6. Transporter 1 Company Name PRICE TRUCKING				U.S. EPA ID Number NYR046765574		
7. Transporter 2 Company Name				U.S. EPA ID Number		
8. Designated Facility Name and Site Address CWM CHEMICAL SERVICES, L.L.C. 1550 BALMER RD. MODEL CITY NY 14107				U.S. EPA ID Number NYD049836679		
Facility's Phone: (716) 754-8231						
9a. HM	9b. U.S. DOT Description (including Proper Shipping Name, Hazard Class, ID Number, and Packing Group (if any))	10. Containers		11. Total Quantity	12. Unit Wt./Vol.	13. Waste Codes
		No.	Type			
X	RQ, POLYCHLORINATED BIPHENYLS, SOLID MIXTURE, 9, UN3432, III NY296605	001	DT	EST 2725	K	B007
14. Special Handling Instructions and Additional Information 1. NY296605 PCB Soil ERG # 171 PCB Out of Service Date 03/24/08 Weight Is Section 11 is Estimated. SR# 81623575						
15. GENERATOR'S/OFFEROR'S CERTIFICATION: I hereby declare that the contents of this consignment are fully and accurately described above by the proper shipping name, and are classified, packaged, marked and labeled/placarded, and are in all respects in proper condition for transport according to applicable international and national governmental regulations. If export shipment and I am the Primary Exporter, I certify that the contents of this consignment conform to the terms of the attached EPA Acknowledgment of Consent. I certify that the waste minimization statement identified in 40 CFR 262.27(a) (if I am a large quantity generator) or (b) (if I am a small quantity generator) is true.						
Generator's/Offoror's Printed/Typed Name AGENT FOR NORTHROP GRUMMAN ELLEN CARTER Signature Month Day Year 03 24 08						
16. International Shipments <input type="checkbox"/> Import to U.S. <input type="checkbox"/> Export from U.S. Port of entry/exit: _____ Date leaving U.S.: _____						
17. Transporter Acknowledgment of Receipt of Materials						
Transporter 1 Printed/Typed Name NAN ZWKN			Signature 		Month Day Year 03 24 08	
Transporter 2 Printed/Typed Name			Signature		Month Day Year	
18. Discrepancy						
18a. Discrepancy Indication Space <input checked="" type="checkbox"/> Quantity <input type="checkbox"/> Type <input type="checkbox"/> Residue <input type="checkbox"/> Partial Rejection <input type="checkbox"/> Full Rejection qty est actual held 34428K Manifest Reference Number: _____						
18b. Alternate Facility (or Generator)					U.S. EPA ID Number	
Facility's Phone:						
18c. Signature of Alternate Facility (or Generator)					Month Day Year	
19. Hazardous Waste Report Management Method Codes (i.e., codes for hazardous waste treatment, disposal, and recycling systems)						
1. H132		2.		3.		4.
20. Designated Facility Owner or Operator: Certification of receipt of hazardous materials covered by the manifest except as noted in Item 18a						
Printed/Typed Name ELLEN CARTER					Signature 	
					Month Day Year 03 25 08	



Transporter Log
CWM Chemical Services, Inc.
 Model City, NY

160958

50
 Cubic Yards

81623506

28-283-NH

SCALE 1 106520 LB G
 09:52 AM 03/25/08 T2

Receipt #

Trailer License Plate # and State

Service Req. #

Profile #

Permit #

Transporter Name

Tractor/Trailer/Roll-off #

Driver's Name

Generator

SCALE 2 34900 LB G
 10:57 AM 03/25/08 T2

Scheduled Arrival:

Date

Time

Actual Arrival:

Date

Time In

Time Out

171620P
 32487K

Arrived during Blackout? Y / N

Notified DEC? Y / N

Leaker

Permit Violation

Placarding/Veh. I.D. Violation

Other (specify)

Bulk to Landfill

No wet line

Flatbed

Stabilization

Drums

Tanker

Transformers

Receiving:

[Signature]
 Initials

Comments

Laboratory

Time In

Time Out

Initials

Comments

Stabilization

Time In

Time Out

Initials

Gross Wt.

Comments

Landfill

Time In

Time Out

Initials

Comments

Other

Time In

Time Out

Initials

Comments

Aqueous Treatment

Time In

Time Out

Signature (NO Initials)

Comments

Facility Personnel (please initial)

Smoking or eating in prohibited areas

Leaving truck unattended

Failure to obey instructions of facility personnel

Failure to display overweight flag

Failure to wear appropriate PPE

Improper tarping or detarpin

Unsafe driving practices

Overweight upon arrival

Other (specify)

Security Guard Initials:

(Indicating receipt of Wash Bay pass, if necessary)

Driver's Comments

Please print or type. (Form designed for use on elite (12-pitch) typewriter.)

Form Approved. OMB No. 2050-0039

UNIFORM HAZARDOUS WASTE MANIFEST		1. Generator ID Number NYR000058347	2. Page 1 of 1	3. Emergency Response Phone 200-424-9300	4. Manifest Tracking Number 000364591GBF	
5. Generator's Name and Mailing Address NORTHROP GRUMMAN CORP 925 SOUTH OYSTER BAY RD. MAIL STOP W16-35 BETHPAGE NY 11714			Generator's Site Address (if different than mailing address) NORTHROP GRUMMAN AEROSPACE BLVD BETHPAGE NY 11714			
Generator's Phone: (516) 575-4680						
6. Transporter 1 Company Name PRICE TRUCKING				U.S. EPA ID Number NYD046765574		
7. Transporter 2 Company Name				U.S. EPA ID Number		
8. Designated Facility Name and Site Address CWM CHEMICAL SERVICES, L.L.C. 1550 BALMER RD. MODEL CITY NY 14107				U.S. EPA ID Number NYD049836679		
Facility's Phone: (716) 754-8231						
9a. HM	9b. U.S. DOT Description (including Proper Shipping Name, Hazard Class, ID Number, and Packing Group (if any))	10. Containers		11. Total Quantity	12. Unit Wt./Vol.	13. Waste Codes
		No.	Type			
X	1. RQ, POLYCHLORINATED BIPHENYLS, SOLID MIXTURE, 9,UN3432,III NY296605	001	DT	EST 27215	K	E007
	2.					
	3.					
	4.					
14. Special Handling Instructions and Additional Information 1. NY296605 PCB Soil ERG # 171 PCB Out of Service Date 03/24/08 Weight in Section 11 is Estimated. SR# 91623574						
15. GENERATOR'S/OFFEROR'S CERTIFICATION: I hereby declare that the contents of this consignment are fully and accurately described above by the proper shipping name, and are classified, packaged, marked and labeled/placarded, and are in all respects in proper condition for transport according to applicable international and national governmental regulations. If export shipment and I am the Primary Exporter, I certify that the contents of this consignment conform to the terms of the attached EPA Acknowledgment of Consent. I certify that the waste minimization statement identified in 40 CFR 262.27(a) (if I am a large quantity generator) or (b) (if I am a small quantity generator) is true.						
Generator's/Offoror's Printed/Typed Name AGENT FOR NORTHROP GRUMMAN EQUIPMENT Signature Eric Northrop Grumman Month Day Year 10/3/24/08						
16. International Shipments <input type="checkbox"/> Import to U.S. <input type="checkbox"/> Export from U.S. Port of entry/exit: Date leaving U.S.:						
17. Transporter Acknowledgment of Receipt of Materials						
Transporter 1 Printed/Typed Name Vasili Zinkiv			Signature Vasili Zinkiv		Month Day Year 03/24/08	
Transporter 2 Printed/Typed Name			Signature		Month Day Year	
18. Discrepancy						
18a. Discrepancy Indication Space <input checked="" type="checkbox"/> Quantity <input type="checkbox"/> Type <input type="checkbox"/> Residue <input type="checkbox"/> Partial Rejection <input type="checkbox"/> Full Rejection qty est actual recd 32487K Manifest Reference Number:						
18b. Alternate Facility (or Generator)				U.S. EPA ID Number		
Facility's Phone:						
18c. Signature of Alternate Facility (or Generator)				Month Day Year		
19. Hazardous Waste Report Management Method Codes (i.e., codes for hazardous waste treatment, disposal, and recycling systems)						
1. H132		2.		3.		4.
20. Designated Facility Owner or Operator: Certification of receipt of hazardous materials covered by the manifest except as noted in Item 18a						
Printed/Typed Name Allen Carter			Signature Allen Carter		Month Day Year 3/25/08	



Transporter Log
CWM Chemical Services, Inc.
 Model City, NY

160961

Cubic Yards

81623579 285903 N.Y.
 Receipt # NY 12001 GA-025
 Trailer License Plate # and State
 Service Req. # PRICE TRUCKING CORP. Profile # 11800/2250 Permit #
 Transporter Name DENNIS SIMPSON Tractor/Trailer/Roll-off #
 Driver's Name WERTHROP GRUMMAN CORP. Generator

SCALE 1 96760 LB G
 11:09 AM 03/25/08 12

SCALE 2 30320 LB G
 12:25 PM 03/25/08 12

Scheduled Arrival: _____
 Date Time
 Actual Arrival: 11:01
 Date Time In Time Out

66440P
30137K

Arrived during Blackout? Y / N Notified DEC? Y / N

- Leaker Permit Violation Placarding/Veh. I.D. Violation
 Other (specify _____)

Receiving: [Signature]
 Initials Comments

- Bulk to Landfill No wet line Flatbed Stabilization Drums Tanker Transformers

Laboratory _____
 Time In Time Out Initials Comments

Stabilization _____
 Time In Time Out Initials Gross Wt. Comments

Landfill _____
 Time In Time Out Initials Comments

Other _____
 Time In Time Out Initials Comments

Aqueous Treatment _____
 Time In Time Out Signature (NO Initials) Comments

Facility Personnel (please initial)

- | | |
|--|--|
| _____ Smoking or eating in prohibited areas | _____ Leaving truck unattended |
| _____ Failure to obey instructions of facility personnel | _____ Failure to display overweight flag |
| _____ Failure to wear appropriate PPE | _____ Improper tarping or detarpin |
| _____ Unsafe driving practices | _____ Overweight upon arrival |
| _____ Other (specify _____) | |

Security Guard Initials: _____
 (Indicating receipt of Wash Bay pass, if necessary)

Driver's Comments _____

Please print or type. (Form designed for use on elite (12-pitch) typewriter.)

Form Approved. OMB No. 2050-0039

UNIFORM HAZARDOUS WASTE MANIFEST		1. Generator ID Number NYR000058347	2. Page 1 of 1	3. Emergency Response Phone 800-424-9300	4. Manifest Tracking Number 000364592GBF	
5. Generator's Name and Mailing Address NORTHROP GRUMMAN CORP 925 SOUTH OYSTER BAY RD, MAIL STOP W16-35 BETHPAGE NY 11714			Generator's Site Address (if different than mailing address) NORTHROP GRUMMAN AEROSPACE BLVD BETHPAGE NY 11714			
Generator's Phone: (516) 575-4680						
6. Transporter 1 Company Name PRICE TRUCKING			U.S. EPA ID Number NYD046765574			
7. Transporter 2 Company Name			U.S. EPA ID Number			
8. Designated Facility Name and Site Address CWM CHEMICAL SERVICES, L.L.C. 1550 BALMER RD. MODEL CITY NY 14107			U.S. EPA ID Number NYD049836679			
Facility's Phone: (716) 754-8231						
9a. HM	9b. U.S. DOT Description (including Proper Shipping Name, Hazard Class, ID Number, and Packing Group (if any))	10. Containers No. Type		11. Total Quantity	12. Unit Wt./Vol.	13. Waste Codes
X	1. RO, POLYCHLORINATED BIPHENYLS, SOLID MIXTURE, 9,UN3432,III NY296605	001	DT	EST 27215	K	B007
	2.					
	3.					
	4.					
14. Special Handling Instructions and Additional Information 1. NY296605 PCB Soil ERG #171 PCB Out of Service Date 03/24/08 Weight in Section 11 is Estimated. SR# 81623579						
15. GENERATOR'S/OFFEROR'S CERTIFICATION: I hereby declare that the contents of this consignment are fully and accurately described above by the proper shipping name, and are classified, packaged, marked and labeled/placarded, and are in all respects in proper condition for transport according to applicable international and national governmental regulations. If export shipment and I am the Primary Exporter, I certify that the contents of this consignment conform to the terms of the attached EPA Acknowledgment of Consent. I certify that the waste minimization statement identified in 40 CFR 262.27(a) (if I am a large quantity generator) or (b) (if I am a small quantity generator) is true.						
Generator's/Offeror's Printed/Typed Name ALBERT FOR NORTHROP GRUMMAN EVAN Signature Month Day Year 03 24 08						
16. International Shipments <input type="checkbox"/> Import to U.S. <input type="checkbox"/> Export from U.S. Port of entry/exit: Date leaving U.S.:						
17. Transporter Acknowledgment of Receipt of Materials Transporter 1 Printed/Typed Name DENNIS SIMPSON Signature Month Day Year 03 24 08 Transporter 2 Printed/Typed Name Signature Month Day Year						
18. Discrepancy 18a. Discrepancy Indication Space <input checked="" type="checkbox"/> Quantity <input type="checkbox"/> Type <input type="checkbox"/> Residue <input type="checkbox"/> Partial Rejection <input type="checkbox"/> Full Rejection qty est actual recd 30137						
18b. Alternate Facility (or Generator) Manifest Reference Number: U.S. EPA ID Number						
Facility's Phone: 18c. Signature of Alternate Facility (or Generator) Month Day Year						
19. Hazardous Waste Report Management Method Codes (i.e., codes for hazardous waste treatment, disposal, and recycling systems)						
1.	2.	3.	4.			
1.	H132					
20. Designated Facility Owner or Operator. Certification of receipt of hazardous materials covered by the manifest except as noted in Item 18a						
Printed/Typed Name ETLEON CARTER Signature Month Day Year 3 25 08						



Transporter Log
CWM Chemical Services, Inc.
 Model City, NY

160967

Cubic Yards

81623534 2604R2-NV
 Receipt # Trailer License Plate # and State
 86951L NY296605 9A-025
 Service Req. # Profile # Permit #
 PRICE TRUCKING 13600-2350
 Transporter Name Tractor/Trailer/Roll-off #
 KOKIL TOSSAIA NORTHROP-GRIFFIN, CORP
 Driver's Name Generator

SCALE 1 111400 LB G
 06:05 AM 03/26/08 12

SCALE 2 36260 LB G
 07:58 AM 03/26/08 12

Scheduled Arrival: _____
 Date Time
 Actual Arrival: _____
 Date Time In Time Out

75140P
 34033R

Arrived during Blackout? Y / N Notified DEC? Y / N

Receiving: _____	_____
Initials	Comments

Leaker Permit Violation Placarding/Veh. I.D. Violation

Other (specify _____)

Bulk to Landfill No wet line Flatbed Stabilization Drums Tanker Transformers

Laboratory
 Time In Time Out Initials Comments

Stabilization
 Time In Time Out Initials Gross Wt. Comments

Landfill
 Time In Time Out Initials Comments

Other
 Time In Time Out Initials Comments

Aqueous Treatment
 Time In Time Out Signature (NO Initials) Comments

07-331
 11/7 2008

Facility Personnel (please initial)

- | | |
|--|--|
| _____ Smoking or eating in prohibited areas | _____ Leaving truck unattended |
| _____ Failure to obey instructions of facility personnel | _____ Failure to display overweight flag |
| _____ Failure to wear appropriate PPE | _____ Improper tarping or detarpin |
| _____ Unsafe driving practices | ✓ _____ Overweight upon arrival |
| _____ Other (specify _____) | |

Security Guard Initials: _____
 (Indicating receipt of Wash Bay pass, if necessary)

Driver's Comments

2350 Price 5:45am

CWMI

Please print or type. (Form designed for use on elite (12-pitch) typewriter.) Form Approved. OMB No. 2050-0039

UNIFORM HAZARDOUS WASTE MANIFEST		1. Generator ID Number NY R 0 0 0 0 5 8 3 4 7	2. Page 1 of 1	3. Emergency Response Phone 800-424-9300	4. Manifest Tracking Number 000364585GBF						
5. Generator's Name and Mailing Address NORTHROP GRUMMAN CORP 925 SOUTH OYSTER BAY RD, MAIL STOP W16-35 BETHPAGE NY 11714 Generator's Phone: (516) 575-4680				Generator's Site Address (if different than mailing address) NORTHROP GRUMMAN AEROSPACE BLVD BETHPAGE NY 11714							
6. Transporter 1 Company Name PRICE TRUCKING					U.S. EPA ID Number NYD046765574						
7. Transporter 2 Company Name					U.S. EPA ID Number						
8. Designated Facility Name and Site Address CWM CHEMICAL SERVICES, L.L.C. 1550 BALMER RD. MODEL CITY NY 14107 Facility's Phone: (716) 754-8231					U.S. EPA ID Number NYD049836679						
9a. HM	9b. U.S. DOT Description (including Proper Shipping Name, Hazard Class, ID Number, and Packing Group (if any))			10. Containers No. Type		11. Total Quantity	12. Unit Wt./Vol.	13. Waste Codes			
X	1. RQ, POLYCHLORINATED BIPHENYLS, SOLID MIXTURE, 9, UN3432, III NY296605			001	DT	EST. 27215	K	B007			
	2.										
	3.										
	4.										
14. Special Handling Instructions and Additional Information T. NY296605 PCB Soil ERG # 171 PCB Out of Service Date 03/20/08 Weight in Section 11 is Estimated. SR# 869514 81623584											
15. GENERATOR'S/OFFEROR'S CERTIFICATION: I hereby declare that the contents of this consignment are fully and accurately described above by the proper shipping name, and are classified, packaged, marked and labeled/placarded, and are in all respects in proper condition for transport according to applicable international and national governmental regulations. If export shipment and I am the Primary Exporter, I certify that the contents of this consignment conform to the terms of the attached EPA Acknowledgment of Consent. I certify that the waste minimization statement identified in 40 CFR 262.27(a) (if I am a large quantity generator) or (b) (if I am a small quantity generator) is true.											
Generator's/Offeror's Printed/Typed Name AGENT FOR NORTHROP GRUMMAN Signature: ERIC BRUCE Date: 03/20/08											
16. International Shipments <input type="checkbox"/> Import to U.S. <input type="checkbox"/> Export from U.S. Port of entry/exit: _____ Date leaving U.S.: _____											
17. Transporter Acknowledgment of Receipt of Materials Transporter 1 Printed/Typed Name: JAMES SIMPSON Signature: James Simpson Date: 03/19/08 Transporter 2 Printed/Typed Name: KOKOU TOSSAH Signature: Kokou Tossah Date: 03/26/08											
18. Discrepancy 18a. Discrepancy Indication Space <input checked="" type="checkbox"/> Quantity <input type="checkbox"/> Type <input type="checkbox"/> Residue <input type="checkbox"/> Partial Rejection <input type="checkbox"/> Full Rejection qty est actual recd 34083K Manifest Reference Number: _____											
18b. Alternate Facility (or Generator) Facility's Phone: _____ U.S. EPA ID Number: _____											
18c. Signature of Alternate Facility (or Generator) Month Day Year											
19. Hazardous Waste Report Management Method Codes (i.e., codes for hazardous waste treatment, disposal, and recycling systems)											
1. H132			2. ---			3. ---			4. ---		
20. Designated Facility Owner or Operator: Certification of receipt of hazardous materials covered by the manifest except as noted in item 18a Printed/Typed Name: ERIC CARTER Signature: Eric Carter Date: 3/26/08											



Transporter Log
CWM Chemical Services, Inc.
 Model City, NY

160994

Cubic Yards

81623610
 Receipt #

22012 NJ
 Trailer License Plate # and State

SCALE 1 110480 LB G

09:45 AM 03/27/08 12

Service Req. #

Profile #

Permit #

Transporter Name

Tractor/Trailer/Roll-off #

Driver's Name

Generator

SCALE 2 34640 LB G

10:57 AM 03/27/08 12

Scheduled Arrival:

Actual Arrival: 9:39
 Date _____ Time In _____ Time Out _____

75840P
 34401K

Arrived during Blackout? Y / N Notified DEC? Y / N

Leaker Permit Violation Placarding/Veh. I.D. Violation

Other (specify _____)

Bulk to Landfill No wet line Flatbed Stabilization Drums Tanker Transformers

Receiving: [Signature]
 Initials Comments

Laboratory

Time In _____ Time Out _____ Initials _____ Comments _____

Stabilization

Time In _____ Time Out _____ Initials _____ Gross Wt. _____ Comments _____

Landfill

Time In _____ Time Out _____ Initials _____ Comments _____

Other

Time In _____ Time Out _____ Initials _____ Comments _____

Aqueous Treatment

Time In _____ Time Out _____ Signature (NO Initials) _____ Comments _____

Facility Personnel (please initial)

- _____ Smoking or eating in prohibited areas
- _____ Failure to obey instructions of facility personnel
- _____ Failure to wear appropriate PPE
- _____ Unsafe driving practices
- _____ Other (specify _____)
- _____ Leaving truck unattended
- _____ Failure to display overweight flag
- _____ Improper tarping or detarpin
- Overweight upon arrival

Security Guard Initials: _____
 (Indicating receipt of Wash Bay pass, if necessary)

Driver's Comments _____

Please print or type. (Form designed for use on elite (12-pitch) typewriter.)

Form Approved. OMB No. 2050-0039

UNIFORM HAZARDOUS WASTE MANIFEST		1. Generator ID Number NYR000058347	2. Page 1 of 1	3. Emergency Response Phone 800-424-9300	4. Manifest Tracking Number 000364593GBF	
5. Generator's Name and Mailing Address NORTHROP GRUMMAN CORP 925 SOUTH OYSTER BAY RD, MAIL STOP W16-35 BETHPAGE NY 11714			Generator's Site Address (if different than mailing address) NORTHROP GRUMMAN AEROSPACE BLVD BETHPAGE NY 11714			
Generator's Phone: (516) 575-4680						
6. Transporter 1 Company Name PRIGG TRUCKING			U.S. EPA ID Number NYD046765574			
7. Transporter 2 Company Name			U.S. EPA ID Number			
8. Designated Facility Name and Site Address CWM CHEMICAL SERVICES, L.L.C. 1550 BALMER RD. MODEL CITY NY 14107			U.S. EPA ID Number NYD049836679			
Facility's Phone: (716) 754-8231						
9a. HM	9b. U.S. DOT Description (including Proper Shipping Name, Hazard Class, ID Number, and Packing Group (if any))	10. Containers		11. Total Quantity	12. Unit WT./Vol.	13. Waste Codes
		No.	Type			
X	1. RQ, POLYCHLORINATED BIPHENYLS, SOLID MIXTURE, 9, UN3432, III NY296605	001	DT	EST 27215	K	B007
	2.					
	3.					
	4.					
14. Special Handling Instructions and Additional Information 1. NY296605 PCB Soil ERG # 171 PCB Out of Service Date 03/26/08 Weight is Section 11 is Estimated. SR# 81623610						
15. GENERATOR'S/OFFEROR'S CERTIFICATION: I hereby declare that the contents of this consignment are fully and accurately described above by the proper shipping name, and are classified, packaged, marked and labeled/placarded, and are in all respects in proper condition for transport according to applicable international and national governmental regulations. If export shipment and I am the Primary Exporter, I certify that the contents of this consignment conform to the terms of the attached EPA Acknowledgment of Consent. I certify that the waste minimization statement identified in 40 CFR 262.27(a) (if I am a large quantity generator) or (b) (if I am a small quantity generator) is true.						
Generator's/Offoror's Printed/Typed Name: NORTHROP GRUMMAN Signature: <i>[Signature]</i> Month: 03 Day: 26 Year: 08						
16. International Shipments <input type="checkbox"/> Import to U.S. <input type="checkbox"/> Export from U.S. Port of entry/exit: _____ Date leaving U.S.: _____						
17. Transporter Acknowledgment of Receipt of Materials Transporter 1 Printed/Typed Name: IVAN ZINKIV Signature: <i>[Signature]</i> Month: 3 Day: 26 Year: 08						
Transporter 2 Printed/Typed Name: _____ Signature: _____ Month: _____ Day: _____ Year: _____						
18. Discrepancy						
18a. Discrepancy Indication Space <input checked="" type="checkbox"/> Quantity <input type="checkbox"/> Type <input type="checkbox"/> Residue <input type="checkbox"/> Partial Rejection <input type="checkbox"/> Full Rejection						
qty list actual recd 34401K Manifest Reference Number: _____						
18b. Alternate Facility (or Generator) _____ U.S. EPA ID Number _____						
Facility's Phone: _____						
18c. Signature of Alternate Facility (or Generator) _____ Month: _____ Day: _____ Year: _____						
19. Hazardous Waste Report Management Method Codes (i.e., codes for hazardous waste treatment, disposal, and recycling systems)						
1. H132		2.		3.		4.
20. Designated Facility Owner or Operator: Certification of receipt of hazardous materials covered by the manifest except as noted in Item 18a						
Printed/Typed Name: EILEEN CARTER Signature: <i>[Signature]</i> Month: 3 Day: 27 Year: 08						

GENERATOR

TRANSPORTER/INTL

DESIGNATED FACILITY



Transporter Log
CWM Chemical Services, Inc.
 Model City, NY

160997

50
 Cubic Yards

81633613

28 013-NY

SCALE 1 102760 LB G

10:02 AM 03/27/08 12

Receipt # _____ Trailer License Plate # and State _____

Service Req. # _____ Profile # _____ Permit # _____

Transporter Name _____ Tractor/Trailer/Roll-off # _____

Driver's Name _____ Generator _____

SCALE 2 34500 LB G

11:13 AM 03/27/08 12

Scheduled Arrival: _____

Actual Arrival: _____
 Date _____ Time _____
 Date _____ Time In _____ Time Out _____

68260P
 30963K

Arrived during Blackout? Y / N Notified DEC? Y / N

Leaker Permit Violation Placarding/Veh. I.D. Violation

Other (specify _____)

Bulk to Landfill No wet line Flatbed Stabilization Drums Tanker Transformers

Receiving: <u> J </u>	_____
Initials	Comments

Laboratory

Time In _____ Time Out _____ Initials _____ Comments _____

Stabilization

Time In _____ Time Out _____ Initials _____ Gross Wt. _____ Comments _____

Landfill

Time In _____ Time Out _____ Initials _____ Comments _____

Other

Time In _____ Time Out _____ Initials _____ Comments _____

Aqueous Treatment

Time In _____ Time Out _____ Signature (NO Initials) _____ Comments _____

Facility Personnel (please initial)

- | | |
|--|--|
| _____ Smoking or eating in prohibited areas | _____ Leaving truck unattended |
| _____ Failure to obey instructions of facility personnel | _____ Failure to display overweight flag |
| _____ Failure to wear appropriate PPE | _____ Improper tarping or detarpin |
| _____ Unsafe driving practices | _____ Overweight upon arrival |
| _____ Other (specify) _____ | |

Security Guard Initials: _____
 (Indicating receipt of Wash Bay pass, if necessary)

Driver's Comments _____

Please print or type. (Form designed for use on elite (12-pitch) typewriter.)

Form Approved. OMB No. 2050-0039

UNIFORM HAZARDOUS WASTE MANIFEST		1. Generator ID Number NYR000058347	2. Page 1 of 1	3. Emergency Response Phone 800-424-9300	4. Manifest Tracking Number 000364594GBF		
5. Generator's Name and Mailing Address NORTHROP GRUMMAN CORP 925 SOUTH OYSTER BAY RD, MAIL STOP W16-35 BETHPAGE NY 11714				Generator's Site Address (if different than mailing address) NORTHROP GRUMMAN AEROSPACE BLVD BETHPAGE NY 11714			
Generator's Phone: (516) 575-4680							
6. Transporter 1 Company Name PRICE TRUCKING				U.S. EPA ID Number NYD046765574			
7. Transporter 2 Company Name				U.S. EPA ID Number			
8. Designated Facility Name and Site Address CWM CHEMICAL SERVICES, L.L.C. 1550 BALMER RD. MODEL CITY NY 14107				U.S. EPA ID Number NYD049836679			
Facility's Phone: (716) 754-8231							
9a. HM	9b. U.S. DOT Description (including Proper Shipping Name, Hazard Class, ID Number, and Packing Group (if any))	10. Containers		11. Total Quantity	12. Unit Wt./Vol.	13. Waste Codes	
		No.	Type				
X	RQ, POLYCHLORINATED BIPHENYLS, SOLID MIXTURE, 9, UN3432, III NY296605	001	DT	EST 27215	K	B007	
14. Special Handling Instructions and Additional Information 1. NY296605 PCB Soil ERG #171 PCB Out of Service Date <u>03/26/08</u> Weight is Section 11 is Estimated. SR# <u>81623613</u>							
15. GENERATOR'S/OFFEROR'S CERTIFICATION: I hereby declare that the contents of this consignment are fully and accurately described above by the proper shipping name, and are classified, packaged, marked and labeled/placarded, and are in all respects in proper condition for transport according to applicable international and national governmental regulations. If export shipment and I am the Primary Exporter, I certify that the contents of this consignment conform to the terms of the attached EPA Acknowledgment of Consent. I certify that the waste minimization statement identified in 40 CFR 262.27(a) (if I am a large quantity generator) or (b) (if I am a small quantity generator) is true.							
Generator's/Offeror's Printed/Typed Name AGENT FOR NORTHROP GRUMMAN BRUCE EULIAN				Signature <i>Bruce Eulian</i>		Month Day Year 03 26 08	
16. International Shipments <input type="checkbox"/> Import to U.S. <input type="checkbox"/> Export from U.S. Port of entry/exit: _____ Transporter signature (for exports only): _____ Date leaving U.S.: _____							
17. Transporter Acknowledgment of Receipt of Materials							
Transporter 1 Printed/Typed Name Vasily Zinkiv				Signature <i>Vasily Zinkiv</i>		Month Day Year 03 26 08	
Transporter 2 Printed/Typed Name				Signature		Month Day Year	
18. Discrepancy							
18a. Discrepancy Indication Space <input checked="" type="checkbox"/> Quantity <input type="checkbox"/> Type <input type="checkbox"/> Residue <input type="checkbox"/> Partial Rejection <input type="checkbox"/> Full Rejection							
qty not actual rec'd 30903K							
18b. Alternate Facility (or Generator)				Manifest Reference Number:		U.S. EPA ID Number	
Facility's Phone:							
18c. Signature of Alternate Facility (or Generator)						Month Day Year	
19. Hazardous Waste Report Management Method Codes (i.e., codes for hazardous waste treatment, disposal, and recycling systems)							
1. H132		2.		3.		4.	
20. Designated Facility Owner or Operator: Certification of receipt of hazardous materials covered by the manifest except as noted in Item 18a							
Printed/Typed Name ELLEN CARTON				Signature <i>Ellen Carton</i>		Month Day Year 3 27 08	



Transporter Log
CWM Chemical Services, Inc.
 Model City, NY

161054

50
 Cubic Yards

SCALE 2 106340 LB 6
 06:26 AM 04/02/08 12

71623664

Receipt # _____ Trailer License Plate # and State _____
 Service Req. # _____ Profile # _____ Permit # _____
 Transporter Name _____ Tractor/Trailer/Roll-off # _____
 Driver's Name _____ Generator _____

SCALE 2 35100 LB 6
 07:42 AM 04/02/08 12

71240P

Scheduled Arrival: _____
 Date _____ Time _____
 Actual Arrival: _____
 Date _____ Time In _____ Time Out _____

Arrived during Blackout? Y / N Notified DEC? Y / N
 Leaker Permit Violation Placarding/Veh. I.D. Violation
 Other (specify _____)
 Bulk to Landfill No wet line Flatbed Stabilization Drums Tanker Transformers

Receiving: _____ Initials Comments
--

Laboratory	Time In	Time Out	Initials	Comments	
Stabilization	Time In	Time Out	Initials	Gross Wt.	Comments
Landfill	Time In	Time Out	Initials	Comments	
Other	Time In	Time Out	Initials	Comments	
Aqueous Treatment	Time In	Time Out	Signature (NO Initials)	Comments	

Facility Personnel (please initial)

_____ Smoking or eating in prohibited areas	_____ Leaving truck unattended
_____ Failure to obey instructions of facility personnel	_____ Failure to display overweight flag
_____ Failure to wear appropriate PPE	_____ Improper tarping or detarplin
_____ Unsafe driving practices	_____ Overweight upon arrival
_____ Other (specify) _____	

Security Guard Initials: _____
 (Indicating receipt of Wash Bay pass, if necessary)

Driver's Comments _____

UNIFORM HAZARDOUS WASTE MANIFEST		1. Generator ID Number NYR 000058347	2. Page 1 of 1	3. Emergency Response Phone 800-424-9300	4. Manifest Tracking Number 002551489 JJK		
5. Generator's Name and Mailing Address NORTHROP GRUMMAN SYSTEMS CORP 600 Grumman Rd - Mail Stop 718-025 Bethpage, NY 11714		Generator's Site Address (if different than mailing address) NORTHROP GRUMMAN Aerospace Blvd Bethpage, NY 11714					
6. Transporter 1 Company Name PRICE TRUCKING				U.S. EPA ID Number NYD046765574			
7. Transporter 2 Company Name				U.S. EPA ID Number			
8. Designated Facility Name and Site Address Chemical Services, LLC 1550 Balmer Rd Model City, NY 14107				U.S. EPA ID Number NYD049836679			
Facility's Phone: 716-754-8231							
GENERATOR	9a. HM	9b. U.S. DOT Description (including Proper Shipping Name, Hazard Class, ID Number, and Packing Group (if any))	10. Containers		11. Total Quantity	12. Unit Wt./Vol.	
			No.	Type			
	X	1. RC Hazardous Waste, Solid, D.O.S., 9, NA3077, III (0007) NY 296709	001	OT	EST 60,000.00P	0007	
14. Special Handling Instructions and Additional Information NY 296709 - Chrome contaminate Soil ERG # 171 Weight in sec II est SR# 870376-1 81623669							
15. GENERATOR'S/OFFEROR'S CERTIFICATION: I hereby declare that the contents of this consignment are fully and accurately described above by the proper shipping name, and are classified, packaged, marked and labeled/placarded, and are in all respects in proper condition for transport according to applicable international and national governmental regulations. If export shipment and I am the Primary Exporter, I certify that the contents of this consignment conform to the terms of the attached EPA Acknowledgment of Consent. I certify that the waste minimization statement identified in 40 CFR 262.27(a) (if I am a large quantity generator) or (b) (if I am a small quantity generator) is true.							
Generator's/Offeror's Printed/Typed Name NORTHROP BRUCE AGENT FOR GRUMMAN EULIAN				Signature <i>Northrop Bruce Eulian</i>		Month Day Year 10 9 08	
TRANSPORTER INT'L	16. International Shipments <input type="checkbox"/> Import to U.S. <input type="checkbox"/> Export from U.S. Port of entry/exit: _____ Date leaving U.S.: _____						
	17. Transporter Acknowledgment of Receipt of Materials						
TRANSPORTER	Transporter 1 Printed/Typed Name IVAN ZUKOV			Signature <i>Ivan Zukov</i>		Month Day Year 4 1 08	
	Transporter 2 Printed/Typed Name			Signature		Month Day Year	
DESIGNATED FACILITY	18. Discrepancy						
	18a. Discrepancy Indication Space <input checked="" type="checkbox"/> Quantity <input type="checkbox"/> Type <input type="checkbox"/> Residue <input type="checkbox"/> Partial Rejection <input type="checkbox"/> Full Rejection						
	Qty est actual recd 7124P						
	18b. Alternate Facility (or Generator)				U.S. EPA ID Number		
	Facility's Phone:						
18c. Signature of Alternate Facility (or Generator)				Month Day Year			
19. Hazardous Waste Report Management Method Codes (i.e., codes for hazardous waste treatment, disposal, and recycling systems)							
1. H132		2.		3.		4.	
20. Designated Facility Owner or Operator: Certification of receipt of hazardous materials covered by the manifest except as noted in Item 18a							
Printed/Typed Name EILAN CARTER				Signature <i>Eilan Carter</i>		Month Day Year 4 2 08	



Transporter Log
CWM Chemical Services, Inc.
 Model City, NY

161055

50
 Cubic Yards

816 23672

2800B3-NY

SCALE 2 106080 LB G

08:43 AM 04/02/08 12

Receipt #

Trailer License Plate # and State

Service Req. #

Profile #

Permit #

Transporter Name

Tractor/Trailer/Roll-off #

Driver's Name

Generator

SCALE 2 74820 LB G

08:49 AM 04/02/08 12

Scheduled Arrival:

Date

Time

Actual Arrival:

Date

Time In

Time Out

Arrived during Blackout? Y / N

Notified DEC? Y / N

Leaker

Permit Violation

Placarding/Veh. I.D. Violation

Other (specify)

Bulk to Landfill

No wet line

Flatbed

Stabilization

Drums

Tanker

Transformers

Receiving: J

Initials

Comments

Laboratory

Time In

Time Out

Initials

Comments

Stabilization

Time In

Time Out

Initials

Gross Wt.

Comments

Landfill

Time In

Time Out

Initials

Comments

Other

Time In

Time Out

Initials

Comments

Aqueous Treatment

Time In

Time Out

Signature (NO Initials)

Comments

Facility Personnel (please initial)

Smoking or eating in prohibited areas

Leaving truck unattended

Failure to obey instructions of facility personnel

Failure to display overweight flag

Failure to wear appropriate PPE

Improper tarping or detarpin

Unsafe driving practices

Overweight upon arrival

Other (specify)

Security Guard Initials:

(Indicating receipt of Wash Bay pass, if necessary)

Driver's Comments

White: Records

Green & Canary: Accts Rec.

Pink: Environmental

Goldenrod: Driver

UNIFORM HAZARDOUS WASTE MANIFEST		1. Generator ID Number NYR 000058347	2. Page 1 of 1	3. Emergency Response Phone 800-424-9300	4. Manifest Tracking Number 002551488 JJK	
5. Generator's Name and Mailing Address Northrop Grumman Systems Corp 600 Grumman Rd Mail Stop 216-025 Bethpage NY 11714			Generator's Site Address (if different than mailing address) Northrop Grumman Aerospace Blvd Bethpage NY 11714			
6. Transporter 1 Company Name PRICE TRUCKING			U.S. EPA ID Number NYD046765574			
7. Transporter 2 Company Name			U.S. EPA ID Number			
8. Designated Facility Name and Site Address Cwm Chemical Services L.L.C. 1550 Balmer Rd Model City NY 14107			U.S. EPA ID Number NY0049836629			
Facility's Phone: 716-754-9231						
GENERATOR	9a. HM	9b. U.S. DOT Description (including Proper Shipping Name, Hazard Class, ID Number, and Packing Group (if any))	10. Containers		11. Total Quantity	12. Unit Wt./Vol.
			No.	Type		
	X	1. RQ, Hazardous Waste, Solid, N.O.S., 9, NA3077, III (0007) NY296709	001	OT	60,000.00	P
					13. Waste Codes 000	
14. Special Handling Instructions and Additional Information NY296709 - Chrome Contaminated Soil ERG #171 Weight in sect #11 is est SR# 870376-2 81623672 Recd 71260P						
15. GENERATOR'S/OFFEROR'S CERTIFICATION: I hereby declare that the contents of this consignment are fully and accurately described above by the proper shipping name, and are classified, packaged, marked and labeled/placarded, and are in all respects in proper condition for transport according to applicable international and national governmental regulations. If export shipment and I am the Primary Exporter, I certify that the contents of this consignment conform to the terms of the attached EPA Acknowledgment of Consent. I certify that the waste minimization statement identified in 40 CFR 262.27(a) (if I am a large quantity generator) or (b) (if I am a small quantity generator) is true.						
Generator's/Offor's Printed/Typed Name NORTHROP BRUCE AGENT FOR GRUMMAN EVLAN		Signature <i>Northrop Bruce</i>		Month Day Year 10 4 08		
18. International Shipments <input type="checkbox"/> Import to U.S. <input type="checkbox"/> Export from U.S. Port of entry/exit: _____ Date leaving U.S.: _____						
17. Transporter Acknowledgment of Receipt of Materials						
Transporter 1 Printed/Typed Name VASIN ZILIK		Signature <i>Vasin Zilik</i>		Month Day Year 09 01 08		
Transporter 2 Printed/Typed Name		Signature		Month Day Year		
18. Discrepancy						
18a. Discrepancy Indication Space <input checked="" type="checkbox"/> Quantity <input type="checkbox"/> Type <input type="checkbox"/> Residue <input type="checkbox"/> Partial Rejection <input type="checkbox"/> Full Rejection qty est actual recd 71260P						
18b. Alternate Facility (or Generator) Manifest Reference Number: _____ U.S. EPA ID Number _____						
Facility's Phone: _____						
18c. Signature of Alternate Facility (or Generator) Month Day Year						
19. Hazardous Waste Report Management Method Codes (i.e., codes for hazardous waste treatment, disposal, and recycling systems)						
1. H132		2.		3.		4.
20. Designated Facility Owner or Operator, Certification of receipt of hazardous materials covered by the manifest except as noted in Item 18a						
Printed/Typed Name ELLEN CARTER		Signature <i>Ellen Carter</i>		Month Day Year 11 12 08		



Transporter Log
CWM Chemical Services, Inc.
 Model City, NY

161102

50
 Cubic Yards

814023720

2701B3-NY

SCALE 1 112440 LB G
 06:48 AM 04/07/08 12

Receipt # _____ Trailer License Plate # and State _____

Service Req. # _____ Profile # _____ Permit # _____

Transporter Name _____ Tractor/Trailer/Roll-off # _____

Driver's Name _____ Generator _____

SCALE 2 35200 LB G
 08:04 AM 04/07/08 12

Scheduled Arrival: _____
 Date _____ Time _____

Actual Arrival: _____
 Date _____ Time In _____ Time Out _____

Arrived during Blackout? Y / N Notified DEC? Y / N

Leaker Permit Violation Placarding/Veh. I.D. Violation

Other (specify _____)

Bulk to Landfill No wet line Flatbed Stabilization Drums Tanker Transformers

Receiving: <u>[Signature]</u>	_____
Initials	Comments

Laboratory _____
 Time In _____ Time Out _____ Initials _____ Comments _____

Stabilization _____
 Time In _____ Time Out _____ Initials _____ Gross Wt. _____ Comments _____

Landfill _____
 Time In _____ Time Out _____ Initials _____ Comments _____

Other _____
 Time In _____ Time Out _____ Initials _____ Comments _____

Aqueous Treatment _____
 Time In _____ Time Out _____ Signature (NO Initials) _____ Comments _____

Facility Personnel (please initial)

- | | |
|--|--|
| _____ Smoking or eating in prohibited areas | _____ Leaving truck unattended |
| _____ Failure to obey instructions of facility personnel | _____ Failure to display overweight flag |
| _____ Failure to wear appropriate PPE | _____ Improper tarping or detarpin |
| _____ Unsafe driving practices | _____ Overweight upon arrival |
| _____ Other (specify) _____ | |

Security Guard Initials: _____
 (Indicating receipt of Wash Bay pass, if necessary)

Driver's Comments _____

Please print or type. (Form designed for use on elite (12-pitch) typewriter.)

Form Approved. OMB No. 2050-0039

UNIFORM HAZARDOUS WASTE MANIFEST		1. Generator ID Number NYR000058347	2. Page 1 of 1	3. Emergency Response Phone 700-424-9300	4. Manifest Tracking Number 002551487 JJK		
5. Generator's Name and Mailing Address Northrop Grumman Systems Corp 600 Grumman Rd - mail stop 218-025 Bethpage NY 11714			Generator's Site Address (if different than mailing address) Northrop Grumman? Aerospac Blvd Bethpage NY 11714				
Generator's Phone: 516-575-4680							
6. Transporter 1 Company Name PRICES TRUCKING			U.S. EPA ID Number NYD046765574				
7. Transporter 2 Company Name			U.S. EPA ID Number				
8. Designated Facility Name and Site Address Chemical Services 1550 Balmer Rd Model City, NY 14107			U.S. EPA ID Number 10YD049836679				
Facility's Phone: 716-754-8231							
GENERATOR	9a. HM	9b. U.S. DOT Description (including Proper Shipping Name, Hazard Class, ID Number, and Packing Group (if any))	10. Containers		11. Total Quantity	12. Unit Wt./Vol.	
			No.	Type			
	X	1. RQ, Hazardous Waste, Solid, N.O.S., 9, NA3077, III (0007) NY 296709	001	DT	60,000	P	0007
		2.					
		3.					
	4.						
14. Special Handling Instructions and Additional Information NY 296709 - Chrome Contaminated Soil Weight in section 11 est. ERG #171							
15. GENERATOR'S/OFFEROR'S CERTIFICATION: I hereby declare that the contents of this consignment are fully and accurately described above by the proper shipping name, and are classified, packaged, marked and labeled/placarded, and are in all respects in proper condition for transport according to applicable international and national governmental regulations. If export shipment and I am the Primary Exporter, I certify that the contents of this consignment conform to the terms of the attached EPA Acknowledgment of Consent. I certify that the waste minimization statement identified in 40 CFR 262.27(a) (if I am a large quantity generator) or (b) (if I am a small quantity generator) is true.							
Generator's/Offoror's Printed/Typed Name AGENT FOR NORTHROP GRUMMAN BRUCE EULIAN Signature <i>Bruce Eulian</i> Month Day Year 10 4 08							
INTL	16. International Shipments <input type="checkbox"/> Import to U.S. <input type="checkbox"/> Export from U.S. Port of entry/exit: _____ Date leaving U.S.: _____						
	17. Transporter Acknowledgment of Receipt of Materials						
TRANSPORTER	Transporter 1 Printed/Typed Name IVAN ZWIKIV			Signature <i>Ivan Zwikiv</i>		Month Day Year 9 9 08	
	Transporter 2 Printed/Typed Name			Signature		Month Day Year	
DESIGNATED FACILITY	18. Discrepancy						
	18a. Discrepancy Indication Space <input checked="" type="checkbox"/> Quantity <input type="checkbox"/> Type <input type="checkbox"/> Residue <input type="checkbox"/> Partial Rejection <input type="checkbox"/> Full Rejection						
	18b. Alternate Facility (or Generator) Manifest Reference Number: _____ U.S. EPA ID Number _____						
	Facility's Phone: _____						
18c. Signature of Alternate Facility (or Generator) Month Day Year							
19. Hazardous Waste Report Management Method Codes (i.e., codes for hazardous waste treatment, disposal, and recycling systems)							
1. H132		2.		3.		4.	
20. Designated Facility Owner or Operator. Certification of receipt of hazardous materials covered by the manifest except as noted in item 18a							
Printed/Typed Name EILEEN CARTER			Signature <i>Eileen Carter</i>		Month Day Year 4 17 08		



Transporter Log
CWM Chemical Services, Inc.
 Model City, NY

161097

50
 Cubic Yards

81623716 Receipt #
 282B3-N1 Trailer License Plate # and State

Service Req. # NY276509 Profile #
 Permit # 1352-50
 Transporter Name V. Z. K. V. Tractor/Trailer/Roll-off #
 Driver's Name Generator

SCALE 1 106700 LB G
 08:03 AM 04/07/08 12
 SCALE 2 34920 LB G
 07:11 AM 04/07/08 12
 71730P

Scheduled Arrival: _____
 Date Time
 Actual Arrival: _____
 Date Time In Time Out

Arrived during Blackout? Y / N Notified DEC? Y / N
 Leaker Permit Violation Placarding/Veh. I.D. Violation
 Other (specify) _____
 Bulk to Landfill No wet line Flatbed Stabilization Drums Tanker Transformers

Receiving: _____
 Initials Comments

Laboratory
 Time In Time Out Initials Comments

Stabilization
 Time In Time Out Initials Gross Wt. Comments

Landfill
 Time In Time Out Initials Comments

Other
 Time In Time Out Initials Comments

Aqueous Treatment
 Time In Time Out Signature (NO Initials) Comments
 02-23-08
 11/4/16/08
 25 260/11
 02 2040/0

Facility Personnel (please initial)

_____ Smoking or eating in prohibited areas	_____ Leaving truck unattended
_____ Failure to obey instructions of facility personnel	_____ Failure to display overweight flag
_____ Failure to wear appropriate PPE	_____ Improper tarping or detarpin
_____ Unsafe driving practices	_____ Overweight upon arrival
_____ Other (specify) _____	

Security Guard Initials: _____
 (Indicating receipt of Wash Bay pass, if necessary)

Driver's Comments _____

Please print or type. (Form designed for use on elite (12-pitch) typewriter.)

UNIFORM HAZARDOUS WASTE MANIFEST		1. Generator ID Number NYR0000058347	2. Page 1 of 1	3. Emergency Response Phone 800-424-9300	4. Manifest Tracking Number 002551485 JJK		
5. Generator's Name and Mailing Address Northrop Grumman Systems Corp 600 Grumman Rd - mail Stop 218-025 Bethpage NY 11714			Generator's Site Address (if different than mailing address) Northrop Grumman Aerospace Blvd Bethpage NY 11714				
Generator's Phone: 516-575-4680			6. Transporter 1 Company Name PRICE TRUCKING		U.S. EPA ID Number NYD046765574		
7. Transporter 2 Company Name					U.S. EPA ID Number		
8. Designated Facility Name and Site Address Chemical Services 1550 Balmer Rd Model City NY 14107			U.S. EPA ID Number NYD049836679				
Facility's Phone: 716-754-8231							
GENERATOR	9a. HM	9b. U.S. DOT Description (including Proper Shipping Name, Hazard Class, ID Number, and Packing Group (if any))	10. Containers No.	Type	11. Total Quantity	12. Unit WL/Vol.	13. Waste Codes
		1. RQ, Hazardous Waste, Solid, N.O.S., X a, NA3077, III, (0002) NY296709	001	OT	6000.	P	D007
14. Special Handling Instructions and Additional Information NY296709 - Chrome contaminated soil ERG # 171 Weight in section 11 Estimated 816237kg							
15. GENERATOR'S/OFFEROR'S CERTIFICATION: I hereby declare that the contents of this consignment are fully and accurately described above by the proper shipping name, and are classified, packaged, marked and labeled/placarded, and are in all respects in proper condition for transport according to applicable international and national governmental regulations. If export shipment and I am the Primary Exporter, I certify that the contents of this consignment conform to the terms of the attached EPA Acknowledgment of Consent. I certify that the waste minimization statement identified in 40 CFR 262.27(a) (if I am a large quantity generator) or (b) (if I am a small quantity generator) is true.							
Generator's/Offeror's Printed/Typed Name NORTHROP GRUMMAN BRUCE EULIAN					Signature <i>Bruce Eulian</i>		Month Day Year 10 04 08
TRANSPORTER INTL	16. International Shipments <input type="checkbox"/> Import to U.S. <input type="checkbox"/> Export from U.S.		Port of entry/exit:		Date leaving U.S.:		
	Transporter signature (for exports only):						
TRANSPORTER	17. Transporter Acknowledgment of Receipt of Materials		Signature		Month Day Year		
	Transporter 1 Printed/Typed Name VASIL ZINKIV	Signature <i>Vasil Zinkiv</i>		10 04 08			
Transporter 2 Printed/Typed Name		Signature		Month Day Year			
DESIGNATED FACILITY	18. Discrepancy						
	18a. Discrepancy Indication Space <input checked="" type="checkbox"/> Quantity <input type="checkbox"/> Type <input type="checkbox"/> Residue <input type="checkbox"/> Partial Rejection <input type="checkbox"/> Full Rejection						
	Qty is actual level 71780T				Manifest Reference Number:		
18b. Alternate Facility (or Generator)					U.S. EPA ID Number		
Facility's Phone:					Month Day Year		
18c. Signature of Alternate Facility (or Generator)							
19. Hazardous Waste Report Management Method Codes (i.e., codes for hazardous waste treatment, disposal, and recycling systems)							
1. H132		2.		3.		4.	
20. Designated Facility Owner or Operator: Certification of receipt of hazardous materials covered by the manifest except as noted in item 18a							
Printed/Typed Name ERLEN CARTER					Signature <i>Erlen Carter</i>		Month Day Year 4 7 08



Transporter Log
CWM Chemical Services, Inc.
 Model City, NY

161060

Cubic Yards

81625676
 Receipt #

Trailer License Plate # and State

NY 296005

Service Req. #

Profile #

Permit #

PRICE TRUCKING

10500 2300

Transporter Name

Tractor/Trailer/Roll-off #

Simpson

N. G. INC.

Driver's Name

Generator

SCALE 1 104020 LB G

10:28 AM 04/02/08 12

SCALE 2 34080 LB G

11:33 AM 04/02/08 12

69440P

31725K

Scheduled Arrival:

Actual Arrival: 1021
 Date Time In Time Out

Arrived during Blackout? Y / N Notified DEC? Y / N

Leaker Permit Violation Placarding/Veh. I.D. Violation

Other (specify)

Bulk to Landfill No wet line Flatbed Stabilization Drums Tanker Transformers

Receiving: [Signature]

Initials

Comments

Laboratory

Time In Time Out Initials Comments

Stabilization

Time In Time Out Initials Gross Wt. Comments

Landfill

Time In Time Out Initials Comments

Other

Time In Time Out Initials Comments

Aqueous Treatment

Time In Time Out Signature (NO Initials) Comments

Facility Personnel (please initial)

Smoking or eating in prohibited areas

Leaving truck unattended

Failure to obey instructions of facility personnel

Failure to display overweight flag

Failure to wear appropriate PPE

Improper tarping or detarpin

Unsafe driving practices

Overweight upon arrival

Other (specify)

Security Guard Initials:

(Indicating receipt of Wash-Bay pass, if necessary)

Driver's Comments

Please print or type. (Form designed for use on elite (12-pitch) typewriter.)

Form Approved. OMB No. 2050-0039

UNIFORM HAZARDOUS WASTE MANIFEST		1. Generator ID Number NYR000058347	2. Page 1 of 1	3. Emergency Response Phone 800-424-9300	4. Manifest Tracking Number 000364595GBF	
5. Generator's Name and Mailing Address NORTHROP GRUMMAN CORP 925 SOUTH OYSTER BAY RD, MAIL STOP W16-35 BETHPAGE NY 11714			Generator's Site Address (if different than mailing address) NORTHROP GRUMMAN AEROSPACE BLVD BETHPAGE NY 11714			
Generator's Phone: (516) 575-4680			6. Transporter 1 Company Name PRICE TRUCKING		U.S. EPA ID Number NYDO46765574	
7. Transporter 2 Company Name			U.S. EPA ID Number			
8. Designated Facility Name and Site Address CWM CHEMICAL SERVICES, L.L.C. 1550 BALMER RD. MODEL CITY NY 14107			U.S. EPA ID Number NYD049836679			
Facility's Phone: (716) 754-8231						
9a. HM	9b. U.S. DOT Description (including Proper Shipping Name, Hazard Class, ID Number, and Packing Group (if any))	10. Containers		11. Total Quantity	12. Unit Wt./Vol.	13. Waste Codes
		No.	Type			
X	RQ, POLYCHLORINATED BIPHENYLS, SOLID MIXTURE, 9,UN3432,III NY296605	001	DT	EST 2725	K	B007
14. Special Handling, Instructions and Additional Information 1. NY296605 PCB Soil ERG #171 PCB Out of Service Date 04/01/08 Weight is Section 11 is Estimated. SR# 81623676						
15. GENERATOR'S/OFFEROR'S CERTIFICATION: I hereby declare that the contents of this consignment are fully and accurately described above by the proper shipping name, and are classified, packaged, marked and labeled/placarded, and are in all respects in proper condition for transport according to applicable international and national governmental regulations. If export shipment and I am the Primary Exporter, I certify that the contents of this consignment conform to the terms of the attached EPA Acknowledgment of Consent. I certify that the waste minimization statement identified in 40 CFR 262.27(a) (if I am a large quantity generator) or (b) (if I am a small quantity generator) is true.						
Generator's/Offeror's Printed/Typed Name NORTHROP GRUMMAN			Signature BRUCE EULIAN		Month Day Year 04/01/08	
16. International Shipments <input type="checkbox"/> Import to U.S. <input type="checkbox"/> Export from U.S.			Port of entry/exit: Date leaving U.S.:			
17. Transporter Acknowledgment of Receipt of Materials						
Transporter 1 Printed/Typed Name JAMES SIMPSON			Signature James Simpson		Month Day Year 04/01/08	
Transporter 2 Printed/Typed Name			Signature		Month Day Year	
18. Discrepancy						
18a. Discrepancy Indication Space <input checked="" type="checkbox"/> Quantity <input type="checkbox"/> Type <input type="checkbox"/> Residue <input type="checkbox"/> Partial Rejection <input type="checkbox"/> Full Rejection qty est actual recd 31725K						
18b. Alternate Facility (or Generator)			Manifest Reference Number: U.S. EPA ID Number			
Facility's Phone:						
18c. Signature of Alternate Facility (or Generator)			Month Day Year			
19. Hazardous Waste Report Management Method Codes (i.e., codes for hazardous waste treatment, disposal, and recycling systems)						
1. H132		2.		3.		4.
20. Designated Facility Owner or Operator: Certification of receipt of hazardous materials covered by the manifest except as noted in Item 18a						
Printed/typed Name EILEEN CARTER			Signature Eileen Carter		Month Day Year 4/2/08	



Transporter Log
CWM Chemical Services, Inc.
 Model City, NY

161056

40
 Cubic Yards

81623673
 Receipt # NY 2102BZ N.Y.
 Trailer License Plate # and State

SCALE 1 100660 LB G
 08:51 AM 04/02/08 12

Service Req. # 2000 2400 Profile # 2000 2400 Permit #
 Transporter Name Mark Miles Tractor/Trailer/Roll-off #
 Driver's Name Mark Miles Generator

SCALE 2 35560 LB G
 10:51 AM 04/02/08 12

Scheduled Arrival: _____
 Actual Arrival: _____
 Date Time Date Time In Time Out

65100P
27529K

Arrived during Blackout? Y / N Notified DEC? Y / N

Leaker Permit Violation Placarding/Veh. I.D. Violation

Other (specify _____)

Receiving: _____
 Initials Comments

Bulk to Landfill No wet line Flatbed Stabilization Drums Tanker Transformers

Laboratory _____
 Time In Time Out Initials Comments

Stabilization _____
 Time In Time Out Initials Gross Wt. Comments

Landfill _____
 Time In Time Out Initials Comments

Other _____
 Time In Time Out Initials Comments

Aqueous Treatment _____
 Time In Time Out Signature (NO Initials) Comments

Facility Personnel (please initial)

- _____ Smoking or eating in prohibited areas
- _____ Failure to obey instructions of facility personnel
- _____ Failure to wear appropriate PPE
- _____ Unsafe driving practices
- _____ Other (specify _____)
- _____ Leaving truck unattended
- _____ Failure to display overweight flag
- _____ Improper tarping or detarpin
- _____ Overweight upon arrival

Security Guard Initials: _____
 (Indicating receipt of Wash Bay pass, if necessary)

Driver's Comments _____

Please print or type. (Form designed for use on elite (12-pitch) typewriter.)

Form Approved. OMB No. 2050-0039

UNIFORM HAZARDOUS WASTE MANIFEST		1. Generator ID Number NYR000058347	2. Page 1 of 1	3. Emergency Response Phone 800-424-9300	4. Manifest Tracking Number 000364596GBF		
5. Generator's Name and Mailing Address NORTHROP GRUMMAN CORP 925 SOUTH OYSTER BAY RD, MAIL STOP W16-35 BETHPAGE NY 11714				Generator's Site Address (if different than mailing address) NORTHROP GRUMMAN AEROSPACE BLVD BETHPAGE NY 11714			
Generator's Phone: (516) 575-4680				U.S. EPA ID Number NYD046765574			
6. Transporter 1 Company Name PRICE TRUCKING				U.S. EPA ID Number			
7. Transporter 2 Company Name				U.S. EPA ID Number			
8. Designated Facility Name and Site Address CWM CHEMICAL SERVICES, L.L.C. 1550 BALMER RD. MODEL CITY NY 14107				U.S. EPA ID Number NYD049836879			
Facility's Phone: (716) 754-8231							
9a. HM	9b. U.S. DOT Description (including Proper Shipping Name, Hazard Class, ID Number, and Packing Group (if any))	10. Containers		11. Total Quantity	12. Unit Wt./Vol.	13. Waste Codes	
		No.	Type				
X	1. RQ, POLYCHLORINATED BIPHENYLS, SOLID MIXTURE, 9, UN3432, III NY296605	001	DT	EST 27215	K	B007	
14. Special Handling Instructions and Additional Information 1. NY296605 PCB Soil ERG #171 PCB Out of Service Date 04, 01, 08 Weight is Section 11 is Estimated. SR# 81623673 Recd 29529K							
15. GENERATOR'S/OFFEROR'S CERTIFICATION: I hereby declare that the contents of this consignment are fully and accurately described above by the proper shipping name, and are classified, packaged, marked and labeled/placarded, and are in all respects in proper condition for transport according to applicable international and national governmental regulations. If export shipment and I am the Primary Exporter, I certify that the contents of this consignment conform to the terms of the attached EPA Acknowledgment of Consent. I certify that the waste minimization statement identified in 40 CFR 262.27(a) (if I am a large quantity generator) or (b) (if I am a small quantity generator) is true.							
Generator's/Offeror's Printed/Typed Name: NORTHROP BRUCE Signature: <i>[Signature]</i> Month: 04 Day: 01 Year: 08 AGENT FOR GRUMMAN EULIAN <i>[Signature]</i>							
16. International Shipments <input type="checkbox"/> Import to U.S. <input type="checkbox"/> Export from U.S. Port of entry/exit: _____ Date leaving U.S.: _____							
17. Transporter Acknowledgment of Receipt of Materials Transporter 1 Printed/Typed Name: MOMIE MILES Signature: <i>[Signature]</i> Month: 04 Day: 01 Year: 08 Transporter 2 Printed/Typed Name: _____ Signature: _____ Month: _____ Day: _____ Year: _____							
18. Discrepancy 18a. Discrepancy Indication Space <input type="checkbox"/> Quantity <input type="checkbox"/> Type <input type="checkbox"/> Residue <input type="checkbox"/> Partial Rejection <input type="checkbox"/> Full Rejection Manifest Reference Number: _____							
18b. Alternate Facility (or Generator) U.S. EPA ID Number: _____ Facility's Phone: _____							
18c. Signature of Alternate Facility (or Generator) Month: _____ Day: _____ Year: _____							
19. Hazardous Waste Report Management Method Codes (i.e., codes for hazardous waste treatment, disposal, and recycling systems) 1. H132 2. _____ 3. _____ 4. _____							
20. Designated Facility Owner or Operator. Certification of receipt of hazardous materials covered by the manifest except as noted in Item 18a Printed/Typed Name: EULIAN CARTER Signature: <i>[Signature]</i> Month: 4 Day: 2 Year: 08							



Transporter Log
CWM Chemical Services, Inc.
 Model City, NY

161103

Cubic Yards

81623721
 Receipt #
 Service Req. # PRICE TRUCKING
 Profile #
 Transporter Name KOKOLI TOSSAH
 Driver's Name
 Trailer License Plate # and State 580 C83-NY
 Permit # 13600-2450
 Tractor/Trailer/Roll-off # NORTHROP-GRUNMAN
 Generator

SCALE 1 106700 LB G
 08:52 AM 04/07/08 12

SCALE 2 35380 LB G
 07:56 AM 04/07/08 12

Scheduled Arrival: _____
 Date Time
 Actual Arrival: _____
 Date Time In Time Out

71320P
 32351K

Arrived during Blackout? Y / N Notified DEC? Y / N

Leaker Permit Violation Placarding/Veh. I.D. Violation

Other (specify) _____

Bulk to Landfill No wet line Flatbed Stabilization Drums Tanker Transformers

Receiving: _____	
Initials	Comments

Laboratory
 Time In Time Out Initials Comments

Stabilization
 Time In Time Out Initials Gross Wt. Comments

Landfill
 Time In Time Out Initials Comments

Other
 Time In Time Out Initials Comments

Aqueous Treatment
 Time In Time Out Signature (NO Initials) Comments

Facility Personnel (please initial)

- | | |
|--|--|
| _____ Smoking or eating in prohibited areas | _____ Leaving truck unattended |
| _____ Failure to obey instructions of facility personnel | _____ Failure to display overweight flag |
| _____ Failure to wear appropriate PPE | _____ Improper tarping or detarpin |
| _____ Unsafe driving practices | _____ Overweight upon arrival |
| _____ Other (specify) _____ | |

Security Guard Initials: _____
 (Indicating receipt of Wash Bay pass, if necessary)

Driver's Comments

Please print or type. (Form designed for use on elite (12-pitch) typewriter.)

Form Approved. OMB No. 2050-0039

UNIFORM HAZARDOUS WASTE MANIFEST	1. Generator ID Number NYR000058347	2. Page 1 of 1	3. Emergency Response Phone 800-424-9300	4. Manifest Tracking Number 000364598GBF
----------------------------------	--	-------------------	---	---

5. Generator's Name and Mailing Address NORTHROP GRUMMAN CORP 925 SOUTH OYSTER BAY RD, MAIL STOP W16-35 BETHPAGE NY 11714 Generator's Phone: (516) 575-4680	Generator's Site Address (if different than mailing address) NORTHROP GRUMMAN AEROSPACE BLVD BETHPAGE NY 11714
---	---

6. Transporter 1 Company Name PRICE TRUCKING	U.S. EPA ID Number NYD046765574
---	------------------------------------

7. Transporter 2 Company Name	U.S. EPA ID Number
8. Designated Facility Name and Site Address CWM CHEMICAL SERVICES, L.L.C. 1550 BALMER RD. MODEL CITY NY 14107 Facility's Phone: (716) 754-8231	U.S. EPA ID Number NYD049836679

9a. HM	9b. U.S. DOT Description (including Proper Shipping Name, Hazard Class, ID Number, and Packing Group (if any))	10. Containers		11. Total Quantity	12. Unit Wt./Vol.	13. Waste Codes		
		No.	Type					
X	1. RQ, POLYCHLORINATED BIPHENYLS, SOLID MIXTURE, 9,UN3432,III NY296605	001	DT	EST 27215	K		B007	
	2.							
	3.							
	4.							

14. Special Handling Instructions and Additional Information 1. NY296605 PCB Soln PCB Out of Service Date 04/04/08 81623721 Weight is Section 11 Is Estimated. SR# #2802B3-NY	ERG # 171
--	-----------

15. GENERATOR'S/OFFEROR'S CERTIFICATION: I hereby declare that the contents of this consignment are fully and accurately described above by the proper shipping name, and are classified, packaged, marked and labeled/placarded, and are in all respects in proper condition for transport according to applicable international and national governmental regulations. If export shipment and I am the Primary Exporter, I certify that the contents of this consignment conform to the terms of the attached EPA Acknowledgment of Consent. I certify that the waste minimization statement identified in 40 CFR 262.27(a) (if I am a large quantity generator) or (b) (if I am a small quantity generator) is true.

Generator's/Offoror's Printed/Typed Name AGENT FOR GRUMMAN BRUCE EULIAN	Signature <i>[Signature]</i>	Month Day Year 04/04/08
--	---------------------------------	----------------------------

16. International Shipments <input type="checkbox"/> Import to U.S. <input type="checkbox"/> Export from U.S.	Port of entry/exit: Date leaving U.S.:
17. Transporter Acknowledgment of Receipt of Materials Transporter 1 Printed/Typed Name KOKOU TOSSAH Signature <i>[Signature]</i> Month Day Year 04/04/08	Transporter 2 Printed/Typed Name Signature <i>[Signature]</i> Month Day Year

18. Discrepancy 18a. Discrepancy Indication Space <input checked="" type="checkbox"/> Quantity <input type="checkbox"/> Type <input type="checkbox"/> Residue <input type="checkbox"/> Partial Rejection <input type="checkbox"/> Full Rejection Qty est actual rec'd 32351K

18b. Alternate Facility (or Generator) Facility's Name: _____ Facility's Phone: _____ 18c. Signature of Alternate Facility (or Generator) Month Day Year	U.S. EPA ID Number
--	--------------------

19. Hazardous Waste Report Management Method Codes (i.e., codes for hazardous waste treatment, disposal, and recycling systems)			
1. H132	2.	3.	4.

20. Designated Facility Owner or Operator: Certification of receipt of hazardous materials covered by the manifest except as noted in item 18a Printed/Typed Name EILEEN CARTER Signature <i>[Signature]</i> Month Day Year 14/7/08



Transporter Log
CWM Chemical Services, Inc.
 Model City, NY

161217

Cubic Yards

81623629

NY 336280

Receipt #

Trailer License Plate # and State

SCALE 2 80000 LB 6

06:25 AM 04/11/08 12

Service Req. #

Profile #

Permit #

PRICE TRUCKING INC 12400 2177

Transporter Name

Tractor/Trailer/Roll-off #

SCALE 2 30500 LB 6

RAVANA GABRIANA

NORTHERN GRUMMANN CORP

08:10 AM 04/11/08 12

Driver's Name

Generator

Scheduled Arrival:

Date

Time

Actual Arrival:

Date

Time In

Time Out

43430P
02444K

Arrived during Blackout? Y / N

Notified DEC? Y / N

Receiving: J

Initials

Comments

Leaker Permit Violation Placarding/Veh. I.D. Violation

Other (specify _____)

Bulk to Landfill No wet line Flatbed Stabilization Drums Tanker Transformers

Laboratory

Time In

Time Out

Initials

Comments

IN

Stabilization

Time In

Time Out

Initials

Gross Wt.

Comments

Landfill

Time In

Time Out

Initials

Comments

Other

Time In

Time Out

Initials

Comments

Aqueous Treatment

Time In

Time Out

Signature (NO Initials)

Comments

07:33
11/24/08
1850.73
02 2040/0

Facility Personnel (please initial)

_____ Smoking or eating in prohibited areas

_____ Leaving truck unattended

_____ Failure to obey instructions of facility personnel

_____ Failure to display overweight flag

_____ Failure to wear appropriate PPE

_____ Improper tarping or detarpin

_____ Unsafe driving practices

_____ Overweight upon arrival

_____ Other (specify _____)

Security Guard Initials: _____

(Indicating receipt of Wash Bay pass, if necessary)

Driver's Comments

White: Records

Green & Canary: Accts Rec.

Pink: Environmental

Goldenrod: Driver

Please print or type. (Form designed for use on elite (12-pitch) typewriter.)

Form Approved. OMB No. 2050-0039

UNIFORM HAZARDOUS WASTE MANIFEST		1. Generator ID Number NYR000058347	2. Page 1 of 1	3. Emergency Response Phone 800-424-9300	4. Manifest Tracking Number 000364597GBF			
5. Generator's Name and Mailing Address NORTHROP GRUMMAN CORP 925 SOUTH OYSTER BAY RD. MAIL STOP W16-35 BETHPAGE NY 11714 (516) 675-4680				Generator's Site Address (if different than mailing address) NORTHROP GRUMMAN AEROSPACE BLVD BETHPAGE NY 11714				
6. Transporter 1 Company Name PRICO TRUCKING		U.S. EPA ID Number NYD046765574		7. Transporter 2 Company Name				
8. Designated Facility Name and Site Address CWM CHEMICAL SERVICES, L.L.C. 1550 BALMER RD. MODEL CITY NY 14107 (716) 754-8231		U.S. EPA ID Number NYD049836679						
9a. HM X		9b. U.S. DOT Description (including Proper Shipping Name, Hazard Class, ID Number, and Packing Group (if any)) 1. RQ, POLYCHLORINATED BIPHENYLS, SOLID MIXTURE, 9.UN3432,III NY296605		10. Containers No. 001 Type DT		11. Total Quantity EST. 27215	12. Unit Wt./Vol. K	13. Waste Codes B007
14. Special Handling Instructions and Additional Information NY296605 PCB Soln ERG # 171 PCB Out of Service Date 04/04/08 Weight in Section 11 is Estimated. SR# 81623839								
15. GENERATOR'S/OFFEROR'S CERTIFICATION: I hereby declare that the contents of this consignment are fully and accurately described above by the proper shipping name, and are classified, packaged, marked and labeled/placarded, and are in all respects in proper condition for transport according to applicable international and national governmental regulations. If export shipment and I am the Primary Exporter, I certify that the contents of this consignment conform to the terms of the attached EPA Acknowledgment of Consent. I certify that the waste minimization statement identified in 40 CFR 262.27(a) (if I am a large quantity generator) or (b) (if I am a small quantity generator) is true.								
Generator's/Offoror's Printed/Typed Name AGENT FOR NORTHROP GRUMMAN		Signature BRUCE EULIAN		Month Day Year 04 04 08		18. International Shipments <input type="checkbox"/> Import to U.S. <input type="checkbox"/> Export from U.S.		
17. Transporter Acknowledgment of Receipt of Materials Transporter 1 Printed/Typed Name ANNA GABRIANOU		Signature [Signature]		Month Day Year 04 04 08		Port of entry/exit: Date leaving U.S.:		
18. Discrepancy 18a. Discrepancy Indication Space <input checked="" type="checkbox"/> Quantity <input type="checkbox"/> Type <input type="checkbox"/> Residue <input type="checkbox"/> Partial Rejection <input type="checkbox"/> Full Rejection qty not actual recd 2244K								
18b. Alternate Facility (or Generator)		Manifest Reference Number		U.S. EPA ID Number				
18c. Signature of Alternate Facility (or Generator)		Month Day Year		19. Hazardous Waste Report Management Method Codes (i.e., codes for hazardous waste treatment, disposal, and recycling systems)				
1. H132		2.		3.		4.		
20. Designated Facility Owner or Operator. Certification of receipt of hazardous materials covered by the manifest except as noted in Item 18a Printed/Typed Name Erin Conn		Signature [Signature]		Month Day Year 4/1/08				

ARCADIS

Attachment D-2

Common Fill and Recycled
Concrete Aggregate Analytical
Data



Columbia
Analytical
Services^{inc.}

1 Mustard St., Suite 250
Rochester, NY 14609

Date: February 26, 2008
Number of pages: 7

To:

Ms. Melissa Reindl
ARCADIS of New York
Two Huntington Quadrangle
Suite 1S10
Melville, NY 11747-4503

Phone: 631-391-5277

Fax: 631-249-7610

CC:

From:

Michael Perry

Phone: (585) 288-5380

Fax: (585) 288-8475

RUSH REPORT

Submission #: R2842367
Project Reference: NGC - BETHPAGE, NY

thanks, Mike

IMPORTANT NOTICE:

The documents accompanying this transmission may contain information which is legally privileged and/or confidential. The information is intended only for the use of the individual or entity named above. If you are not the intended recipient, or the person responsible for delivering it to the intended recipient, you are hereby notified that any disclosure, copying, distributing, or use of any information contained in this transmission is strictly PROHIBITED. If you have received this transmission in error, please immediately notify us by telephone and mail the original transmission to us. Thank you for your cooperation and assistance.

COLUMBIA ANALYTICAL SERVICES

Reported: 02/26/08

ARCADIS of New York
Project Reference: NGC - BETHPAGE, NY
Client Sample ID : 110-SAND-V

Date Sampled : 02/20/08 14:30 Order #: 1078138 Sample Matrix: SOIL/SEDIMENT
Date Received: 02/21/08 Submission #: R2842367

ANALYTE	METHOD	PQL	RESULT	DRY WEIGHT UNITS	DATE ANALYZED	DILUTION
<u>METALS</u>						
ALUMINUM	6010B	10.0	556	MG/KG	02/25/08	1.0
ANTIMONY	6010B	6.00	6.13 U	MG/KG	02/25/08	1.0
ARSENIC	6010B	1.00	1.02 U	MG/KG	02/25/08	1.0
BARIUM	6010B	2.00	2.55	MG/KG	02/25/08	1.0
BERYLLIUM	6010B	0.500	0.511 U	MG/KG	02/25/08	1.0
CADMIUM	6010B	0.500	0.511 U	MG/KG	02/25/08	1.0
CALCIUM	6010B	100	102 U	MG/KG	02/25/08	1.0
CHROMIUM	6010B	1.00	2.41	MG/KG	02/25/08	1.0
COBALT	6010B	5.00	5.11 U	MG/KG	02/25/08	1.0
COPPER	6010B	2.00	2.04 U	MG/KG	02/25/08	1.0
IRON	6010B	10.0	1630	MG/KG	02/25/08	1.0
LEAD	6010B	5.00	5.11 U	MG/KG	02/25/08	1.0
MAGNESIUM	6010B	100	154	MG/KG	02/25/08	1.0
MANGANESE	6010B	1.00	38.9	MG/KG	02/25/08	1.0
MERCURY	7471A	0.0500	0.0511 U	MG/KG	02/22/08	1.0
NICKEL	6010B	4.00	4.09 U	MG/KG	02/25/08	1.0
POTASSIUM	6010B	200	204 U	MG/KG	02/25/08	1.0
SELENIUM	6010B	1.00	1.02 U	MG/KG	02/25/08	1.0
SILVER	6010B	1.00	1.02 U	MG/KG	02/25/08	1.0
SODIUM	6010B	100	102 U	MG/KG	02/25/08	1.0
THALLIUM	6010B	1.00	1.02 U	MG/KG	02/25/08	1.0
VANADIUM	6010B	5.00	5.11 U	MG/KG	02/25/08	1.0
ZINC	6010B	2.00	2.98	MG/KG	02/25/08	1.0
<u>WET CHEMISTRY</u>						
PERCENT SOLIDS	160.3M	1.00	97.8	%	02/22/08 13:00	1.0

COLUMBIA ANALYTICAL SERVICES

VOLATILE ORGANICS
METHOD 8260B
Reported: 02/26/08

ARCADIS of New York
Project Reference: NGC - BETHPAGE, NY
Client Sample ID : 110-SAND-V

Date Sampled : 02/20/08 14:30 Order #: 1078138 Sample Matrix: SOIL/SEDIMENT
Date Received: 02/21/08 Submission #: R2842367 Percent Solid: 97.8

ANALYTE	PQL	RESULT	UNITS
DATE ANALYZED : 02/22/08			
ANALYTICAL DILUTION: 1.00			Dry Weight
ACETONE	20	20 U	UG/KG
BENZENE	5.0	5.1 U	UG/KG
BROMODICHLOROMETHANE	5.0	5.1 U	UG/KG
BROMOFORM	5.0	5.1 U	UG/KG
BROMOMETHANE	5.0	5.1 U	UG/KG
2-BUTANONE (MEK)	10	10 U	UG/KG
METHYL-TERT-BUTYL ETHER	5.0	5.1 U	UG/KG
CARBON DISULFIDE	10	10 U	UG/KG
CARBON TETRACHLORIDE	5.0	5.1 U	UG/KG
CHLORO BENZENE	5.0	5.1 U	UG/KG
CHLOROETHANE	10	10 U	UG/KG
CHLOROFORM	5.0	5.1 U	UG/KG
CHLOROMETHANE	5.0	5.1 U	UG/KG
1,2-DIBROMO-3-CHLOROPROPANE	5.0	5.1 U	UG/KG
CYCLOHEXANE	5.0	5.1 U	UG/KG
DIBROMOCHLOROMETHANE	5.0	5.1 U	UG/KG
1,2-DIBROMOETHANE	5.0	5.1 U	UG/KG
1,3-DICHLORO BENZENE	5.0	5.1 U	UG/KG
1,4-DICHLORO BENZENE	5.0	5.1 U	UG/KG
1,2-DICHLORO BENZENE	5.0	5.1 U	UG/KG
DICHLORODIFLUOROMETHANE	5.0	5.1 U	UG/KG
1,1-DICHLOROETHANE	5.0	5.1 U	UG/KG
1,2-DICHLOROETHANE	5.0	5.1 U	UG/KG
1,1-DICHLOROETHENE	5.0	5.1 U	UG/KG
CIS-1,2-DICHLOROETHENE	5.0	5.1 U	UG/KG
TRANS-1,2-DICHLOROETHENE	5.0	5.1 U	UG/KG
1,2-DICHLOROPROPANE	5.0	5.1 U	UG/KG
CIS-1,3-DICHLOROPROPENE	5.0	5.1 U	UG/KG
TRANS-1,3-DICHLOROPROPENE	5.0	5.1 U	UG/KG
ETHYLBENZENE	5.0	5.1 U	UG/KG
2-HEXANONE	10	10 U	UG/KG
ISOPROPYLBENZENE	5.0	5.1 U	UG/KG
METHYL ACETATE	10	10 U	UG/KG
METHYLCYCLOHEXANE	5.0	5.1 U	UG/KG
METHYLENE CHLORIDE	5.0	5.1 U	UG/KG
4-METHYL-2-PENTANONE (MIBK)	10	10 U	UG/KG
STYRENE	5.0	5.1 U	UG/KG
1,1,2,2-TETRACHLOROETHANE	5.0	5.1 U	UG/KG
TETRACHLOROETHENE	5.0	5.1 U	UG/KG
TOLUENE	5.0	5.1 U	UG/KG
1,2,4-TRICHLORO BENZENE	5.0	5.1 U	UG/KG
1,1,1-TRICHLOROETHANE	5.0	5.1 U	UG/KG
1,1,2-TRICHLOROETHANE	5.0	5.1 U	UG/KG
TRICHLOROETHENE	5.0	5.1 U	UG/KG

COLUMBIA ANALYTICAL SERVICES

VOLATILE ORGANICS
METHOD 8260B
Reported: 02/26/08

ARCADIS of New York
Project Reference: NGC - BETHPAGE, NY
Client Sample ID : 110-SAND-V

Date Sampled : 02/20/08 14:30 Order #: 1078138 Sample Matrix: SOIL/SEDIMENT
Date Received: 02/21/08 Submission #: R2842367 Percent Solid: 97.8

ANALYTE	PQL	RESULT	UNITS
DATE ANALYZED	: 02/22/08		
ANALYTICAL DILUTION:	1.00		Dry Weight
TRICHLOROFLUOROMETHANE	5.0	5.1 U	UG/KG
1,1,2-TRICHLORO1,2,2-TRIFLUOROETHA	5.0	5.1 U	UG/KG
VINYL CHLORIDE	5.0	5.1 U	UG/KG
O-XYLENE	5.0	5.1 U	UG/KG
M+P-XYLENE	5.0	5.1 U	UG/KG

<u>SURROGATE RECOVERIES</u>	<u>QC LIMITS</u>		
4-BROMOFLUOROBENZENE	(50 - 135 %)	89	%
TOLUENE-D8	(75 - 128 %)	89	%
DIBROMOFLUOROMETHANE	(58 - 133 %)	86	%

COLUMBIA ANALYTICAL SERVICES

EXTRACTABLE ORGANICS
METHOD 8270C SEMIVOLATILES
 Reported: 02/26/08

ARCADIS of New York
 Project Reference: NGC - BETHPAGE, NY
 Client Sample ID : 110-SAND-V

Date Sampled : 02/20/08 14:30 Order #: 1078138 Sample Matrix: SOIL/SEDIMENT
 Date Received: 02/21/08 Submission #: R2842367 Percent Solid: 97.8

ANALYTE	PQL	RESULT	UNITS
DATE EXTRACTED :	02/21/08		
DATE ANALYZED :	02/25/08		
ANALYTICAL DILUTION:	1.00		Dry Weight
ACENAPHTHENE	330	340 U	UG/KG
ACENAPHTHYLENE	330	340 U	UG/KG
ANTHRACENE	330	340 U	UG/KG
BENZO (A) ANTHRACENE	330	340 U	UG/KG
BENZO (A) PYRENE	330	340 U	UG/KG
BENZO (B) FLUORANTHENE	330	340 U	UG/KG
BENZO (G, H, I) PERYLENE	330	340 U	UG/KG
BENZO (K) FLUORANTHENE	330	340 U	UG/KG
BENZYL ALCOHOL	330	340 U	UG/KG
BUTYL BENZYL PHTHALATE	330	340 U	UG/KG
DI-N-BUTYLPHTHALATE	330	340 U	UG/KG
CARBAZOLE	330	340 U	UG/KG
INDENO (1, 2, 3-CD) PYRENE	330	340 U	UG/KG
4-CHLOROANILINE	330	340 U	UG/KG
BIS (-2-CHLOROETHOXY) METHANE	330	340 U	UG/KG
BIS (2-CHLOROETHYL) ETHER	330	340 U	UG/KG
2-CHLORONAPHTHALENE	330	340 U	UG/KG
2-CHLOROPHENOL	330	340 U	UG/KG
2, 2'-OXYBIS (1-CHLOROPROPANE)	330	340 U	UG/KG
CHRYSENE	330	340 U	UG/KG
DIBENZO (A, H) ANTHRACENE	330	340 U	UG/KG
DIBENZOFURAN	330	340 U	UG/KG
1, 3-DICHLOROBENZENE	330	340 U	UG/KG
1, 2-DICHLOROBENZENE	330	340 U	UG/KG
1, 4-DICHLOROBENZENE	330	340 U	UG/KG
3, 3'-DICHLOROBENZIDINE	330	340 U	UG/KG
2, 4-DICHLOROPHENOL	330	340 U	UG/KG
DIETHYLPHTHALATE	330	340 U	UG/KG
DIMETHYL PHTHALATE	330	340 U	UG/KG
2, 4-DIMETHYLPHENOL	330	340 U	UG/KG
2, 4-DINITROPHENOL	1700	1700 U	UG/KG
2, 4-DINITROTOLUENE	330	340 U	UG/KG
2, 6-DINITROTOLUENE	330	340 U	UG/KG
BIS (2-ETHYLHEXYL) PHTHALATE	330	340 U	UG/KG
FLUORANTHENE	330	340 U	UG/KG
FLUORENE	330	340 U	UG/KG
HEXACHLOROBENZENE	330	340 U	UG/KG
HEXACHLOROBUTADIENE	330	340 U	UG/KG
HEXACHLOROCYCLOPENTADIENE	330	340 U	UG/KG
HEXACHLOROETHANE	330	340 U	UG/KG
ISOPHORONE	330	340 U	UG/KG
2-METHYLNAPHTHALENE	330	340 U	UG/KG
4, 6-DINITRO-2-METHYLPHENOL	1700	1700 U	UG/KG

COLUMBIA ANALYTICAL SERVICES

EXTRACTABLE ORGANICS
 METHOD 8270C SEMIVOLATILES
 Reported: 02/26/08

ARCADIS of New York
 Project Reference: NGC - BETHPAGE, NY
 Client Sample ID : 110-SAND-V

Date Sampled : 02/20/08 14:30 Order #: 1078138 Sample Matrix: SOIL/SEDIMENT
 Date Received: 02/21/08 Submission #: R2842367 Percent Solid: 97.8

ANALYTE	PQL	RESULT	UNITS
DATE EXTRACTED	: 02/21/08		
DATE ANALYZED	: 02/25/08		
ANALYTICAL DILUTION:	1.00		Dry Weight
4-CHLORO-3-METHYLPHENOL	330	340 U	UG/KG
2-METHYLPHENOL	330	340 U	UG/KG
3+4-METHYLPHENOL	330	340 U	UG/KG
NAPHTHALENE	330	340 U	UG/KG
2-NITROANILINE	1700	1700 U	UG/KG
3-NITROANILINE	1700	1700 U	UG/KG
4-NITROANILINE	1700	1700 U	UG/KG
NITROBENZENE	330	340 U	UG/KG
2-NITROPHENOL	330	340 U	UG/KG
4-NITROPHENOL	1700	1700 U	UG/KG
N-NITROSODIMETHYLAMINE	330	340 U	UG/KG
N-NITROSODIPHENYLAMINE	330	340 U	UG/KG
DI-N-OCTYL PHTHALATE	330	340 U	UG/KG
PENTACHLOROPHENOL	1700	1700 U	UG/KG
PHENANTHRENE	330	340 U	UG/KG
PHENOL	330	340 U	UG/KG
4-BROMOPHENYL-PHENYLEETHER	330	340 U	UG/KG
4-CHLOROPHENYL-PHENYLEETHER	330	340 U	UG/KG
N-NITROSO-DI-N-PROPYLAMINE	330	340 U	UG/KG
PYRENE	330	340 U	UG/KG
1,2,4-TRICHLOROBENZENE	330	340 U	UG/KG
2,4,6-TRICHLOROPHENOL	330	340 U	UG/KG
2,4,5-TRICHLOROPHENOL	330	340 U	UG/KG

SURROGATE RECOVERIES

QC LIMITS

TERPHENYL-d14	(48 - 131 %)	79	%
NITROBENZENE-d5	(27 - 130 %)	68	%
PHENOL-d6	(10 - 133 %)	73	%
2-FLUOROBIPHENYL	(32 - 130 %)	75	%
2-FLUOROPHENOL	(10 - 130 %)	64	%
2,4,6-TRIBROMOPHENOL	(33 - 139 %)	96	%

COLUMBIA ANALYTICAL SERVICES

EXTRACTABLE ORGANICS
METHOD 8082 PCB'S
Reported: 02/26/08

ARCADIS of New York
Project Reference: NGC - BETHPAGE, NY
Client Sample ID : 110-SAND-V

Date Sampled : 02/20/08 14:30 Order #: 1078138 Sample Matrix: SOIL/SEDIMENT
Date Received: 02/21/08 Submission #: R2842367 Percent Solid: 97.8

ANALYTE	PQL	RESULT	UNITS
DATE EXTRACTED	: 02/21/08		
DATE ANALYZED	: 02/22/08		
ANALYTICAL DILUTION:	1.00		Dry Weight
PCB 1016	33	34 U	UG/KG
PCB 1221	67	69 U	UG/KG
PCB 1232	33	34 U	UG/KG
PCB 1242	33	34 U	UG/KG
PCB 1248	33	34 U	UG/KG
PCB 1254	33	34 U	UG/KG
PCB 1260	33	34 U	UG/KG

<u>SURROGATE RECOVERIES</u>	<u>QC LIMITS</u>		
DECACHLOROBIPHENYL	(29 - 153 %)	88	%
TETRACHLORO-META-XYLENE	(27 - 134 %)	85	%



Date: March 14, 2008

Number of pages: _____

1 Mustard St., Suite 250
Rochester, NY 14609

To:

Ms. Melissa Reindl
ARCADIS of New York
Two Huntington Quadrangle
Suite 1S10
Melville, NY 11747-4503

Phone: 631-391-5277

Fax: 631-249-7610

CC:

From:

Michael Perry

Phone: (585) 288-5380

Fax: (585) 288-8475

RUSH REPORT

Submission #: R2842651
Project Reference: NGC SVE IRM

IMPORTANT NOTICE:

The documents accompanying this transmission may contain information which is legally privileged and/or confidential. The information is intended only for the use of the individual or entity named above. If you are not the intended recipient, or the person responsible for delivering it to the intended recipient, you are hereby notified that any disclosure, copying, distributing, or use of any information contained in this transmission is strictly PROHIBITED. If you have received this transmission in error, please immediately notify us by telephone and mail the original transmission to us. Thank you for your cooperation and assistance.

COLUMBIA ANALYTICAL SERVICES

VOLATILE ORGANICS

METHOD 8260B

Reported: 03/14/08

ARCADIS of New York

Project Reference: NGC SVE IRM

Client Sample ID : NGSC-BF-RCA-031008-01

Date Sampled : 03/10/08 12:55 Order #: 1082405 Sample Matrix: SOIL/SEDIMENT
 Date Received: 03/11/08 Submission #: R2842651 Percent Solid: 88.1

ANALYTE	PQL	RESULT	UNITS
DATE ANALYZED : 03/13/08			
ANALYTICAL DILUTION: 1.00			Dry Weight
ACETONE	20	53	UG/KG
BENZENE	5.0	5.7 U	UG/KG
BROMODICHLOROMETHANE	5.0	5.7 U	UG/KG
BROMOFORM	5.0	5.7 U	UG/KG
BROMOMETHANE	5.0	5.7 U	UG/KG
2-BUTANONE (MEK)	10	11 U	UG/KG
METHYL-TERT-BUTYL ETHER	5.0	5.7 U	UG/KG
CARBON DISULFIDE	10	11 U	UG/KG
CARBON TETRACHLORIDE	5.0	5.7 U	UG/KG
CHLOROBENZENE	5.0	5.7 U	UG/KG
CHLOROETHANE	10	11 U	UG/KG
CHLOROFORM	5.0	5.7 U	UG/KG
CHLOROMETHANE	5.0	5.7 U	UG/KG
1,2-DIBROMO-3-CHLOROPROPANE	5.0	5.7 U	UG/KG
CYCLOHEXANE	5.0	5.7 U	UG/KG
DIBROMOCHLOROMETHANE	5.0	5.7 U	UG/KG
1,2-DIBROMOETHANE	5.0	5.7 U	UG/KG
1,3-DICHLOROBENZENE	5.0	5.7 U	UG/KG
1,4-DICHLOROBENZENE	5.0	5.7 U	UG/KG
1,2-DICHLOROBENZENE	5.0	5.7 U	UG/KG
DICHLORODIFLUOROMETHANE	5.0	5.7 U	UG/KG
1,1-DICHLOROETHANE	5.0	5.7 U	UG/KG
1,2-DICHLOROETHANE	5.0	5.7 U	UG/KG
1,1-DICHLOROETHENE	5.0	5.7 U	UG/KG
CIS-1,2-DICHLOROETHENE	5.0	5.7 U	UG/KG
TRANS-1,2-DICHLOROETHENE	5.0	5.7 U	UG/KG
1,2-DICHLOROPROPANE	5.0	5.7 U	UG/KG
CIS-1,3-DICHLOROPROPENE	5.0	5.7 U	UG/KG
TRANS-1,3-DICHLOROPROPENE	5.0	5.7 U	UG/KG
ETHYLBENZENE	5.0	5.7 U	UG/KG
2-HEXANONE	10	11 U	UG/KG
ISOPROPYLBENZENE	5.0	5.7 U	UG/KG
METHYL ACETATE	10	11 U	UG/KG
METHYLCYCLOHEXANE	5.0	5.7 U	UG/KG
METHYLENE CHLORIDE	5.0	5.7 U	UG/KG
4-METHYL-2-PENTANONE (MIBK)	10	11 U	UG/KG
STYRENE	5.0	5.7 U	UG/KG
1,1,2,2-TETRACHLOROETHANE	5.0	5.7 U	UG/KG
TETRACHLOROETHENE	5.0	5.7 U	UG/KG
TOLUENE	5.0	5.7 U	UG/KG
1,2,4-TRICHLOROBENZENE	5.0	5.7 U	UG/KG
1,1,1-TRICHLOROETHANE	5.0	5.7 U	UG/KG
1,1,2-TRICHLOROETHANE	5.0	5.7 U	UG/KG
TRICHLOROETHENE	5.0	5.7 U	UG/KG

COLUMBIA ANALYTICAL SERVICES

VOLATILE ORGANICS
METHOD 8260B
Reported: 03/14/08

ARCADIS of New York
Project Reference: NGC SVE IRM
Client Sample ID : NGSC-BF-RCA-031008-01

Date Sampled : 03/10/08 12:55 Order #: 1082405 Sample Matrix: SOIL/SEDIMENT
Date Received: 03/11/08 Submission #: R2842651 Percent Solid: 88.1

ANALYTE	PQL	RESULT	UNITS
DATE ANALYZED : 03/13/08			Dry Weight
ANALYTICAL DILUTION: 1.00			
TRICHLOROFLUOROMETHANE	5.0	5.7 U	UG/KG
1,1,2-TRICHLORO1,2,2-TRIFLUOROETHA	5.0	5.7 U	UG/KG
VINYL CHLORIDE	5.0	5.7 U	UG/KG
O-XYLENE	5.0	5.7 U	UG/KG
M+P-XYLENE	5.0	5.7 U	UG/KG

SURROGATE RECOVERIES	QC LIMITS		
4-BROMOFLUOROBENZENE	(50 - 135 %)	81	%
TOLUENE-D8	(75 - 128 %)	88	%
DIBROMOFLUOROMETHANE	(58 - 133 %)	40 *	%

COLUMBIA ANALYTICAL SERVICES

VOLATILE ORGANICS

METHOD 8260B

Reported: 03/14/08

ARCADIS of New York

Project Reference: NGC SVE IRM

Client Sample ID : NGSC-BF-RCA-031008-02

Date Sampled : 03/10/08 13:00 Order #: 1082406 Sample Matrix: SOIL/SEDIMENT
 Date Received: 03/11/08 Submission #: R2842651 Percent Solid: 91.2

ANALYTE	PQL	RESULT	UNITS
DATE ANALYZED : 03/13/08			
ANALYTICAL DILUTION: 1.00			Dry Weight
ACETONE	20	46	UG/KG
BENZENE	5.0	5.5 U	UG/KG
BROMODICHLOROMETHANE	5.0	5.5 U	UG/KG
BROMOFORM	5.0	5.5 U	UG/KG
BROMOMETHANE	5.0	5.5 U	UG/KG
2-BUTANONE (MEK)	10	11 U	UG/KG
METHYL-TERT-BUTYL ETHER	5.0	5.5 U	UG/KG
CARBON DISULFIDE	10	11 U	UG/KG
CARBON TETRACHLORIDE	5.0	5.5 U	UG/KG
CHLOROBENZENE	5.0	5.5 U	UG/KG
CHLOROETHANE	10	11 U	UG/KG
CHLOROFORM	5.0	5.5 U	UG/KG
CHLOROMETHANE	5.0	5.5 U	UG/KG
1,2-DIBROMO-3-CHLOROPROPANE	5.0	5.5 U	UG/KG
CYCLOHEXANE	5.0	5.5 U	UG/KG
DIBROMOCHLOROMETHANE	5.0	5.5 U	UG/KG
1,2-DIBROMOETHANE	5.0	5.5 U	UG/KG
1,3-DICHLOROBENZENE	5.0	5.5 U	UG/KG
1,4-DICHLOROBENZENE	5.0	5.5 U	UG/KG
1,2-DICHLOROBENZENE	5.0	5.5 U	UG/KG
DICHLORODIFLUOROMETHANE	5.0	5.5 U	UG/KG
1,1-DICHLOROETHANE	5.0	5.5 U	UG/KG
1,2-DICHLOROETHANE	5.0	5.5 U	UG/KG
1,1-DICHLOROETHENE	5.0	5.5 U	UG/KG
CIS-1,2-DICHLOROETHENE	5.0	5.5 U	UG/KG
TRANS-1,2-DICHLOROETHENE	5.0	5.5 U	UG/KG
1,2-DICHLOROPROPANE	5.0	5.5 U	UG/KG
CIS-1,3-DICHLOROPROPENE	5.0	5.5 U	UG/KG
TRANS-1,3-DICHLOROPROPENE	5.0	5.5 U	UG/KG
ETHYLBENZENE	5.0	5.5 U	UG/KG
2-HEXANONE	10	11 U	UG/KG
ISOPROPYLBENZENE	5.0	5.5 U	UG/KG
METHYL ACETATE	10	11 U	UG/KG
METHYLCYCLOHEXANE	5.0	5.5 U	UG/KG
METHYLENE CHLORIDE	5.0	5.5 U	UG/KG
4-METHYL-2-PENTANONE (MIBK)	10	11 U	UG/KG
STYRENE	5.0	5.5 U	UG/KG
1,1,2,2-TETRACHLOROETHANE	5.0	5.5 U	UG/KG
TETRACHLOROETHENE	5.0	5.5 U	UG/KG
TOLUENE	5.0	5.5 U	UG/KG
1,2,4-TRICHLOROBENZENE	5.0	5.5 U	UG/KG
1,1,1-TRICHLOROETHANE	5.0	5.5 U	UG/KG
1,1,2-TRICHLOROETHANE	5.0	5.5 U	UG/KG
TRICHLOROETHENE	5.0	5.5 U	UG/KG

COLUMBIA ANALYTICAL SERVICES

VOLATILE ORGANICS
METHOD 8260B
Reported: 03/14/08

ARCADIS of New York
Project Reference: NGC SVE IRM
Client Sample ID : NGSC-BF-RCA-031008-02

Date Sampled : 03/10/08 13:00 Order #: 1082406 Sample Matrix: SOIL/SEDIMENT
Date Received: 03/11/08 Submission #: R2842651 Percent Solid: 91.2

ANALYTE	PQL	RESULT	UNITS
DATE ANALYZED : 03/13/08			Dry Weight
ANALYTICAL DILUTION: 1.00			
TRICHLOROFLUOROMETHANE	5.0	5.5 U	UG/KG
1,1,2-TRICHLORO1,2,2-TRIFLUOROETHA	5.0	5.5 U	UG/KG
VINYL CHLORIDE	5.0	5.5 U	UG/KG
O-XYLENE	5.0	5.5 U	UG/KG
M+P-XYLENE	5.0	5.5 U	UG/KG

SURROGATE RECOVERIES	QC LIMITS		
4-BROMOFLUOROBENZENE	(50 - 135 %)	81	%
TOLUENE-D8	(75 - 128 %)	91	%
DIBROMOFLUOROMETHANE	(58 - 133 %)	42 *	%

COLUMBIA ANALYTICAL SERVICES

VOLATILE ORGANICS

METHOD 8260B

Reported: 03/14/08

ARCADIS of New York

Project Reference: NGC SVE IRM

Client Sample ID : NGSC-BF-RCA-031008-03

Date Sampled : 03/10/08 13:05 Order #: 1082407 Sample Matrix: SOIL/SEDIMENT
 Date Received: 03/11/08 Submission #: R2842651 Percent Solid: 91.4

ANALYTE	PQL	RESULT	UNITS
DATE ANALYZED	: 03/13/08		
ANALYTICAL DILUTION:	1.00		Dry Weight
ACETONE	20	62	UG/KG
BENZENE	5.0	5.5 U	UG/KG
BROMODICHLOROMETHANE	5.0	5.5 U	UG/KG
BROMOFORM	5.0	5.5 U	UG/KG
BROMOMETHANE	5.0	5.5 U	UG/KG
2-BUTANONE (MEK)	10	11 U	UG/KG
METHYL-TERT-BUTYL ETHER	5.0	5.5 U	UG/KG
CARBON DISULFIDE	10	11 U	UG/KG
CARBON TETRACHLORIDE	5.0	5.5 U	UG/KG
CHLOROBENZENE	5.0	5.5 U	UG/KG
CHLOROETHANE	10	11 U	UG/KG
CHLOROFORM	5.0	5.5 U	UG/KG
CHLOROMETHANE	5.0	5.5 U	UG/KG
1,2-DIBROMO-3-CHLOROPROPANE	5.0	5.5 U	UG/KG
CYCLOHEXANE	5.0	5.5 U	UG/KG
DIBROMOCHLOROMETHANE	5.0	5.5 U	UG/KG
1,2-DIBROMOETHANE	5.0	5.5 U	UG/KG
1,3-DICHLOROBENZENE	5.0	5.5 U	UG/KG
1,4-DICHLOROBENZENE	5.0	5.5 U	UG/KG
1,2-DICHLOROBENZENE	5.0	5.5 U	UG/KG
DICHLORODIFLUOROMETHANE	5.0	5.5 U	UG/KG
1,1-DICHLOROETHANE	5.0	5.5 U	UG/KG
1,2-DICHLOROETHANE	5.0	5.5 U	UG/KG
1,1-DICHLOROETHENE	5.0	5.5 U	UG/KG
CIS-1,2-DICHLOROETHENE	5.0	5.5 U	UG/KG
TRANS-1,2-DICHLOROETHENE	5.0	5.5 U	UG/KG
1,2-DICHLOROPROPANE	5.0	5.5 U	UG/KG
CIS-1,3-DICHLOROPROPENE	5.0	5.5 U	UG/KG
TRANS-1,3-DICHLOROPROPENE	5.0	5.5 U	UG/KG
ETHYLBENZENE	5.0	5.5 U	UG/KG
2-HEXANONE	10	11 U	UG/KG
ISOPROPYLBENZENE	5.0	5.5 U	UG/KG
METHYL ACETATE	10	11 U	UG/KG
METHYLCYCLOHEXANE	5.0	5.5 U	UG/KG
METHYLENE CHLORIDE	5.0	5.5 U	UG/KG
4-METHYL-2-PENTANONE (MIBK)	10	11 U	UG/KG
STYRENE	5.0	5.5 U	UG/KG
1,1,2,2-TETRACHLOROETHANE	5.0	5.5 U	UG/KG
TETRACHLOROETHENE	5.0	5.5 U	UG/KG
TOLUENE	5.0	5.5 U	UG/KG
1,2,4-TRICHLOROBENZENE	5.0	5.5 U	UG/KG
1,1,1-TRICHLOROETHANE	5.0	5.5 U	UG/KG
1,1,2-TRICHLOROETHANE	5.0	5.5 U	UG/KG
TRICHLOROETHENE	5.0	5.5 U	UG/KG

COLUMBIA ANALYTICAL SERVICES

VOLATILE ORGANICS
METHOD 8260B
Reported: 03/14/08

ARCADIS of New York
Project Reference: NGC SVE IRM
Client Sample ID : NGSC-BF-RCA-031008-03

Date Sampled : 03/10/08 13:05 Order #: 1082407 Sample Matrix: SOIL/SEDIMENT
Date Received: 03/11/08 Submission #: R2842651 Percent Solid: 91.4

ANALYTE	PQL	RESULT	UNITS
DATE ANALYZED		: 03/13/08	
ANALYTICAL DILUTION:	1.00		Dry Weight
TRICHLOROFLUOROMETHANE	5.0	5.5 U	UG/KG
1,1,2-TRICHLORO1,2,2-TRIFLUOROETHA	5.0	5.5 U	UG/KG
VINYL CHLORIDE	5.0	5.5 U	UG/KG
O-XYLENE	5.0	5.5 U	UG/KG
M+P-XYLENE	5.0	5.5 U	UG/KG

SURROGATE RECOVERIES

QC LIMITS

4-BROMOFLUOROBENZENE	(50 - 135 %)	84	%
TOLUENE-D8	(75 - 128 %)	93	%
DIBROMOFLUOROMETHANE	(58 - 133 %)	48 *	%

COLUMBIA ANALYTICAL SERVICES

VOLATILE ORGANICS

METHOD 8260B

Reported: 03/14/08

ARCADIS of New York

Project Reference: NGC SVE IRM

Client Sample ID : NGSC-BF-RCA-031008-04

Date Sampled : 03/10/08 13:10 Order #: 1082408 Sample Matrix: SOIL/SEDIMENT
 Date Received: 03/11/08 Submission #: R2842651 Percent Solid: 89.2

ANALYTE	PQL	RESULT	UNITS
DATE ANALYZED : 03/13/08			
ANALYTICAL DILUTION: 1.00			Dry Weight
ACETONE	20	75	UG/KG
BENZENE	5.0	5.6 U	UG/KG
BROMODICHLOROMETHANE	5.0	5.6 U	UG/KG
BROMOFORM	5.0	5.6 U	UG/KG
BROMOMETHANE	5.0	5.6 U	UG/KG
2-BUTANONE (MEK)	10	15	UG/KG
METHYL-TERT-BUTYL ETHER	5.0	5.6 U	UG/KG
CARBON DISULFIDE	10	11 U	UG/KG
CARBON TETRACHLORIDE	5.0	5.6 U	UG/KG
CHLOROBENZENE	5.0	5.6 U	UG/KG
CHLOROETHANE	10	11 U	UG/KG
CHLOROFORM	5.0	5.6 U	UG/KG
CHLOROMETHANE	5.0	5.6 U	UG/KG
1,2-DIBROMO-3-CHLOROPROPANE	5.0	5.6 U	UG/KG
CYCLOHEXANE	5.0	5.6 U	UG/KG
DIBROMOCHLOROMETHANE	5.0	5.6 U	UG/KG
1,2-DIBROMOETHANE	5.0	5.6 U	UG/KG
1,3-DICHLOROBENZENE	5.0	5.6 U	UG/KG
1,4-DICHLOROBENZENE	5.0	5.6 U	UG/KG
1,2-DICHLOROBENZENE	5.0	5.6 U	UG/KG
DICHLORODIFLUOROMETHANE	5.0	5.6 U	UG/KG
1,1-DICHLOROETHANE	5.0	5.6 U	UG/KG
1,2-DICHLOROETHANE	5.0	5.6 U	UG/KG
1,1-DICHLOROETHENE	5.0	5.6 U	UG/KG
CIS-1,2-DICHLOROETHENE	5.0	5.6 U	UG/KG
TRANS-1,2-DICHLOROETHENE	5.0	5.6 U	UG/KG
1,2-DICHLOROPROPANE	5.0	5.6 U	UG/KG
CIS-1,3-DICHLOROPROPENE	5.0	5.6 U	UG/KG
TRANS-1,3-DICHLOROPROPENE	5.0	5.6 U	UG/KG
ETHYLBENZENE	5.0	5.6 U	UG/KG
2-HEXANONE	10	11 U	UG/KG
ISOPROPYLBENZENE	5.0	5.6 U	UG/KG
METHYL ACETATE	10	11 U	UG/KG
METHYLCYCLOHEXANE	5.0	5.6 U	UG/KG
METHYLENE CHLORIDE	5.0	5.6 U	UG/KG
4-METHYL-2-PENTANONE (MIBK)	10	11 U	UG/KG
STYRENE	5.0	5.6 U	UG/KG
1,1,2,2-TETRACHLOROETHANE	5.0	5.6 U	UG/KG
TETRACHLOROETHENE	5.0	5.6 U	UG/KG
TOLUENE	5.0	5.6 U	UG/KG
1,2,4-TRICHLOROBENZENE	5.0	5.6 U	UG/KG
1,1,1-TRICHLOROETHANE	5.0	5.6 U	UG/KG
1,1,2-TRICHLOROETHANE	5.0	5.6 U	UG/KG
TRICHLOROETHENE	5.0	5.6 U	UG/KG

COLUMBIA ANALYTICAL SERVICES

VOLATILE ORGANICS
METHOD 8260B
Reported: 03/14/08

ARCADIS of New York
Project Reference: NGC SVE IRM
Client Sample ID : NGSC-BF-RCA-031008-04

Date Sampled : 03/10/08 13:10 Order #: 1082408 Sample Matrix: SOIL/SEDIMENT
Date Received: 03/11/08 Submission #: R2842651 Percent Solid: 89.2

ANALYTE	PQL	RESULT	UNITS
DATE ANALYZED : 03/13/08			
ANALYTICAL DILUTION: 1.00			Dry Weight
TRICHLOROFLUOROMETHANE	5.0	5.6 U	UG/KG
1,1,2-TRICHLORO1,2,2-TRIFLUOROETHA	5.0	5.6 U	UG/KG
VINYL CHLORIDE	5.0	5.6 U	UG/KG
O-XYLENE	5.0	5.6 U	UG/KG
M+P-XYLENE	5.0	5.6 U	UG/KG

<u>SURROGATE RECOVERIES</u>	<u>QC LIMITS</u>		
4-BROMOFLUOROBENZENE	(50 - 135 %)	78	%
TOLUENE-D8	(75 - 128 %)	91	%
DIBROMOFLUOROMETHANE	(58 - 133 %)	31 *	%

COLUMBIA ANALYTICAL SERVICES

VOLATILE ORGANICS
METHOD 8260B
Reported: 03/14/08

ARCADIS of New York
Project Reference: NGC SVE IRM
Client Sample ID : NGSC-BF-RCA-031008-05

Date Sampled : 03/10/08 13:15 Order #: 1082409 Sample Matrix: SOIL/SEDIMENT
Date Received: 03/11/08 Submission #: R2842651 Percent Solid: 92.7

ANALYTE	PQL	RESULT	UNITS
DATE ANALYZED : 03/13/08			
ANALYTICAL DILUTION: 1.00			Dry Weight
ACETONE	20	59	UG/KG
BENZENE	5.0	5.4 U	UG/KG
BROMODICHLOROMETHANE	5.0	5.4 U	UG/KG
BROMOFORM	5.0	5.4 U	UG/KG
BROMOMETHANE	5.0	5.4 U	UG/KG
2-BUTANONE (MEK)	10	11 U	UG/KG
METHYL-TERT-BUTYL ETHER	5.0	5.4 U	UG/KG
CARBON DISULFIDE	10	11 U	UG/KG
CARBON TETRACHLORIDE	5.0	5.4 U	UG/KG
CHLOROBENZENE	5.0	5.4 U	UG/KG
CHLOROETHANE	10	11 U	UG/KG
CHLOROFORM	5.0	5.4 U	UG/KG
CHLOROMETHANE	5.0	5.4 U	UG/KG
1,2-DIBROMO-3-CHLOROPROPANE	5.0	5.4 U	UG/KG
CYCLOHEXANE	5.0	5.4 U	UG/KG
DIBROMOCHLOROMETHANE	5.0	5.4 U	UG/KG
1,2-DIBROMOETHANE	5.0	5.4 U	UG/KG
1,3-DICHLOROBENZENE	5.0	5.4 U	UG/KG
1,4-DICHLOROBENZENE	5.0	5.4 U	UG/KG
1,2-DICHLOROBENZENE	5.0	5.4 U	UG/KG
DICHLORODIFLUOROMETHANE	5.0	5.4 U	UG/KG
1,1-DICHLOROETHANE	5.0	5.4 U	UG/KG
1,2-DICHLOROETHANE	5.0	5.4 U	UG/KG
1,1-DICHLOROETHENE	5.0	5.4 U	UG/KG
CIS-1,2-DICHLOROETHENE	5.0	5.4 U	UG/KG
TRANS-1,2-DICHLOROETHENE	5.0	5.4 U	UG/KG
1,2-DICHLOROPROPANE	5.0	5.4 U	UG/KG
CIS-1,3-DICHLOROPROPENE	5.0	5.4 U	UG/KG
TRANS-1,3-DICHLOROPROPENE	5.0	5.4 U	UG/KG
ETHYLBENZENE	5.0	5.4 U	UG/KG
2-HEXANONE	10	11 U	UG/KG
ISOPROPYLBENZENE	5.0	5.4 U	UG/KG
METHYL ACETATE	10	11 U	UG/KG
METHYLCYCLOHEXANE	5.0	5.4 U	UG/KG
METHYLENE CHLORIDE	5.0	5.4 U	UG/KG
4-METHYL-2-PENTANONE (MIBK)	10	11 U	UG/KG
STYRENE	5.0	5.4 U	UG/KG
1,1,2,2-TETRACHLOROETHANE	5.0	5.4 U	UG/KG
TETRACHLOROETHENE	5.0	5.4 U	UG/KG
TOLUENE	5.0	5.4 U	UG/KG
1,2,4-TRICHLOROBENZENE	5.0	5.4 U	UG/KG
1,1,1-TRICHLOROETHANE	5.0	5.4 U	UG/KG
1,1,2-TRICHLOROETHANE	5.0	5.4 U	UG/KG
TRICHLOROETHENE	5.0	5.4 U	UG/KG

COLUMBIA ANALYTICAL SERVICES

VOLATILE ORGANICS
METHOD 8260B
Reported: 03/14/08

ARCADIS of New York
Project Reference: NGC SVE IRM
Client Sample ID : NGSC-BF-RCA-031008-05

Date Sampled : 03/10/08 13:15 Order #: 1082409 Sample Matrix: SOIL/SEDIMENT
Date Received: 03/11/08 Submission #: R2842651 Percent Solid: 92.7

ANALYTE	PQL	RESULT	UNITS
DATE ANALYZED	: 03/13/08		
ANALYTICAL DILUTION:	1.00		Dry Weight
TRICHLOROFLUOROMETHANE	5.0	5.4 U	UG/KG
1,1,2-TRICHLORO1,2,2-TRIFLUOROETHA	5.0	5.4 U	UG/KG
VINYL CHLORIDE	5.0	5.4 U	UG/KG
O-XYLENE	5.0	5.4 U	UG/KG
M+P-XYLENE	5.0	5.4 U	UG/KG
<u>SURROGATE RECOVERIES</u>	<u>QC LIMITS</u>		
4-BROMOFLUOROBENZENE	(50 - 135 %)	85	%
TOLUENE-D8	(75 - 128 %)	92	%
DIBROMOFLUOROMETHANE	(58 - 133 %)	31 *	%

COLUMBIA ANALYTICAL SERVICES

VOLATILE ORGANICS
 METHOD 8260B
 Reported: 03/14/08

ARCADIS of New York
 Project Reference: NGC SVE IRM
 Client Sample ID : NGSC-BF-RCA-031008-06

Date Sampled : 03/10/08 13:20 Order #: 1082410 Sample Matrix: SOIL/SEDIMENT
 Date Received: 03/11/08 Submission #: R2842651 Percent Solid: 90.7

ANALYTE	PQL	RESULT	UNITS
DATE ANALYZED : 03/13/08			
ANALYTICAL DILUTION: 1.00			Dry Weight
ACETONE	20	30	UG/KG
BENZENE	5.0	5.5 U	UG/KG
BROMODICHLOROMETHANE	5.0	5.5 U	UG/KG
BROMOFORM	5.0	5.5 U	UG/KG
BROMOMETHANE	5.0	5.5 U	UG/KG
2-BUTANONE (MEK)	10	11 U	UG/KG
METHYL-TERT-BUTYL ETHER	5.0	5.5 U	UG/KG
CARBON DISULFIDE	10	11 U	UG/KG
CARBON TETRACHLORIDE	5.0	5.5 U	UG/KG
CHLOROENZENE	5.0	5.5 U	UG/KG
CHLOROETHANE	10	11 U	UG/KG
CHLOROFORM	5.0	5.5 U	UG/KG
CHLOROMETHANE	5.0	5.5 U	UG/KG
1,2-DIBROMO-3-CHLOROPROPANE	5.0	5.5 U	UG/KG
CYCLOHEXANE	5.0	5.5 U	UG/KG
DIBROMOCHLOROMETHANE	5.0	5.5 U	UG/KG
1,2-DIBROMOETHANE	5.0	5.5 U	UG/KG
1,3-DICHLOROENZENE	5.0	5.5 U	UG/KG
1,4-DICHLOROENZENE	5.0	5.5 U	UG/KG
1,2-DICHLOROENZENE	5.0	5.5 U	UG/KG
DICHLORODIFLUOROMETHANE	5.0	5.5 U	UG/KG
1,1-DICHLOROETHANE	5.0	5.5 U	UG/KG
1,2-DICHLOROETHANE	5.0	5.5 U	UG/KG
1,1-DICHLOROETHENE	5.0	5.5 U	UG/KG
CIS-1,2-DICHLOROETHENE	5.0	5.5 U	UG/KG
TRANS-1,2-DICHLOROETHENE	5.0	5.5 U	UG/KG
1,2-DICHLOROPROPANE	5.0	5.5 U	UG/KG
CIS-1,3-DICHLOROPROPENE	5.0	5.5 U	UG/KG
TRANS-1,3-DICHLOROPROPENE	5.0	5.5 U	UG/KG
ETHYLBENZENE	5.0	5.5 U	UG/KG
2-HEXANONE	10	11 U	UG/KG
ISOPROPYLBENZENE	5.0	5.5 U	UG/KG
METHYL ACETATE	10	11 U	UG/KG
METHYLCYCLOHEXANE	5.0	5.5 U	UG/KG
METHYLENE CHLORIDE	5.0	5.5 U	UG/KG
4-METHYL-2-PENTANONE (MIBK)	10	11 U	UG/KG
STYRENE	5.0	5.5 U	UG/KG
1,1,2,2-TETRACHLOROETHANE	5.0	5.5 U	UG/KG
TETRACHLOROETHENE	5.0	5.5 U	UG/KG
TOLUENE	5.0	5.5 U	UG/KG
1,2,4-TRICHLOROENZENE	5.0	5.5 U	UG/KG
1,1,1-TRICHLOROETHANE	5.0	5.5 U	UG/KG
1,1,2-TRICHLOROETHANE	5.0	5.5 U	UG/KG
TRICHLOROETHENE	5.0	5.5 U	UG/KG

COLUMBIA ANALYTICAL SERVICES

VOLATILE ORGANICS
METHOD 8260B
Reported: 03/14/08

ARCADIS of New York
Project Reference: NGC SVE IRM
Client Sample ID : NGSC-BF-RCA-031008-06

Date Sampled : 03/10/08 13:20 Order #: 1082410 Sample Matrix: SOIL/SEDIMENT
Date Received: 03/11/08 Submission #: R2842651 Percent Solid: 90.7

ANALYTE	PQL	RESULT	UNITS
DATE ANALYZED : 03/13/08			Dry Weight
ANALYTICAL DILUTION: 1.00			
TRICHLOROFLUOROMETHANE	5.0	5.5 U	UG/KG
1,1,2-TRICHLORO1,2,2-TRIFLUOROETHA	5.0	5.5 U	UG/KG
VINYL CHLORIDE	5.0	5.5 U	UG/KG
O-XYLENE	5.0	5.5 U	UG/KG
M+P-XYLENE	5.0	5.5 U	UG/KG

SURROGATE RECOVERIES

QC LIMITS

4-BROMOFLUOROBENZENE	(50 - 135 %)	83	%
TOLUENE-D8	(75 - 128 %)	90	%
DIBROMOFLUOROMETHANE	(58 - 133 %)	33 *	%

COLUMBIA ANALYTICAL SERVICES

EXTRACTABLE ORGANICS
METHOD 8270C SEMIVOLATILES
 Reported: 03/14/08

ARCADIS of New York
 Project Reference: NGC SVE IRM
 Client Sample ID : NGSC-BF-RCA-031008-01

Date Sampled : 03/10/08 12:55 Order #: 1082405 Sample Matrix: SOIL/SEDIMENT
 Date Received: 03/11/08 Submission #: R2842651 Percent Solid: 88.1

ANALYTE	PQL	RESULT	UNITS
DATE EXTRACTED : 03/12/08			
DATE ANALYZED : 03/12/08			
ANALYTICAL DILUTION: 10.00			Dry Weight
ACENAPHTHENE	330	3700 U	UG/KG
ACENAPHTHYLENE	330	3700 U	UG/KG
ACETOPHENONE	330	3700 U	UG/KG
ANTHRACENE	330	3700 U	UG/KG
ATRAZINE	330	3700 U	UG/KG
BENZALDEHYDE	330	3700 U	UG/KG
BENZO (A) ANTHRACENE	330	3700 U	UG/KG
BENZO (A) PYRENE	330	3700 U	UG/KG
BENZO (B) FLUORANTHENE	330	3700 U	UG/KG
BENZO (G, H, I) PERYLENE	330	3700 U	UG/KG
BENZO (K) FLUORANTHENE	330	3700 U	UG/KG
1,1'-BIPHENYL	330	3700 U	UG/KG
BUTYL BENZYL PHTHALATE	330	3700 U	UG/KG
DI-N-BUTYL PHTHALATE	330	3700 U	UG/KG
CAPROLACTAM	330	3700 U	UG/KG
CARBAZOLE	330	3700 U	UG/KG
INDENO (1,2,3-CD) PYRENE	330	3700 U	UG/KG
4-CHLOROANILINE	330	3700 U	UG/KG
BIS (-2-CHLOROETHOXY) METHANE	330	3700 U	UG/KG
BIS (2-CHLOROETHYL) ETHER	330	3700 U	UG/KG
2-CHLORONAPHTHALENE	330	3700 U	UG/KG
2-CHLOROPHENOL	330	3700 U	UG/KG
2,2'-OXYBIS (1-CHLOROPROPANE)	330	3700 U	UG/KG
CHRYSENE	330	3700 U	UG/KG
DIBENZO (A, H) ANTHRACENE	330	3700 U	UG/KG
DIBENZOFURAN	330	3700 U	UG/KG
3,3'-DICHLOROBENZIDINE	330	3700 U	UG/KG
2,4-DICHLOROPHENOL	330	3700 U	UG/KG
DIETHYL PHTHALATE	330	3700 U	UG/KG
DIMETHYL PHTHALATE	330	3700 U	UG/KG
2,4-DIMETHYLPHENOL	330	3700 U	UG/KG
2,4-DINITROPHENOL	1700	19000 U	UG/KG
2,4-DINITROTOLUENE	330	3700 U	UG/KG
2,6-DINITROTOLUENE	330	3700 U	UG/KG
BIS (2-ETHYLHEXYL) PHTHALATE	330	3700 U	UG/KG
FLUORANTHENE	330	740 J	UG/KG
FLUORENE	330	3700 U	UG/KG
HEXACHLOROBENZENE	330	3700 U	UG/KG
HEXACHLOROBUTADIENE	330	3700 U	UG/KG
HEXACHLOROCYCLOPENTADIENE	330	3700 U	UG/KG
HEXACHLOROETHANE	330	3700 U	UG/KG
ISOPHORONE	330	3700 U	UG/KG
2-METHYLNAPHTHALENE	330	3700 U	UG/KG

COLUMBIA ANALYTICAL SERVICES

EXTRACTABLE ORGANICS
 METHOD 8270C SEMIVOLATILES
 Reported: 03/14/08

ARCADIS of New York
 Project Reference: NGC SVE IRM
 Client Sample ID : NGSC-BF-RCA-031008-01

Date Sampled : 03/10/08 12:55 Order #: 1082405 Sample Matrix: SOIL/SEDIMENT
 Date Received: 03/11/08 Submission #: R2842651 Percent Solid: 88.1

ANALYTE	PQL	RESULT	UNITS
DATE EXTRACTED	: 03/12/08		
DATE ANALYZED	: 03/12/08		
ANALYTICAL DILUTION:	10.00		Dry Weight
4,6-DINITRO-2-METHYLPHENOL	1700	19000 U	UG/KG
4-CHLORO-3-METHYLPHENOL	330	3700 U	UG/KG
2-METHYLPHENOL	330	3700 U	UG/KG
4-METHYLPHENOL	330	3700 U	UG/KG
NAPHTHALENE	330	3700 U	UG/KG
2-NITROANILINE	1700	19000 U	UG/KG
3-NITROANILINE	1700	19000 U	UG/KG
4-NITROANILINE	1700	19000 U	UG/KG
NITROBENZENE	330	3700 U	UG/KG
2-NITROPHENOL	330	3700 U	UG/KG
4-NITROPHENOL	1700	19000 U	UG/KG
N-NITROSODIPHENYLAMINE	330	3700 U	UG/KG
DI-N-OCTYL PHTHALATE	330	3700 U	UG/KG
PENTACHLOROPHENOL	1700	19000 U	UG/KG
PHENANTHRENE	330	510 J	UG/KG
PHENOL	330	3700 U	UG/KG
4-BROMOPHENYL-PHENYLEETHER	330	3700 U	UG/KG
4-CHLOROPHENYL-PHENYLEETHER	330	3700 U	UG/KG
N-NITROSO-DI-N-PROPYLAMINE	330	3700 U	UG/KG
PYRENE	330	660 J	UG/KG
2,4,6-TRICHLOROPHENOL	330	3700 U	UG/KG
2,4,5-TRICHLOROPHENOL	330	3700 U	UG/KG

SURROGATE RECOVERIES	QC LIMITS		
TERPHENYL-d14	(48 - 131 %)	90	%
NITROBENZENE-d5	(27 - 130 %)	69	%
PHENOL-d6	(10 - 133 %)	61	%
2-FLUOROBIPHENYL	(32 - 130 %)	85	%
2-FLUOROPHENOL	(10 - 130 %)	29	%
2,4,6-TRIBROMOPHENOL	(33 - 139 %)	7 *	%

COLUMBIA ANALYTICAL SERVICES

EXTRACTABLE ORGANICS
 METHOD 8270C SEMIVOLATILES
 Reported: 03/14/08

ARCADIS of New York
 Project Reference: NGC SVE IRM
 Client Sample ID : NGSC-BF-RCA-031008-02

Date Sampled : 03/10/08 13:00 Order #: 1082406 Sample Matrix: SOIL/SEDIMENT
 Date Received: 03/11/08 Submission #: R2842651 Percent Solid: 91.2

ANALYTE	PQL	RESULT	UNITS
DATE EXTRACTED	: 03/12/08		
DATE ANALYZED	: 03/12/08		
ANALYTICAL DILUTION:	15.00		Dry Weight
ACENAPHTHENE	330	5400 U	UG/KG
ACENAPHTHYLENE	330	5400 U	UG/KG
ACETOPHENONE	330	5400 U	UG/KG
ANTHRACENE	330	5400 U	UG/KG
ATRAZINE	330	5400 U	UG/KG
BENZALDEHYDE	330	5400 U	UG/KG
BENZO (A) ANTHRACENE	330	5400 U	UG/KG
BENZO (A) PYRENE	330	5400 U	UG/KG
BENZO (B) FLUORANTHENE	330	5400 U	UG/KG
BENZO (G, H, I) PERYLENE	330	5400 U	UG/KG
BENZO (K) FLUORANTHENE	330	5400 U	UG/KG
1,1'-BIPHENYL	330	5400 U	UG/KG
BUTYL BENZYL PHTHALATE	330	5400 U	UG/KG
DI-N-BUTYLPHTHALATE	330	5400 U	UG/KG
CAPROLACTAM	330	5400 U	UG/KG
CARBAZOLE	330	5400 U	UG/KG
INDENO (1, 2, 3-CD) PYRENE	330	5400 U	UG/KG
4-CHLOROANILINE	330	5400 U	UG/KG
BIS (-2-CHLOROETHOXY) METHANE	330	5400 U	UG/KG
BIS (2-CHLOROETHYL) ETHER	330	5400 U	UG/KG
2-CHLORONAPHTHALENE	330	5400 U	UG/KG
2-CHLOROPHENOL	330	5400 U	UG/KG
2,2'-OXYBIS (1-CHLOROPROPANE)	330	5400 U	UG/KG
CHRYSENE	330	610 J	UG/KG
DIBENZO (A, H) ANTHRACENE	330	5400 U	UG/KG
DIBENZOFURAN	330	5400 U	UG/KG
3,3'-DICHLOROBENZIDINE	330	5400 U	UG/KG
2,4-DICHLOROPHENOL	330	5400 U	UG/KG
DIETHYLPHTHALATE	330	5400 U	UG/KG
DIMETHYL PHTHALATE	330	5400 U	UG/KG
2,4-DIMETHYLPHENOL	330	5400 U	UG/KG
2,4-DINITROPHENOL	1700	28000 U	UG/KG
2,4-DINITROTOLUENE	330	5400 U	UG/KG
2,6-DINITROTOLUENE	330	5400 U	UG/KG
BIS (2-ETHYLHEXYL) PHTHALATE	330	5400 U	UG/KG
FLUORANTHENE	330	1200 J	UG/KG
FLUORENE	330	5400 U	UG/KG
HEXACHLOROBENZENE	330	5400 U	UG/KG
HEXACHLOROBUTADIENE	330	5400 U	UG/KG
HEXACHLOROCYCLOPENTADIENE	330	5400 U	UG/KG
HEXACHLOROETHANE	330	5400 U	UG/KG
ISOPHORONE	330	5400 U	UG/KG
2-METHYLNAPHTHALENE	330	5400 U	UG/KG

COLUMBIA ANALYTICAL SERVICES

EXTRACTABLE ORGANICS
METHOD 8270C SEMIVOLATILES
 Reported: 03/14/08

ARCADIS of New York
 Project Reference: NGC SVE IRM
 Client Sample ID : NGSC-BF-RCA-031008-02

Date Sampled : 03/10/08 13:00 Order #: 1082406 Sample Matrix: SOIL/SEDIMENT
 Date Received: 03/11/08 Submission #: R2842651 Percent Solid: 91.2

ANALYTE	PQL	RESULT	UNITS
DATE EXTRACTED : 03/12/08			
DATE ANALYZED : 03/12/08			
ANALYTICAL DILUTION: 15.00			Dry Weight
4,6-DINITRO-2-METHYLPHENOL	1700	28000 U	UG/KG
4-CHLORO-3-METHYLPHENOL	330	5400 U	UG/KG
2-METHYLPHENOL	330	5400 U	UG/KG
4-METHYLPHENOL	330	5400 U	UG/KG
NAPHTHALENE	330	5400 U	UG/KG
2-NITROANILINE	1700	28000 U	UG/KG
3-NITROANILINE	1700	28000 U	UG/KG
4-NITROANILINE	1700	28000 U	UG/KG
NITROBENZENE	330	5400 U	UG/KG
2-NITROPHENOL	330	5400 U	UG/KG
4-NITROPHENOL	1700	28000 U	UG/KG
N-NITROSODIPHENYLAMINE	330	5400 U	UG/KG
DI-N-OCTYL PHTHALATE	330	5400 U	UG/KG
PENTACHLOROPHENOL	1700	28000 U	UG/KG
PHENANTHRENE	330	980 J	UG/KG
PHENOL	330	5400 U	UG/KG
4-BROMOPHENYL-PHENYLEETHER	330	5400 U	UG/KG
4-CHLOROPHENYL-PHENYLEETHER	330	5400 U	UG/KG
N-NITROSO-DI-N-PROPYLAMINE	330	5400 U	UG/KG
PYRENE	330	1000 J	UG/KG
2,4,6-TRICHLOROPHENOL	330	5400 U	UG/KG
2,4,5-TRICHLOROPHENOL	330	5400 U	UG/KG

SURROGATE RECOVERIES

QC LIMITS

TERPHENYL-d14	(48 - 131 %)	D	%
NITROBENZENE-d5	(27 - 130 %)	D	%
PHENOL-d6	(10 - 133 %)	D	%
2-FLUOROBIPHENYL	(32 - 130 %)	D	%
2-FLUOROPHENOL	(10 - 130 %)	D	%
2,4,6-TRIBROMOPHENOL	(33 - 139 %)	D	%

COLUMBIA ANALYTICAL SERVICES

EXTRACTABLE ORGANICS
 METHOD 8270C SEMIVOLATILES
 Reported: 03/14/08

ARCADIS of New York
 Project Reference: NGC SVE IRM
 Client Sample ID : NGSC-BF-RCA-031008-03

Date Sampled : 03/10/08 13:05 Order #: 1082407 Sample Matrix: SOIL/SEDIMENT
 Date Received: 03/11/08 Submission #: R2842651 Percent Solid: 91.4

ANALYTE	PQL	RESULT	UNITS
DATE EXTRACTED : 03/12/08			
DATE ANALYZED : 03/12/08			
ANALYTICAL DILUTION: 15.00			Dry Weight
ACENAPHTHENE	330	5400 U	UG/KG
ACENAPHTHYLENE	330	5400 U	UG/KG
ACETOPHENONE	330	5400 U	UG/KG
ANTHRACENE	330	5400 U	UG/KG
ATRAZINE	330	5400 U	UG/KG
BENZALDEHYDE	330	5400 U	UG/KG
BENZO (A) ANTHRACENE	330	5400 U	UG/KG
BENZO (A) PYRENE	330	5400 U	UG/KG
BENZO (B) FLUORANTHENE	330	5400 U	UG/KG
BENZO (G, H, I) PERYLENE	330	5400 U	UG/KG
BENZO (K) FLUORANTHENE	330	5400 U	UG/KG
1, 1'-BIPHENYL	330	5400 U	UG/KG
BUTYL BENZYL PHTHALATE	330	5400 U	UG/KG
DI-N-BUTYLPHTHALATE	330	5400 U	UG/KG
CAPROLACTAM	330	5400 U	UG/KG
CARBAZOLE	330	5400 U	UG/KG
INDENO (1, 2, 3-CD) PYRENE	330	5400 U	UG/KG
4-CHLOROANILINE	330	5400 U	UG/KG
BIS (-2-CHLOROETHOXY) METHANE	330	5400 U	UG/KG
BIS (2-CHLOROETHYL) ETHER	330	5400 U	UG/KG
2-CHLORONAPHTHALENE	330	5400 U	UG/KG
2-CHLOROPHENOL	330	5400 U	UG/KG
2, 2'-OXYBIS (1-CHLOROPROPANE)	330	5400 U	UG/KG
CHRYSENE	330	5400 U	UG/KG
DIBENZO (A, H) ANTHRACENE	330	5400 U	UG/KG
DIBENZOFURAN	330	5400 U	UG/KG
3, 3'-DICHLOROBENZIDINE	330	5400 U	UG/KG
2, 4-DICHLOROPHENOL	330	5400 U	UG/KG
DIETHYLPHTHALATE	330	5400 U	UG/KG
DIMETHYL PHTHALATE	330	5400 U	UG/KG
2, 4-DIMETHYLPHENOL	330	5400 U	UG/KG
2, 4-DINITROPHENOL	1700	28000 U	UG/KG
2, 4-DINITROTOLUENE	330	5400 U	UG/KG
2, 6-DINITROTOLUENE	330	5400 U	UG/KG
BIS (2-ETHYLHEXYL) PHTHALATE	330	5400 U	UG/KG
FLUORANTHENE	330	950 J	UG/KG
FLUORENE	330	5400 U	UG/KG
HEXACHLORO BENZENE	330	5400 U	UG/KG
HEXACHLORO BUTADIENE	330	5400 U	UG/KG
HEXACHLORO CYCLOPENTADIENE	330	5400 U	UG/KG
HEXACHLOROETHANE	330	5400 U	UG/KG
ISOPHORONE	330	5400 U	UG/KG
2-METHYLNAPHTHALENE	330	5400 U	UG/KG

COLUMBIA ANALYTICAL SERVICES

EXTRACTABLE ORGANICS
METHOD 8270C SEMIVOLATILES
Reported: 03/14/08

ARCADIS of New York
Project Reference: NGC SVE IRM
Client Sample ID : NGSC-BF-RCA-031008-03

Date Sampled : 03/10/08 13:05 Order #: 1082407 Sample Matrix: SOIL/SEDIMENT
Date Received: 03/11/08 Submission #: R2842651 Percent Solid: 91.4

ANALYTE	PQL	RESULT	UNITS
DATE EXTRACTED : 03/12/08			
DATE ANALYZED : 03/12/08			
ANALYTICAL DILUTION: 15.00			Dry Weight
4,6-DINITRO-2-METHYLPHENOL	1700	28000 U	UG/KG
4-CHLORO-3-METHYLPHENOL	330	5400 U	UG/KG
2-METHYLPHENOL	330	5400 U	UG/KG
4-METHYLPHENOL	330	5400 U	UG/KG
NAPHTHALENE	330	5400 U	UG/KG
2-NITROANILINE	1700	28000 U	UG/KG
3-NITROANILINE	1700	28000 U	UG/KG
4-NITROANILINE	1700	28000 U	UG/KG
NITROBENZENE	330	5400 U	UG/KG
2-NITROPHENOL	330	5400 U	UG/KG
4-NITROPHENOL	1700	28000 U	UG/KG
N-NITROSODIPHENYLAMINE	330	5400 U	UG/KG
DI-N-OCTYL PHTHALATE	330	5400 U	UG/KG
PENTACHLOROPHENOL	1700	28000 U	UG/KG
PHENANTHRENE	330	740 J	UG/KG
PHENOL	330	5400 U	UG/KG
4-BROMOPHENYL-PHENYLEETHER	330	5400 U	UG/KG
4-CHLOROPHENYL-PHENYLEETHER	330	5400 U	UG/KG
N-NITROSO-DI-N-PROPYLAMINE	330	5400 U	UG/KG
PYRENE	330	790 J	UG/KG
2,4,6-TRICHLOROPHENOL	330	5400 U	UG/KG
2,4,5-TRICHLOROPHENOL	330	5400 U	UG/KG

SURROGATE RECOVERIES

QC LIMITS

TERPHENYL-d14	(48 - 131 %)	D	%
NITROBENZENE-d5	(27 - 130 %)	D	%
PHENOL-d6	(10 - 133 %)	D	%
2-FLUOROBIPHENYL	(32 - 130 %)	D	%
2-FLUOROPHENOL	(10 - 130 %)	D	%
2,4,6-TRIBROMOPHENOL	(33 - 139 %)	D	%

COLUMBIA ANALYTICAL SERVICES

EXTRACTABLE ORGANICS
METHOD 8270C SEMIVOLATILES
 Reported: 03/14/08

ARCADIS of New York
 Project Reference: NGC SVE IRM
 Client Sample ID : NGSC-BF-RCA-031008-04

Date Sampled : 03/10/08 13:10 Order #: 1082408 Sample Matrix: SOIL/SEDIMENT
 Date Received: 03/11/08 Submission #: R2842651 Percent Solid: 89.2

ANALYTE	PQL	RESULT	UNITS
DATE EXTRACTED	: 03/12/08		
DATE ANALYZED	: 03/12/08		
ANALYTICAL DILUTION:	10.00		Dry Weight
ACENAPHTHENE	330	3700 U	UG/KG
ACENAPHTHYLENE	330	3700 U	UG/KG
ACETOPHENONE	330	3700 U	UG/KG
ANTHRACENE	330	450 J	UG/KG
ATRAZINE	330	3700 U	UG/KG
BENZALDEHYDE	330	3700 U	UG/KG
BENZO (A) ANTHRACENE	330	750 J	UG/KG
BENZO (A) PYRENE	330	570 J	UG/KG
BENZO (B) FLUORANTHENE	330	700 J	UG/KG
BENZO (G, H, I) PERYLENE	330	490 J	UG/KG
BENZO (K) FLUORANTHENE	330	580 J	UG/KG
1, 1' -BIPHENYL	330	3700 U	UG/KG
BUTYL BENZYL PHTHALATE	330	3700 U	UG/KG
DI -N -BUTYL PHTHALATE	330	3700 U	UG/KG
CAPROLACTAM	330	3700 U	UG/KG
CARBAZOLE	330	3700 U	UG/KG
INDENO (1, 2, 3 -CD) PYRENE	330	450 J	UG/KG
4 -CHLOROANILINE	330	3700 U	UG/KG
BIS (-2 -CHLOROETHOXY) METHANE	330	3700 U	UG/KG
BIS (2 -CHLOROETHYL) ETHER	330	3700 U	UG/KG
2 -CHLORONAPHTHALENE	330	3700 U	UG/KG
2 -CHLOROPHENOL	330	3700 U	UG/KG
2, 2' -OXYBIS (1 -CHLOROPROPANE)	330	3700 U	UG/KG
CHRYSENE	330	830 J	UG/KG
DIBENZO (A, H) ANTHRACENE	330	3700 U	UG/KG
DIBENZOFURAN	330	3700 U	UG/KG
3, 3' -DICHLOROBENZIDINE	330	3700 U	UG/KG
2, 4 -DICHLOROPHENOL	330	3700 U	UG/KG
DIETHYL PHTHALATE	330	3700 U	UG/KG
DIMETHYL PHTHALATE	330	3700 U	UG/KG
2, 4 -DIMETHYLPHENOL	330	3700 U	UG/KG
2, 4 -DINITROPHENOL	1700	19000 U	UG/KG
2, 4 -DINITROTOLUENE	330	3700 U	UG/KG
2, 6 -DINITROTOLUENE	330	3700 U	UG/KG
BIS (2 -ETHYLHEXYL) PHTHALATE	330	3700 U	UG/KG
FLUORANTHENE	330	2000 J	UG/KG
FLUORENE	330	3700 U	UG/KG
HEXACHLORO BENZENE	330	3700 U	UG/KG
HEXACHLORO BUTADIENE	330	3700 U	UG/KG
HEXACHLORO CYCLOPENTADIENE	330	3700 U	UG/KG
HEXACHLOROETHANE	330	3700 U	UG/KG
ISOPHORONE	330	3700 U	UG/KG
2 -METHYLNAPHTHALENE	330	3700 U	UG/KG

COLUMBIA ANALYTICAL SERVICES

EXTRACTABLE ORGANICS
 METHOD 8270C SEMIVOLATILES
 Reported: 03/14/08

ARCADIS of New York
 Project Reference: NGC SVE IRM
 Client Sample ID : NGSC-BF-RCA-031008-04

Date Sampled : 03/10/08 13:10 Order #: 1082408 Sample Matrix: SOIL/SEDIMENT
 Date Received: 03/11/08 Submission #: R2842651 Percent Solid: 89.2

ANALYTE	PQL	RESULT	UNITS
DATE EXTRACTED	: 03/12/08		
DATE ANALYZED	: 03/12/08		
ANALYTICAL DILUTION:	10.00		Dry Weight
4,6-DINITRO-2-METHYLPHENOL	1700	19000 U	UG/KG
4-CHLORO-3-METHYLPHENOL	330	3700 U	UG/KG
2-METHYLPHENOL	330	3700 U	UG/KG
4-METHYLPHENOL	330	3700 U	UG/KG
NAPHTHALENE	330	3700 U	UG/KG
2-NITROANILINE	1700	19000 U	UG/KG
3-NITROANILINE	1700	19000 U	UG/KG
4-NITROANILINE	1700	19000 U	UG/KG
NITROBENZENE	330	3700 U	UG/KG
2-NITROPHENOL	330	3700 U	UG/KG
4-NITROPHENOL	1700	19000 U	UG/KG
N-NITROSODIPHENYLAMINE	330	3700 U	UG/KG
DI-N-OCTYL PHTHALATE	330	3700 U	UG/KG
PENTACHLOROPHENOL	1700	19000 U	UG/KG
PHENANTHRENE	330	1700 J	UG/KG
PHENOL	330	3700 U	UG/KG
4-BROMOPHENYL-PHENYLETHER	330	3700 U	UG/KG
4-CHLOROPHENYL-PHENYLETHER	330	3700 U	UG/KG
N-NITROSO-DI-N-PROPYLAMINE	330	3700 U	UG/KG
PYRENE	330	1500 J	UG/KG
2,4,6-TRICHLOROPHENOL	330	3700 U	UG/KG
2,4,5-TRICHLOROPHENOL	330	3700 U	UG/KG

SURROGATE RECOVERIES

QC LIMITS

TERPHENYL-d14	(48 - 131 %)	90	%
NITROBENZENE-d5	(27 - 130 %)	78	%
PHENOL-d6	(10 - 133 %)	64	%
2-FLUOROBIPHENYL	(32 - 130 %)	88	%
2-FLUOROPHENOL	(10 - 130 %)	23	%
2,4,6-TRIBROMOPHENOL	(33 - 139 %)	3 *	%

COLUMBIA ANALYTICAL SERVICES

EXTRACTABLE ORGANICS
METHOD 8270C SEMIVOLATILES
 Reported: 03/14/08

ARCADIS of New York
 Project Reference: NGC SVE IRM
 Client Sample ID : NGSC-BF-RCA-031008-05

Date Sampled : 03/10/08 13:15 Order #: 1082409 Sample Matrix: SOIL/SEDIMENT
 Date Received: 03/11/08 Submission #: R2842651 Percent Solid: 92.7

ANALYTE	PQL	RESULT	UNITS
DATE EXTRACTED : 03/12/08			
DATE ANALYZED : 03/12/08			
ANALYTICAL DILUTION: 15.00			Dry Weight
ACENAPHTHENE	330	5300 U	UG/KG
ACENAPHTHYLENE	330	5300 U	UG/KG
ACETOPHENONE	330	5300 U	UG/KG
ANTHRACENE	330	5300 U	UG/KG
ATRAZINE	330	5300 U	UG/KG
BENZALDEHYDE	330	5300 U	UG/KG
BENZO (A) ANTHRACENE	330	5300 U	UG/KG
BENZO (A) PYRENE	330	5300 U	UG/KG
BENZO (B) FLUORANTHENE	330	5300 U	UG/KG
BENZO (G, H, I) PERYLENE	330	5300 U	UG/KG
BENZO (K) FLUORANTHENE	330	5300 U	UG/KG
1,1'-BIPHENYL	330	5300 U	UG/KG
BUTYL BENZYL PHTHALATE	330	5300 U	UG/KG
DI-N-BUTYLPHTHALATE	330	5300 U	UG/KG
CAPROLACTAM	330	5300 U	UG/KG
CARBAZOLE	330	5300 U	UG/KG
INDENO (1,2,3-CD) PYRENE	330	5300 U	UG/KG
4-CHLOROANILINE	330	5300 U	UG/KG
BIS (-2-CHLOROETHOXY) METHANE	330	5300 U	UG/KG
BIS (2-CHLOROETHYL) ETHER	330	5300 U	UG/KG
2-CHLORONAPHTHALENE	330	5300 U	UG/KG
2-CHLOROPHENOL	330	5300 U	UG/KG
2,2'-OXYBIS (1-CHLOROPROPANE)	330	5300 U	UG/KG
CHRYSENE	330	5300 U	UG/KG
DIBENZO (A, H) ANTHRACENE	330	5300 U	UG/KG
DIBENZOFURAN	330	5300 U	UG/KG
3,3'-DICHLOROBENZIDINE	330	5300 U	UG/KG
2,4-DICHLOROPHENOL	330	5300 U	UG/KG
DIETHYLPHTHALATE	330	5300 U	UG/KG
DIMETHYL PHTHALATE	330	5300 U	UG/KG
2,4-DIMETHYLPHENOL	330	5300 U	UG/KG
2,4-DINITROPHENOL	1700	28000 U	UG/KG
2,4-DINITROTOLUENE	330	5300 U	UG/KG
2,6-DINITROTOLUENE	330	5300 U	UG/KG
BIS (2-ETHYLHEXYL) PHTHALATE	330	5300 U	UG/KG
FLUORANTHENE	330	1200 J	UG/KG
FLUORENE	330	5300 U	UG/KG
HEXACHLOROBENZENE	330	5300 U	UG/KG
HEXACHLOROBUTADIENE	330	5300 U	UG/KG
HEXACHLOROCYCLOPENTADIENE	330	5300 U	UG/KG
HEXACHLOROETHANE	330	5300 U	UG/KG
ISOPHORONE	330	5300 U	UG/KG
2-METHYLNAPHTHALENE	330	5300 U	UG/KG

COLUMBIA ANALYTICAL SERVICES

EXTRACTABLE ORGANICS
 METHOD 8270C SEMIVOLATILES
 Reported: 03/14/08

ARCADIS of New York
 Project Reference: NGC SVE IRM
 Client Sample ID : NGSC-BF-RCA-031008-05

Date Sampled : 03/10/08 13:15 Order #: 1082409 Sample Matrix: SOIL/SEDIMENT
 Date Received: 03/11/08 Submission #: R2842651 Percent Solid: 92.7

ANALYTE	PQL	RESULT	UNITS
DATE EXTRACTED	: 03/12/08		
DATE ANALYZED	: 03/12/08		
ANALYTICAL DILUTION:	15.00		Dry Weight
4,6-DINITRO-2-METHYLPHENOL	1700	28000 U	UG/KG
4-CHLORO-3-METHYLPHENOL	330	5300 U	UG/KG
2-METHYLPHENOL	330	5300 U	UG/KG
4-METHYLPHENOL	330	5300 U	UG/KG
NAPHTHALENE	330	5300 U	UG/KG
2-NITROANILINE	1700	28000 U	UG/KG
3-NITROANILINE	1700	28000 U	UG/KG
4-NITROANILINE	1700	28000 U	UG/KG
NITROBENZENE	330	5300 U	UG/KG
2-NITROPHENOL	330	5300 U	UG/KG
4-NITROPHENOL	1700	28000 U	UG/KG
N-NITROSODIPHENYLAMINE	330	5300 U	UG/KG
DI-N-OCTYL PHTHALATE	330	5300 U	UG/KG
PENTACHLOROPHENOL	1700	28000 U	UG/KG
PHENANTHRENE	330	1000 J	UG/KG
PHENOL	330	5300 U	UG/KG
4-BROMOPHENYL-PHENYLEETHER	330	5300 U	UG/KG
4-CHLOROPHENYL-PHENYLEETHER	330	5300 U	UG/KG
N-NITROSO-DI-N-PROPYLAMINE	330	5300 U	UG/KG
PYRENE	330	900 J	UG/KG
2,4,6-TRICHLOROPHENOL	330	5300 U	UG/KG
2,4,5-TRICHLOROPHENOL	330	5300 U	UG/KG

SURROGATE RECOVERIES

QC LIMITS

TERPHENYL-d14	(48 - 131 %)	D	%
NITROBENZENE-d5	(27 - 130 %)	D	%
PHENOL-d6	(10 - 133 %)	D	%
2-FLUOROBIPHENYL	(32 - 130 %)	D	%
2-FLUOROPHENOL	(10 - 130 %)	D	%
2,4,6-TRIBROMOPHENOL	(33 - 139 %)	D	%

COLUMBIA ANALYTICAL SERVICESEXTRACTABLE ORGANICS
METHOD 8270C SEMIVOLATILES
Reported: 03/14/08ARCADIS of New York
Project Reference: NGC SVE IRM
Client Sample ID : NGSC-BF-RCA-031008-06Date Sampled : 03/10/08 13:20 Order #: 1082410 Sample Matrix: SOIL/SEDIMENT
Date Received: 03/11/08 Submission #: R2842651 Percent Solid: 90.7

ANALYTE	PQL	RESULT	UNITS
DATE EXTRACTED	: 03/12/08		
DATE ANALYZED	: 03/12/08		
ANALYTICAL DILUTION:	10.00		Dry Weight
ACENAPHTHENE	330	1000 J	UG/KG
ACENAPHTHYLENE	330	360 J	UG/KG
ACETOPHENONE	330	3600 U	UG/KG
ANTHRACENE	330	2500 J	UG/KG
ATRAZINE	330	3600 U	UG/KG
BENZALDEHYDE	330	3600 U	UG/KG
BENZO (A) ANTHRACENE	330	2800 J	UG/KG
BENZO (A) PYRENE	330	2300 J	UG/KG
BENZO (B) FLUORANTHENE	330	2000 J	UG/KG
BENZO (G, H, I) PERYLENE	330	1200 J	UG/KG
BENZO (K) FLUORANTHENE	330	1800 J	UG/KG
1,1'-BIPHENYL	330	3600 U	UG/KG
BUTYL BENZYL PHTHALATE	330	3600 U	UG/KG
DI-N-BUTYLPHTHALATE	330	3600 U	UG/KG
CAPROLACTAM	330	3600 U	UG/KG
CARBAZOLE	330	550 J	UG/KG
INDENO (1, 2, 3-CD) PYRENE	330	1200 J	UG/KG
4-CHLOROANILINE	330	3600 U	UG/KG
BIS (-2-CHLOROETHOXY) METHANE	330	3600 U	UG/KG
BIS (2-CHLOROETHYL) ETHER	330	3600 U	UG/KG
2-CHLORONAPHTHALENE	330	3600 U	UG/KG
2-CHLOROPHENOL	330	3600 U	UG/KG
2,2'-OXYBIS (1-CHLOROPROPANE)	330	3600 U	UG/KG
CHRYSENE	330	2900 J	UG/KG
DIBENZO (A, H) ANTHRACENE	330	3600 U	UG/KG
DIBENZOFURAN	330	880 J	UG/KG
3,3'-DICHLOROBENZIDINE	330	3600 U	UG/KG
2,4-DICHLOROPHENOL	330	3600 U	UG/KG
DIETHYLPHTHALATE	330	3600 U	UG/KG
DIMETHYL PHTHALATE	330	3600 U	UG/KG
2,4-DIMETHYLPHENOL	330	3600 U	UG/KG
2,4-DINITROPHENOL	1700	19000 U	UG/KG
2,4-DINITROTOLUENE	330	3600 U	UG/KG
2,6-DINITROTOLUENE	330	3600 U	UG/KG
BIS (2-ETHYLHEXYL) PHTHALATE	330	3600 U	UG/KG
FLUORANTHENE	330	7700	UG/KG
FLUORENE	330	1400 J	UG/KG
HEXACHLOROBENZENE	330	3600 U	UG/KG
HEXACHLOROBUTADIENE	330	3600 U	UG/KG
HEXACHLOROCYCLOPENTADIENE	330	3600 U	UG/KG
HEXACHLOROETHANE	330	3600 U	UG/KG
ISOPHORONE	330	3600 U	UG/KG
2-METHYLNAPHTHALENE	330	490 J	UG/KG

COLUMBIA ANALYTICAL SERVICES

EXTRACTABLE ORGANICS
METHOD 8270C SEMIVOLATILES
 Reported: 03/14/08

ARCADIS of New York
 Project Reference: NGC SVE IRM
 Client Sample ID : NGSC-BF-RCA-031008-06

Date Sampled : 03/10/08 13:20 Order #: 1082410 Sample Matrix: SOIL/SEDIMENT
 Date Received: 03/11/08 Submission #: R2842651 Percent Solid: 90.7

ANALYTE	PQL	RESULT	UNITS
DATE EXTRACTED : 03/12/08			
DATE ANALYZED : 03/12/08			
ANALYTICAL DILUTION: 10.00			Dry Weight
4,6-DINITRO-2-METHYLPHENOL	1700	19000 U	UG/KG
4-CHLORO-3-METHYLPHENOL	330	3600 U	UG/KG
2-METHYLPHENOL	330	3600 U	UG/KG
4-METHYLPHENOL	330	3600 U	UG/KG
NAPHTHALENE	330	410 J	UG/KG
2-NITROANILINE	1700	19000 U	UG/KG
3-NITROANILINE	1700	19000 U	UG/KG
4-NITROANILINE	1700	19000 U	UG/KG
NITROBENZENE	330	3600 U	UG/KG
2-NITROPHENOL	330	3600 U	UG/KG
4-NITROPHENOL	1700	19000 U	UG/KG
N-NITROSODIPHENYLAMINE	330	3600 U	UG/KG
DI-N-OCTYL PHTHALATE	330	3600 U	UG/KG
PENTACHLOROPHENOL	1700	19000 U	UG/KG
PHENANTHRENE	330	8600	UG/KG
PHENOL	330	3600 U	UG/KG
4-BROMOPHENYL-PHENYLETHER	330	3600 U	UG/KG
4-CHLOROPHENYL-PHENYLETHER	330	3600 U	UG/KG
N-NITROSO-DI-N-PROPYLAMINE	330	3600 U	UG/KG
PYRENE	330	5600	UG/KG
2,4,6-TRICHLOROPHENOL	330	3600 U	UG/KG
2,4,5-TRICHLOROPHENOL	330	3600 U	UG/KG

SURROGATE RECOVERIES	QC LIMITS		
TERPHENYL-d14	(48 - 131 %)	86	%
NITROBENZENE-d5	(27 - 130 %)	71	%
PHENOL-d6	(10 - 133 %)	64	%
2-FLUOROBIPHENYL	(32 - 130 %)	80	%
2-FLUOROPHENOL	(10 - 130 %)	37	%
2,4,6-TRIBROMOPHENOL	(33 - 139 %)	5 *	%

COLUMBIA ANALYTICAL SERVICES

Reported: 03/17/08

ARCADIS of New York
Project Reference: NGC SVE IRM
Client Sample ID : NGSC-BF-RCA-031008-01

Date Sampled : 03/10/08 12:55 Order #: 1082405 Sample Matrix: SOIL/SEDIMENT
Date Received: 03/11/08 Submission #: R2842651

ANALYTE	METHOD	PQL	RESULT	DRY WEIGHT UNITS	DATE ANALYZED	DILUTION
<u>METALS</u>						
ALUMINUM	6010B	10.0	5780	MG/KG	03/13/08	1.0
ANTIMONY	6010B	6.00	6.81 U	MG/KG	03/13/08	1.0
ARSENIC	6010B	1.00	2.05	MG/KG	03/14/08	1.0
BARIUM	6010B	2.00	46.3	MG/KG	03/13/08	1.0
BERYLLIUM	6010B	0.500	0.568 U	MG/KG	03/13/08	1.0
CADMIUM	6010B	0.500	0.568 U	MG/KG	03/13/08	1.0
CALCIUM	6010B	100	60000	MG/KG	03/14/08	10.0
CHROMIUM	6010B	1.00	15.0	MG/KG	03/13/08	1.0
COBALT	6010B	5.00	5.68 U	MG/KG	03/13/08	1.0
COPPER	6010B	2.00	23.2	MG/KG	03/13/08	1.0
IRON	6010B	10.0	8770	MG/KG	03/14/08	1.0
LEAD	6010B	5.00	31.1	MG/KG	03/13/08	1.0
MAGNESIUM	6010B	100	11000	MG/KG	03/13/08	1.0
MANGANESE	6010B	1.00	185	MG/KG	03/13/08	1.0
MERCURY	7471A	0.0500	0.0568 U	MG/KG	03/12/08	1.0
NICKEL	6010B	4.00	8.74	MG/KG	03/13/08	1.0
POTASSIUM	6010B	200	924	MG/KG	03/14/08	1.0
SELENIUM	6010B	1.00	1.14 U	MG/KG	03/13/08	1.0
SILVER	6010B	1.00	1.14 U	MG/KG	03/13/08	1.0
SODIUM	6010B	100	346	MG/KG	03/14/08	1.0
THALLIUM	6010B	1.00	1.14 U	MG/KG	03/13/08	1.0
VANADIUM	6010B	5.00	18.3	MG/KG	03/13/08	1.0
ZINC	6010B	2.00	49.5	MG/KG	03/13/08	1.0
<u>WET CHEMISTRY</u>						
PERCENT SOLIDS	160.3M	1.00	88.1	%	03/12/08 14:50	1.0

COLUMBIA ANALYTICAL SERVICES

Reported: 03/14/08

ARCADIS of New York
Project Reference: NGC SVE IRM
Client Sample ID : NGSC-BF-RCA-031008-02

Date Sampled : 03/10/08 13:00 Order #: 1082406 Sample Matrix: SOIL/SEDIMENT
Date Received: 03/11/08 Submission #: R2842651

ANALYTE	METHOD	PQL	RESULT	DRY WEIGHT UNITS	DATE ANALYZED	DILUTION
<u>METALS</u>						
ALUMINUM	6010B	10.0	5480	MG/KG	03/13/08	1.0
ANTIMONY	6010B	6.00	6.58 U	MG/KG	03/13/08	1.0
ARSENIC	6010B	1.00	1.10 U	MG/KG	03/14/08	1.0
BARIUM	6010B	2.00	40.9	MG/KG	03/13/08	1.0
BERYLLIUM	6010B	0.500	0.548 U	MG/KG	03/13/08	1.0
CADMIUM	6010B	0.500	0.548 U	MG/KG	03/13/08	1.0
CALCIUM	6010B	100	36000	MG/KG	03/14/08	1.0
CHROMIUM	6010B	1.00	13.4	MG/KG	03/13/08	1.0
COBALT	6010B	5.00	5.48 U	MG/KG	03/13/08	1.0
COPPER	6010B	2.00	26.8	MG/KG	03/13/08	1.0
IRON	6010B	10.0	9770	MG/KG	03/14/08	1.0
LEAD	6010B	5.00	32.1	MG/KG	03/13/08	1.0
MAGNESIUM	6010B	100	4730	MG/KG	03/13/08	1.0
MANGANESE	6010B	1.00	150	MG/KG	03/13/08	1.0
MERCURY	7471A	0.0500	0.0548 U	MG/KG	03/12/08	1.0
NICKEL	6010B	4.00	9.77	MG/KG	03/13/08	1.0
POTASSIUM	6010B	200	885	MG/KG	03/14/08	1.0
SELENIUM	6010B	1.00	1.10 U	MG/KG	03/13/08	1.0
SILVER	6010B	1.00	1.10 U	MG/KG	03/13/08	1.0
SODIUM	6010B	100	317	MG/KG	03/14/08	1.0
THALLIUM	6010B	1.00	1.10 U	MG/KG	03/13/08	1.0
VANADIUM	6010B	5.00	24.5	MG/KG	03/13/08	1.0
ZINC	6010B	2.00	43.9	MG/KG	03/13/08	1.0

COLUMBIA ANALYTICAL SERVICES

Reported: 03/14/08

ARCADIS of New York
Project Reference: NGC SVE IRM
Client Sample ID : NGSC-BF-RCA-031008-03

Date Sampled : 03/10/08 13:05 Order #: 1082407 Sample Matrix: SOIL/SEDIMENT
Date Received: 03/11/08 Submission #: R2842651

ANALYTE	METHOD	PQL	RESULT	DRY WEIGHT UNITS	DATE ANALYZED	DILUTION
<u>METALS</u>						
ALUMINUM	6010B	10.0	5560	MG/KG	03/13/08	1.0
ANTIMONY	6010B	6.00	6.56 U	MG/KG	03/13/08	1.0
ARSENIC	6010B	1.00	1.09 U	MG/KG	03/13/08	1.0
BARIUM	6010B	2.00	39.2	MG/KG	03/13/08	1.0
BERYLLIUM	6010B	0.500	0.547 U	MG/KG	03/13/08	1.0
CADMIUM	6010B	0.500	0.547 U	MG/KG	03/13/08	1.0
CALCIUM	6010B	100	47800	MG/KG	03/14/08	1.0
CHROMIUM	6010B	1.00	14.6	MG/KG	03/13/08	1.0
COBALT	6010B	5.00	5.47 U	MG/KG	03/13/08	1.0
COPPER	6010B	2.00	28.9	MG/KG	03/13/08	1.0
IRON	6010B	10.0	9770	MG/KG	03/14/08	1.0
LEAD	6010B	5.00	28.4	MG/KG	03/13/08	1.0
MAGNESIUM	6010B	100	8400	MG/KG	03/13/08	1.0
MANGANESE	6010B	1.00	144	MG/KG	03/13/08	1.0
MERCURY	7471A	0.0500	0.0718	MG/KG	03/12/08	1.0
NICKEL	6010B	4.00	7.94	MG/KG	03/13/08	1.0
POTASSIUM	6010B	200	931	MG/KG	03/14/08	1.0
SELENIUM	6010B	1.00	1.09 U	MG/KG	03/13/08	1.0
SILVER	6010B	1.00	1.09 U	MG/KG	03/13/08	1.0
SODIUM	6010B	100	289	MG/KG	03/14/08	1.0
THALLIUM	6010B	1.00	1.09 U	MG/KG	03/13/08	1.0
VANADIUM	6010B	5.00	20.7	MG/KG	03/13/08	1.0
ZINC	6010B	2.00	43.4	MG/KG	03/13/08	1.0

COLUMBIA ANALYTICAL SERVICES

Reported: 03/14/08

ARCADIS of New York
Project Reference: NGC SVE IRM
Client Sample ID : NGSC-BF-RCA-031008-04

Date Sampled : 03/10/08 13:10 Order #: 1082408 Sample Matrix: SOIL/SEDIMENT
Date Received: 03/11/08 Submission #: R2842651

ANALYTE	METHOD	PQL	RESULT	DRY WEIGHT UNITS	DATE ANALYZED	DILUTION
<u>METALS</u>						
ALUMINUM	6010B	10.0	5920	MG/KG	03/13/08	1.0
ANTIMONY	6010B	6.00	6.73 U	MG/KG	03/13/08	1.0
ARSENIC	6010B	1.00	2.59	MG/KG	03/13/08	1.0
BARIUM	6010B	2.00	48.3	MG/KG	03/13/08	1.0
BERYLLIUM	6010B	0.500	0.561 U	MG/KG	03/13/08	1.0
CADMIUM	6010B	0.500	0.561 U	MG/KG	03/13/08	1.0
CALCIUM	6010B	100	44300	MG/KG	03/14/08	1.0
CHROMIUM	6010B	1.00	14.5	MG/KG	03/13/08	1.0
COBALT	6010B	5.00	5.61 U	MG/KG	03/13/08	1.0
COPPER	6010B	2.00	19.5	MG/KG	03/13/08	1.0
IRON	6010B	10.0	9410	MG/KG	03/14/08	1.0
LEAD	6010B	5.00	35.0	MG/KG	03/13/08	1.0
MAGNESIUM	6010B	100	6270	MG/KG	03/13/08	1.0
MANGANESE	6010B	1.00	146	MG/KG	03/13/08	1.0
MERCURY	7471A	0.0500	0.0561 U	MG/KG	03/12/08	1.0
NICKEL	6010B	4.00	10.1	MG/KG	03/13/08	1.0
POTASSIUM	6010B	200	778	MG/KG	03/14/08	1.0
SELENIUM	6010B	1.00	1.12 U	MG/KG	03/13/08	1.0
SILVER	6010B	1.00	1.12 U	MG/KG	03/13/08	1.0
SODIUM	6010B	100	298	MG/KG	03/14/08	1.0
THALLIUM	6010B	1.00	1.12 U	MG/KG	03/13/08	1.0
VANADIUM	6010B	5.00	27.8	MG/KG	03/13/08	1.0
ZINC	6010B	2.00	45.3	MG/KG	03/13/08	1.0

COLUMBIA ANALYTICAL SERVICES

Reported: 03/14/08

ARCADIS of New York
Project Reference: NGC SVE IRM
Client Sample ID : NGSC-BF-RCA-031008-05

Date Sampled : 03/10/08 13:15
Date Received: 03/11/08

Order #: 1082409
Submission #: R2842651

Sample Matrix: SOIL/SEDIMENT

ANALYTE	METHOD	PQL	RESULT	DRY WEIGHT UNITS	DATE ANALYZED	DILUTION
<u>METALS</u>						
ALUMINUM	6010B	10.0	5730	MG/KG	03/13/08	1.0
ANTIMONY	6010B	6.00	6.47 U	MG/KG	03/13/08	1.0
ARSENIC	6010B	1.00	2.31	MG/KG	03/13/08	1.0
BARIUM	6010B	2.00	47.0	MG/KG	03/13/08	1.0
BERYLLIUM	6010B	0.500	0.539 U	MG/KG	03/13/08	1.0
CADMIUM	6010B	0.500	0.539 U	MG/KG	03/13/08	1.0
CALCIUM	6010B	100	81800	MG/KG	03/14/08	10.0
CHROMIUM	6010B	1.00	14.5	MG/KG	03/13/08	1.0
COBALT	6010B	5.00	5.39 U	MG/KG	03/13/08	1.0
COPPER	6010B	2.00	16.0	MG/KG	03/13/08	1.0
IRON	6010B	2.00	16.0	MG/KG	03/14/08	1.0
IRON	6010B	10.0	9040	MG/KG	03/14/08	1.0
LEAD	6010B	5.00	27.5	MG/KG	03/13/08	1.0
MAGNESIUM	6010B	100	15100	MG/KG	03/13/08	1.0
MANGANESE	6010B	1.00	156	MG/KG	03/13/08	1.0
MERCURY	7471A	0.0500	0.0579	MG/KG	03/12/08	1.0
NICKEL	6010B	4.00	8.64	MG/KG	03/13/08	1.0
POTASSIUM	6010B	200	689	MG/KG	03/14/08	1.0
SELENIUM	6010B	1.00	1.08 U	MG/KG	03/13/08	1.0
SILVER	6010B	1.00	1.08 U	MG/KG	03/13/08	1.0
SODIUM	6010B	100	276	MG/KG	03/14/08	1.0
THALLIUM	6010B	1.00	1.08 U	MG/KG	03/13/08	1.0
VANADIUM	6010B	5.00	22.1	MG/KG	03/13/08	1.0
ZINC	6010B	2.00	45.1	MG/KG	03/13/08	1.0

COLUMBIA ANALYTICAL SERVICES

Reported: 03/14/08

ARCADIS of New York
Project Reference: NGC SVE IRM
Client Sample ID : NGSC-BF-RCA-031008-06

Date Sampled : 03/10/08 13:20
Date Received: 03/11/08

Order #: 1082410
Submission #: R2842651

Sample Matrix: SOIL/SEDIMENT

ANALYTE	METHOD	PQL	RESULT	DRY WEIGHT UNITS	DATE ANALYZED	DILUTION
METALS						
ALUMINUM	6010B	10.0	3940	MG/KG	03/13/08	1.0
ANTIMONY	6010B	6.00	6.62 U	MG/KG	03/13/08	1.0
ARSENIC	6010B	1.00	1.10 U	MG/KG	03/13/08	1.0
BARIUM	6010B	2.00	29.7	MG/KG	03/13/08	1.0
BERYLLIUM	6010B	0.500	0.551 U	MG/KG	03/13/08	1.0
CADMIUM	6010B	0.500	0.551 U	MG/KG	03/13/08	1.0
CALCIUM	6010B	100	45300	MG/KG	03/14/08	1.0
CHROMIUM	6010B	1.00	11.2	MG/KG	03/13/08	1.0
COBALT	6010B	5.00	5.51 U	MG/KG	03/13/08	1.0
COPPER	6010B	2.00	11.0	MG/KG	03/13/08	1.0
IRON	6010B	10.0	6700	MG/KG	03/14/08	1.0
LEAD	6010B	5.00	21.4	MG/KG	03/13/08	1.0
MAGNESIUM	6010B	100	11000	MG/KG	03/13/08	1.0
MANGANESE	6010B	1.00	111	MG/KG	03/13/08	1.0
MERCURY	7471A	0.0500	0.0551 U	MG/KG	03/12/08	1.0
NICKEL	6010B	4.00	6.99	MG/KG	03/13/08	1.0
POTASSIUM	6010B	200	719	MG/KG	03/14/08	1.0
SELENIUM	6010B	1.00	1.10 U	MG/KG	03/13/08	1.0
SILVER	6010B	1.00	1.10 U	MG/KG	03/13/08	1.0
SODIUM	6010B	100	176	MG/KG	03/14/08	1.0
THALLIUM	6010B	1.00	1.10 U	MG/KG	03/13/08	1.0
VANADIUM	6010B	5.00	19.0	MG/KG	03/13/08	1.0
ZINC	6010B	2.00	34.0	MG/KG	03/13/08	1.0

COLUMBIA ANALYTICAL SERVICES

EXTRACTABLE ORGANICS

METHOD 8081A

Reported: 03/14/08

ARCADIS of New York

Project Reference: NGC SVE IRM

Client Sample ID : NGSC-BF-RCA-031008-01

Date Sampled : 03/10/08 12:55 Order #: 1082405 Sample Matrix: SOIL/SEDIMENT
 Date Received: 03/11/08 Submission #: R2842651 Percent Solid: 88.1

ANALYTE	PQL	RESULT	UNITS
DATE EXTRACTED	: 03/12/08		
DATE ANALYZED	: 03/13/08		
ANALYTICAL DILUTION:	10.00		Dry Weight
ALDRIN	1.7	19 U	UG/KG
ALPHA-BHC	1.7	19 U	UG/KG
BETA-BHC	1.7	19 U	UG/KG
DELTA-BHC	1.7	19 U	UG/KG
GAMMA-BHC (LINDANE)	1.7	19 U	UG/KG
CHLORDANE	8.3	360	UG/KG
4,4'-DDD	3.3	37 U	UG/KG
4,4'-DDE	3.3	37 U	UG/KG
4,4'-DDT	3.3	37 U	UG/KG
DIELDRIN	3.3	37 U	UG/KG
ALPHA-ENDOSULFAN	1.7	19 U	UG/KG
BETA-ENDOSULFAN	3.3	37 U	UG/KG
ENDOSULFAN SULFATE	3.3	37 U	UG/KG
ENDRIN	3.3	37 U	UG/KG
ENDRIN ALDEHYDE	3.3	37 U	UG/KG
ENDRIN KETONE	3.3	37 U	UG/KG
HEPTACHLOR	1.7	19 U	UG/KG
HEPTACHLOR EPOXIDE	1.7	19 U	UG/KG
METHOXYCHLOR	17	190 U	UG/KG
TOXAPHENE	33	370 U	UG/KG

<u>SURROGATE RECOVERIES</u>	<u>QC LIMITS</u>		
DECACHLOROBIPHENYL (DCB)	(18 - 176 %)	103	%
TETRACHLORO-META-XYLENE (TCMX)	(24 - 136 %)	83	%

COLUMBIA ANALYTICAL SERVICES

EXTRACTABLE ORGANICS

METHOD 8081A

Reported: 03/14/08

ARCADIS of New York

Project Reference: NGC SVE IRM

Client Sample ID : NGSC-BF-RCA-031008-02

Date Sampled : 03/10/08 13:00 Order #: 1082406 Sample Matrix: SOIL/SEDIMENT
 Date Received: 03/11/08 Submission #: R2842651 Percent Solid: 91.2

ANALYTE	PQL	RESULT	UNITS
DATE EXTRACTED	: 03/12/08		
DATE ANALYZED	: 03/13/08		
ANALYTICAL DILUTION:	10.00		Dry Weight
ALDRIN	1.7	19 U	UG/KG
ALPHA-BHC	1.7	19 U	UG/KG
BETA-BHC	1.7	19 U	UG/KG
DELTA-BHC	1.7	19 U	UG/KG
GAMMA-BHC (LINDANE)	1.7	19 U	UG/KG
CHLORDANE	8.3	390	UG/KG
4,4'-DDD	3.3	36 U	UG/KG
4,4'-DDE	3.3	36 U	UG/KG
4,4'-DDT	3.3	36 U	UG/KG
DIELDRIN	3.3	36 U	UG/KG
ALPHA-ENDOSULFAN	1.7	19 U	UG/KG
BETA-ENDOSULFAN	3.3	36 U	UG/KG
ENDOSULFAN SULFATE	3.3	36 U	UG/KG
ENDRIN	3.3	36 U	UG/KG
ENDRIN ALDEHYDE	3.3	36 U	UG/KG
ENDRIN KETONE	3.3	36 U	UG/KG
HEPTACHLOR	1.7	19 U	UG/KG
HEPTACHLOR EPOXIDE	1.7	19 U	UG/KG
METHOXYCHLOR	17	190 U	UG/KG
TOXAPHENE	33	360 U	UG/KG
<u>SURROGATE RECOVERIES</u>		<u>QC LIMITS</u>	
DECACHLOROBIPHENYL (DCB)	(18 - 176 %)	89	%
TETRACHLORO-META-XYLENE (TCMX)	(24 - 136 %)	75	%

COLUMBIA ANALYTICAL SERVICES

EXTRACTABLE ORGANICS

METHOD 8081A

Reported: 03/14/08

ARCADIS of New York

Project Reference: NGC SVE IRM

Client Sample ID : NGSC-BF-RCA-031008-03

Date Sampled : 03/10/08 13:05 Order #: 1082407 Sample Matrix: SOIL/SEDIMENT
 Date Received: 03/11/08 Submission #: R2842651 Percent Solid: 91.4

ANALYTE	PQL	RESULT	UNITS
DATE EXTRACTED : 03/12/08			
DATE ANALYZED : 03/13/08			
ANALYTICAL DILUTION: 10.00			Dry Weight
ALDRIN	1.7	19 U	UG/KG
ALPHA-BHC	1.7	19 U	UG/KG
BETA-BHC	1.7	19 U	UG/KG
DELTA-BHC	1.7	19 U	UG/KG
GAMMA-BHC (LINDANE)	1.7	19 U	UG/KG
CHLORDANE	8.3	590	UG/KG
4,4'-DDD	3.3	36 U	UG/KG
4,4'-DDE	3.3	36 U	UG/KG
4,4'-DDT	3.3	36 U	UG/KG
DIELDRIN	3.3	36 U	UG/KG
ALPHA-ENDOSULFAN	1.7	19 U	UG/KG
BETA-ENDOSULFAN	3.3	36 U	UG/KG
ENDOSULFAN SULFATE	3.3	36 U	UG/KG
ENDRIN	3.3	36 U	UG/KG
ENDRIN ALDEHYDE	3.3	36 U	UG/KG
ENDRIN KETONE	3.3	36 U	UG/KG
HEPTACHLOR	1.7	19 U	UG/KG
HEPTACHLOR EPOXIDE	1.7	19 U	UG/KG
METHOXYCHLOR	17	190 U	UG/KG
TOXAPHENE	33	360 U	UG/KG
<u>SURROGATE RECOVERIES</u>	<u>QC LIMITS</u>		
DECACHLOROBIPHENYL (DCB)	(18 - 176 %)	87	%
TETRACHLORO-META-XYLENE (TCMX)	(24 - 136 %)	74	%

COLUMBIA ANALYTICAL SERVICES

EXTRACTABLE ORGANICS

METHOD 8081A

Reported: 03/14/08

ARCADIS of New York

Project Reference: NGC SVE IRM

Client Sample ID : NGSC-BF-RCA-031008-04

Date Sampled : 03/10/08 13:10 Order #: 1082408 Sample Matrix: SOIL/SEDIMENT
 Date Received: 03/11/08 Submission #: R2842651 Percent Solid: 89.2

ANALYTE	PQL	RESULT	UNITS
DATE EXTRACTED : 03/12/08			
DATE ANALYZED : 03/13/08			
ANALYTICAL DILUTION: 10.00			Dry Weight
ALDRIN	1.7	43	UG/KG
ALPHA-BHC	1.7	19 U	UG/KG
BETA-BHC	1.7	19 U	UG/KG
DELTA-BHC	1.7	19 U	UG/KG
GAMMA-BHC (LINDANE)	1.7	19 U	UG/KG
CHLORDANE	8.3	480	UG/KG
4,4'-DDD	3.3	37 U	UG/KG
4,4'-DDE	3.3	37 U	UG/KG
4,4'-DDT	3.3	37 U	UG/KG
DIELDRIN	3.3	37 U	UG/KG
ALPHA-ENDOSULFAN	1.7	19 U	UG/KG
BETA-ENDOSULFAN	3.3	37 U	UG/KG
ENDOSULFAN SULFATE	3.3	37 U	UG/KG
ENDRIN	3.3	37 U	UG/KG
ENDRIN ALDEHYDE	3.3	37 U	UG/KG
ENDRIN KETONE	3.3	37 U	UG/KG
HEPTACHLOR	1.7	19 U	UG/KG
HEPTACHLOR EPOXIDE	1.7	19 U	UG/KG
METHOXYCHLOR	17	190 U	UG/KG
TOXAPHENE	33	370 U	UG/KG

SURROGATE RECOVERIES

QC LIMITS

DECACHLOROBIPHENYL (DCB)	(18 - 176 %)	101	%
TETRACHLORO-META-XYLENE (TCMX)	(24 - 136 %)	80	%

COLUMBIA ANALYTICAL SERVICES

EXTRACTABLE ORGANICS

METHOD 8081A

Reported: 03/14/08

ARCADIS of New York

Project Reference: NGC SVE IRM

Client Sample ID : NGSC-BF-RCA-031008-05

Date Sampled : 03/10/08 13:15 Order #: 1082409 Sample Matrix: SOIL/SEDIMENT
 Date Received: 03/11/08 Submission #: R2842651 Percent Solid: 92.7

ANALYTE	PQL	RESULT	UNITS
DATE EXTRACTED : 03/12/08			
DATE ANALYZED : 03/13/08			
ANALYTICAL DILUTION: 10.00			Dry Weight
ALDRIN	1.7	18 U	UG/KG
ALPHA-BHC	1.7	18 U	UG/KG
BETA-BHC	1.7	18 U	UG/KG
DELTA-BHC	1.7	18 U	UG/KG
GAMMA-BHC (LINDANE)	1.7	18 U	UG/KG
CHLORDANE	8.3	440	UG/KG
4,4'-DDD	3.3	36 U	UG/KG
4,4'-DDE	3.3	36 U	UG/KG
4,4'-DDT	3.3	36 U	UG/KG
DIELDRIN	3.3	36 U	UG/KG
ALPHA-ENDOSULFAN	1.7	18 U	UG/KG
BETA-ENDOSULFAN	3.3	36 U	UG/KG
ENDOSULFAN SULFATE	3.3	36 U	UG/KG
ENDRIN	3.3	36 U	UG/KG
ENDRIN ALDEHYDE	3.3	36 U	UG/KG
ENDRIN KETONE	3.3	36 U	UG/KG
HEPTACHLOR	1.7	18 U	UG/KG
HEPTACHLOR EPOXIDE	1.7	18 U	UG/KG
METHOXYCHLOR	17	180 U	UG/KG
TOXAPHENE	33	360 U	UG/KG

SURROGATE RECOVERIES

QC LIMITS

DECACHLOROBIPHENYL (DCB)	(18 - 176 %)	92	%
TETRACHLORO-META-XYLENE (TCMX)	(24 - 136 %)	75	%

COLUMBIA ANALYTICAL SERVICES

EXTRACTABLE ORGANICS

METHOD 8081A

Reported: 03/14/08

ARCADIS of New York

Project Reference: NGC SVE IRM

Client Sample ID : NGSC-BF-RCA-031008-06

Date Sampled : 03/10/08 13:20 Order #: 1082410 Sample Matrix: SOIL/SEDIMENT
 Date Received: 03/11/08 Submission #: R2842651 Percent Solid: 90.7

ANALYTE	PQL	RESULT	UNITS
DATE EXTRACTED	: 03/12/08		
DATE ANALYZED	: 03/13/08		
ANALYTICAL DILUTION:	10.00		Dry Weight
ALDRIN	1.7	19 U	UG/KG
ALPHA-BHC	1.7	19 U	UG/KG
BETA-BHC	1.7	19 U	UG/KG
DELTA-BHC	1.7	19 U	UG/KG
GAMMA-BHC (LINDANE)	1.7	19 U	UG/KG
CHLORDANE	8.3	280	UG/KG
4,4'-DDD	3.3	36 U	UG/KG
4,4'-DDE	3.3	36 U	UG/KG
4,4'-DDT	3.3	36 U	UG/KG
DIELDRIN	3.3	36 U	UG/KG
ALPHA-ENDOSULFAN	1.7	19 U	UG/KG
BETA-ENDOSULFAN	3.3	36 U	UG/KG
ENDOSULFAN SULFATE	3.3	36 U	UG/KG
ENDRIN	3.3	36 U	UG/KG
ENDRIN ALDEHYDE	3.3	36 U	UG/KG
ENDRIN KETONE	3.3	36 U	UG/KG
HEPTACHLOR	1.7	19 U	UG/KG
HEPTACHLOR EPOXIDE	1.7	19 U	UG/KG
METHOXYCHLOR	17	190 U	UG/KG
TOXAPHENE	33	360 U	UG/KG

<u>SURROGATE RECOVERIES</u>	<u>QC LIMITS</u>		
DECACHLOROBIPHENYL (DCB)	(18 - 176 %)	87	%
TETRACHLORO-META-XYLENE (TCMX)	(24 - 136 %)	78	%

COLUMBIA ANALYTICAL SERVICES

EXTRACTABLE ORGANICS
METHOD 8082 PCB'S
Reported: 03/14/08

ARCADIS of New York
Project Reference: NGC SVE IRM
Client Sample ID : NGSC-BF-RCA-031008-01

Date Sampled : 03/10/08 12:55 Order #: 1082405 Sample Matrix: SOIL/SEDIMENT
Date Received: 03/11/08 Submission #: R2842651 Percent Solid: 88.1

ANALYTE	PQL	RESULT	UNITS
DATE EXTRACTED : 03/12/08			
DATE ANALYZED : 03/12/08			
ANALYTICAL DILUTION: 1.00			Dry Weight
PCB 1016	33	37 U	UG/KG
PCB 1221	67	76 U	UG/KG
PCB 1232	33	37 U	UG/KG
PCB 1242	33	37 U	UG/KG
PCB 1248	33	37 U	UG/KG
PCB 1254	33	37 U	UG/KG
PCB 1260	33	37 U	UG/KG

<u>SURROGATE RECOVERIES</u>	<u>QC LIMITS</u>		
DECACHLOROBIPHENYL	(29 - 153 %)	75	%
TETRACHLORO-META-XYLENE	(27 - 134 %)	93	%

COLUMBIA ANALYTICAL SERVICES

EXTRACTABLE ORGANICS

METHOD 8082 PCB'S

Reported: 03/14/08

ARCADIS of New York

Project Reference: NGC SVE IRM

Client Sample ID : NGSC-BF-RCA-031008-02

Date Sampled : 03/10/08 13:00 Order #: 1082406 Sample Matrix: SOIL/SEDIMENT
Date Received: 03/11/08 Submission #: R2842651 Percent Solid: 91.2

ANALYTE	PQL	RESULT	UNITS
DATE EXTRACTED	: 03/12/08		
DATE ANALYZED	: 03/12/08		
ANALYTICAL DILUTION:	1.00		Dry Weight
PCB 1016	33	36 U	UG/KG
PCB 1221	67	73 U	UG/KG
PCB 1232	33	36 U	UG/KG
PCB 1242	33	36 U	UG/KG
PCB 1248	33	36 U	UG/KG
PCB 1254	33	36 U	UG/KG
PCB 1260	33	36 U	UG/KG

<u>SURROGATE RECOVERIES</u>	<u>QC LIMITS</u>		
DECACHLOROBIPHENYL	(29 - 153 %)	66	%
TETRACHLORO-META-XYLENE	(27 - 134 %)	95	%

COLUMBIA ANALYTICAL SERVICES

EXTRACTABLE ORGANICS

METHOD 8082 PCB'S

Reported: 03/14/08

ARCADIS of New York

Project Reference: NGC SVE IRM

Client Sample ID : NGSC-BF-RCA-031008-03

Date Sampled : 03/10/08 13:05 Order #: 1082407 Sample Matrix: SOIL/SEDIMENT
Date Received: 03/11/08 Submission #: R2842651 Percent Solid: 91.4

ANALYTE	PQL	RESULT	UNITS
DATE EXTRACTED	: 03/12/08		
DATE ANALYZED	: 03/12/08		
ANALYTICAL DILUTION:	1.00		Dry Weight
PCB 1016	33	36 U	UG/KG
PCB 1221	67	73 U	UG/KG
PCB 1232	33	36 U	UG/KG
PCB 1242	33	36 U	UG/KG
PCB 1248	33	36 U	UG/KG
PCB 1254	33	36 U	UG/KG
PCB 1260	33	36 U	UG/KG

<u>SURROGATE RECOVERIES</u>	<u>QC LIMITS</u>		
DECACHLOROBIPHENYL	(29 - 153 %)	70	%
TETRACHLORO-META-XYLENE	(27 - 134 %)	92	%

COLUMBIA ANALYTICAL SERVICES

EXTRACTABLE ORGANICS
METHOD 8082 PCB'S
Reported: 03/14/08

ARCADIS of New York
Project Reference: NGC SVE IRM
Client Sample ID : NGSC-BF-RCA-031008-04

Date Sampled : 03/10/08 13:10 Order #: 1082408 Sample Matrix: SOIL/SEDIMENT
Date Received: 03/11/08 Submission #: R2842651 Percent Solid: 89.2

ANALYTE	PQL	RESULT	UNITS
DATE EXTRACTED	: 03/12/08		
DATE ANALYZED	: 03/12/08		
ANALYTICAL DILUTION:	1.00		Dry Weight
PCB 1016	33	37 U	UG/KG
PCB 1221	67	75 U	UG/KG
PCB 1232	33	37 U	UG/KG
PCB 1242	33	37 U	UG/KG
PCB 1248	33	37 U	UG/KG
PCB 1254	33	37 U	UG/KG
PCB 1260	33	37 U	UG/KG
<u>SURROGATE RECOVERIES</u>	<u>QC LIMITS</u>		
DECACHLOROBIPHENYL	(29 - 153 %)	66	%
TETRACHLORO-META-XYLENE	(27 - 134 %)	96	%

COLUMBIA ANALYTICAL SERVICES

EXTRACTABLE ORGANICS
METHOD 8082 PCB'S
Reported: 03/14/08

ARCADIS of New York
Project Reference: NGC SVE IRM
Client Sample ID : NGSC-BF-RCA-031008-05

Date Sampled : 03/10/08 13:15 Order #: 1082409 Sample Matrix: SOIL/SEDIMENT
Date Received: 03/11/08 Submission #: R2842651 Percent Solid: 92.7

ANALYTE	PQL	RESULT	UNITS
DATE EXTRACTED	: 03/12/08		
DATE ANALYZED	: 03/12/08		
ANALYTICAL DILUTION:	1.00		Dry Weight
PCB 1016	33	36 U	UG/KG
PCB 1221	67	72 U	UG/KG
PCB 1232	33	36 U	UG/KG
PCB 1242	33	36 U	UG/KG
PCB 1248	33	36 U	UG/KG
PCB 1254	33	36 U	UG/KG
PCB 1260	33	36 U	UG/KG

<u>SURROGATE RECOVERIES</u>	<u>QC LIMITS</u>		
DECACHLOROBIPHENYL	(29 - 153 %)	63	%
TETRACHLORO-META-XYLENE	(27 - 134 %)	98	%

COLUMBIA ANALYTICAL SERVICES

EXTRACTABLE ORGANICS
METHOD 8082 PCB'S
Reported: 03/14/08

ARCADIS of New York
Project Reference: NGC SVE IRM
Client Sample ID : NGSC-BF-RCA-031008-06

Date Sampled : 03/10/08 13:20 Order #: 1082410 Sample Matrix: SOIL/SEDIMENT
Date Received: 03/11/08 Submission #: R2842651 Percent Solid: 90.7

ANALYTE	PQL	RESULT	UNITS
DATE EXTRACTED : 03/12/08			
DATE ANALYZED : 03/12/08			
ANALYTICAL DILUTION: 1.00			Dry Weight
PCB 1016	33	36 U	UG/KG
PCB 1221	67	74 U	UG/KG
PCB 1232	33	36 U	UG/KG
PCB 1242	33	36 U	UG/KG
PCB 1248	33	36 U	UG/KG
PCB 1254	33	36 U	UG/KG
PCB 1260	33	36 U	UG/KG

SURROGATE RECOVERIES
DECACHLOROBIPHENYL
TETRACHLORO-META-XYLENE

QC LIMITS
(29 - 153 %)
(27 - 134 %)

62 %
95 %