

**Quarterly Operation, Maintenance,
and Monitoring Report for the
Groundwater Interim Remedial
Measure**

March 2013

Operable Unit 3 (Former Grumman Settling Ponds)
Bethpage, New York

NYSDEC ID # 1-30-003A



Salvatore Tedesco
Staff Environmental Engineering Specialist

William S. Wittek, PE
Senior Engineer

Carlo San Giovanni
Project Manager

**Quarterly Operation,
Maintenance, and Monitoring
Report for the Groundwater
Interim Remedial Measure**

March 2013

Operable Unit 3 (Former
Grumman Settling Ponds)
Bethpage, New York

NYSDEC ID# 1-30-003A

Prepared for:
Northrop Grumman Systems Corporation

Prepared by:
ARCADIS of New York, Inc.
Two Huntington Quadrangle
Suite 1S10
Melville
New York 11747
Tel 631 249 7600
Fax 631 249 7610

Our Ref.:
NY001496.1112.GWSI4

Date:
May 29, 2013

1. Introduction	1
2. Groundwater Interim Remedial Measure Objectives	2
3. Groundwater Interim Remedial Measure Description	2
4. Operation and Maintenance Activities	4
5. Treatment System Compliance and Performance Monitoring	5
5.1 System Monitoring Activities	5
5.2 Summary of OM&M Results and Conclusions	6
5.2.1 System Operation and Effectiveness	6
5.2.2 Regulatory Status of Discharges	8
5.2.2.1 Air Discharge	8
5.2.2.2 Water Discharge	9
6. Environmental Effectiveness Monitoring	9
6.1 Hydraulic Monitoring	9
6.1.1 Activities	9
6.1.2 Results	9
6.2 Groundwater Quality Monitoring	10
6.2.1 Activities	10
6.2.2 Results	10
6.3 Environmental Effectiveness Monitoring Conclusions	10
7. Groundwater IRM Recommendations	11
8. References	12

Tables

Table 1	Operational Summary, Groundwater Interim Remedial Measure, Operable Unit 3 (Former Grumman Settling Ponds), Bethpage, New York.
Table 2	Summary of Influent Water Sample Analytical Results, Groundwater Interim Remedial Measure, Operable Unit 3 (Former Grumman Settling Ponds), Bethpage, New York.
Table 3	Summary of Effluent Water Sample Analytical Results, Groundwater Interim Remedial Measure, Operable Unit 3 (Former Grumman Settling Ponds), Bethpage, New York.
Table 4	Summary of Influent Vapor Sample Analytical Results, Groundwater Interim Remedial Measure, Operable Unit 3 (Former Grumman Settling Ponds), Bethpage, New York.
Table 5	Summary of Effluent Vapor Sample Analytical Results, Groundwater Interim Remedial Measure, Operable Unit 3 (Former Grumman Settling Ponds), Bethpage, New York.
Table 6	Summary of System Parameters, Groundwater Interim Remedial Measure, Operable Unit 3 (Former Grumman Settling Ponds), Bethpage, New York.
Table 7	Summary of Groundwater Recovered, VOC Mass Recovered, and VOC Mass Recovery Rates, Groundwater Interim Remedial Measure, Operable Unit 3 (Former Grumman Settling Ponds), Bethpage, New York.
Table 8	Summary of Air Emissions Model Output, Groundwater Interim Remedial Measure, Operable Unit 3 (Former Grumman Settling Ponds), Bethpage, New York.
Table 9	Concentrations of Volatile Organic Compounds in Groundwater Samples Collected from Remedial Wells, Groundwater Interim Remedial Measure, Operable Unit 3 (Former Grumman Settling Ponds), Bethpage, New York.
Table 10	Concentrations of Metals in Groundwater Samples Collected from Remedial Wells, Groundwater Interim Remedial Measure, Operable Unit 3 (Former Grumman Settling Ponds), Bethpage, New York.
Table 11	Summary of Water-Level Elevations, Groundwater Interim Remedial Measure, Operable Unit 3 (Former Grumman Settling Ponds), Bethpage, New York.
Table 12	Summary of Calculated Vertical Hydraulic Gradients, Groundwater Interim Remedial Measure, Operable Unit 3 (Former Grumman Settling Ponds), Bethpage, New York.

- Table 13 Concentrations of Volatile Organic Compounds in Groundwater Samples Collected from Monitoring Wells, Groundwater Interim Remedial Measure, Operable Unit 3 (Former Grumman Settling Ponds), Bethpage, New York.
- Table 14 Concentrations of Metals in Groundwater Samples Collected from Monitoring Wells, Groundwater Interim Remedial Measure, Operable Unit 3 (Former Grumman Settling Ponds), Bethpage, New York.

Figures

- Figure 1 Site Area Location , Groundwater Interim Remedial Measure, Operable Unit 3 (Former Grumman Settling Ponds), Bethpage, New York.
- Figure 2 Site and Groundwater Interim Remedial Measure Layout, Groundwater Interim Remedial Measure, Operable Unit 3 (Former Grumman Settling Ponds), Bethpage, New York.
- Figure 3 Groundwater Treatment System Process Schematic, Process Flow Diagram and Monitoring Locations, Groundwater Interim Remedial Measure, Operable Unit 3 (Former Grumman Settling Ponds), Bethpage, New York.
- Figure 4 Groundwater Monitoring Well Network and Configuration of the Shallow Potentiometric Surface and Groundwater Flow Directions First Quarter 2013, Groundwater Interim Remedial Measure, Operable Unit 3 (Former Grumman Settling Ponds), Bethpage, New York.
- Figure 5 Cumulative Total, Project, and Non-Project VOC Mass Removed Through March 2013, Groundwater Interim Remedial Measure, Operable Unit 3 (Former Grumman Settling Ponds), Bethpage, New York.
- Figure 6A Remedial Well Total VOC Concentrations Through March 2013, Groundwater Interim Remedial Measure, Operable Unit 3 (Former Grumman Settling Ponds), Bethpage, New York.
- Figure 6B Remedial Well Project VOC Concentrations Through March 2013, Groundwater Interim Remedial Measure, Operable Unit 3 (Former Grumman Settling Ponds), Bethpage, New York.
- Figure 6C Remedial Well Non-Project VOC Concentrations Through March 2013, Groundwater Interim Remedial Measure, Operable Unit 3 (Former Grumman Settling Ponds), Bethpage, New York.
- Figure 7 Influent Total, Project, and Non-Project VOC Concentrations Through March 2013, Groundwater Interim Remedial Measure, Operable Unit 3 (Former Grumman Settling Ponds), Bethpage, New York.

- Figure 8A Total VOC Mass Recovery Rates Through March 2013, Groundwater Interim Remedial Measure, Operable Unit 3 (Former Grumman Settling Ponds), Bethpage, New York.
- Figure 8B Project VOC Mass Recovery Rates Through March 2013, Groundwater Interim Remedial Measure, Operable Unit 3 (Former Grumman Settling Ponds), Bethpage, New York.
- Figure 8C Non-Project VOC Mass Recovery Rates Through March 2013, Groundwater Interim Remedial Measure, Operable Unit 3 (Former Grumman Settling Ponds), Bethpage, New York.
- Figure 9 Cross Section D-D' Showing TVOCs in Groundwater and Direction of Vertical Groundwater Hydraulic Gradients First Quarter 2013, Groundwater Interim Remedial Measure, Operable Unit 3 (Former Grumman Settling Ponds), Bethpage, New York

Appendices

- A Well Construction Information and Environmental Effectiveness Monitoring Program
- B Compliance and Performance Program and Water Sample Analytical Results
- C Vapor Sample Analytical Results
- D Air Discharge Quality Evaluation

March 2013

1. Introduction

Pursuant to the Administrative Order on Consent (AOC) Index # W1-0018-04-01 (NYSDEC 2005), ARCADIS of New York, Inc. (ARCADIS), on behalf of Northrop Grumman Systems Corporation (Northrop Grumman), has prepared this Operable Unit 3 (OU3) Groundwater Interim Remedial Measure (Groundwater IRM) Quarterly Operation, Maintenance, and Monitoring (OM&M) Report for submittal to the New York State Department of Environmental Conservation (NYSDEC). The present day Bethpage Community Park property (Park) and the Former Grumman Plant 24 Access Road, which the NYSDEC has collectively termed the “Former Grumman Settling Ponds Area” and designated as OU3, are referred to herein as the Site Area. A Site Area Location map is provided on Figure 1.

The Groundwater IRM has been operational since July 21, 2009. This quarterly OM&M report summarizes the Groundwater IRM OM&M activities performed between January 1 and March 31, 2013 (hereinafter referred to as the reporting period). During this reporting period, the Remedial System and Environmental Effectiveness Monitoring Programs were conducted in accordance with the NYSDEC-approved OU3 Interim Groundwater IRM OM&M Manual (OM&M Manual) (ARCADIS 2009) and the remedial well maintenance program described in the 2011 Annual Report (ARCADIS 2012).

As discussed in the OU3 Site Area Remedial Investigation Report (Site Area RI) (ARCADIS 2011a), Northrop Grumman does not take responsibility for certain compounds (e.g. Freon 12 and Freon 22), which are present in Site Area groundwater. Throughout this report, a distinction is made between the “Project” and “Non-project” Volatile Organic Compounds (VOCs), which are defined as follows:

- “Project VOCs:” are VOCs that may be related to former Grumman historical activities. For this report, Project VOCs are the VOCs listed in the Interim State Pollutant Elimination Discharge System (SPDES) permit equivalency (NYSDEC 2009), plus Toluene, Benzene, and Total Xylenes. A list of “Project VOCs” is provided in various tables throughout this report.
- “Non-project VOCs:” are VOCs, such as Freon 12 and Freon 22 that are unrelated to former Grumman activities but have been detected in the Site Area groundwater. As noted in the Site Area RI (ARCADIS 2011a), a sub-plume of Freon 22 has been identified originating from the area of the Town of Oyster Bay’s (Town’s) former ice rink (shown on Figure 2). Based on Town information (Zervos,

March 2013

Theodore 2007), Freon 22 was used by the Town and released to the environment.

2. Groundwater Interim Remedial Measure Objectives

The remedial action objectives (RAOs) for the Groundwater IRM are as follows:

- Mitigate the off-site migration of project-related, dissolved-phase VOCs. Specifically, the Groundwater IRM addresses:
 - Groundwater that has total volatile organic compound (TVOC) concentrations greater than 5 micrograms per liter ($\mu\text{g/L}$) in the upper 20 feet of the surficial aquifer across the 1,200-foot wide lateral extent of the southern Site Area boundary.
 - Groundwater below the upper 20 feet of the surficial aquifer that has TVOC concentrations greater than 50 $\mu\text{g/L}$ across the 1,200-foot wide lateral extent of the southern Site Area boundary.
- Comply with applicable NYSDEC standards, criteria and guidance values (SCGs) for treated water and air emissions.

3. Groundwater Interim Remedial Measure Description

The Groundwater IRM consists of:

- A “pump-and-treat system” where groundwater is:
 - Extracted along the southern portion of the Northrop Grumman Former Plant 24 Access Road via four remedial wells.
 - Conveyed to a treatment plant at McKay Field via four underground pipelines.
 - Treated via air stripping to reduce concentrations of Project and Non-Project VOCs.
 - Filtered to remove oxidized metals.

March 2013

- Returned to the aquifer, via a discharge pipeline routed to a recharge basin located on the adjacent former Bethpage Navy Weapons Industrial Reserve Plant (NWIRP) property.
- A vapor phase treatment system that reduces concentrations of Project VOCs in the air stripper off-gas.
- A Groundwater Monitoring Network that is periodically monitored to assess the environmental effectiveness of the Groundwater IRM.

The major components of the Groundwater IRM are:

- Four Remedial Wells (RW-1, RW-2, RW-3, and RW-4) with design pumping rates of 30 gallons per minute (gpm), 75 gpm, 75 gpm, and 30 gpm, respectively, for a total design influent rate of 210 gpm.
- One low-profile air stripper to remove VOCs from the extracted groundwater prior to discharge to the recharge basins.
- Two bag filters configured so that one is “operational” and the other is in “stand by” mode. The system control logic automatically switches from the “operational” filter unit to the “stand by” filter unit when the bag filters are full to prevent a system shut down. The spent filters are then replaced and the unit is placed in “stand by” mode.
- Four emission control units (ECUs), two containing vapor phase granular activated carbon (VPGAC) and two containing potassium permanganate-impregnated zeolite (PPZ). The VPGAC ECUs treat the Project VOCs in the air stripper off gas, except for vinyl chloride, which is treated by the PPZ ECUs.
- The Groundwater Monitoring Network consists of 35 monitoring locations (i.e., 17 groundwater monitoring wells, 4 remedial wells, and 14 piezometers).

Additional information is provided in the OM&M Manual (ARCADIS 2009). The layout of the Groundwater IRM is shown on Figure 2 and a schematic drawing is provided on Figure 3. The groundwater sampling locations that form the Groundwater Monitoring Network are shown on Figure 4. Construction details for the monitoring wells and piezometers are provided in Appendix A.

March 2013

4. Operation and Maintenance Activities

In general, the Groundwater IRM operated continuously during the reporting period with the exception of brief shutdown periods for routine maintenance and alarm conditions. Groundwater IRM operation and maintenance (O&M) activities conducted during the reporting period are described below and are summarized in Table 1:

- The system operated full-time, 86 out of 90 days (96 percent uptime).
- The system was monitored during the majority of business days, either via a site visit or remotely by wireless computer link-up.
- The Supervisory Control and Data Acquisition (SCADA) system operated as designed, and when conditions warranted (see below), shut the system down automatically and instantaneously, and provided notification of system advisories and alarms to plant operators.
- Intentional system shutdowns included (see Table 1 for more information):
 - Winter Storm Nemo Emergency Preparedness (February 8, 2012).
 - Preventative quarterly maintenance on Remedial Wells RW-2 and RW-3 (February 27, 2013), which consisted of injecting carbon dioxide into the remedial wells to rehabilitate the wells and to help address iron fouling issues associated with the submersible pumps.
 - Air Stripper maintenance (March 14, 2013).
- Unintentional system shutdowns included (see Table 1 for more information):
 - High-pressure alarm condition upstream from the bag filters (February 14, 2013): Problem: Atypical short duration between two bag filter switchovers. Solution: none, unless it becomes a common problem.
 - “False” Secondary Fail Safe (SFSI) low-pressure alarm condition (5 times between March 5 and 28, 2013): Problem: Plugged and/or failing pressure switch(es) caused system to shut down due to a ‘false’ low pressure alarm (i.e. line pressure did not drop below the alarm set point but the plugged/faulty switch responded as if a low-pressure condition existed).

March 2013

Solution: Cleaned plugged switches (March 5, 2013) and replace failing ones (in 2Q2013).

5. Treatment System Compliance and Performance Monitoring

5.1 System Monitoring Activities

The following compliance and performance monitoring activities were performed during this reporting period (see Appendix B, Table B-1 for a summary of the compliance and performance monitoring program requirements):

- Three (3) sampling events to collect required monthly water samples and quarterly air samples.
- Thirteen (13) weekly site visits to monitor and record key system operational parameters.
- The following additional, non-routine monitoring activities were performed during this reporting period to assess system performance:
 - RW-2 and RW-3 water samples were analyzed for total and dissolved iron during each of the three monthly sampling events to help assess iron fouling impacts. Results are provided in Appendix B.

The system operation and monitoring results are summarized in the following tables, graphs, and appendices:

- An Operational Summary, including monitoring events, system operational days, and noteworthy site activities (Table 1).
- Summary of Influent and Effluent Water Sample Analytical Results (Tables 2 and 3, respectively). Table 3 also provides the Groundwater IRM treatment system removal efficiency. Complete validated Water Sample Analytical Result Summaries for each sampling event are included in Appendix B.
- Summary of Influent and Effluent Vapor Sample Analytical Results (Tables 4 and 5, respectively). Table 5 also provides the Groundwater IRM treatment system removal efficiency. Complete, validated Vapor Sample Analytical Results, for each sample event, are included in Appendix C.

March 2013

- System Parameters including flow rates, line pressures, and temperatures (Table 6).
- Summaries of Groundwater Recovered, VOC Mass Recovered, and VOC Recovery Rates (Table 7). Table 7 provides a breakdown of these parameters by Remedial Well and System and also breaks down the VOC Mass Recovered and VOC Recovery Rates into Project, Non-Project, and Total VOCs.
- Air Discharge Quality Evaluation and Compliance Table (Appendix D and Table 8, respectively).
- Concentrations of VOCs and Metals in Remedial Well Groundwater Samples (Tables 9 and 10, respectively).
- Cumulative Total, Project, and Non-Project VOC Mass Removed (Figure 5).
- Remedial Well Total, Project, and Non-Project VOC Concentrations (Figures 6A, 6B, and 6C, respectively).
- Influent Total, Project, and Non-Project VOC Concentrations (Figure 7).
- Total, Project, and Non-Project VOC Mass Recovery Rates (Figures 8A, 8B, and 8C, respectively).

5.2 Summary of OM&M Results and Conclusions

5.2.1 System Operation and Effectiveness

Groundwater IRM OM&M results and conclusions for the reporting period are summarized below:

- Total volume of groundwater recovered and treated (Table 7):
 - 1st Quarter 2013: 23 million gallons.
 - Cumulative Total: 378 million gallons.
- Total VOC mass recovered (Table 7 and Figures 5, 8A, 8B, and 8C):
 - 1st Quarter 2013: 50 pounds (lbs) of VOCs.

March 2013

- Cumulative Total: 1,874 lbs of VOCs.
- The majority of VOCs recovered during this quarterly reporting period were Project VOCs (52% or 26 lbs). This is consistent with 2012 fourth quarter (4Q2012) data. Prior to 4Q2012, Project VOC recovery had not exceeded Non-Project VOC recovery in a quarterly reporting period since 2009.
- Well-specific VOC mass recovered and mass removal rates (Table 7 and Figures 8A, 8B, and 8C):
 - The majority of Project VOCs were recovered by RW-2 (94%) and RW-3 (6%).
 - The majority of the Non-Project VOCs were recovered by RW-3 (70%) and RW-4 (30%).
- Treatment system influent concentrations (Table 2 and Figure 7):
 - Project VOC influent concentrations for the first two months of the reporting period (78 µg/L and 80 µg/L) were lower than the 2012 average influent concentration (106 µg/L), continuing the general decreasing trend starting in 2009. The March 2013 concentration of 206 µg/L was higher than previously observed 2012 values but well below the peak concentration of ~1,000 µg/L (in August 2009).
 - Non-Project influent concentrations (64 to 86 µg/L during the reporting period) are lower than the 2012 average influent concentration (143 µg/L), continuing the decreasing trend starting in 2010, and are well below the peak concentration of 650 µg/L (in May 2010).
 - Mercury has not been detected in an influent sample since system start-up.
- Metals concentrations in the remedial wells during this reporting period are consistent with historical metals concentrations with the exception of the elevated iron concentration (1,950 µg/L total iron) in the March 2013 RW-2 sample. The elevated RW-2 total iron concentration is believed to be attributed to the iron precipitate that coats the well and pipeline, specifically, small pieces of the iron precipitate can break off and become entrained in the influent groundwater.
- The air stripper, air stripper off-gas treatment system, and bag filter system performed within acceptable parameters for this reporting period, as indicated by:

March 2013

- The air stripper VOC removal efficiency was greater than 99.9 percent for Project and Non-Project VOCs (Table 3).
- Both the water and air discharges complied with their applicable standards, criteria, guidance values (SGCs) and discharge limits (Tables 3, 5, and 8).

5.2.2 Regulatory Status of Discharges

5.2.2.1 Air Discharge

To determine the compliance status of air discharge from the Groundwater IRM treatment system, the system's effluent vapor concentrations were compared to NYSDEC Division of Air Resources Air Guide-1 (DAR-1) Model Short-term Guideline Concentrations (SGCs [NYSDEC 2010]) (Table 5) and the effluent vapor laboratory results were compared to a site-specific modeled annual maximum allowable stack concentration (MASC). The annual MASC was calculated during each monitoring event for individual compounds using the output from the USEPA SCREEN3 Model in conjunction with the NYSDEC DAR-1 AGCs. A scaling factor was calculated using the SCREEN3 model with site-specific physical layout information (e.g. building dimensions, stack height, terrain, etc.) and operating data (e.g. air flow rate, temperature, etc.) inputs for each monitoring event. The scaling factor was then used to adjust (scale) the NYSDEC DAR-1 AGC to a site-specific MASC. A summary of the instantaneous percent (i.e., not time-weighted) of the site-specific annual MASC for Project VOCs, Freon 12, and Freon 22 is provided in Table 8. A summary of the cumulative annual percent (i.e. time-weighted) of the site-specific MASC for detected compounds is also provided in Table 8. A summary of the model inputs, outputs, and backup calculations is provided in Appendix D.

The Groundwater IRM air effluent met NYSDEC requirements throughout the reporting period as indicated by the following:

- The measured concentrations of individual VOCs in the vapor effluent did not exceed applicable SGCs (Table 5).
- The measured concentration of individual VOCs in the vapor effluent did not exceed their applicable, instantaneous MASCs, as calculated using the USEPA SCREEN 3 Model (Table 8). Similarly, the time-weighted rolling averages for the individual Project VOCs, Freon 12, and Freon 22 are below their respective MASCs.

March 2013

5.2.2.2 *Water Discharge*

The Groundwater IRM treated water effluent met NYSDEC regulatory requirements during the reporting period (Table 3).

6. Environmental Effectiveness Monitoring

Groundwater IRM treatment system environmental effectiveness (i.e., hydraulic monitoring and groundwater quality monitoring) activities and results for this reporting period are discussed below.

6.1 Hydraulic Monitoring

6.1.1 Activities

In accordance with OM&M Manual requirements and methodologies (ARCADIS 2009), a quarterly round of groundwater hydraulic monitoring was performed during this reporting period. Specifically, depth-to-water measurements were collected on February 13, 2012 from 34 of the 35 locations forming the approved monitoring well network (Table 11 and Figure 4). A water-level measurement could not be collected at Monitoring Well BCPMW-1 because it was buried underneath snow.

6.1.2 Results

Figure 4 shows the configuration of the shallow potentiometric surface and the inferred horizontal groundwater flow directions on February 13, 2013 at the Site Area.

An evaluation of vertical hydraulic gradients was also conducted. The vertical hydraulic gradient is a measure of the potential for vertical groundwater flow between two vertically separated, closely spaced observation points (i.e., clustered or nested observation wells). The magnitude of the gradient indicates the steepness of the gradient, and the sign of the gradient indicates the direction of vertical flow (i.e., a positive vertical gradient indicates upward flow, while a negative vertical gradient indicates downward groundwater flow). The gradient does not provide information with respect to the rate of groundwater movement, which is affected by the hydraulic conductivity of the aquifer material through which the water is moving.

Table 12 provides a summary of calculated vertical groundwater hydraulic gradients at key well pairs located along the Site Area southern boundary during the February 13, 2013 hydraulic groundwater monitoring event, and the vertical gradient directions are

March 2013

shown on Figure 9. The vertical hydraulic gradients generally indicate that shallow groundwater is moving downward and deeper groundwater is being drawn upward toward the well screens of remedial wells within the area containing Project VOCs (i.e., RW-1 through RW-3), thereby documenting an area of vertical hydraulic control that satisfies the remedial action objective of containing Project VOC concentrations in groundwater above 5 µg/L.

6.2 Groundwater Quality Monitoring

6.2.1 Activities

Consistent with the OM&M Manual, groundwater quality monitoring was not required during the First Quarter of 2013.

6.2.2 Results

Historical groundwater quality data are summarized on the following tables:

- Table 13 summarizes the results of laboratory analysis of VOCs in groundwater samples collected from the groundwater network wells to date.
- Table 14 summarizes the results of laboratory analysis of metals in groundwater samples collected from the groundwater network wells to date.

When an appropriate amount of data has been collected, trend graphs will be developed for selected wells.

6.3 Environmental Effectiveness Monitoring Conclusions

Evaluation of the operational hydraulic groundwater monitoring data, as shown on Figure 4, indicates that the Groundwater IRM is operating as designed and the associated capture zone has developed.

Figure 9 indicates that the Groundwater IRM is preventing the off-site migration of groundwater with Project VOC concentrations greater than 5 µg/L.

March 2013

7. Groundwater IRM Recommendations

- Remove mercury from the SPDES equivalency monitoring program because mercury has never been detected in any system water sample.
- Continue operating, maintaining, and monitoring the system in accordance with the Groundwater OM&M Manual (ARCADIS 2009) including the current quarterly preventive maintenance program performed at Remedial Wells RW-2 and RW-3 to remove iron build-up in the wells and pipelines.
- Based on the consistent operation of the Groundwater IRM since July 2009, we recommend that the current, quarterly reporting frequency be reduced to annual. Consistent with the NYSDEC-approved OU3 Groundwater IRM OM&M Manual (ARCADIS 2009), an annual report will be prepared to summarize system operation, performance, and monitoring data; this annual report will be prepared and submitted under the supervision of a licensed, professional engineer. Additionally, pertinent data collected for the Groundwater IRM will be submitted to the NYSDEC as part of the semi-annual progress reports currently completed in accordance with Section III of AOC Index #W1-0018-04-01. Upon receipt of NYSDEC approval of this recommendation, the OU3 Groundwater IRM OM&M Manual (ARCADIS 2009) will be updated to reflect this change.



March 2013

8. References

ARCADIS of New York, Inc. (ARCADIS) 2009. Interim Operation, Maintenance, and Monitoring Manual, Northrop Grumman Groundwater Interim Remedial Measure, Operable Unit 3 (Former Grumman Settling Ponds), Bethpage, New York. December 2009.

ARCADIS U.S. Inc. (ARCADIS) 2011. Remedial Investigation Report (Site Area). Operable Unit 3 – Former Grumman Settling Ponds, Bethpage, New York. NYSDEC Site #1-30-003A. February 8, 2011.

ARCADIS U.S. Inc. (ARCADIS) 2012. Operation, Maintenance, and Monitoring Report for the Groundwater Interim Remedial Measure, 2011 Annual Summary Report. Operable Unit 3 – Former Grumman Settling Ponds, Bethpage, New York. NYSDEC Site # 1-30-003A. March 23, 2012.

New York State Department of Environmental Conservation (NYSDEC), 2005, Order on Consent, Index # W1-0018-04-01, Site # 1-30-003A, July 4, 2005.

New York State Department of Environmental Conservation (NYSDEC), 2009, Interim State Pollution Discharge Elimination System (SPDES) Letter, March 19, 2009.

New York State Department of Environmental Conservation (NYSDEC), 2010, DAR-1 AGC/SGC Tables, Revised October 18, 2010.

Zervos, Theodore, 2007. Deposition of Theodore Zervos in the matter Town of Oyster Bay v. Northrop Grumman Systems Corporation et al. Case No. 05-CV-1945 (TCP)(AKT). January 22, 2007.



Tables

Table 1. Operational Summary, Groundwater Interim Remedial Measure, Operable Unit 3 (Former Grumman Settling Ponds), Bethpage, New York.

MONTH	DAY																															Days Operational (1)	
	1	2	3	4	5	6	7	8	9	10	11	12	13	14	15	16	17	18	19	20	21	22	23	24	25	26	27	28	29	30	31		
2009 Total																																160	
2010 Total																																352	
2011 Total																																351	
2012 Total																																353	
Jan-13					b		###			b					b				b							b							31
Feb-13	b			###*/b			b	(2)		b				(3)b			b				b					b	(4)						25
Mar-13	b	bb	(4)bb	###b	(5)	b		b	(5)		b			b	(5,6)b	(5)										b		(5)				30	
Q1 2013																																86	
TOTAL																																1,216	

Legend:

- Indicates system online for at least the majority of the day.
- Indicates system operated with reduced flow rates.
- Indicates system offline for at least the majority of the day.
- # Indicates water compliance samples were collected.
- ## Indicates water performance samples were collected.
- ** Indicates vapor compliance samples were collected.
- * Indicates vapor performance samples were collected.
- b Indicates filter bag unit changed over.

Acronyms/Key:

- IRM Interim Remedial Measure.
- BF Bag Filter

Table 1. Operational Summary, Groundwater Interim Remedial Measure, Operable Unit 3 (Former Grumman Settling Ponds), Bethpage, New York.

Notes:

- (1) Days in which the system was operational for the majority of the day are counted as one day.
- (2) The system was shut down at ~4:15 PM on February 8, 2013 in anticipation of Winter Storm Nemo. The system was restarted at ~10:45 AM on February 10, 2013 after a full site inspection was performed after the storm.
- (3) The system shut down at 2:36 AM on February 14, 2013 due to both 401 BF & 402 BF fouling over a shorter than expected time frame, resulting in high-high pressure alarm and system shutdown. The system was off-line for approximately 9.5 hours.
- (4) The system was shut down at 9:05 AM on February 27, 2013 for preventative maintenance activities at Remedial Wells RW-2 and RW-3. During the work, the RW-2 pump was pulled, replaced with a spare pump, and subsequently cleaned for future use. Upon initial restart, the system shut down due a low pressure alarm caused by a plugged secondary, fail-safe (SFSI) pressure switch. The switch was cleaned and system was restarted at approximately 3PM. The system was down for approximately 77 hours. Over the next two days (March 2 & 3, 2013) multiple bag filter switchovers occurred and at one point the system was off-line for approximately 5.5 hours because two switchovers occurred in rapid succession.
- (5) Between March 5 and March 28, the system shut down five (5) times due to problems associated with the RW-2 and RW-3 SFSI pressure switches, specifically:
 - a) The system shut down at 10:34 AM on March 5, 2013, was restarted at 1:05 PM, and was off-line for approximately 2.5 hours.
 - b) The system shut down at 1:43 PM on March 9, 2013, the RW-2 and RW-3 switches were manually cleaned, and system was restarted at ~10:20 AM on March 10, 2013, with RW-3 running at a reduced flow rate of 65 gpm. The system was was off-line for approximately 21 hours.
 - c) The system could not be restarted after the air stripper cleaning on March 14, 2013 (see Note 6) due to pressure switch issues. The problematic RW-3 pressure switch was switched with the RW-4 pressure switch, and the system was restarted.
 - d) The system shut down at 11:54 AM on March 15, 2013 due to the problematic pressure RW-4 switch. The corresponding primary RW-4 pressure switch was tested with a positive result, and the problematic, secondary/redundent switch was temporarily taken off-line, until a replacement switch can be installed. The system was restarted at 14:06 PM and was off-line for approximately 3.25 hours.
 - e) The system shut down at 12:26 PM March 28, 2013 due to a problematic switch. The system was restarted at 2:15 PM and was off-line for approximately 2 hours.
- (6) The system was shutdown at 10:32 AM on March 14, 2013 for a periodic air stripper cleaning using a pressure washer. After the air stripper cleaning, there was a problem restarting the system (see Note 5c). The system was restarted at 4:42 PM and was off-line for approximately 6 hours.

Table 2. Summary of Influent Water Sample Analytical Results, Groundwater Interim Remedial Measure, Operable Unit 3 (Former Grumman Settling Ponds), Bethpage, New York. ⁽¹⁾

Compound ⁽²⁾	04/03/12 (µg/L)	05/07/12 (µg/L)	06/05/12 (µg/L)	07/02/12 (µg/L)	08/07/12 (µg/L)	09/04/12 (µg/L)	10/01/12 (µg/L)	11/12/12 (µg/L)	12/03/12 (µg/L)	01/07/13 (µg/L)	02/04/13 (µg/L)	03/04/13 (µg/L)
Project VOCs												
1,1,1 - Trichloroethane	ND	ND	ND	ND	ND	ND	ND	ND	ND	ND	ND	ND
1,1 - Dichloroethane	0.63	0.52	0.58	0.46	0.56	0.51	0.47	0.51	0.53	0.48	0.42	0.71
1,2 - Dichloroethane	ND	ND	ND	ND	ND	ND	ND	ND	ND	ND	ND	ND
1,1 - Dichloroethene	0.34	0.25	ND	ND	0.3	0.3	0.36	0.26	0.34	0.25	ND	0.44
Tetrachloroethene	0.29	0.35	ND	ND	0.28	0.3	0.34	0.31	0.38	0.34	0.30	0.34
Trichloroethene	7.7	6.9	7.1	7.0	7.5	7.1	7.0	6.8	6.3	5.9	5.4	7.3
Vinyl Chloride	17	11	11	10	14	17	15	17	17	16	17	52
cis 1,2-Dichloroethene	76	59	61	53	57	63	54	47	44	38	40	80
trans 1,2-Dichloroethene	ND	ND	ND	0.24	ND	ND	ND	ND	ND	ND	ND	ND
Benzene	ND	ND	ND	ND	ND	ND	ND	ND	ND	ND	ND	ND
Toluene	17	11	13	18	19	22	23	26	21	17	13	59
Xylenes	1.8	1.2	1.5	1.7	2.0	2.1	1.9	2.2	1.9	1.8	1.6	6.1
Subtotal Project VOCs	121	92	96	90	101	112	102	100	91	80	78	206
Non-Project VOCs												
Dichlorodifluoromethane (Freon 12)	ND	ND	ND	ND	ND	ND	ND	ND	ND	ND	ND	ND
Chlorodifluoromethane (Freon 22)	200	150	130	120	140	130	100	110	100	86	85	64
Subtotal Non-Project VOCs	200	150	130	120	140	130	100	110	100	86	85	64
Total VOCs ⁽³⁾	321	242	226	210	241	242	202	210	191	166	163	270
Inorganics												
Total Iron	600	650	360	470	850	410	400	330	840	370	510	370
Total Mercury	NA	NA	NA	NA	NA	NA	NA	NA	NA	NA	NA	NA
pH ⁽⁴⁾	5.4	5.4	5.6	5.4	5.7	5.3	5.5	5.6	5.3	5.9	5.7	5.4 ⁽⁵⁾

See notes on last page.

Table 2. Summary of Influent Water Sample Analytical Results, Groundwater Interim Remedial Measure, Operable Unit 3 (Former Grumman Settling Ponds), Bethpage, New York. ⁽¹⁾

Notes:

- (1) Water samples collected by ARCADIS on the dates shown and submitted to Columbia Analytical Services, Inc. for VOC analyses per NYSDEC ASP 2000, Method OLM 4.3, for iron analyses per USEPA Method 6010 and for mercury analyses per USEPA Method 7470. The VOC analyte list is provided in the DRAFT Groundwater IRM OM&M Manual (ARCADIS 2009b). Influent water samples were collected from Water Sampling Port-5 (WSP-5); refer to Figure 3 of this OM&M Report for the schematic location of WSP-5. Data in this table corresponds to approximately the past year of system operation.
- (2) Only VOCs associated with the interim State Pollutant Discharge Elimination System (SPDES) equivalency program, plus Toluene, Benzene, Xylenes, non-project related Freon 12 and Freon 22, Mercury and Iron are included in this table. Complete VOC and inorganic data summary tables, including VOC TICs, are provided in Appendix B. Laboratory data qualifiers are included in the Appendix B tables.
- (3) "Total VOCs" represents the sum of individual concentrations of the compounds detected. The values used in calculations referenced in this report have been rounded to the nearest whole number.
- (4) pH samples collected and measured in the field by ARCADIS personnel on the dates listed using an Oakton Model 300 pH/conductivity meter. pH units are standard units.
- (5) The March 2013 pH influent data was compromised, so an estimated value based on the average of available pH values (from Remedial Wells RW-2 and RW-3) is provided.

Acronyms\Key:

700	Bold data indicates that the analyte was detected at or above its reporting limit.
16	Data that is not bold indicates analyte detected but below its reporting limit; the value is estimated.
IRM	Interim remedial measure.
NA	Not analyzed.
ND	Analyte not detected at, or above its laboratory quantification limit.
NYSDEC	New York State Department of Environmental Conservation.
OM&M	Operation, maintenance and monitoring.
TICs	Tentatively identified compounds.
USEPA	United States Environmental Protection Agency.
VOC	Volatile organic compound.
µg/L	Micrograms per liter.

Table 3. Summary of Effluent Water Sample Analytical Results, Groundwater Interim Remedial Measure, Operable Unit 3 (Former Grumman Settling Ponds), Bethpage, New York. ⁽¹⁾

Compound ⁽²⁾	Discharge												
	Limit ⁽³⁾ (µg/L)	04/03/12 (µg/L)	05/07/12 (µg/L)	06/05/12 (µg/L)	07/02/12 (µg/L)	08/07/12 (µg/L)	9/4/5/2012 (µg/L)	10/01/12 (µg/L)	11/12/12 (µg/L)	12/03/12 (µg/L)	01/07/13 (µg/L)	02/04/13 (µg/L)	03/04/13 (µg/L)
Project VOCs													
1,1,1 - Trichloroethane	5	ND	ND	ND	ND	ND	ND	ND	ND	ND	ND	ND	ND
1,1 - Dichloroethane	5	ND	ND	ND	ND	ND	ND	ND	ND	ND	ND	ND	ND
1,2 - Dichloroethane	5	ND	ND	ND	ND	ND	ND	ND	ND	ND	ND	ND	ND
1,1 - Dichloroethene	5	ND	ND	ND	ND	ND	ND	ND	ND	ND	ND	ND	ND
Tetrachloroethene	5	ND	ND	ND	ND	ND	ND	ND	ND	ND	ND	ND	ND
Trichloroethene	5	ND	ND	ND	ND	ND	ND	ND	ND	ND	ND	ND	ND
Vinyl Chloride	5	ND	ND	ND	ND	ND	ND	ND	ND	ND	ND	ND	ND
cis 1,2-Dichloroethene	5	ND	ND	ND	ND	ND	ND	ND	ND	ND	ND	ND	ND
trans 1,2-Dichloroethene	5	ND	ND	ND	ND	ND	ND	ND	ND	ND	ND	ND	ND
Benzene	5	ND	ND	ND	ND	ND	ND	ND	ND	ND	ND	ND	ND
Toluene	5	ND	ND	ND	ND	ND	ND	ND	ND	ND	ND	ND	ND
Xylenes	5	ND	ND	ND	ND	ND	ND	ND	ND	ND	ND	ND	ND
Subtotal Project VOCs	--	0.0	0.0	0.0	0.0	0.0	0.0	0.0	0.0	0.0	0.0	0.0	0.0
Non-Project VOCs													
Dichlorodifluoromethane (Freon 12)	5	ND	ND	ND	ND	ND	ND	ND	ND	ND	ND	ND	ND
Chlorodifluoromethane (Freon 22)	5	ND	ND	ND	ND	ND	ND	ND	ND	ND	ND	ND	ND
Subtotal Non-Project VOCs	--	0	0	0	0	0	0	0	0	0	0	0	0
Total VOCs ⁽⁴⁾	--	0.0	0.0	0.0	0.0	0.0	0.0	0.0	0.0	0.0	0.0	0.0	0.0
Treatment Efficiency ⁽⁵⁾	--	> 99.9%	> 99.9%	> 99.9%	> 99.9%	> 99.9%	> 99.9%	> 99.9%	> 99.9%	> 99.9%	> 99.9%	> 99.9%	> 99.9%
Inorganics													
Total Iron	600	290	330	250	290	350	240	430	270	230	140	370	560
Total Mercury	250	ND	ND	ND	ND	ND	ND	ND	ND	ND	ND	ND	ND
pH ⁽⁶⁾	5.5 - 8.5	6.5	6.7	6.8	6.6	6.6	6.0	6.7	6.4	6.4	6.7	7.5	6.7

See notes on last page.

Table 3. Summary of Effluent Water Sample Analytical Results, Groundwater Interim Remedial Measure, Operable Unit 3 (Former Grumman Settling Ponds), Bethpage, New York. ⁽¹⁾

Notes:

- (1) Water samples collected by ARCADIS on the dates shown and submitted to Columbia Analytical Services, Inc. for VOC analyses per NYSDEC ASP 2000, Method OLM 4.3, for iron analyses per USEPA Method 6010 and for mercury analyses per USEPA Method 7470. The VOC analyte list is provided in the DRAFT Groundwater IRM OM&M Manual (ARCADIS 2009b). Effluent water samples were collected from Water Sampling Port-7 (WSP-7); refer to Figure 3 of this OM&M Report for the location of WSP-7. Data in this tables corresponds to approximately the past year of system operation.
- (2) Only VOCs associated with the interim SPDES equivalency program, including Toluene, Benzene, Xylenes, non-project related Freon 12 and Freon 22, Mercury and Iron are included in this table. Complete VOC and inorganic data summary tables, including VOC TICs, are provided in Appendix B. Laboratory data qualifiers are included in the Appendix B tables.
- (3) Discharge limits per the interim SPDES equivalency program or Division of Water Technical and Operational Guidance Series (TOGS 1.1.1) Quality Standards and Guidance Values and Groundwater Effluent Limitations, if the compound is not part of the interim SPDES equivalency program.
- (4) "Total VOCs" represents the sum of individual concentrations of compounds detected. The values used in calculations referenced in this report have been rounded to the nearest whole number.
- (5) Treatment efficiency was calculated by dividing the difference between the influent and effluent total VOC concentrations by the influent total VOC concentration.
- (6) Influent pH samples collected and measured in the field by ARCADIS personnel on the dates listed using an Oakton Model 300 pH/conductivity meter. pH units are standard units.

Acronyms\Key:

- 700** Bold data indicates that the analyte was detected at or above its reporting limit.
- 16 Data that is not bold indicates analyte detected but below its reporting limit; the value is estimated.
- 6** Bold box indicates value is greater than discharge criterion.
- IRM Interim remedial measure.
- ND Analyte not detected at, or above its laboratory quantification limit.
- NYSDEC New York State Department of Environmental Conservation.
- OM&M Operation, maintenance, and monitoring.
- SPDES State pollutant discharge elimination system.
- TICs Tentatively identified compounds.
- USEPA United States Environmental Protection Agency.
- VOC Volatile organic compound.
- µg/L Micrograms per liter.
- Not applicable.
- > Greater than.

Table 4. Summary of Influent Vapor Sample Analytical Results, Groundwater Interim Remedial Measure, Operable Unit 3 (Former Grumman Settling Ponds), Bethpage, New York. ⁽¹⁾

Compound ⁽²⁾	01/09/12 (µg/m ³)	04/03/12 (µg/m ³)	07/05/12 (µg/m ³)	10/03/12 (µg/m ³)	12/03/12 (µg/m ³)	02/04/13 (µg/m ³)
Project VOCs						
1,1,1 - Trichloroethane	ND	ND	ND	ND	2.4	ND
1,1 - Dichloroethane	8.7	9.0	7.5	8.9	11	6.2
1,2 - Dichloroethane	ND	ND	ND	ND	ND	ND
1,1 - Dichloroethene	ND	ND	4.2	ND	4.6	ND
Tetrachloroethene	ND	ND	4.0	5.3	5.9	ND
Trichloroethene	120	110	110	110	110	63
Vinyl Chloride	170	190	160	210	310	210
cis 1,2-Dichloroethene	1,200	1,100	900	900	1,000	560
trans 1,2-Dichloroethene	ND	ND	ND	ND	1.3	ND
Benzene	ND	ND	ND	ND	4.8	ND
Toluene	310	270	290	400	420	46
Xylenes	31	28	30	39	48	ND
Subtotal Project VOCs	1,840	1,707	1,506	1,673	1,918	885
Non-Project VOCs						
Dichlorodifluoromethane (Freon 12)	ND	ND	3.1	ND	3.6	ND
Chlorodifluoromethane (Freon 22)	1,700	1,800	1,300	1,000	1,100	730
Subtotal Non-Project VOCs	1,700	1,800	1,303	1,000	1,104	730
Total VOCs ⁽³⁾	3,540	3,507	2,809	2,673	3,022	1,615

See notes on last page.

Table 4. Summary of Influent Vapor Sample Analytical Results, Groundwater Interim Remedial Measure, Operable Unit 3 (Former Grumman Settling Ponds), Bethpage, New York. ⁽¹⁾

Notes:

- (1) Vapor samples collected by ARCADIS on the dates shown and submitted to Columbia Analytical Services, Inc. for VOC analyses per Modified USEPA Method T0-15. A VOC analyte list is provided in the DRAFT Groundwater IRM OM&M Manual (ARCADIS 2009b). Influent samples were collected at Vapor Sampling Port-1 (VSP-1); refer to Figure 3 of this OM&M Report for the location of VSP-1. Data in this table corresponds to approximately the past year of system operation.
- (2) Only VOCs that are associated with the interim State Pollutant Discharge Elimination System (SPDES) equivalency program, Toluene, Benzene, Xylenes, and non-project related Freon 12 and Freon 22 are included in this table. Complete VOC summary tables, including VOC TICs, are provided in Appendix C. Laboratory data qualifiers are included in the Appendix C tables.
- (3) "Total VOCs" represents the sum of individual concentrations of compounds detected. The values used in calculations referenced in this report have been rounded to the nearest whole number.

Acronyms\Key:

- 700** Bold data indicates that the analyte was detected at or above its reporting limit.
- 16 Data that is not bold indicates analyte detected but below its reporting limit; the value is estimated.
- IRM Interim remedial measure.
- ND Analyte not detected at or above its laboratory reporting limit.
- OM&M Operation, maintenance, and monitoring.
- TICs Tentatively identified compounds.
- USEPA United States Environmental Protection Agency.
- VOC Volatile organic compound.
- µg/m³ Micrograms per cubic meter.

Table 5. Summary of Effluent Vapor Sample Analytical Results, Groundwater Interim Remedial Measure, Operable Unit 3
 (Former Grumman Settling Ponds), Bethpage, New York. ⁽¹⁾

Compound ⁽²⁾	Discharge	01/09/12 (µg/m ³)	04/03/12 (µg/m ³)	07/05/12 (µg/m ³)	10/03/12 (µg/m ³)	12/03/12 (µg/m ³)	02/04/13 (µg/m ³)
	Limit ⁽³⁾ (µg/m ³)						
Project VOCs							
1,1,1 - Trichloroethane	9,000	ND	ND	ND	ND	ND	ND
1,1 - Dichloroethane	NS	ND	ND	0.82	1.1	1.8	1.8
1,2 - Dichloroethane	NS	ND	ND	ND	ND	ND	ND
1,1 - Dichloroethene	380 ⁽⁴⁾	ND	ND	ND	ND	1.0	3.3
Tetrachloroethene	1,000	ND	ND	ND	ND	ND	ND
Trichloroethene	14,000	ND	ND	1.6	3.1	4.3	4.6
Vinyl Chloride	180,000	8.1	8.4	ND	7.9	23	57
cis 1,2-Dichloroethene	190,000 ⁽⁵⁾	13	13	2.0	9.6	25	46
trans 1,2-Dichloroethene	NS	ND	ND	ND	ND	ND	ND
Benzene	1,300	11	13	0.96	ND	1.9	1.1
Toluene	37,000	30	26	27	37	38	20
Xylenes	4,300	ND	ND	ND	2.8	4.3	2.6
Subtotal Project VOCs	NA	62	60	32	62	99	136
Non-Project VOCs							
Dichlorodifluoromethane (Freon 12)	NS	ND	ND	2.9	3.1	3.5	2.6
Chlorodifluoromethane (Freon 22)	NS	1,600	1,800	1,000	1,000	1,100	820
Subtotal Non-Project VOCs	NA	1,600	1,800	1,003	1,003	1,104	823
Total VOCs ⁽⁶⁾	NA	1,662	1,860	1,035	1,065	1,203	959
Treatment Efficiency (Total VOCs) ⁽⁷⁾	NA	53.1%	47.0%	63.2%	60.2%	60.2%	40.6%
Treatment Efficiency (Project VOCs) ⁽⁸⁾	NA	96.6%	96.5%	97.9%	96.3%	94.8%	84.6%

See notes on last page.

Table 5. Summary of Effluent Vapor Sample Analytical Results, Groundwater Interim Remedial Measure, Operable Unit 3 (Former Grumman Settling Ponds), Bethpage, New York. ⁽¹⁾

Notes:

- (1) Vapor samples collected by ARCADIS on the dates shown and submitted to Columbia Analytical Services, Inc. for VOC analyses per Modified USEPA Method T0-15. A VOC analyte list is provided in the DRAFT Groundwater IRM OM&M Manual (ARCADIS 2009b). Effluent samples were collected at Vapor Sampling Port-5 (VSP-5); refer to Figure 3 of this OM&M Report for the location of VSP-5. Data in this tables corresponds to approximately the past year of system operation.
- (2) Only VOCs that are associated with the interim State Pollutant Discharge Elimination System (SPDES) equivalency program, Toluene, Benzene, Xylenes, and non-project related Freon 12 and Freon 22 are included in this table. Complete VOC summary tables, including VOC TICs, are provided in Appendix C. Laboratory data qualifiers are included in the Appendix C tables.
- (3) Discharge limit is compound specific short-term guidance concentration (SGC) per the NYSDEC DAR-1 AGC/SGC tables revised October 18, 2010.
- (4) An SGC was not provided in the DAR-1 AGC/SGC Tables, dated October 18, 2010. An interim SGC was developed based on guidance of the New York State DAR-1 Guidelines for the Control of Toxic Ambient Air Contaminants, 1991 edition. Specifically for 1,1- dichloroethene, which is not defined as provided in Section IV.A.2.b.1 a high-toxicity compound, the Interim SGC = (smaller of Time Weighted Average [TWA] - Threshold Limit Value or TWA - Recommended Exposure Limit)/4.2. or $1,600 \mu\text{g}/\text{m}^3 / 4.2 = \text{approximately } 380 \mu\text{g}/\text{m}^3$. An interim SGC was developed for this compound because it has a moderate toxicity rating, as specified in the DAR-1 AGC/SGC Tables, dated October 18, 2010.
- (5) An SGC was not provided in the DAR-1 AGC/SGC Tables, dated October 18, 2010. An interim SGC was developed based on guidance provided in Section IV.A.2.b.1 of the New York State DAR-1 Guidelines for the Control of Toxic Ambient Air Contaminants, 1991 edition. Specifically for cis-1,2 dichloroethene, which is not defined as a high-toxicity compound, the interim SGC = (smaller of Time Weighted Average [TWA] - Threshold Limit Value or TWA - Recommended Exposure Limit)/4.2 or $790,000 \mu\text{g}/\text{m}^3 / 4.2 = \text{approximately } 190,000 \mu\text{g}/\text{m}^3$. An interim SGC was developed for this compound because it has a moderate toxicity rating, as specified in the DAR-1 AGC/SGC Tables, dated October 18, 2010.
- (6) "Total VOCs" represents the sum of individual concentrations of all compounds detected. The values used in calculations referenced in this report have been rounded to the nearest whole number.
- (7) Treatment efficiency was calculated by dividing the difference between the influent and effluent Total VOC concentrations by the influent Total VOC concentration. Treatment efficiency is only calculated when there is a corresponding influent sample.
- (8) Treatment efficiency was calculated by dividing the difference between the influent and effluent total Project VOC concentrations by the influent total Project VOC concentration. Treatment efficiency is only calculated when there is a corresponding influent sample.

Acronyms/Key:

700	Bold data indicates that the analyte was detected at or above its reporting limit.
16	Data that is not bold indicates analyte detected but below its reporting limit; the value is estimated.
AGC	Annual guideline concentration.
IRM	Interim remedial measure.
ND	Analyte not detected at or above its laboratory reporting limit.
NS	Guideline concentrations not specified in the NYSDEC DAR-1 AGC/SGC tables revised September 10, 2007. An interim SGC was not developed for these compounds because they have low toxicity ratings in the NYSDEC DAR-1 AGC/SGC tables revised October 18, 2010.
NYSDEC	New York State Department of Environmental Conservation.
OM&M	Operation, maintenance, and monitoring.
TICs	Tentatively identified compounds.
USEPA	United States Environmental Protection Agency.
VOC	Volatile organic compound.
$\mu\text{g}/\text{m}^3$	Micrograms per cubic meter.
--	Data not available or value could not be calculated.

Table 6. Summary of System Parameters, Groundwater Interim Remedial Measure, Operable Unit 3 (Former Grumman Settling Ponds), Bethpage, New York.

Date ⁽¹⁾	Water Flow Rates ^{(2), (8)}						Water Pressures ^{(2), (8)}					Air Flow Rate ^{(2), (8)}	Air Pressures ⁽²⁾				Air Temp. ⁽²⁾	
	Remedial Well				Combined Influent	Effluent	Remedial Well Effluent ⁽³⁾				Effluent	Effluent	ECU Influent				Effluent	Stack Temp.
	RW-1	RW-2	RW-3	RW-4			RW-1	RW-2	RW-3	RW-4			GAC-501	GAC-502	PPZ-601	PPZ-602		
(gpm)	(gpm)	(gpm)	(gpm)	(gpm)	(gpm)	(gpm)	(psi)	(psi)	(psi)	(psi)	(psi)	(scfm)	(inH ₂ O)	(inH ₂ O)	(inH ₂ O)	(inH ₂ O)	(inH ₂ O)	(°R)
01/09/12	30.3	75.4	75.4	30.4	217	225	58.7	46.6	46.5	57.7	7.0	2,049	8.0	3.7	0.8	2.0	0.0	532 ⁽⁴⁾
02/06/12	30.4	75.3	75.1	30.2	216	238	58.4	27.0	32.9	58.0	7.0	2,075	8.0	3.7	1.0	2.0	NM	NM
03/09/12	30.9	75.4	76.3	30.8	219	217	58.0	57.0	58.2	57.3	6.0	2,050	8.0	4.0	0.9	1.9	0.0	535 ⁽⁴⁾
04/03/12	30.3	75.1	75.6	30.3	217	227	58.3	43.3	60.2	57.7	7.5	2,079	7.9	3.5	1.0	2.0	0.0	532 ⁽⁵⁾
05/07/12	30.3	74.5	75.3	30.4	216	240	58.0	19.6	57.6	57.4	7.5	2,027	8.0	3.5	0.8	1.7	0.0	536 ⁽⁴⁾
06/05/12	30.4	74.5	75.4	30.1	216	210	57.9	35.8	57.6	57.5	8.0	2,022	7.6	3.4	1.0	2.0	0.0	525
07/02/12	30.5	75.6	75.3	30.6	217	245	57.9	23.1	53.7	57	8.7	2,020	8.0	3.6	1.1	2.3	0.0	539 ⁽⁴⁾
08/07/12	30.1	71.1	75.5	30.3	211	222	58.5	21.3	50.2	57.5	11.5	1,946	7.5	3.1	1.1	2.0	0.0	532
09/04/12	30.7	75.1	75.1	30.5	216	219	57.4	33.1	52.2	56.9	9.5	1,831	7.5	2.9	1.0	1.9	0.0	539 ⁽⁴⁾
10/01/12 ⁽⁶⁾	30.1	72.4	75.1	30.1	212	237	58.0	32.2	51.9	57.5	8.0	1,813	7.2	2.9	1.0	1.9	0.0	538 ⁽⁵⁾
11/12/12	30.3	69.3	74.9	31.1	210	223	57.6	22.0	46.0	56.0	8.5	1,963	7.5	2.8	0.9	1.9	0.0	522
12/03/12 ⁽⁷⁾	31.3	64.6	74.3	30.9	207	207	56.5	19.3	43.0	55.9	8.0	1,962	7.5	2.8	1.0	1.9	0.0	533 ⁽⁴⁾
01/07/13 ⁽⁸⁾	31.2	66.4	75.4	31.8	206	215	57	24	37	56	10	1,934	6.5	2.5	1.0	1.8	0.0	516
02/04/12	31.3	62.6	73.1	30.8	198	204	57	26	34	57	7	1,885	7.0	2.5	0.5	1.5	0.0	525
03/04/12	31.7	77.8	72.7	31.3	214	231	57	28	25	56	8	1,900	6.5	2.5	0.5	1.5	0.0	529

See notes on last page.

Table 6. Summary of System Parameters, Groundwater Interim Remedial Measure, Operable Unit 3 (Former Grumman Settling Ponds), Bethpage, New York.

Notes:

- (1) Operational data collected by ARCADIS on days noted. Parameters listed were typically recorded during compliance monitoring events. Data in this table corresponds to approximately the past year of system operation.
- (2) Instantaneous values from field-mounted instruments, except for the combined influent water-flow rate, which is the sum of individual well flow rates via the Supervisory Control and Data Acquisition (SCADA) System.
- (3) Remedial Well effluent pressure readings measured at the influent manifold within the treatment system building.
- (4) Stack temperature measured using infrared temperature gun.
- (5) ECU Mid-train temperature used because stack effluent gauge could not be read.
- (6) Water samples taken on October 1, 2012, air samples taken on October 3, 2012. Air parameters shown reflect conditions on the air sampling date.
- (7) Influent pressures to ECUs not recorded on day of sampling, the average of the next two site visits in December were used.
- (8) Starting with January's 2013 site visit the following instantaneous parameters are obtained from the SCADA HMI: Water Flow Rate, Water Pressure, Air Flow Rate.

Acronyms\Key:

ECU	Emission control unit.
gpm	Gallons per minute.
inH ₂ O	Inches of water column.
NM	Not measured. The value was not measured due to a faulty gauge.
psi	Pounds per square inch.
°R	Degrees Rankine.
scfm	Standard cubic feet per minute.
Temp.	Temperature.

Table 7. Summary of Groundwater Recovered, VOC Mass Recovered, and VOC Mass Recovery Rates, Groundwater Interim Remedial Measure, Operable Unit 3 (Former Grumman Settling Ponds), Bethpage, New York.

Operating Period ⁽¹⁾	Volume of Groundwater Recovered (x1,000 gal) ⁽²⁾					VOC Mass Recovered (lbs) ⁽³⁾															VOC Mass Recovery Rate (lbs/day) ⁽⁴⁾																			
						Total VOCs ⁽⁵⁾					Project VOCs ⁽⁶⁾					Non-Project VOCs ⁽⁷⁾					Total VOCs ⁽⁵⁾					Project VOCs ⁽⁶⁾					Non-Project VOCs ⁽⁷⁾									
	RW-1	RW-2	RW-3	RW-4	Total	RW-1	RW-2	RW-3	RW-4	Total	RW-1	RW-2	RW-3	RW-4	Total	RW-1	RW-2	RW-3	RW-4	Total	RW-1	RW-2	RW-3	RW-4	Total	RW-1	RW-2	RW-3	RW-4	Total	RW-1	RW-2	RW-3	RW-4	Total	RW-1	RW-2	RW-3	RW-4	Total
System Pilot Test, Shakedown and Start Up Totals ⁽⁸⁾																																								
	137	270	251	150	808	NA	NA	NA	NA	1.1	NA	NA	NA	NA	1.0	NA	NA	NA	NA	0.1	NA	NA	NA	NA	NA	NA	NA	NA	NA	NA	NA	NA	NA	NA	NA	NA	NA	NA	NA	NA
2009 Totals ⁽⁹⁾																																								
7/21/09 - 12/30/09	6,592	13,838	16,445	6,574	43,449	0.17	275	53	14	342	0.17	273	19	0.20	293	<0.01	0.56	35	13	48	<0.01	1.9	0.34	0.09	2.2	<0.01	1.9	0.12	<0.01	1.9	<0.01	<0.01	0.22	0.08	0.30					
2010 Totals ⁽¹⁰⁾																																								
12/30/09 - 01/05/11	15,726	35,127	38,160	15,689	104,702	0.56	172	412	89	672	0.56	171	28	0.10	200	<0.01	0.17	383	89	469	<0.01	0.46	1.1	0.24	1.8	<0.01	0.46	0.08	<0.01	0.54	<0.01	<0.01	1.0	0.24	1.3					
2011 Totals ⁽¹¹⁾																																								
01/05/11 - 01/09/12	15,218	36,570	37,682	15,196	104,666	0.36	167	271	78	516	0.36	167	35	0.09	203	<0.01	1.1	236	78	314	<0.01	0.45	0.73	0.21	1.4	<0.01	0.45	0.09	<0.01	0.55	<0.01	<0.01	0.64	0.21	0.85					
2011 Totals ⁽¹²⁾																																								
01/09/12 - 01/01/13	15,260	35,178	36,111	15,336	101,885	0.28	114	113	40	267	0.26	113	12	0.38	126	<0.01	1.5	101	40	140	<0.01	0.32	0.32	0.11	0.75	<0.01	0.32	0.03	<0.01	0.35	<0.01	<0.01	0.28	0.11	0.39					
January 2013 through March 2013 Totals																																								
01/01/13 - 02/04/13 ⁽¹³⁾	1,265	2,566	2,964	1,283	8,078	0.01	8.4	6.4	2.5	17	0.01	8.3	0.56	0.02	8.9	<0.01	0.12	5.8	2.5	8.4	<0.01	0.25	0.19	0.07	0.50	<0.01	0.24	0.02	<0.01	0.26	<0.01	<0.01	0.17	0.07	0.25					
02/04/13 - 03/04/13	1,080	2,198	2,443	1,080	6,801	0.01	7.2	5.3	2.1	15	0.01	7.1	0.46	0.02	7.6	<0.01	0.10	4.8	2.1	7.0	<0.01	0.26	0.19	0.08	0.54	<0.01	0.25	0.02	<0.01	0.27	<0.01	<0.01	0.17	0.08	0.25					
03/04/13 - 04/01/13	1,235	2,890	2,666	1,233	8,024	0.01	10	5.7	2.4	18	0.01	9.4	0.51	0.02	9.9	<0.01	0.13	5.2	2.4	7.7	<0.01	0.36	0.20	0.09	0.64	<0.01	0.34	0.02	<0.01	0.35	<0.01	<0.01	0.19	0.09	0.28					
Subtotal Jan - Mar 2013 ⁽¹⁴⁾	3,580	7,654	8,073	3,596	22,903	0.03	26	17	7.0	50	0.03	25	1.5	0.06	26	<0.01	0.35	16	7.0	23	<0.01	0.29	0.19	0.08	0.56	<0.01	0.28	0.02	<0.01	0.29	<0.01	<0.01	0.18	0.08	0.26					
2013 Totals ⁽¹⁵⁾	3,580	7,654	8,073	3,596	22,903	0.03	26	17	7.0	50	0.03	25	1.5	0.06	26	<0.01	0.35	16	7.0	23	<0.01	0.29	0.19	0.08	0.56	<0.01	0.28	0.02	<0.01	0.29	<0.01	<0.01	0.18	0.08	0.26					
Total ⁽¹⁶⁾	56,513	128,637	136,722	56,541	378,413	1.4	754	866	228	1,847	1.4	749	96	0.80	848	<0.01	3.7	771	227	994	NA	NA	NA	NA	NA	NA	NA	NA	NA	NA	NA	NA	NA	NA	NA					

See notes on next page.

Table 7. Summary of Groundwater Recovered, VOC Mass Recovered, and VOC Mass Recovery Rates, Groundwater Interim Remedial Measure, Operable Unit 3 (Former Grumman Settling Ponds), Bethpage, New York.

Notes:

- (1) Represents operating period between consecutive monitoring events.
- (2) Volume of groundwater recovered is based on individual local well totalized flow readings. Listed value is the difference between totalized flow values recorded between consecutive monitoring events. The total groundwater recovered during a given operating period is the sum of the individual well flow totals. Values shown are rounded to the nearest gallon, but should only be considered accurate to two significant figures to account for error associated with field measurements.
- (3) Mass recovered per well was calculated by multiplying the TVOC concentration from the most recent sampling event by the number of gallons extracted during the reporting period. The total amount recovered during a given operating period is the sum of masses recovered from each of the individual wells. Values less than ten pounds are presented using two significant figures and values greater than ten pounds have been rounded to the nearest whole number; however, these values should only be considered accurate to two significant figures to account for error associated with field measurements and analytical data.
- (4) Mass recovery rates were calculated by dividing the total mass recovered for each well and for the system by the number of days in the respective operating period. Values are presented using two significant figures.
- (5) "Total VOCs" represents the sum of individual concentrations of the VOCs detected.
- (6) "Project VOCs" represents the sum of individual compound concentrations of 1,1,1-Trichloroethane; 1,1-Dichloroethane; 1,2-Dichloroethane; 1,1-Dichloroethene; Tetrachloroethene; Trichloroethylene, Vinyl Chloride; cis-1,2-Dichloroethene; trans-1,2-Dichloroethene; Benzene; Toluene; and Xylenes-o,m, and p.
- (7) "Non-Project VOCs" represents the difference between Total VOCs and Project VOCs.
- (8) Values based on operational data recorded prior to system startup on July 21, 2009.
- (9) The volume of groundwater recovered and mass recovered calculations represent the operational period between system start-up on July 21, 2009 and December 30, 2009.
- (10) The volume of groundwater recovered and mass recovered calculations represent the operational period between December 30, 2009 and January 5, 2011.
- (11) The volume of groundwater recovered and mass recovered calculations represent the operational period between January 5, 2011 and January 9, 2012.
- (12) The volume of groundwater recovered and mass recovered calculations represent the operational period between January 9, 2012 and January 1, 2013.
- (13) Starting with the January 2013 site visit the totalized water flow readings are recorded from the SCADA HMI.
- (14) The volume of groundwater recovered and mass recovered calculations represent the operational period between January 1, 2013 and April 1, 2013.
- (15) The volume of groundwater recovered and mass recovered calculations represent the operational period between January 1, 2013 and April 1, 2013.
- (16) "Total" refers to the amounts removed by the Operable Unit 3 Groundwater Interim Remedial Measure.

Acronyms\Key:

IRM	Interim Remedial Measure.
gal	Gallons.
lbs	Pounds.
lbs/day	Pounds per day.
NA	Not applicable.
TVOC	Total volatile organic compounds.
<	Less than.

Table 8. Summary of Air Emissions Model Output, Groundwater Interim Remedial Measure, Operable Unit 3
 (Former Grumman Settling Ponds), Bethpage, New York.

Compound ⁽¹⁾	AGC ⁽²⁾ ($\mu\text{g}/\text{m}^3$)	Percent of MASC Per Event ⁽³⁾					Percent AGC ⁽⁴⁾
		4/3/12	7/5/12	10/3/2012 ⁽⁵⁾	12/3/2012 ⁽⁵⁾	02/04/13	
1,1 - Dichloroethane	0.63	0.00%	0.02%	0.00%	0.04%	0.04%	0.02%
1,1 - Dichloroethene	70	0.00%	0.00%	0.00%	0.00%	0.00%	0.00%
Acetone	30,000	0.00%	0.00%	0.00%	0.00%	0.00%	0.00%
Chloroform	0.043	0.00%	1.09%	1.40%	2.00%	1.31%	1.03%
Ethylbenzene	1,000	0.00%	0.00%	0.00%	0.00%	0.00%	0.00%
Xylenes (o)	100	0.00%	0.00%	0.00%	0.00%	0.00%	0.00%
Xylenes (m,p)	100	0.00%	0.00%	0.00%	0.00%	0.00%	0.00%
Chloromethane	90	0.00%	0.00%	0.00%	0.00%	0.00%	0.00%
Trichloroethene	0.5	0.00%	0.05%	0.10%	0.13%	0.14%	0.08%
Vinyl Chloride	0.11	1.17%	0.00%	1.11%	3.21%	8.09%	2.86%
cis 1,2 Dichloroethene	63	0.00%	0.00%	0.00%	0.01%	0.01%	0.00%
Benzene	0.13	1.53%	0.11%	0.00%	0.22%	0.13%	0.47%
Toluene	5,000	0.00%	0.00%	0.00%	0.00%	0.00%	0.00%
Trichlorofluoromethane (Freon 11)	5,000	0.00%	0.00%	0.00%	0.00%	0.00%	0.00%
Dichlorodifluoromethane (Freon 12)	12,000	0.00%	0.00%	0.00%	0.00%	0.00%	0.00%
Chlorodifluoromethane (Freon 22)	50,000	0.00%	0.00%	0.00%	0.00%	0.00%	0.00%

See notes on last page.

Table 8. Summary of Air Emissions Model Output, Groundwater Interim Remedial Measure, Operable Unit 3
(Former Grumman Settling Ponds), Bethpage, New York.

Notes:

- (1) Only VOCs that were detected in the effluent vapor sample (VSP-5) over the past year of system operation are included in this table.
- (2) AGC refers to the compound-specific annual guideline concentration per the NYSDEC DAR-1 AGC/SGC tables, revised October 18, 2010. NYSDEC DAR-1 AGCs were scaled using the results of a site-specific annual USEPA SCREEN 3 model to calculate the annual MASC per monitoring event.
- (3) Percent of AGC (or Percent MASC) was calculated by dividing the actual effluent concentration by the site-specific annual MASC. Detailed calculations are included in Appendix D.
- (4) Percent AGC is the twelve month average at the end of the reporting period. The Percent AGC was calculated by time-weighting the "Percent MASCs" for the individual sampling events over the past year. MASCs are typically calculated once per quarter, thus the MASCs for each month within a quarter are assumed to be
- (5) During the fourth quarter 2012 reporting period, additional vapor sampling was performed in December 2012 to monitor VPGAC and PPZ treatment efficiencies. For calculation purposes, each of the 4Q2012 sampling events were assumed to be representative for half the quarter (i.e. 1.5 months).

Acronyms\Key:

AGC	Annual Guideline Concentration.
DAR-1	Division of Air Resources-1.
MASC	Maximum allowable stack concentration.
NYSDEC	New York State Department of Environmental Conservation.
SGC	Short-term Guideline Concentration.
USEPA	United States Environmental Protection Agency.
VOCs	Volatile Organic Compounds.
$\mu\text{g}/\text{m}^3$	Micrograms per cubic meter.
VPGAC	Vapor Phase Granular Activated Carbon
PPZ	Potassium Permanganate Zeolite

Table 9. Concentrations of Volatile Organic Compounds in Groundwater Samples Collected from Remedial Wells, Groundwater Interim Remedial Measure, Operable Unit 3 (Former Grumman Settling Ponds), Bethpage, New York. ⁽¹⁾

COMPOUND (ug/L)	Sample Location:	RW-1	RW-1	RW-1	RW-1	RW-1	RW-1
	Sample Date:	7/29/2009	8/12/2009	9/10/2009	11/10/2009	12/2/2009	2/2/2010
NYSDEC							
<u>SCGs</u>							
1,1,1-Trichloroethane	5	< 5	< 5	< 5	< 5	< 5	< 5
1,1,2,2-Tetrachloroethane	5	< 5	< 5	< 5	< 5	< 5	< 5
1,1,2-Trichloroethane	1	< 5	< 5	< 5	< 5	< 5	< 5
1,1-Dichloroethane	5	< 5	< 5	< 5	< 5	< 5	< 5
1,1-Dichloroethene	5	< 5	< 5	< 5	< 5	< 5	< 5
1,2-Dichloroethane	0.6	< 5	< 5	< 5	< 5	< 5	< 5
1,2-Dichloropropane	1	< 5	< 5	< 5	< 5	< 5	< 5
2-Butanone	NE	6.5 J	< 50	< 50	< 50	< 50	< 50
2-Hexanone	50	< 50	< 50	< 50	< 50	< 50	< 50
4-methyl-2-pentanone	50	< 50	< 50	< 50	< 50	< 50	< 50
Acetone	NE	3.5 J	< 50	2.9 J	1.5 J	< 50	< 50
Benzene	1	< 0.7	< 0.7	< 0.7	< 0.7	< 0.7	< 0.7
Bromodichloromethane	50	< 5	< 5	< 5	< 5	< 5	< 5
Bromoform	50	< 5	< 5	< 5	< 5	< 5	< 5
Bromomethane	5	< 5	< 5	< 5	< 5	< 5 R	< 5
Carbon Disulfide	60	< 5	< 5	< 5	< 5	< 5	< 5
Carbon tetrachloride	5	< 5	< 5	< 5	< 5	< 5	< 5
Chlorobenzene	5	< 5	< 5	< 5	< 5	< 5	< 5
Chlorodifluoromethane (Freon 22)	NE	< 5	< 5	< 5	< 5	< 5	< 5
Chloroethane	5	< 5	< 5	< 5	< 5	< 5	< 5
Chloroform	7	3 J	2.4 J	1.9 J	1.4 J	1.3 J	0.8 J
Chloromethane	5	< 5	< 5	< 5	< 5	< 5 R	< 5
cis-1,2-dichloroethene	5	1.5 J	1.5 J	1.4 J	1.5 J	1.7 J	1.5 J
cis-1,3-dichloropropene	0.4	< 5	< 5	< 5	< 5	< 5	< 5
Dibromochloromethane	50	< 5	< 5	< 5	< 5	< 5	< 5
Dichlorodifluoromethane (Freon 12)	5	< 5	< 5	< 5	< 5	< 5	< 5
Ethylbenzene	5	< 5	< 5	< 5	< 5	< 5	< 5
Methyl tert-Butyl Ether	5	--	--	--	--	--	< 5
Methylene Chloride	5	< 5	< 5	< 5	< 5	< 5	< 5
Styrene	5	< 5	< 5	< 5	< 5	< 5	< 5
Tetrachloroethene	5	< 5	< 5	< 5	< 5	< 5	< 5
Toluene	5	< 5	< 5	< 5	< 5	< 5	< 5
trans-1,2-dichloroethene	5	< 5	< 5	< 5	< 5	< 5	< 5
trans-1,3-dichloropropene	0.4	< 5	< 5	< 5	< 5	< 5	< 5
Trichloroethylene	5	1.3 J	1.7 J	1.5 J	1.8 J	2 J	2 J
Trichlorofluoromethane (CFC-11)	5	--	--	--	--	--	< 5
Trichlorotrifluoroethane (Freon 113)	5	< 5	< 5	< 5	< 5	< 5	< 5
Vinyl Chloride	2	< 2	< 2	< 2	< 2	< 2	< 2
Xylene-o	5	< 5	< 5	< 5	< 5	< 5	< 5
Xylenes - m,p	5	< 5	< 5	< 5	< 5	< 5	< 5
Total VOCs ⁽²⁾		15.8	5.6	7.7	6.2	5.0	4.3
Project VOCs ⁽³⁾		2.8	3.2	2.9	3.3	3.7	3.5

See notes on last page.

Table 9. Concentrations of Volatile Organic Compounds in Groundwater Samples Collected from Remedial Wells, Groundwater Interim Remedial Measure, Operable Unit 3 (Former Grumman Settling Ponds), Bethpage, New York. ⁽¹⁾

COMPOUND (ug/L)	Sample Location: Sample Date:	RW-1 4/12/2010	RW-1 7/20/2010	RW-1 10/4/2010	RW-1 1/10/2011	RW-1 4/8/2011	RW-1 7/8/2011
NYSDEC							
<u>SCGs</u>							
1,1,1-Trichloroethane	5	< 5	< 5	< 5	< 5	< 5	< 5
1,1,2,2-Tetrachloroethane	5	< 5	< 5	< 5	< 5	< 5	< 5
1,1,2-Trichloroethane	1	< 5	< 5	< 5	< 5	< 5	< 5
1,1-Dichloroethane	5	< 5	< 5	< 5	< 5	< 5	< 5
1,1-Dichloroethene	5	< 5	< 5	< 5	< 5	< 5	< 5
1,2-Dichloroethane	0.6	< 5	< 5	< 5	< 5	< 5	< 5
1,2-Dichloropropane	1	< 5	< 5	< 5	< 5	< 5	< 5
2-Butanone	NE	< 50	< 50	< 50	< 50	< 50	< 50
2-Hexanone	50	< 50	< 50	< 50	< 50	< 50	< 50
4-methyl-2-pentanone	50	< 50	< 50	< 50	< 50	< 50	< 50
Acetone	NE	< 50	< 50	< 50	< 50	< 50	< 50
Benzene	1	< 0.7	< 0.7	< 0.7	< 0.7	< 0.7	< 0.7
Bromodichloromethane	50	< 5	< 5	< 5	< 5	< 5	< 5
Bromoform	50	< 5	< 5	< 5	< 5	< 5	< 5
Bromomethane	5	< 5	< 5	< 5	< 5	< 5	< 5
Carbon Disulfide	60	< 5	< 5	< 5	< 5	< 5	< 5
Carbon tetrachloride	5	< 5	< 5	< 5	< 5	< 5	< 5
Chlorobenzene	5	< 5	< 5	< 5	< 5	< 5	< 5
Chlorodifluoromethane (Freon 22)	NE	< 5	< 5	< 5	< 5	< 5	< 5
Chloroethane	5	< 5	< 5	< 5	< 5	< 5	< 5
Chloroform	7	0.42 J	0.36 J	0.31 J	< 5	< 5	< 5
Chloromethane	5	< 5	< 5	< 5	< 5	< 5	< 5
cis-1,2-dichloroethene	5	1.5 J	2 J	1.3 J	1.3 J	0.81 J	0.78 J
cis-1,3-dichloropropene	0.4	< 5	< 5	< 5	< 5	< 5	< 5
Dibromochloromethane	50	< 5	< 5	< 5	< 5	< 5	< 5
Dichlorodifluoromethane (Freon 12)	5	< 5	< 5	< 5	< 5	< 5	< 5
Ethylbenzene	5	< 5	< 5	< 5	< 5	< 5	< 5
Methyl tert-Butyl Ether	5	< 5	< 5	< 5	< 5	< 5	< 5
Methylene Chloride	5	< 5	< 5	< 5	< 5	< 5	< 5
Styrene	5	< 5	< 5	< 5	< 5	< 5	< 5
Tetrachloroethene	5	< 5	< 5	< 5	< 5	< 5	< 5
Toluene	5	< 5	< 5	< 5	< 5	< 5	< 5
trans-1,2-dichloroethene	5	< 5	< 5	< 5	< 5	< 5	< 5
trans-1,3-dichloropropene	0.4	< 5	< 5	< 5	< 5	< 5	< 5
Trichloroethylene	5	2.4 J	3.4 J	3 J	2.4 J	1.9 J	1.8 J
Trichlorofluoromethane (CFC-11)	5	< 5	< 5	< 5	< 5	< 5	< 5
Trichlorotrifluoroethane (Freon 113)	5	< 5	< 5	< 5	< 5	< 5	< 5
Vinyl Chloride	2	< 2	< 2	< 2	< 2	< 2	< 2
Xylene-o	5	< 5	< 5	< 5	< 5	< 5	< 5
Xylenes - m,p	5	< 5	< 5	< 5	< 5	< 5	< 5
Total VOCs ⁽²⁾		4.3	5.8	4.6	3.7	2.7	2.6
Project VOCs ⁽³⁾		3.9	5.4	4.3	3.7	2.7	2.6

See notes on last page.

Table 9. Concentrations of Volatile Organic Compounds in Groundwater Samples Collected from Remedial Wells, Groundwater Interim Remedial Measure, Operable Unit 3 (Former Grumman Settling Ponds), Bethpage, New York. ⁽¹⁾

COMPOUND (ug/L)	Sample Location: Sample Date:	RW-1 10/3/2011	RW-1 1/9/2012	RW-1 4/3/2012	RW-1 7/2/2012	RW-1 10/1/2012	RW-1 1/7/2013
NYSDEC							
<u>SCGs</u>							
1,1,1-Trichloroethane	5	< 5	< 5 U	< 5 U	< 5 U	< 5 U	< 5 U
1,1,2,2-Tetrachloroethane	5	< 5	< 5 U	< 5 U	< 5 U	< 5 U	< 5 U
1,1,2-Trichloroethane	1	< 5	< 5 U	< 5 U	< 5 U	< 5 U	< 5 U
1,1-Dichloroethane	5	< 5	< 5 U	< 5 U	< 5 U	< 5 U	< 5 U
1,1-Dichloroethene	5	< 5	< 5 U	< 5 U	< 5 U	< 5 U	< 5 U
1,2-Dichloroethane	0.6	< 5	< 5 U	< 5 U	< 5 U	< 5 U	< 5 U
1,2-Dichloropropane	1	< 5	< 5 U	< 5 U	< 5 U	< 5 U	< 5 U
2-Butanone	NE	< 50	< 50 U	< 50 U	< 50 U	< 50 U	< 50 U
2-Hexanone	50	< 50	< 50 U	< 50 U	< 50 U	< 50 U	< 50 U
4-methyl-2-pentanone	50	< 50	< 50 U	< 50 U	< 50 U	< 50 U	< 50 U
Acetone	NE	< 50	< 50 U	< 50 U	< 50 U	< 50 U	< 50 U
Benzene	1	< 0.7	< 0.7 U	< 0.7 U	< 0.7 U	< 0.7 U	< 0.7 U
Bromodichloromethane	50	< 5	< 5 U	< 5 U	< 5 U	< 5 U	< 5 U
Bromoform	50	< 5	< 5 U	< 5 U	< 5 U	< 5 U	< 5 U
Bromomethane	5	< 5	< 5 U	< 5 U	< 5 U	< 5 U	< 5 U
Carbon Disulfide	60	< 5	< 5 U	< 5 U	< 5 U	< 5 U	< 5 U
Carbon tetrachloride	5	< 5	< 5 U	< 5 U	< 5 U	< 5 U	< 5 U
Chlorobenzene	5	< 5	< 5 U	< 5 U	< 5 U	< 5 U	< 5 U
Chlorodifluoromethane (Freon 22)	NE	< 5	< 5 U	< 5 U	< 5 U	< 5 U	< 5 U
Chloroethane	5	< 5	< 5 U	< 5 U	< 5 U	< 5 U	< 5 U
Chloroform	7	< 5	0.22 J	0.21 J	0.23 J	< 5 U	< 5 U
Chloromethane	5	< 5	< 5 U	< 5 U	< 5 U	< 5 U	< 5 U
cis-1,2-dichloroethene	5	0.94 J	0.95 J	0.65 J	0.58 J	0.37 J	0.34 J
cis-1,3-dichloropropene	0.4	< 5	< 5 U	< 5 U	< 5 U	< 5 U	< 5 U
Dibromochloromethane	50	< 5	< 5 U	< 5 U	< 5 U	< 5 U	< 5 U
Dichlorodifluoromethane (Freon 12)	5	< 5	< 5 U	< 5 U	< 5 U	< 5 U	< 5 U
Ethylbenzene	5	< 5	< 5 U	< 5 U	< 5 U	< 5 U	< 5 U
Methyl tert-Butyl Ether	5	< 5	< 5 U	< 5 U	< 5 U	< 5 U	< 5 U
Methylene Chloride	5	< 5	< 5 U	< 5 U	< 5 U	< 5 U	< 5 U
Styrene	5	< 5	< 5 U	< 5 U	< 5 U	< 5 U	< 5 U
Tetrachloroethene	5	< 5	< 5 U	< 5 U	< 5 U	< 5 U	< 5 U
Toluene	5	< 5	< 5 U	< 5 U	< 5 U	< 5 U	< 5 U
trans-1,2-dichloroethene	5	< 5	< 5 U	< 5 U	< 5 U	< 5 U	< 5 U
trans-1,3-dichloropropene	0.4	< 5	< 5 U	< 5 U	< 5 U	< 5 U	< 5 U
Trichloroethylene	5	1.8 J	1.8 J	1.7 J	1.4 J	0.95 J	0.86 J
Trichlorofluoromethane (CFC-11)	5	< 5	< 5 U	< 5 U	< 5 U	< 5 U	< 5 U
Trichlorotrifluoroethane (Freon 113)	5	< 5	< 5 U	< 5 U	< 5 U	< 5 U	< 5 U
Vinyl Chloride	2	< 2	< 2 U	< 2 U	< 2 U	< 2 U	< 2 U
Xylene-o	5	< 5	< 5 U	< 5 U	< 5 U	< 5 U	< 5 U
Xylenes - m,p	5	< 5	< 5 U	< 5 U	< 5 U	< 5 U	< 5 U
Total VOCs ⁽²⁾		2.7	3.0	2.6	2.2	1.3	1.2
Project VOCs ⁽³⁾		2.7	2.8	2.4	2.0	1.3	1.2

See notes on last page.

Table 9. Concentrations of Volatile Organic Compounds in Groundwater Samples Collected from Remedial Wells, Groundwater Interim Remedial Measure, Operable Unit 3 (Former Grumman Settling Ponds), Bethpage, New York. ⁽¹⁾

COMPOUND (ug/L)	Sample Location:	RW-2	RW-2	RW-2	RW-2	RW-2	RW-2
	Sample Date:	7/29/2009	8/12/2009	9/10/2009	11/10/2009	12/2/2009	2/2/2010
NYSDEC							
SCGs							
1,1,1-Trichloroethane	5	< 100	< 100	< 50	< 25	< 25	< 25
1,1,2,2-Tetrachloroethane	5	< 100	< 100	< 50	< 25	< 25	< 25
1,1,2-Trichloroethane	1	< 100	< 100	< 50	< 25	< 25	< 25
1,1-Dichloroethane	5	9.2 J	8.8 J	6.4 J	5.2 J	5.3 J	3.5 J
1,1-Dichloroethene	5	< 100	< 100	< 50	2.9 J	3.1 J	< 25
1,2-Dichloroethane	0.6	< 100	< 100	< 50	< 25	< 25	< 25
1,2-Dichloropropane	1	< 100	< 100	< 50	< 25	< 25	< 25
2-Butanone	NE	< 1000	< 1000	< 500	< 250	< 250	< 250
2-Hexanone	50	< 1000	< 1000	< 500	< 250	< 250	< 250
4-methyl-2-pentanone	50	< 1000	< 1000	< 500	< 250	< 250	< 250
Acetone	NE	< 1000	< 1000	< 500	< 250	< 250	< 250
Benzene	1	< 14	< 14	< 7	< 3.5	< 3.5	< 3.5
Bromodichloromethane	50	< 100	< 100	< 50	< 25	< 25	< 25
Bromoform	50	< 100	< 100	< 50	< 25	< 25	< 25
Bromomethane	5	< 100	< 100	< 50	< 25	< 25 R	< 25
Carbon Disulfide	60	< 100	< 100	< 50	< 25	< 25	< 25
Carbon tetrachloride	5	< 100	< 100	< 50	< 25	< 25	< 25
Chlorobenzene	5	< 100	< 100	< 50	< 25	< 25	< 25
Chlorodifluoromethane (Freon 22)	NE	< 100	< 100	4 J	3.5 J	3.3 J	< 25
Chloroethane	5	< 100	< 100	< 50	< 25	< 25	< 25
Chloroform	7	< 100	< 100	3.4 J	3 J	2.3 J	2 J
Chloromethane	5	< 100	< 100	< 50	< 25	< 25 R	< 25
cis-1,2-dichloroethene	5	2,600	2,300	1,300	930	880	590
cis-1,3-dichloropropene	0.4	< 100	< 100	< 50	< 25	< 25	< 25
Dibromochloromethane	50	< 100	< 100	< 50	< 25	< 25	< 25
Dichlorodifluoromethane (Freon 12)	5	< 100	< 100	< 50	< 25	< 25	< 25
Ethylbenzene	5	13 J	7.2 J	4.8 J	6.4 J	5.1 J	1.8 J
Methyl tert-Butyl Ether	5	--	--	--	--	--	< 25
Methylene Chloride	5	< 100	< 100	< 50	< 25	< 25	< 25
Styrene	5	< 100	< 100	< 50	< 25	< 25	< 25
Tetrachloroethene	5	< 100	< 100	< 50	< 25	< 25	< 25
Toluene	5	520	170	190	200	150	49
trans-1,2-dichloroethene	5	12 J	21 J	32 J	6.2 J	2.1 J	49
trans-1,3-dichloropropene	0.4	< 100	< 100	< 50	< 25	< 25	< 25
Trichloroethylene	5	46 J	30 J	52	59	63	46
Trichlorofluoromethane (CFC-11)	5	--	--	--	--	--	< 25
Trichlorotrifluoroethane (Freon 113)	5	< 100	< 100	< 50	< 25	< 25	< 25
Vinyl Chloride	2	630	670	370	210	210	83
Xylene-o	5	14 J	9.4 J	5.4 J	6 J	4.9 J	< 25
Xylenes - m,p	5	27 J	9.2 J	7.9 J	11 J	9 J	< 25
Total VOCs ⁽²⁾		3,871	3,226	1,976	1,443	1,338	824
Project VOCs ⁽³⁾		3,849	3,210	1,957	1,430	1,327	821

See notes on last page.

Table 9. Concentrations of Volatile Organic Compounds in Groundwater Samples Collected from Remedial Wells, Groundwater Interim Remedial Measure, Operable Unit 3 (Former Grumman Settling Ponds), Bethpage, New York. ⁽¹⁾

COMPOUND (ug/L)	Sample Location: Sample Date:	RW-2 4/12/2010	RW-2 7/20/2010	RW-2 10/4/2010	RW-2 1/10/2011	RW-2 6/8/2011	RW-2 7/8/2011
NYSDEC							
<u>SCGs</u>							
1,1,1-Trichloroethane	5	< 13	< 13	< 13	0.78 J	1.1 J	0.93 J
1,1,2,2-Tetrachloroethane	5	< 13	< 13	< 13	< 13	< 5	< 13
1,1,2-Trichloroethane	1	< 13	< 13	< 13	< 13	< 5	< 13
1,1-Dichloroethane	5	3.2 J	2.3 J	2.2 J	3.5 J	3.1 J	2.4 J
1,1-Dichloroethene	5	3 J	2.1 J	2.2 J	4.9 J	2.8 J	2.7 J
1,2-Dichloroethane	0.6	< 13	< 13	< 13	< 13	< 5	< 13
1,2-Dichloropropane	1	< 13	< 13	< 13	< 13	0.38 J	< 13
2-Butanone	NE	< 130	< 130	< 130	< 130	< 50	< 130
2-Hexanone	50	< 130	< 130	< 130	< 130	< 50	< 130
4-methyl-2-pentanone	50	< 130	< 130	< 130	< 130	< 50	< 130
Acetone	NE	< 130	< 130	< 130 B	< 130 B	< 50	< 130
Benzene	1	< 1.8	< 1.8	< 1.8	< 1.8	< 0.7	< 1.8
Bromodichloromethane	50	< 13	< 13	< 13	< 13	< 5	< 13
Bromoform	50	< 13	< 13	< 13	< 13	< 5	< 13
Bromomethane	5	< 13	< 13	< 13	< 13	< 5	< 13
Carbon Disulfide	60	< 13	< 13	< 13	< 13	< 5	< 13
Carbon tetrachloride	5	< 13	< 13	< 13	< 13	< 5	< 13
Chlorobenzene	5	< 13	< 13	< 13	< 13	< 5	< 13
Chlorodifluoromethane (Freon 22)	NE	1.7 J	1.1 J	1 J	1.4 J	0.98 J	1.3 J
Chloroethane	5	< 13	< 13	< 13	< 13	< 5	< 13
Chloroform	7	1.5 J	1.4 J	1.9 J	1.9 J	1.3 J	1.3 J
Chloromethane	5	< 13	< 13	< 13	< 13	< 5	< 13
cis-1,2-dichloroethene	5	480	310	270	460	300 D	320
cis-1,3-dichloropropene	0.4	< 13	< 13	< 13	< 13	< 5	< 13
Dibromochloromethane	50	< 13	< 13	< 13	< 13	< 5	< 13
Dichlorodifluoromethane (Freon 12)	5	< 13	< 13	< 13	< 13	< 5	< 13
Ethylbenzene	5	2.2 J	1.7 J	1.5 J	2.6 J	1.7 J	2.4 J
Methyl tert-Butyl Ether	5	< 13	< 13	< 13	< 13	< 5	< 13
Methylene Chloride	5	< 13	< 13	< 13	< 13	< 5	< 13
Styrene	5	< 13	< 13	< 13	< 13	< 5	< 13
Tetrachloroethene	5	< 13	< 13	< 13	< 13	0.43 J	< 13
Toluene	5	71	35	25	62	62	81
trans-1,2-dichloroethene	5	< 13	0.95 J	< 13	< 13	0.42 J	< 13
trans-1,3-dichloropropene	0.4	< 13	< 13	< 13	< 13	< 5	< 13
Trichloroethylene	5	43	35	36	51	30	25
Trichlorofluoromethane (CFC-11)	5	< 13	< 13	< 13	< 13	< 5 U	< 13
Trichlorotrifluoroethane (Freon 113)	5	< 13	< 13	< 13	< 13	< 5	< 13
Vinyl Chloride	2	94	54	45	87	88	67
Xylene-o	5	2.2 J	1.3 J	0.9 J	2.6 J	2.6 J	2.6 J
Xylenes - m,p	5	3.5 J	2.4 J	1.9 J	3.8 J	4.5 J	4.6 J
Total VOCs ⁽²⁾		705	447	388	681	499	511
Project VOCs ⁽³⁾		699	443	383	676	495	506

See notes on last page.

Table 9. Concentrations of Volatile Organic Compounds in Groundwater Samples Collected from Remedial Wells, Groundwater Interim Remedial Measure, Operable Unit 3 (Former Grumman Settling Ponds), Bethpage, New York. ⁽¹⁾

COMPOUND (ug/L)	Sample Location: Sample Date:	RW-2 10/3/2011	RW-2 1/9/2012	RW-2 4/3/2012	RW-2 (dup.) 4/3/2012	RW-2 7/2/2012	RW-2 10/1/2012	RW-2 1/7/2013
NYSDEC								
<u>SCGs</u>								
1,1,1-Trichloroethane	5	0.73 J	< 13 U	0.52 J	< 10 U	0.46 J	0.51 J	0.41 J
1,1,2,2-Tetrachloroethane	5	< 13 U	< 13 U	< 10 U	< 10 U	< 5 U	< 5 U	< 5 U
1,1,2-Trichloroethane	1	< 13 U	< 13 U	< 10 U	< 10 U	< 5 U	< 5 U	< 5 U
1,1-Dichloroethane	5	2.0 J	1.7 J	1.4 J	1.6 J	1.5 J	1.6 J	1.6 J
1,1-Dichloroethene	5	1.7 J	0.98 J	0.92 J	0.84 J	1.2 J	1 J	0.82 J
1,2-Dichloroethane	0.6	< 13 U	< 13 U	< 10 U	< 10 U	< 5 U	< 5 U	< 5 U
1,2-Dichloropropane	1	< 13 U	< 13 U	< 10 U	< 10 U	< 5 U	0.28 J	< 5 U
2-Butanone	NE	< 130 U	< 130 U	< 100 U	< 100 U	< 50 U	< 50 U	< 50 U
2-Hexanone	50	< 130 U	< 130 U	< 100 U	< 100 U	< 50 U	< 50 U	< 50 U
4-methyl-2-pentanone	50	< 130 U	< 130 U	< 100 U	< 100 U	< 50 U	< 50 U	< 50 U
Acetone	NE	< 130 UB	3.4 J	< 100 U	1.5 J	< 50 U	< 50 U	< 50 U
Benzene	1	< 1.8 U	< 1.8 U	< 1.4 U	< 1.4 U	< 0.7 U	< 0.7 U	< 0.7 U
Bromodichloromethane	50	< 13 U	< 13 U	< 10 U	< 10 U	< 5 U	< 5 U	< 5 U
Bromoform	50	< 13 U	< 13 U	< 10 U	< 10 U	< 5 U	< 5 U	< 5 U
Bromomethane	5	< 13 U	< 13 U	< 10 U	< 10 U	< 5 U	< 5 U	< 5 U
Carbon Disulfide	60	< 13 U	< 13 U	< 10 U	< 10 U	< 5 U	< 5 U	< 5 U
Carbon tetrachloride	5	< 13 U	< 13 U	< 10 U	< 10 U	< 5 U	< 5 U	< 5 U
Chlorobenzene	5	< 13 U	< 13 U	< 10 U	< 10 U	0.22 J	< 5 U	< 5 U
Chlorodifluoromethane (Freon 22)	NE	0.60 J	0.95 J	0.64 J	0.48 J	0.44 J	0.4 J	0.33 J
Chloroethane	5	< 13 U	< 13 U	< 10 U	< 10 U	< 5 U	< 5 U	< 5 U
Chloroform	7	1.1 J	1.4 J	1 J	1.1 J	1.4 J	1.9 J	2.1 J
Chloromethane	5	< 13 U	< 13 U	< 10 U	< 10 U	< 5 U	< 5 U	< 5 U
cis-1,2-dichloroethene	5	280	260	220	220	200	200	160
cis-1,3-dichloropropene	0.4	< 13 U	< 13 U	< 10 U	< 10 U	< 5 U	< 5 U	< 5 U
Dibromochloromethane	50	< 13 U	< 13 U	< 10 U	< 10 U	< 5 U	< 5 U	< 5 U
Dichlorodifluoromethane (Freon 12)	5	< 13 U	< 13 U	< 10 U	< 10 U	< 5 U	< 5 U	< 5 U
Ethylbenzene	5	2.5 J	2.4 J	1.5 J	1.6 J	2.8 J	3.3 J	2.3 J
Methyl tert-Butyl Ether	5	< 13 U	< 13 U	< 10 U	< 10 U	< 5 U	< 5 U	< 5 U
Methylene Chloride	5	< 13 U	< 13 U	< 10 U	< 10 U	< 5 U	< 5 U	< 5 U
Styrene	5	< 13 U	< 13 U	< 10 U	< 10 U	< 5 U	< 5 U	< 5 U
Tetrachloroethene	5	0.58 J	< 13 U	< 10 U	< 10 U	0.4 J	0.36 J	0.38 J
Toluene	5	72	81	60	61	73	96	82
trans-1,2-dichloroethene	5	0.63 J	< 13 U	0.46 J	< 10 U	0.87 J	0.26 J	< 5 U
trans-1,3-dichloropropene	0.4	< 13 U	< 13 U	< 10 U	< 10 U	< 5 U	< 5 U	< 5 U
Trichloroethylene	5	25	23	18	18	20	20	18
Trichlorofluoromethane (CFC-11)	5	< 13 U	< 13 U	< 10 U	< 10 U	< 5 U	< 5 U	< 5 U
Trichlorotrifluoroethane (Freon 113)	5	< 13 U	< 13 U	< 10 U	< 10 U	< 5 U	< 5 U	< 5 U
Vinyl Chloride	2	55	59	54	54	44	61	75
Xylene-o	5	2.6 J	2.6 J	2.2 J	2.3 J	2.6 J	2.7 J	3.2 J
Xylenes - m,p	5	4.2 J	4.7 J	3.6 J	4.1 J	4.5 J	5.8	5.3
Total VOCs ⁽²⁾		449	441	364	367	353	395	351
Project VOCs ⁽³⁾		444	433	361	362	349	374	347

See notes on last page.

Table 9. Concentrations of Volatile Organic Compounds in Groundwater Samples Collected from Remedial Wells, Groundwater Interim Remedial Measure, Operable Unit 3 (Former Grumman Settling Ponds), Bethpage, New York. ⁽¹⁾

COMPOUND (ug/L)	Sample Location: Sample Date:	RW-3 7/29/2009	RW-3 8/12/2009	RW-3 9/10/2009	RW-3 11/10/2009	RW-3 12/2/2009	RW-3 2/2/2010
NYSDEC							
<u>SCGs</u>							
1,1,1-Trichloroethane	5	< 5	< 5	< 5	< 5	< 13	< 25
1,1,2,2-Tetrachloroethane	5	< 5	< 5	< 5	< 5	< 13	< 25
1,1,2-Trichloroethane	1	< 5	< 5	< 5	< 5	< 13	< 25
1,1-Dichloroethane	5	2.4 J	2.1 J	1.9 J	1.4 J	1.3 J	< 25
1,1-Dichloroethene	5	< 5	0.35 J	0.41 J	0.53 J	< 13	< 25
1,2-Dichloroethane	0.6	< 5	< 5	< 5	< 5	< 13	< 25
1,2-Dichloropropane	1	< 5	< 5	< 5	< 5	< 13	< 25
2-Butanone	NE	< 50	< 50	< 50	< 50	< 130	< 250
2-Hexanone	50	< 50	< 50	< 50	< 50	< 130	< 250
4-methyl-2-pentanone	50	< 50	< 50	< 50	< 50	< 130	< 250
Acetone	NE	< 50	< 50	2 J	3.1 J	< 130	< 250
Benzene	1	< 0.7	< 0.7	< 0.7	< 0.7	< 1.8	< 3.5
Bromodichloromethane	50	0.35 J	< 5	< 5	< 5	< 13	< 25
Bromoform	50	< 5	< 5	< 5	< 5	< 13	< 25
Bromomethane	5	< 5	< 5	< 5	< 5	< 13	< 25
Carbon Disulfide	60	< 5	< 5	< 5	< 5	< 13	< 25
Carbon tetrachloride	5	< 5	< 5	< 5	< 5	< 13	< 25
Chlorobenzene	5	< 5	< 5	< 5	< 5	< 13	< 25
Chlorodifluoromethane (Freon 22)	NE	2.1 J	8.5	93	490 D	660 D	1,300 D
Chloroethane	5	< 5	< 5	< 5	< 5	< 13	< 25
Chloroform	7	2.1 J	2.3 J	2.9 J	5.9	6 J	4.3 J
Chloromethane	5	< 5	< 5	< 5	< 5	< 13 R	< 25
cis-1,2-dichloroethene	5	130	120	130	85	72	68
cis-1,3-dichloropropene	0.4	< 5	< 5	< 5	< 5	< 13	< 25
Dibromochloromethane	50	< 5	< 5	< 5	< 5	< 13	< 25
Dichlorodifluoromethane (Freon 12)	5	< 5	< 5	< 5	< 5	< 13	< 25
Ethylbenzene	5	< 5	< 5	< 5	< 5	< 13	< 25
Methyl tert-Butyl Ether	5	--	--	--	--	--	< 25
Methylene Chloride	5	< 5	< 5	< 5	< 5	< 13	< 25
Styrene	5	< 5	< 5	< 5	< 5	< 13	< 25
Tetrachloroethene	5	0.81 J	0.56 J	0.83 J	0.54 J	< 13	< 25
Toluene	5	< 5	< 5	< 5	< 5	< 13	< 25
trans-1,2-dichloroethene	5	0.68 J	0.54 J	0.59 J	0.52 J	< 13	7.2 J
trans-1,3-dichloropropene	0.4	< 5	< 5	< 5	< 5	< 13	< 25
Trichloroethylene	5	37	34	29	24	22	19 J
Trichlorofluoromethane (CFC-11)	5	--	--	--	--	--	< 25
Trichlorotrifluoroethane (Freon 113)	5	< 5	< 5	< 5	< 5	< 13	< 25
Vinyl Chloride	2	< 2	< 2	0.47 J	0.42 J	< 5	< 10
Xylene-o	5	< 5	< 5	< 5	< 5	< 13	< 25
Xylenes - m,p	5	< 5	< 5	< 5	< 5	< 13	< 25
Total VOCs ⁽²⁾		175	168	261	611	761	1,399
Project VOCs ⁽³⁾		171	158	163	112	95	94

See notes on last page.

Table 9. Concentrations of Volatile Organic Compounds in Groundwater Samples Collected from Remedial Wells, Groundwater Interim Remedial Measure, Operable Unit 3 (Former Grumman Settling Ponds), Bethpage, New York. ⁽¹⁾

COMPOUND (ug/L)	Sample Location: Sample Date:	RW-3 4/12/2010	RW-3 7/20/2010	RW-3 10/4/2010	RW-3 1/10/2011	RW-3 4/8/2011	RW-3 7/8/2011
NYSDEC							
<u>SCGs</u>							
1,1,1-Trichloroethane	5	< 25	< 50	< 25	< 25	< 25	< 25
1,1,2,2-Tetrachloroethane	5	< 25	< 50	< 25	< 25	< 25	< 25
1,1,2-Trichloroethane	1	< 25	< 50	< 25	< 25	< 25	< 25
1,1-Dichloroethane	5	< 25	< 50	< 25	< 25	< 25	< 25
1,1-Dichloroethene	5	< 25	< 50	< 25	< 25	< 25	< 25
1,2-Dichloroethane	0.6	< 25	< 50	< 25	< 25	< 25	< 25
1,2-Dichloropropane	1	< 25	< 50	< 25	< 25	< 25	< 25
2-Butanone	NE	< 250	< 500	< 250	< 250	< 250	< 250
2-Hexanone	50	< 250	< 500	< 250	< 250	< 250	< 250
4-methyl-2-pentanone	50	< 250	< 500	< 250	< 250	< 250	< 250
Acetone	NE	< 250	< 500	< 250	< 250 B	< 250	< 250
Benzene	1	< 3.5	< 7	< 3.5	< 3.5	< 3.5	< 3.5
Bromodichloromethane	50	< 25	< 50	< 25	< 25	< 25	< 25
Bromoform	50	< 25	< 50	< 25	< 25	< 25	< 25
Bromomethane	5	< 25	< 50	< 25	< 25	< 25	< 25
Carbon Disulfide	60	< 25	< 50	< 25	< 25	< 25	< 25
Carbon tetrachloride	5	< 25	< 50	< 25	< 25	< 25	< 25
Chlorobenzene	5	< 25	< 50	< 25	< 25	< 25	< 25
Chlorodifluoromethane (Freon 22)	NE	1,300 D	1400	880	890	900	670
Chloroethane	5	< 25	< 50	< 25	< 25	< 25	< 25
Chloroform	7	3.2 J	< 50	6.6 J	5.8 J	4.0 J	2.5 J
Chloromethane	5	< 25	< 50	< 25	< 25	< 25	< 25
cis-1,2-dichloroethene	5	70	64	64	74	93	110
cis-1,3-dichloropropene	0.4	< 25	< 50	< 25	< 25	< 25	< 25
Dibromochloromethane	50	< 25	< 50	< 25	< 25	< 25	< 25
Dichlorodifluoromethane (Freon 12)	5	< 25	< 50	< 25	< 25	< 25	< 25
Ethylbenzene	5	< 25	< 50	< 25	< 25	< 25	< 25
Methyl tert-Butyl Ether	5	< 25	< 50	< 25	< 25	< 25	< 25
Methylene Chloride	5	< 25	< 50	< 25	< 25	< 25	< 25
Styrene	5	< 25	< 50	< 25	< 25	< 25	< 25
Tetrachloroethene	5	< 25	< 50	< 25	< 25	< 25	< 25
Toluene	5	< 25	< 50	< 25	< 25	< 25	< 25
trans-1,2-dichloroethene	5	< 25	4.8 J	6.7 J	3.9 J	6.5 J	< 25
trans-1,3-dichloropropene	0.4	< 25	< 50	< 25	< 25	< 25	< 25
Trichloroethylene	5	17 J	14 J	12 J	10 J	6.8 J	7.7 J
Trichlorofluoromethane (CFC-11)	5	< 25	< 50	< 25	< 25	< 25	< 25
Trichlorotrifluoroethane (Freon 113)	5	< 25	< 50	< 25	< 25	< 25	< 25
Vinyl Chloride	2	< 10	< 20	2.6 J	5.1 J	11	9.9 J
Xylene-o	5	< 25	< 50	< 25	< 25	< 25	< 25
Xylenes - m,p	5	< 25	< 50	< 25	< 25	< 25	< 25
Total VOCs ⁽²⁾		1,390	1,483	972	989	1,021	800
Project VOCs ⁽³⁾		87	83	85	93	117	128

See notes on last page.

Table 9. Concentrations of Volatile Organic Compounds in Groundwater Samples Collected from Remedial Wells, Groundwater Interim Remedial Measure, Operable Unit 3 (Former Grumman Settling Ponds), Bethpage, New York. ⁽¹⁾

COMPOUND (ug/L)	Sample Location: Sample Date:	RW-3 10/3/2011	RW-3 1/9/2012	RW-3 4/3/2012	RW-3 7/2/2012	RW-3 10/1/2012	RW-3 1/7/2013
NYSDEC							
SCGs							
1,1,1-Trichloroethane	5	< 25 U	< 13 U	< 13 U	< 10 U	< 10 U	< 5 U
1,1,2,2-Tetrachloroethane	5	< 25 U	< 13 U	< 13 U	< 10 U	< 10 U	< 5 U
1,1,2-Trichloroethane	1	< 25 U	< 13 U	< 13 U	< 10 U	< 10 U	< 5 U
1,1-Dichloroethane	5	< 25 U	< 13 U	< 13 U	< 10 U	< 10 U	0.21 J
1,1-Dichloroethene	5	< 25 U	< 13 U	< 13 U	< 10 U	< 10 U	< 5 U
1,2-Dichloroethane	0.6	< 25 U	< 13 U	< 13 U	< 10 U	< 10 U	< 5 U
1,2-Dichloropropane	1	< 25 U	< 13 U	< 13 U	< 10 U	< 10 U	< 5 U
2-Butanone	NE	< 250 U	< 130 U	< 130 U	< 100 U	< 100 U	< 50 U
2-Hexanone	50	< 250 U	< 130 U	< 130 U	< 100 U	< 100 U	< 50 U
4-methyl-2-pentanone	50	< 250 U	< 130 U	< 130 U	< 100 U	< 100 U	< 50 U
Acetone	NE	< 250 U	< 130 U	< 130 U	< 100 UB	< 100 U	< 50 U
Benzene	1	< 3.5 U	< 1.8 U	< 1.8 U	< 1.4 U	< 1.4 U	< 0.7 U
Bromodichloromethane	50	< 25 U	< 13 U	< 13 U	< 10 U	< 10 U	< 5 U
Bromoform	50	< 25 U	< 13 U	< 13 U	< 10 U	< 10 U	< 5 U
Bromomethane	5	< 25 U	< 13 U	< 13 U	< 10 U	< 10 U	< 5 U
Carbon Disulfide	60	< 25 U	< 13 U	< 13 U	< 10 U	< 10 U	< 5 U
Carbon tetrachloride	5	< 25 U	< 13 U	< 13 U	< 10 U	< 10 U	< 5 U
Chlorobenzene	5	< 25 U	< 13 U	< 13 U	< 10 U	< 10 U	< 5 U
Chlorodifluoromethane (Freon 22)	NE	540	390	460	270	230	190
Chloroethane	5	< 25 U	< 13 U	< 13 U	< 10 U	< 10 U	< 5 U
Chloroform	7	5.5 J	6.9 J	3.4 J	2.9 J	5.3 J	4.9 J
Chloromethane	5	< 25 U	< 13 U	< 13 U	< 10 U	< 10 U	< 5 U
cis-1,2-dichloroethene	5	92	55	33	22	17	12
cis-1,3-dichloropropene	0.4	< 25 U	< 13 U	< 13 U	< 10 U	< 10 U	< 5 U
Dibromochloromethane	50	< 25 U	< 13 U	< 13 U	< 10 U	< 10 U	< 5 U
Dichlorodifluoromethane (Freon 12)	5	< 25 U	< 13 U	< 13 U	< 10 U	< 10 U	< 5 U
Ethylbenzene	5	< 25 U	< 13 U	< 13 U	< 10 U	< 10 U	< 5 U
Methyl tert-Butyl Ether	5	< 25 U	< 13 U	< 13 U	< 10 U	< 10 U	< 5 U
Methylene Chloride	5	< 25 U	< 13 U	< 13 U	< 10 U	< 10 U	< 5 U
Styrene	5	< 25 U	< 13 U	< 13 U	< 10 U	< 10 U	< 5 U
Tetrachloroethene	5	< 25 U	< 13 U	< 13 U	< 10 U	< 10 U	0.33 J
Toluene	5	< 25 U	< 13 U	< 13 U	< 10 U	< 10 U	< 5 U
trans-1,2-dichloroethene	5	1.8 J	< 13 U	< 13 U	< 10 U	< 10 U	< 5 U
trans-1,3-dichloropropene	0.4	< 25 U	< 13 U	< 13 U	< 10 U	< 10 U	< 5 U
Trichloroethylene	5	7.5 J	6.7 J	6 J	6.5 J	5.3 J	5.1
Trichlorofluoromethane (CFC-11)	5	< 25 U	< 13 U	< 13 U	< 10 U	< 10 U	< 5 U
Trichlorotrifluoroethane (Freon 113)	5	< 25 U	< 13 U	< 13 U	< 10 U	< 10 U	< 5 U
Vinyl Chloride	2	7.1 J	2.8 J	1.2 J	0.8 J	0.48 J	0.25 J
Xylene-o	5	< 25 U	< 13 U	< 13 U	< 10 U	< 10 U	< 5 U
Xylenes - m,p	5	< 25 U	< 13 U	< 13 U	< 10 U	< 10 U	< 5 U
Total VOCs ⁽²⁾		654	461	504	302	258	213
Project VOCs ⁽³⁾		108	65	40	29	23	18

See notes on last page.

Table 9. Concentrations of Volatile Organic Compounds in Groundwater Samples Collected from Remedial Wells, Groundwater Interim Remedial Measure, Operable Unit 3 (Former Grumman Settling Ponds), Bethpage, New York. ⁽¹⁾

COMPOUND (ug/L)	Sample Location: Sample Date:	RW-4 7/29/2009	RW-4 8/12/2009	RW-4 9/10/2009	RW-4 11/10/2009	RW-4 12/2/2009	RW-4 2/2/2010
	NYSDEC						
	<u>SCGs</u>						
1,1,1-Trichloroethane	5	< 5	< 5	< 5	< 5	< 10	< 10
1,1,2,2-Tetrachloroethane	5	< 5	< 5	< 5	< 5	< 10	< 10
1,1,2-Trichloroethane	1	< 5	< 5	< 5	< 5	< 10	< 10
1,1-Dichloroethane	5	0.42 J	0.38 J	0.47 J	0.52 J	< 10	0.6 J
1,1-Dichloroethene	5	< 5	< 5	< 5	< 5	< 10	< 10
1,2-Dichloroethane	0.6	< 5	< 5	< 5	< 5	< 10	< 10
1,2-Dichloropropane	1	< 5	< 5	< 5	< 5	< 10	< 10
2-Butanone	NE	< 50	< 50	< 50	< 50	< 100	< 100
2-Hexanone	50	< 50	< 50	< 50	< 50	< 100	< 100
4-methyl-2-pentanone	50	< 50	< 50	< 50	< 50	< 100	< 100
Acetone	NE	< 50	< 50	< 50	3.5 J	< 100	< 100
Benzene	1	< 0.7	< 0.7	< 0.7	< 0.7	< 1.4	< 1.4
Bromodichloromethane	50	< 5	< 5	< 5	< 5	< 10	< 10
Bromoform	50	< 5	< 5	< 5	< 5	< 10	< 10
Bromomethane	5	< 5	< 5	< 5	< 5	< 10 R	< 10
Carbon Disulfide	60	< 5	< 5	< 5	< 5	< 10	< 10
Carbon tetrachloride	5	< 5	< 5	< 5	< 5	< 10	< 10
Chlorobenzene	5	< 5	< 5	< 5	< 5	< 10	< 10
Chlorodifluoromethane (Freon 22)	NE	140	200	330 D	230 D	290	440 D
Chloroethane	5	< 5	< 5	< 5	< 5	< 10	< 10
Chloroform	7	1 J	0.88 J	0.78 J	0.95 J	0.88 J	0.72 J
Chloromethane	5	< 5	< 5	< 5	< 5	< 10 R	< 10
cis-1,2-dichloroethene	5	1.5 J	1.7 J	1.9 J	1.9 J	2.2 J	1.8 J
cis-1,3-dichloropropene	0.4	< 5	< 5	< 5	< 5	< 10	< 10
Dibromochloromethane	50	< 5	< 5	< 5	< 5	< 10	< 10
Dichlorodifluoromethane (Freon 12)	5	< 5	< 5	< 5	< 5	< 10	< 10
Ethylbenzene	5	< 5	< 5	< 5	< 5	< 10	< 10
Methyl tert-Butyl Ether	5	--	--	--	--	--	< 10
Methylene Chloride	5	< 5	< 5	< 5	< 5	< 10	< 10
Styrene	5	< 5	< 5	< 5	< 5	< 10	< 10
Tetrachloroethene	5	0.44 J	0.44 J	0.44 J	0.48 J	< 10	0.64 J
Toluene	5	< 5	< 5	< 5	< 5	< 10	< 10
trans-1,2-dichloroethene	5	< 5	< 5	< 5	< 5	< 10	< 10
trans-1,3-dichloropropene	0.4	< 5	< 5	< 5	< 5	< 10	< 10
Trichloroethylene	5	1.1 J	1.2 J	1.6 J	1.9 J	1.8 J	1.4 J
Trichlorofluoromethane (CFC-11)	5	--	--	--	--	--	< 10
Trichlorotrifluoroethane (Freon 113)	5	< 5	< 5	< 5	< 5	< 10	< 10
Vinyl Chloride	2	< 2	< 2	< 2	< 2	< 4	< 4
Xylene-o	5	< 5	< 5	< 5	< 5	< 10	< 10
Xylenes - m,p	5	< 5	< 5	< 5	< 5	< 10	< 10
Total VOCs ⁽²⁾		144	205	335	239	295	445
Project VOCs ⁽³⁾		3.5	3.7	4.4	4.8	4.0	4.4

See notes on last page.

Table 9. Concentrations of Volatile Organic Compounds in Groundwater Samples Collected from Remedial Wells, Groundwater Interim Remedial Measure, Operable Unit 3 (Former Grumman Settling Ponds), Bethpage, New York. ⁽¹⁾

COMPOUND (ug/L)	Sample Location: Sample Date:	RW-4 4/12/2010	RW-4 7/20/2010	RW-4 10/4/2010	RW-4 1/10/2011	RW-4 4/8/2011	RW-4 7/8/2011
NYSDEC							
<u>SCGs</u>							
1,1,1-Trichloroethane	5	< 13	< 25	< 25	< 25	< 25	< 25
1,1,2,2-Tetrachloroethane	5	< 13	< 25	< 25	< 25	< 25	< 25
1,1,2-Trichloroethane	1	< 13	< 25	< 25	< 25	< 25	< 25
1,1-Dichloroethane	5	< 13	< 25	< 25	< 25	< 25	< 25
1,1-Dichloroethene	5	< 13	< 25	< 25	< 25	< 25	< 25
1,2-Dichloroethane	0.6	< 13	< 25	< 25	< 25	< 25	< 25
1,2-Dichloropropane	1	< 13	< 25	< 25	< 25	< 25	< 25
2-Butanone	NE	< 130	< 250	< 250	< 250	< 250	< 250
2-Hexanone	50	< 130	< 250	< 250	< 250	< 250	< 250
4-methyl-2-pentanone	50	< 130	< 250	< 250	< 250	< 250	< 250
Acetone	NE	< 130	< 250	< 250	< 250	< 250	< 250
Benzene	1	< 1.8	< 3.5	< 3.5	< 3.5	< 3.5	< 3.5
Bromodichloromethane	50	< 13	< 25	< 25	< 25	< 25	< 25
Bromoform	50	< 13	< 25	< 25	< 25	< 25	< 25
Bromomethane	5	< 13	< 25	< 25	< 25	< 25	< 25
Carbon Disulfide	60	< 13	< 25	< 25	< 25	< 25	< 25
Carbon tetrachloride	5	< 13	< 25	< 25	< 25	< 25	< 25
Chlorobenzene	5	< 13	< 25	< 25	< 25	< 25	< 25
Chlorodifluoromethane (Freon 22)	NE	560 D	840	850	820	650	520
Chloroethane	5	< 13	< 25	< 25	< 25	< 25	< 25
Chloroform	7	0.8 J	< 25	< 25	< 25	< 25	< 25
Chloromethane	5	< 13	< 25	< 25	< 25	< 25	< 25
cis-1,2-dichloroethene	5	1.5 J	< 25	< 25	< 25	< 25	< 25
cis-1,3-dichloropropene	0.4	< 13	< 25	< 25	< 25	< 25	< 25
Dibromochloromethane	50	< 13	< 25	< 25	< 25	< 25	< 25
Dichlorodifluoromethane (Freon 12)	5	< 13	< 25	< 25	< 25	< 25	< 25
Ethylbenzene	5	< 13	< 25	< 25	< 25	< 25	< 25
Methyl tert-Butyl Ether	5	< 13	< 25	< 25	< 25	< 25	< 25
Methylene Chloride	5	< 13	< 25	< 25	< 25	< 25	< 25
Styrene	5	< 13	< 25	< 25	< 25	< 25	< 25
Tetrachloroethene	5	0.9 J	< 25	< 25	< 25	< 25	< 25
Toluene	5	< 13	< 25	< 25	< 25	< 25	< 25
trans-1,2-dichloroethene	5	< 13	< 25	< 25	< 25	< 25	< 25
trans-1,3-dichloropropene	0.4	< 13	< 25	< 25	< 25	< 25	< 25
Trichloroethylene	5	1.4 J	< 25	< 25	< 25	< 25	< 25
Trichlorofluoromethane (CFC-11)	5	< 13	< 25	< 25	< 25	< 25	< 25
Trichlorotrifluoroethane (Freon 113)	5	< 13	< 25	< 25	< 25	< 25	< 25
Vinyl Chloride	2	< 5	< 10	< 10	< 10	< 10	< 10
Xylene-o	5	< 13	< 25	< 25	< 25	< 25	< 25
Xylenes - m,p	5	< 13	< 25	< 25	< 25	< 25	< 25
Total VOCs ⁽²⁾		565	840	850	820	650	520
Project VOCs ⁽³⁾		3.8	0.0	0.0	0.0	0.0	0.0

See notes on last page.

Table 9. Concentrations of Volatile Organic Compounds in Groundwater Samples Collected from Remedial Wells, Groundwater Interim Remedial Measure, Operable Unit 3 (Former Grumman Settling Ponds), Bethpage, New York. ⁽¹⁾

COMPOUND (ug/L)	Sample Location: Sample Date:	RW-4 10/3/2011	RW-4 1/9/2012	RW-4 4/3/2012	RW-4 7/2/2012	RW-4 10/1/2012	RW-4 1/7/2013
NYSDEC							
<u>SCGs</u>							
1,1,1-Trichloroethane	5	< 13 U	< 13 U	< 13 U	< 10 U	< 10 U	< 5 U
1,1,2,2-Tetrachloroethane	5	< 13 U	< 13 U	< 13 U	< 10 U	< 10 U	< 5 U
1,1,2-Trichloroethane	1	< 13 U	< 13 U	< 13 U	< 10 U	< 10 U	< 5 U
1,1-Dichloroethane	5	0.55 J	0.73 J	0.63 J	0.6 J	0.54 J	0.46 J
1,1-Dichloroethene	5	< 13 U	< 13 U	< 13 U	< 10 U	< 10 U	0.24 J
1,2-Dichloroethane	0.6	< 13 U	< 13 U	< 13 U	< 10 U	< 10 U	< 5 U
1,2-Dichloropropane	1	< 13 U	< 13 U	< 13 U	< 10 U	< 10 U	< 5 U
2-Butanone	NE	< 130 U	< 130 U	< 130 U	< 100 U	< 100 U	< 50 U
2-Hexanone	50	< 130 U	< 130 U	< 130 U	< 100 U	< 100 U	< 50 U
4-methyl-2-pentanone	50	< 130 U	< 130 U	< 130 U	< 100 U	< 100 U	< 50 U
Acetone	NE	< 130 U	< 130 U	< 130 U	< 100 UB	< 100 U	< 50 U
Benzene	1	< 1.8 U	< 1.8 U	< 1.8 U	< 1.4 U	< 1.4 U	< 0.7 U
Bromodichloromethane	50	< 13 U	< 13 U	< 13 U	< 10 U	< 10 U	< 5 U
Bromoform	50	< 13 U	< 13 U	< 13 U	< 10 U	< 10 U	< 5 U
Bromomethane	5	< 13 U	< 13 U	< 13 U	< 10 U	< 10 U	< 5 U
Carbon Disulfide	60	< 13 U	< 13 U	< 13 U	< 10 U	< 10 U	< 5 U
Carbon tetrachloride	5	< 13 U	< 13 U	< 13 U	< 10 U	< 10 U	< 5 U
Chlorobenzene	5	< 13 U	< 13 U	< 13 U	< 10 U	< 10 U	< 5 U
Chlorodifluoromethane (Freon 22)	NE	430	390	360	250	230	190 D
Chloroethane	5	< 13 U	< 13 U	< 13 U	< 10 U	< 10 U	< 5 U
Chloroform	7	< 13 U	< 13 U	< 13 U	< 10 U	< 10 U	0.28 J
Chloromethane	5	< 13 U	< 13 U	< 13 U	< 10 U	< 10 U	< 5 U
cis-1,2-dichloroethene	5	0.63 J	0.63 J	< 13 U	0.4 J	< 10 U	0.24 J
cis-1,3-dichloropropene	0.4	< 13 U	< 13 U	< 13 U	< 10 U	< 10 U	< 5 U
Dibromochloromethane	50	< 13 U	< 13 U	< 13 U	< 10 U	< 10 U	< 5 U
Dichlorodifluoromethane (Freon 12)	5	< 13 U	< 13 U	< 13 U	< 10 U	< 10 U	< 5 U
Ethylbenzene	5	< 13 U	< 13 U	< 13 U	< 10 U	< 10 U	< 5 U
Methyl tert-Butyl Ether	5	< 13 U	< 13 U	< 13 U	< 10 U	< 10 U	0.28 J
Methylene Chloride	5	< 13 U	< 13 U	< 13 U	< 10 U	< 10 U	< 5 U
Styrene	5	< 13 U	< 13 U	< 13 U	< 10 U	< 10 U	< 5 U
Tetrachloroethene	5	1.2 J	1.3 J	1.1 J	1.1 J	1 J	0.95 J
Toluene	5	< 13 U	< 13 U	< 13 U	< 10 U	< 10 U	< 5 U
trans-1,2-dichloroethene	5	< 13 U	< 13 U	< 13 U	< 10 U	< 10 U	< 5 U
trans-1,3-dichloropropene	0.4	< 13 U	< 13 U	< 13 U	< 10 U	< 10 U	< 5 U
Trichloroethylene	5	< 13 U	1.1 J	0.85 J	0.9 J	0.76 J	0.82 J
Trichlorofluoromethane (CFC-11)	5	< 13 U	< 13 U	< 13 U	< 10 U	< 10 U	< 5 U
Trichlorotrifluoroethane (Freon 113)	5	< 13 U	< 13 U	< 13 U	< 10 U	< 10 U	0.38 J
Vinyl Chloride	2	< 5 U	< 5 U	< 5 U	< 4 U	< 4 U	< 2 U
Xylene-o	5	< 13 U	< 13 U	< 13 U	< 10 U	< 10 U	< 5 U
Xylenes - m,p	5	< 13 U	< 13 U	< 13 U	< 10 U	< 10 U	< 5 U
Total VOCs ⁽²⁾		432	394	363	253	232	194
Project VOCs ⁽³⁾		2.4	3.8	2.6	2.6	2.3	2.7

See notes on last page.

Table 9. Concentrations of Volatile Organic Compounds in Groundwater Samples Collected from Remedial Wells, Groundwater Interim Remedial Measure, Operable Unit 3 (Former Grumman Settling Ponds), Bethpage, New York. ⁽¹⁾

Notes:

- (1) Water samples collected by ARCADIS on the dates shown and submitted to Columbia Analytical Services, Inc. for VOC analysis using NYSDEC ASP 2000 Method OLM4.3. Results validated following protocols specified in Sampling and Analysis Plan in the December 2009 DRAFT OM&M Manual (ARCADIS 2009).
- (2) "Total VOCs" represents the sum of individual concentrations of the VOCs detected.
- (3) "Project VOCs" represents the sum of individual compound concentrations of 1,1,1-Trichloroethane; 1,1-Dichloroethane; 1,2-Dichloroethane; 1,1-Dichloroethene; Tetrachloroethene; Trichloroethene; Vinyl Chloride; cis-1,2-Dichloroethene; trans-1,2-Dichloroethene; Benzene; Toluene; and Xylenes-o,m, and p.

Acronyms\Key:

- Indicates an exceedance of an SCG.
- 700** Bold data indicates that the analyte was detected at or above its reporting limit.
- ASP Analytical services protocol.
- B Compound detected in associated blank sample.
- D Constituent identified from secondary dilution.
- J Value is estimated.
- NE Not established.
- NYSDEC New York State Department of Environmental Conservation.
- R Concentration for the constituent was rejected.
- SCGs Standards, criteria, and guidance values.
- VOC Volatile organic compound.
- ug/L Micrograms per liter.
- < 5 Compound not detected above its laboratory quantification limit.
- Not analyzed.

Table 10. Concentrations of Metals in Groundwater Samples Collected from Remedial Wells, Groundwater Interim Remedial Measure, Operable Unit 3 (Former Grumman Settling Ponds), Bethpage, New York. ⁽¹⁾

COMPOUND (ug/L)	Sample Location: Sample Date:	RW-1 4/21/2009	RW-1 7/29/2009	RW-1 8/12/2009	RW-1 9/10/2009	RW-1 11/10/2009	RW-1 12/2/2009	RW-1 10/4/2010	RW-1 2/10/2011	RW-1 10/3/2011	RW-1 11/11/2011	RW-1 ⁽²⁾ 10/1/2012	RW-1 1/7/2013
	NYSDEC <u>SCGs</u>												
Total Cadmium	5	< 5	--	--	--	--	--	< 5	--	--	< 5	< 5	--
Dissolved Cadmium	5	< 5	--	--	--	--	--	< 5	--	--	< 5	< 5	--
Total Chromium	50	24.3	--	--	--	--	--	27	--	--	23	23	--
Dissolved Chromium	50	20.2	--	--	--	--	--	27	--	--	24	23	--
Total Iron	300	< 100	< 100	< 100	< 100	< 100	< 100	< 100	< 100	< 100	--	< 100	--
Dissolved Iron	300	< 100	--	--	--	--	--	< 100	< 100	< 100	--	< 100	--
Total Manganese	300	23.6	--	--	--	--	--	12	--	--	--	--	--
Dissolved Manganese	300	22.4	--	--	--	--	--	11	--	--	--	--	--
Total Mercury	0.7	< 0.2	--	--	--	--	--	--	--	--	--	--	--
Dissolved Mercury	0.7	< 0.2	--	--	--	--	--	--	--	--	--	--	--

See notes on last page.

Table 10. Concentrations of Metals in Groundwater Samples Collected from Remedial Wells, Groundwater Interim Remedial Measure, Operable Unit 3 (Former Grumman Settling Ponds), Bethpage, New York. ⁽¹⁾

COMPOUND (ug/L)	Sample Location: Sample Date:	RW-2 4/21/2009	RW-2 7/29/2009	RW-2 8/12/2009	RW-2 9/10/2009	RW-2 10/9/2009	RW-2 11/10/2009	RW-2 12/2/2009	RW-2 1/11/2010	RW-2 2/2/2010	RW-2 3/10/2010
	NYSDEC <u>SCGs</u>										
Total Cadmium	5	< 5	--	--	--	--	--	--	--	--	--
Dissolved Cadmium	5	< 5	--	--	--	--	--	--	--	--	--
Total Chromium	50	< 10	--	--	--	--	--	--	--	--	--
Dissolved Chromium	50	< 10	--	--	--	--	--	--	--	--	--
Total Iron	300	2,330	5,950	4,870	3,550	3,800	2,040	1,260	1,140	1,000	2,550
Dissolved Iron	300	781	--	--	--	--	--	--	--	--	--
Total Manganese	300	241	--	--	--	--	--	--	--	--	--
Dissolved Manganese	300	248	--	--	--	--	--	--	--	--	--
Total Mercury	0.7	< 0.2	--	--	--	--	--	--	--	--	--
Dissolved Mercury	0.7	< 0.2	--	--	--	--	--	--	--	--	--

See notes on last page.

Table 10. Concentrations of Metals in Groundwater Samples Collected from Remedial Wells, Groundwater Interim Remedial Measure, Operable Unit 3 (Former Grumman Settling Ponds), Bethpage, New York. ⁽¹⁾

COMPOUND (ug/L)	Sample Location: Sample Date:	RW-2	RW-2	RW-2	RW-2	RW-2	RW-2	RW-2	RW-2	RW-2	RW-2
		4/12/2010	7/20/2010	10/4/2010	12/6/2010	2/10/2011	2/10/2011	3/7/2011	5/2/2011	6/8/2011	7/8/2011
	NYSDEC <u>SCGs</u>										
Total Cadmium	5	--	--	< 5	--	--	--	--	--	--	--
Dissolved Cadmium	5	--	--	< 5	--	--	--	--	--	--	--
Total Chromium	50	--	--	< 10	--	--	--	--	--	--	--
Dissolved Chromium	50	--	--	< 10	--	--	--	--	--	--	--
Total Iron	300	880	1,180	710	590	970	970	850	890	830	3,110
Dissolved Iron	300	--	--	380	270	550	550	530	710	670	670
Total Manganese	300	--	--	187	--	--	--	--	--	--	--
Dissolved Manganese	300	--	--	192	--	--	--	--	--	--	--
Total Mercury	0.7	--	--	--	--	--	--	--	--	--	--
Dissolved Mercury	0.7	--	--	--	--	--	--	--	--	--	--

See notes on last page.

Table 10. Concentrations of Metals in Groundwater Samples Collected from Remedial Wells, Groundwater Interim Remedial Measure, Operable Unit 3 (Former Grumman Settling Ponds), Bethpage, New York. ⁽¹⁾

COMPOUND (ug/L)	Sample Location: Sample Date:	RW-2 8/1/2011	RW-2 9/6/2011	RW-2 10/3/2011	RW-2 11/11/2011	RW-2 12/19/2011	RW-2 1/9/2012	RW-2 2/6/2012	RW-2 3/8/2012	RW-2 4/3/2012	RW-2 5/7/2012
	NYSDEC <u>SCGs</u>										
Total Cadmium	5	--	--	--	< 5	--	--	--	--	--	< 5
Dissolved Cadmium	5	--	--	--	< 5	--	--	--	--	--	< 5
Total Chromium	50	--	--	--	< 10	--	--	--	--	--	< 10
Dissolved Chromium	50	--	--	--	< 10	--	--	--	--	--	< 10
Total Iron	300	840	830	1,640	750	930	870	960	990	930	970
Dissolved Iron	300	670	650	640	540	750	700	640	640	830	730
Total Manganese	300	--	--	--	--	--	--	--	--	--	--
Dissolved Manganese	300	--	--	--	--	--	--	--	--	--	--
Total Mercury	0.7	--	--	--	--	--	--	--	--	--	--
Dissolved Mercury	0.7	--	--	--	--	--	--	--	--	--	--

See notes on last page.

Table 10. Concentrations of Metals in Groundwater Samples Collected from Remedial Wells, Groundwater Interim Remedial Measure, Operable Unit 3 (Former Grumman Settling Ponds), Bethpage, New York. ⁽¹⁾

COMPOUND (ug/L)	Sample Location: Sample Date:	RW-2	RW-2	RW-2	RW-2	RW-2	RW-2	RW-2	RW-2	RW-2	RW-2 ⁽³⁾
		6/5/2012	7/2/2012	8/7/2012	9/4/2012	10/1/2012	11/12/2012	12/3/2012	1/7/2013	2/4/2013	3/4/2013
	NYSDEC <u>SCGs</u>										
Total Cadmium	5	--	--	--	--	< 5	--	--	--	--	--
Dissolved Cadmium	5	--	--	--	--	< 5	--	--	--	--	--
Total Chromium	50	--	--	--	--	< 10	--	--	--	--	--
Dissolved Chromium	50	--	--	--	--	< 10	--	--	--	--	--
Total Iron	300	800	940	1,850	950	1,020	750	670	600	640	1,950
Dissolved Iron	300	690	840	780	810	780	610	540	560	520	1,920
Total Manganese	300	--	--	--	--	--	--	--	--	--	--
Dissolved Manganese	300	--	--	--	--	--	--	--	--	--	--
Total Mercury	0.7	--	--	--	--	--	--	--	--	--	--
Dissolved Mercury	0.7	--	--	--	--	--	--	--	--	--	--

See notes on last page.

Table 10. Concentrations of Metals in Groundwater Samples Collected from Remedial Wells, Groundwater Interim Remedial Measure, Operable Unit 3 (Former Grumman Settling Ponds), Bethpage, New York. ⁽¹⁾

COMPOUND (ug/L)	Sample Location: Sample Date:	RW-3 4/22/2009	RW-3 7/29/2009	RW-3 9/10/2009	RW-3 11/10/2009	RW-3 12/2/2009	RW-3 3/10/2010	RW-3 4/12/2010	RW-3 7/20/2010	RW-3 10/4/2010
	NYSDEC <u>SCGs</u>									
Total Cadmium	5	< 5	--	--	--	--	--	--	--	< 5
Dissolved Cadmium	5	< 5	--	--	--	--	--	--	--	< 5
Total Chromium	50	22.6	--	--	--	--	--	--	--	< 10
Dissolved Chromium	50	< 10	--	--	--	--	--	--	--	< 10
Total Iron	300	246	< 100	< 100	< 100	< 100	200	470	890	350
Dissolved Iron	300	< 100	--	--	--	--	--	--	--	< 100
Total Manganese	300	< 10	--	--	--	--	--	--	--	35
Dissolved Manganese	300	< 10	--	--	--	--	--	--	--	34
Total Mercury	0.7	< 0.2	--	--	--	--	--	--	--	--
Dissolved Mercury	0.7	< 0.2	--	--	--	--	--	--	--	--

See notes on last page.

Table 10. Concentrations of Metals in Groundwater Samples Collected from Remedial Wells, Groundwater Interim Remedial Measure, Operable Unit 3 (Former Grumman Settling Ponds), Bethpage, New York. ⁽¹⁾

COMPOUND (ug/L)	Sample Location:	RW-3	RW-3	RW-3	RW-3	RW-3	RW-3	RW-3	RW-3	RW-3
	Sample Date:	12/6/2010	3/7/2011	4/8/2011	5/2/2011	6/8/2011	7/8/2011	8/1/2011	9/6/2011	10/3/2011
	NYSDEC									
	<u>SCGs</u>									
Total Cadmium	5	--	--	--	--	--	--	--	--	--
Dissolved Cadmium	5	--	--	--	--	--	--	--	--	--
Total Chromium	50	--	--	--	--	--	--	--	--	--
Dissolved Chromium	50	--	--	--	--	--	--	--	--	--
Total Iron	300	340	530	480	480	570	450	450	370	460
Dissolved Iron	300	150	200	200	130	140	120	120	< 100	110
Total Manganese	300	--	--	--	--	--	--	--	--	--
Dissolved Manganese	300	--	--	--	--	--	--	--	--	--
Total Mercury	0.7	--	--	--	--	--	--	--	--	--
Dissolved Mercury	0.7	--	--	--	--	--	--	--	--	--

See notes on last page.

Table 10. Concentrations of Metals in Groundwater Samples Collected from Remedial Wells, Groundwater Interim Remedial Measure, Operable Unit 3 (Former Grumman Settling Ponds), Bethpage, New York. ⁽¹⁾

COMPOUND (ug/L)	Sample Location: Sample Date:	RW-3 11/11/2011	RW-3 12/19/2011	RW-3 1/9/2012	RW-3 2/6/2012	RW-3 3/8/2012	RW-3 4/3/2012	RW-3 5/7/2012	RW-3 6/5/2012	RW-3 7/2/2012
	NYSDEC <u>SCGs</u>									
Total Cadmium	5	< 5	--	--	--	--	--	< 5	--	--
Dissolved Cadmium	5	< 5	--	--	--	--	--	< 5	--	--
Total Chromium	50	< 10	--	--	--	--	--	< 10	--	--
Dissolved Chromium	50	< 10	--	--	--	--	--	< 10	--	--
Total Iron	300	460	280	500	410	980	310	400	140	250
Dissolved Iron	300	< 100	200	110	100	130	110	< 100	120	110
Total Manganese	300	--	--	--	--	--	--	--	--	--
Dissolved Manganese	300	--	--	--	--	--	--	--	--	--
Total Mercury	0.7	--	--	--	--	--	--	--	--	--
Dissolved Mercury	0.7	--	--	--	--	--	--	--	--	--

See notes on last page.

Table 10. Concentrations of Metals in Groundwater Samples Collected from Remedial Wells, Groundwater Interim Remedial Measure, Operable Unit 3 (Former Grumman Settling Ponds), Bethpage, New York. ⁽¹⁾

COMPOUND (ug/L)	Sample Location: Sample Date:	RW-3 8/7/2012	RW-3 9/4/2012	RW-3 10/1/2012	RW-3 11/12/2012	RW-3 12/3/2012	RW-3 1/7/2013	RW-3 2/4/2013	RW-3 3/4/2013
NYSDEC <u>SCGs</u>									
Total Cadmium	5	--	--	< 5	--	--	--	--	--
Dissolved Cadmium	5	--	--	< 5	--	--	--	--	--
Total Chromium	50	--	--	< 10	--	--	--	--	--
Dissolved Chromium	50	--	--	< 10	--	--	--	--	--
Total Iron	300	310	140	280	220	210	< 100	290	130
Dissolved Iron	300	120	< 100	< 100	100	< 100	< 100	110	130
Total Manganese	300	--	--	--	--	--	--	--	--
Dissolved Manganese	300	--	--	--	--	--	--	--	--
Total Mercury	0.7	--	--	--	--	--	--	--	--
Dissolved Mercury	0.7	--	--	--	--	--	--	--	--

See notes on last page.

Table 10. Concentrations of Metals in Groundwater Samples Collected from Remedial Wells, Groundwater Interim Remedial Measure, Operable Unit 3 (Former Grumman Settling Ponds), Bethpage, New York. ⁽¹⁾

COMPOUND (ug/L)	Sample Location: Sample Date:	RW-4 4/22/2009	RW-4 7/29/2009	RW-4 8/12/2009	RW-4 9/10/2009	RW-4 11/10/2009	RW-4 12/2/2009	RW-4 10/4/2010	RW-4 10/3/2011	RW-4 11/11/2011	RW-4 ⁽²⁾ 10/1/2012	RW-4 1/7/2013
NYSDEC SCGs												
Total Cadmium	5	< 5	--	--	--	--	--	< 5	--	< 5	< 5	--
Dissolved Cadmium	5	< 5	--	--	--	--	--	< 5	--	< 5	< 5	--
Total Chromium	50	< 10	--	--	--	--	--	< 10	--	< 10	< 10	--
Dissolved Chromium	50	< 10	--	--	--	--	--	< 10	--	< 10	< 10	--
Total Iron	300	< 100	< 100	< 100	< 100	< 100	< 100	< 100	< 100	< 100	< 100	--
Dissolved Iron	300	< 100	--	--	--	--	--	< 100	< 100	< 100	< 100	--
Total Manganese	300	10.4	--	--	--	--	--	28	--	--	--	--
Dissolved Manganese	300	< 10	--	--	--	--	--	29	--	--	--	--
Total Mercury	0.7	< 0.2	--	--	--	--	--	--	--	--	--	--
Dissolved Mercury	0.7	< 0.2	--	--	--	--	--	--	--	--	--	--

- Notes:**
- (1) Water samples collected by ARCADIS on the dates shown and submitted to Columbia Analytical Services, Inc. for metals analysis using USEPA Method 6010 and for mercury analyses using USEPA Method 7470. Results validated following protocols specified in Sampling and Analysis Plan in the December 2009 DRAFT OM&M Manual (ARCADIS 2009).
 - (2) Beginning January 2012 metals analyses for recovery wells RW-1 and RW-4 are included with annual recovery well sampling performed in October of each year.
 - (3) Elevated RW-2 iron concentrations are believed attributed to multiple system shutdowns and re-starts due to a fouled pressure switch on March 2 and March 3, 2013. Turbulence dislodged accumulated iron deposits at the remedial well piping.

- Acronyms/Key:**
- Indicates an exceedance of an SCG.
 - 700** Bold data indicates that the analyte was detected at or above its reporting limit.
 - NYSDEC New York State Department of Environmental Conservation.
 - ASP Analytical services protocol.
 - SCGs Standards, criteria, and guidance values.
 - ug/L Micrograms per liter.
 - Not analyzed.
 - < 5 Compound not detected above its laboratory quantification limit.



Table 11. Summary of Water-Level Elevations, Groundwater Interim Remedial Measure, Operable Unit 3 (Former Grumman Settling Ponds), Bethpage, New York.

Well Identification	Well Casing Elevation (ft msl)	Event Date	Baseline (1) 5/8/2009 (ft msl)	1Q2010 02/04/10 (ft msl)	2Q2010 04/23/10 (ft msl)	3Q2010 08/26/10 (ft msl)	4Q2010 12/10/10 (ft msl)	1Q2011 02/04/11 (ft msl)	2Q2011 05/20/11 (ft msl)	3Q2011 08/09/11 (ft msl)	4Q2011 10/26/11 (ft msl)	1Q2012 01/25/12 (ft msl)	2Q2012 05/02/12 (ft msl)	3Q2012 08/17/12 (ft msl)	4Q2012 10/05/12 (ft msl)	1Q2013 02/13/13 (ft msl)
Recovery Wells																
RW-1	125.18		69.75	70.67	74.38	72.52	71.11	70.96	72.13	70.44	72.72	73.15	72.12	71.71	71.21	70.35
RW-2	124.48		72.27	61.80	64.88	63.44	61.35	67.99	66.31	64.18	65.11	69.05	69.81	65.3	63.7	62.66
RW-3	122.84		69.40	67.64	71.4	69.44*	68.13	67.74	68.88	67.64	69.70	70.75	71.74	74.35 ⁽²⁾	68.06	68.01
RW-4	121.25		69.25	70.35	74.02	71.93	70.56	67.06	71.37	69.95	72.13	72.71	71.61	70.88	70.67	69.7
Monitoring Wells																
B24MW-2	126.96		74.31	74.13	76.16	75.86	75.65	74.96	76.06	74.35	76.00	76.28	75.57	75.76	74.63	74.85
B24MW-3	127.11		72.63	72.16	75.87	74.10	72.89	72.40	74.04	72.27	74.44	74.63	73.67	73.62	72.69	72.2
B30MW-1	128.33		73.55	73.00	76.54	74.96	73.86	73.38	74.75	73.25	75.41	75.54	74.66	NM	73.66	73.11
BCPMW-1	125.73		73.16	72.67	76.26	74.66	73.43	72.94	74.75	72.94	75.05	75.23	74.29	74.22	73.27	
BCPMW-2	126.39		72.55	71.83	75.52	73.69	72.55	72.03	73.64	71.94	74.16	74.33	73.29	73.17	72.39	71.82
BCPMW-3	124.94		72.46	71.59	75.24	73.40	72.27	71.74	73.25	71.64	73.94	74.05	73.06	72.85	72.14	71.56
BCPMW-4-1	128.76		72.30	71.33	75.05	73.13	72.02	71.56	73.08	71.46	73.70	73.78	72.81	72.59	71.89	71.41
BCPMW-4-2	129.15		72.58	71.36	75.07	73.16	72.08	71.56	73.06	71.51	73.74	73.83	72.83	72.61	71.92	71.42
BCPMW-4-3	129.19		72.32	71.46	75.16	73.26	72.14	71.73	73.19	71.55	73.84	73.96	72.94	72.71	71.97	71.53
BCPMW-5-1	129.37		72.79	72.14	75.66	73.94	72.72	72.74	73.81	72.14	74.46	74.77	73.67	73.34	72.62	72.06
BCPMW-6-1	126.01		72.12	71.26	74.91	72.96	71.91	71.49	72.77	71.45	73.58	73.67	72.66	72.32	71.73	71.12
BCPMW-6-2	125.16		71.74	70.96	74.64	72.60	71.59	71.17	72.49	71.01	73.26	73.37	72.30	71.97	71.39	70.84
BCPMW-7-1	124.81		72.00	71.33	74.99	72.99	71.97	71.51	72.78	71.53	73.62	73.71	72.71	72.31	71.77	71.2
MW-200-1	123.49		72.16	71.37	75.07	73.14	72.08	71.72	72.98	71.52	73.69	73.83	72.76	72.59	71.91	71.34
MW-201-1	121.69		72.04	71.10	74.84	72.87	71.79	71.33	72.69	71.25	73.48	73.55	72.53	72.28	71.65	71.09
MW-202-1	119.27		71.90	71.13	74.83	72.82	71.77	71.32	72.66	71.21	73.46	73.57	73.51	72.23	71.6	70.98
MW-203-1	118.25		71.83	71.10	74.75	72.77	71.75	71.30	72.61	70.20	73.43	73.52	72.49	72.13	71.56	71.02
Piezometers																
PZ-1a	128.82		72.56	71.15	74.87	72.94	71.85	71.33	72.76	71.31	73.54	73.62	72.63	72.42	71.72	71.23
PZ-1b	128.92		72.47	71.09	74.78	72.88	71.82	71.28	72.70	71.24	73.47	73.55	72.56	72.36	71.64	71.16
PZ-1c	128.96		72.47	71.48	75.15	73.23	72.13	71.74	73.16	71.56	73.83	73.9	72.90	72.68	71.94	71.46
PZ-2a	128.36		72.47	71.09	74.82	72.87	71.81	71.34	72.74	71.30	73.45	73.57	72.57	72.32	71.64	71.14
PZ-2b	128.37		72.43	71.08	74.77	72.86	71.78	71.30	72.68	71.27	73.45	73.55	72.54	72.28	71.61	71.13
PZ-2c	128.55		72.41	71.40	75.05	73.15	72.05	71.68	73.05	71.52	73.74	73.87	72.82	72.55	71.88	71.38
PZ-3	124.99		72.52	70.94	74.69	72.71	71.65	70.93	72.55	71.08	73.28	73.4	72.35	72.16	71.44	71.06
PZ-4	125.31		72.50	71.07	74.81	72.83	71.78	71.45	72.64	71.32	73.42	73.52	72.54	72.32	71.63	71.18
PZ-5a	129.07		72.50	71.94	75.61	73.79	72.59	72.17	73.70	71.98	74.27	74.39	73.40	73.25	72.45	71.94
PZ-5b	129.06		72.50	71.84	75.53	73.69	72.51	72.08	73.67	71.88	74.16	74.29	73.29	73.15	72.35	71.85
PZ-6a	125.67		72.50	71.03	74.73	72.84	71.70	71.24	72.56	71.24	73.37	73.46	72.43	72.13	71.5	70.95
PZ-6b	125.74		72.50	70.93	74.7	72.65	71.58	71.11	72.46	71.14	73.28	73.37	72.34	72.05	71.43	70.88
PZ-7a	125.10		72.50	71.32	75.02	73.00	72.00	71.54	72.80	71.58	73.67	73.7	72.72	72.36	71.78	71.2
PZ-7b	125.06		72.50	71.21	74.85	72.83	71.83	71.37	72.68	71.26	73.45	73.53	72.51	72.13	71.54	71.05

Notes and Abbreviations:

(1) Baseline readings were taken prior to system start-up, which occurred on July 21, 2009.

(2) Measurement collected is believed to be anomalous

*: RW-3 water level measurement collected on September 9, 2010.

ft msl: feet relative to mean sea level

NM: not measured



Table 12. Summary of Calculated Vertical Groundwater Hydraulic Gradients, Groundwater Interim Remedial Measure, Operable Unit 3 (Former Grumman Settling Ponds), Bethpage, New York.

Observation Well Pairing			10/5/2012			2/13/2013		
Shallow	Deep	Vertical Distance Between Screens (ft)	Observed Head		Vertical Hydraulic Gradient (1) (ft/ft)	Observed Head		Vertical Hydraulic Gradient (1) (ft/ft)
			Shallow (ft msl)	Deep (ft msl)		Shallow (ft msl)	Deep (ft msl)	
PZ-1A	PZ-1B	20	71.72	71.64	-0.004	71.23	71.16	-0.0035
PZ-1B	PZ-1C	50	71.64	71.94	0.006	71.16	71.46	0.006
PZ-2A	PZ-2B	20	71.64	71.61	-0.0015	71.14	71.13	-0.0005
PZ-2B	PZ-2C	50	71.61	71.88	0.0054	71.13	71.38	0.005
PZ-5A	PZ-5B	45	72.45	72.35	-0.0022	71.94	71.85	-0.002
PZ-6A	PZ-6B	25	71.50	71.43	-0.0028	70.95	70.88	-0.0028
PZ-7A	PZ-7B	48	71.78	71.54	-0.005	71.20	71.05	-0.0031
BCPMW-4-1	BCPMW-4-2	21	71.89	71.92	0.0014	71.41	71.42	0.0005
BCPMW-4-2	BCPMW-4-3	44	71.92	71.97	0.0011	71.42	71.53	0.0025
BCPMW-6-1	BCPMW-6-2	44.5	71.73	71.39	-0.0072	71.12	70.84	-0.0076

Notes:

1. Positive groundwater hydraulic gradient indicates a vertically upward gradient and a negative groundwater hydraulic gradient indicates vertically downward gradient.

Table 13. Concentrations of Volatile Organic Compounds in Groundwater Samples Collected from Monitoring Wells, Groundwater Interim Remedial Measure, Operable Unit 3 (Former Grumman Settling Ponds), Bethpage, New York. ^(1,2,3)

COMPOUND (ug/L)	Sample Location: B24MW-2 B24MW-2 B24MW-2 B24MW-2 B24MW-3 B24MW-3 B24MW-3							
	Sample Date: 4/23/2009 10/4/2010 10/27/2011 10/3/2012 4/20/2009 10/6/2010 10/27/2011							
	NYSDEC SCGs							
1,1,1-Trichloroethane	5	< 5	< 5	< 5	< 5	0.62 J	< 5	< 5
1,1,2,2-Tetrachloroethane	5	< 5	< 5	< 5	< 5	< 5	< 5	< 5
1,1,2-Trichloroethane	1	< 5	< 5	< 5	< 5	< 5	< 5	< 5
1,1-Dichloroethane	5	< 5	< 5	< 5	< 5	< 5	< 5	< 5
1,1-Dichloroethene	5	< 5	< 5	< 5	< 5	< 5	< 5	< 5
1,2-Dichloroethane	0.6	< 5	< 5	< 5	< 5	< 5	< 5	< 5
1,2-Dichloropropane	1	< 5	< 5	< 5	< 5	< 5	< 5	< 5
2-Butanone	NE	< 50	< 50	< 50	< 50	< 50	< 50	< 50
2-Hexanone	50	< 50	< 50	< 50	< 50	< 50 J	< 50	< 50
4-methyl-2-pentanone	50	< 50	< 50	< 50	< 50	< 50 J	< 50	< 50
Acetone	NE	< 50 B	< 50	< 50 B	< 50	< 50	< 50	< 50
Benzene	1	< 0.7	< 0.7	< 0.7	< 0.7	< 0.7	< 0.7	< 0.7
Bromodichloromethane	50	< 5	< 5	< 5	< 5	< 5	< 5	< 5
Bromoform	50	< 5	< 5	< 5	< 5	< 5	< 5	< 5
Bromomethane	5	< 5	< 5	< 5	< 5	< 5	< 5	< 5
Carbon Disulfide	60	< 5	< 5	< 5	< 5	< 5	< 5	< 5
Carbon tetrachloride	5	< 5	< 5	< 5	< 5	< 5	< 5	< 5
Chlorobenzene	5	< 5	< 5	< 5	< 5	< 5	< 5	< 5
Chlorodifluoromethane (Freon 22)	NE	< 5	< 5	< 5	0.41 J	< 5	< 5	< 5
Chloroethane	5	< 5	< 5	< 5	< 5	< 5	< 5	< 5
Chloroform	7	< 5	0.3 J	< 5	1.3 J	< 5	< 5	0.32 J
Chloromethane	5	< 5	< 5	< 5	< 5	< 5	< 5	< 5
cis-1,2-dichloroethene	5	< 5	< 5	< 5	1.9 J	10	1.2 J	0.4 J
cis-1,3-dichloropropene	0.4	< 5	< 5	< 5	< 5	< 5	< 5	< 5
Dibromochloromethane	50	< 5	< 5	< 5	< 5	< 5	< 5	< 5
Dichlorodifluoromethane (Freon 12)	5	< 5	< 5	< 5	< 5	< 5	< 5	< 5
Ethylbenzene	5	< 5	< 5	< 5	< 5	< 5	< 5	< 5
Methyl tert-Butyl Ether	5	--	< 5	--	0.45 J	--	< 5	--
Methylene Chloride	5	< 5	< 5	< 5	< 5	< 5	< 5	< 5
Styrene	5	< 5	< 5	< 5	< 5	< 5	< 5	< 5
Tetrachloroethene	5	< 5	< 5	< 5	< 5	0.51 J	< 5	< 5
Toluene	5	< 5	< 5	< 5	< 5	< 5	< 5	< 5
trans-1,2-dichloroethene	5	< 5	< 5	< 5	< 5	< 5	< 5	< 5
trans-1,3-dichloropropene	0.4	< 5	< 5	< 5	< 5	< 5	< 5	< 5
Trichloroethene	5	3.7 J	4.4 J	3.2 J	25	45	5.9	1.4 J
Trichlorotrifluoroethane (Freon 113)	5	< 5	< 5	< 5	< 5	< 5	< 5	< 5
Vinyl Chloride	2	< 2	< 2	< 2	< 2	< 2	< 2	< 2
Xylene-o	5	< 5	< 5	< 5	< 5	< 5	< 5	< 5
Xylenes - m,p	5	< 5	< 5	< 5	< 5	< 5	< 5	< 5
Total VOCs ⁽⁴⁾		3.7	4.7	3.2	29	56	7.1	2.1
Project VOCs ⁽⁵⁾		3.7	4.4	3.2	27	56	7.1	1.8

See notes on last page.

Table 13. Concentrations of Volatile Organic Compounds in Groundwater Samples Collected from Monitoring Wells, Groundwater Interim Remedial Measure, Operable Unit 3 (Former Grumman Settling Ponds), Bethpage, New York. ^(1,2,3)

COMPOUND (ug/L)	Sample Location: Sample Date:	B24MW-3 10/4/2012	B30MW-1 4/23/2009	B30MW-1 10/4/2010	B30MW-1 10/27/2011	B30MW-1 10/3/2012	BCPMW-1 4/28/2009
	NYSDEC						
	SCGs						
1,1,1-Trichloroethane	5	< 5	< 5	< 5	< 5	< 5	< 5
1,1,2,2-Tetrachloroethane	5	< 5	< 5	< 5	< 5	< 5	< 5
1,1,2-Trichloroethane	1	< 5	< 5	< 5	< 5	< 5	< 5
1,1-Dichloroethane	5	< 5	< 5	< 5	< 5	< 5	0.37 J
1,1-Dichloroethene	5	< 5	< 5	< 5	< 5	< 5	< 5
1,2-Dichloroethane	0.6	< 5	< 5	< 5	< 5	< 5	< 5
1,2-Dichloropropane	1	< 5	< 5	< 5	< 5	< 5	< 5
2-Butanone	NE	< 50	< 50	< 50	< 50	< 50	< 50
2-Hexanone	50	< 50	< 50	< 50	< 50	< 50	< 50
4-methyl-2-pentanone	50	< 50	< 50	< 50	< 50	< 50	< 50
Acetone	NE	< 50	< 50 B	< 50 B	< 50	< 50	< 50 B
Benzene	1	< 0.7	< 0.7	< 0.7	< 0.7	< 0.7	< 0.7
Bromodichloromethane	50	< 5	< 5	< 5	< 5	< 5	< 5
Bromoform	50	< 5	< 5	< 5	< 5	< 5	< 5
Bromomethane	5	< 5	< 5	< 5	< 5	< 5	< 5
Carbon Disulfide	60	< 5	< 5	< 5	< 5	< 5	< 5
Carbon tetrachloride	5	< 5	< 5	< 5	< 5	< 5	< 5
Chlorobenzene	5	< 5	< 5	< 5	< 5	< 5	< 5
Chlorodifluoromethane (Freon 22)	NE	< 5	< 5	< 5	< 5	< 5	< 5
Chloroethane	5	< 5	< 5	< 5	< 5	< 5	< 5
Chloroform	7	0.38 J	< 5	< 5	< 5	< 5	0.88 J
Chloromethane	5	< 5	< 5	< 5	< 5	< 5	< 5
cis-1,2-dichloroethene	5	0.62 J	< 5	< 5	< 5	< 5	22
cis-1,3-dichloropropene	0.4	< 5	< 5	< 5	< 5	< 5	< 5
Dibromochloromethane	50	< 5	< 5	< 5	< 5	< 5	< 5
Dichlorodifluoromethane (Freon 12)	5	< 5	< 5	< 5	< 5	< 5	< 5
Ethylbenzene	5	< 5	< 5	< 5	< 5	< 5	< 5
Methyl tert-Butyl Ether	5	< 5	--	< 5	--	< 5	--
Methylene Chloride	5	< 5	< 5	< 5	< 5	< 5	0.52 J
Styrene	5	< 5	< 5	< 5	< 5	< 5	< 5
Tetrachloroethene	5	< 5	< 5	< 5	< 5	< 5	< 5
Toluene	5	< 5	< 5	< 5	< 5	< 5	0.33 J
trans-1,2-dichloroethene	5	< 5	< 5	< 5	< 5	< 5	0.44 J
trans-1,3-dichloropropene	0.4	< 5	< 5	< 5	< 5	< 5	< 5
Trichloroethene	5	1 J	< 5	< 5	< 5	< 5	190
Trichlorotrifluoroethane (Freon 113)	5	< 5	< 5	< 5	< 5	< 5	< 5
Vinyl Chloride	2	< 2	< 2	< 2	< 2	< 2	< 2
Xylene-o	5	< 5	< 5	< 5	< 5	< 5	< 5
Xylenes - m,p	5	< 5	< 5	< 5	< 5	< 5	< 5
Total VOCs ⁽⁴⁾		2.0	0	0	0	0	220
Project VOCs ⁽⁵⁾		1.6	0	0	0	0	210

See notes on last page.

Table 13. Concentrations of Volatile Organic Compounds in Groundwater Samples Collected from Monitoring Wells, Groundwater Interim Remedial Measure, Operable Unit 3 (Former Grumman Settling Ponds), Bethpage, New York. ^(1,2,3)

COMPOUND (ug/L)	Sample Location: BCPMW-2		BCPMW-3	BCPMW-4-1	BCPMW-4-1	BCPMW-4-1	BCPMW-4-1
	Sample Date: 4/28/2009		4/29/2009	4/17/2009	12/1/2009	10/4/2010	10/28/2011
	NYSDEC SCGs						
1,1,1-Trichloroethane	5	< 10	< 25	< 25	2.4 J	14 J	10 J
1,1,2,2-Tetrachloroethane	5	< 10	< 25	< 25	< 5	< 25	< 25
1,1,2-Trichloroethane	1	< 10	< 25	< 25	0.38 J	< 25	< 25
1,1-Dichloroethane	5	8 J	9.6 J	6.5 J	46	38	18 J
1,1-Dichloroethene	5	3.8 J	43	1.8 J	14	21 J	13 J
1,2-Dichloroethane	0.6	0.68 J	< 25	< 25	0.65 J	< 25	2.1 J
1,2-Dichloropropane	1	< 10	< 25	< 25	4.7 J	3.8 J	1.9 J
2-Butanone	NE	< 100	< 250	< 250	< 50	< 250	< 250
2-Hexanone	50	< 100	< 250	< 250 J	< 50	< 250	< 250
4-methyl-2-pentanone	50	< 100	< 250	< 250 J	< 50	< 250	< 250
Acetone	NE	< 100	< 250	< 250 J	< 50	< 250	< 250B
Benzene	1	< 1.4	< 3.5	< 3.5	0.44 J	< 3.5	< 3.5
Bromodichloromethane	50	< 10	< 25	< 25	< 5	< 25	< 25
Bromoform	50	< 10	< 25	< 25	< 5	< 25	< 25
Bromomethane	5	< 10	< 25	< 25	R	< 25	< 25
Carbon Disulfide	60	< 10	< 25	< 25	< 5	< 25	< 25
Carbon tetrachloride	5	< 10	< 25	< 25	< 5	< 25	< 25
Chlorobenzene	5	< 10	< 25	< 25	< 5	< 25	< 25
Chlorodifluoromethane (Freon 22)	NE	< 10	< 25	17 J	6.2	4.3 J	2.5 J
Chloroethane	5	< 10	< 25	< 25	2.4 J	4.1 J	< 25
Chloroform	7	< 10	< 25	< 25	< 5	< 25	< 25
Chloromethane	5	< 10	< 25	< 25	R	< 25	< 25
cis-1,2-dichloroethene	5	310	900	1800 D	750 D	510	500
cis-1,3-dichloropropene	0.4	< 10	< 25	< 25	< 5	< 25	< 25
Dibromochloromethane	50	< 10	< 25	< 25	< 5	< 25	< 25
Dichlorodifluoromethane (Freon 12)	5	< 10	< 25	< 25	< 5	< 25	< 25
Ethylbenzene	5	< 10	< 25 B	< 25	< 5	< 25	< 25
Methyl tert-Butyl Ether	5	--	--	--	--	< 25	< 25
Methylene Chloride	5	< 10	< 25	< 25	< 5	< 25	< 25 B
Styrene	5	< 10	< 25	< 25	< 5	< 25	< 25
Tetrachloroethene	5	1.5 J	< 25	< 25	0.64 J	< 25	< 25
Toluene	5	< 10	< 25 B	< 25	< 5	< 25	< 25
trans-1,2-dichloroethene	5	2.4 J	8.9 J	110	2.5 J	3.9 J	1.3 J
trans-1,3-dichloropropene	0.4	< 10	< 25	< 25	< 5	< 25	< 25
Trichloroethene	5	180	470	22 J	170	45	43
Trichlorotrifluoroethane (Freon 113)	5	< 10	< 25	< 25	< 5	< 25	< 25
Vinyl Chloride	2	4.1	300	180	540 D	220	32
Xylene-o	5	< 10	< 25 B	< 25	8	< 25	< 25
Xylenes - m,p	5	< 10	< 25 B	< 25	< 5	< 25	< 25
Total VOCs ⁽⁴⁾		510	1,700	2,100	1,500	860	620
Project VOCs ⁽⁵⁾		510	1,700	2,100	1,500	850	620

See notes on last page.

Table 13. Concentrations of Volatile Organic Compounds in Groundwater Samples Collected from Monitoring Wells, Groundwater Interim Remedial Measure, Operable Unit 3 (Former Grumman Settling Ponds), Bethpage, New York. ^(1,2,3)

COMPOUND (ug/L)	Sample Location: <i>BCPMW-4-1</i> Sample Date: <i>10/3/2012</i>	<i>BCPMW-4-2</i> <i>4/17/2009</i>	<i>BCPMW-4-2</i> <i>12/4/2009</i>	<i>BCPMW-4-2</i> <i>10/7/2010</i>	<i>BCPMW-4-2</i> <i>10/28/2011</i>	<i>BCPMW-4-2</i> <i>10/3/2012</i>	
	NYSDEC SCGs						
1,1,1-Trichloroethane	5	29	< 250	< 10	< 5	0.33 J	0.23 J
1,1,2,2-Tetrachloroethane	5	< 25	< 250	< 10	< 5	< 5	< 5
1,1,2-Trichloroethane	1	1.7 J	< 250	< 10	< 5	< 5	< 5
1,1-Dichloroethane	5	39	57 J	8.7 J	7.3	2.6 J	1.4 J
1,1-Dichloroethene	5	24 J	34 J	2.7 J	1.9 J	1.1 J	0.8 J
1,2-Dichloroethane	0.6	4.8 J	< 250	< 10	0.91 J	0.85 J	0.45 J
1,2-Dichloropropane	1	5.1 J	< 250	< 10	0.9 J	0.39 J	< 5
2-Butanone	NE	< 250	< 2500	< 100	< 50	< 50	< 50
2-Hexanone	50	< 250	< 2500 J	< 100	< 50	< 50	< 50
4-methyl-2-pentanone	50	< 250	< 2500 J	< 100	< 50	< 50	< 50
Acetone	NE	< 250	< 2500 J	< 100	< 50 B	< 50	< 50
Benzene	1	< 3.5	< 35	< 1.4	< 0.7	< 0.7 U	< 0.7
Bromodichloromethane	50	< 25	< 250	< 10	< 5	< 5	< 5
Bromoform	50	< 25	< 250	< 10	< 5	< 5	< 5
Bromomethane	5	< 25	< 250	< 10	< 5	< 5	< 5
Carbon Disulfide	60	< 25	< 250	< 10	< 5	< 5	< 5
Carbon tetrachloride	5	< 25	< 250	< 10	< 5	< 5	< 5
Chlorobenzene	5	< 25	< 250	< 10	< 5	< 5	< 5
Chlorodifluoromethane (Freon 22)	NE	< 25	< 250	0.8 J	< 5	< 5	< 5
Chloroethane	5	1.6 J	< 250	1.1 J	0.79 J	< 5	< 5
Chloroform	7	< 25	< 250	< 10	0.96 J	0.62 J	0.54 J
Chloromethane	5	< 25	< 250	R	< 5	< 5	< 5
cis-1,2-dichloroethene	5	840	18000 D	270	99	59	70
cis-1,3-dichloropropene	0.4	< 25	< 250	< 10	< 5	< 5	< 5
Dibromochloromethane	50	< 25	< 250	< 10	< 5	< 5	< 5
Dichlorodifluoromethane (Freon 12)	5	< 25	< 250	< 10	< 5	< 5	< 5
Ethylbenzene	5	< 25	62 J	0.78 J	< 5	< 5	< 5
Methyl tert-Butyl Ether	5	< 25	--	--	0.35 J	0.28 J	0.29 J
Methylene Chloride	5	< 25	< 250	< 10	< 5	< 5	< 5
Styrene	5	< 25	< 250	< 10	< 5	< 5	< 5
Tetrachloroethene	5	< 25	< 250	0.82 J	0.73 J	0.59 J	0.91 J
Toluene	5	< 25	2400	< 10 B	< 5	< 5	< 5
trans-1,2-dichloroethene	5	2.2 J	< 250	1.3 J	0.65 J	0.41 J	0.5 J
trans-1,3-dichloropropene	0.4	< 25	< 250	< 10	< 5	< 5	< 5
Trichloroethene	5	110	< 250	310	66	50	68
Trichlorotrifluoroethane (Freon 113)	5	< 25	< 250	< 10	< 5	< 5	< 5
Vinyl Chloride	2	420	6300	58	54	20	9.5
Xylene-o	5	< 25	110 J	< 10 B	< 5	< 5	< 5
Xylenes - m,p	5	< 25	190 J	< 10 B	< 5	< 5	< 5
Total VOCs ⁽⁴⁾		1,500	27,000	660	230	140	150
Project VOCs ⁽⁵⁾		1,500	27,000	650	230	130	150

See notes on last page.

Table 13. Concentrations of Volatile Organic Compounds in Groundwater Samples Collected from Monitoring Wells, Groundwater Interim Remedial Measure, Operable Unit 3 (Former Grumman Settling Ponds), Bethpage, New York. ^(1,2,3)

COMPOUND (ug/L)	Sample Location: BCPMW-4-3 BCPMW-4-3 BCPMW-4-3 BCPMW-4-3 BCPMW-4-3 BCPMW-5-1						
	Sample Date:	4/17/2009	12/1/2009	10/7/2010	10/28/2011	10/3/2012	4/23/2009
	NYSDEC SCGs						
1,1,1-Trichloroethane	5	< 5	< 5	< 5	< 5	< 5	< 100
1,1,2,2-Tetrachloroethane	5	< 5	< 5	< 5	< 5	< 5	< 100
1,1,2-Trichloroethane	1	< 5	< 5	< 5	< 5	< 5	< 100
1,1-Dichloroethane	5	< 5	< 5	< 5	< 5	< 5	< 100
1,1-Dichloroethene	5	< 5	< 5	< 5	< 5	< 5	21 J
1,2-Dichloroethane	0.6	< 5	< 5	< 5	< 5	< 5	< 100
1,2-Dichloropropane	1	< 5	< 5	< 5	< 5	< 5	< 100
2-Butanone	NE	< 50	< 50	< 50	< 50	< 50	< 1000
2-Hexanone	50	< 50 J	< 50	< 50	< 50	< 50	< 1000
4-methyl-2-pentanone	50	< 50 J	< 50	< 50	< 50	< 50	< 1000
Acetone	NE	< 50 J	< 50	< 50	< 50	< 50	< 1000
Benzene	1	< 0.7	< 0.7	< 0.7	< 0.7	< 0.7	< 14
Bromodichloromethane	50	< 5	< 5	< 5	< 5	< 5	< 100
Bromoform	50	< 5	< 5	< 5	< 5	< 5	< 100
Bromomethane	5	< 5	< 5	< 5	< 5	< 5	< 100
Carbon Disulfide	60	< 5	< 5	< 5	< 5	< 5	< 100
Carbon tetrachloride	5	< 5	< 5	< 5	< 5	< 5	< 100
Chlorobenzene	5	< 5	< 5	< 5	< 5	< 5	< 100
Chlorodifluoromethane (Freon 22)	NE	< 5	< 5	< 5	< 5	< 5	< 100
Chloroethane	5	< 5	< 5	< 5	< 5	< 5	< 100
Chloroform	7	0.53 J	0.32 J	< 5	< 5	0.2 J	< 100
Chloromethane	5	< 5	R	< 5	< 5	< 5	< 100
cis-1,2-dichloroethene	5	0.37 J	< 5	< 5	< 5	< 5	960
cis-1,3-dichloropropene	0.4	< 5	< 5	< 5	< 5	< 5	< 100
Dibromochloromethane	50	< 5	< 5	< 5	< 5	< 5	< 100
Dichlorodifluoromethane (Freon 12)	5	< 5	< 5	< 5	< 5	< 5	< 100
Ethylbenzene	5	< 5	< 5	< 5	< 5	< 5	48 J
Methyl tert-Butyl Ether	5	--	--	< 5	< 5	< 5	--
Methylene Chloride	5	< 5	< 5	< 5	< 5	< 5	< 100
Styrene	5	< 5	< 5	< 5	< 5	< 5	< 100
Tetrachloroethene	5	< 5	< 5	< 5	0.27 J	0.3 J	< 100
Toluene	5	< 5	< 5	< 5	< 5	< 5	2700
trans-1,2-dichloroethene	5	< 5	< 5	< 5	< 5	< 5	< 100
trans-1,3-dichloropropene	0.4	< 5	< 5	< 5	< 5	< 5	< 100
Trichloroethene	5	0.56 J	0.51 J	0.41 J	0.74 J	0.84 J	220
Trichlorotrifluoroethane (Freon 113)	5	< 5	< 5	< 5	0.38 J	< 5	< 100
Vinyl Chloride	2	< 2	< 2	< 2	< 2	< 2	330
Xylene-o	5	< 5	< 5	< 5	< 5	< 5	40 J
Xylenes - m,p	5	< 5	< 5	< 5	< 5	< 5	110
Total VOCs ⁽⁴⁾		1.5	0.83	0.41	1.4	1.3	4,400
Project VOCs ⁽⁵⁾		0.93	0.51	0.41	1.0	1.1	4,400

See notes on last page.

Table 13. Concentrations of Volatile Organic Compounds in Groundwater Samples Collected from Monitoring Wells, Groundwater Interim Remedial Measure, Operable Unit 3 (Former Grumman Settling Ponds), Bethpage, New York. ^(1,2,3)

COMPOUND (ug/L)	Sample Location: BCPMW-6-1					
	Sample Date: 4/20/2009	12/4/2009	10/6/2010	10/31/2011	BCPMW-6-1 10/3/2012	
	NYSDEC SCGs					
1,1,1-Trichloroethane	5	< 5	< 5	< 100	< 250	< 100
1,1,2,2-Tetrachloroethane	5	< 5	< 5	< 100	< 250	< 100
1,1,2-Trichloroethane	1	< 5	< 5	< 100	< 250	< 100
1,1-Dichloroethane	5	0.3 J	< 5	< 100	< 250	< 100
1,1-Dichloroethene	5	< 5	< 5	< 100	< 250	< 100
1,2-Dichloroethane	0.6	< 5	< 5	< 100	< 250	< 100
1,2-Dichloropropane	1	< 5	< 5	< 100	< 250	< 100
2-Butanone	NE	< 50	< 50	< 1000	< 2500	< 1000
2-Hexanone	50	< 50 J	< 50	< 1000	< 2500	< 1000
4-methyl-2-pentanone	50	< 50 J	< 50	< 1000	< 2500	< 1000
Acetone	NE	< 50 J	< 50	< 1000	< 2500	< 1000
Benzene	1	< 0.7	< 0.7	< 14	< 35	< 14
Bromodichloromethane	50	< 5	< 5	< 100	< 250	< 100
Bromoform	50	< 5	< 5	< 100	< 250	< 100
Bromomethane	5	< 5	R	< 100	< 250	< 100
Carbon Disulfide	60	< 5	< 5	< 100	< 250	< 100
Carbon tetrachloride	5	< 5	< 5	< 100	< 250	< 100
Chlorobenzene	5	< 5	< 5	< 100	< 250	< 100
Chlorodifluoromethane (Freon 22)	NE	4500 D	1700 EJ	10000 D	7100	2100
Chloroethane	5	< 5	< 5	< 100	< 250	< 100
Chloroform	7	1.7 J	0.32 J	< 100	< 250	< 100
Chloromethane	5	< 5	R	< 100	< 250	< 100
cis-1,2-dichloroethene	5	21	1.7 J	< 100	< 250	< 100
cis-1,3-dichloropropene	0.4	< 5	< 5	< 100	< 250	< 100
Dibromochloromethane	50	< 5	< 5	< 100	< 250	< 100
Dichlorodifluoromethane (Freon 12)	5	< 5	< 5	< 100	< 250	< 100
Ethylbenzene	5	< 5	< 5	< 100	< 250	< 100
Methyl tert-Butyl Ether	5	--	--	< 100	< 250	< 100
Methylene Chloride	5	< 5	< 5	< 100	< 250	< 100
Styrene	5	< 5	< 5	< 100	< 250	< 100
Tetrachloroethene	5	0.34 J	< 5	< 100	< 250	< 100
Toluene	5	< 5	< 5	< 100	< 250	< 100
trans-1,2-dichloroethene	5	< 5	< 5	< 100	< 250	< 100
trans-1,3-dichloropropene	0.4	< 5	< 5	< 100	< 250	< 100
Trichloroethene	5	4.9 J	1.6 J	< 100	< 250	< 100
Trichlorotrifluoroethane (Freon 113)	5	< 5	< 5	< 100	< 250	< 100
Vinyl Chloride	2	< 2	< 2	< 40	< 100	< 40
Xylene-o	5	< 5	< 5	< 100	< 250	< 100
Xylenes - m,p	5	< 5	< 5	< 100	< 250	< 100
Total VOCs ⁽⁴⁾		4,500	1,700	10,000	7,100	2,100
Project VOCs ⁽⁵⁾		27	2.3	0	0	0

See notes on last page.

Table 13. Concentrations of Volatile Organic Compounds in Groundwater Samples Collected from Monitoring Wells, Groundwater Interim Remedial Measure, Operable Unit 3 (Former Grumman Settling Ponds), Bethpage, New York. ^(1,2,3)

COMPOUND (ug/L)	Sample Location: Sample Date:	BCPMW-6-2 5/8/2009	BCPMW-6-2 12/4/2009	BCPMW-6-2 10/6/2010	BCPMW-6-2 10/31/2011	BCPMW-6-2 10/3/2012
	NYSDEC SCGs					
1,1,1-Trichloroethane	5	< 5	0.78 J	< 5	< 5	< 5
1,1,2,2-Tetrachloroethane	5	< 5	< 5	< 5	< 5	< 5
1,1,2-Trichloroethane	1	< 5	< 5	< 5	< 5	< 5
1,1-Dichloroethane	5	0.37 J	0.65 J	0.47 J	0.41 J	0.23 J
1,1-Dichloroethene	5	< 5	0.44 J	< 5	0.3 J	< 5
1,2-Dichloroethane	0.6	< 5	< 5	< 5	< 5	< 5
1,2-Dichloropropane	1	< 5	< 5	< 5	< 5	< 5
2-Butanone	NE	< 50	< 50	< 50	< 50	< 50
2-Hexanone	50	< 50	< 50	< 50	< 50	< 50
4-methyl-2-pentanone	50	< 50	< 50	< 50	< 50	< 50
Acetone	NE	< 50	< 50	< 50	< 50	< 50
Benzene	1	< 0.7	< 0.7	< 0.7	< 0.7	< 0.7
Bromodichloromethane	50	< 5	< 5	< 5	< 5	< 5
Bromoform	50	< 5	< 5	< 5	< 5	< 5
Bromomethane	5	< 5	R	< 5	< 5	< 5
Carbon Disulfide	60	< 5	< 5	< 5	< 5	< 5
Carbon tetrachloride	5	< 5	< 5	< 5	< 5	< 5
Chlorobenzene	5	< 5	< 5	< 5	< 5	< 5
Chlorodifluoromethane (Freon 22)	NE	< 5	< 5	< 5	< 5	0.64 J
Chloroethane	5	< 5	< 5	< 5	< 5	< 5
Chloroform	7	0.53 J	< 5	0.41 J	0.3 J	0.38 J
Chloromethane	5	< 5	R	< 5	< 5	< 5
cis-1,2-dichloroethene	5	< 5	< 5	< 5	< 5	< 5
cis-1,3-dichloropropene	0.4	< 5	< 5	< 5	< 5	< 5
Dibromochloromethane	50	< 5	< 5	< 5	< 5	< 5
Dichlorodifluoromethane (Freon 12)	5	< 5	< 5	< 5	< 5	< 5
Ethylbenzene	5	< 5	< 5	< 5	< 5	< 5
Methyl tert-Butyl Ether	5	--	--	< 5	0.33 J	0.24 J
Methylene Chloride	5	< 5	< 5	< 5	< 5	< 5
Styrene	5	< 5	< 5	< 5	< 5	< 5
Tetrachloroethene	5	< 5	0.79 J	2.1 J	1.8 J	1.6 J
Toluene	5	< 5	< 5	< 5	< 5	< 5
trans-1,2-dichloroethene	5	< 5	< 5	< 5	< 5	< 5
trans-1,3-dichloropropene	0.4	< 5	< 5	< 5	< 5	< 5
Trichloroethene	5	< 5	0.45 J	< 5	< 5	< 5
Trichlorotrifluoroethane (Freon 113)	5	< 5	< 5	< 5	< 5	< 5
Vinyl Chloride	2	< 2	< 2	< 2	< 2	< 2
Xylene-o	5	< 5	< 5	< 5	< 5	< 5
Xylenes - m,p	5	< 5	< 5	< 5	< 5	< 5
Total VOCs ⁽⁴⁾		0.90	3.1	3.0	3.1	3.1
Project VOCs ⁽⁵⁾		0.37	3.1	2.6	2.5	1.8

See notes on last page.

Table 13. Concentrations of Volatile Organic Compounds in Groundwater Samples Collected from Monitoring Wells, Groundwater Interim Remedial Measure, Operable Unit 3 (Former Grumman Settling Ponds), Bethpage, New York. ^(1,2,3)

COMPOUND (ug/L)	Sample Location:	BCPMW-7-1	BCPMW-7-1	BCPMW-7-1	BCPMW-7-1	BCPMW-7-1	MW-200-1
	Sample Date:	4/20/2009	12/1/2009	10/7/2010	11/1/2011	10/4/2012	4/29/2009
	NYSDEC						
	SCGs						
1,1,1-Trichloroethane	5	< 5	< 5	< 5	< 5	< 5	< 5
1,1,2,2-Tetrachloroethane	5	< 5	< 5	< 5	< 5	< 5	< 5
1,1,2-Trichloroethane	1	< 5	< 5	< 5	< 5	< 5	< 5
1,1-Dichloroethane	5	< 5	< 5	< 5	< 5	< 5	0.79 J
1,1-Dichloroethene	5	< 5	< 5	< 5	< 5	< 5	< 5
1,2-Dichloroethane	0.6	< 5	< 5	< 5	< 5	< 5	< 5
1,2-Dichloropropane	1	< 5	< 5	< 5	< 5	< 5	< 5
2-Butanone	NE	< 50	< 50	< 50	< 50	< 50	< 50
2-Hexanone	50	< 50 J	< 50	< 50	< 50	< 50	< 50
4-methyl-2-pentanone	50	< 50 J	< 50	< 50	< 50	< 50	< 50
Acetone	NE	< 50	< 50	< 50	< 50	< 50	< 50 B
Benzene	1	< 0.7	< 0.7	< 0.7	< 0.7	< 0.7	< 0.7
Bromodichloromethane	50	< 5	< 5	< 5	< 5	< 5	< 5
Bromoform	50	< 5	< 5	< 5	< 5	< 5	< 5
Bromomethane	5	< 5	R	< 5	< 5	< 5	< 5
Carbon Disulfide	60	< 5	< 5	< 5	< 5	< 5	< 5
Carbon tetrachloride	5	< 5	< 5	< 5	< 5	< 5	< 5
Chlorobenzene	5	< 5	< 5	< 5	< 5	< 5	< 5
Chlorodifluoromethane (Freon 22)	NE	2.6 J	1.5 J	5.2	9.2	3.6 J	< 5
Chloroethane	5	< 5	< 5	< 5	< 5	< 5	< 5
Chloroform	7	< 5	< 5	< 5	< 5	0.37 J	2.3 J
Chloromethane	5	< 5	R	< 5	< 5	< 5	< 5
cis-1,2-dichloroethene	5	< 5	< 5	< 5	< 5	< 5	38
cis-1,3-dichloropropene	0.4	< 5	< 5	< 5	< 5	< 5	< 5
Dibromochloromethane	50	< 5	< 5	< 5	< 5	< 5	< 5
Dichlorodifluoromethane (Freon 12)	5	< 5	< 5	< 5	< 5	< 5	< 5
Ethylbenzene	5	< 5	< 5	< 5	< 5	< 5	< 5
Methyl tert-Butyl Ether	5	--	--	< 5	0.22 J	0.26 J	--
Methylene Chloride	5	< 5	< 5	< 5	< 5	< 5	< 5
Styrene	5	< 5	< 5	< 5	< 5	< 5	< 5
Tetrachloroethene	5	< 5	< 5	< 5	< 5	< 5	0.54 J
Toluene	5	< 5	< 5	< 5	< 5	< 5	< 5
trans-1,2-dichloroethene	5	< 5	< 5	< 5	< 5	< 5	0.3 J
trans-1,3-dichloropropene	0.4	< 5	< 5	< 5	< 5	< 5	< 5
Trichloroethene	5	< 5	< 5	< 5	< 5	< 5	34
Trichlorotrifluoroethane (Freon 113)	5	< 5	< 5	< 5	< 5	< 5	< 5
Vinyl Chloride	2	< 2	< 2	< 2	< 2	< 2	< 2
Xylene-o	5	< 5	< 5	< 5	< 5	< 5	< 5
Xylenes - m,p	5	< 5	< 5	< 5	< 5	< 5	< 5
Total VOCs ⁽⁴⁾		2.6	1.5	5.2	9.4	4.2	76
Project VOCs ⁽⁵⁾		0.0	0.0	0.0	0.22	0.0	74

See notes on last page.

Table 13. Concentrations of Volatile Organic Compounds in Groundwater Samples Collected from Monitoring Wells, Groundwater Interim Remedial Measure, Operable Unit 3 (Former Grumman Settling Ponds), Bethpage, New York. ^(1,2,3)

COMPOUND (ug/L)	Sample Location: MW-200-1 MW-200-1 MW-200-1 MW-200-1 MW-201-1 MW-201-1 MW-201-1							
	Sample Date: 12/2/2009 10/5/2010 11/3/2011 10/4/2012 5/1/2009 12/2/2009 10/5/2010							
	NYSDEC							
	SCGs							
1,1,1-Trichloroethane	5	< 5	< 5	< 5	< 5	5.5 J	3.3 J	< 50
1,1,2,2-Tetrachloroethane	5	< 5	< 5	< 5	< 5	< 25	< 50	< 50
1,1,2-Trichloroethane	1	< 5	< 5	< 5	< 5	< 25	< 50	< 50
1,1-Dichloroethane	5	< 5	< 5	< 5	< 5	10 J	9 J	14 J
1,1-Dichloroethene	5	< 5	< 5	< 5	< 5	7.9 J	8.1 J	6.9 J
1,2-Dichloroethane	0.6	< 5	< 5	< 5	< 5	< 25	< 50	< 50
1,2-Dichloropropane	1	< 5	< 5	< 5	< 5	< 25	< 50	< 50
2-Butanone	NE	< 50	< 50	< 50	< 50	< 250	< 500	< 500
2-Hexanone	50	< 50	< 50	< 50	< 50	< 250	< 500	< 500
4-methyl-2-pentanone	50	< 50	< 50	< 50	< 50	< 250	< 500	< 500
Acetone	NE	< 50	< 50	< 50	< 50	< 250 B	< 500	< 500
Benzene	1	< 0.7	< 0.7	< 0.7	< 0.7	< 3.5	< 7	< 7
Bromodichloromethane	50	< 5	< 5	< 5	< 5	< 25	< 50	< 50
Bromoform	50	< 5	< 5	< 5	< 5	< 25	< 50	< 50
Bromomethane	5	R	< 5	< 5	< 5	< 25	< 50	< 50
Carbon Disulfide	60	< 5	< 5	< 5	< 5	< 25	< 50	< 50
Carbon tetrachloride	5	< 5	< 5	< 5	< 5	< 25	< 50	< 50
Chlorobenzene	5	< 5	< 5	< 5	< 5	< 25	< 50	< 50
Chlorodifluoromethane (Freon 22)	NE	< 5	< 5	< 5	< 5	< 25	< 50	< 50
Chloroethane	5	< 5	< 5	< 5	< 5	< 25	< 50	< 50
Chloroform	7	2.3 J	0.5 J	0.21 J	< 5	< 25	< 50	4.2 J
Chloromethane	5	R	< 5	< 5	< 5	< 25	R	< 50
cis-1,2-dichloroethene	5	5.7	3.5 J	11	1.5 J	970 D	1300	3900 D
cis-1,3-dichloropropene	0.4	< 5	< 5	< 5	< 5	< 25	< 50	< 50
Dibromochloromethane	50	< 5	< 5	< 5	< 5	< 25	< 50	< 50
Dichlorodifluoromethane (Freon 12)	5	< 5	< 5	< 5	< 5	< 25	< 50	< 50
Ethylbenzene	5	< 5	< 5	< 5	< 5	< 25	< 50	< 50
Methyl tert-Butyl Ether	5	--	< 5	< 5	< 5	--	--	< 50
Methylene Chloride	5	< 5	< 5	< 5	< 5	< 25	< 50	< 50
Styrene	5	< 5	< 5	< 5	< 5	< 25	< 50	< 50
Tetrachloroethene	5	< 5	< 5	0.43 J	< 5	< 25	< 50	< 50
Toluene	5	< 5	< 5	< 5	< 5	< 25	< 50	< 50
trans-1,2-dichloroethene	5	< 5	< 5	< 5	< 5	2.7 J	3.5 J	6.7 J
trans-1,3-dichloropropene	0.4	< 5	< 5	< 5	< 5	< 25	< 50	< 50
Trichloroethene	5	12	7	20	3.8 J	160	230	72
Trichlorotrifluoroethane (Freon 113)	5	< 5	< 5	< 5	< 5	< 25	< 50	< 50 U
Vinyl Chloride	2	< 2	< 2	< 2	< 2	< 10	38	820
Xylene-o	5	< 5	< 5	< 5	< 5	< 25	< 50	7.2 J
Xylenes - m,p	5	< 5	< 5	< 5	< 5	< 25	< 50	< 50
Total VOCs ⁽⁴⁾		20	11	32	5.3	1,200	1,600	4,800
Project VOCs ⁽⁵⁾		18	11	31	5.3	1,200	1,600	4,800

See notes on last page.

Table 13. Concentrations of Volatile Organic Compounds in Groundwater Samples Collected from Monitoring Wells, Groundwater Interim Remedial Measure, Operable Unit 3 (Former Grumman Settling Ponds), Bethpage, New York. ^(1,2,3)

COMPOUND (ug/L)	Sample Location: MW-201-1		MW-201-1	MW-202-1	MW-202-1	MW-202-1	MW-202-1
	Sample Date:	11/3/2011	10/4/2012	5/1/2009	12/2/2009	10/6/2010	11/3/2011
	NYSDEC SCGs						
1,1,1-Trichloroethane	5	< 5	< 5	< 5	< 5	< 5	0.32 J
1,1,2,2-Tetrachloroethane	5	< 5	< 5	< 5	< 5	< 5	< 5
1,1,2-Trichloroethane	1	< 5	< 5	< 5	< 5	< 5	< 5
1,1-Dichloroethane	5	0.51 J	1.2 J	< 5	< 5	< 5	0.86 J
1,1-Dichloroethene	5	0.21 J	0.65 J	< 5	< 5	< 5	0.72 J
1,2-Dichloroethane	0.6	< 5	< 5	< 5	< 5	< 5	< 5
1,2-Dichloropropane	1	< 5	< 5	< 5	< 5	< 5	< 5
2-Butanone	NE	< 50	< 50	< 50	< 50	< 50	< 50
2-Hexanone	50	< 50	< 50	< 50	< 50	< 50	< 50
4-methyl-2-pentanone	50	< 50	< 50	< 50	< 50	< 50	< 50
Acetone	NE	< 50	< 50	< 50	< 50	< 50	< 50
Benzene	1	< 0.7	< 0.7	< 0.7	< 0.7	< 0.7	< 0.7
Bromodichloromethane	50	< 5	< 5	< 5	< 5	< 5	< 5
Bromoform	50	< 5	< 5	< 5	< 5	< 5	< 5
Bromomethane	5	< 5	< 5	< 5	< 5	< 5	< 5
Carbon Disulfide	60	< 5	< 5	< 5	< 5	< 5	< 5
Carbon tetrachloride	5	< 5	< 5	< 5	< 5	< 5	< 5
Chlorobenzene	5	< 5	< 5	< 5	< 5	< 5	< 5
Chlorodifluoromethane (Freon 22)	NE	< 5	< 5	< 5	< 5	0.61 J	0.21 J
Chloroethane	5	< 5	< 5	< 5	< 5	< 5	< 5
Chloroform	7	3.2 J	2.9 J	6.2	6.7	0.93 J	< 5
Chloromethane	5	< 5	< 5	< 5	< 5	< 5	< 5
cis-1,2-dichloroethene	5	61	180 D	0.64 J	0.58 J	< 5	< 5
cis-1,3-dichloropropene	0.4	< 5	< 5	< 5	< 5	< 5	< 5
Dibromochloromethane	50	< 5	< 5	< 5	< 5	< 5	< 5
Dichlorodifluoromethane (Freon 12)	5	< 5	< 5	< 5	< 5	< 5	< 5
Ethylbenzene	5	< 5	< 5	< 5	< 5	< 5	< 5
Methyl tert-Butyl Ether	5	0.75 J	0.22 J	--	--	< 5	0.37 J
Methylene Chloride	5	< 5	< 5	< 5	< 5	< 5	< 5
Styrene	5	< 5	< 5	< 5	< 5	< 5	< 5
Tetrachloroethene	5	0.24 J	0.24 J	< 5	< 5	0.48 J	0.92 J
Toluene	5	< 5 J	< 5	< 5	< 5	< 5	< 5
trans-1,2-dichloroethene	5	< 5	0.59 J	< 5	< 5	< 5	< 5
trans-1,3-dichloropropene	0.4	< 5	< 5	< 5	< 5	< 5	< 5
Trichloroethene	5	20	20	7.5	9.3	2.4 J	0.78 J
Trichlorotrifluoroethane (Freon 113)	5	< 5	< 5	< 5	< 5	0.43 J	0.44 J
Vinyl Chloride	2	< 2 U	13	< 2	< 2	< 2	< 2
Xylene-o	5	< 5	< 5	< 5	< 5	< 5	< 5
Xylenes - m,p	5	< 5	< 5	< 5	< 5	< 5	< 5
Total VOCs ⁽⁴⁾		86	220	14	17	4.9	4.6
Project VOCs ⁽⁵⁾		82	220	8.1	9.9	2.9	3.6

See notes on last page.

Table 13. Concentrations of Volatile Organic Compounds in Groundwater Samples Collected from Monitoring Wells, Groundwater Interim Remedial Measure, Operable Unit 3 (Former Grumman Settling Ponds), Bethpage, New York. ^(1,2,3)

COMPOUND (ug/L)	Sample Location:	MW-202-1	MW-203-1	MW-203-1	MW-203-1	MW-203-1	MW-203-1
	Sample Date:	10/4/2012	5/1/2009	12/2/2009	10/5/2010	11/1/2011	10/3/2012
	NYSDEC SCGs						
1,1,1-Trichloroethane	5	0.74 J	< 5	< 5	< 5	< 5	0.26 J
1,1,2,2-Tetrachloroethane	5	< 5	< 5	< 5	< 5	< 5	< 5
1,1,2-Trichloroethane	1	< 5	< 5	< 5	< 5	< 5	< 5
1,1-Dichloroethane	5	2.1 J	< 5	< 5	< 5	0.32 J	1 J
1,1-Dichloroethene	5	1.9 J	< 5	< 5	< 5	< 5	0.44 J
1,2-Dichloroethane	0.6	< 5	< 5	< 5	< 5	< 5	< 5
1,2-Dichloropropane	1	< 5	< 5	< 5	< 5	< 5	< 5
2-Butanone	NE	< 50	< 50	< 50	< 50	< 50	< 50
2-Hexanone	50	< 50	< 50	< 50	< 50	< 50	< 50
4-methyl-2-pentanone	50	< 50	< 50	< 50	< 50	< 50	< 50
Acetone	NE	< 50	< 50 B	< 50	< 50 B	< 50	< 50
Benzene	1	< 0.7	< 0.7	< 0.7	< 0.7	< 0.7	< 0.7
Bromodichloromethane	50	< 5	< 5	< 5	< 5	< 5	< 5
Bromoform	50	< 5	< 5	< 5	< 5	< 5	< 5
Bromomethane	5	< 5	< 5	< 5	< 5	< 5	< 5
Carbon Disulfide	60	< 5	< 5	< 5	< 5	< 5	< 5
Carbon tetrachloride	5	< 5	< 5	< 5	< 5	< 5	< 5
Chlorobenzene	5	< 5	< 5	< 5	< 5	< 5	< 5
Chlorodifluoromethane (Freon 22)	NE	< 5	73	17	29	8.9	3.6 J
Chloroethane	5	< 5	< 5	< 5	< 5	< 5	< 5
Chloroform	7	< 5	7.9	2.6 J	1.5 J	0.68 J	0.36 J
Chloromethane	5	< 5	< 5	< 5	< 5	< 5	< 5
cis-1,2-dichloroethene	5	0.4 J	1.6 J	0.83 J	0.97 J	1.4 J	0.62 J
cis-1,3-dichloropropene	0.4	< 5	< 5	< 5	< 5	< 5	< 5
Dibromochloromethane	50	< 5	< 5	< 5	< 5	< 5	< 5
Dichlorodifluoromethane (Freon 12)	5	< 5	< 5	< 5	< 5	< 5	< 5
Ethylbenzene	5	< 5	< 5	< 5	< 5	< 5	< 5
Methyl tert-Butyl Ether	5	< 5	--	--	0.88 J	0.41 J	0.21 J
Methylene Chloride	5	< 5	< 5	< 5	< 5	< 5	< 5
Styrene	5	< 5	< 5	< 5	< 5	< 5	< 5
Tetrachloroethene	5	1.7 J	< 5	< 5	< 5	0.35 J	0.59 J
Toluene	5	< 5	< 5	< 5	< 5	< 5	< 5
trans-1,2-dichloroethene	5	< 5	< 5	< 5	< 5	< 5	< 5
trans-1,3-dichloropropene	0.4	< 5	< 5	< 5	< 5	< 5	< 5
Trichloroethene	5	1.2 J	1.3 J	0.7 J	1.6 J	2.9 J	1.8 J
Trichlorotrifluoroethane (Freon 113)	5	0.76 J	< 5	< 5	< 5	< 5	1.1 J
Vinyl Chloride	2	< 2	< 2	< 2	< 2	< 2	< 2
Xylene-o	5	< 5	< 5	< 5	< 5	< 5	< 5
Xylenes - m,p	5	< 5	< 5	< 5	< 5	< 5	< 5
Total VOCs ⁽⁴⁾		8.8	84	21	34	15	10
Project VOCs ⁽⁵⁾		8.0	2.9	1.5	2.6	5	4.7

See notes on last page.

Table 13. Concentrations of Volatile Organic Compounds in Groundwater Samples Collected from Monitoring Wells, Groundwater Interim Remedial Measure, Operable Unit 3 (Former Grumman Settling Ponds), Bethpage, New York. ^(1,2,3)

Notes:

- (1) Results validated following protocols specified in Sampling and Analysis Plan in the December 2009 DRAFT OM&M Manual (ARCADIS 2009).
- (2) Samples analyzed for the TCL VOCs using NYSDEC ASP 2000 Method OLM4.2.
- (3) Sampling method changed from 3 well volume purge to HydraSleeve™ no purge method, see Section 6 of this report.
- (4) "Total VOCs" represents the sum of individual concentrations of the VOCs detected.
- (5) "Project VOCs" represents the sum of individual compound concentrations of 1,1,1-Trichloroethane; 1,1-Dichloroethane; 1,2-Dichloroethane; 1,1-Dichloroethene; Tetrachloroethene; Trichloroethene; Vinyl Chloride; cis-1,2-Dichloroethene; trans-1,2-Dichloroethene; Benzene; Toluene; and Xylenes-o,m, and p.

Acronyms\Key:

Indicates an exceedance of an SCG.

Bold value indicates a detection.

Concentration values are rounded to two significant figures.

Italicized samples collected with HydraSleeve™ no purge method.

RI/FS Remedial Investigation/Feasibility Study.

NYSDEC New York State Department of Environmental Conservation.

TCL Target compound list.

VOC Volatile Organic Compound.

ASP Analytical services protocol.

SCGs Standards, criteria, and guidance values.

ug/L Micrograms per liter.

NE Not established.

E Concentration for the constituent exceeded the calibration range.

J Value is estimated.

D Constituent identified from secondary dilution.

R Concentration for the constituent was rejected.

B Compound detected in associated blank sample.

< 5 Compound not detected above its laboratory quantification limit.

Table 14. Concentrations of Metals in Groundwater Samples Collected from Monitoring Wells, Groundwater Interim Remedial Measure, Operable Unit 3 (Former Grumman Settling Ponds), Bethpage, New York. ^(1,2)

COMPOUND (ug/L)	Sample Location: B24MW-2		B24MW-3	BCPMW-1	BCPMW-2	BCPMW-3	BCPMW-4-1	BCPMW-4-1	BCPMW-4-1	BCPMW-4-1	BCPMW-4-1
	Sample Date: 4/23/2009		4/20/2009	4/28/2009	4/28/2009	4/29/2009	4/17/2009	10/4/2010	10/28/2011	10/3/2012	10/4/2012
	NYSDEC SCGs										
Cadmium (total)	5	< 5	< 5	< 5	< 5	< 5	< 5	< 5	< 5	< 5	--
Cadmium (dissolved)	5	< 5	< 5	< 5	< 5	< 5	< 5	< 5	< 5	--	< 5
Chromium (total)	50	40.3	28.2	20.8	< 10	< 10	22.7	43	25	32	--
Chromium (dissolved)	50	< 10	10.6	< 10	< 10	< 10	12.8	41	22	--	26
Iron (total)	300	--	597	--	< 100	2,080	103	--	--	--	--
Iron (dissolved)	300	--	< 100	--	< 100	1,760	< 100	--	--	--	--
Manganese (total)	300	--	16.9	--	12.7	51.4	11.2	--	--	--	--
Manganese (dissolved)	300	--	13.7	--	11.3	49.2	< 10	--	--	--	--

See notes on last page.

Table 14. Concentrations of Metals in Groundwater Samples Collected from Monitoring Wells, Groundwater Interim Remedial Measure, Operable Unit 3 (Former Grumman Settling Ponds), Bethpage, New York. ^(1,2)

COMPOUND (ug/L)	Sample Location: BCPMW-4-2 BCPMW-4-2 BCPMW-4-2 BCPMW-4-2 BCPMW-4-2 BCPMW-4-3 BCPMW-4-3 BCPMW-4-3 BCPMW-4-3 BCPMW-4-3										
	Sample Date:	4/17/2009	10/7/2010	10/28/2011	10/3/2012	10/4/2012	4/17/2009	10/7/2010	10/28/2011	10/3/2012	10/4/2012
	NYSDEC SCGs										
Cadmium (total)	5	< 5	< 5	< 5	< 5	--	< 5	< 5	< 5	< 5	--
Cadmium (dissolved)	5	< 5	--	< 5	--	< 5	< 5	< 5	< 5	--	< 5
Chromium (total)	50	10.6	< 10	< 10	< 10	--	< 10	< 10	< 10	< 10	--
Chromium (dissolved)	50	< 10	--	< 10	--	< 10	< 10	< 10	< 10	--	< 10
Iron (total)	300	4,630	--	--	--	--	< 100	--	--	--	--
Iron (dissolved)	300	4,080	--	--	--	--	< 100	--	--	--	--
Manganese (total)	300	228	--	--	--	--	< 10	--	--	--	--
Manganese (dissolved)	300	217	--	--	--	--	< 10	--	--	--	--

See notes on last page.

Table 14. Concentrations of Metals in Groundwater Samples Collected from Monitoring Wells, Groundwater Interim Remedial Measure, Operable Unit 3 (Former Grumman Settling Ponds), Bethpage, New York. ^(1,2)

COMPOUND (ug/L)	Sample Location: BCPMW-5-1		BCPMW-6-1	BCPMW-6-1	BCPMW-6-1	BCPMW-6-1	BCPMW-6-1	BCPMW-6-1	BCPMW-6-2	BCPMW-6-2	BCPMW-6-2	BCPMW-6-2	BCPMW-6-2
	Sample Date:	4/23/2009	4/20/2009	10/6/2010	10/31/2011	10/3/2012	10/4/2012		5/8/2009	10/6/2010	10/31/2011	10/3/2012	10/4/2012
	NYSDEC SCGs												
Cadmium (total)	5	< 5	< 5	<5	< 5	< 5	--		< 5	<5	<5	< 5	--
Cadmium (dissolved)	5	< 5	< 5	<5	< 5	--	< 5		< 5	<5	<5	< 5	< 5
Chromium (total)	50	< 10	< 10	< 10	14	< 10	--	10.3	<10	<10	<10	< 10	--
Chromium (dissolved)	50	< 10	< 10	<10	< 10	--	< 10		< 10	<10	<10	< 10	< 10
Iron (total)	300	7,420	< 100	--	--	--	--		--	--	--	--	--
Iron (dissolved)	300	6,370	< 100	--	--	--	--		--	--	--	--	--
Manganese (total)	300	145	< 10	--	--	--	--		--	--	--	--	--
Manganese (dissolved)	300	131	< 10	--	--	--	--		--	--	--	--	--

See notes on last page.

Table 14. Concentrations of Metals in Groundwater Samples Collected from Monitoring Wells, Groundwater Interim Remedial Measure, Operable Unit 3 (Former Grumman Settling Ponds), Bethpage, New York. ^(1,2)

COMPOUND (ug/L)	Sample Location: BCPMW-7-1 BCPMW-7-1 BCPMW-7-1 BCPMW-7-1 MW-200-1 MW-200-1 MW-200-1 MW-200-1 ⁽³⁾ MW-200-1 MW-201-1 MW-201-1											
	Sample Date: 4/20/2009 10/7/2010 11/1/2011 10/4/2012 4/29/2009 10/5/2010 11/3/2011 10/4/2012 4/15/2013 5/1/2009 10/5/2010											
	NYSDEC SCGs											
Cadmium (total)	5	< 5	< 5	< 5	< 5	< 5	< 5	< 5	< 5	--	< 5	< 5
Cadmium (dissolved)	5	< 5	< 5	< 5	< 5	< 5	< 5	< 5	< 5	--	< 5	< 5
Chromium (total)	50	< 10	< 10	< 10	< 10	< 10	14	48	1,130	86	< 10	< 10
Chromium (dissolved)	50	< 10	< 10	< 10	< 10	< 10	< 10	13	320	21	< 10	< 10
Iron (total)	300	< 100	--	--	--	--	--	--	--	--	--	--
Iron (dissolved)	300	< 100	--	--	--	--	--	--	--	--	--	--
Manganese (total)	300	106	--	--	--	--	--	--	--	--	--	--
Manganese (dissolved)	300	94.8	--	--	--	--	--	--	--	--	--	--

See notes on last page.

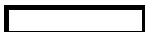

Table 14. Concentrations of Metals in Groundwater Samples Collected from Monitoring Wells, Groundwater Interim Remedial Measure, Operable Unit 3 (Former Grumman Settling Ponds), Bethpage, New York. ^(1,2)

COMPOUND (ug/L)	Sample Location:	MW-201-1	MW-201-1 ⁽³⁾	MW-201-1	MW-202-1	MW-202-1	MW-202-1	MW-202-1 ⁽³⁾	MW-202-1	MW-203-1	MW-203-1	MW-203-1
	Sample Date:	11/3/2011	10/4/2012	4/16/2013	5/1/2009	10/6/2010	11/3/2011	10/4/2012	4/16/2013	5/1/2009	10/5/2010	11/1/2011
	NYSDEC SCGs											
Cadmium (total)	5	< 5	< 5	--	< 5	< 5	< 5	< 5	--	< 5	< 5	< 5
Cadmium (dissolved)	5	< 5	< 5	--	< 5	< 5	< 5	< 5	--	< 5	< 5	< 5
Chromium (total)	50	< 10	159	28	16.5	15	23	263 J	19	31.5	31	37
Chromium (dissolved)	50	< 10	42	17	< 10	< 10	< 10	22	< 10	< 10	< 10	< 10
Iron (total)	300	--	--	--	--	--	--	--	--	--	--	--
Iron (dissolved)	300	--	--	--	--	--	--	--	--	--	--	--
Manganese (total)	300	--	--	--	--	--	--	--	--	--	--	--
Manganese (dissolved)	300	--	--	--	--	--	--	--	--	--	--	--

See notes on last page.

Table 14. Concentrations of Metals in Groundwater Samples Collected from Monitoring Wells, Groundwater Interim Remedial Measure, Operable Unit 3 (Former Grumman Settling Ponds), Bethpage, New York. ^(1,2)

COMPOUND (ug/L)	Sample Location: MW-203-1 ⁽³⁾		
	Sample Date: 10/3/2012	MW-203-1 10/4/2012	MW-203-1 4/16/2013
	NYSDEC SCGs		
Cadmium (total)	5	< 5	--
Cadmium (dissolved)	5	--	< 5
Chromium (total)	50	1,600	--
Chromium (dissolved)	50	--	84
Iron (total)	300	--	--
Iron (dissolved)	300	--	--
Manganese (total)	300	--	--
Manganese (dissolved)	300	--	--

Notes:

- (1) Results validated following protocols specified in Sampling and Analysis Plan in the December 2009 DRAFT OM&M Manual (ARCADIS 2009).
 (2) Samples analyzed for the metals using NYSDEC ASP Method 2000 ILM4.0.
 (3) Samples collected with HydraSleeve™ no purge method, all other samples collected by purge (3-Volume) method.

Acronyms/Key:

Indicates an exceedance of an SCG.

Bold indicates a detection.

RI/FIS Remedial Investigation/Feasibility Study.

NYSDEC New York State Department of Environmental Conservation.

ASP Analytical services protocol.

SCGs Standards, criteria, and guidance values.

ug/L Micrograms per liter.

-- Not analyzed.

< 5 Compound not detected above its laboratory quantification limit.

Figures

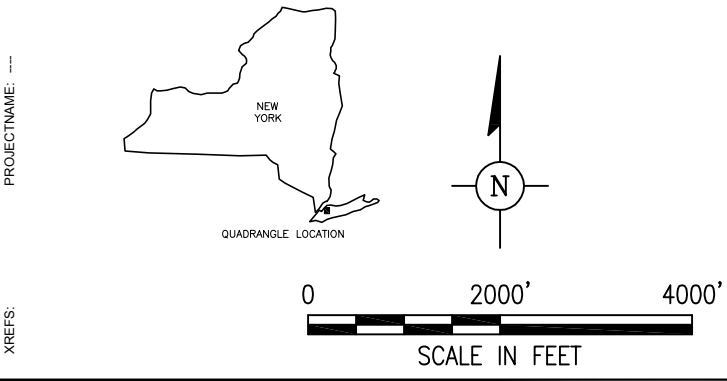
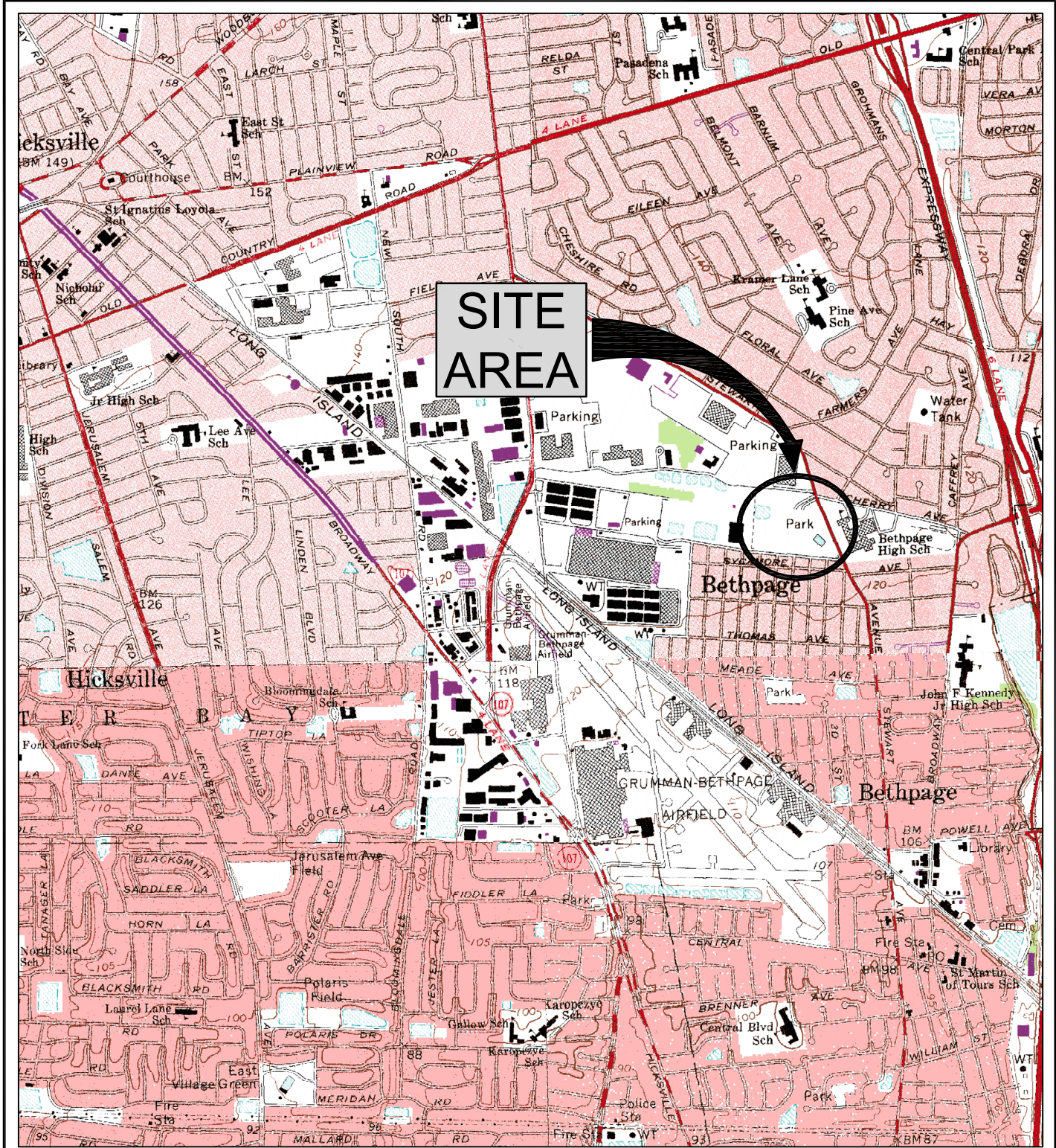

SOURCE:
 USGS 7.5 MIN. AMITYVILLE QUADRANGLE, AMITYVILLE, NY, 1994
 USGS 7.5 MIN. FREEPORT QUADRANGLE, FREEPORT, NY, 1994
 USGS 7.5 MIN. HICKSVILLE QUADRANGLE, HICKSVILLE, NY, 1967, PHOTOREVISED 1979
 USGS 7.5 MIN. HUNTINGTON QUADRANGLE, HUNTINGTON, NY, 1967, PHOTOREVISED 1979

GROUNDWATER INTERIM REMEDIAL MEASURE
 OPERABLE UNIT 3
 (FORMER GRUMMAN SETTLING PONDS)
 BETHPAGE, NEW YORK

SITE AREA LOCATION



FIGURE
1

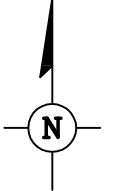
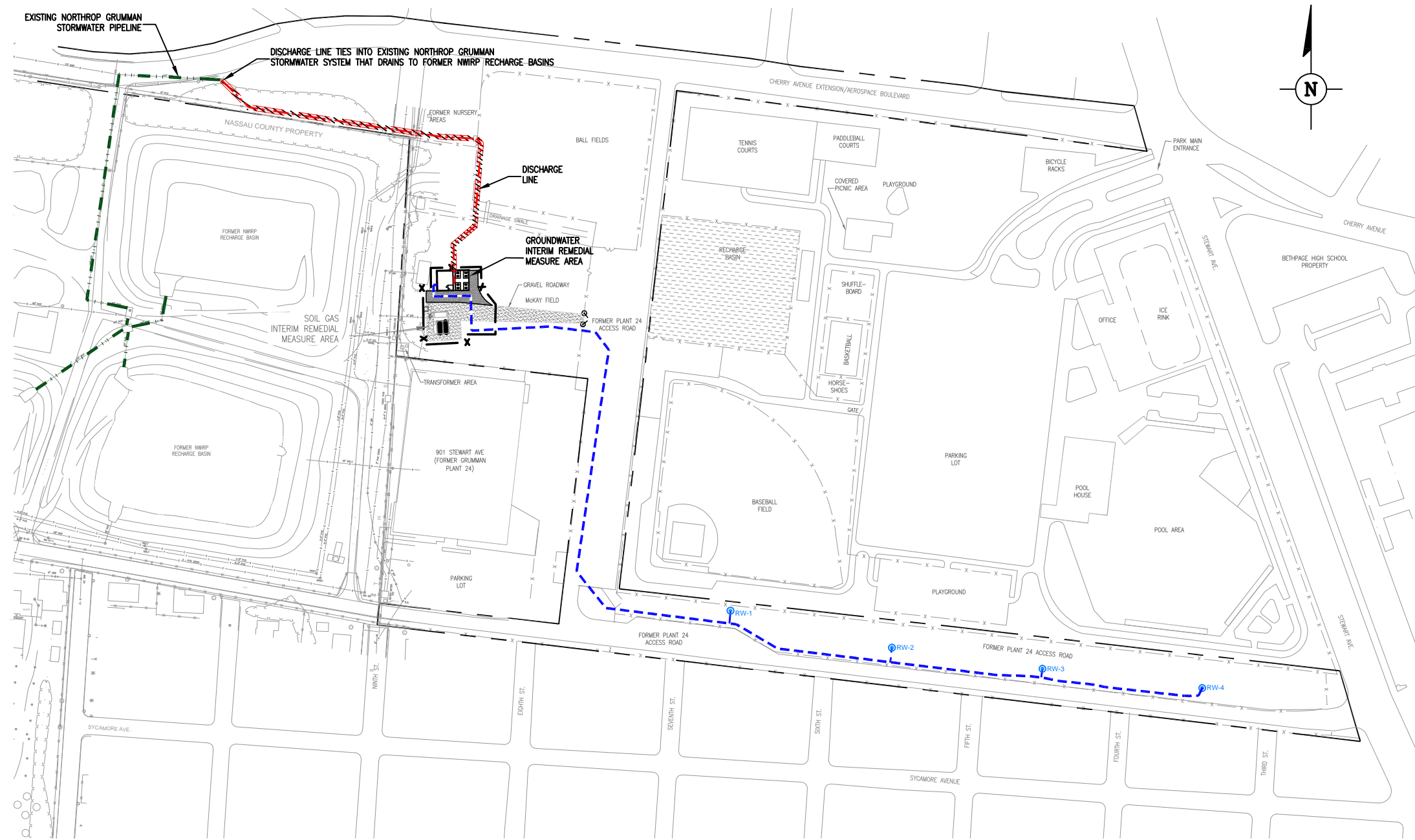

- LEGEND:**
- NORTHROP GRUMMAN PROPERTY LINE
 - X- FENCE
 - b.t. BITUMINOUS PAVEMENT
 - GROUNDWATER IRM INFLUENT PIPELINE AND ELECTRICAL CONDUITS
 - GROUNDWATER IRM EFFLUENT PIPELINE
 - EXISTING NORTHROP GRUMMAN STORMWATER PIPELINE
 - RW-4 GROUNDWATER INTERIM REMEDIAL MEASURE WELL
 - NWIRP NAVAL WEAPONS INDUSTRIAL RESERVE PLANT (NOW OWNED BY NASSAU COUNTY)



GROUNDWATER INTERIM REMEDIAL MEASURE
 OPERABLE UNIT 3
 (FORMER GRUMMAN SETTLING PONDS)
 BETHPAGE, NEW YORK

**SITE AND GROUNDWATER INTERIM
 REMEDIAL MEASURE LAYOUT**

 **ARCADIS**

FIGURE
2



- LEGEND:**
- PROCESS WATER
 - - - PROCESS AIR
 - ⊖ INSTRUMENT
 - SAMPLE PORT
 - ▶ FLOW DIRECTION
 - FM FLOW METER
 - FT FLOW RATE TRANSMITTER
 - PSL PRESSURE VACUUM LOW
 - PT PRESSURE TRANSMITTER
 - PI PRESSURE INDICATOR
 - LSHH LEVEL SWITCH HIGH HIGH
 - LT LEVEL TRANSMITTER
 - TT TEMPERATURE TRANSMITTER
 - TI TEMPERATURE INDICATOR
 - ⑧ PROCESS DESIGNATION
 - WSP WATER SAMPLE PORT
 - VSP VAPOR SAMPLE PORT

PROCESS	①	②	③	④	⑤	⑥	⑦	⑧	⑨	⑩	⑪
Mass Loading (lbs/day)											
Trichloroethene	0.009	0.041	0.082	0.008	0.140	<0.008	0.000	0.140	0.140	<0.014	<0.014
cis -1,2 Dichloroethene	0.007	1.877	0.431	0.030	2.346	<0.008	0.000	2.346	2.346	<0.235	<0.235
Vinyl Chloride	0.000	0.443	0.001	0.000	0.444	<0.003	0.000	0.444	0.444	0.444	<0.044
Flow Rate (gpm)	40	85	85	40	250	250	---	---	---	---	---
Flow Rate (CFM)	---	---	---	---	---	---	1,300 - 1,600	1,300	1,535	1,557	1,581
Pressure (feet of water)	10	10	10	10	8	15	---	---	---	---	---
Pressure (inches of water)	---	---	---	---	---	---	0	- 28 to - 38	12	6	0
pH	6.4	6.4	6.4	6.4	6.4	6.2	---	---	---	---	---
Temperature	55	55	55	55	55	55	10	55	97	95	95
Relative Humidity	---	---	---	---	---	---	20 - 80	100	<50	<50	<50

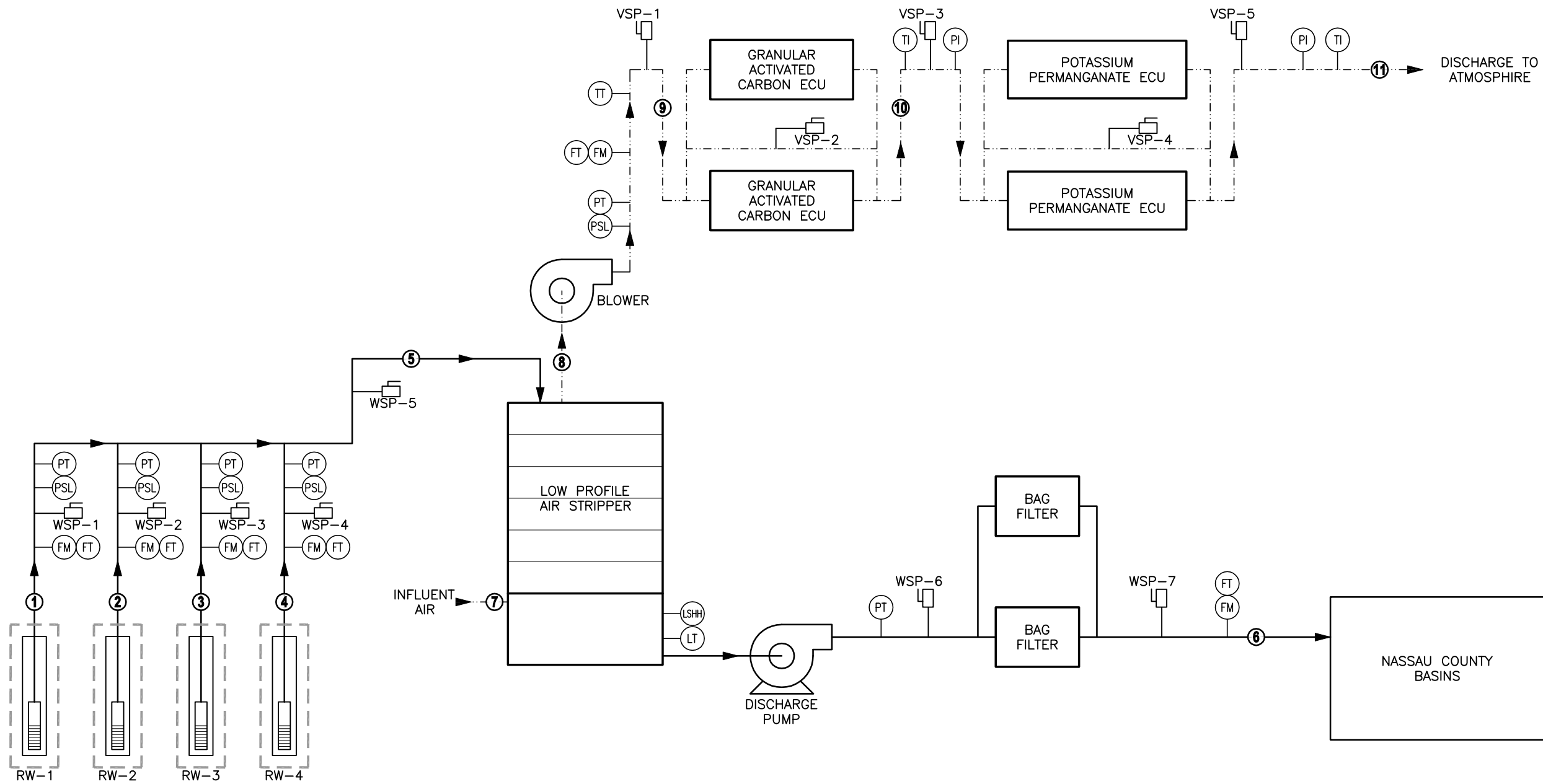
GROUNDWATER INTERIM REMEDIAL MEASURE
OPERABLE UNIT 3
(FORMER GRUMMAN SETTLING PONDS)
BETHPAGE, NEW YORK

**GROUNDWATER TREATMENT SYSTEM
PROCESS SCHEMATIC,
PROCESS FLOW DIAGRAM,
AND MONITORING LOCATIONS**

ARCADIS

FIGURE
3

CITY (Rev) 0 DIV (Rev) 0 DWG (Rev) 0 DB (Rev) 0 LD (Rev) 0 PC (Rev) 0 PM (Rev) 0 TM (Rev) 0 LVR (Rev) 0 OFF (Rev) 0 REF
 G:\ENV\CAD\Manufacturing\RETURN-TO-Service\NY\011861112\GIS\AS-AD\GW\NY186_1112_GWIS\Fig.dwg LAYOUT_4
 XREFS IMAGES PROJECTNAME
 CAD/REV: 18 IS (US TECH) PAGESETUP: PLOTSTYLETABLE: PLOT: PLOTTED: 5/6/2013 5:08 PM BY: HALLWELL TRSH
 SAVED: 5/6/2013 5:08 PM

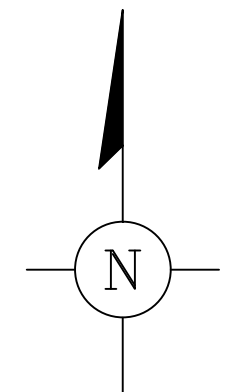
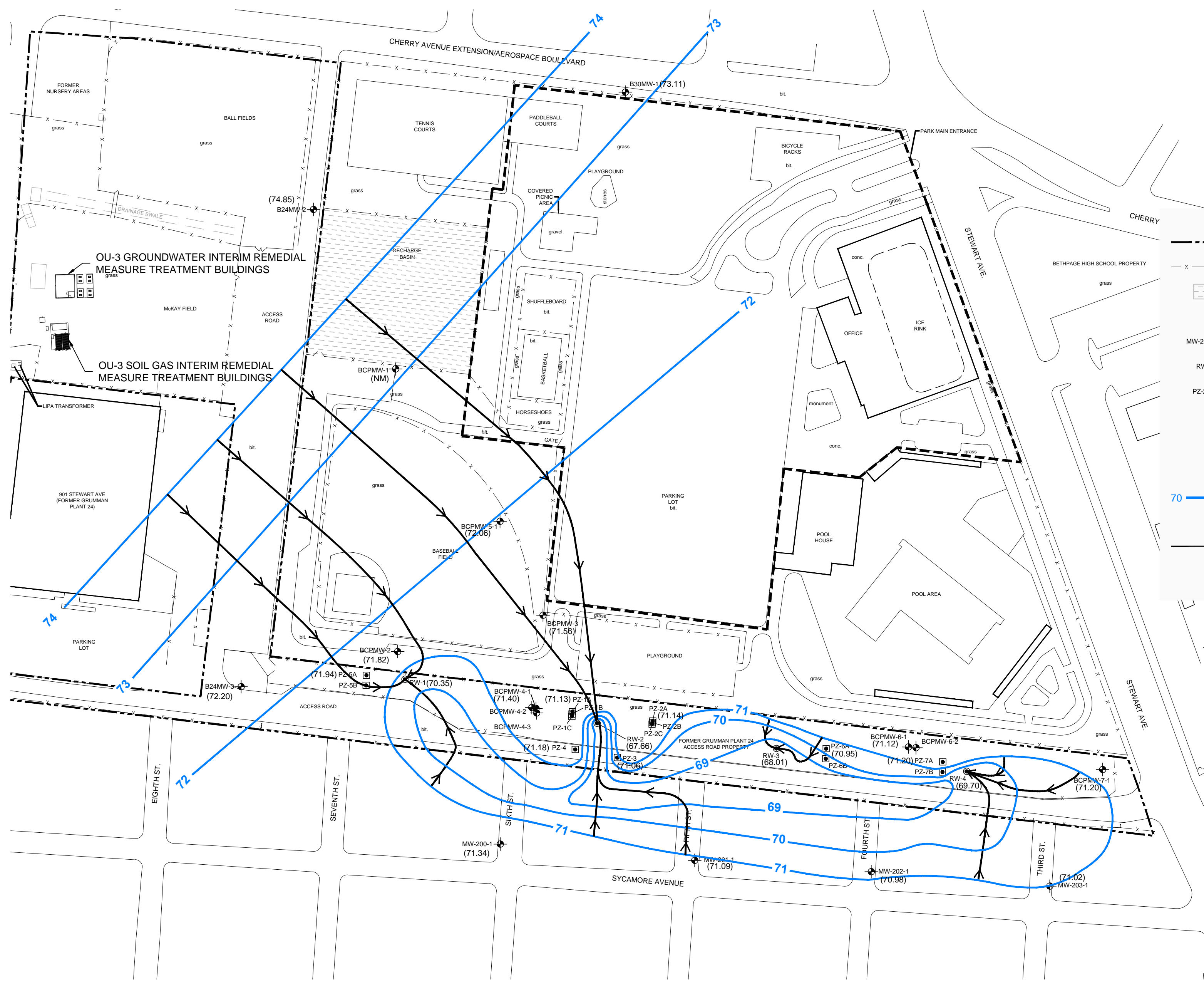

EXPLANATION:

- — — — — NORTHROP GRUMMAN PROPERTY LINE
- x - x - FENCE
- [Hatched Box] BASIN
- bit. BITUMINOUS PAVEMENT
- MW-200-1 [Symbol] MONITORING WELL
- RW-2 [Symbol] RECOVERY WELL
- PZ-2C [Symbol] PIEZOMETER
- (71.82) WATER-LEVEL ELEVATION (FEET MEAN SEA LEVEL)
- (NM) NOT MONITORED
- 70 [Blue Line] GROUNDWATER ELEVATION CONTOUR (RELATIVE TO MEAN SEA LEVEL) (DASHED WHERE WATER LEVEL DATA IS UNAVAILABLE)
- [Arrow] HORIZONTAL COMPONENT OF GROUNDWATER FLOW

- NOTES:**
1. MONITORING WELLS, RECOVERY WELLS, AND PIEZOMETERS SURVEYED TO NORTH AMERICAN DATUM (NAD) 83.
 2. PARK FEATURES SHOWN WERE PRESENT PRIOR TO TOWN OF OYSTER BAY REDEVELOPMENT IN 2005.

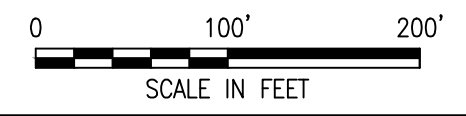

NORTHROP GRUMMAN SYSTEMS CORPORATION
 OPERABLE UNIT 3
 (FORMER GRUMMAN SETTLEMENTS)
 BETHPAGE, NEW YORK

GROUNDWATER MONITORING WELL NETWORK AND CONFIGURATION OF THE SHALLOW POTENTIOMETRIC SURFACE AND GROUNDWATER FLOW DIRECTIONS FIRST QUARTER 2013



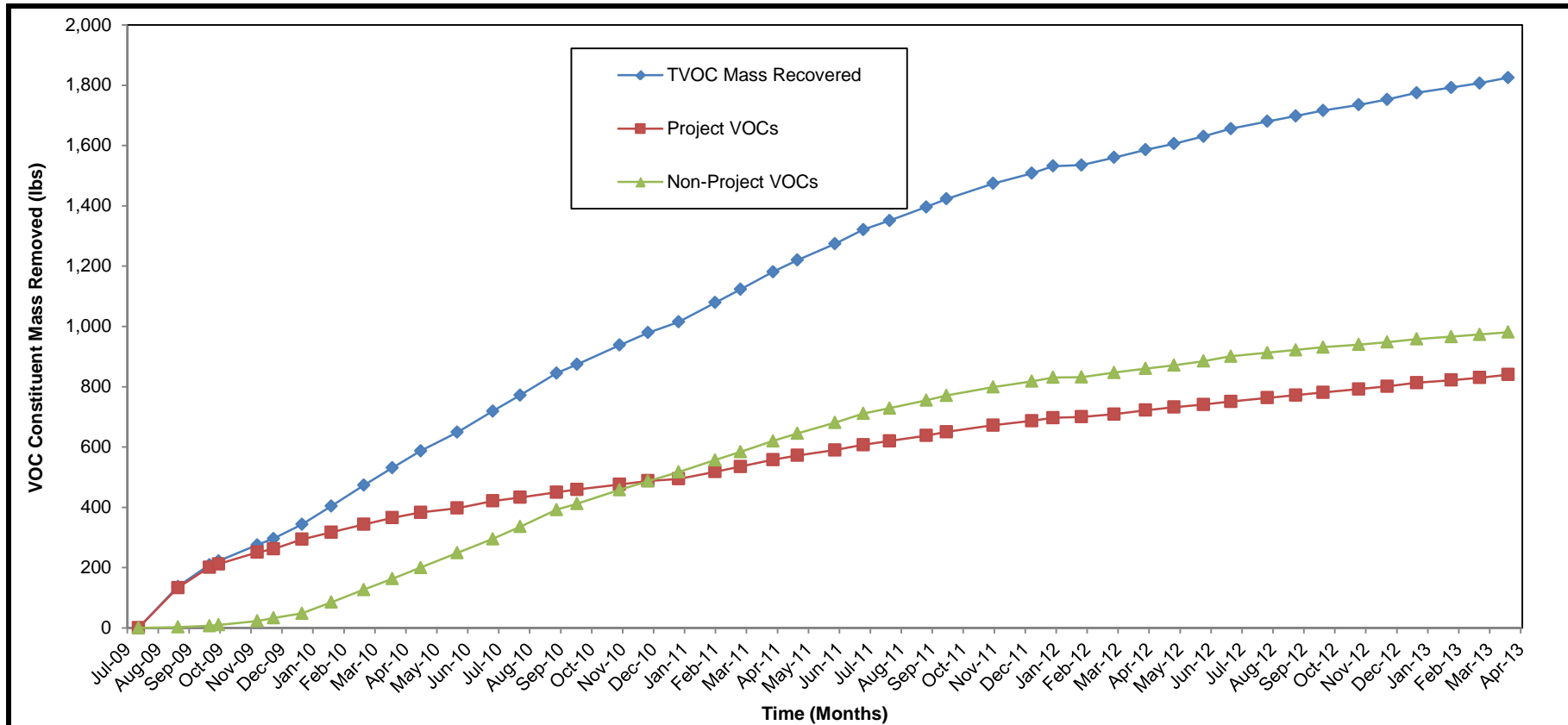

Notes:

VOC = Volatile organic compound.

lbs = Pounds.

Total VOCs = Sum of VOCs detected.

Project VOCs = Sum of 1,1,1-Trichloroethane; 1,1-Dichloroethane; 1,2-Dichloroethane; 1,1-Dichloroethene; Tetrachloroethene; Trichloroethene; Vinyl Chloride; cis-1,2-Dichloroethene; trans-1,2-Dichloroethene; Benzene; Toluene; and Total Xylenes.

Non-Project VOCs = Sum of Total VOCs that are not Project VOCs.

GROUNDWATER INTERIM REMEDIAL MEASURE
 OPERABLE UNIT 3
 (FORMER GRUMMAN SETTLING PONDS)
 BETHPAGE, NEW YORK

**CUMULATIVE TOTAL, PROJECT,
 AND NON-PROJECT VOC MASS
 REMOVED THROUGH
 MARCH 2013**



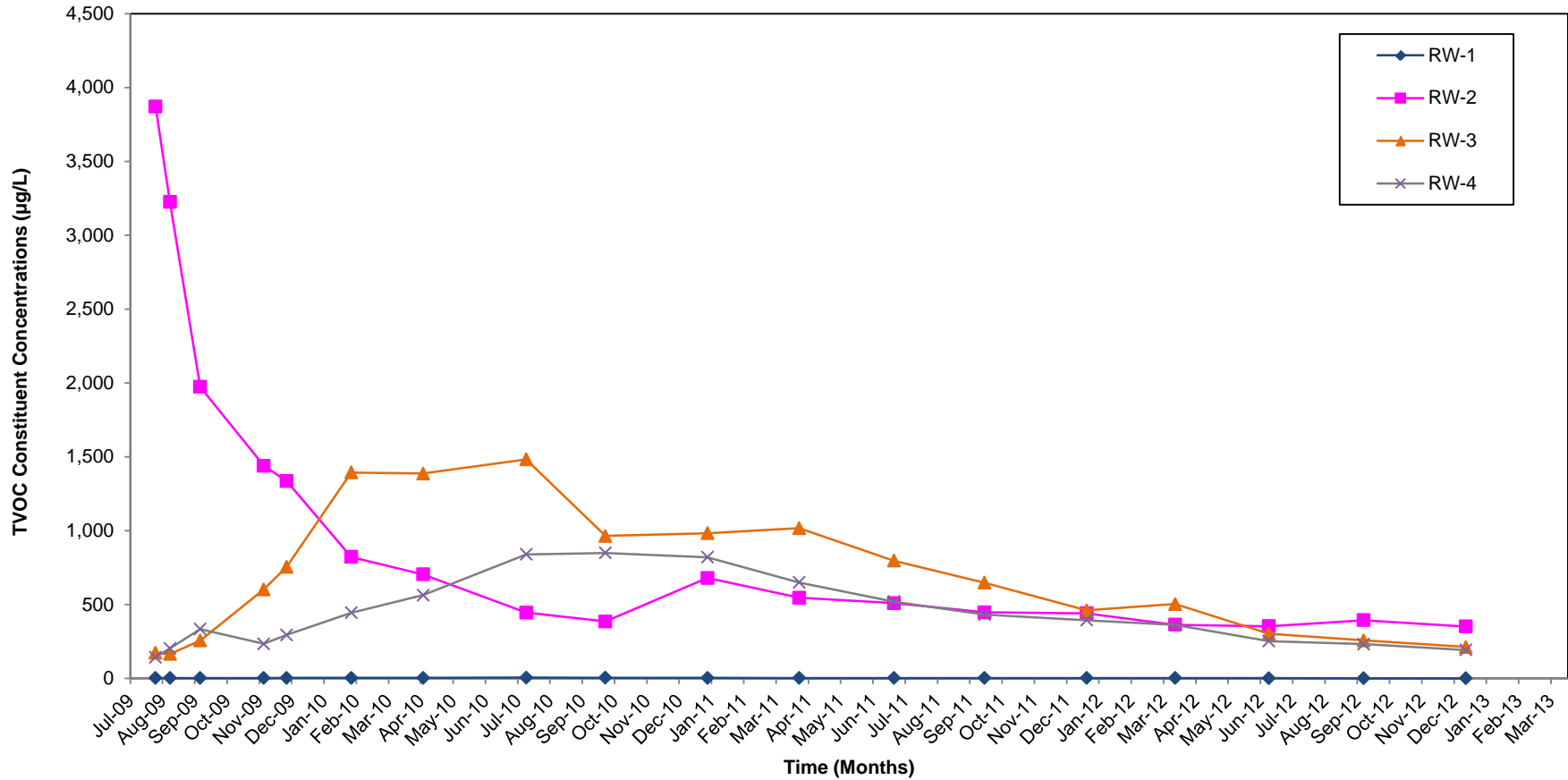

Notes:

VOC = Volatile organic compound.

µg/L = Micrograms per liter.

Total VOCs = Sum of VOCs detected.

GROUNDWATER INTERIM REMEDIAL MEASURE
OPERABLE UNIT 3
(FORMER GRUMMAN SETTLING PONDS)
BETHPAGE, NEW YORK

**REMEDIAL WELL TOTAL VOC
CONCENTRATIONS THROUGH
MARCH 2013**



FIGURE
6A

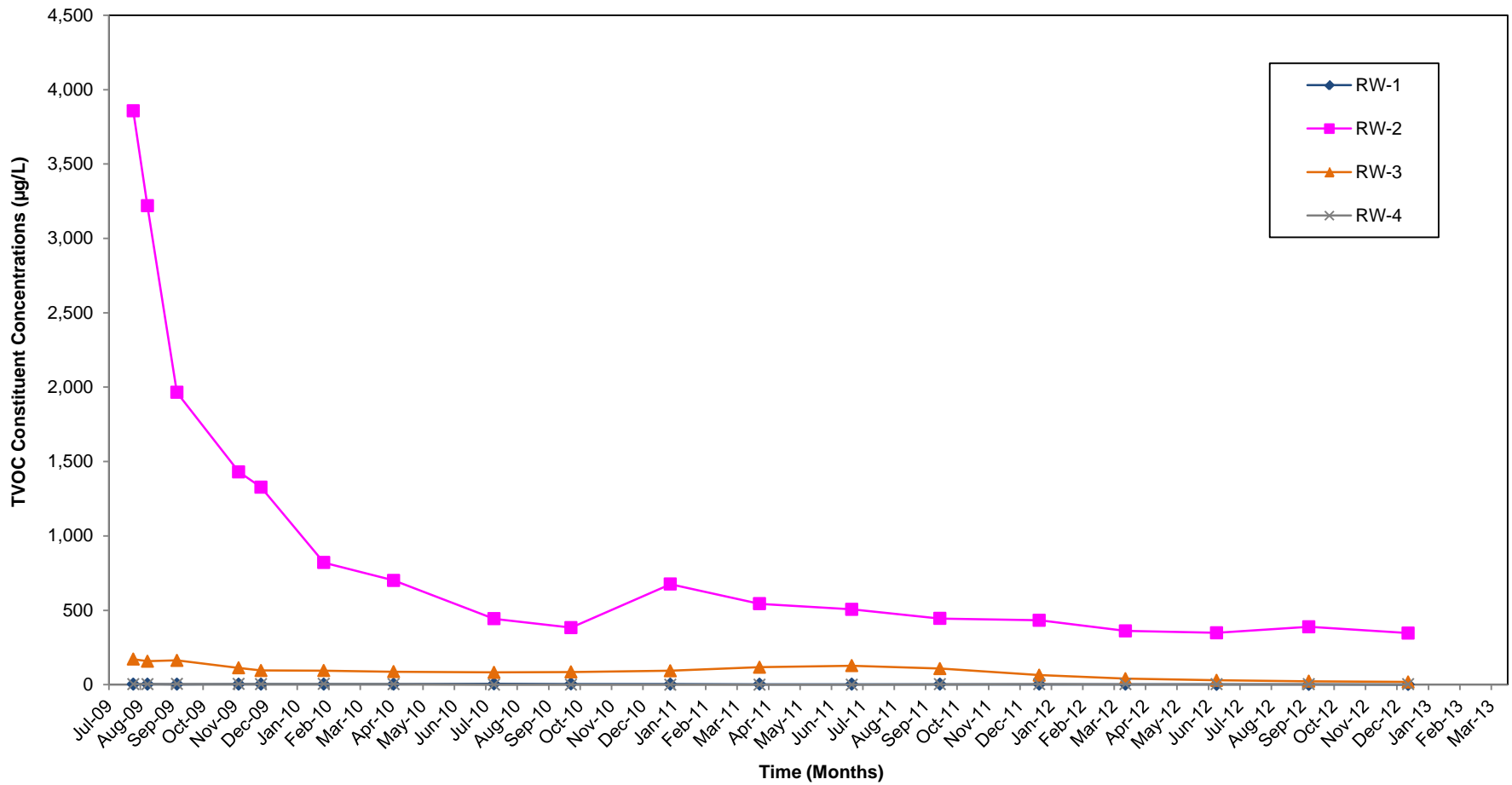

Notes:

VOC = Volatile organic compound.

µg/L = Micrograms per liter.

Project VOCs = Sum of 1,1,1-Trichloroethane; 1,1-Dichloroethane; 1,2- Dichloroethane; 1,1-Dichloroethene; Tetrachloroethene; Trichloroethene; Vinyl Chloride; cis-1,2-Dichloroethene; trans-1,2-Dichloroethene; Benzene; Toluene; and Total Xylenes.

GROUNDWATER INTERIM REMEDIAL MEASURE
 OPERABLE UNIT 3
 (FORMER GRUMMAN SETTLING PONDS)
 BETHPAGE, NEW YORK

**REMEDIAL WELL PROJECT VOC
 CONCENTRATIONS THROUGH
 MARCH 2013**



FIGURE
6B

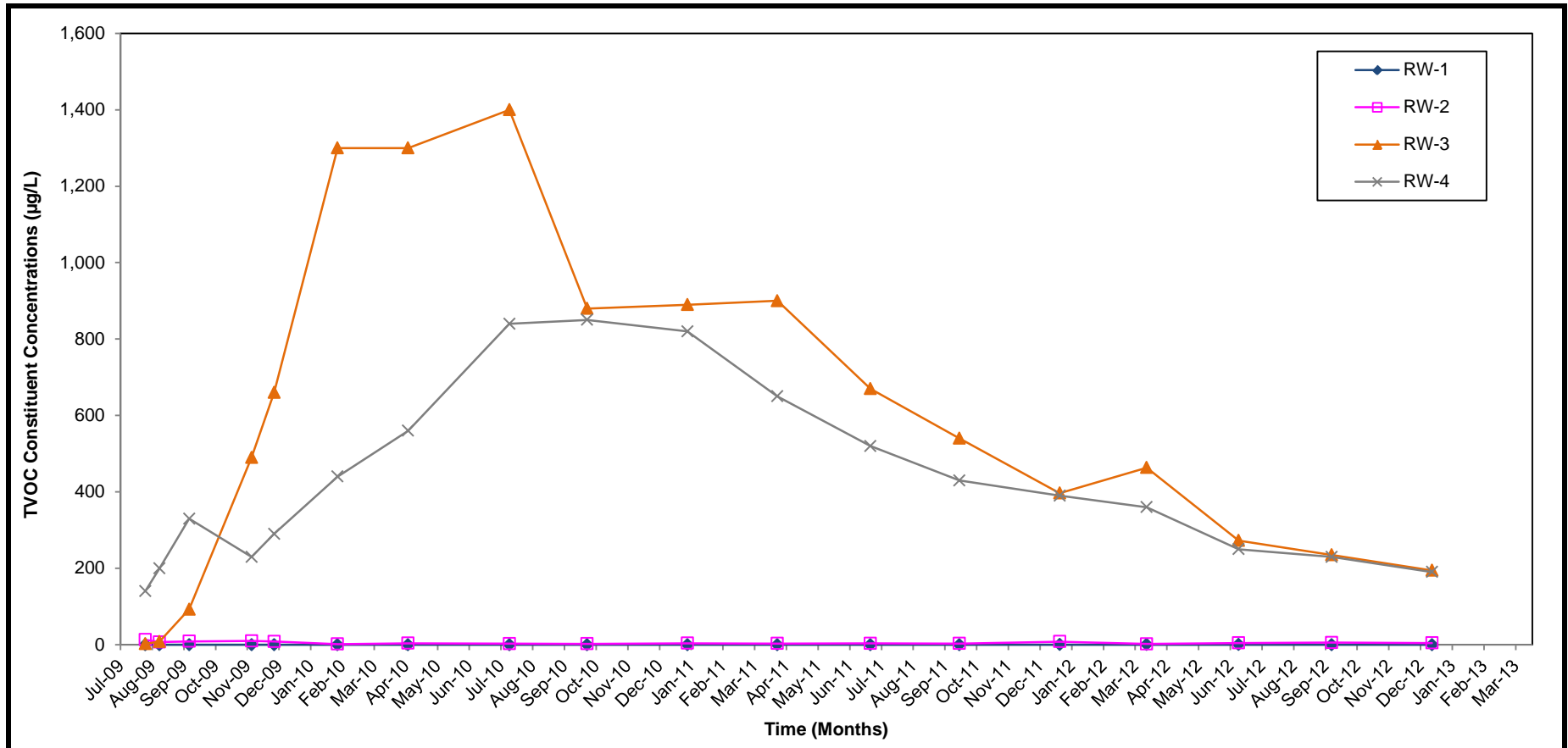

Notes:

VOC = Volatile organic compound.

µg/L = Micrograms per liter.

Non-Project VOCs = Sum of Total VOCs that are not Project VOCs.

GROUNDWATER INTERIM REMEDIAL MEASURE
OPERABLE UNIT 3
(FORMER GRUMMAN SETTLING PONDS)
BETHPAGE, NEW YORK

**REMEDIAL WELL NON-PROJECT
VOC CONCENTRATIONS THROUGH
MARCH 2013**

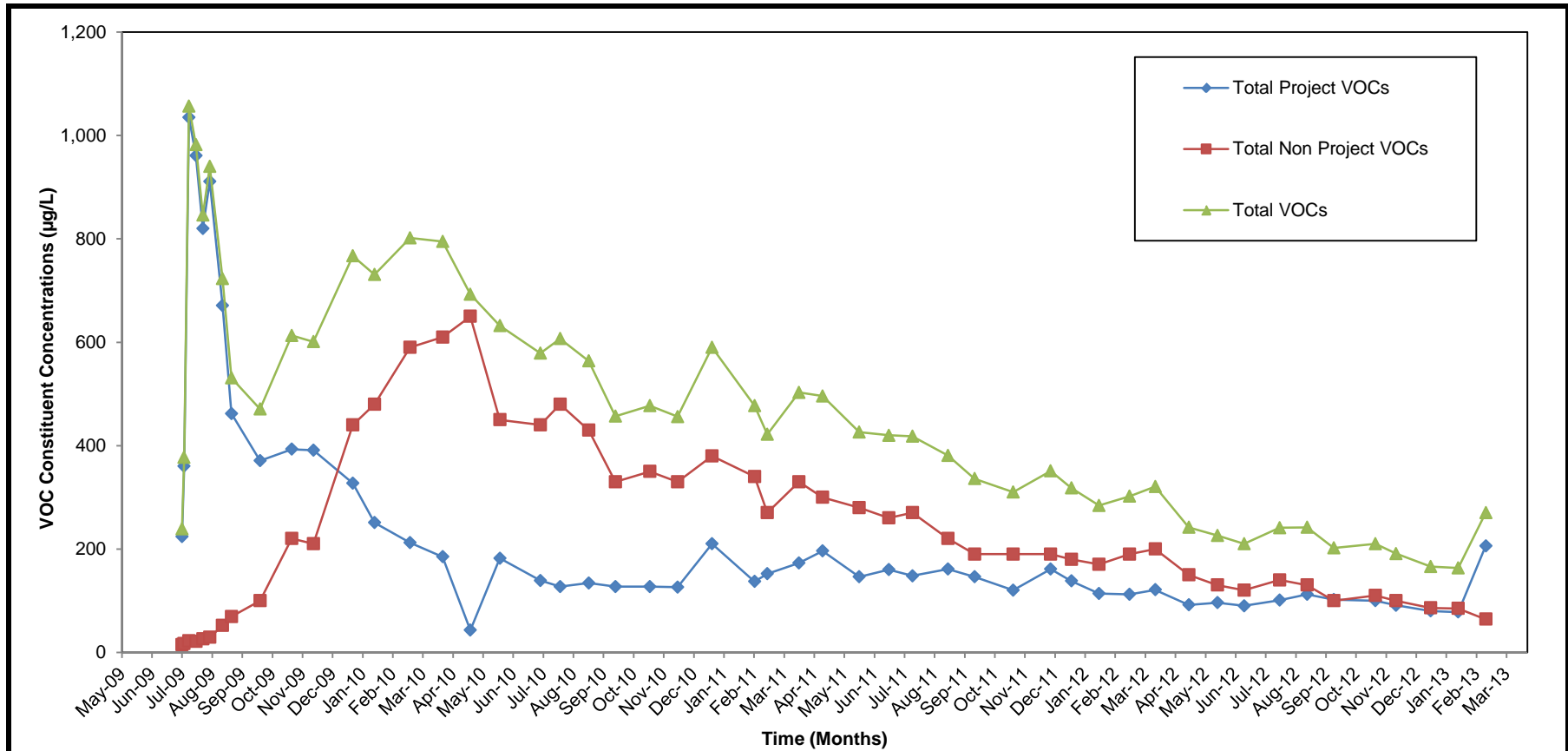

FIGURE
6C



Notes:

VOC = Volatile organic compound.

ug/L = Microgram per liter.

Total VOCs = Sum of VOCs detected.

Project VOCs = Sum of 1,1,1-Trichloroethane; 1,1-Dichloroethane; 1,2-Dichloroethane; 1,1-Dichloroethene; Tetrachloroethene; Trichloroethene; Vinyl Chloride; cis-1,2-Dichloroethene; trans-1,2-Dichloroethene; Benzene; Toluene; and Total Xylenes.

Non-Project VOCs = Sum of Total VOCs that are not Project VOCs.

GROUNDWATER INTERIM REMEDIAL MEASURE OPERABLE UNIT 3 (FORMER GRUMMAN SETTLING PONDS) BETHPAGE, NEW YORK	
INFLUENT TOTAL, PROJECT, AND NON-PROJECT VOC CONCENTRATIONS THROUGH MARCH 2013	
	FIGURE 7

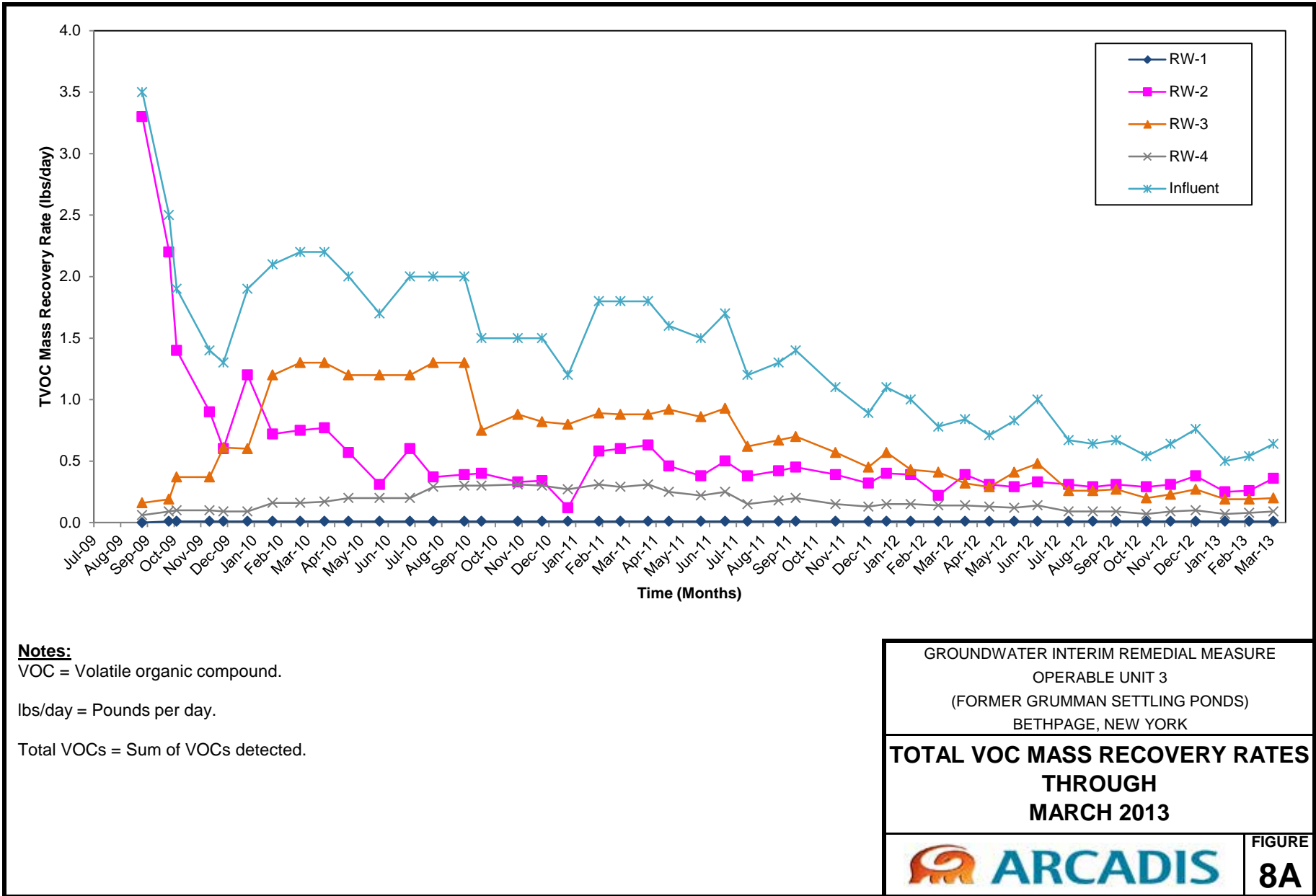

Notes:
 VOC = Volatile organic compound.
 lbs/day = Pounds per day.
 Total VOCs = Sum of VOCs detected.

GROUNDWATER INTERIM REMEDIAL MEASURE
 OPERABLE UNIT 3
 (FORMER GRUMMAN SETTLING PONDS)
 BETHPAGE, NEW YORK

**TOTAL VOC MASS RECOVERY RATES
 THROUGH
 MARCH 2013**

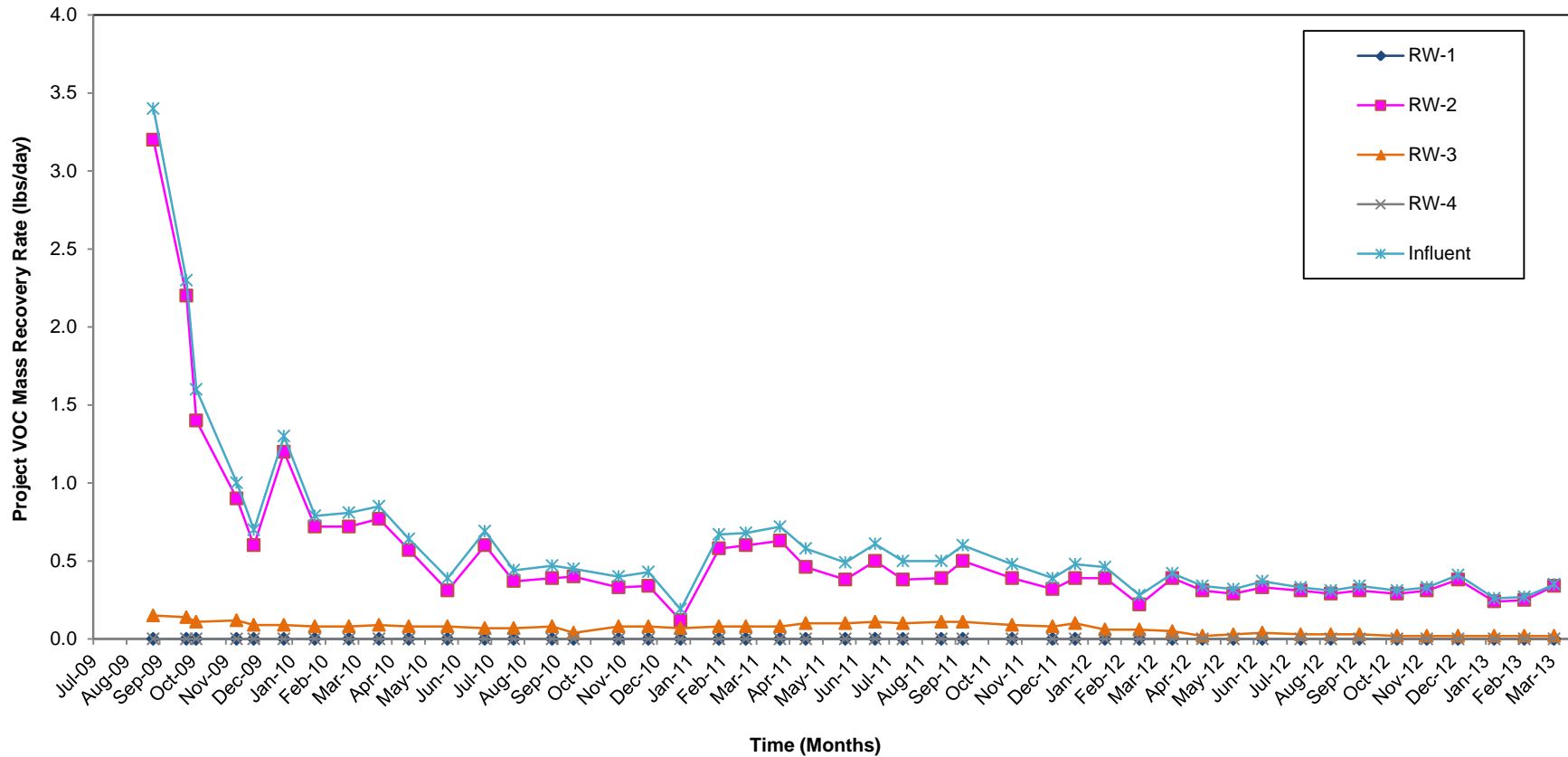

FIGURE
8A



Notes:

VOC = Volatile organic compound.

lbs/day = Pounds per day.

Project VOCs = Sum of 1,1,1-Trichloroethane; 1,1-Dichloroethane; 1,2-Dichloroethane; 1,1-Dichloroethene; Tetrachloroethene; Trichloroethene; Vinyl Chloride; cis-1,2-Dichloroethene; trans-1,2-Dichloroethene; Benzene; Toluene; and Total Xylenes.

GROUNDWATER INTERIM REMEDIAL MEASURE
 OPERABLE UNIT 3
 (FORMER GRUMMAN SETTLING PONDS)
 BETHPAGE, NEW YORK

**PROJECT VOC MASS RECOVERY
 RATES THROUGH
 MARCH 2013**



FIGURE
8B

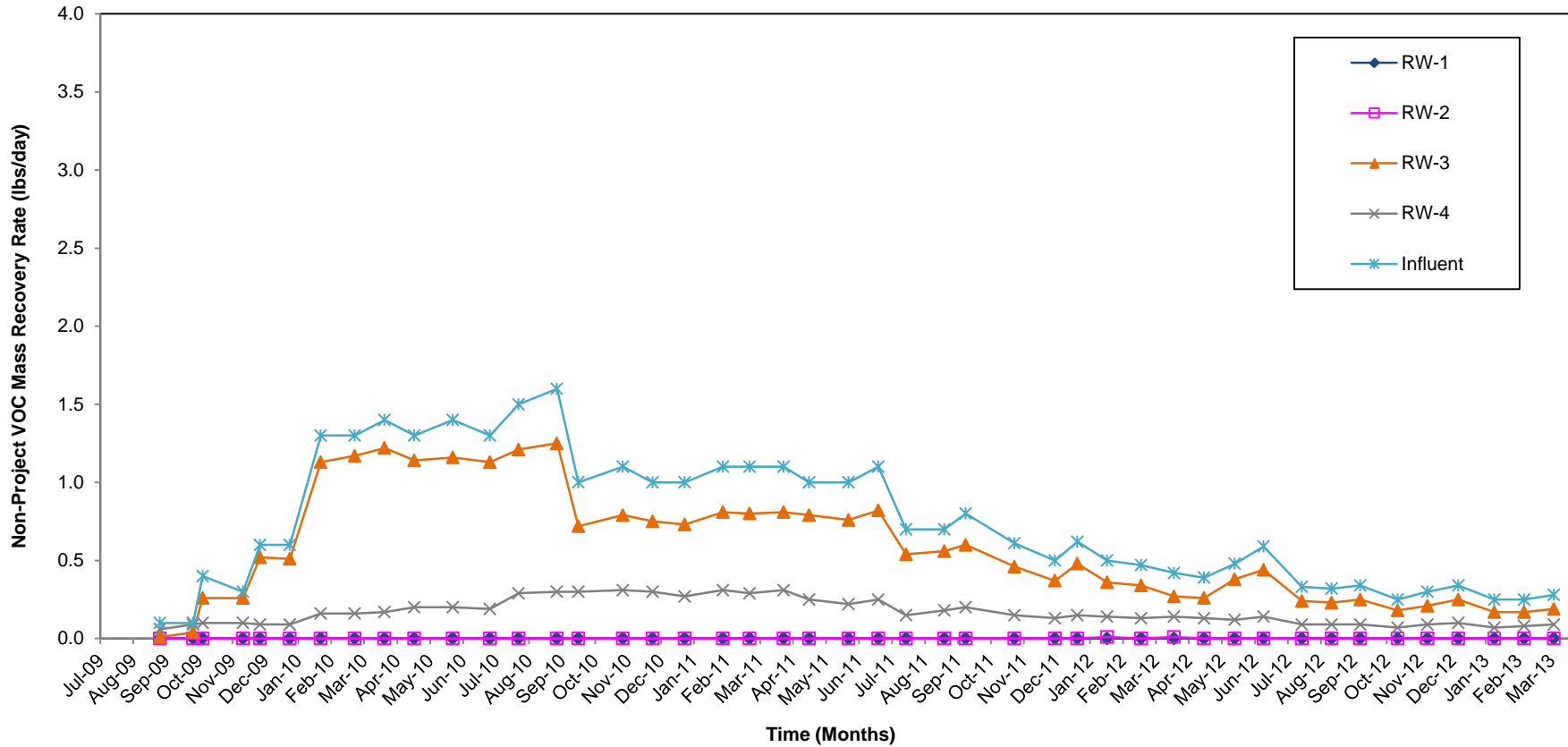

Notes:

VOC = Volatile organic compound.

lbs/day = Pounds per day.

Non-Project VOCs = Sum of Total VOCs that are not Project VOCs.

GROUNDWATER INTERIM REMEDIAL MEASURE
 OPERABLE UNIT 3
 (FORMER GRUMMAN SETTLING PONDS)
 BETHPAGE, NEW YORK

**NON-PROJECT VOC MASS
 RECOVERY RATES THROUGH
 MARCH 2013**



FIGURE
8C

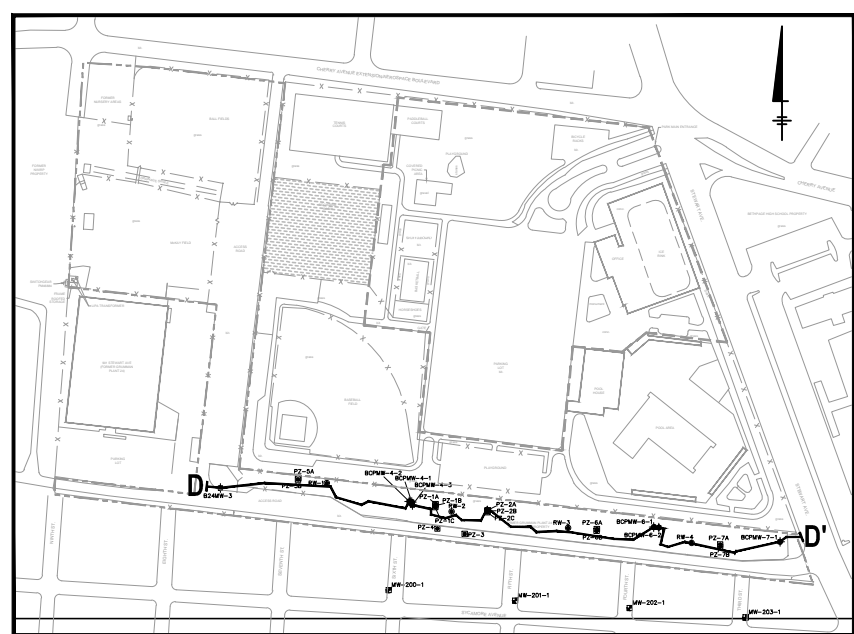
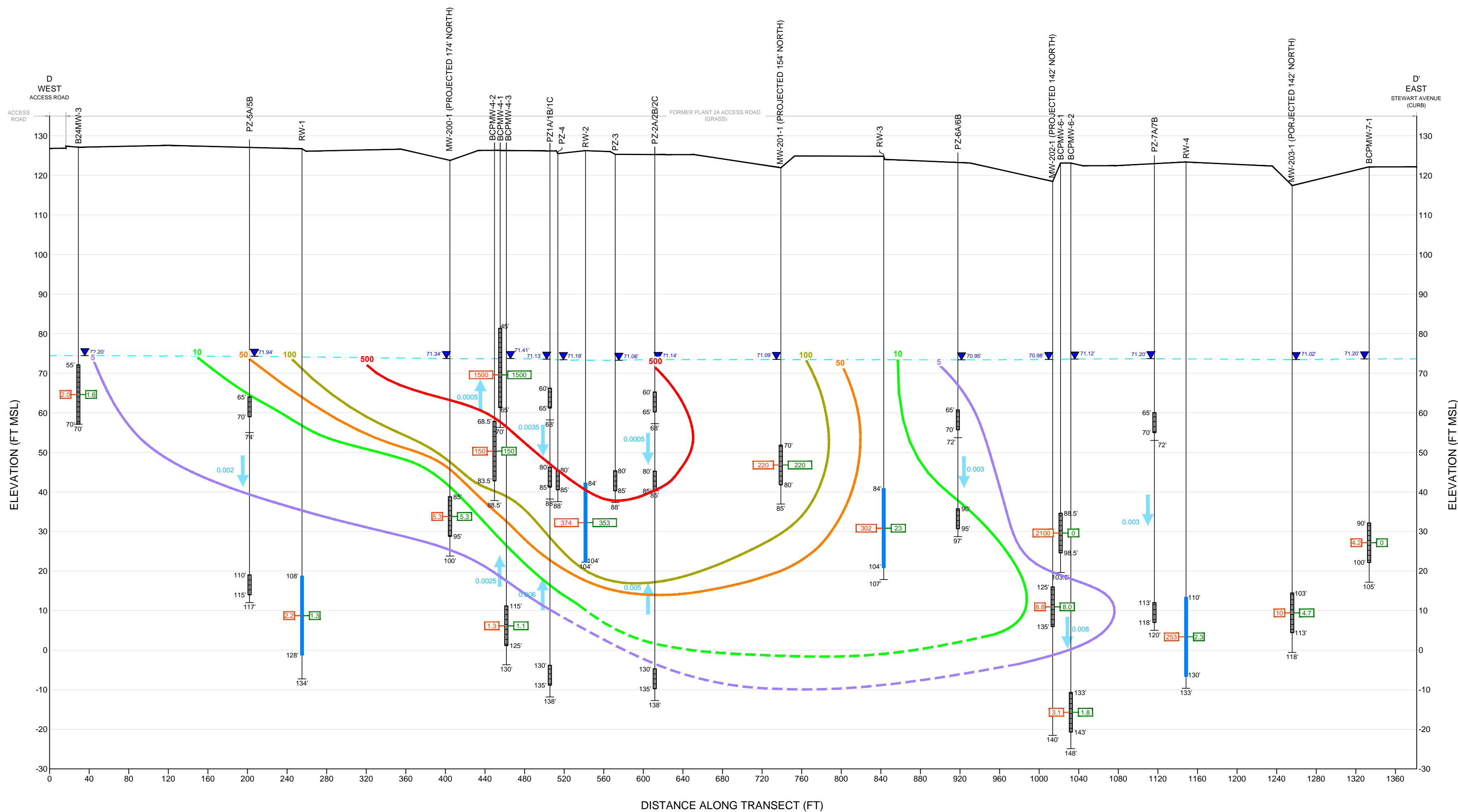

KEY PLAN
SHOWING CROSS SECTION D-D'

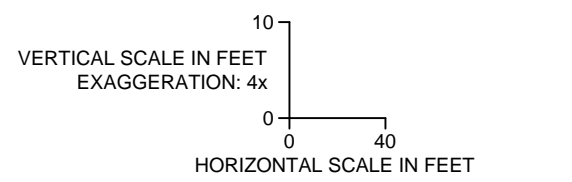
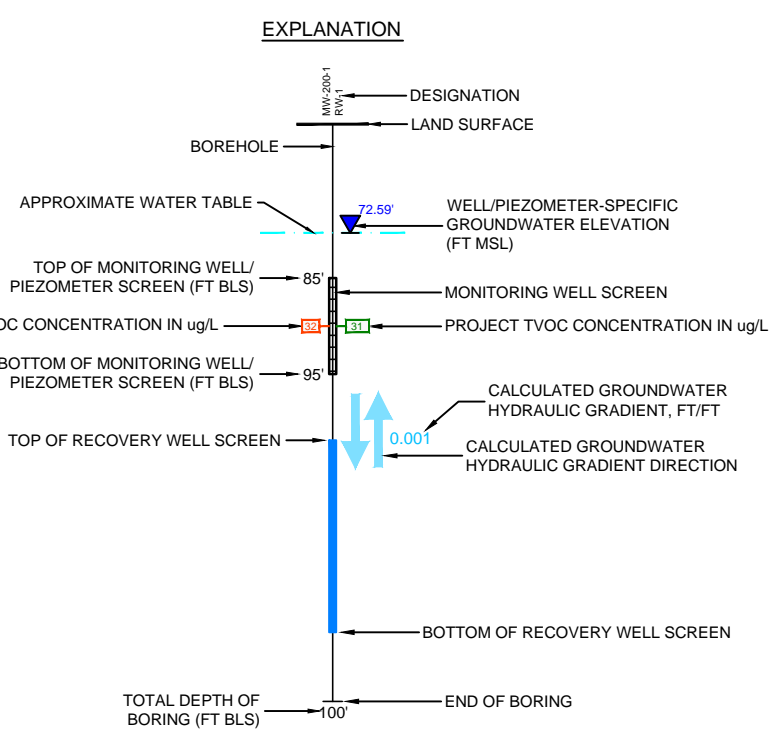

- DEFINITIONS:**
FT - FEET
MSL - MEAN SEA LEVEL
TCE - TRICHLOROETHENE
 $\mu\text{g/L}$ - MICROGRAMS PER LITER
TVOC - TOTAL VOLATILE ORGANIC COMPOUND
- DEFINITION OF CONTOURS (DASHED WHERE INFERRED)**
- 5 $\mu\text{g/L}$
 - 10 $\mu\text{g/L}$
 - 50 $\mu\text{g/L}$
 - 100 $\mu\text{g/L}$
 - 500 $\mu\text{g/L}$
 - 1,000 $\mu\text{g/L}$

- NOTES:**
1. WATER LEVEL ELEVATIONS CALCULATED FROM DATA COLLECTED ON FEBRUARY 13, 2013.
 2. MONITORING WELL TVOC/PROJECT TVOC DATA FROM THE OCTOBER 2012 SAMPLING ROUND. RESULT REPRESENTATIVE OF ENTIRE WELL SCREEN INTERVAL.
 3. CONTOURS ARE BASED ON PROJECT TVOC DATA, SEE NOTE 2.
 4. THE GROUNDWATER INTERIM REMEDIAL MEASURE (IRM) HAS BEEN DESIGNED TO ADDRESS GROUNDWATER THAT HAS TVOC CONCENTRATIONS GREATER THAN 5 $\mu\text{g/L}$ IN THE UPPER 20 FEET OF THE SURFICIAL AQUIFER AND GROUNDWATER BELOW THE UPPER 20 FEET OF THE SURFICIAL AQUIFER THAT HAS TVOC CONCENTRATIONS GREATER THAN 50 $\mu\text{g/L}$.
 5. PROJECT VOCS ARE VOCS THAT MAY BE RELATED TO FORMER GRUMMAN HISTORICAL ACTIVITIES. NON-PROJECT VOCS ARE VOCS THAT ARE NOT RELATED TO FORMER GRUMMAN ACTIVITIES BUT HAVE BEEN DETECTED IN THE SITE AREA. PLEASE REFER TO THE REPORT TABLES FOR LISTS OF PROJECT AND NON-PROJECT VOCS.

NORTHROP GRUMMAN SYSTEMS CORPORATION
OPERABLE UNIT 3
(FORMER GRUMMAN SETTLING PONDS)
BETHPAGE, NEW YORK

CROSS SECTION D-D' SHOWING TVOCs IN GROUNDWATER AND DIRECTION OF VERTICAL GROUNDWATER HYDRAULIC GRADIENTS FIRST QUARTER 2013

FIGURE
9

CITY (Road) DIV (GROUP) (Rev) DE (Rev) LD (Rev) PIC (Rev) PM (Rev) TM (Rev) LTR (Rev) OFF (Rev) REF
 G:\ENV\CD\SRV\ACT\10014881\12\02\09\04\2013\1\01\01\1488_112_01\01\02_01.dwg LAYOUT: 9 SANED: 5/20/13 4:45 PM ACADVER: 18.1S (LMS TECH) PAGES: 18 PLOTSTYLETABLE: ... PLOTSTYLETABLE: ... PLOTSTYLETABLE: ...
 XREFS: PROJECTNAME: ...
 Xref_01



Appendix A

Well Construction Information and
Environmental Effectiveness
Monitoring Program

Table A-1. Well Construction Information and Environmental Effectiveness Monitoring Program, Groundwater Interim Remedial Measure, Operable Unit 3 (Former Grumman Settling Ponds), Northrop Grumman Systems Corporation, Bethpage, New York. ^(1,2)

Well ID	Well Diameter (inches)	Depth to Screen		Screen Length (ft)	Well Depth (ft)	Well Materials	Water Levels ⁽³⁾	MONITORING ACTIVITY		
		Top (ft bls)	Bottom (ft bls)					WATER QUALITY ⁽⁴⁾		
								VOC	Cd/Cr	Fe/Mn
Monitoring Wells										
BCPMW-1	2	50	65	15	65	Sch. 40 PVC	Quarterly	Baseline	Baseline	--
BCPMW-2	2	60	75	15	75	Sch. 40 PVC	Quarterly	Baseline	Baseline	Baseline
BCPMW-3	2	59	74	15	74	Sch. 40 PVC	Quarterly	Baseline	Baseline	Baseline
BCPMW-4-1	4	45	65	20	70	Sch. 40 PVC	Quarterly	Baseline/Semiannual ⁽⁵⁾	Baseline/Annual	Baseline
BCPMW-4-2	4	68.5	83.5	15	88.5	Sch. 40 PVC	Quarterly	Baseline/Semiannual ⁽⁵⁾	Baseline/Annual	Baseline
BCPMW-4-3	4	115	125	10	130	Sch. 40 PVC	Quarterly	Baseline/Semiannual ⁽⁵⁾	Baseline/Annual	Baseline
BCPMW-5-1	4	50	65	15	70	Sch. 80 PVC/ SS	Quarterly	Baseline	Baseline	Baseline
BCPMW-6-1	4	88.5	98.5	10	103.5	Sch. 40 PVC	Quarterly	Baseline/Semiannual ⁽⁵⁾	Baseline/Annual	--
BCPMW-6-2	4	133	143	10	148	Sch. 40 PVC	Quarterly	Baseline/Semiannual ⁽⁵⁾	Baseline/Annual	--
BCPMW-7-1	4	90	100	10	105	Sch. 40 PVC	Quarterly	Baseline/Semiannual ⁽⁵⁾	Baseline/Annual	--
B24MW-2	2	54	74	20	74	PVC	Quarterly	Baseline/Annual	Baseline	--
B24MW-3	2	55	70	15	70	PVC	Quarterly	Baseline/Annual	Baseline	--
B30MW-1	2	57	72	15	72	PVC	Quarterly	Baseline/Annual	Baseline	--
MW-200-1	4	85	95	10	100	Sch. 40 PVC/ SS	Quarterly	Baseline/Semiannual ⁽⁵⁾	Baseline/Annual	--
MW-201-1	4	70	80	10	85	Sch. 40 PVC/ SS	Quarterly	Baseline/Semiannual ⁽⁵⁾	Baseline/Annual	--
MW-202-1	4	125	135	10	140	Sch. 40 PVC/ SS	Quarterly	Baseline/Semiannual ⁽⁵⁾	Baseline/Annual	--
MW-203-1	4	103	113	10	118	Sch. 40 PVC/ SS	Quarterly	Baseline/Semiannual ⁽⁵⁾	Baseline/Annual	--
Remedial Wells ⁽⁶⁾										
RW-01	8	108	128	20	134	Sch. 80 PVC/SS	Quarterly	Baseline/Quarterly	Baseline/Annual	--
RW-02	6	84	104	20	104	Steel/SS	Quarterly	Baseline/Quarterly	Baseline/Annual	--
RW-03	8	84	104	20	107	Sch. 80 PVC/SS	Quarterly	Baseline/Quarterly	Baseline/Annual	--
RW-04	8	110	130	20	133	Sch. 80 PVC/SS	Quarterly	Baseline/Quarterly	Baseline/Annual	--

See notes on last page.

Table A-1. Well Construction Information and Environmental Effectiveness Monitoring Program, Groundwater Interim Remedial Measure, Operable Unit 3 (Former Grumman Settling Ponds), Northrop Grumman Systems Corporation, Bethpage, New York. ^(1,2)

Well ID	Well Diameter (inches)	Depth to Screen		Screen Length (ft)	Well Depth (ft)	Well Materials	Water Levels ⁽³⁾	MONITORING ACTIVITY		
		Top (ft bls)	Bottom (ft bls)					WATER QUALITY ⁽⁴⁾		
								VOC	Cd/Cr	Fe/Mn
Piezometers										
PZ-01a	2	60	65	5	68	Sch. 40 PVC	Quarterly	--	--	--
PZ-01b	1	80	85	5	88	Sch. 40 PVC	Quarterly	--	--	--
PZ-01c	1	130	135	5	138	Sch. 40 PVC	Quarterly	--	--	--
PZ-02a	2	60	65	5	68	Sch. 40 PVC	Quarterly	--	--	--
PZ-02b	1	80	85	5	85	Sch. 40 PVC	Quarterly	--	--	--
PZ-02c	1	130	135	5	138	Sch. 40 PVC	Quarterly	--	--	--
PZ-03	1	80	85	5	88	Sch. 40 PVC	Quarterly	--	--	--
PZ-04	1	80	85	5	88	Sch. 40 PVC	Quarterly	--	--	--
PZ-05a	2	65	70	5	74	Sch. 40 PVC	Quarterly	--	--	--
PZ-05b	1	110	115	5	117	Sch. 40 PVC	Quarterly	--	--	--
PZ-06a	2	65	70	5	72	Sch. 40 PVC	Quarterly	--	--	--
PZ-06b	1	90	95	5	97	Sch. 40 PVC	Quarterly	--	--	--
PZ-07a	2	65	70	5	72	Sch. 40 PVC	Quarterly	--	--	--
PZ-07b	1	113	118	5	120	Sch. 40 PVC	Quarterly	--	--	--

Notes:

- (1) Water samples will be collected and analyzed in accordance with the method and procedures described in the Sampling and Analysis Plan (SAP).
- (2) Approximate locations of the wells and piezometers in the OU-3 Groundwater Interim Remedial Measure Monitoring Program are shown in Figure 1.
- (3) Water levels will be measured in all wells/piezometers during the baseline monitoring event. Water levels will be measured in accordance with the procedures presented in the SAP.
- (4) VOC: VOCs, per Table D-3 in the Quality Assurance Project Plan (QAPP), using NYSDEC ASP 2000 Method OLM 4.3.
Cd/Cr: Cadmium and Chromium using USEPA Method 6010.
Fe/Mn: Iron and Manganese using USEPA Method 6010, both total and dissolved.
- (5) Semiannual wells will be monitored annually after Year 1.
- (6) Some of the analyses listed here are also covered in the Remedial System Sampling Program (Table B-1) and some of the analyses and/or frequencies may be modified based on review of short-term and/or long-term testing results. (e.g. the Cd/Cr sampling frequency was changed from quarterly to annually in 2011).

Acronyms\Key:

- Sch. 80 PVC Schedule 80 polyvinyl chloride.
- Sch. 40 PVC schedule 40 polyvinyl chloride.
- SS Stainless steel.
- Steel Low carbon steel.
- ft Feet.
- ft ms Feet relative to mean sea level.
- ft bls Feet below land surface.
- Not applicable.
- VOC Volatile organic compound.



Appendix B

Compliance and Performance
Program and Water Sample
Analytical Results

Table B-1. Compliance and Performance Program Elements, Groundwater Interim Remedial Measure, Operable Unit 3 (Former Grumman Settling Ponds), Northrop Grumman Systems Corporation, Bethpage, New York.

Sample Location/Instrument ⁽¹⁾	Parameter (Method) ⁽²⁾	Frequency			SCADA Data Acquisition
		Short-Term ⁽³⁾ (first month)	(five month period following first month)	Long-Term ⁽⁴⁾	
<i>Water Samples</i> ⁽⁵⁾					
Remedial Well 1 (WSP-1)	VOCs (NYSDEC 2000 OLM 4.3)	Bi-Weekly	Quarterly	Quarterly	NA
	Iron (USEPA 6010)	Bi-Weekly	Annually	Annually	NA
	Cadmium and Chromium (USEPA 6010) ⁽¹¹⁾	---			
Remedial Well 2 (WSP-2)	VOCs (NYSDEC 2000 OLM 4.3)	Bi-Weekly	Quarterly	Quarterly	NA
	Iron (USEPA 6010)	Bi-Weekly	Annually	Annually	NA
	Cadmium and Chromium (USEPA 6010) ⁽¹¹⁾	---			
Remedial Well 3 (WSP-3)	VOCs (NYSDEC 2000 OLM 4.3)	Bi-Weekly	Quarterly	Quarterly	NA
	Iron (USEPA 6010)	Bi-Weekly	Annually	Annually	NA
	Cadmium and Chromium (USEPA 6010) ⁽¹¹⁾	---			
Remedial Well 4 (WSP-4)	VOCs (NYSDEC 2000 OLM 4.3)	Bi-Weekly	Quarterly	Quarterly	NA
	Iron (USEPA 6010)	Bi-Weekly	Annually	Annually	NA
	Cadmium and Chromium (USEPA 6010) ⁽¹¹⁾	---	Annually	Annually	NA
Air Stripper Influent (WSP-5)	VOCs (NYSDEC 2000 OLM 4.3)	1-hr ⁽⁶⁾ ; Days 1, 3, & Weekly	Monthly	Quarterly	NA
	Iron (USEPA 6010)	1-hr ⁽⁶⁾ ; Days 1, 3, & Weekly	Monthly	Quarterly	NA
Air Stripper Effluent (WSP-6)	Iron (USEPA 6010)	1-hr ⁽⁶⁾ ; As Needed	As Needed	As Needed	NA
Plant Effluent (WSP-7)	VOCs (NYSDEC 2000 OLM 4.3)	1-hr ⁽⁶⁾; Days 1, 3, & Weekly	Monthly	Monthly	NA
	Iron (USEPA 6010)	1-hr ⁽⁶⁾; Days 1, 3, & Weekly	Monthly	Monthly	NA
	Mercury (USEPA 7470) ⁽⁷⁾	1-hr ⁽⁶⁾; Days 1, 3, & Weekly	Monthly	NA	NA
	pH (field) ⁽⁸⁾	1-hr ⁽⁶⁾; Days 1, 3, & Weekly	Monthly	Monthly	NA
	Cadmium and Chromium (USEPA 6010) ⁽¹¹⁾	---	Quarterly	Quarterly	NA
<i>Air Samples</i> ^{(9) (10)}					
Air Stripper Effluent/ECU-1 Influent (VSP-1)	VOCs (TO-15 Modified)	Monthly	Monthly	Quarterly	NA
ECU-1 Effluent/ECU-2 Influent (VSP-2)	VOCs (TO-15 Modified)	As Needed	As Needed	As Needed	NA
ECU-2 Effluent/ECU-3 Influent (VSP-3)	VOCs (TO-15 Modified)	As Needed	As Needed	As Needed	NA
ECU-3 Effluent/ECU-4 Influent (VSP-4)	VOCs (TO-15 Modified)	As Needed	As Needed	As Needed	NA
Total Effluent (VSP-5)	VOCs (TO-15 Modified)	Monthly	Monthly	Quarterly	NA

See notes on last page.

Table B-1. Compliance and Performance Program Elements, Groundwater Interim Remedial Measure, Operable Unit 3 (Former Grumman Settling Ponds), Northrop Grumman Systems Corporation, Bethpage, New York.

Sample Location/Instrument ⁽¹⁾	Parameter (Method) ⁽²⁾	Frequency			SCADA Data Acquisition
		Short-Term ⁽³⁾ (first month)	(five month period following first month)	Long-Term ⁽⁴⁾	
<u>Water Flow Measurements</u>					
Remedial Well RW-1 (FT - 110)	Flow rate (gpm + total gal.)	(Daily -1st week) Weekly	Weekly	Weekly	Continuously
Remedial Well RW-2 (FT - 120)	Flow rate (gpm + total gal.)	(Daily -1st week) Weekly	Weekly	Weekly	Continuously
Remedial Well RW-3 (FT - 130)	Flow rate (gpm + total gal.)	(Daily -1st week) Weekly	Weekly	Weekly	Continuously
Remedial Well RW-4 (FT - 140)	Flow rate (gpm + total gal.)	(Daily -1st week) Weekly	Weekly	Weekly	Continuously
Combined Influent (FR - 200)	Flow rate (gpm + total gal.)	(Daily -1st week) Weekly	Weekly	Weekly	Continuously
System Effluent (FT-700)	Flow rate (gpm + total gal.)	(Daily -1st week) Weekly	Weekly	Weekly	Continuously
<u>Air Flow Measurements</u>					
Air Stripper Effluent (FT-500)	Flow rate (SCFM)	(Daily -1st week) Weekly	Weekly	Weekly	Continuously
<u>Water Pressure Measurements</u>					
Remedial Well RW-1 (PT - 110)	Pressure (i.w.g.)	(Daily -1st week) Weekly	Weekly	Weekly	Continuously
Remedial Well RW-2 (PT - 120)	Pressure (i.w.g.)	(Daily -1st week) Weekly	Weekly	Weekly	Continuously
Remedial Well RW-3 (PT - 130)	Pressure (i.w.g.)	(Daily -1st week) Weekly	Weekly	Weekly	Continuously
Remedial Well RW-4 (PT - 140)	Pressure (i.w.g.)	(Daily -1st week) Weekly	Weekly	Weekly	Continuously
Air Stripper Effluent (PT-700)	Pressure (i.w.g.)	(Daily -1st week) Weekly	Weekly	Weekly	Continuously
<u>Air Temperature & Relatively Humidity Measurements</u>					
Air Stripper Effluent (TT-500)	Temperature	Weekly	Weekly	Weekly	Continuously
ECU Mid-Train (TI-503)	Temperature	Weekly	Weekly	Weekly	NA
Effluent (TI-603)	Temperature	Weekly	Weekly	Weekly	NA

See notes on last page.

Table B-1. Compliance and Performance Program Elements, Groundwater Interim Remedial Measure, Operable Unit 3 (Former Grumman Settling Ponds), Northrop Grumman Systems Corporation, Bethpage, New York.

Sample Location/Instrument ⁽¹⁾	Parameter (Method) ⁽²⁾	Frequency				SCADA Data Acquisition
		Short-Term ⁽³⁾ (first month)	(five month period following first month)	Long-Term ⁽⁴⁾		
<u>Air Pressure Measurements</u>						
Air Stripper Effluent (PT-500)	Pressure (i.w.g.)	(Daily -1st week) Weekly	Monthly	Quarterly	Continuously	
ECU #1 Influent (PI-501)	Pressure (i.w.g.)	(Daily -1st week) Weekly	Monthly	Quarterly	NA	
ECU #2 Influent (PI-502)	Pressure (i.w.g.)	(Daily -1st week) Weekly	Monthly	Quarterly	NA	
ECU #3 Influent (PI-601)	Pressure (i.w.g.)	(Daily -1st week) Weekly	Monthly	Quarterly	NA	
ECU #4 Influent (PI-602)	Pressure (i.w.g.)	(Daily -1st week) Weekly	Monthly	Quarterly	NA	
System Effluent (PI-603)	Pressure (i.w.g.)	(Daily -1st week) Weekly	Monthly	Quarterly	NA	

See notes on last page.

Table B-1. Compliance and Performance Program Elements, Groundwater Interim Remedial Measure, Operable Unit 3 (Former Grumman Settling Ponds), Northrop Grumman Systems Corporation, Bethpage, New York.

Notes:

- (1) Refer to Figure 3 of this Operation, Maintenance, & Monitoring (OM&M) Report and Appendix E of the Groundwater IRM OM&M Manual (OM&M Manual (ARCADIS 2009)) for a diagram showing referenced sample locations and measurement points.
- (2) Parameters/methods may be modified based on review of short-term and/or long-term testing results. Parameters shown in **Bold** indicate parameters that require NYSDEC notification/approval prior to change in monitoring schedule.
- (3) Short-term schedule is tentative. Modification may be required/recommended based on the results of start-up and performance testing.
- (4) Long-term schedule is tentative. Modification may be required/recommended based on the results of short-term testing or water quality trends.
- (5) Water samples will be collected in accordance with the methods described in the Sampling and Analysis Plan, which is included as Appendix A of the OM&M Manual (ARCADIS 2009). Samples will be analyzed in accordance with the methods and procedures described in the Sampling and Analysis Plan.
- (6) Per NYSDEC request, a 1-hr pilot test was performed during system shake-down. The 1-hr pilot test samples were also analyzed for Mercury (Hg).
- (7) Per the interim treated effluent (water) discharge criteria provided in the NYSDEC letter dated March 19, 2009, select samples were analyzed for Mercury (Hg).
- (8) As authorized by the NYSDEC, the pH monitoring frequency was reduced from weekly to monthly beginning on February 8, 2010.
- (9) Air samples collected and analyzed in accordance with methods described in the Sampling and Analysis Plan, which is included as Appendix A of the OM&M Manual (ARCADIS 2009).
- (10) Additional air samples will be collected to help calculate media usage rates and to help determine media changeout frequencies.
- (11) Cadmium and Chromium analyses are part of the Environmental Effectiveness Monitoring Program (Table A-1) and the original discharge permit application. They are included here for consistency.

Acronyms\Key:

NA	Not Applicable.
---	Not Required
ECU	Emissions control unit.
VOCs	Volatile organic compounds (refer Tables D-3 and D-5 in the Quality Assurance Project Plan (QAPP) (Appendix D of the OM&M Manual (ARCADIS 2009)) for the analyte lists for aqueous and air samples, respectively).
gal.	Gallons.
gpm	Gallons per minute.
i.w.g.	Inches water gauge.
NYSDEC	New York State Department of Environmental Conservation.
EPA	U.S. Environmental Protection Agency.
SCADA	Supervisory Control And Data Acquisition.
OM&M	Operation, maintenance and monitoring.

Table B-2. Water Sample Analytical Results - January 7, 2013, Groundwater Interim Remedial Measure, Operable Unit 3
 (Former Grumman Settling Ponds), Bethpage, New York. ^(1,2,3)

COMPOUND (ug/L)	Sample ID: Sample Location: Sample Date:	WSP-01 RW-1 1/7/2013	WSP-02 RW-2 1/7/2013	WSP-03 RW-3 1/7/2013	WSP-04 RW-4 1/7/2013	WSP-05 Influent 1/7/2013	WSP-07 Effluent 1/7/2013
<u>Volatile Organic Compounds</u>							
1,1,1-Trichloroethane		< 5 U	0.41 J	< 5 U	< 5 U	< 5 U	< 5 U
1,1,2,2-Tetrachloroethane		< 5 U	< 5 U	< 5 U	< 5 U	< 5 U	< 5 U
1,1,2-Trichloroethane		< 5 U	< 5 U	< 5 U	< 5 U	< 5 U	< 5 U
1,1-Dichloroethane		< 5 U	1.6 J	0.21 J	0.46 J	0.48 J	< 5 U
1,1-Dichloroethene		< 5 U	0.82 J	< 5 U	0.24 J	0.25 J	< 5 U
1,2-Dichloroethane		< 5 U	< 5 U	< 5 U	< 5 U	< 5 U	< 5 U
1,2-Dichloropropane		< 5 U	< 5 U	< 5 U	< 5 U	< 5 U	< 5 U
2-Butanone (MEK)		< 50 U	< 50 U	< 50 U	< 50 U	< 50 U	< 50 U
2-Hexanone (MBK)		< 50 U	< 50 U	< 50 U	< 50 U	< 50 U	< 50 U
4-methyl-2-pentanone (MIK)		< 50 U	< 50 U	< 50 U	< 50 U	< 50 U	< 50 U
Acetone		< 50 U	< 50 U	< 50 U	< 50 U	< 50 U	< 50 U
Benzene		< 0.7 U	< 0.7 U	< 0.7 U	< 0.7 U	< 0.7 U	< 0.7 U
Bromodichloromethane		< 5 U	< 5 U	< 5 U	< 5 U	< 5 U	< 5 U
Bromoform		< 5 U	< 5 U	< 5 U	< 5 U	< 5 U	< 5 U
Bromomethane		< 5 U	< 5 U	< 5 U	< 5 U	< 5 U	< 5 U
Carbon Disulfide		< 5 U	< 5 U	< 5 U	< 5 U	< 5 U	< 5 U
Carbon tetrachloride		< 5 U	< 5 U	< 5 U	< 5 U	< 5 U	< 5 U
Chlorobenzene		< 5 U	< 5 U	< 5 U	< 5 U	< 5 U	< 5 U
Chlorodifluoromethane (Freon 22)		< 5 U	0.33 J	190	190 D	86	< 5 U
Chloroethane		< 5 U	< 5 U	< 5 U	< 5 U	< 5 U	< 5 U
Chloroform		< 5 U	2.1 J	4.9 J	0.28 J	2.1 J	< 5 U
Chloromethane		< 5 U	< 5 U	< 5 U	< 5 U	< 5 U	< 5 U
cis-1,2-dichloroethene		0.34 J	160	12	0.24 J	38	< 5 U
cis-1,3-dichloropropene		< 5 U	< 5 U	< 5 U	< 5 U	< 5 U	< 5 U
Dibromochloromethane		< 5 U	< 5 U	< 5 U	< 5 U	< 5 U	< 5 U
Dichlorodifluoromethane (Freon 12)		< 5 U	< 5 U	< 5 U	< 5 U	< 5 U	< 5 U
Ethylbenzene		< 5 U	2.3 J	< 5 U	< 5 U	0.41 J	< 5 U
Methyl tert-Butyl Ether		< 5 U	< 5 U	< 5 U	0.28 J	< 5 U	< 5 U
Methylene Chloride		< 5 U	< 5 U	< 5 U	< 5 U	< 5 U	< 5 U
Styrene		< 5 U	< 5 U	< 5 U	< 5 U	< 5 U	< 5 U
Tetrachloroethene		< 5 U	0.38 J	0.33 J	0.95 J	0.34 J	< 5 U
Toluene		< 5 U	82	< 5 U	< 5 U	17	< 5 U
trans-1,2-dichloroethene		< 5 U	< 5 U	< 5 U	< 5 U	< 5 U	< 5 U
trans-1,3-dichloropropene		< 5 U	< 5 U	< 5 U	< 5 U	< 5 U	< 5 U
Trichloroethylene		0.86 J	18	5.1	0.82 J	5.9	< 5 U
Trichlorofluoromethane (CFC-11)		< 5 U	< 5 U	< 5 U	< 5 U	< 5 U	< 5 U
Trichlorotrifluoroethane (Freon 113)		< 5 U	< 5 U	< 5 U	0.38 J	< 5 U	< 5 U
Vinyl Chloride		< 2 U	75	0.25 J	< 2 U	16	< 2 U
Xylene-o		< 5 U	3.2 J	< 5 U	< 5 U	0.56 J	< 5 U
Xylenes - m,p		< 5 U	5.3	< 5 U	< 5 U	1.2 J	< 5 U
Subtotal VOCs ⁽⁴⁾							
Tentatively Identified Compounds		ND	ND	ND	ND	ND	ND
Subtotal TICs ⁽⁵⁾		0	0	0	0	0	0
Total VOCs ⁽⁶⁾		1.2	351	213	194	168	0

See notes on last page.

Table B-2. Water Sample Analytical Results - January 7, 2013, Groundwater Interim Remedial Measure, Operable Unit 3 (Former Grumman Settling Ponds), Bethpage, New York. ^(1,2,3)

COMPOUND (ug/L)	Sample ID: Sample Location: Sample Date:	WSP-01 RW-1 1/7/2013	WSP-02 RW-2 1/7/2013	WSP-03 RW-3 1/7/2013	WSP-04 RW-4 1/7/2013	WSP-05 Influent 1/7/2013	WSP-07 Effluent 1/7/2013
Metals							
Cadmium (Dissolved)		--	--	--	--	--	< 5 U
Cadmium (Total)		--	--	--	--	--	< 5 U
Chromium (Dissolved)		--	--	--	--	--	< 10 U
Chromium (Total)		--	--	--	--	--	< 10 U
Iron (Dissolved)		--	560	< 100 U	--	150	140
Iron (Total)		--	600	< 100 U	--	150	140
Manganese (Dissolved)		--	--	--	--	--	--
Manganese (Total)		--	--	--	--	--	--
Mercury (Dissolved)		--	--	--	--	--	--
Mercury (Total)		--	--	--	--	--	< 0.2 U

Notes:

- (1) Samples collected by ARCADIS on the dates shown and submitted to Columbia Analytical Services, Inc. for VOC analyses using New York State Department of Environmental Conservation ASP 2000 Method OLM 4.3 and metals using USEPA Method 6010, except for mercury, which was analyzed using USEPA Method 7470.
- (2) Refer to Figure 3 of this OM&M Report for schematic sample locations.
- (3) Results validated following protocols specified in the Sampling and Analysis Plan (Appendix A) of the Groundwater OM&M Manual (ARCADIS 2009).
- (4) "Subtotal VOCs" represents the sum of individual concentrations of VOCs detected. Values shown have been rounded to the nearest whole number.
- (5) "Subtotal TICs" represents the sum of individual TICs detected. Values shown have been rounded to the nearest whole number.
- (6) "Total VOCs" represent the sum of VOCs and TICs detected. Values shown have been rounded to the nearest whole number.

Acronyms\Key:

Bold value indicates a detection.

- D Compound reported from the diluted analyses as the concentration in the initial analysis was outside the calibration range.
- dup. Duplicate.
- J Estimated value.
- ND TIC not detected.
- OM&M Operation, maintenance and monitoring.
- TIC Tentatively identified compound.
- USEPA United States Environmental Protection Agency.
- VOC Volatile organic compound.
- ug/L Micrograms per liter.
- Not analyzed.
- < 5 U Compound not detected above its laboratory quantification limit.
- B Compound found in an associated blank sample, presence may be suspect
- UB Compound considered non-detect due to associated blank contamination.

Table B-3. Water Sample Analytical Results - February 4, 2013, Groundwater Interim Remedial Measure, Operable Unit 3
 (Former Grumman Settling Ponds), Bethpage, New York.^(1,2,3)

COMPOUND (ug/L)	Sample ID: Sample Location: Sample Date:	WSP-02 RW-2 2/4/2013	WSP-03 RW-3 2/4/2013	WSP-05 Influent 2/4/2013	WSP-05 dup. Influent 2/4/2013	WSP-07 Effluent 2/4/2013
<u>Volatile Organic Compounds</u>						
1,1,1-Trichloroethane	--	--	--	< 5 U	< 5 U	< 5 U
1,1,1,2-Tetrachloroethane	--	--	--	< 5 U	< 5 U	< 5 U
1,1,2-Trichloroethane	--	--	--	< 5 U	< 5 U	< 5 U
1,1-Dichloroethane	--	--	--	0.42 J	0.45 J	< 5 U
1,1-Dichloroethene	--	--	--	< 5 U	< 5 U	< 5 U
1,2-Dichloroethane	--	--	--	< 5 U	< 5 U	< 5 U
1,2-Dichloropropane	--	--	--	< 5 U	< 5 U	< 5 U
2-Butanone (MEK)	--	--	--	< 50 U	< 50 U	< 50 U
2-Hexanone (MBK)	--	--	--	< 50 U	< 50 U	< 50 U
4-methyl-2-pentanone (MIK)	--	--	--	< 50 U	< 50 U	< 50 U
Acetone	--	--	--	< 50 U	< 50 U	< 50 U
Benzene	--	--	--	< 0.7 U	< 0.7 U	< 0.7 U
Bromodichloromethane	--	--	--	< 5 U	< 5 U	< 5 U
Bromoform	--	--	--	< 5 U	< 5 U	< 5 U
Bromomethane	--	--	--	< 5 U	< 5 U	< 5 U
Carbon Disulfide	--	--	--	< 5 U	< 5 U	< 5 U
Carbon tetrachloride	--	--	--	< 5 U	< 5 U	< 5 U
Chlorobenzene	--	--	--	< 5 U	< 5 U	< 5 U
Chlorodifluoromethane (Freon 22)	--	--	--	85	89	< 5 U
Chloroethane	--	--	--	< 5 U	< 5 U	< 5 U
Chloroform	--	--	--	1.9 J	2 J	< 5 U
Chloromethane	--	--	--	< 5 U	< 5 U	< 5 U
cis-1,2-dichloroethene	--	--	--	40	41	< 5 U
cis-1,3-dichloropropene	--	--	--	< 5 U	< 5 U	< 5 U
Dibromochloromethane	--	--	--	< 5 U	< 5 U	< 5 U
Dichlorodifluoromethane (Freon 12)	--	--	--	< 5 U	< 5 U	< 5 U
Ethylbenzene	--	--	--	0.48 J	0.31 J	< 5 U
Methyl tert-Butyl Ether	--	--	--	< 5 U	< 5 U	< 5 U
Methylene Chloride	--	--	--	< 5 U	< 5 U	< 5 U
Styrene	--	--	--	< 5 U	< 5 U	< 5 U
Tetrachloroethene	--	--	--	0.3 J	0.23 J	< 5 U
Toluene	--	--	--	13	13	< 5 U
trans-1,2-dichloroethene	--	--	--	< 5 U	< 5 U	< 5 U
trans-1,3-dichloropropene	--	--	--	< 5 U	< 5 U	< 5 U
Trichloroethylene	--	--	--	5.4	5.6	< 5 U
Trichlorofluoromethane (CFC-11)	--	--	--	< 5 U	< 5 U	< 5 U
Trichlorotrifluoroethane (Freon 113)	--	--	--	< 5 U	< 5 U	< 5 U
Vinyl Chloride	--	--	--	17	17	< 2 U
Xylene-o	--	--	--	0.63 J	0.64 J	< 5 U
Xylenes - m,p	--	--	--	0.92 J	0.86 J	< 5 U
Subtotal VOCs⁽⁴⁾	--	--	--	165	170	0
Tentatively Identified Compounds	--	--	--	ND	ND	ND
Subtotal TICs⁽⁵⁾	--	--	--	0.0	0.0	0.0
Total VOCs⁽⁶⁾	--	--	--	165	170	0

See notes on last page.

Table B-3. Water Sample Analytical Results - February 4, 2013, Groundwater Interim Remedial Measure, Operable Unit 3 (Former Grumman Settling Ponds), Bethpage, New York. ^(1,2,3)

COMPOUND (ug/L)	Sample ID: Sample Location: Sample Date:	WSP-02 RW-2 2/4/2013	WSP-03 RW-3 2/4/2013	WSP-05 Influent 2/4/2013	WSP-05 dup. Influent 2/4/2013	WSP-07 Effluent 2/4/2013
Metals						
Cadmium (Dissolved)		--	--	--	--	--
Cadmium (Total)		--	--	--	--	--
Chromium (Dissolved)		--	--	--	--	--
Chromium (Total)		--	--	--	--	--
Iron (Dissolved)		520	110	140	--	170
Iron (Total)		640	290	370	--	370
Manganese (Dissolved)		--	--	--	--	--
Manganese (Total)		--	--	--	--	--
Mercury (Dissolved)		--	--	--	--	--
Mercury (Total)		--	--	--	--	--

Notes:

(1)

Samples collected by ARCADIS on the dates shown and submitted to Columbia Analytical Services, Inc. for VOC analyses using New York State Department of Environmental Conservation ASP 2000 Method OLM 4.3 and metals using USEPA Method 6010, except for mercury, which was analyzed using USEPA Method 7470.

(2) Refer to Figure 3 of this OM&M Report for schematic sample locations.

(3) Results validated following protocols specified in the Sampling and Analysis Plan (Appendix A) of the Groundwater OM&M Manual (ARCADIS 2009).

(4) "Subtotal VOCs" represents the sum of individual concentrations of VOCs detected. Values shown have been rounded to the nearest whole number.

(5) "Subtotal TICs" represents the sum of individual TICs detected. Values shown have been rounded to the nearest whole number.

(6) "Total VOCs" represent the sum of VOCs and TICs detected. Values shown have been rounded to the nearest whole number.

Acronyms\Key:

Bold value indicates a detection.

- D Compound reported from the diluted analyses as the concentration in the initial analysis was outside the calibration range.
- dup. Duplicate.
- J Estimated value.
- ND TIC not detected.
- OM&M Operation, maintenance and monitoring.
- TIC Tentatively identified compound.
- USEPA United States Environmental Protection Agency.
- VOC Volatile organic compound.
- ug/L Micrograms per liter.
- Not analyzed.
- < 5 U Compound not detected above its laboratory quantification limit.
- B Compound found in an associated blank sample, presence may be suspect
- UB Compound considered non-detect due to associated blank contamination.

Table B-4. Water Sample Analytical Results - March 4, 2013, Groundwater Interim Remedial Measure, Operable Unit 3
 (Former Grumman Settling Ponds), Bethpage, New York. ^(1,2,3)

COMPOUND (ug/L)	Sample ID: Sample Location: Sample Date:	WSP-02 RW-2 3/4/2013	WSP-03 RW-3 3/4/2013	WSP-05 Influent 3/4/2013	WSP-07 Effluent 3/4/2013
<u>Volatile Organic Compounds</u>					
1,1,1-Trichloroethane		--	--	< 5 U	< 5 U
1,1,2,2-Tetrachloroethane		--	--	< 5 U	< 5 U
1,1,2-Trichloroethane		--	--	< 5 U	< 5 U
1,1-Dichloroethane		--	--	0.71 J	< 5 U
1,1-Dichloroethene		--	--	0.44 J	< 5 U
1,2-Dichloroethane		--	--	< 5 U	< 5 U
1,2-Dichloropropane		--	--	< 5 U	< 5 U
2-Butanone (MEK)		--	--	< 50 U	< 50 U
2-Hexanone (MBK)		--	--	< 50 U	< 50 U
4-methyl-2-pentanone (MIBK)		--	--	< 50 U	< 50 U
Acetone		--	--	< 50 U	< 50 U
Benzene		--	--	< 0.7 U	< 0.7 U
Bromodichloromethane		--	--	< 5 U	< 5 U
Bromoform		--	--	< 5 U	< 5 U
Bromomethane		--	--	< 5 U	< 5 U
Carbon Disulfide		--	--	< 5 U	< 5 U
Carbon tetrachloride		--	--	< 5 U	< 5 U
Chlorobenzene		--	--	< 5 U	< 5 U
Chlorodifluoromethane (Freon 22)		--	--	64	< 5 U
Chloroethane		--	--	< 5 U	< 5 U
Chloroform		--	--	1.7 J	< 5 U
Chloromethane		--	--	< 5 U	< 5 U
cis-1,2-dichloroethene		--	--	80	< 5 U
cis-1,3-dichloropropene		--	--	< 5 U	< 5 U
Dibromochloromethane		--	--	< 5 U	< 5 U
Dichlorodifluoromethane (Freon 12)		--	--	< 5 U	< 5 U
Ethylbenzene		--	--	2 J	< 5 U
Methyl tert-Butyl Ether		--	--	< 5 U	< 5 U
Methylene Chloride		--	--	< 5 U	< 5 U
Styrene		--	--	< 5 U	< 5 U
Tetrachloroethene		--	--	0.34 J	< 5 U
Toluene		--	--	59	< 5 U
trans-1,2-dichloroethene		--	--	< 5 U	< 5 U
trans-1,3-dichloropropene		--	--	< 5 U	< 5 U
Trichloroethylene		--	--	7.3	< 5 U
Trichlorofluoromethane (CFC-11)		--	--	< 5 U	< 5 U
Trichlorotrifluoroethane (Freon 113)		--	--	< 5 U	< 5 U
Vinyl Chloride		--	--	52	< 2 U
Xylene-o		--	--	2 J	< 5 U
Xylenes - m,p		--	--	4.1 J	< 5 U
Subtotal VOCs ⁽⁴⁾		--	--	274	0.0
Tentatively Identified Compounds		--	--	ND	ND
Subtotal TICs ⁽⁵⁾		--	--	0.0	0.0
Total VOCs ⁽⁶⁾		--	--	274	0

See notes on last page.

Table B-4. Water Sample Analytical Results - March 4, 2013, Groundwater Interim Remedial Measure, Operable Unit 3
(Former Grumman Settling Ponds), Bethpage, New York. ^(1,2,3)

COMPOUND (ug/L)	Sample ID: Sample Location: Sample Date:	WSP-02 RW-2 3/4/2013	WSP-03 RW-3 3/4/2013	WSP-05 Influent 3/4/2013	WSP-07 Effluent 3/4/2013
Metals					
Cadmium (Dissolved)		--	--	--	--
Cadmium (Total)		--	--	--	--
Chromium (Dissolved)		--	--	--	--
Chromium (Total)		--	--	--	--
Iron (Dissolved)		1,920	130	530	560
Iron (Total)		1,950	130	510	560
Manganese (Dissolved)		--	--	--	--
Manganese (Total)		--	--	--	--
Mercury (Dissolved)		--	--	--	--
Mercury (Total)		--	--	--	< 0.2 U

Notes:

- (1) Samples collected by ARCADIS on the dates shown and submitted to Columbia Analytical Services, Inc. for VOC analyses using New York State Department of Environmental Conservation ASP 2000 Method OLM 4.3 and metals using USEPA Method 6010, except for mercury, which was analyzed using USEPA Method 7470.
- (2) Refer to Figure 3 of this OM&M Report for schematic sample locations.
- (3) Results validated following protocols specified in the Sampling and Analysis Plan (Appendix A) of the Groundwater OM&M Manual (ARCADIS 2009).
- (4) "Subtotal VOCs" represents the sum of individual concentrations of VOCs detected. Values shown have been rounded to the nearest whole number.
- (5) "Subtotal TICs" represents the sum of individual TICs detected. Values shown have been rounded to the nearest whole number.
- (6) "Total VOCs" represent the sum of VOCs and TICs detected. Values shown have been rounded to the nearest whole number.

Acronyms\Key:

Bold value indicates a detection.

- D Compound reported from the diluted analyses as the concentration in the initial analysis was outside the calibration range.
- dup. Duplicate.
- J Estimated value.
- ND TIC not detected.
- OM&M Operation, maintenance and monitoring.
- TIC Tentatively identified compound.
- USEPA United States Environmental Protection Agency.
- VOC Volatile organic compound.
- ug/L Micrograms per liter.
- Not analyzed.
- < 5 U Compound not detected above its laboratory quantification limit.
- B Compound found in an associated blank sample, presence may be suspect
- UB Compound considered non-detect due to associated blank contamination.



Appendix C

Vapor Sample Analytical Results

Table C-1. Vapor Sample Analytical Results - February 4, 2013, Groundwater Interim Remedial Measure, Operable Unit 3
 (Former Grumman Settling Ponds), Bethpage, New York. ^(1,2,3)

COMPOUND (ug/m ³)	Location ID:	VSP-1	VSP-2	VSP-3	VSP-4	VSP-05
	Sample Location:	Influent	VPGAC Mid-Train	VPGAC Effluent	PPZ Mid-Train	Effluent
	Sample Date:	2/4/2013	2/4/2013	2/4/2013	2/4/2013	2/4/2013
<u>Volatile Organic Compounds</u>						
1,1,1-Trichloroethane		< 3.3 U	< 7.8 U	< 0.83 U	< 0.79 U	< 0.69 U
1,1,2,2-Tetrachloroethane		< 3.3 U	< 7.8 U	< 0.83 U	< 0.79 U	< 0.69 U
1,1,2-Trichloroethane		< 3.3 U	< 7.8 U	< 0.83 U	< 0.79 U	< 0.69 U
1,1-Dichloroethane		6.2	9.8	1.8	1.7	1.8
1,1-Dichloroethene		< 3.3 U	< 7.8 U	7.5	4.1	3.3
1,2-Dichloroethane		< 3.3 U	< 7.8 U	< 0.83 U	< 0.79 U	< 0.69 U
1,2-Dichloropropane		< 3.3 U	< 7.8 U	< 0.83 U	< 0.79 U	< 0.69 U
1,3-butadiene		< 3.3 U	< 7.8 U	< 0.83 U	< 0.79 U	< 0.69 U
1-Chloro-1,1-difluoroethane (CFC 142b)		< 3.3 U	< 7.8 U	< 0.83 U	< 0.79 U	< 0.69 U
2-Butanone (MEK)		< 33 U	< 78 U	< 8.3 U	< 7.9 U	< 6.9 U
2-Hexanone (MBK)		< 3.3 U	< 7.8 U	< 0.83 U	< 0.79 U	< 0.69 U
4-methyl-2-pentanone (MIBK)		< 3.3 U	< 7.8 U	< 0.83 U	< 0.79 U	< 0.69 U
Acetone		< 33 U	< 78 U	50	130	49
Benzene		< 3.3 U	< 7.8 U	1.9	< 0.79 U	1.1
Bromodichloromethane		< 3.3 U	< 7.8 U	< 0.83 U	< 0.79 U	< 0.69 U
Bromoform		< 3.3 U	< 7.8 U	< 0.83 U	< 0.79 U	< 0.69 U
Bromomethane		< 3.3 U	< 7.8 U	< 0.83 U	< 0.79 U	< 0.69 U
Carbon Disulfide		< 33 U	< 78 U	< 8.3 U	< 7.9 U	< 6.9 U
Carbon tetrachloride		< 3.3 U	< 7.8 U	< 0.83 U	< 0.79 U	< 0.69 U
Chlorobenzene		< 3.3 U	< 7.8 U	< 0.83 U	< 0.79 U	< 0.69 U
Chlorodifluoromethane (Freon 22)		730 D	800	680 D	720 D	820 D
Chloroethane		< 3.3 U	< 7.8 U	< 0.83 U	< 0.79 U	< 0.69 U
Chloroform		25	23	1.1	3.4	3.6
Chloromethane		< 3.3 U	< 7.8 U	< 0.83 U	< 0.79 U	< 0.69 U
cis-1,2-dichloroethene		560	1,100	47	91	46
cis-1,3-dichloropropene		< 3.3 U	< 7.8 U	< 0.83 U	< 0.79 U	< 0.69 U
Dibromochloromethane		< 3.3 U	< 7.8 U	< 0.83 U	< 0.79 U	< 0.69 U
Dichlorodifluoromethane (Freon 12)		< 3.3 U	< 7.8 U	2.3	2.5	2.6
Ethylbenzene		< 3.3 U	< 7.8 U	< 0.83 U	< 0.79 U	< 0.69 U
Methyl tert-Butyl Ether		< 3.3 U	< 7.8 U	< 0.83 U	< 0.79 U	< 0.69 U
Methylene Chloride		< 3.3 U	< 7.8 U	< 0.83 U	< 0.79 U	< 0.69 U
Styrene		< 3.3 U	< 7.8 U	< 0.83 U	< 0.79 U	< 0.69 U
Tetrachloroethene		< 3.3 U	< 7.8 U	< 0.83 U	< 0.79 U	< 0.69 U
Toluene		46	< 7.8 U	8.4	20	20
trans-1,2-dichloroethene		< 3.3 U	< 7.8 U	< 0.83 U	< 0.79 U	< 0.69 U
trans-1,3-dichloropropene		< 3.3 U	< 7.8 U	< 0.83 U	< 0.79 U	< 0.69 U
Trichloroethylene		63	< 7.8 U	< 0.83 U	6.0	4.6
Trichlorofluoromethane (CFC-11)		< 3.3 U	< 7.8 U	2.1	2.2	2.3
Trichlorotrifluoroethane (Freon 113)		< 3.3 U	< 7.8 U	< 0.83 U	< 0.79 U	< 0.69 U
Vinyl Chloride		210	200	220 D	150	57
Xylene-o		< 3.3 U	< 7.8 U	< 0.83 U	0.97	0.98
Xylenes - m,p		< 6.5 U	< 16 U	< 1.7 U	1.6	1.6
Subtotal VOCs ⁽⁴⁾		1,640	2,133	1,022	1,133	1,014

See notes on last page.

Table C-1. Vapor Sample Analytical Results - February 4, 2013, Groundwater Interim Remedial Measure, Operable Unit 3
(Former Grumman Settling Ponds), Bethpage, New York. ^(1,2,3)

COMPOUND (ug/m ³)	Location ID: Sample Location: Sample Date:	VSP-1 Influent 2/4/2013	VSP-2 VPGAC Mid-Train 2/4/2013	VSP-3 VPGAC Effluent 2/4/2013	VSP-4 PPZ Mid-Train 2/4/2013	VSP-05 Effluent 2/4/2013
<u>Tentatively Identified Compounds</u>						
2-Butoxyethanol		--	--	4.7 JN	13 JN	--
2-Ethyl- 1-Hexanol		--	--	4.6 JN	3.6 JN	--
2-Methylundecane		--	--	--	--	55 JN
2-Phenyl-2-Propanol		--	--	180 JN	100 JN	47 JN
3-Methylundecane		--	--	--	3.7 JN	--
3-Penten-2-one		--	--	--	3.7 JN	--
4-Methylundecane		--	--	--	--	37 JN
Acetaldehyde		--	--	--	3.6 JN	--
Acetophenone		--	--	55 JN	13 JN	27 JN
BUTANE		--	--	4 JN	3.6 JN	--
C8H18 Branched Alkane with the Highest Concentration		--	--	--	11 JN	--
Dodecane		--	--	--	--	43 JN
Hexamethyl Cyclotrisloxane		--	63 JN	46 JN	10 JN	--
Isobutane		--	--	3.5 JN	--	--
Pentane		--	--	28 JN	--	--
Pentylcyclohexane		--	--	--	--	33 JN
Propylene Glycol		--	--	--	10 JN	--
Trimethylsilanol		--	--	18 JN	--	--
Undecane		--	--	--	--	31 JN
Unknown C11H20 Compound with the 1st highest Conc.		--	--	--	--	29 JN
Unknown C11H20 Compound with the 2nd highest Conc.		--	--	--	--	27 JN
Unknown C12H26 Branched Alkane with the 1st highest Conc.		--	--	--	3.8 JN	73 JN
Unknown C12H26 Branched Alkane with the 2nd highest Conc.		--	--	--	--	63 JN
Unknown C12H26 Branched Alkane with the 3rd highest Conc.		--	--	--	--	32 JN
Unknown C12H26 Branched Alkane with the 4rd highest Conc.		--	--	--	--	27 JN
Unknown C12H26 Branched Alkane with the 5th highest Conc.		--	--	--	--	21 JN
Unknown C13H28 Branched Alkane with the 1st highest Conc.		--	--	--	--	39 JN
Unknown with the 1st highest Conc.		--	--	33 JN	--	23 JN
Unknown with the 2nd highest Conc.		--	--	--	--	19 JN
Unknown with the 3rd highest Conc.		--	--	--	--	19 JN
Unknown with the 4th highest Conc.		--	--	--	--	17 JN
Unknown with the 5th highest Conc.		--	--	--	--	16 JN
Subtotal TICs ⁽⁵⁾		0	63	377	179	678
Total VOCs ⁽⁶⁾		1,640	2,196	1,399	1,312	1,692

See notes on last page.

Table C-1. Vapor Sample Analytical Results - February 4, 2013, Groundwater Interim Remedial Measure, Operable Unit 3
(Former Grumman Settling Ponds), Bethpage, New York. ^(1,2,3)

Notes:

- (1) Samples collected by ARCADIS on the dates shown and submitted to Columbia Analytical Services, Inc. for VOC analyses per Modified USEPA Method TO-
- (2) Refer to Figure 3 of this OM&M Report for schematic sample locations.
- (3) Results validated following protocols specified in the Sampling and Analysis Plan (Appendix A) of the Groundwater OM&M (ARCADIS 2009).
- (4) "Subtotal VOCs" represents the sum of individual concentrations of VOCs detected. Values shown have been rounded to the nearest whole number.
- (5) "Subtotal TICs" represents the sum of individual top 20 TICs detected. Values shown have been rounded to the nearest whole number.
- (6) "Total VOCs" represent the sum of VOCs and TICs detected. Values shown have been rounded to the nearest whole number.

Acronyms\Key:

Bold value indicates a detection.

D	Concentration is based on a diluted sample analysis.
JN	Compound tentatively identified, concentration is estimated.
OM&M	Operation, maintenance and monitoring.
TIC	Tentatively identified compound.
USEPA	United States Environmental Protection Agency.
VOC	Volatile organic compound.
ug/m ³	Micrograms per cubic meter.
< 9.2 U	Compound not detected above its laboratory quantification limit.
--	TIC not detected.



Appendix D

Air Discharge Quality Evaluation

Table D-1. Annual Summary of SCREEN3 Model Input and Outputs, Groundwater Interim Remedial Measure, Operable Unit 3 (Former Grumman Settling Ponds), Bethpage, New York.

Parameters	Date Sampled:	04/03/12	07/05/12	10/03/12	12/03/12	02/04/13
SCREEN3 Model Input						
Source Type		Point	Point	Point	Point	Point
Emission Rate (g/s)		1	1	1	1	1
Stack Height (ft)		13.5	13.5	13.5	13.5	13.5
Stack Height (m)		4.1	4.1	4.1	4.1	4.1
Stack Inside Diameter (m)		0.36	0.36	0.36	0.36	0.36
Air Flow Rate (scfm) ^{(1),(9),(11)}		2,079	2,020	1,813	1,962	1,885
Air Flow Rate (acfm @ stack temp) ⁽²⁾		2,087	2,053	1,839	1,974	1,866
Stack Gas Exit Temperature (K) ^{(1),(9),(10)}		296	299	299	296	291
Ambient Air Temperature (K) ⁽³⁾		284	302	294	284	271
Receptor Height (m) ⁽⁴⁾		1.5	1.5	1.5	1.5	1.5
Urban/Rural		Urban	Urban	Urban	Urban	Urban
Building Height (m)		2.6	2.6	2.6	2.6	2.6
Min Horizontal Bldg Dim (m)		7.9	7.9	7.9	7.9	7.9
Max Horizontal Bldg Dim (m)		9.8	9.8	9.8	9.8	9.8
Consider Bldg Downwash?		Yes	Yes	Yes	Yes	Yes
Simple/Complex Terrain Above Stack		Simple	Simple	Simple	Simple	Simple
Simple/Complex Terrain Above Stack Base		Simple	Simple	Simple	Simple	Simple
Meteorology		Full	Full	Full	Full	Full
Automated Distances Array		Yes	Yes	Yes	Yes	Yes
Terrain Height Above Stack Base		0	0	0	0	0
SCREEN3 Model Output						
1-HR Max Concentration at Receptor Height ($\mu\text{g}/\text{m}^3$) ⁽⁵⁾		1,936	1,950	2,229	2,059	2,215
Annualization Factor ⁽⁶⁾		0.08	0.08	0.08	0.08	0.08
Average Annual Concentration at Receptor Height ($\mu\text{g}/\text{m}^3$) ⁽⁷⁾		154.9	156	178.3	164.7	177.2
Distance To Max Concentration (m) ⁽⁸⁾		8	8	8	8	8

See notes on last page.

Table D-1. Annual Summary of SCREEN3 Model Input and Outputs, Groundwater Interim Remedial Measure, Operable Unit 3 (Former Grumman Settling Ponds), Bethpage, New York.

Notes:

- (1) The stack air flow rate (in scfm) and temperature were measured using inline instrumentation. Values were measured at the blower effluent location.
- (2) The stack air flow rate at the stack temperature (in acfm) was calculated by dividing the stack air flow rate in scfm by the ratio of the standard temperature to the actual stack gas exit temperature in degrees Rankine.
- (3) The ambient temperature was recorded from the weather.newsday.com and/or weather underground (www.wunderground.com) websites for Islip, New York. The mean actual temperature from the website(s) was used in model calculation.
- (4) The receptor height corresponds to the average inhalation level.
- (5) SCREEN3 calculated constituent concentration at listed conditions at the specified inhalation level.
- (6) A USEPA time averaging conversion factor of 1/0.08 was used to convert the 1-hour maximum concentration output to an annual average.
- (7) Average annual constituent concentration at the receptor height was calculated by multiplying the one hour maximum concentration by the annualization factor.
- (8) SCREEN3 calculated distance to the 1-hour maximum concentration.
- (9) Stack Air Flow Rate and Exit Temperature parameter readings were recorded on October 3, 2012 at the time of October 3, 2012 air sample collection.
- (10) Mid-Train temperature was used for stack exit temperature as stack exit temperature was not recorded at the time of October 3, 2012 air sample collection.
- (11) Beginning with the January 2013 site visit the air flow rate in scfm is obtained from SCADA HMI.

Acronyms/Key:

$\mu\text{g}/\text{m}^3$	Micrograms per cubic meter.
acfm	Actual cubic feet per minute.
ft	Feet.
g/s	Grams per second.
K	Kelvin.
m	Meters.
scfm	Standard cubic feet per minute.
USEPA	United States Environmental Protection Agency.

Table D-2. Annual Summary of Maximum Allowable Stack Concentration Calculations, Groundwater Interim Remedial Measure, Operable Unit 3 (Former Grumman Settling Ponds), Bethpage, New York.

Compound	Actual Effluent Concentrations ⁽¹⁾ (µg/m ³)				
	04/03/12	07/05/12	10/03/12	12/03/12	02/04/13
1,1 - Dichloroethane	0	0.82	1.1	1.8	1.8
1,1 - Dichloroethene	0	0	0	1.0	3.3
Acetone	260	140	56	98	49
Chloroform	0	3	3.9	5.6	3.6
Ethylbenzene	0	0	0.84	0.96	0
Xylenes (o)	0	0	0.91	1.5	0.98
Xylenes (m,p)	0	0	1.9	2.8	1.6
Chloromethane	0	0	0	0.77	0
Trichloroethene	0	1.6	3.1	4.3	4.6
Vinyl Chloride	8.4	0	7.9	23	57
cis 1,2-Dichloroethene	13	1.9	9.6	25	46
Benzene	13	0.96	0	1.9	1.1
Toluene	26	27	37	38	20
Trichlorofluoromethane (Freon 11)	0	0	1.9	3.0	2.3
Dichlorodifluoromethane (Freon 12)	0	2.9	3.1	3.5	2.6
Chlorodifluoromethane (Freon 22)	1,800	1,000	1,000	1,100	820

See notes on last page.

Table D-2. Annual Summary of Maximum Allowable Stack Concentration Calculations, Groundwater Interim Remedial Measure, Operable Unit 3 (Former Grumman Settling Ponds), Bethpage, New York.

Compound	AGC ⁽²⁾ (µg/m ³)	Maximum Allowable Stack Concentration ⁽³⁾ (µg/m ³)				
		04/03/12	07/05/12	10/03/12	12/03/12	02/04/13
1,1 - Dichloroethane	0.63	4.13E+03	4.17E+03	4.07E+03	4.11E+03	4.04E+03
1,1 - Dichloroethene	70	4.59E+05	4.63E+05	4.52E+05	4.56E+05	4.49E+05
Acetone	30,000	1.97E+08	1.98E+08	1.94E+08	1.96E+08	1.92E+08
Chloroform	0.043	2.82E+02	2.84E+02	2.78E+02	2.80E+02	2.76E+02
Ethylbenzene	1,000	6.55E+06	6.62E+06	6.46E+06	6.52E+06	6.41E+06
Xylenes (o)	100	6.55E+05	6.62E+05	6.46E+05	6.52E+05	6.41E+05
Xylenes (m,p)	100	6.55E+05	6.62E+05	6.46E+05	6.52E+05	6.41E+05
Chloromethane	90	5.90E+05	5.95E+05	5.82E+05	5.87E+05	5.77E+05
Trichloroethene	0.5	3.28E+03	3.31E+03	3.23E+03	3.26E+03	3.20E+03
Vinyl Chloride	0.11	7.21E+02	7.28E+02	7.11E+02	7.17E+02	7.05E+02
cis 1,2 Dichloroethene	63	4.13E+05	4.17E+05	4.07E+05	4.11E+05	4.04E+05
Benzene	0.13	8.52E+02	8.60E+02	8.40E+02	8.47E+02	8.33E+02
Toluene	5,000	3.28E+07	3.31E+07	3.23E+07	3.26E+07	3.20E+07
Trichlorofluoromethane (Freon 11)	5,000	3.28E+07	3.31E+07	3.23E+07	3.26E+07	3.20E+07
Dichlorodifluoromethane (Freon 12)	12,000	7.87E+07	7.94E+07	7.75E+07	7.82E+07	7.69E+07
Chlorodifluoromethane (Freon 22)	50,000	3.28E+08	3.31E+08	3.23E+08	3.26E+08	3.20E+08

See notes on last page.

Table D-2. Annual Summary of Maximum Allowable Stack Concentration Calculations, Groundwater Interim Remedial Measure, Operable Unit 3 (Former Grumman Settling Ponds), Bethpage, New York.

Compound	Percent of Maximum Allowable Stack Concentration ⁽⁴⁾				
	04/03/12	07/05/12	10/03/12	12/03/12	02/04/13
1,1 - Dichloroethane	0.00%	0.02%	0.03%	0.04%	0.04%
1,1 - Dichloroethene	0.00%	0.00%	0.00%	0.00%	0.00%
Acetone	0.00%	0.00%	0.00%	0.00%	0.00%
Chloroform	0.00%	1.09%	1.40%	2.00%	1.31%
Ethylbenzene	0.00%	0.00%	0.00%	0.00%	0.00%
Xylenes (o)	0.00%	0.00%	0.00%	0.00%	0.00%
Xylenes (m,p)	0.00%	0.00%	0.00%	0.00%	0.00%
Chloromethane	0.00%	0.00%	0.00%	0.00%	0.00%
Trichloroethene	0.00%	0.05%	0.10%	0.13%	0.14%
Vinyl Chloride	1.17%	0.00%	1.11%	3.21%	8.09%
cis 1,2 Dichloroethene	0.00%	0.00%	0.00%	0.01%	0.01%
Benzene	1.53%	0.11%	0.00%	0.22%	0.13%
Toluene	0.00%	0.00%	0.00%	0.00%	0.00%
Trichlorofluoromethane (Freon 11)	0.00%	0.00%	0.00%	0.00%	0.00%
Dichlorodifluoromethane (Freon 12)	0.00%	0.00%	0.00%	0.00%	0.00%
Chlorodifluoromethane (Freon 22)	0.00%	0.00%	0.00%	0.00%	0.00%

Notes:

- (1) Actual effluent concentrations are analytical results from air samples collected on the dates shown. Data in this table corresponds to approximately the past year of system operation.
- (2) AGC refers to the compound-specific annual guideline concentration per the NYSDEC DAR-1 AGC/SGC tables, revised October 18, 2010.
- (3) Maximum allowable stack concentrations were calculated by dividing the product of the annual guideline concentration of a compound and the ratio of the SCREEN3 gas emission rate and the SCREEN 3 average concentration at receptor height by the air flow rate at the stack temperature and multiplying by the appropriate conversion factors.
- (4) Percent of MASC was calculated by dividing the actual effluent concentration by the MASC for a given monitoring event.

Acronyms\Key:

- µg/m³ Micrograms per cubic meter.
- AGC Annual guideline concentration.
- MASC Maximum allowable stack concentration.