

**Operation, Maintenance, and
Monitoring Report for the
Groundwater Interim Remedial
Measure**

2012 Annual Summary

Operable Unit 3 (Former Grumman Settling Ponds)
Bethpage, New York

NYSDEC ID # 1-30-003A



Salvatore Tedesco
Staff Environmental Engineering Specialist

William S. Wittek, PE
Senior Engineer

Carlo San Giovanni
Project Manager

**Operation, Maintenance, and
Monitoring Report for the
Groundwater Interim Remedial
Measure**

2012 Annual Summary

Operable Unit 3 (Former
Grumman Settling Ponds)
Bethpage, New York

NYSDEC ID# 1-30-003A

Prepared for:
Northrop Grumman Systems Corporation

Prepared by:
ARCADIS of New York, Inc.
Two Huntington Quadrangle
Suite 1S10
Melville
New York 11747
Tel 631 249 7600
Fax 631 249 7610

Our Ref.:
NY001496.1112.GWSI4

Date:
May 23, 2013

*This document is intended only for the use
of the individual or entity for which it was
prepared and may contain information that
is privileged, confidential and exempt from
disclosure under applicable law. Any
dissemination, distribution or copying of
this document is strictly prohibited.*

1. Introduction	1
2. Groundwater Interim Remedial Measure Objectives	2
3. Groundwater Interim Remedial Measure Description	3
4. Operation and Maintenance Activities	4
4.1 Fourth Quarter 2012	4
4.2 2012 Annual System Performance and Alarm Summary	5
5. Treatment System Compliance and Performance Monitoring	7
5.1 Fourth Quarter 2012 System Monitoring Activities	7
5.2 2012 System Monitoring Activities	9
5.3 Summary of OM&M Results and Conclusions	9
5.3.1 System Operation and Effectiveness	9
5.3.2 Regulatory Status of Discharges	11
5.3.2.1 Air Discharge	11
5.3.2.2 Water Discharge	12
6. Environmental Effectiveness Monitoring	12
6.1 Hydraulic Monitoring	12
6.1.1 Activities	12
6.1.2 Results	12
6.2 Groundwater Quality Monitoring	13
6.2.1 Activities	13
6.2.2 Results	14
6.3 Environmental Effectiveness Monitoring Conclusions	15
7. Groundwater IRM Recommendations	15
8. Certification	16
9. References	17

Tables

Table 1	Operational Summary, Groundwater Interim Remedial Measure, Operable Unit 3 (Former Grumman Settling Ponds), Bethpage, New York.
Table 2	Summary of Influent Water Sample Analytical Results, Groundwater Interim Remedial Measure, Operable Unit 3 (Former Grumman Settling Ponds), Bethpage, New York.
Table 3	Summary of Effluent Water Sample Analytical Results, Groundwater Interim Remedial Measure, Operable Unit 3 (Former Grumman Settling Ponds), Bethpage, New York.
Table 4	Summary of Influent Vapor Sample Analytical Results, Groundwater Interim Remedial Measure, Operable Unit 3 (Former Grumman Settling Ponds), Bethpage, New York.
Table 5	Summary of Effluent Vapor Sample Analytical Results, Groundwater Interim Remedial Measure, Operable Unit 3 (Former Grumman Settling Ponds), Bethpage, New York.
Table 6	Summary of System Parameters, Groundwater Interim Remedial Measure, Operable Unit 3 (Former Grumman Settling Ponds), Bethpage, New York.
Table 7	Summary of Groundwater Recovered, VOC Mass Recovered, and VOC Mass Recovery Rates, Groundwater Interim Remedial Measure, Operable Unit 3 (Former Grumman Settling Ponds), Bethpage, New York.
Table 8	Summary of Air Emissions Model Output, Groundwater Interim Remedial Measure, Operable Unit 3 (Former Grumman Settling Ponds), Bethpage, New York.
Table 9	Concentrations of Volatile Organic Compounds in Groundwater Samples Collected from Remedial Wells, Groundwater Interim Remedial Measure, Operable Unit 3 (Former Grumman Settling Ponds), Bethpage, New York.
Table 10	Concentrations of Metals in Groundwater Samples Collected from Remedial Wells, Groundwater Interim Remedial Measure, Operable Unit 3 (Former Grumman Settling Ponds), Bethpage, New York.
Table 11	Summary of Water-Level Elevations, Groundwater Interim Remedial Measure, Operable Unit 3 (Former Grumman Settling Ponds), Bethpage, New York.
Table 12	Summary of Calculated Vertical Hydraulic Gradients, Groundwater Interim Remedial Measure, Operable Unit 3 (Former Grumman Settling Ponds), Bethpage, New York.

- Table 13 Concentrations of Volatile Organic Compounds in Groundwater Samples Collected from Monitoring Wells, Groundwater Interim Remedial Measure, Operable Unit 3 (Former Grumman Settling Ponds), Bethpage, New York.
- Table 14 Concentrations of Metals in Groundwater Samples Collected from Monitoring Wells, Groundwater Interim Remedial Measure, Operable Unit 3 (Former Grumman Settling Ponds), Bethpage, New York.

Figures

- Figure 1 Site Area Location , Groundwater Interim Remedial Measure, Operable Unit 3 (Former Grumman Settling Ponds), Bethpage, New York.
- Figure 2 Site and Groundwater Interim Remedial Measure Layout, Groundwater Interim Remedial Measure, Operable Unit 3 (Former Grumman Settling Ponds), Bethpage, New York.
- Figure 3 Groundwater Treatment System Process Schematic, Process Flow Diagram and Monitoring Locations, Groundwater Interim Remedial Measure, Operable Unit 3 (Former Grumman Settling Ponds), Bethpage, New York.
- Figure 4 Groundwater Monitoring Well Network and Configuration of the Shallow Potentiometric Surface and Groundwater Flow Directions Fourth Quarter 2012, Groundwater Interim Remedial Measure, Operable Unit 3 (Former Grumman Settling Ponds), Bethpage, New York.
- Figure 5 Cumulative Total, Project, and Non-Project VOC Mass Removed Through December 2012, Groundwater Interim Remedial Measure, Operable Unit 3 (Former Grumman Settling Ponds), Bethpage, New York.
- Figure 6A Remedial Well Total VOC Concentrations Through December 2012, Groundwater Interim Remedial Measure, Operable Unit 3 (Former Grumman Settling Ponds), Bethpage, New York.
- Figure 6B Remedial Well Project VOC Concentrations Through December 2012, Groundwater Interim Remedial Measure, Operable Unit 3 (Former Grumman Settling Ponds), Bethpage, New York.
- Figure 6C Remedial Well Non-Project VOC Concentrations Through December 2012, Groundwater Interim Remedial Measure, Operable Unit 3 (Former Grumman Settling Ponds), Bethpage, New York.
- Figure 7 Influent Total, Project, and Non-Project VOC Concentrations Through December 2012, Groundwater Interim Remedial Measure, Operable Unit 3 (Former Grumman Settling Ponds), Bethpage, New York.

- Figure 8A Total VOC Mass Recovery Rates Through December 2012, Groundwater Interim Remedial Measure, Operable Unit 3 (Former Grumman Settling Ponds), Bethpage, New York.
- Figure 8B Project VOC Mass Recovery Rates Through December 2012, Groundwater Interim Remedial Measure, Operable Unit 3 (Former Grumman Settling Ponds), Bethpage, New York.
- Figure 8C Non-Project VOC Mass Recovery Rates Through December 2012, Groundwater Interim Remedial Measure, Operable Unit 3 (Former Grumman Settling Ponds), Bethpage, New York.
- Figure 9 Cross Section D-D' Showing TVOCs in Groundwater and Direction of Vertical Groundwater Hydraulic Gradients Fourth Quarter 2012, Groundwater Interim Remedial Measure, Operable Unit 3 (Former Grumman Settling Ponds), Bethpage, New York

Appendices

- A Well Construction Information and Environmental Effectiveness Monitoring Program
- B Compliance and Performance Program and Water Sample Analytical Results
- C Vapor Sample Analytical Results
- D Air Discharge Quality Evaluation

1. Introduction

Pursuant to the Administrative Order on Consent (AOC) Index # W1-0018-04-01 (NYSDEC 2005), ARCADIS of New York, Inc. (ARCADIS), on behalf of Northrop Grumman Systems Corporation (Northrop Grumman), has prepared this Operable Unit 3 (OU3) Groundwater Interim Remedial Measure (Groundwater IRM) Annual Operation, Maintenance, and Monitoring (OM&M) Report for submittal to the New York State Department of Environmental Conservation (NYSDEC). The present day Bethpage Community Park property (Park) and the Former Grumman Plant 24 Access Road, which the NYSDEC has termed the “Former Grumman Settling Ponds Area” and designated as OU3, are referred to herein as the Site Area. A Site Area Location map is provided on Figure 1.

The Groundwater IRM has been operational since July 21, 2009. This report summarizes the OM&M activities conducted, data collected, summary of system alarms, conclusions, recommendations, and engineering certification for the Groundwater IRM during 2012 (i.e. From January 1 to December 31, 2012). Additionally, this report summarizes the OM&M activities performed during the fourth Quarter of 2012 (i.e. October 1 through December 31, 2012 [the “reporting period”]). Detailed OM&M summaries for the previous three 2012 operational quarterly periods are available in the following reports (2012 Quarterly Reports):

- Quarterly OM&M Report for the Groundwater IRM, January 1 through March 31 (ARCADIS 2012a)
- Quarterly OM&M Report for the Groundwater IRM, April 1 through June 31 (ARCADIS 2012b)
- Quarterly OM&M Report for the Groundwater IRM, July 1 through September 31 (ARCADIS 2012c)

During 2012, Remedial System and Environmental Effectiveness Monitoring Programs were conducted in accordance with the NYSDEC-approved OU3 Interim Groundwater IRM OM&M Manual (OM&M Manual) (ARCADIS 2009).

As discussed in the OU3 Site Area Remedial Investigation Report (Site Area RI) (ARCADIS 2011a), Northrop Grumman does not take responsibility for certain compounds (e.g., Freon 12 and Freon 22) present in the Site Area. Throughout this

report, a distinction is made between the “Project” and “Non-Project” Volatile Organic Compounds (VOCs), which are defined as follows:

- “Project VOCs:” are VOCs that may be related to former Grumman historical activities. For this report, Project VOCs are the VOCs listed in the Interim State Pollutant Elimination Discharge System (SPDES) permit equivalency (NYSDEC 2009), plus Toluene, Benzene, and Total Xylenes. A list of “Project VOCs” is provided in various tables throughout this report.
- “Non-Project VOCs:” are VOCs, such as Freon 12 and Freon 22 that are not related to former Grumman activities but have been detected in the Site Area. As noted in the Site Area RI (ARCADIS 2011a), a sub-plume of Freon 22 has been identified originating from the area of the Town of Oyster Bay’s (Town’s) former ice rink (shown on Figure 2). Based on Town information (Zervos, Theodore 2007), Freon 22 was used and released to the environment.

2. Groundwater Interim Remedial Measure Objectives

The remedial action objectives (RAOs) for the Groundwater IRM are as follows:

- Mitigate the off-site migration of project-related, dissolved-phase VOCs. Specifically, the Groundwater IRM addresses:
 - Groundwater that has total volatile organic compound (TVOC) concentrations greater than 5 micrograms per liter ($\mu\text{g/L}$) in the upper 20 feet of the surficial aquifer across the 1,200-foot wide lateral extent of the southern Site Area boundary.
 - Groundwater below the upper 20 feet of the surficial aquifer that has TVOC concentrations greater than 50 $\mu\text{g/L}$.
- Comply with applicable NYSDEC standards, criteria and guidance values (SCGs) for treated water and air emissions.

A secondary benefit of the Groundwater IRM is the creation of a clean-water front atop the downgradient groundwater, which minimizes the potential for vapor intrusion downgradient of the Site Area.

3. Groundwater Interim Remedial Measure Description

The Groundwater IRM consists of:

- A “pump-and-treat system” where groundwater is:
 - Extracted along the southern portion of the Northrop Grumman Former Plant 24 Access Road via four remedial wells.
 - Conveyed to a treatment plant at McKay Field via four underground pipelines.
 - Treated via air stripping to reduce concentrations of Project and Non-Project VOCs.
 - Filtered to remove oxidized metals.
 - Returned to the aquifer, via a discharge pipeline routed to a recharge basin located on the adjacent former Bethpage Navy Weapons Industrial Reserve Plant (NWIRP) property.
- A vapor phase treatment system that reduces concentrations of Project VOCs in the air stripper off-gas prior to discharge to the atmosphere.
- A Groundwater Monitoring Network that is periodically monitored to assess the environmental effectiveness of the Groundwater IRM.

The major components of the Groundwater IRM are:

- Four Remedial Wells (RW-1, RW-2, RW-3, and RW-4) with design pumping rates of 30 gallons per minute (gpm), 75 gpm, 75 gpm, and 30 gpm, respectively; for a total design influent rate of 210 gpm.
- One low-profile air stripper to remove VOCs from the extracted groundwater prior to discharge to the recharge basins.
- Two bag filters configured so that one is “operational” and the other is in “stand by” mode. The system control logic switches from the “operational” filter unit to the “stand by” filter unit automatically to prevent a shut down.

- Four emission control units (ECUs), two containing vapor phase granular activated carbon (VPGAC) and two containing potassium permanganate-impregnated zeolite (PPZ). The VPGAC ECUs treat the Project VOCs in the air stripper off gas, except for vinyl chloride, which is treated by the PPZ ECUs.
- The Groundwater Monitoring Network consists of 35 monitoring locations (i.e., 17 groundwater monitoring wells, 4 remedial wells, and 14 piezometers).

Additional information is provided in the OM&M Manual (ARCADIS 2009). The layout of the Groundwater IRM is shown on Figure 2 and a schematic drawing is provided on Figure 3. The groundwater sampling locations that form the Groundwater Monitoring Network are shown on Figure 4. Construction details for the monitoring wells and piezometers are provided in Appendix A.

4. Operation and Maintenance Activities

4.1 Fourth Quarter 2012

Groundwater IRM operation and maintenance (O&M) activities conducted during the reporting period are described below and are summarized in Table 1:

- The system operated full-time, 87 out of 92 days (95 percent uptime).
- RW-2 operated at diminished flows (between 87% to 96% of design) during this quarter likely due to iron build-up in influent pipeline and valves.
- The system was monitored during the majority of business days, either via a site visit or remotely by wireless computer link-up.
- The Supervisory Control and Data Acquisition (SCADA) system operated as designed, and when conditions warranted (see below), shut the system down automatically and instantaneously, and provided notification of system advisories and alarms to plant operators.
- Intentional system shut downs were as follows (see Table 1 for more information):
 - Air Stripper periodic maintenance (October 3 and October 17, 2012)
 - Hurricane Sandy Emergency Preparedness (October 28, 2012)

- Nor'easter Emergency Preparedness (November 7, 2012)
- Remedial Well RW-2 preventative quarterly maintenance, Remedial Well RW-3 rehabilitation to address iron fouling issues (December 5 to December 6, 2012)
- System shut downs due to alarm conditions were as follows (see Table 1 for more information):
 - Bag filter fault (October 20, 2012): Problem: Both bag filters clogged up over the weekend before an operator was able to respond to the alarm.

4.2 2012 Annual System Performance and Alarm Summary

The 2012 system operation up-time is provided on Table 1 and summarized below. System shut downs that occurred in 2012 are summarized below, and are described in the three 2012 Quarterly Reports (ARCADIS 2012a, ARCADIS 2012b, and ARCADIS 2012c) and in this report. In general, system operation in 2012 is consistent with operation in previous years.

In 2012:

- The system operated full-time 353, out of 366 days (96 percent uptime).
- RW-2 operated at diminished flows (between 87% to 99% of design) starting in September 2012 likely due to iron build-up in influent pipeline and valves.
- There were 27 system shutdowns, of which:
 - Five (5) were due to a temporary power interruptions or suspected poor local power service.
 - Ten (10) intentional shutdowns for system maintenance (e.g. periodic preventative system maintenance or required system repairs/upgrade).
 - Two (2) intentional shutdowns were prior to severe weather events (Hurricane Sandy and a Nor'easter). System was shut down prior to the arrival of severe storms and was restarted when it was considered safe to do so.

- Eleven (11) were due to alarm conditions encountered during the normal operation of the system:
 - One (1) was due to iron build-up on/in a remedial well pump which caused a low-pressure condition and motor overload.
 - Four (4) were due to low pressure/motor overloads caused by electrical shorts in motor leads and wiring faults.
 - Two (2) were due to iron precipitate build-up in the air stripper which caused blower high-pressure conditions.
 - Two (2) were caused when the second bag filter clogged before an operator could change out the first spent bag filter.
 - Two (2) were caused by a faulty check valve which stayed open after the building sump pump was shut off during bag filter changes.

For the most part, the system was able to be restarted without incident the same day or the following day that an alarm occurred.

As shown above, the majority of the operational issues were related to: (a) electrical issues at the remedial wells, and (b) iron fouling issues.

To address the electrical wiring issues it is recommended that a visual inspection of pump wire leads be completed during well rehabilitation activities and wire leads be replaced if abrasion or other damage to wire insulation is visually apparent.

To address iron-related problems, the following work was performed:

- Continued rehabilitation maintenance of Remedial Well RW-2 and Remedial Well RW-3 on a quarterly schedule with Aqua Gard™ treatments.
- Continued periodic power washings of the air stripper.
- Sump pump check valve was removed and cleaned of iron build-up.

While the above measures did not eliminate the problems associated with iron fouling, they have lessened the impacts and provide a means to manage problematic iron

fouling and maintain system uptime. The quarterly maintenance events at Remedial Wells RW-2 and RW-3 and the air stripper cleanings helped reduce the iron-fouling related system shutdowns (low pressure and pump motor overloads) from four events in 2011 to one event in 2012, and there were no more check valve related shut downs after the check valve was cleaned.

As reported in Section 4.2 above, the desired RW-2 pumping rate of 75 gpm could not be maintained starting in September 2012 likely due to iron build-up in the pipeline and valves. Maintenance work is scheduled for 1Q2013 and 2Q2013 to remove iron build-up in both the RW-2 and RW-3 pipeline and valves.

5. Treatment System Compliance and Performance Monitoring

5.1 Fourth Quarter 2012 System Monitoring Activities

The following compliance and performance monitoring events were performed during this reporting period (see Appendix B, Table B-1 for a summary of the compliance and performance monitoring program requirements):

- Three (3) sampling events to collect required water samples and air samples.
- Thirteen (13) weekly site visits to monitor and record key system operational parameters.
- The following additional, non-routine monitoring activities were performed during this reporting period to assess system performance:
 - On November 12 and December 3, 2012, RW-2, RW-3 and treatment system influent water samples were collected and analyzed for total and dissolved iron (Fe). Results are provided in Appendix B.
 - On December 3, 2012, treatment system influent, effluent and mid-train vapor samples were collected and analyzed for VOCs to monitor media usage rates and assist in determining changeout scheduling of VPGAC and PPZ ECUs. Results are provided in Appendix C.

The system operation and monitoring results are summarized in the following tables, graphs, and appendices:

- An Operational Summary, including monitoring events, system operational days, and noteworthy site activities (Table 1).
- Summary of Influent and Effluent Water Sample Analytical Results (Tables 2 and 3, respectively). Table 3 also provides the Groundwater IRM treatment system removal efficiency. Complete validated Water Sample Analytical Result Summaries for each sampling event are included in Appendix B.
- Summary of Influent and Effluent Vapor Sample Analytical Results (Tables 4 and 5, respectively). Table 5 also provides the Groundwater IRM treatment system removal efficiency. Complete, validated Vapor Sample Analytical Results, for each sample event, are included in Appendix C.
- System Parameters including flow rates, line pressures, and temperatures (Table 6).
- Summaries of Groundwater Recovered, VOC Mass Recovered, and VOC Recovery Rates (Table 7). Table 7 provides a breakdown of these parameters by Remedial Well and System and also breaks down the VOC Mass Recovered and VOC Recovery Rates into Project, Non-Project, and Total VOCs.
- Air Discharge Quality Evaluation and Compliance Table (Appendix D and Table 8, respectively).
- Concentrations of VOCs and Metals in Remedial Well Groundwater Samples (Tables 9 and 10, respectively).
- Cumulative Total, Project, and Non-Project VOC Mass Removed (Figure 5).
- Remedial Well Total, Project, and Non-Project VOC Concentrations (Figures 6A, 6B, and 6C, respectively).
- Influent Total, Project, and Non-Project VOC Concentrations (Figure 7).
- Total, Project, and Non-Project VOC Mass Recovery Rates (Figures 8A, 8B, and 8C, respectively).

5.2 2012 System Monitoring Activities

In addition to the system monitoring discussed above, the system compliance and performance monitoring activities performed during the previous three quarterly periods are described in the 2012 Quarterly Reports (ARCADIS 2012a, ARCADIS 2012b, and ARCADIS 2012c).

5.3 Summary of OM&M Results and Conclusions

5.3.1 System Operation and Effectiveness

Groundwater IRM OM&M results and conclusions for the reporting period and 2012 are summarized below:

- Total volume of groundwater recovered and treated (Table 7):
 - 4th Quarter 2012: 27 million gallons.
 - 2012 Annual Total: 102 million gallons.
 - Cumulative Total: 356 million gallons.
- Total VOC mass recovered (Table 7 and Figures 5, 8A, 8B, and 8C):
 - 4th Quarter 2012: 59 pounds (lbs) of VOCs.
 - 2012 Annual Total: 267 lbs of VOCs.
 - Cumulative Total: 1,798 lbs of VOCs.
 - The majority of VOCs recovered during this quarterly reporting period were Project VOCs (54% or 32 lbs). This is the first time since 2009 that more Project VOCs were removed during a quarterly period than Non-Project VOCs. Overall, in 2012, more Non-Project VOCs were removed (52% or 139 lbs) than Project VOCs.
- Per well VOC mass recovered and mass removal rates (Table 7 and Figures 8A, 8B, and 8C):

- The majority of Project VOCs are recovered by RW-2 (94% during the reporting period and 90% during 2012) and RW-3 (6% during the reporting period and 10% during 2012).
- The majority of the Non-Project VOCs are recovered by RW-3 (70% during the reporting period and 72% during 2012) and RW-4 (30% during the reporting period and 28% during 2012).
- Treatment system influent concentrations (Table 2 and Figure 7):
 - Project VOC influent concentrations (91 to 102 µg/L during the reporting period) are consistent with some of the other 2012 values, but well below the peak concentration observed in 2012 (138 µg/L) and are significantly below the peak project concentration observed in August 2009 (~1,000 µg/L).
 - Non-Project influent concentrations (100 to 110 µg/L during the reporting period) are lower than other 2012 values and are well below the peak concentration of 650 µg/L (in May 2010).
 - Mercury has not been detected in an influent sample since system start-up.
- Total Project VOC concentrations in Remedial Wells RW-1 and RW-4 are below 5 µg/L, which is the most stringent RAO (Table 9).
- Metals concentrations in Remedial Wells RW-1, RW-2, and RW-4 in 2012 were consistent with concentrations in previous years, including infrequent anomalous iron concentrations in RW-2 that are believed attributed to a dislodged iron flake captured in sample (Table 10). Metals concentrations in Remedial Well RW-3 generally decreased in the second half of 2012.
- The air stripper, air stripper off-gas treatment system, and bag filter system performed within acceptable parameters for this reporting period and for 2012, as indicated by:
 - The air stripper VOC removal efficiency was greater than 99.9 percent for Project and Non-Project VOCs (Table 3).
 - Both the water and air discharges comply with their applicable standards, criteria, and guidance values (SGCs), with the exception of an anomalous

elevated total iron concentration in March 2012 effluent water sample believed attributed to a dislodged iron flake captured in sample (Tables 3, 5, and 8).

5.3.2 Regulatory Status of Discharges

5.3.2.1 Air Discharge

To determine the compliance status of air discharge from the Groundwater IRM treatment system, the system's effluent vapor concentrations were compared to NYSDEC Division of Air Resources Air Guide-1 (DAR-1) Model Short-term Guideline Concentrations (SGCs [NYSDEC 2010]) (Table 5) and the effluent vapor laboratory results were compared to a site-specific modeled annual maximum allowable stack concentration (MASC). The annual MASC was calculated during each monitoring event for individual compounds using the output from the USEPA SCREEN3 Model in conjunction with the NYSDEC DAR-1 AGCs. A scaling factor was calculated using the SCREEN3 model with site-specific physical layout information (e.g. building dimensions, stack height, terrain, etc.) and operating data (e.g. air flow rate, temperature, etc.) inputs for each monitoring event. The scaling factor was then used to adjust (scale) the NYSDEC DAR-1 AGC to a site-specific MASC. A summary of the instantaneous percent (i.e., not time-weighted) of the site-specific annual MASC for Project VOCs, Freon 12, and Freon 22 is provided in Table 8. A summary of the cumulative annual percent (i.e. time-weighted) of the site-specific MASC for detected compounds is also provided in Table 8. A summary of the model inputs, outputs, and backup calculations is provided in Appendix D.

The Groundwater IRM air effluent met NYSDEC requirements throughout the reporting period and 2012, as indicated by the following:

- The measured concentrations of individual VOCs in the vapor effluent did not exceed applicable SGCs (Table 5).
- The measured concentration of individual VOCs in the vapor effluent did not exceed their applicable, instantaneous MASCs, as calculated using the USEPA SCREEN 3 Model (Table 8). Similarly, the time-weighted rolling averages for the individual Project VOCS, Freon 12, and Freon 22 are below their respective MASCs.

5.3.2.2 *Water Discharge*

The Groundwater IRM treated water effluent met NYSDEC regulatory requirements during the reporting period and during 2012 with the exception of an anomalous elevated total iron concentration (910 µg/L) in March 2012 sample believed attributed to a dislodged iron flake captured in sample (Table 3 and Appendix B).

6. Environmental Effectiveness Monitoring

Groundwater IRM treatment system environmental effectiveness (i.e., hydraulic monitoring and groundwater quality monitoring) activities and results for this reporting period and for 2012 are discussed below.

6.1 Hydraulic Monitoring

6.1.1 *Activities*

In accordance with the OM&M Manual requirements and methodologies (ARCADIS 2009), a quarterly round of groundwater hydraulic monitoring was performed during this reporting period. Specifically, depth-to-water measurements were collected on October 5, 2012 from the 35 locations forming the approved monitoring well network (Table 11 and Figure 4). Water-level data collected were mapped and vertical hydraulic gradients were calculated as part of the evaluation of the hydraulic performance of the Groundwater IRM. The vertical hydraulic gradient is a measure of the potential for vertical groundwater flow between two vertically separated, closely spaced observation points (i.e., clustered or nested observation wells). The magnitude of the gradient indicates the steepness of the gradient, and the sign of the gradient indicates the direction of vertical flow (i.e., a positive vertical gradient indicates upward flow, while a negative vertical gradient indicates downward groundwater flow). The gradient does not provide information with respect to the rate of groundwater movement, which is affected by the hydraulic conductivity of the aquifer material through which the water is moving.

6.1.2 *Results*

Figure 4 shows the water-level elevations observed on October 5, 2012 and the inferred horizontal groundwater flow directions. Comparing fourth quarter water-level elevations from 2012 to those from last year reveal that the water table was approximately one-foot higher in 2012.

Table 12 summarizes the observed vertical groundwater hydraulic gradients at key well pairs located along the Site Area southern boundary during the October 5, 2012 monitoring event; the vertical gradient directions are shown on Figure 9. The vertical hydraulic gradients indicate that shallow groundwater is moving downward and deeper groundwater is being drawn upward toward the well screens of Remedial Wells RW-1 through RW-4 thereby documenting an area of vertical hydraulic control, in that portion of the aquifer that has concentrations of Project VOCs above 5 µg/L. Figure 9, in combination with Figure 4, indicate that the remedial wells are intercepting the Project VOC-impacted groundwater with concentrations greater than 5 µg/L and preventing its off-site migration.

The hydraulic monitoring results for the other three 2012 quarterly reporting periods are provided in their respective 2012 Quarterly Reports (ARCADIS 2012a, ARCADIS 2012b, and ARCADIS 2012c). Results from these earlier 2012 reporting periods are consistent with this reporting period and show that the Groundwater IRM has been intercepting the Project VOC-impacted groundwater with concentrations greater than 5 µg/L and preventing its off-site migration throughout 2012.

6.2 Groundwater Quality Monitoring

6.2.1 Activities

In accordance with the OM&M Manual (ARCADIS 2009), the 2012 Annual Groundwater IRM sampling event occurred during the Fourth Quarter of 2012. Groundwater samples were collected from 13 monitoring wells and analyzed for the Target Compound List (TCL) VOCs, plus Freon 12 and Freon 22, using NYSDEC Analytical Services Protocol (ASP) 2000 Method OLM4.2. Groundwater samples from 10 of the 13 monitoring wells sampled were also analyzed for total and dissolved metals (cadmium and chromium) using NYSDEC Method ILM4.0. Methods OLM4.2 and ILM4.0 are outlined in the Quality Assurance Project Plan (QAPP) (Appendix D-1 of the OM&M Manual; ARCADIS 2009).

A non-purge sampling method (HydraSleeve™) approved by NYSDEC (NYSDEC 2012) was used for the first time during the annual groundwater quality monitoring event in October 2012. This sampling method had been proposed and approved as a green alternative to conventional sampling methods (i.e. to reduce the volume of investigation derived waste). Due to non-representative results observed in some wells using this method, four wells were re-sampled in April 2013 for total and

dissolved chromium using the conventional three-volume, purge-and-sample method as a check on the October 2012 HydraSleeve™ results.

6.2.2 Results

Table 13 summarizes the results of laboratory analysis for VOCs in groundwater samples collected from monitoring wells associated with the Groundwater IRM. The table includes the results of samples collected during this and previous reporting periods. In general, when the fourth Quarter 2012 groundwater sampling results are compared to the results from previous quarters, monitoring wells located south of the remedial wells, (within the capture zone of the remedial wells, as shown on Figure 4), show stable or decreasing VOC concentrations. The exception to this observation was MW-201-1, where VOCs increased in 2012. However, the TVOC concentration observed in MW-201-1 was less than 5 percent of the concentration found in that well only two years before.

Table 14 summarizes the results of laboratory analysis of metals in groundwater samples collected from monitoring wells associated with the Groundwater IRM. The October 2012 groundwater sampling results indicate no detections of total and dissolved cadmium, which is consistent with data from the period of record for these wells. Chromium concentrations in monitoring wells located upgradient (north) of the remedial wells are consistent with concentrations seen during previous sampling events with concentrations of total and dissolved chromium below NYSDEC SCGs.

Chromium concentrations in the four monitoring wells located south of the remedial wells, (within the capture zone of the remedial wells, as shown on Figure 4), were substantially higher in October 2012 compared to the results from previous sampling events. Those elevated concentrations are thought to be attributable to using a different sampling methodology (HydraSleeve™ method) than the conventional purge-and-sample method historically used to sample the wells. Notably, the turbidity levels in the samples from the HydraSleeve™ sampling round were an order-of-magnitude higher than observed during the previous purge-and-sample rounds. To determine whether the October 2012 elevated chromium concentrations were caused by the change in sampling methodology, the four wells were re-sampled in April 2013, this time using the conventional purge-and-sample method. The April 2013 chromium results (Table 14) are much more consistent with the results prior to the HydraSleeve™ round, although the total chromium concentrations in two of the wells (MW-200-1 and MW-203-1) are above the 50 µg/L chromium SGC. Even so, those total chromium concentrations are an order-of-magnitude lower than the previous HydraSleeve™

results. Also, the dissolved chromium concentrations in the four wells are below the SCG in the April 2013 results. These four wells, and the other IRM monitoring wells, will be sampled during future sampling rounds using the conventional purge-and-sample method.

6.3 Environmental Effectiveness Monitoring Conclusions

Collectively, Figures 4 and 9 indicate that the Groundwater IRM Containment system is operating as designed, the expected associated capture zone has developed, and off-site migration of groundwater, that has Project VOC concentrations greater than 5 µg/L, is being prevented.

7. Groundwater IRM Recommendations

- Remove mercury from the SPDES equivalency monitoring program because Mercury has never been detected in any system water sample.
- Continue operating, maintaining, and monitoring the system in accordance with the Groundwater OM&M Manual (ARCADIS 2009) including the quarterly preventive maintenance program and removing iron build-up in the RW-2 and RW-3 influent pipelines during the first two quarters in 2013.
- Based on the consistent operation of the Groundwater IRM since July 2009, we recommend that the current, quarterly reporting frequency be reduced to annual. Consistent with the NYSDEC-approved OU3 Groundwater IRM OM&M Manual (ARCADIS 2009), an annual report will be prepared to summarize system operation, performance, and monitoring data; this annual report will be prepared and submitted under the supervision of a licensed, professional engineer. Additionally, pertinent data collected for the Groundwater IRM will be submitted to the NYSDEC as part of the semi-annual progress reports currently completed in accordance with Section III of AOC Index #W1-0018-04-01. Upon receipt of NYSDEC approval of this recommendation, the OU3 Groundwater IRM OM&M Manual (ARCADIS 2009) will be updated to reflect this change.
- Sample monitoring wells using the conventional purge-and-sample method during future monitoring events in lieu of HydraSleeve™ sampling, which, due to high turbidity, may impact sample results.



8. Certification

Statement of Certification

On behalf of Northrop Grumman Systems Corporation, I hereby certify and attest that the Operable Unit 3 Groundwater Interim Remedial Measure is operated during this reporting period in compliance with the remedial action objectives provided within the NYSDEC-approved Groundwater Interim Remedial Measure Work Plan dated December 2007, which was prepared pursuant to NYSDEC Order on Consent Index # W1-0018-04-01 referencing the Former Grumman Settling Ponds Site and dated July 4, 2005.

A handwritten signature in cursive script that reads "William S. Wittek".

William S. Wittek, P.E.
Senior Engineer
License # 080827

9. References

ARCADIS of New York, Inc. (ARCADIS) 2009. Interim Operation, Maintenance, and Monitoring Manual, Northrop Grumman Groundwater Interim Remedial Measure, Operable Unit 3 (Former Grumman Settling Ponds), Bethpage, New York. December 2009.

ARCADIS U.S. Inc. (ARCADIS) 2011a. Remedial Investigation Report (Site Area). Operable Unit 3 – Former Grumman Settling Ponds, Bethpage, New York. NYSDEC Site #1-30-003A. February 8, 2011.

ARCADIS U.S. Inc. (ARCADIS) 2011b. Operation, Maintenance, and Monitoring Report for the Groundwater Interim Remedial Measure, 2010 Annual Summary Report. Operable Unit 3 – Former Grumman Settling Ponds, Bethpage, New York. NYSDEC Site # 1-30-003A. April 7, 2011.

ARCADIS U.S. Inc. (ARCADIS) 2012a. Quarterly Operation, Maintenance and Monitoring Report for the Groundwater Interim Remedial Measure – March 2012, Operable Unit 3 – Former Grumman Settling Ponds, Bethpage, New York. NYSDEC Site # 1-30-003A. May 17, 2012.

ARCADIS U.S. Inc. (ARCADIS) 2012b. Quarterly Operation, Maintenance and Monitoring Report for the Groundwater Interim Remedial Measure – June 2012, Operable Unit 3 – Former Grumman Settling Ponds, Bethpage, New York. NYSDEC Site # 1-30-003A. August 30, 2012.

ARCADIS U.S. Inc. (ARCADIS) 2012c. Quarterly Operation, Maintenance and Monitoring Report for the Groundwater Interim Remedial Measure – September 2012, Operable Unit 3 – Former Grumman Settling Ponds, Bethpage, New York. NYSDEC Site # 1-30-003A. November 28, 2012.

New York State Department of Environmental Conservation (NYSDEC), 2005, Order on Consent, Index # W1-0018-04-01, Site # 1-30-003A, July 4, 2005.

New York State Department of Environmental Conservation (NYSDEC), 2009, Interim State Pollution Discharge Elimination System (SPDES) Letter, March 19, 2009.

New York State Department of Environmental Conservation (NYSDEC), 2010, DAR-1 AGC/SGC Tables, Revised October 18, 2010.



**Operation,
Maintenance, and
Monitoring Report
Groundwater Interim
Remedial Measure**

2012 Annual Summary

New York State Department of Environmental Conservation (NYSDEC), 2012, Re:
Northrop Grumman-Bethpage, Nassau County, Oyster Bay (T), NYSDEC Site
No. 1-30-003A-OU3, August 1, 2012.

Zervos, Theodore, 2007. Deposition of Theodore Zervos in the matter Town of
Oyster Bay v. Northrop Grumman Systems Corporation et al. Case No. 05-CV-
1945 (TCP)(AKT). January 22, 2007.



Tables

Table 1. Operational Summary, Groundwater Interim Remedial Measure, Operable Unit 3 (Former Grumman Settling Ponds), Bethpage, New York.

MONTH	DAY																															Days Operational (1)	
	1	2	3	4	5	6	7	8	9	10	11	12	13	14	15	16	17	18	19	20	21	22	23	24	25	26	27	28	29	30	31		
2009 Total																																160	
2010 Total																																352	
2011 Total																																351	
Jan-12	b				b			###**	b				b				b	bb	b					b					b			31	
Feb-12	b			b		###	b						(2)b				b						b	(3)				(4)	b	b		27	
Mar-12			b					### b					(5)	b				(6)		(7)b	(7)b	b				(7)b	b			b		30	
Q1 2012																																88	
Apr-12			###**		b								(8)	b									b			(9)b			(10)bb	(11)b		30	
May-12			b				###	b					b										(12)b	(13)b	b	(14)b		b		(15)	b	29	
Jun-12		b			###	b							b											b					b			30	
Q2 2012																																89	
Jul-12		###b			**								(16)b		b								b					b				30	
Aug-12	b				b	### b	b						b						b	(17)	bb	bbbb		b				b				28	
Sep-12	b			###				b					b	(18)									b							b			31
Q3 2012																																89	
Oct-12	###	b	(19)**		b											(20)bb	b	b	(21)b	bb			b					(22)b			b	28	
Nov-12	b	b		b			(23)	b			###	b															(24)b		b				30
Dec-12			###**	b	(25)	b																	b								b		29
Q4 2012																																87	
2012 Total																																353	
TOTAL																																1,216	

Legend:

- Indicates system online for at least the majority of the day.
- Indicates system operated with reduced flow rates.
- Indicates system offline for at least the majority of the day.
- # Indicates water compliance samples were collected.
- ## Indicates water performance samples were collected.
- ** Indicates vapor compliance samples were collected.
- * Indicates vapor performance samples were collected.
- b Indicates filter bag unit changed over.

Acronyms/Key:

- IRM Interim Remedial Measure.
- BF Bag Filter

Table 1. Operational Summary, Groundwater Interim Remedial Measure, Operable Unit 3 (Former Grumman Settling Ponds), Bethpage, New York.

Notes:

(1) Days in which the system was operational for the majority of the day are counted as one day.

1st Quarter 2012

- (2) The system shut down at 9:46 AM on February 14, 2012 due to low pressure/motor overload alarm conditions at Remedial Well RW-2. Attempts to restart the system with RW-2 failed due the re-occurrence the RW-2 low-pressure alarm condition. The system was restarted without RW-2 at 1:30 PM. Remedial Well RW-2 stayed off-line until pump and well maintenance work was performed on February 27 and 28, 2012 (see Note 4).
- (3) The system shut down at 3:23 PM on February 23, 2012 due to a temporary power supply interruption. The system was restarted at 5:48 PM after the system was inspected for any problems. The system was off-line for ~ 2.5 hours.
- (4) The system was shut down for preventative maintenance work on Remedial Wells RW-2 and RW-3 at ~8:00 AM on February 27, 2012. After the maintenance work was completed, the system was restarted at ~2:00 pm on February 28, 2012. The system was off-line for ~30 hours.
- (5) The system shut down at 4:27 AM on March 14, 2012 due to a temporary power supply interruption. The system was restarted at 10:10 AM after the system was inspected for any problems. The system was off-line for ~ 5.7 hours.
- (6) The system shut down at 2:42 AM on March 19, 2012 due to low pressure alarm condition at Remedial Well RW-3. Attempts to restart the system with RW-3 failed due to the re-occurrence of the RW-3 pump motor overload condition. The system was restarted without RW-3 at approximately 11:15 AM. Remedial Well RW-3 stayed off-line until March 26, 2012 (see Note 7).
- (7) The system was shut down multiple times between March 21 and March 26, 2012 to troubleshoot and address the re-occurring Remedial Well RW-3 pump overload conditions. Specifically,
 - a) On March 21, Remedial Well RW-3 pump was pulled and inspected. An electrical short was observed in the motor lead. The pump, motor, and motor lead were replaced and the system restarted at ~12:30PM. However, the system shut down approximately 15 minutes later on another RW-3 motor overload alarm. The system was restarted but shut down approximately 4 hours later on a Remedial Well RW-1 motor overload alarm. At that point, a decision was made to keep the system off until the Plant's electrical components could be better inspected.
 - b) On March 22, the Plant's electrical system was inspected and no problems were found. Attempts to restart the system failed due to the re-occurrence of the RW-3 motor overload alarm condition. The system was restarted without RW-3 at ~11AM. There was no apparent problem with Remedial Well RW-1 and the March 21 RW-1 motor overload alarm condition was suspected to be due to poor local power service.
 - c) On March 26, a wiring fault was detected at Remedial Well RW-3. Once repaired, RW-3 was brought on-line at approximately 8:30AM.

2nd Quarter 2012

- (8) The system shut down at 3:05 PM on April 13, 2012 due to low pressure/motor overload alarm condition at Remedial Well RW-3. Attempts to restart the system with RW-3 failed due to RW-3 low-flow alarm conditions. The system was restarted without RW-3 at 5:40 PM. Remedial Well RW-3 stayed off-line until electrical troubleshooting and repairs were completed on April 23, 2012. Troubleshooting and repairs performed between April 13 and April 23, 2012 were:
 - a) On April 19, the Plant's electrical system was inspected and no problems were found. Arrangements were made to inspect the electrical connections and components at the well on April 23.
 - b) On April 23, a defect was discovered on the motor lead coating and insulation. The pump motor lead was replaced and the well was restarted at ~5:40 PM.
- (9) The system shut down at 3:47 AM on April 24, 2012 due to a motor overload alarm condition at Remedial Well RW-3. The system was off-line for approximately 7 hours. It was determined that the alarm was likely due to poor power service, which is common for this area.
- (10) The system shut down at 1:39 PM on April 28, 2012 due high-water level alarm condition in the building sump. The alarm condition was caused by a minor valve leak after a bag filter changeout earlier in the day. The system was off-line for approximately 5 hours.

Table 1. Operational Summary, Groundwater Interim Remedial Measure, Operable Unit 3 (Former Grumman Settling Ponds), Bethpage, New York.

Notes (continued):

- (11) The system shut down at 6:16 AM on April 30, 2012 due to both 401 BF & 402 BF fouling over the weekend, resulting in high-high pressure alarm and system shutdown. The system was off-line for approximately 4.5 hours.
- (12) The system was shut down at ~12:30 PM on May 22, 2012 for control system programming upgrades. The system was restarted at ~ 5:30 PM, and was off-line for approximately 5 hours.
- (13) The system was shut down for preventative maintenance work on Remedial Wells RW-2 and RW-3 at ~8:00 AM on May 23, 2012. After the maintenance work was completed, the system was restarted at ~5:30 pm on May 24, 2012. The system was off-line for approximately 33.5 hours.
- (14) The system was shut down at ~4:00 PM on May 25, 2012 for control system programming upgrades. The system was restarted at ~5:20 PM and was off-line for approximately 1.5 hours.
- (15) The system was shut down at ~12:45 PM on May 30, 2012 for control system programming upgrades. The system was restarted at ~4:20 PM and was off-line for approximately 3.5 hours.

3rd Quarter 2012

- (16) The system shut down at 3:10 PM on July 12, 2012 due to a blower high-vacuum alarm condition. The alarm condition appeared to be due to restricted air flow through the air stripper trays caused by particulate fouling. Troubleshooting was completed, and the system was restarted with the remedial wells temporarily operating at reduced flow rates. The system was off-line for approximately 2 hours. An air stripper cleaning was scheduled for Friday, July 13, 2012.
 - a) The system shut down again at 9:19 AM on July 13, 2012 due to another blower high-vacuum alarm condition. The system was restarted with RW-1 off line and the three remaining remedial wells temporarily operating at reduced flow rates. The system was off-line for approximately 2.75 hours.
 - b) The system was shutdown at ~4:00 PM on July 13, 2012 for an air stripper cleaning using a pressure washer. The system was fully operational at ~ 3:00 PM on July 14, 2012. The system was off-line approximately 23 hours.
- (17) The system was shut down at ~8:00 AM on August 21, 2012 for preventative maintenance work on Remedial Wells RW-2 and RW-3 . After the maintenance work was completed, the system was restarted at ~7:30 PM on August 22, 2012. The system was off-line for ~35 hours.
- (18) The system shut down at ~5:00 PM on September 14, 2012 due high-water level alarm condition in the building sump. The alarm condition was caused by a faulty check valve in the effluent line from the sump. The system was off-line for approximately 1 hour. (The valve was subsequently removed and cleaned during a routine maintenance event on October 17, 2012).

4th Quarter 2012

- (19) The system was shut down at 11:43 AM on October 3, 2012 for preventative maintenance work on the low profile air stripper. The demister pad was switched out with a spare. The system was restarted at approximately 5:30 PM and was off-line for approximately 6 hours.
- (20) The system was shutdown at 11:13 AM on October 17, 2012 for a periodic air stripper cleaning using a pressure washer. The system was restarted at 5:39 PM and was off-line for approximately 6.5 hours.
- (21) The system shut down at 6:23 PM on October 20, 2012 due to both 401 BF & 402 BF fouling over the weekend, resulting in high-high pressure alarm and system shutdown. The system was off-line for approximately 16 hours.
- (22) The system was shut down at approximately 6:00 PM on October 28, 2012 in anticipation of Hurricane Sandy. The system was restarted at 11:06 AM on November 1, 2012 after a full site inspection following the storm, which included a test of the SCADA and alarm call-out systems.
- (23) The system was shut down at approximately 7:42 PM on November 7, 2012 in anticipation of an approaching Nor'easter. The system was restarted at 10:40 AM on November 8, 2012 after a full site inspection following the storm, which included a test of the SCADA and alarm call-out systems.
- (24) The system shut down at 5:28 AM on November 25, 2012 due to a low vacuum alarm condition at the process blower intake. It was determined that the alarm was likely due to a power interruption. The system was restarted at 7:18 AM the same day after troubleshooting activities and was off-line for approximately 2 hours.
- (25) The system was shut down at 8:45 AM on December 5, 2012 for preventative maintenance activities at Remedial Wells RW-2 and RW-3. During the work the RW-2 pump pulled, replaced with a spare pump, and subsequently cleaned for future use. The system was restarted at 3:00 PM on December 6, 2012.

Table 2. Summary of Influent Water Sample Analytical Results, Groundwater Interim Remedial Measure, Operable Unit 3 (Former Grumman Settling Ponds), Bethpage, New York. ⁽¹⁾

Compound ⁽²⁾	01/09/12 (µg/L)	02/06/12 (µg/L)	03/08/12 (µg/L)	04/03/12 (µg/L)	05/07/12 (µg/L)	06/05/12 (µg/L)	07/02/12 (µg/L)	08/07/12 (µg/L)	09/04/12 (µg/L)	10/01/12 (µg/L)	11/12/12 (µg/L)	12/03/12 (µg/L)
Project VOCs												
1,1,1 - Trichloroethane	0.24	ND	ND	ND	ND	ND	ND	ND	ND	ND	ND	ND
1,1 - Dichloroethane	0.67	0.63	0.6	0.63	0.52	0.58	0.46	0.56	0.51	0.47	0.51	0.53
1,2 - Dichloroethane	ND	ND	ND	ND	ND	ND	ND	ND	ND	ND	ND	ND
1,1 - Dichloroethene	0.45	0.36	0.36	0.34	0.25	ND	ND	0.3	0.3	0.36	0.26	0.34
Tetrachloroethene	0.36	0.37	0.33	0.29	0.35	ND	ND	0.28	0.3	0.34	0.31	0.38
Trichloroethene	9.0	7.8	7.3	7.7	6.9	7.1	7.0	7.5	7.1	7.0	6.8	6.3
Vinyl Chloride	18	13	16	17	11	11	10	14	17	15	17	17
cis 1,2-Dichloroethene	84	72	74	76	59	61	53	57	63	54	47	44
trans 1,2-Dichloroethene	ND	0.22	ND	ND	ND	ND	0.24	ND	ND	ND	ND	ND
Benzene	ND	ND	ND	ND	ND	ND	ND	ND	ND	ND	ND	ND
Toluene	23	18	12	17	11	13	18	19	22	23	26	21
Xylenes	1.9	1.5	1.2	1.8	1.2	1.5	1.7	2.0	2.1	1.9	2.2	1.9
Subtotal Project VOCs	138	114	112	121	92	96	90	101	112	102	100	91
Non-Project VOCs												
Dichlorodifluoromethane (Freon 12)	ND	ND	ND	ND	ND	ND	ND	ND	ND	ND	ND	ND
Chlorodifluoromethane (Freon 22)	180	170	190	200	150	130	120	140	130	100	110	100
Subtotal Non-Project VOCs	180	170	190	200	150	130	120	140	130	100	110	100
Total VOCs ⁽³⁾	318	284	302	321	242	226	210	241	242	202	210	191
Inorganics												
Total Iron	380	790	490	600	650	360	470	850	410	400	330	840
Total Mercury	NA	NA	NA	NA	NA	NA	NA	NA	NA	NA	NA	NA
pH ⁽⁴⁾	6.2	5.7	5.6 ⁽⁵⁾	5.4	5.4	5.6	5.4	5.7	5.3	5.5	5.6	5.3

See notes on last page.

Table 2. Summary of Influent Water Sample Analytical Results, Groundwater Interim Remedial Measure, Operable Unit 3 (Former Grumman Settling Ponds), Bethpage, New York. ⁽¹⁾

Notes:

- (1) Water samples collected by ARCADIS on the dates shown and submitted to Columbia Analytical Services, Inc. for VOC analyses per NYSDEC ASP 2000, Method OLM 4.3, for iron analyses per USEPA Method 6010 and for mercury analyses per USEPA Method 7470. The VOC analyte list is provided in the DRAFT Groundwater IRM OM&M Manual (ARCADIS 2009b). Influent water samples were collected from Water Sampling Port-5 (WSP-5); refer to Figure 3 of this OM&M Report for the schematic location of WSP-5. Data in this table corresponds to approximately the past year of system operation.
- (2) Only VOCs associated with the interim State Pollutant Discharge Elimination System (SPDES) equivalency program, plus Toluene, Benzene, Xylenes, non-project related Freon 12 and Freon 22, Mercury and Iron are included in this table. Complete VOC and inorganic data summary tables, including VOC TICs, are provided in Appendix B. Laboratory data qualifiers are included in the Appendix B tables.
- (3) "Total VOCs" represents the sum of individual concentrations of the compounds detected. The values used in calculations referenced in this report have been rounded to the nearest whole number.
- (4) pH samples collected and measured in the field by ARCADIS personnel on the dates listed using an Oakton Model 300 pH/conductivity meter. pH units are standard units.
- (5) The March 2012 pH value was measured on March 9, 2012.

Acronyms\Key:

- 700** Bold data indicates that the analyte was detected at or above its reporting limit.
- 16 Data that is not bold indicates analyte detected but below its reporting limit; the value is estimated.
- IRM Interim remedial measure.
- NA Not analyzed.
- ND Analyte not detected at, or above its laboratory quantification limit.
- NYSDEC New York State Department of Environmental Conservation.
- OM&M Operation, maintenance and monitoring.
- TICs Tentatively identified compounds.
- USEPA United States Environmental Protection Agency.
- VOC Volatile organic compound.
- µg/L Micrograms per liter.

Table 3. Summary of Effluent Water Sample Analytical Results, Groundwater Interim Remedial Measure, Operable Unit 3 (Former Grumman Settling Ponds), Bethpage, New York. ⁽¹⁾

Compound ⁽²⁾	Discharge												
	Limit ⁽³⁾ (µg/L)	01/09/12 (µg/L)	02/06/12 (µg/L)	03/08/12 (µg/L)	04/03/12 (µg/L)	05/07/12 (µg/L)	06/05/12 (µg/L)	07/02/12 (µg/L)	08/07/12 (µg/L)	9/4/5/2012 (µg/L)	10/01/12 (µg/L)	11/12/12 (µg/L)	12/03/12 (µg/L)
Project VOCs													
1,1,1 - Trichloroethane	5	ND	ND	ND	ND	ND	ND	ND	ND	ND	ND	ND	ND
1,1 - Dichloroethane	5	ND	ND	ND	ND	ND	ND	ND	ND	ND	ND	ND	ND
1,2 - Dichloroethane	5	ND	ND	ND	ND	ND	ND	ND	ND	ND	ND	ND	ND
1,1 - Dichloroethene	5	ND	ND	ND	ND	ND	ND	ND	ND	ND	ND	ND	ND
Tetrachloroethene	5	ND	ND	ND	ND	ND	ND	ND	ND	ND	ND	ND	ND
Trichloroethene	5	ND	ND	ND	ND	ND	ND	ND	ND	ND	ND	ND	ND
Vinyl Chloride	5	ND	ND	ND	ND	ND	ND	ND	ND	ND	ND	ND	ND
cis 1,2-Dichloroethene	5	ND	ND	ND	ND	ND	ND	ND	ND	ND	ND	ND	ND
trans 1,2-Dichloroethene	5	ND	ND	ND	ND	ND	ND	ND	ND	ND	ND	ND	ND
Benzene	5	ND	ND	ND	ND	ND	ND	ND	ND	ND	ND	ND	ND
Toluene	5	ND	ND	ND	ND	ND	ND	ND	ND	ND	ND	ND	ND
Xylenes	5	ND	ND	ND	ND	ND	ND	ND	ND	ND	ND	ND	ND
Subtotal Project VOCs	--	0.0	0.0	0.0	0.0	0.0	0.0	0.0	0.0	0.0	0.0	0.0	0.0
Non-Project VOCs													
Dichlorodifluoromethane (Freon 12)	5	ND	ND	ND	ND	ND	ND	ND	ND	ND	ND	ND	ND
Chlorodifluoromethane (Freon 22)	5	ND	ND	ND	ND	ND	ND	ND	ND	ND	ND	ND	ND
Subtotal Non-Project VOCs	--	0	0	0	0	0	0	0	0	0	0	0	0
Total VOCs ⁽⁴⁾	--	0.0	0.0	0.0	0.0	0.0	0.0	0.0	0.0	0.0	0.0	0.0	0.0
Treatment Efficiency ⁽⁵⁾	--	> 99.9%	> 99.9%	> 99.9%	> 99.9%	> 99.9%	> 99.9%	> 99.9%	> 99.9%	> 99.9%	> 99.9%	> 99.9%	> 99.9%
Inorganics													
Total Iron	600	360	310	910 ⁽⁷⁾	290	330	250	290	350	240	430	270	230
Total Mercury	250	< 0.2	< 0.2	< 0.2	ND	ND	ND	ND	ND	ND	ND	ND	ND
pH ⁽⁶⁾	5.5 - 8.5	7.1	6.7	5.9 ⁽⁸⁾	6.5	6.7	6.8	6.6	6.6	6.0	6.7	6.4	6.4

See notes on last page.

Table 3. Summary of Effluent Water Sample Analytical Results, Groundwater Interim Remedial Measure, Operable Unit 3 (Former Grumman Settling Ponds), Bethpage, New York. ⁽¹⁾

Notes:

- (1) Water samples collected by ARCADIS on the dates shown and submitted to Columbia Analytical Services, Inc. for VOC analyses per NYSDEC ASP 2000, Method OLM 4.3, for iron analyses per USEPA Method 6010 and for mercury analyses per USEPA Method 7470. The VOC analyte list is provided in the DRAFT Groundwater IRM OM&M Manual (ARCADIS 2009b). Effluent water samples were collected from Water Sampling Port-7 (WSP-7); refer to Figure 3 of this OM&M Report for the location of WSP-7. Data in this tables corresponds to approximately the past year of system operation.
- (2) Only VOCs associated with the interim SPDES equivalency program, including Toluene, Benzene, Xylenes, non-project related Freon 12 and Freon 22, Mercury and Iron are included in this table. Complete VOC and inorganic data summary tables, including VOC TICs, are provided in Appendix B. Laboratory data qualifiers are included in the Appendix B tables.
- (3) Discharge limits per the interim SPDES equivalency program or Division of Water Technical and Operational Guidance Series (TOGS 1.1.1) Quality Standards and Guidance Values and Groundwater Effluent Limitations, if the compound is not part of the interim SPDES equivalency program.
- (4) "Total VOCs" represents the sum of individual concentrations of compounds detected. The values used in calculations referenced in this report have been rounded to the nearest whole number.
- (5) Treatment efficiency was calculated by dividing the difference between the influent and effluent total VOC concentrations by the influent total VOC concentration.
- (6) pH samples collected and measured in the field by ARCADIS personnel on the dates listed using an Oakton Model 300 pH/conductivity meter. pH units are standard units.
- (7) Elevated iron concentration believed to be from a small piece of iron precipitate build-up on bag filter and discharge pipeline that flaked off and was captured in the sample.
- (8) The March 2012 pH value was measured on March 9, 2012.

Acronyms\Key:

- 700** Bold data indicates that the analyte was detected at or above its reporting limit.
- 16 Data that is not bold indicates analyte detected but below its reporting limit; the value is estimated.
- 6** Bold box indicates value is greater than discharge criterion.
- IRM Interim remedial measure.
- ND Analyte not detected at, or above its laboratory quantification limit.
- NYSDEC New York State Department of Environmental Conservation.
- OM&M Operation, maintenance, and monitoring.
- SPDES State pollutant discharge elimination system.
- TICs Tentatively identified compounds.
- USEPA United States Environmental Protection Agency.
- VOC Volatile organic compound.
- µg/L Micrograms per liter.
- Not applicable.
- > Greater than.

Table 4. Summary of Influent Vapor Sample Analytical Results, Groundwater Interim Remedial Measure, Operable Unit 3 (Former Grumman Settling Ponds), Bethpage, New York. ⁽¹⁾

Compound ⁽²⁾	01/09/12 (µg/m ³)	04/03/12 (µg/m ³)	07/05/12 (µg/m ³)	10/03/12 (µg/m ³)	12/03/12 (µg/m ³)
Project VOCs					
1,1,1 - Trichloroethane	ND	ND	ND	ND	2.4
1,1 - Dichloroethane	8.7	9.0	7.5	8.9	11
1,2 - Dichloroethane	ND	ND	ND	ND	ND
1,1 - Dichloroethene	ND	ND	4.2	ND	4.6
Tetrachloroethene	ND	ND	4.0	5.3	5.9
Trichloroethene	120	110	110	110	110
Vinyl Chloride	170	190	160	210	310
cis 1,2-Dichloroethene	1,200	1,100	900	900	1,000
trans 1,2-Dichloroethene	ND	ND	ND	ND	1.3
Benzene	ND	ND	ND	ND	4.8
Toluene	310	270	290	400	420
Xylenes	31	28	30	39	48
Subtotal Project VOCs	1,840	1,707	1,506	1,673	1,918
Non-Project VOCs					
Dichlorodifluoromethane (Freon 12)	ND	ND	3.1	ND	3.6
Chlorodifluoromethane (Freon 22)	1,700	1,800	1,300	1,000	1,100
Subtotal Non-Project VOCs	1,700	1,800	1,303	1,000	1,104
Total VOCs ⁽³⁾	3,540	3,507	2,809	2,673	3,022

See notes on last page.

Table 4. Summary of Influent Vapor Sample Analytical Results, Groundwater Interim Remedial Measure, Operable Unit 3 (Former Grumman Settling Ponds), Bethpage, New York. ⁽¹⁾

Notes:

- (1) Vapor samples collected by ARCADIS on the dates shown and submitted to Columbia Analytical Services, Inc. for VOC analyses per Modified USEPA Method T0-15. A VOC analyte list is provided in the DRAFT Groundwater IRM OM&M Manual (ARCADIS 2009b). Influent samples were collected at Vapor Sampling Port-1 (VSP-1); refer to Figure 3 of this OM&M Report for the location of VSP-1. Data in this table corresponds to approximately the past year of system operation.
- (2) Only VOCs that are associated with the interim State Pollutant Discharge Elimination System (SPDES) equivalency program, Toluene, Benzene, Xylenes, and non-project related Freon 12 and Freon 22 are included in this table. Complete VOC summary tables, including VOC TICs, are provided in Appendix C. Laboratory data qualifiers are included in the Appendix C tables.
- (3) "Total VOCs" represents the sum of individual concentrations of compounds detected. The values used in calculations referenced in this report have been rounded to the nearest whole number.

Acronyms\Key:

- 700** Bold data indicates that the analyte was detected at or above its reporting limit.
16 Data that is not bold indicates analyte detected but below its reporting limit; the value is estimated.
IRM Interim remedial measure.
ND Analyte not detected at or above its laboratory reporting limit.
OM&M Operation, maintenance, and monitoring.
TICs Tentatively identified compounds.
USEPA United States Environmental Protection Agency.
VOC Volatile organic compound.
 $\mu\text{g}/\text{m}^3$ Micrograms per cubic meter.

Table 5. Summary of Effluent Vapor Sample Analytical Results, Groundwater Interim Remedial Measure, Operable Unit 3 (Former Grumman Settling Ponds), Bethpage, New York. ⁽¹⁾

Compound ⁽²⁾	Discharge	01/09/12 (µg/m ³)	04/03/12 (µg/m ³)	07/05/12 (µg/m ³)	10/03/12 (µg/m ³)	12/03/12 (µg/m ³)
	Limit ⁽³⁾ (µg/m ³)					
Project VOCs						
1,1,1 - Trichloroethane	9,000	ND	ND	ND	ND	ND
1,1 - Dichloroethane	NS	ND	ND	0.82	1.1	1.8
1,2 - Dichloroethane	NS	ND	ND	ND	ND	ND
1,1 - Dichloroethene	380 ⁽⁴⁾	ND	ND	ND	ND	1.0
Tetrachloroethene	1,000	ND	ND	ND	ND	ND
Trichloroethene	14,000	ND	ND	1.6	3.1	4.3
Vinyl Chloride	180,000	8.1	8.4	ND	7.9	23
cis 1,2-Dichloroethene	190,000 ⁽⁵⁾	13	13	2.0	9.6	25
trans 1,2-Dichloroethene	NS	ND	ND	ND	ND	ND
Benzene	1,300	11	13	0.96	ND	1.9
Toluene	37,000	30	26	27	37	38
Xylenes	4,300	ND	ND	ND	2.8	4.3
Subtotal Project VOCs	NA	62	60	32	62	99
Non-Project VOCs						
Dichlorodifluoromethane (Freon 12)	NS	ND	ND	2.9	3.1	3.5
Chlorodifluoromethane (Freon 22)	NS	1,600	1,800	1,000	1,000	1,100
Subtotal Non-Project VOCs	NA	1,600	1,800	1,003	1,003	1,104
Total VOCs ⁽⁶⁾	NA	1,662	1,860	1,035	1,065	1,203
Treatment Efficiency (Total VOCs) ⁽⁷⁾	NA	53.1%	47.0%	63.2%	60.2%	60.2%
Treatment Efficiency (Project VOCs) ⁽⁸⁾	NA	96.6%	96.5%	97.9%	96.3%	94.8%

See notes on last page.

Table 5. Summary of Effluent Vapor Sample Analytical Results, Groundwater Interim Remedial Measure, Operable Unit 3 (Former Grumman Settling Ponds), Bethpage, New York. ⁽¹⁾

Notes:

- (1) Vapor samples collected by ARCADIS on the dates shown and submitted to Columbia Analytical Services, Inc. for VOC analyses per Modified USEPA Method T0-15. A VOC analyte list is provided in the DRAFT Groundwater IRM OM&M Manual (ARCADIS 2009b). Effluent samples were collected at Vapor Sampling Port-5 (VSP-5); refer to Figure 3 of this OM&M Report for the location of VSP-5. Data in this tables corresponds to approximately the past year of system operation.
- (2) Only VOCs that are associated with the interim State Pollutant Discharge Elimination System (SPDES) equivalency program, Toluene, Benzene, Xylenes, and non-project related Freon 12 and Freon 22 are included in this table. Complete VOC summary tables, including VOC TICs, are provided in Appendix C. Laboratory data qualifiers are included in the Appendix C tables.
- (3) Discharge limit is compound specific short-term guidance concentration (SGC) per the NYSDEC DAR-1 AGC/SGC tables revised October 18, 2010.
- (4) An SGC was not provided in the DAR-1 AGC/SGC Tables, dated October 18, 2010. An interim SGC was developed based on guidance of the New York State DAR-1 Guidelines for the Control of Toxic Ambient Air Contaminants, 1991 edition. Specifically for 1,1- dichloroethene, which is not defined as provided in Section IV.A.2.b.1 a high-toxicity compound, the Interim SGC = (smaller of Time Weighted Average [TWA] - Threshold Limit Value or TWA - Recommended Exposure Limit)/4.2. or $1,600 \mu\text{g}/\text{m}^3 / 4.2 = \text{approximately } 380 \mu\text{g}/\text{m}^3$. An interim SGC was developed for this compound because it has a moderate toxicity rating, as specified in the DAR-1 AGC/SGC Tables, dated October 18, 2010.
- (5) An SGC was not provided in the DAR-1 AGC/SGC Tables, dated October 18, 2010. An interim SGC was developed based on guidance provided in Section IV.A.2.b.1 of the New York State DAR-1 Guidelines for the Control of Toxic Ambient Air Contaminants, 1991 edition. Specifically for cis-1,2 dichloroethene, which is not defined as a high-toxicity compound, the interim SGC = (smaller of Time Weighted Average [TWA] - Threshold Limit Value or TWA - Recommended Exposure Limit)/4.2 or $790,000 \mu\text{g}/\text{m}^3 / 4.2 = \text{approximately } 190,000 \mu\text{g}/\text{m}^3$. An interim SGC was developed for this compound because it has a moderate toxicity rating, as specified in the DAR-1 AGC/SGC Tables, dated October 18, 2010.
- (6) "Total VOCs" represents the sum of individual concentrations of all compounds detected. The values used in calculations referenced in this report have been rounded to the nearest whole number.
- (7) Treatment efficiency was calculated by dividing the difference between the influent and effluent Total VOC concentrations by the influent Total VOC concentration. Treatment efficiency is only calculated when there is a corresponding influent sample.
- (8) Treatment efficiency was calculated by dividing the difference between the influent and effluent total Project VOC concentrations by the influent total Project VOC concentration. Treatment efficiency is only calculated when there is a corresponding influent sample.

Acronyms/Key:

700	Bold data indicates that the analyte was detected at or above its reporting limit.
16	Data that is not bold indicates analyte detected but below its reporting limit; the value is estimated.
AGC	Annual guideline concentration.
IRM	Interim remedial measure.
ND	Analyte not detected at or above its laboratory reporting limit.
NS	Guideline concentrations not specified in the NYSDEC DAR-1 AGC/SGC tables revised September 10, 2007. An interim SGC was not developed for these compounds because they have low toxicity ratings in the NYSDEC DAR-1 AGC/SGC tables revised October 18, 2010.
NYSDEC	New York State Department of Environmental Conservation.
OM&M	Operation, maintenance, and monitoring.
TICs	Tentatively identified compounds.
USEPA	United States Environmental Protection Agency.
VOC	Volatile organic compound.
$\mu\text{g}/\text{m}^3$	Micrograms per cubic meter.
--	Data not available or value could not be calculated.

Table 6. Summary of System Parameters, Groundwater Interim Remedial Measure, Operable Unit 3 (Former Grumman Settling Ponds), Bethpage, New York.

Date ⁽¹⁾	Water Flow Rates ⁽²⁾						Water Pressures ⁽²⁾					Air Flow Rate ⁽²⁾	Air Pressures ⁽²⁾					Air Temp. ⁽²⁾
	Remedial Well				Combined Influent	Effluent	Remedial Well Effluent ⁽³⁾				Effluent	Effluent	ECU Influent				Effluent	Stack Temp.
	RW-1 (gpm)	RW-2 (gpm)	RW-3 (gpm)	RW-4 (gpm)			RW-1 (psi)	RW-2 (psi)	RW-3 (psi)	RW-4 (psi)			GAC-501 (inH ₂ O)	GAC-502 (inH ₂ O)	PPZ-601 (inH ₂ O)	PPZ-602 (inH ₂ O)		
01/09/12	30.3	75.4	75.4	30.4	217	225	58.7	46.6	46.5	57.7	7.0	2,049	8.0	3.7	0.8	2.0	0.0	532 ⁽⁴⁾
02/06/12	30.4	75.3	75.1	30.2	216	238	58.4	27.0	32.9	58.0	7.0	2,075	8.0	3.7	1.0	2.0	NM	NM
03/09/12	30.9	75.4	76.3	30.8	219	217	58.0	57.0	58.2	57.3	6.0	2,050	8.0	4.0	0.9	1.9	0.0	535 ⁽⁴⁾
04/03/12	30.3	75.1	75.6	30.3	217	227	58.3	43.3	60.2	57.7	7.5	2,079	7.9	3.5	1.0	2.0	0.0	532 ⁽⁵⁾
05/07/12	30.3	74.5	75.3	30.4	216	240	58.0	19.6	57.6	57.4	7.5	2,027	8.0	3.5	0.8	1.7	0.0	536 ⁽⁴⁾
06/05/12	30.4	74.5	75.4	30.1	216	210	57.9	35.8	57.6	57.5	8.0	2,022	7.6	3.4	1.0	2.0	0.0	525
07/02/12	30.5	75.6	75.3	30.6	217	245	57.9	23.1	53.7	57	8.7	2,020	8.0	3.6	1.1	2.3	0.0	539 ⁽⁴⁾
08/07/12	30.1	71.1	75.5	30.3	211	222	58.5	21.3	50.2	57.5	11.5	1,946	7.5	3.1	1.1	2.0	0.0	532
09/04/12	30.7	75.1	75.1	30.5	216	219	57.4	33.1	52.2	56.9	9.5	1,831	7.5	2.9	1.0	1.9	0.0	539 ⁽⁴⁾
10/01/12 ⁽⁶⁾	30.1	72.4	75.1	30.1	212	237	58.0	32.2	51.9	57.5	8.0	1,813	7.2	2.9	1.0	1.9	0.0	538 ⁽⁵⁾
11/12/12	30.3	69.3	74.9	31.1	210	223	57.6	22.0	46.0	56.0	8.5	1,963	7.5	2.8	0.9	1.9	0.0	522
12/03/12 ⁽⁷⁾	31.3	64.6	74.3	30.9	207	207	56.5	19.3	43.0	55.9	8.0	1,962	7.5	2.8	1.0	1.9	0.0	533 ⁽⁴⁾

See notes on last page.

Table 6. Summary of System Parameters, Groundwater Interim Remedial Measure, Operable Unit 3 (Former Grumman Settling Ponds), Bethpage, New York.

Notes:

- (1) Operational data collected by ARCADIS on days noted. Parameters listed were typically recorded during compliance monitoring events. Data in this table corresponds to approximately the past year of system operation.
- (2) Instantaneous values from field-mounted instruments, except for the combined influent water-flow rate, which is the sum of individual well flow rates via the Supervisory Control and Data Acquisition (SCADA) System.
- (3) Remedial Well effluent pressure readings measured at the influent manifold within the treatment system building.
- (4) Stack temperature measured using infrared temperature gun.
- (5) ECU Mid-train temperature used because stack effluent gauge could not be read.
- (6) Water samples taken on October 1, 2012, air samples taken on October 3, 2012. Air parameters shown reflect conditions on the air sampling date.
- (7) Influent pressures to ECUs not recorded on day of sampling, the average of the next two site visits in December were used.

Acronyms\Key:

ECU	Emission control unit.
gpm	Gallons per minute.
inH ₂ O	Inches of water column.
NM	Not measured. The value was not measured due to a faulty gauge.
psi	Pounds per square inch.
°R	Degrees Rankine.
scfm	Standard cubic feet per minute.
Temp.	Temperature.

Table 7. Summary of Groundwater Recovered, VOC Mass Recovered, and VOC Mass Recovery Rates, Groundwater Interim Remedial Measure, Operable Unit 3 (Former Grumman Settling Ponds), Bethpage, New York.

Operating Period ⁽¹⁾	Volume of Groundwater Recovered (x1,000 gal) ⁽²⁾					VOC Mass Recovered (lbs) ⁽³⁾															VOC Mass Recovery Rate (lbs/day) ⁽⁴⁾																			
						Total VOCs ⁽⁵⁾					Project VOCs ⁽⁶⁾					Non-Project VOCs ⁽⁷⁾					Total VOCs ⁽⁵⁾					Project VOCs ⁽⁶⁾					Non-Project VOCs ⁽⁷⁾									
	RW-1	RW-2	RW-3	RW-4	Total	RW-1	RW-2	RW-3	RW-4	Total	RW-1	RW-2	RW-3	RW-4	Total	RW-1	RW-2	RW-3	RW-4	Total	RW-1	RW-2	RW-3	RW-4	Total	RW-1	RW-2	RW-3	RW-4	Total	RW-1	RW-2	RW-3	RW-4	Total	RW-1	RW-2	RW-3	RW-4	Total
System Pilot Test, Shakedown and Start Up Totals ⁽⁸⁾																																								
	137	270	251	150	808	NA	NA	NA	NA	1.1	NA	NA	NA	NA	1.0	NA	NA	NA	NA	0.1	NA	NA	NA	NA	NA	NA	NA	NA	NA	NA	NA	NA	NA	NA	NA	NA	NA	NA	NA	NA
2009 Totals ⁽⁹⁾																																								
7/21/09 - 12/30/09	6,592	13,838	16,445	6,574	43,449	0.17	275	53	14	342	0.17	273	19	0.20	293	<0.01	0.56	35	13	48	<0.01	1.9	0.34	0.09	2.2	<0.01	1.9	0.12	<0.01	1.9	<0.01	<0.01	0.22	0.08	0.30					
2010 Totals ⁽¹⁰⁾																																								
12/30/09 - 01/05/11	15,726	35,127	38,160	15,689	104,702	0.56	172	412	89	672	0.56	171	28	0.10	200	<0.01	0.17	383	89	469	<0.01	0.46	1.1	0.24	1.8	<0.01	0.46	0.08	<0.01	0.54	<0.01	<0.01	1.0	0.24	1.3					
2011 Totals ⁽¹¹⁾																																								
01/05/11 - 01/09/12	15,218	36,570	37,682	15,196	104,666	0.36	167	271	78	516	0.36	167	35	0.09	203	<0.01	1.1	236	78	314	<0.01	0.45	0.73	0.21	1.4	<0.01	0.45	0.09	<0.01	0.55	<0.01	<0.01	0.64	0.21	0.85					
January 2012 through March 2012 Totals																																								
01/09/12 - 02/06/12	1,234	3,041	3,047	1,233	8,555	0.03	11	12	4.0	27	0.03	11	1.6	0.04	13	<0.01	0.21	10	4.0	14	<0.01	0.39	0.43	0.14	1.0	<0.01	0.39	0.06	<0.01	0.46	<0.01	0.01	0.36	0.14	0.50					
02/06/12 - 03/09/12	1,330	1,932	3,298	1,333	7,893	0.03	7.1	13	4.4	25	0.03	7.0	1.8	0.04	9.0	<0.01	0.13	11	4.3	15	<0.01	0.22	0.41	0.14	0.78	<0.01	0.22	0.06	<0.01	0.28	<0.01	<0.01	0.34	0.13	0.47					
03/09/12 - 04/09/12	1,283	3,162	2,563	1,284	8,292	0.03	12	10	4.2	26	0.03	12	1.4	0.04	13	<0.01	0.22	8.0	4.2	12	<0.01	0.39	0.32	0.14	0.84	<0.01	0.39	0.05	<0.01	0.42	<0.01	0.01	0.26	0.14	0.39					
Subtotal Jan-Mar 2012 ⁽¹²⁾	3,847	8,135	8,908	3,850	24,740	0.09	30	35	13	78	0.09	30	4.8	0.12	35	<0.01	0.56	29	13	41	<0.01	0.33	0.38	0.14	0.86	<0.01	0.33	0.05	<0.01	0.38	<0.01	0.01	0.32	0.14	0.45					
April 2012 through June 2012 Totals																																								
04/09/12 - 05/07/12	1,195	2,917	1,898	1,195	7,205	0.03	8.8	8.0	3.6	20	0.02	8.8	0.6	0.03	9.5	<0.01	0.05	7.3	4.0	11	<0.01	0.31	0.29	0.13	0.71	<0.01	0.31	0.02	<0.01	0.34	<0.01	<0.01	0.26	0.14	0.39					
05/07/12 - 06/05/12	1,152	2,776	2,839	1,149	7,916	0.02	8.4	12	3.5	24	0.02	8.4	1.0	0.02	9.4	<0.01	0.05	11	3.4	14	<0.01	0.29	0.41	0.12	0.83	<0.01	0.29	0.03	<0.01	0.32	<0.01	<0.01	0.38	0.12	0.48					
06/05/12 - 07/02/12	1,244	2,968	3,038	1,231	8,481	0.03	9.0	13	3.7	26	0.02	8.9	1.0	0.03	10	<0.01	0.05	12	3.7	16	<0.01	0.33	0.48	0.14	1.0	<0.01	0.33	0.04	<0.01	0.37	<0.01	<0.01	0.44	0.14	0.59					
Subtotal Apr-Jun 2012 ⁽¹³⁾	3,591	8,661	7,775	3,575	23,602	0.08	26	33	11	70	0.06	26	2.6	0.08	29	<0.01	0.15	30	11	41	<0.01	0.31	0.39	0.13	0.83	<0.01	0.31	0.03	<0.01	0.35	<0.01	<0.01	0.36	0.13	0.49					
July 2012 through September 2012 Totals																																								
07/02/12 - 08/07/12	1,505	3,711	3,772	1,518	10,506	0.03	11	9.5	3.2	24	0.03	11	0.9	0.04	12	<0.01	0.14	8.6	3.2	12	<0.01	0.31	0.26	0.09	0.67	<0.01	0.31	0.03	<0.01	0.33	<0.01	<0.01	0.24	0.09	0.33					
08/07/12 - 09/04/12	1,156	2,771	2,876	1,159	7,962	0.02	8.2	7.2	2.4	18	0.02	8.0	0.7	0.03	8.8	<0.01	0.11	6.5	2.4	9.0	<0.01	0.29	0.26	0.09	0.64	<0.01	0.29	0.03	<0.01	0.31	<0.01	<0.01	0.23	0.09	0.32					
09/04/12 - 10/01/12	1,185	2,889	2,935	1,188	8,197	0.02	8.5	7.4	2.5	18	0.02	8.4	0.7	0.03	9.2	<0.01	0.11	6.7	2.5	9.3	<0.01	0.31	0.27	0.09	0.67	<0.01	0.31	0.03	<0.01	0.34	<0.01	<0.01	0.25	0.09	0.34					
Subtotal Jul-Sept 2012 ^{(14),(18)}	3,846	9,371	9,583	3,865	26,665	0.07	28	24	8.1	60	0.07	27	2.3	0.10	30	<0.01	0.36	22	8.1	30	<0.01	0.31	0.26	0.09	0.66	<0.01	0.30	0.03	<0.01	0.33	<0.01	<0.01	0.24	0.09	0.33					
October 2012 through December 2012 Totals																																								
10/01/12 - 11/05/12	1,298	3,043	3,229	1,316	8,886	0.01	10	6.9	2.5	19	0.01	10	0.61	0.03	11	<0.01	0.14	6.3	2.5	8.9	<0.01	0.29	0.20	0.07	0.54	<0.01	0.29	0.02	<0.01	0.31	<0.01	<0.01	0.18	0.07	0.25					
11/05/12 - 12/03/12	1,207	2,677	2,963	1,231	8,078	0.01	8.8	6.4	2.4	18	0.01	8.7	0.56	0.02	9.0	<0.01	0.12	5.8	2.4	8.3	<0.01	0.31	0.23	0.09	0.64	<0.01	0.31	0.02	<0.01	0.32	<0.01	<0.01	0.21	0.09	0.30					
12/03/12 - 01/01/13	1,471	3,291	3,653	1,499	9,914	0.02	11	7.9	2.9	22	0.02	11	0.69	0.03	12	<0.01	0.15	7.2	2.9	10	<0.01	0.38	0.27	0.10	0.76	<0.01	0.38	0.02	<0.01	0.41	<0.01	<0.01	0.25	0.10	0.34					
Subtotal Oct-Dec 2012 ⁽¹⁵⁾	3,976	9,011	9,845	4,046	26,878	0.04	30	21	7.8	59	0.04	30	1.9	0.08	32	<0.01	0.41	19	7.8	27	<0.01	0.33	0.23	0.08	0.64	<0.01	0.33	0.02	<0.01	0.35	<0.01	<0.01	0.21	0.08	0.29					
2012 Totals ⁽¹⁶⁾	15,260	35,178	36,111	15,336	101,885	0.28	114	113	40	267	0.26	113	12	0.38	126	<0.01	1.48	100	40	139	<0.01	0.32	0.32	0.11	0.75	<0.01	0.32	0.03	<0.01	0.35	<0.01	<0.01	0.28	0.11	0.39					
Total ⁽¹⁷⁾	52,933	120,983	128,649	52,945	355,510	1.4	728	849	221	1,798	1.4	724	94	0.77	823	<0.01	3.3	754	220	970	NA	NA	NA	NA	NA	NA	NA	NA	NA	NA	NA	NA	NA	NA	NA					

See notes on next page.

Table 7. Summary of Groundwater Recovered, VOC Mass Recovered, and VOC Mass Recovery Rates, Groundwater Interim Remedial Measure, Operable Unit 3 (Former Grumman Settling Ponds), Bethpage, New York.

Notes:

- (1) Represents operating period between consecutive monitoring events.
- (2) Volume of groundwater recovered is based on individual local well totalized flow readings. Listed value is the difference between totalized flow values recorded between consecutive monitoring events. The total groundwater recovered during a given operating period is the sum of the individual well flow totals. Values shown are rounded to the nearest gallon, but should only be considered accurate to two significant figures to account for error associated with field measurements.
- (3) Mass recovered per well was calculated by multiplying the TVOC concentration from the most recent sampling event by the number of gallons extracted during the reporting period. The total amount recovered during a given operating period is the sum of masses recovered from each of the individual wells. Values less than ten pounds are presented using two significant figures and values greater than ten pounds have been rounded to the nearest whole number; however, these values should only be considered accurate to two significant figures to account for error associated with field measurements and analytical data.
- (4) Mass recovery rates were calculated by dividing the total mass recovered for each well and for the system by the number of days in the respective operating period. Values are presented using two significant figures.
- (5) "Total VOCs" represents the sum of individual concentrations of the VOCs detected.
- (6) "Project VOCs" represents the sum of individual compound concentrations of 1,1,1-Trichloroethane; 1,1-Dichloroethane; 1,2-Dichloroethane; 1,1-Dichloroethene; Tetrachloroethene; Trichloroethelyene, Vinyl Chloride; cis-1,2-Dichloroethene; trans-1,2-Dichloroethene; Benzene; Toluene; and Xylenes-o,m, and p.
- (7) "Non-Project VOCs" represents the difference between Total VOCs and Project VOCs.
- (8) Values based on operational data recorded prior to system startup on July 21, 2009.
- (9) The volume of groundwater recovered and mass recovered calculations represent the operational period between system start-up on July 21, 2009 and December 30, 2009.
- (10) The volume of groundwater recovered and mass recovered calculations represent the operational period between December 30, 2009 and January 5, 2011.
- (11) The volume of groundwater recovered and mass recovered calculations represent the operational period between January 5, 2011 and January 9, 2012.
- (12) The volume of groundwater recovered and mass recovered calculations represent the operational period between January 9, 2012 and April 9, 2012.
- (13) The volume of groundwater recovered and mass recovered calculations represent the operational period between April 9, 2012 and July 2, 2012.
- (14) The volume of groundwater recovered and mass recovered calculations represent the operational period between July 2, 2012 and October 1, 2012.
- (15) The volume of groundwater recovered and mass recovered calculations represent the operational period between October 1, 2012 and January 1, 2013.
- (16) The volume of groundwater recovered and mass recovered calculations represent the operational period between January 9, 2012 and January 1, 2013.
- (17) "Total" refers to the amounts removed by the Operable Unit 3 Groundwater Interim Remedial Measure.
- (18) Select 20123Q calculations were modified based on updated information.

Acronyms/Key:

- IRM Interim Remedial Measure.
- gal Gallons.
- lbs Pounds.
- lbs/day Pounds per day.
- NA Not applicable.
- TVOC Total volatile organic compounds.
- < Less than.

Table 8. Summary of Air Emissions Model Output, Groundwater Interim Remedial Measure, Operable Unit 3
(Former Grumman Settling Ponds), Bethpage, New York.

Compound ⁽¹⁾	AGC ⁽²⁾ ($\mu\text{g}/\text{m}^3$)	Percent of MASC Per Event ⁽³⁾					Percent AGC ⁽⁴⁾
		1/9/12	4/3/12	7/5/12	10/03/12	12/03/12	
1,1 - Dichloroethane	0.63	0.00%	0.00%	0.02%	0.00%	0.04%	0.01%
1,1 - Dichloroethene	70	0.00%	0.00%	0.00%	0.00%	0.00%	0.00%
Acetone	30,000	0.00%	0.00%	0.00%	0.00%	0.00%	0.00%
Chloroform	0.043	0.00%	0.00%	1.09%	1.40%	2.00%	0.70%
Ethylbenzene	1,000	0.00%	0.00%	0.00%	0.00%	0.00%	0.00%
Xylenes (o)	100	0.00%	0.00%	0.00%	0.00%	0.00%	0.00%
Xylenes (m,p)	100	0.00%	0.00%	0.00%	0.00%	0.00%	0.00%
Chloromethane	90	0.00%	0.00%	0.00%	0.00%	0.00%	0.00%
Trichloroethene	0.5	0.00%	0.00%	0.05%	0.10%	0.13%	0.04%
Vinyl Chloride	0.11	1.12%	1.17%	0.00%	1.11%	3.21%	1.11%
cis 1,2 Dichloroethene	63	0.00%	0.00%	0.00%	0.00%	0.01%	0.00%
Benzene	0.13	1.29%	1.53%	0.11%	0.00%	0.22%	0.76%
Toluene	5,000	0.00%	0.00%	0.00%	0.00%	0.00%	0.00%
Trichlorofluoromethane (Freon 11)	5,000	0.00%	0.00%	0.00%	0.00%	0.00%	0.00%
Dichlorodifluoromethane (Freon 12)	12,000	0.00%	0.00%	0.00%	0.00%	0.00%	0.00%
Chlorodifluoromethane (Freon 22)	50,000	0.00%	0.00%	0.00%	0.00%	0.00%	0.00%

See notes on last page.

Table 8. Summary of Air Emissions Model Output, Groundwater Interim Remedial Measure, Operable Unit 3
(Former Grumman Settling Ponds), Bethpage, New York.

Notes:

- (1) Only VOCs that were detected in the effluent vapor sample (VSP-5) over the past year of system operation are included in this table.
- (2) AGC refers to the compound-specific annual guideline concentration per the NYSDEC DAR-1 AGC/SGC tables, revised October 18, 2010. NYSDEC DAR-1 AGCs were scaled using the results of a site-specific annual USEPA SCREEN 3 model to calculate the annual MASC per monitoring event.
- (3) Percent of AGC (or Percent MASC) was calculated by dividing the actual effluent concentration by the site-specific annual MASC. Detailed calculations are included in Appendix D.
- (4) Percent AGC is the twelve month average at the end of the reporting period. The Percent AGC was calculated by time-weighting the "Percent MASCs" for the individual sampling events over the past year. MASCs are typically calculated once per quarter, thus the MASCs for each month within a quarter are assumed to be the same. During this reporting period, additional vapor sampling was performed in December 2012 to monitor VPGAC and PPZ treatment efficiencies. For calculation purposes, each of the 4Q2012 sampling events were assumed to be representative for half the quarter (i.e. 1.5 months).

Acronyms\Key:

AGC	Annual Guideline Concentration.
DAR-1	Division of Air Resources-1.
MASC	Maximum allowable stack concentration.
NYSDEC	New York State Department of Environmental Conservation.
SGC	Short-term Guideline Concentration.
USEPA	United States Environmental Protection Agency.
VOCs	Volatile Organic Compounds.
$\mu\text{g}/\text{m}^3$	Micrograms per cubic meter.
VPGAC	Vapor Phase Granular Activated Carbon
PPZ	Potassium Permanganate Zeolite

Table 9. Concentrations of Volatile Organic Compounds in Groundwater Samples Collected from Remedial Wells, Groundwater Interim Remedial Measure, Operable Unit 3 (Former Grumman Settling Ponds), Bethpage, New York. ⁽¹⁾

COMPOUND (ug/L)	Sample Location:	RW-1	RW-1	RW-1	RW-1	RW-1	RW-1
	Sample Date:	7/29/2009	8/12/2009	9/10/2009	11/10/2009	12/2/2009	2/2/2010
NYSDEC							
<u>SCGs</u>							
1,1,1-Trichloroethane	5	< 5	< 5	< 5	< 5	< 5	< 5
1,1,2,2-Tetrachloroethane	5	< 5	< 5	< 5	< 5	< 5	< 5
1,1,2-Trichloroethane	1	< 5	< 5	< 5	< 5	< 5	< 5
1,1-Dichloroethane	5	< 5	< 5	< 5	< 5	< 5	< 5
1,1-Dichloroethene	5	< 5	< 5	< 5	< 5	< 5	< 5
1,2-Dichloroethane	0.6	< 5	< 5	< 5	< 5	< 5	< 5
1,2-Dichloropropane	1	< 5	< 5	< 5	< 5	< 5	< 5
2-Butanone	NE	6.5 J	< 50	< 50	< 50	< 50	< 50
2-Hexanone	50	< 50	< 50	< 50	< 50	< 50	< 50
4-methyl-2-pentanone	50	< 50	< 50	< 50	< 50	< 50	< 50
Acetone	NE	3.5 J	< 50	2.9 J	1.5 J	< 50	< 50
Benzene	1	< 0.7	< 0.7	< 0.7	< 0.7	< 0.7	< 0.7
Bromodichloromethane	50	< 5	< 5	< 5	< 5	< 5	< 5
Bromoform	50	< 5	< 5	< 5	< 5	< 5	< 5
Bromomethane	5	< 5	< 5	< 5	< 5	< 5 R	< 5
Carbon Disulfide	60	< 5	< 5	< 5	< 5	< 5	< 5
Carbon tetrachloride	5	< 5	< 5	< 5	< 5	< 5	< 5
Chlorobenzene	5	< 5	< 5	< 5	< 5	< 5	< 5
Chlorodifluoromethane (Freon 22)	NE	< 5	< 5	< 5	< 5	< 5	< 5
Chloroethane	5	< 5	< 5	< 5	< 5	< 5	< 5
Chloroform	7	3 J	2.4 J	1.9 J	1.4 J	1.3 J	0.8 J
Chloromethane	5	< 5	< 5	< 5	< 5	< 5 R	< 5
cis-1,2-dichloroethene	5	1.5 J	1.5 J	1.4 J	1.5 J	1.7 J	1.5 J
cis-1,3-dichloropropene	0.4	< 5	< 5	< 5	< 5	< 5	< 5
Dibromochloromethane	50	< 5	< 5	< 5	< 5	< 5	< 5
Dichlorodifluoromethane (Freon 12)	5	< 5	< 5	< 5	< 5	< 5	< 5
Ethylbenzene	5	< 5	< 5	< 5	< 5	< 5	< 5
Methyl tert-Butyl Ether	5	--	--	--	--	--	< 5
Methylene Chloride	5	< 5	< 5	< 5	< 5	< 5	< 5
Styrene	5	< 5	< 5	< 5	< 5	< 5	< 5
Tetrachloroethene	5	< 5	< 5	< 5	< 5	< 5	< 5
Toluene	5	< 5	< 5	< 5	< 5	< 5	< 5
trans-1,2-dichloroethene	5	< 5	< 5	< 5	< 5	< 5	< 5
trans-1,3-dichloropropene	0.4	< 5	< 5	< 5	< 5	< 5	< 5
Trichloroethylene	5	1.3 J	1.7 J	1.5 J	1.8 J	2 J	2 J
Trichlorofluoromethane (CFC-11)	5	--	--	--	--	--	< 5
Trichlorotrifluoroethane (Freon 113)	5	< 5	< 5	< 5	< 5	< 5	< 5
Vinyl Chloride	2	< 2	< 2	< 2	< 2	< 2	< 2
Xylene-o	5	< 5	< 5	< 5	< 5	< 5	< 5
Xylenes - m,p	5	< 5	< 5	< 5	< 5	< 5	< 5
Total VOCs ⁽²⁾		15.8	5.6	7.7	6.2	5.0	4.3
Project VOCs ⁽³⁾		2.8	3.2	2.9	3.3	3.7	3.5

See notes on last page.

Table 9. Concentrations of Volatile Organic Compounds in Groundwater Samples Collected from Remedial Wells, Groundwater Interim Remedial Measure, Operable Unit 3 (Former Grumman Settling Ponds), Bethpage, New York. ⁽¹⁾

COMPOUND (ug/L)	Sample Location: Sample Date:	RW-1 4/12/2010	RW-1 7/20/2010	RW-1 10/4/2010	RW-1 1/10/2011	RW-1 4/8/2011	RW-1 7/8/2011
NYSDEC							
<u>SCGs</u>							
1,1,1-Trichloroethane	5	< 5	< 5	< 5	< 5	< 5	< 5
1,1,2,2-Tetrachloroethane	5	< 5	< 5	< 5	< 5	< 5	< 5
1,1,2-Trichloroethane	1	< 5	< 5	< 5	< 5	< 5	< 5
1,1-Dichloroethane	5	< 5	< 5	< 5	< 5	< 5	< 5
1,1-Dichloroethene	5	< 5	< 5	< 5	< 5	< 5	< 5
1,2-Dichloroethane	0.6	< 5	< 5	< 5	< 5	< 5	< 5
1,2-Dichloropropane	1	< 5	< 5	< 5	< 5	< 5	< 5
2-Butanone	NE	< 50	< 50	< 50	< 50	< 50	< 50
2-Hexanone	50	< 50	< 50	< 50	< 50	< 50	< 50
4-methyl-2-pentanone	50	< 50	< 50	< 50	< 50	< 50	< 50
Acetone	NE	< 50	< 50	< 50	< 50	< 50	< 50
Benzene	1	< 0.7	< 0.7	< 0.7	< 0.7	< 0.7	< 0.7
Bromodichloromethane	50	< 5	< 5	< 5	< 5	< 5	< 5
Bromoform	50	< 5	< 5	< 5	< 5	< 5	< 5
Bromomethane	5	< 5	< 5	< 5	< 5	< 5	< 5
Carbon Disulfide	60	< 5	< 5	< 5	< 5	< 5	< 5
Carbon tetrachloride	5	< 5	< 5	< 5	< 5	< 5	< 5
Chlorobenzene	5	< 5	< 5	< 5	< 5	< 5	< 5
Chlorodifluoromethane (Freon 22)	NE	< 5	< 5	< 5	< 5	< 5	< 5
Chloroethane	5	< 5	< 5	< 5	< 5	< 5	< 5
Chloroform	7	0.42 J	0.36 J	0.31 J	< 5	< 5	< 5
Chloromethane	5	< 5	< 5	< 5	< 5	< 5	< 5
cis-1,2-dichloroethene	5	1.5 J	2 J	1.3 J	1.3 J	0.81 J	0.78 J
cis-1,3-dichloropropene	0.4	< 5	< 5	< 5	< 5	< 5	< 5
Dibromochloromethane	50	< 5	< 5	< 5	< 5	< 5	< 5
Dichlorodifluoromethane (Freon 12)	5	< 5	< 5	< 5	< 5	< 5	< 5
Ethylbenzene	5	< 5	< 5	< 5	< 5	< 5	< 5
Methyl tert-Butyl Ether	5	< 5	< 5	< 5	< 5	< 5	< 5
Methylene Chloride	5	< 5	< 5	< 5	< 5	< 5	< 5
Styrene	5	< 5	< 5	< 5	< 5	< 5	< 5
Tetrachloroethene	5	< 5	< 5	< 5	< 5	< 5	< 5
Toluene	5	< 5	< 5	< 5	< 5	< 5	< 5
trans-1,2-dichloroethene	5	< 5	< 5	< 5	< 5	< 5	< 5
trans-1,3-dichloropropene	0.4	< 5	< 5	< 5	< 5	< 5	< 5
Trichloroethylene	5	2.4 J	3.4 J	3 J	2.4 J	1.9 J	1.8 J
Trichlorofluoromethane (CFC-11)	5	< 5	< 5	< 5	< 5	< 5	< 5
Trichlorotrifluoroethane (Freon 113)	5	< 5	< 5	< 5	< 5	< 5	< 5
Vinyl Chloride	2	< 2	< 2	< 2	< 2	< 2	< 2
Xylene-o	5	< 5	< 5	< 5	< 5	< 5	< 5
Xylenes - m,p	5	< 5	< 5	< 5	< 5	< 5	< 5
Total VOCs ⁽²⁾		4.3	5.8	4.6	3.7	2.7	2.6
Project VOCs ⁽³⁾		3.9	5.4	4.3	3.7	2.7	2.6

See notes on last page.

Table 9. Concentrations of Volatile Organic Compounds in Groundwater Samples Collected from Remedial Wells, Groundwater Interim Remedial Measure, Operable Unit 3 (Former Grumman Settling Ponds), Bethpage, New York. ⁽¹⁾

COMPOUND (ug/L)	Sample Location: Sample Date:	RW-1 10/3/2011	RW-1 1/9/2012	RW-1 4/3/2012	RW-1 7/2/2012	RW-1 10/1/2012
NYSDEC						
<u>SCGs</u>						
1,1,1-Trichloroethane	5	< 5	< 5 U	< 5 U	< 5 U	< 5 U
1,1,2,2-Tetrachloroethane	5	< 5	< 5 U	< 5 U	< 5 U	< 5 U
1,1,2-Trichloroethane	1	< 5	< 5 U	< 5 U	< 5 U	< 5 U
1,1-Dichloroethane	5	< 5	< 5 U	< 5 U	< 5 U	< 5 U
1,1-Dichloroethene	5	< 5	< 5 U	< 5 U	< 5 U	< 5 U
1,2-Dichloroethane	0.6	< 5	< 5 U	< 5 U	< 5 U	< 5 U
1,2-Dichloropropane	1	< 5	< 5 U	< 5 U	< 5 U	< 5 U
2-Butanone	NE	< 50	< 50 U	< 50 U	< 50 U	< 50 U
2-Hexanone	50	< 50	< 50 U	< 50 U	< 50 U	< 50 U
4-methyl-2-pentanone	50	< 50	< 50 U	< 50 U	< 50 U	< 50 U
Acetone	NE	< 50	< 50 U	< 50 U	< 50 U	< 50 U
Benzene	1	< 0.7	< 0.7 U	< 0.7 U	< 0.7 U	< 0.7 U
Bromodichloromethane	50	< 5	< 5 U	< 5 U	< 5 U	< 5 U
Bromoform	50	< 5	< 5 U	< 5 U	< 5 U	< 5 U
Bromomethane	5	< 5	< 5 U	< 5 U	< 5 U	< 5 U
Carbon Disulfide	60	< 5	< 5 U	< 5 U	< 5 U	< 5 U
Carbon tetrachloride	5	< 5	< 5 U	< 5 U	< 5 U	< 5 U
Chlorobenzene	5	< 5	< 5 U	< 5 U	< 5 U	< 5 U
Chlorodifluoromethane (Freon 22)	NE	< 5	< 5 U	< 5 U	< 5 U	< 5 U
Chloroethane	5	< 5	< 5 U	< 5 U	< 5 U	< 5 U
Chloroform	7	< 5	0.22 J	0.21 J	0.23 J	< 5 U
Chloromethane	5	< 5	< 5 U	< 5 U	< 5 U	< 5 U
cis-1,2-dichloroethene	5	0.94 J	0.95 J	0.65 J	0.58 J	0.37 J
cis-1,3-dichloropropene	0.4	< 5	< 5 U	< 5 U	< 5 U	< 5 U
Dibromochloromethane	50	< 5	< 5 U	< 5 U	< 5 U	< 5 U
Dichlorodifluoromethane (Freon 12)	5	< 5	< 5 U	< 5 U	< 5 U	< 5 U
Ethylbenzene	5	< 5	< 5 U	< 5 U	< 5 U	< 5 U
Methyl tert-Butyl Ether	5	< 5	< 5 U	< 5 U	< 5 U	< 5 U
Methylene Chloride	5	< 5	< 5 U	< 5 U	< 5 U	< 5 U
Styrene	5	< 5	< 5 U	< 5 U	< 5 U	< 5 U
Tetrachloroethene	5	< 5	< 5 U	< 5 U	< 5 U	< 5 U
Toluene	5	< 5	< 5 U	< 5 U	< 5 U	< 5 U
trans-1,2-dichloroethene	5	< 5	< 5 U	< 5 U	< 5 U	< 5 U
trans-1,3-dichloropropene	0.4	< 5	< 5 U	< 5 U	< 5 U	< 5 U
Trichloroethylene	5	1.8 J	1.8 J	1.7 J	1.4 J	0.95 J
Trichlorofluoromethane (CFC-11)	5	< 5	< 5 U	< 5 U	< 5 U	< 5 U
Trichlorotrifluoroethane (Freon 113)	5	< 5	< 5 U	< 5 U	< 5 U	< 5 U
Vinyl Chloride	2	< 2	< 2 U	< 2 U	< 2 U	< 2 U
Xylene-o	5	< 5	< 5 U	< 5 U	< 5 U	< 5 U
Xylenes - m,p	5	< 5	< 5 U	< 5 U	< 5 U	< 5 U
Total VOCs ⁽²⁾		2.7	3.0	2.6	2.2	1.3
Project VOCs ⁽³⁾		2.7	2.8	2.4	2.0	1.3

See notes on last page.

Table 9. Concentrations of Volatile Organic Compounds in Groundwater Samples Collected from Remedial Wells, Groundwater Interim Remedial Measure, Operable Unit 3 (Former Grumman Settling Ponds), Bethpage, New York. ⁽¹⁾

COMPOUND (ug/L)	Sample Location:	RW-2	RW-2	RW-2	RW-2	RW-2	RW-2
	Sample Date:	7/29/2009	8/12/2009	9/10/2009	11/10/2009	12/2/2009	2/2/2010
NYSDEC							
SCGs							
1,1,1-Trichloroethane	5	< 100	< 100	< 50	< 25	< 25	< 25
1,1,2,2-Tetrachloroethane	5	< 100	< 100	< 50	< 25	< 25	< 25
1,1,2-Trichloroethane	1	< 100	< 100	< 50	< 25	< 25	< 25
1,1-Dichloroethane	5	9.2 J	8.8 J	6.4 J	5.2 J	5.3 J	3.5 J
1,1-Dichloroethene	5	< 100	< 100	< 50	2.9 J	3.1 J	< 25
1,2-Dichloroethane	0.6	< 100	< 100	< 50	< 25	< 25	< 25
1,2-Dichloropropane	1	< 100	< 100	< 50	< 25	< 25	< 25
2-Butanone	NE	< 1000	< 1000	< 500	< 250	< 250	< 250
2-Hexanone	50	< 1000	< 1000	< 500	< 250	< 250	< 250
4-methyl-2-pentanone	50	< 1000	< 1000	< 500	< 250	< 250	< 250
Acetone	NE	< 1000	< 1000	< 500	< 250	< 250	< 250
Benzene	1	< 14	< 14	< 7	< 3.5	< 3.5	< 3.5
Bromodichloromethane	50	< 100	< 100	< 50	< 25	< 25	< 25
Bromoform	50	< 100	< 100	< 50	< 25	< 25	< 25
Bromomethane	5	< 100	< 100	< 50	< 25	< 25 R	< 25
Carbon Disulfide	60	< 100	< 100	< 50	< 25	< 25	< 25
Carbon tetrachloride	5	< 100	< 100	< 50	< 25	< 25	< 25
Chlorobenzene	5	< 100	< 100	< 50	< 25	< 25	< 25
Chlorodifluoromethane (Freon 22)	NE	< 100	< 100	4 J	3.5 J	3.3 J	< 25
Chloroethane	5	< 100	< 100	< 50	< 25	< 25	< 25
Chloroform	7	< 100	< 100	3.4 J	3 J	2.3 J	2 J
Chloromethane	5	< 100	< 100	< 50	< 25	< 25 R	< 25
cis-1,2-dichloroethene	5	2,600	2,300	1,300	930	880	590
cis-1,3-dichloropropene	0.4	< 100	< 100	< 50	< 25	< 25	< 25
Dibromochloromethane	50	< 100	< 100	< 50	< 25	< 25	< 25
Dichlorodifluoromethane (Freon 12)	5	< 100	< 100	< 50	< 25	< 25	< 25
Ethylbenzene	5	13 J	7.2 J	4.8 J	6.4 J	5.1 J	1.8 J
Methyl tert-Butyl Ether	5	--	--	--	--	--	< 25
Methylene Chloride	5	< 100	< 100	< 50	< 25	< 25	< 25
Styrene	5	< 100	< 100	< 50	< 25	< 25	< 25
Tetrachloroethene	5	< 100	< 100	< 50	< 25	< 25	< 25
Toluene	5	520	170	190	200	150	49
trans-1,2-dichloroethene	5	12 J	21 J	32 J	6.2 J	2.1 J	49
trans-1,3-dichloropropene	0.4	< 100	< 100	< 50	< 25	< 25	< 25
Trichloroethylene	5	46 J	30 J	52	59	63	46
Trichlorofluoromethane (CFC-11)	5	--	--	--	--	--	< 25
Trichlorotrifluoroethane (Freon 113)	5	< 100	< 100	< 50	< 25	< 25	< 25
Vinyl Chloride	2	630	670	370	210	210	83
Xylene-o	5	14 J	9.4 J	5.4 J	6 J	4.9 J	< 25
Xylenes - m,p	5	27 J	9.2 J	7.9 J	11 J	9 J	< 25
Total VOCs ⁽²⁾		3,871	3,226	1,976	1,443	1,338	824
Project VOCs ⁽³⁾		3,849	3,210	1,957	1,430	1,327	821

See notes on last page.

Table 9. Concentrations of Volatile Organic Compounds in Groundwater Samples Collected from Remedial Wells, Groundwater Interim Remedial Measure, Operable Unit 3 (Former Grumman Settling Ponds), Bethpage, New York. ⁽¹⁾

COMPOUND (ug/L)	Sample Location: Sample Date:	RW-2 4/12/2010	RW-2 7/20/2010	RW-2 10/4/2010	RW-2 1/10/2011	RW-2 6/8/2011	RW-2 7/8/2011
NYSDEC							
<u>SCGs</u>							
1,1,1-Trichloroethane	5	< 13	< 13	< 13	0.78 J	1.1 J	0.93 J
1,1,2,2-Tetrachloroethane	5	< 13	< 13	< 13	< 13	< 5	< 13
1,1,2-Trichloroethane	1	< 13	< 13	< 13	< 13	< 5	< 13
1,1-Dichloroethane	5	3.2 J	2.3 J	2.2 J	3.5 J	3.1 J	2.4 J
1,1-Dichloroethene	5	3 J	2.1 J	2.2 J	4.9 J	2.8 J	2.7 J
1,2-Dichloroethane	0.6	< 13	< 13	< 13	< 13	< 5	< 13
1,2-Dichloropropane	1	< 13	< 13	< 13	< 13	0.38 J	< 13
2-Butanone	NE	< 130	< 130	< 130	< 130	< 50	< 130
2-Hexanone	50	< 130	< 130	< 130	< 130	< 50	< 130
4-methyl-2-pentanone	50	< 130	< 130	< 130	< 130	< 50	< 130
Acetone	NE	< 130	< 130	< 130 B	< 130 B	< 50	< 130
Benzene	1	< 1.8	< 1.8	< 1.8	< 1.8	< 0.7	< 1.8
Bromodichloromethane	50	< 13	< 13	< 13	< 13	< 5	< 13
Bromoform	50	< 13	< 13	< 13	< 13	< 5	< 13
Bromomethane	5	< 13	< 13	< 13	< 13	< 5	< 13
Carbon Disulfide	60	< 13	< 13	< 13	< 13	< 5	< 13
Carbon tetrachloride	5	< 13	< 13	< 13	< 13	< 5	< 13
Chlorobenzene	5	< 13	< 13	< 13	< 13	< 5	< 13
Chlorodifluoromethane (Freon 22)	NE	1.7 J	1.1 J	1 J	1.4 J	0.98 J	1.3 J
Chloroethane	5	< 13	< 13	< 13	< 13	< 5	< 13
Chloroform	7	1.5 J	1.4 J	1.9 J	1.9 J	1.3 J	1.3 J
Chloromethane	5	< 13	< 13	< 13	< 13	< 5	< 13
cis-1,2-dichloroethene	5	480	310	270	460	300 D	320
cis-1,3-dichloropropene	0.4	< 13	< 13	< 13	< 13	< 5	< 13
Dibromochloromethane	50	< 13	< 13	< 13	< 13	< 5	< 13
Dichlorodifluoromethane (Freon 12)	5	< 13	< 13	< 13	< 13	< 5	< 13
Ethylbenzene	5	2.2 J	1.7 J	1.5 J	2.6 J	1.7 J	2.4 J
Methyl tert-Butyl Ether	5	< 13	< 13	< 13	< 13	< 5	< 13
Methylene Chloride	5	< 13	< 13	< 13	< 13	< 5	< 13
Styrene	5	< 13	< 13	< 13	< 13	< 5	< 13
Tetrachloroethene	5	< 13	< 13	< 13	< 13	0.43 J	< 13
Toluene	5	71	35	25	62	62	81
trans-1,2-dichloroethene	5	< 13	0.95 J	< 13	< 13	0.42 J	< 13
trans-1,3-dichloropropene	0.4	< 13	< 13	< 13	< 13	< 5	< 13
Trichloroethylene	5	43	35	36	51	30	25
Trichlorofluoromethane (CFC-11)	5	< 13	< 13	< 13	< 13	< 5 U	< 13
Trichlorotrifluoroethane (Freon 113)	5	< 13	< 13	< 13	< 13	< 5	< 13
Vinyl Chloride	2	94	54	45	87	88	67
Xylene-o	5	2.2 J	1.3 J	0.9 J	2.6 J	2.6 J	2.6 J
Xylenes - m,p	5	3.5 J	2.4 J	1.9 J	3.8 J	4.5 J	4.6 J
Total VOCs ⁽²⁾		705	447	388	681	499	511
Project VOCs ⁽³⁾		699	443	383	676	495	506

See notes on last page.

Table 9. Concentrations of Volatile Organic Compounds in Groundwater Samples Collected from Remedial Wells, Groundwater Interim Remedial Measure, Operable Unit 3 (Former Grumman Settling Ponds), Bethpage, New York. ⁽¹⁾

COMPOUND (ug/L)	Sample Location: Sample Date:	RW-2 10/3/2011	RW-2 1/9/2012	RW-2 4/3/2012	RW-2 (dup.) 4/3/2012	RW-2 7/2/2012	RW-2 10/1/2012
NYSDEC							
<u>SCGs</u>							
1,1,1-Trichloroethane	5	0.73 J	< 13 U	0.52 J	< 10 U	0.46 J	0.51 J
1,1,2,2-Tetrachloroethane	5	< 13 U	< 13 U	< 10 U	< 10 U	< 5 U	< 5 U
1,1,2-Trichloroethane	1	< 13 U	< 13 U	< 10 U	< 10 U	< 5 U	< 5 U
1,1-Dichloroethane	5	2.0 J	1.7 J	1.4 J	1.6 J	1.5 J	1.6 J
1,1-Dichloroethene	5	1.7 J	0.98 J	0.92 J	0.84 J	1.2 J	1 J
1,2-Dichloroethane	0.6	< 13 U	< 13 U	< 10 U	< 10 U	< 5 U	< 5 U
1,2-Dichloropropane	1	< 13 U	< 13 U	< 10 U	< 10 U	< 5 U	0.28 J
2-Butanone	NE	< 130 U	< 130 U	< 100 U	< 100 U	< 50 U	< 50 U
2-Hexanone	50	< 130 U	< 130 U	< 100 U	< 100 U	< 50 U	< 50 U
4-methyl-2-pentanone	50	< 130 U	< 130 U	< 100 U	< 100 U	< 50 U	< 50 U
Acetone	NE	< 130 UB	3.4 J	< 100 U	1.5 J	< 50 U	< 50 U
Benzene	1	< 1.8 U	< 1.8 U	< 1.4 U	< 1.4 U	< 0.7 U	< 0.7 U
Bromodichloromethane	50	< 13 U	< 13 U	< 10 U	< 10 U	< 5 U	< 5 U
Bromoform	50	< 13 U	< 13 U	< 10 U	< 10 U	< 5 U	< 5 U
Bromomethane	5	< 13 U	< 13 U	< 10 U	< 10 U	< 5 U	< 5 U
Carbon Disulfide	60	< 13 U	< 13 U	< 10 U	< 10 U	< 5 U	< 5 U
Carbon tetrachloride	5	< 13 U	< 13 U	< 10 U	< 10 U	< 5 U	< 5 U
Chlorobenzene	5	< 13 U	< 13 U	< 10 U	< 10 U	0.22 J	< 5 U
Chlorodifluoromethane (Freon 22)	NE	0.60 J	0.95 J	0.64 J	0.48 J	0.44 J	0.4 J
Chloroethane	5	< 13 U	< 13 U	< 10 U	< 10 U	< 5 U	< 5 U
Chloroform	7	1.1 J	1.4 J	1 J	1.1 J	1.4 J	1.9 J
Chloromethane	5	< 13 U	< 13 U	< 10 U	< 10 U	< 5 U	< 5 U
cis-1,2-dichloroethene	5	280	260	220	220	200	200
cis-1,3-dichloropropene	0.4	< 13 U	< 13 U	< 10 U	< 10 U	< 5 U	< 5 U
Dibromochloromethane	50	< 13 U	< 13 U	< 10 U	< 10 U	< 5 U	< 5 U
Dichlorodifluoromethane (Freon 12)	5	< 13 U	< 13 U	< 10 U	< 10 U	< 5 U	< 5 U
Ethylbenzene	5	2.5 J	2.4 J	1.5 J	1.6 J	2.8 J	3.3 J
Methyl tert-Butyl Ether	5	< 13 U	< 13 U	< 10 U	< 10 U	< 5 U	< 5 U
Methylene Chloride	5	< 13 U	< 13 U	< 10 U	< 10 U	< 5 U	< 5 U
Styrene	5	< 13 U	< 13 U	< 10 U	< 10 U	< 5 U	< 5 U
Tetrachloroethene	5	0.58 J	< 13 U	< 10 U	< 10 U	0.4 J	0.36 J
Toluene	5	72	81	60	61	73	96
trans-1,2-dichloroethene	5	0.63 J	< 13 U	0.46 J	< 10 U	0.87 J	0.26 J
trans-1,3-dichloropropene	0.4	< 13 U	< 13 U	< 10 U	< 10 U	< 5 U	< 5 U
Trichloroethylene	5	25	23	18	18	20	20
Trichlorofluoromethane (CFC-11)	5	< 13 U	< 13 U	< 10 U	< 10 U	< 5 U	< 5 U
Trichlorotrifluoroethane (Freon 113)	5	< 13 U	< 13 U	< 10 U	< 10 U	< 5 U	< 5 U
Vinyl Chloride	2	55	59	54	54	44	61
Xylene-o	5	2.6 J	2.6 J	2.2 J	2.3 J	2.6 J	2.7 J
Xylenes - m,p	5	4.2 J	4.7 J	3.6 J	4.1 J	4.5 J	5.8
Total VOCs ⁽²⁾		449	441	364	367	353	395
Project VOCs ⁽³⁾		444	433	361	362	349	374

See notes on last page.

Table 9. Concentrations of Volatile Organic Compounds in Groundwater Samples Collected from Remedial Wells, Groundwater Interim Remedial Measure, Operable Unit 3 (Former Grumman Settling Ponds), Bethpage, New York. ⁽¹⁾

COMPOUND (ug/L)	Sample Location:	RW-3	RW-3	RW-3	RW-3	RW-3	RW-3
	Sample Date:	7/29/2009	8/12/2009	9/10/2009	11/10/2009	12/2/2009	2/2/2010
NYSDEC							
<u>SCGs</u>							
1,1,1-Trichloroethane	5	< 5	< 5	< 5	< 5	< 13	< 25
1,1,2,2-Tetrachloroethane	5	< 5	< 5	< 5	< 5	< 13	< 25
1,1,2-Trichloroethane	1	< 5	< 5	< 5	< 5	< 13	< 25
1,1-Dichloroethane	5	2.4 J	2.1 J	1.9 J	1.4 J	1.3 J	< 25
1,1-Dichloroethene	5	< 5	0.35 J	0.41 J	0.53 J	< 13	< 25
1,2-Dichloroethane	0.6	< 5	< 5	< 5	< 5	< 13	< 25
1,2-Dichloropropane	1	< 5	< 5	< 5	< 5	< 13	< 25
2-Butanone	NE	< 50	< 50	< 50	< 50	< 130	< 250
2-Hexanone	50	< 50	< 50	< 50	< 50	< 130	< 250
4-methyl-2-pentanone	50	< 50	< 50	< 50	< 50	< 130	< 250
Acetone	NE	< 50	< 50	2 J	3.1 J	< 130	< 250
Benzene	1	< 0.7	< 0.7	< 0.7	< 0.7	< 1.8	< 3.5
Bromodichloromethane	50	0.35 J	< 5	< 5	< 5	< 13	< 25
Bromoform	50	< 5	< 5	< 5	< 5	< 13	< 25
Bromomethane	5	< 5	< 5	< 5	< 5	< 13	< 25
Carbon Disulfide	60	< 5	< 5	< 5	< 5	< 13	< 25
Carbon tetrachloride	5	< 5	< 5	< 5	< 5	< 13	< 25
Chlorobenzene	5	< 5	< 5	< 5	< 5	< 13	< 25
Chlorodifluoromethane (Freon 22)	NE	2.1 J	8.5	93	490 D	660 D	1,300 D
Chloroethane	5	< 5	< 5	< 5	< 5	< 13	< 25
Chloroform	7	2.1 J	2.3 J	2.9 J	5.9	6 J	4.3 J
Chloromethane	5	< 5	< 5	< 5	< 5	< 13 R	< 25
cis-1,2-dichloroethene	5	130	120	130	85	72	68
cis-1,3-dichloropropene	0.4	< 5	< 5	< 5	< 5	< 13	< 25
Dibromochloromethane	50	< 5	< 5	< 5	< 5	< 13	< 25
Dichlorodifluoromethane (Freon 12)	5	< 5	< 5	< 5	< 5	< 13	< 25
Ethylbenzene	5	< 5	< 5	< 5	< 5	< 13	< 25
Methyl tert-Butyl Ether	5	--	--	--	--	--	< 25
Methylene Chloride	5	< 5	< 5	< 5	< 5	< 13	< 25
Styrene	5	< 5	< 5	< 5	< 5	< 13	< 25
Tetrachloroethene	5	0.81 J	0.56 J	0.83 J	0.54 J	< 13	< 25
Toluene	5	< 5	< 5	< 5	< 5	< 13	< 25
trans-1,2-dichloroethene	5	0.68 J	0.54 J	0.59 J	0.52 J	< 13	7.2 J
trans-1,3-dichloropropene	0.4	< 5	< 5	< 5	< 5	< 13	< 25
Trichloroethylene	5	37	34	29	24	22	19 J
Trichlorofluoromethane (CFC-11)	5	--	--	--	--	--	< 25
Trichlorotrifluoroethane (Freon 113)	5	< 5	< 5	< 5	< 5	< 13	< 25
Vinyl Chloride	2	< 2	< 2	0.47 J	0.42 J	< 5	< 10
Xylene-o	5	< 5	< 5	< 5	< 5	< 13	< 25
Xylenes - m,p	5	< 5	< 5	< 5	< 5	< 13	< 25
Total VOCs ⁽²⁾		175	168	261	611	761	1,399
Project VOCs ⁽³⁾		171	158	163	112	95	94

See notes on last page.

Table 9. Concentrations of Volatile Organic Compounds in Groundwater Samples Collected from Remedial Wells, Groundwater Interim Remedial Measure, Operable Unit 3 (Former Grumman Settling Ponds), Bethpage, New York. ⁽¹⁾

COMPOUND (ug/L)	Sample Location: Sample Date:	RW-3 4/12/2010	RW-3 7/20/2010	RW-3 10/4/2010	RW-3 1/10/2011	RW-3 4/8/2011	RW-3 7/8/2011
NYSDEC							
<u>SCGs</u>							
1,1,1-Trichloroethane	5	< 25	< 50	< 25	< 25	< 25	< 25
1,1,2,2-Tetrachloroethane	5	< 25	< 50	< 25	< 25	< 25	< 25
1,1,2-Trichloroethane	1	< 25	< 50	< 25	< 25	< 25	< 25
1,1-Dichloroethane	5	< 25	< 50	< 25	< 25	< 25	< 25
1,1-Dichloroethene	5	< 25	< 50	< 25	< 25	< 25	< 25
1,2-Dichloroethane	0.6	< 25	< 50	< 25	< 25	< 25	< 25
1,2-Dichloropropane	1	< 25	< 50	< 25	< 25	< 25	< 25
2-Butanone	NE	< 250	< 500	< 250	< 250	< 250	< 250
2-Hexanone	50	< 250	< 500	< 250	< 250	< 250	< 250
4-methyl-2-pentanone	50	< 250	< 500	< 250	< 250	< 250	< 250
Acetone	NE	< 250	< 500	< 250	< 250 B	< 250	< 250
Benzene	1	< 3.5	< 7	< 3.5	< 3.5	< 3.5	< 3.5
Bromodichloromethane	50	< 25	< 50	< 25	< 25	< 25	< 25
Bromoform	50	< 25	< 50	< 25	< 25	< 25	< 25
Bromomethane	5	< 25	< 50	< 25	< 25	< 25	< 25
Carbon Disulfide	60	< 25	< 50	< 25	< 25	< 25	< 25
Carbon tetrachloride	5	< 25	< 50	< 25	< 25	< 25	< 25
Chlorobenzene	5	< 25	< 50	< 25	< 25	< 25	< 25
Chlorodifluoromethane (Freon 22)	NE	1,300 D	1400	880	890	900	670
Chloroethane	5	< 25	< 50	< 25	< 25	< 25	< 25
Chloroform	7	3.2 J	< 50	6.6 J	5.8 J	4.0 J	2.5 J
Chloromethane	5	< 25	< 50	< 25	< 25	< 25	< 25
cis-1,2-dichloroethene	5	70	64	64	74	93	110
cis-1,3-dichloropropene	0.4	< 25	< 50	< 25	< 25	< 25	< 25
Dibromochloromethane	50	< 25	< 50	< 25	< 25	< 25	< 25
Dichlorodifluoromethane (Freon 12)	5	< 25	< 50	< 25	< 25	< 25	< 25
Ethylbenzene	5	< 25	< 50	< 25	< 25	< 25	< 25
Methyl tert-Butyl Ether	5	< 25	< 50	< 25	< 25	< 25	< 25
Methylene Chloride	5	< 25	< 50	< 25	< 25	< 25	< 25
Styrene	5	< 25	< 50	< 25	< 25	< 25	< 25
Tetrachloroethene	5	< 25	< 50	< 25	< 25	< 25	< 25
Toluene	5	< 25	< 50	< 25	< 25	< 25	< 25
trans-1,2-dichloroethene	5	< 25	4.8 J	6.7 J	3.9 J	6.5 J	< 25
trans-1,3-dichloropropene	0.4	< 25	< 50	< 25	< 25	< 25	< 25
Trichloroethylene	5	17 J	14 J	12 J	10 J	6.8 J	7.7 J
Trichlorofluoromethane (CFC-11)	5	< 25	< 50	< 25	< 25	< 25	< 25
Trichlorotrifluoroethane (Freon 113)	5	< 25	< 50	< 25	< 25	< 25	< 25
Vinyl Chloride	2	< 10	< 20	2.6 J	5.1 J	11	9.9 J
Xylene-o	5	< 25	< 50	< 25	< 25	< 25	< 25
Xylenes - m,p	5	< 25	< 50	< 25	< 25	< 25	< 25
Total VOCs ⁽²⁾		1,390	1,483	972	989	1,021	800
Project VOCs ⁽³⁾		87	83	85	93	117	128

See notes on last page.

Table 9. Concentrations of Volatile Organic Compounds in Groundwater Samples Collected from Remedial Wells, Groundwater Interim Remedial Measure, Operable Unit 3 (Former Grumman Settling Ponds), Bethpage, New York. ⁽¹⁾

COMPOUND (ug/L)	Sample Location: Sample Date:	RW-3 10/3/2011	RW-3 1/9/2012	RW-3 4/3/2012	RW-3 7/2/2012	RW-3 10/1/2012
NYSDEC						
<u>SCGs</u>						
1,1,1-Trichloroethane	5	< 25 U	< 13 U	< 13 U	< 10 U	< 10 U
1,1,2,2-Tetrachloroethane	5	< 25 U	< 13 U	< 13 U	< 10 U	< 10 U
1,1,2-Trichloroethane	1	< 25 U	< 13 U	< 13 U	< 10 U	< 10 U
1,1-Dichloroethane	5	< 25 U	< 13 U	< 13 U	< 10 U	< 10 U
1,1-Dichloroethene	5	< 25 U	< 13 U	< 13 U	< 10 U	< 10 U
1,2-Dichloroethane	0.6	< 25 U	< 13 U	< 13 U	< 10 U	< 10 U
1,2-Dichloropropane	1	< 25 U	< 13 U	< 13 U	< 10 U	< 10 U
2-Butanone	NE	< 250 U	< 130 U	< 130 U	< 100 U	< 100 U
2-Hexanone	50	< 250 U	< 130 U	< 130 U	< 100 U	< 100 U
4-methyl-2-pentanone	50	< 250 U	< 130 U	< 130 U	< 100 U	< 100 U
Acetone	NE	< 250 U	< 130 U	< 130 U	< 100 UB	< 100 U
Benzene	1	< 3.5 U	< 1.8 U	< 1.8 U	< 1.4 U	< 1.4 U
Bromodichloromethane	50	< 25 U	< 13 U	< 13 U	< 10 U	< 10 U
Bromoform	50	< 25 U	< 13 U	< 13 U	< 10 U	< 10 U
Bromomethane	5	< 25 U	< 13 U	< 13 U	< 10 U	< 10 U
Carbon Disulfide	60	< 25 U	< 13 U	< 13 U	< 10 U	< 10 U
Carbon tetrachloride	5	< 25 U	< 13 U	< 13 U	< 10 U	< 10 U
Chlorobenzene	5	< 25 U	< 13 U	< 13 U	< 10 U	< 10 U
Chlorodifluoromethane (Freon 22)	NE	540	390	460	270	230
Chloroethane	5	< 25 U	< 13 U	< 13 U	< 10 U	< 10 U
Chloroform	7	5.5 J	6.9 J	3.4 J	2.9 J	5.3 J
Chloromethane	5	< 25 U	< 13 U	< 13 U	< 10 U	< 10 U
cis-1,2-dichloroethene	5	92	55	33	22	17
cis-1,3-dichloropropene	0.4	< 25 U	< 13 U	< 13 U	< 10 U	< 10 U
Dibromochloromethane	50	< 25 U	< 13 U	< 13 U	< 10 U	< 10 U
Dichlorodifluoromethane (Freon 12)	5	< 25 U	< 13 U	< 13 U	< 10 U	< 10 U
Ethylbenzene	5	< 25 U	< 13 U	< 13 U	< 10 U	< 10 U
Methyl tert-Butyl Ether	5	< 25 U	< 13 U	< 13 U	< 10 U	< 10 U
Methylene Chloride	5	< 25 U	< 13 U	< 13 U	< 10 U	< 10 U
Styrene	5	< 25 U	< 13 U	< 13 U	< 10 U	< 10 U
Tetrachloroethene	5	< 25 U	< 13 U	< 13 U	< 10 U	< 10 U
Toluene	5	< 25 U	< 13 U	< 13 U	< 10 U	< 10 U
trans-1,2-dichloroethene	5	1.8 J	< 13 U	< 13 U	< 10 U	< 10 U
trans-1,3-dichloropropene	0.4	< 25 U	< 13 U	< 13 U	< 10 U	< 10 U
Trichloroethylene	5	7.5 J	6.7 J	6 J	6.5 J	5.3 J
Trichlorofluoromethane (CFC-11)	5	< 25 U	< 13 U	< 13 U	< 10 U	< 10 U
Trichlorotrifluoroethane (Freon 113)	5	< 25 U	< 13 U	< 13 U	< 10 U	< 10 U
Vinyl Chloride	2	7.1 J	2.8 J	1.2 J	0.8 J	0.48 J
Xylene-o	5	< 25 U	< 13 U	< 13 U	< 10 U	< 10 U
Xylenes - m,p	5	< 25 U	< 13 U	< 13 U	< 10 U	< 10 U
Total VOCs ⁽²⁾		654	461	504	302	258
Project VOCs ⁽³⁾		108	65	40	29	23

See notes on last page.

Table 9. Concentrations of Volatile Organic Compounds in Groundwater Samples Collected from Remedial Wells, Groundwater Interim Remedial Measure, Operable Unit 3 (Former Grumman Settling Ponds), Bethpage, New York. ⁽¹⁾

COMPOUND (ug/L)	Sample Location: Sample Date:	RW-4 7/29/2009	RW-4 8/12/2009	RW-4 9/10/2009	RW-4 11/10/2009	RW-4 12/2/2009	RW-4 2/2/2010
	NYSDEC						
	<u>SCGs</u>						
1,1,1-Trichloroethane	5	< 5	< 5	< 5	< 5	< 10	< 10
1,1,2,2-Tetrachloroethane	5	< 5	< 5	< 5	< 5	< 10	< 10
1,1,2-Trichloroethane	1	< 5	< 5	< 5	< 5	< 10	< 10
1,1-Dichloroethane	5	0.42 J	0.38 J	0.47 J	0.52 J	< 10	0.6 J
1,1-Dichloroethene	5	< 5	< 5	< 5	< 5	< 10	< 10
1,2-Dichloroethane	0.6	< 5	< 5	< 5	< 5	< 10	< 10
1,2-Dichloropropane	1	< 5	< 5	< 5	< 5	< 10	< 10
2-Butanone	NE	< 50	< 50	< 50	< 50	< 100	< 100
2-Hexanone	50	< 50	< 50	< 50	< 50	< 100	< 100
4-methyl-2-pentanone	50	< 50	< 50	< 50	< 50	< 100	< 100
Acetone	NE	< 50	< 50	< 50	3.5 J	< 100	< 100
Benzene	1	< 0.7	< 0.7	< 0.7	< 0.7	< 1.4	< 1.4
Bromodichloromethane	50	< 5	< 5	< 5	< 5	< 10	< 10
Bromoform	50	< 5	< 5	< 5	< 5	< 10	< 10
Bromomethane	5	< 5	< 5	< 5	< 5	< 10 R	< 10
Carbon Disulfide	60	< 5	< 5	< 5	< 5	< 10	< 10
Carbon tetrachloride	5	< 5	< 5	< 5	< 5	< 10	< 10
Chlorobenzene	5	< 5	< 5	< 5	< 5	< 10	< 10
Chlorodifluoromethane (Freon 22)	NE	140	200	330 D	230 D	290	440 D
Chloroethane	5	< 5	< 5	< 5	< 5	< 10	< 10
Chloroform	7	1 J	0.88 J	0.78 J	0.95 J	0.88 J	0.72 J
Chloromethane	5	< 5	< 5	< 5	< 5	< 10 R	< 10
cis-1,2-dichloroethene	5	1.5 J	1.7 J	1.9 J	1.9 J	2.2 J	1.8 J
cis-1,3-dichloropropene	0.4	< 5	< 5	< 5	< 5	< 10	< 10
Dibromochloromethane	50	< 5	< 5	< 5	< 5	< 10	< 10
Dichlorodifluoromethane (Freon 12)	5	< 5	< 5	< 5	< 5	< 10	< 10
Ethylbenzene	5	< 5	< 5	< 5	< 5	< 10	< 10
Methyl tert-Butyl Ether	5	--	--	--	--	--	< 10
Methylene Chloride	5	< 5	< 5	< 5	< 5	< 10	< 10
Styrene	5	< 5	< 5	< 5	< 5	< 10	< 10
Tetrachloroethene	5	0.44 J	0.44 J	0.44 J	0.48 J	< 10	0.64 J
Toluene	5	< 5	< 5	< 5	< 5	< 10	< 10
trans-1,2-dichloroethene	5	< 5	< 5	< 5	< 5	< 10	< 10
trans-1,3-dichloropropene	0.4	< 5	< 5	< 5	< 5	< 10	< 10
Trichloroethylene	5	1.1 J	1.2 J	1.6 J	1.9 J	1.8 J	1.4 J
Trichlorofluoromethane (CFC-11)	5	--	--	--	--	--	< 10
Trichlorotrifluoroethane (Freon 113)	5	< 5	< 5	< 5	< 5	< 10	< 10
Vinyl Chloride	2	< 2	< 2	< 2	< 2	< 4	< 4
Xylene-o	5	< 5	< 5	< 5	< 5	< 10	< 10
Xylenes - m,p	5	< 5	< 5	< 5	< 5	< 10	< 10
Total VOCs ⁽²⁾		144	205	335	239	295	445
Project VOCs ⁽³⁾		3.5	3.7	4.4	4.8	4.0	4.4

See notes on last page.

Table 9. Concentrations of Volatile Organic Compounds in Groundwater Samples Collected from Remedial Wells, Groundwater Interim Remedial Measure, Operable Unit 3 (Former Grumman Settling Ponds), Bethpage, New York. ⁽¹⁾

COMPOUND (ug/L)	Sample Location: Sample Date:	RW-4 4/12/2010	RW-4 7/20/2010	RW-4 10/4/2010	RW-4 1/10/2011	RW-4 4/8/2011	RW-4 7/8/2011
NYSDEC							
<u>SCGs</u>							
1,1,1-Trichloroethane	5	< 13	< 25	< 25	< 25	< 25	< 25
1,1,2,2-Tetrachloroethane	5	< 13	< 25	< 25	< 25	< 25	< 25
1,1,2-Trichloroethane	1	< 13	< 25	< 25	< 25	< 25	< 25
1,1-Dichloroethane	5	< 13	< 25	< 25	< 25	< 25	< 25
1,1-Dichloroethene	5	< 13	< 25	< 25	< 25	< 25	< 25
1,2-Dichloroethane	0.6	< 13	< 25	< 25	< 25	< 25	< 25
1,2-Dichloropropane	1	< 13	< 25	< 25	< 25	< 25	< 25
2-Butanone	NE	< 130	< 250	< 250	< 250	< 250	< 250
2-Hexanone	50	< 130	< 250	< 250	< 250	< 250	< 250
4-methyl-2-pentanone	50	< 130	< 250	< 250	< 250	< 250	< 250
Acetone	NE	< 130	< 250	< 250	< 250	< 250	< 250
Benzene	1	< 1.8	< 3.5	< 3.5	< 3.5	< 3.5	< 3.5
Bromodichloromethane	50	< 13	< 25	< 25	< 25	< 25	< 25
Bromoform	50	< 13	< 25	< 25	< 25	< 25	< 25
Bromomethane	5	< 13	< 25	< 25	< 25	< 25	< 25
Carbon Disulfide	60	< 13	< 25	< 25	< 25	< 25	< 25
Carbon tetrachloride	5	< 13	< 25	< 25	< 25	< 25	< 25
Chlorobenzene	5	< 13	< 25	< 25	< 25	< 25	< 25
Chlorodifluoromethane (Freon 22)	NE	560 D	840	850	820	650	520
Chloroethane	5	< 13	< 25	< 25	< 25	< 25	< 25
Chloroform	7	0.8 J	< 25	< 25	< 25	< 25	< 25
Chloromethane	5	< 13	< 25	< 25	< 25	< 25	< 25
cis-1,2-dichloroethene	5	1.5 J	< 25	< 25	< 25	< 25	< 25
cis-1,3-dichloropropene	0.4	< 13	< 25	< 25	< 25	< 25	< 25
Dibromochloromethane	50	< 13	< 25	< 25	< 25	< 25	< 25
Dichlorodifluoromethane (Freon 12)	5	< 13	< 25	< 25	< 25	< 25	< 25
Ethylbenzene	5	< 13	< 25	< 25	< 25	< 25	< 25
Methyl tert-Butyl Ether	5	< 13	< 25	< 25	< 25	< 25	< 25
Methylene Chloride	5	< 13	< 25	< 25	< 25	< 25	< 25
Styrene	5	< 13	< 25	< 25	< 25	< 25	< 25
Tetrachloroethene	5	0.9 J	< 25	< 25	< 25	< 25	< 25
Toluene	5	< 13	< 25	< 25	< 25	< 25	< 25
trans-1,2-dichloroethene	5	< 13	< 25	< 25	< 25	< 25	< 25
trans-1,3-dichloropropene	0.4	< 13	< 25	< 25	< 25	< 25	< 25
Trichloroethylene	5	1.4 J	< 25	< 25	< 25	< 25	< 25
Trichlorofluoromethane (CFC-11)	5	< 13	< 25	< 25	< 25	< 25	< 25
Trichlorotrifluoroethane (Freon 113)	5	< 13	< 25	< 25	< 25	< 25	< 25
Vinyl Chloride	2	< 5	< 10	< 10	< 10	< 10	< 10
Xylene-o	5	< 13	< 25	< 25	< 25	< 25	< 25
Xylenes - m,p	5	< 13	< 25	< 25	< 25	< 25	< 25
Total VOCs ⁽²⁾		565	840	850	820	650	520
Project VOCs ⁽³⁾		3.8	0.0	0.0	0.0	0.0	0.0

See notes on last page.

Table 9. Concentrations of Volatile Organic Compounds in Groundwater Samples Collected from Remedial Wells, Groundwater Interim Remedial Measure, Operable Unit 3 (Former Grumman Settling Ponds), Bethpage, New York. ⁽¹⁾

COMPOUND (ug/L)	Sample Location: Sample Date:	RW-4 10/3/2011	RW-4 1/9/2012	RW-4 4/3/2012	RW-4 7/2/2012	RW-4 10/1/2012
NYSDEC						
<u>SCGs</u>						
1,1,1-Trichloroethane	5	< 13 U	< 13 U	< 13 U	< 10 U	< 10 U
1,1,2,2-Tetrachloroethane	5	< 13 U	< 13 U	< 13 U	< 10 U	< 10 U
1,1,2-Trichloroethane	1	< 13 U	< 13 U	< 13 U	< 10 U	< 10 U
1,1-Dichloroethane	5	0.55 J	0.73 J	0.63 J	0.6 J	0.54 J
1,1-Dichloroethene	5	< 13 U	< 13 U	< 13 U	< 10 U	< 10 U
1,2-Dichloroethane	0.6	< 13 U	< 13 U	< 13 U	< 10 U	< 10 U
1,2-Dichloropropane	1	< 13 U	< 13 U	< 13 U	< 10 U	< 10 U
2-Butanone	NE	< 130 U	< 130 U	< 130 U	< 100 U	< 100 U
2-Hexanone	50	< 130 U	< 130 U	< 130 U	< 100 U	< 100 U
4-methyl-2-pentanone	50	< 130 U	< 130 U	< 130 U	< 100 U	< 100 U
Acetone	NE	< 130 U	< 130 U	< 130 U	< 100 UB	< 100 U
Benzene	1	< 1.8 U	< 1.8 U	< 1.8 U	< 1.4 U	< 1.4 U
Bromodichloromethane	50	< 13 U	< 13 U	< 13 U	< 10 U	< 10 U
Bromoform	50	< 13 U	< 13 U	< 13 U	< 10 U	< 10 U
Bromomethane	5	< 13 U	< 13 U	< 13 U	< 10 U	< 10 U
Carbon Disulfide	60	< 13 U	< 13 U	< 13 U	< 10 U	< 10 U
Carbon tetrachloride	5	< 13 U	< 13 U	< 13 U	< 10 U	< 10 U
Chlorobenzene	5	< 13 U	< 13 U	< 13 U	< 10 U	< 10 U
Chlorodifluoromethane (Freon 22)	NE	430	390	360	250	230
Chloroethane	5	< 13 U	< 13 U	< 13 U	< 10 U	< 10 U
Chloroform	7	< 13 U	< 13 U	< 13 U	< 10 U	< 10 U
Chloromethane	5	< 13 U	< 13 U	< 13 U	< 10 U	< 10 U
cis-1,2-dichloroethene	5	0.63 J	0.63 J	< 13 U	0.4 J	< 10 U
cis-1,3-dichloropropene	0.4	< 13 U	< 13 U	< 13 U	< 10 U	< 10 U
Dibromochloromethane	50	< 13 U	< 13 U	< 13 U	< 10 U	< 10 U
Dichlorodifluoromethane (Freon 12)	5	< 13 U	< 13 U	< 13 U	< 10 U	< 10 U
Ethylbenzene	5	< 13 U	< 13 U	< 13 U	< 10 U	< 10 U
Methyl tert-Butyl Ether	5	< 13 U	< 13 U	< 13 U	< 10 U	< 10 U
Methylene Chloride	5	< 13 U	< 13 U	< 13 U	< 10 U	< 10 U
Styrene	5	< 13 U	< 13 U	< 13 U	< 10 U	< 10 U
Tetrachloroethene	5	1.2 J	1.3 J	1.1 J	1.1 J	1 J
Toluene	5	< 13 U	< 13 U	< 13 U	< 10 U	< 10 U
trans-1,2-dichloroethene	5	< 13 U	< 13 U	< 13 U	< 10 U	< 10 U
trans-1,3-dichloropropene	0.4	< 13 U	< 13 U	< 13 U	< 10 U	< 10 U
Trichloroethylene	5	< 13 U	1.1 J	0.85 J	0.9 J	0.76 J
Trichlorofluoromethane (CFC-11)	5	< 13 U	< 13 U	< 13 U	< 10 U	< 10 U
Trichlorotrifluoroethane (Freon 113)	5	< 13 U	< 13 U	< 13 U	< 10 U	< 10 U
Vinyl Chloride	2	< 5 U	< 5 U	< 5 U	< 4 U	< 4 U
Xylene-o	5	< 13 U	< 13 U	< 13 U	< 10 U	< 10 U
Xylenes - m,p	5	< 13 U	< 13 U	< 13 U	< 10 U	< 10 U
Total VOCs ⁽²⁾		432	394	363	253	232
Project VOCs ⁽³⁾		2.4	3.8	2.6	2.6	2.3

See notes on last page.

Table 9. Concentrations of Volatile Organic Compounds in Groundwater Samples Collected from Remedial Wells, Groundwater Interim Remedial Measure, Operable Unit 3 (Former Grumman Settling Ponds), Bethpage, New York. ⁽¹⁾

Notes:

- (1) Water samples collected by ARCADIS on the dates shown and submitted to Columbia Analytical Services, Inc. for VOC analysis using NYSDEC ASP 2000 Method OLM4.3. Results validated following protocols specified in Sampling and Analysis Plan in the December 2009 DRAFT OM&M Manual (ARCADIS 2009).
- (2) "Total VOCs" represents the sum of individual concentrations of the VOCs detected.
- (3) "Project VOCs" represents the sum of individual compound concentrations of 1,1,1-Trichloroethane; 1,1-Dichloroethane; 1,2-Dichloroethane; 1,1-Dichloroethene; Tetrachloroethene; Trichloroethene; Vinyl Chloride; cis-1,2-Dichloroethene; trans-1,2-Dichloroethene; Benzene; Toluene; and Xylenes-o,m, and p.

Acronyms\Key:

	Indicates an exceedance of an SCG.
700	Bold data indicates that the analyte was detected at or above its reporting limit.
ASP	Analytical services protocol.
B	Compound detected in associated blank sample.
D	Constituent identified from secondary dilution.
J	Value is estimated.
NE	Not established.
NYSDEC	New York State Department of Environmental Conservation.
R	Concentration for the constituent was rejected.
SCGs	Standards, criteria, and guidance values.
VOC	Volatile organic compound.
ug/L	Micrograms per liter.
< 5	Compound not detected above its laboratory quantification limit.
--	Not analyzed.

Table 10. Concentrations of Metals in Groundwater Samples Collected from Remedial Wells, Groundwater Interim Remedial Measure, Operable Unit 3 (Former Grumman Settling Ponds), Bethpage, New York. ⁽¹⁾

COMPOUND (ug/L)	Sample Location: Sample Date:	RW-1	RW-1	RW-1	RW-1	RW-1	RW-1	RW-1	RW-1	RW-1	RW-1	RW-1 ⁽²⁾
		4/21/2009	7/29/2009	8/12/2009	9/10/2009	11/10/2009	12/2/2009	10/4/2010	2/10/2011	10/3/2011	11/11/2011	10/1/2012
	NYSDEC SCGs											
Total Cadmium	5	< 5	--	--	--	--	--	< 5	--	--	< 5	< 5
Dissolved Cadmium	5	< 5	--	--	--	--	--	< 5	--	--	< 5	< 5
Total Chromium	50	24.3	--	--	--	--	--	27	--	--	23	23
Dissolved Chromium	50	20.2	--	--	--	--	--	27	--	--	24	23
Total Iron	300	< 100	< 100	< 100	< 100	< 100	< 100	< 100	< 100	< 100	--	< 100
Dissolved Iron	300	< 100	--	--	--	--	--	< 100	< 100	< 100	--	< 100
Total Manganese	300	23.6	--	--	--	--	--	12	--	--	--	--
Dissolved Manganese	300	22.4	--	--	--	--	--	11	--	--	--	--
Total Mercury	0.7	< 0.2	--	--	--	--	--	--	--	--	--	--
Dissolved Mercury	0.7	< 0.2	--	--	--	--	--	--	--	--	--	--

See notes on last page.

Table 10. Concentrations of Metals in Groundwater Samples Collected from Remedial Wells, Groundwater Interim Remedial Measure, Operable Unit 3 (Former Grumman Settling Ponds), Bethpage, New York. ⁽¹⁾

COMPOUND (ug/L)	Sample Location: Sample Date:	RW-2 4/21/2009	RW-2 7/29/2009	RW-2 8/12/2009	RW-2 9/10/2009	RW-2 10/9/2009	RW-2 11/10/2009	RW-2 12/2/2009	RW-2 1/11/2010	RW-2 2/2/2010
	NYSDEC <u>SCGs</u>									
Total Cadmium	5	< 5	--	--	--	--	--	--	--	--
Dissolved Cadmium	5	< 5	--	--	--	--	--	--	--	--
Total Chromium	50	< 10	--	--	--	--	--	--	--	--
Dissolved Chromium	50	< 10	--	--	--	--	--	--	--	--
Total Iron	300	2,330	5,950	4,870	3,550	3,800	2,040	1,260	1,140	1,000
Dissolved Iron	300	781	--	--	--	--	--	--	--	--
Total Manganese	300	241	--	--	--	--	--	--	--	--
Dissolved Manganese	300	248	--	--	--	--	--	--	--	--
Total Mercury	0.7	< 0.2	--	--	--	--	--	--	--	--
Dissolved Mercury	0.7	< 0.2	--	--	--	--	--	--	--	--

See notes on last page.

Table 10. Concentrations of Metals in Groundwater Samples Collected from Remedial Wells, Groundwater Interim Remedial Measure, Operable Unit 3 (Former Grumman Settling Ponds), Bethpage, New York. ⁽¹⁾

COMPOUND (ug/L)	Sample Location: Sample Date:	RW-2 3/10/2010	RW-2 4/12/2010	RW-2 7/20/2010	RW-2 10/4/2010	RW-2 12/6/2010	RW-2 2/10/2011	RW-2 2/10/2011	RW-2 4/8/2011	RW-2 5/2/2011
	NYSDEC <u>SCGs</u>									
Total Cadmium	5	--	--	--	< 5	--	--	--	--	--
Dissolved Cadmium	5	--	--	--	< 5	--	--	--	--	--
Total Chromium	50	--	--	--	< 10	--	--	--	--	--
Dissolved Chromium	50	--	--	--	< 10	--	--	--	--	--
Total Iron	300	2,550	880	1,180	710	590	970	970	1,000	890
Dissolved Iron	300	--	--	--	380	270	550	550	740	710
Total Manganese	300	--	--	--	187	--	--	--	--	--
Dissolved Manganese	300	--	--	--	192	--	--	--	--	--
Total Mercury	0.7	--	--	--	--	--	--	--	--	--
Dissolved Mercury	0.7	--	--	--	--	--	--	--	--	--

See notes on last page.

Table 10. Concentrations of Metals in Groundwater Samples Collected from Remedial Wells, Groundwater Interim Remedial Measure, Operable Unit 3 (Former Grumman Settling Ponds), Bethpage, New York. ⁽¹⁾

COMPOUND (ug/L)	Sample Location: Sample Date:	RW-2 6/8/2011	RW-2 7/8/2011	RW-2 8/1/2011	RW-2 9/6/2011	RW-2 10/3/2011	RW-2 11/11/2011	RW-2 12/19/2011	RW-2 1/9/2012	RW-2 2/6/2012	RW-2 3/8/2012
	NYSDEC <u>SCGs</u>										
Total Cadmium	5	--	--	--	--	--	< 5	--	--	--	--
Dissolved Cadmium	5	--	--	--	--	--	< 5	--	--	--	--
Total Chromium	50	--	--	--	--	--	< 10	--	--	--	--
Dissolved Chromium	50	--	--	--	--	--	< 10	--	--	--	--
Total Iron	300	830	3,110	840	830	1,640	750	930	870	960	990
Dissolved Iron	300	670	670	670	650	640	540	750	700	640	640
Total Manganese	300	--	--	--	--	--	--	--	--	--	--
Dissolved Manganese	300	--	--	--	--	--	--	--	--	--	--
Total Mercury	0.7	--	--	--	--	--	--	--	--	--	--
Dissolved Mercury	0.7	--	--	--	--	--	--	--	--	--	--

See notes on last page.

Table 10. Concentrations of Metals in Groundwater Samples Collected from Remedial Wells, Groundwater Interim Remedial Measure, Operable Unit 3 (Former Grumman Settling Ponds), Bethpage, New York. ⁽¹⁾

COMPOUND (ug/L)	Sample Location: Sample Date:	RW-2	RW-2	RW-2	RW-2	RW-2	RW-2	RW-2	RW-2	RW-2
		4/3/2012	5/7/2012	6/5/2012	7/2/2012	8/7/2012	9/4/2012	10/1/2012	11/12/2012	12/3/2012
	NYSDEC SCGs									
Total Cadmium	5	--	< 5	--	--	--	--	< 5	--	--
Dissolved Cadmium	5	--	< 5	--	--	--	--	< 5	--	--
Total Chromium	50	--	< 10	--	--	--	--	< 10	--	--
Dissolved Chromium	50	--	< 10	--	--	--	--	< 10	--	--
Total Iron	300	930	970	800	940	1,850	950	1,020	750	670
Dissolved Iron	300	830	730	690	840	780	810	780	610	540
Total Manganese	300	--	--	--	--	--	--	--	--	--
Dissolved Manganese	300	--	--	--	--	--	--	--	--	--
Total Mercury	0.7	--	--	--	--	--	--	--	--	--
Dissolved Mercury	0.7	--	--	--	--	--	--	--	--	--

See notes on last page.

Table 10. Concentrations of Metals in Groundwater Samples Collected from Remedial Wells, Groundwater Interim Remedial Measure, Operable Unit 3 (Former Grumman Settling Ponds), Bethpage, New York. ⁽¹⁾

COMPOUND (ug/L)	Sample Location: Sample Date:	RW-3 4/22/2009	RW-3 7/29/2009	RW-3 9/10/2009	RW-3 11/10/2009	RW-3 12/2/2009	RW-3 3/10/2010	RW-3 4/12/2010	RW-3 7/20/2010	RW-3 10/4/2010
	NYSDEC SCGs									
Total Cadmium	5	< 5	--	--	--	--	--	--	--	< 5
Dissolved Cadmium	5	< 5	--	--	--	--	--	--	--	< 5
Total Chromium	50	22.6	--	--	--	--	--	--	--	< 10
Dissolved Chromium	50	< 10	--	--	--	--	--	--	--	< 10
Total Iron	300	246	< 100	< 100	< 100	< 100	200	470	890	350
Dissolved Iron	300	< 100	--	--	--	--	--	--	--	< 100
Total Manganese	300	< 10	--	--	--	--	--	--	--	35
Dissolved Manganese	300	< 10	--	--	--	--	--	--	--	34
Total Mercury	0.7	< 0.2	--	--	--	--	--	--	--	--
Dissolved Mercury	0.7	< 0.2	--	--	--	--	--	--	--	--

See notes on last page.

Table 10. Concentrations of Metals in Groundwater Samples Collected from Remedial Wells, Groundwater Interim Remedial Measure, Operable Unit 3 (Former Grumman Settling Ponds), Bethpage, New York. ⁽¹⁾

COMPOUND (ug/L)	Sample Location: Sample Date:	RW-3 12/6/2010	RW-3 3/7/2011	RW-3 4/8/2011	RW-3 5/2/2011	RW-3 6/8/2011	RW-3 7/8/2011	RW-3 8/1/2011	RW-3 9/6/2011	RW-3 10/3/2011
	NYSDEC SCGs									
Total Cadmium	5	--	--	--	--	--	--	--	--	--
Dissolved Cadmium	5	--	--	--	--	--	--	--	--	--
Total Chromium	50	--	--	--	--	--	--	--	--	--
Dissolved Chromium	50	--	--	--	--	--	--	--	--	--
Total Iron	300	340	530	480	480	570	450	450	370	460
Dissolved Iron	300	150	200	200	130	140	120	120	< 100	110
Total Manganese	300	--	--	--	--	--	--	--	--	--
Dissolved Manganese	300	--	--	--	--	--	--	--	--	--
Total Mercury	0.7	--	--	--	--	--	--	--	--	--
Dissolved Mercury	0.7	--	--	--	--	--	--	--	--	--

See notes on last page.

Table 10. Concentrations of Metals in Groundwater Samples Collected from Remedial Wells, Groundwater Interim Remedial Measure, Operable Unit 3 (Former Grumman Settling Ponds), Bethpage, New York. ⁽¹⁾

COMPOUND (ug/L)	Sample Location: Sample Date:	RW-3 11/11/2011	RW-3 12/19/2011	RW-3 1/9/2012	RW-3 2/6/2012	RW-3 3/8/2012	RW-3 4/3/2012	RW-3 5/7/2012	RW-3 6/5/2012	RW-3 7/2/2012
NYSDEC SCGs										
Total Cadmium	5	< 5	--	--	--	--	--	< 5	--	--
Dissolved Cadmium	5	< 5	--	--	--	--	--	< 5	--	--
Total Chromium	50	< 10	--	--	--	--	--	< 10	--	--
Dissolved Chromium	50	< 10	--	--	--	--	--	< 10	--	--
Total Iron	300	460	280	500	410	980	310	400	140	250
Dissolved Iron	300	< 100	200	110	100	130	110	< 100	120	110
Total Manganese	300	--	--	--	--	--	--	--	--	--
Dissolved Manganese	300	--	--	--	--	--	--	--	--	--
Total Mercury	0.7	--	--	--	--	--	--	--	--	--
Dissolved Mercury	0.7	--	--	--	--	--	--	--	--	--

See notes on last page.

Table 10. Concentrations of Metals in Groundwater Samples Collected from Remedial Wells, Groundwater Interim Remedial Measure, Operable Unit 3 (Former Grumman Settling Ponds), Bethpage, New York. ⁽¹⁾

COMPOUND (ug/L)	Sample Location:	RW-3	RW-3	RW-3	RW-3	RW-3
	Sample Date:	8/7/2012	9/4/2012	10/1/2012	11/12/2012	12/3/2012
	NYSDEC <u>SCGs</u>					
Total Cadmium	5	--	--	< 5	--	--
Dissolved Cadmium	5	--	--	< 5	--	--
Total Chromium	50	--	--	< 10	--	--
Dissolved Chromium	50	--	--	< 10	--	--
Total Iron	300	310	140	280	220	210
Dissolved Iron	300	120	< 100	< 100	100	< 100
Total Manganese	300	--	--	--	--	--
Dissolved Manganese	300	--	--	--	--	--
Total Mercury	0.7	--	--	--	--	--
Dissolved Mercury	0.7	--	--	--	--	--

See notes on last page.

Table 10. Concentrations of Metals in Groundwater Samples Collected from Remedial Wells, Groundwater Interim Remedial Measure, Operable Unit 3 (Former Grumman Settling Ponds), Bethpage, New York. ⁽¹⁾

COMPOUND (ug/L)	Sample Location: Sample Date:	RW-4 4/22/2009	RW-4 7/29/2009	RW-4 8/12/2009	RW-4 9/10/2009	RW-4 11/10/2009	RW-4 12/2/2009	RW-4 10/4/2010	RW-4 10/3/2011	RW-4 11/11/2011	RW-4 ⁽²⁾ 10/1/2012
NYSDEC SCGs											
Total Cadmium	5	< 5	--	--	--	--	--	< 5	--	< 5	< 5
Dissolved Cadmium	5	< 5	--	--	--	--	--	< 5	--	< 5	< 5
Total Chromium	50	< 10	--	--	--	--	--	< 10	--	< 10	< 10
Dissolved Chromium	50	< 10	--	--	--	--	--	< 10	--	< 10	< 10
Total Iron	300	< 100	< 100	< 100	< 100	< 100	< 100	< 100	< 100	< 100	< 100
Dissolved Iron	300	< 100	--	--	--	--	--	< 100	< 100	< 100	< 100
Total Manganese	300	10.4	--	--	--	--	--	28	--	--	--
Dissolved Manganese	300	< 10	--	--	--	--	--	29	--	--	--
Total Mercury	0.7	< 0.2	--	--	--	--	--	--	--	--	--
Dissolved Mercury	0.7	< 0.2	--	--	--	--	--	--	--	--	--

Notes:

- (1) Water samples collected by ARCADIS on the dates shown and submitted to Columbia Analytical Services, Inc. for metals analysis using USEPA Method 6010 and for mercury analyses using USEPA Method 7470.. Results validated following protocols specified in Sampling and Analysis Plan in the December 2009 DRAFT OM&M Manual (ARCADIS 2009).
- (2) Beginning January 2012 metals analyses for recovery wells RW-1 and RW-4 are included with annual recovery well sampling performed in October of each year.

Acronyms/Key:

- Indicates an exceedance of an SCG.
- 700** Bold data indicates that the analyte was detected at or above its reporting limit.
- NYSDEC New York State Department of Environmental Conservation.
- ASP Analytical services protocol.
- SCGs Standards, criteria, and guidance values.
- ug/L Micrograms per liter.
- Not analyzed.
- < 5 Compound not detected above its laboratory quantification limit.



Table 11. Summary of Water-Level Elevations, Groundwater Interim Remedial Measure, Operable Unit 3 (Former Grumman Settling Ponds), Bethpage, New York.

Well Identification	Well Casing Elevation (ft msl)	Event Date	Baseline (1) 5/8/2009 (ft msl)	1Q2010 02/04/10 (ft msl)	2Q2010 04/23/10 (ft msl)	3Q2010 08/26/10 (ft msl)	4Q2010 12/10/10 (ft msl)	1Q2011 02/04/11 (ft msl)	2Q2011 05/20/11 (ft msl)	3Q2011 08/09/11 (ft msl)	4Q2011 10/26/11 (ft msl)	1Q2012 01/25/12 (ft msl)	2Q2012 05/02/12 (ft msl)	3Q2012 08/17/12 (ft msl)	4Q2012 10/05/12 (ft msl)
Recovery Wells															
RW-1	125.18		69.75	70.67	74.38	72.52	71.11	70.96	72.13	70.44	72.72	73.15	72.12	71.71	71.21
RW-2	124.48		72.27	61.80	64.88	63.44	61.35	67.99	66.31	64.18	65.11	69.05	69.81	65.3	63.7
RW-3	122.84		69.40	67.64	71.4	69.44*	68.13	67.74	68.88	67.64	69.70	70.75	71.74	74.35 ⁽²⁾	68.06
RW-4	121.25		69.25	70.35	74.02	71.93	70.56	67.06	71.37	69.95	72.13	72.71	71.61	70.88	70.67
Monitoring Wells															
B24MW-2	126.96		74.31	74.13	76.16	75.86	75.65	74.96	76.06	74.35	76.00	76.28	75.57	75.76	74.63
B24MW-3	127.11		72.63	72.16	75.87	74.10	72.89	72.40	74.04	72.27	74.44	74.63	73.67	73.62	72.69
B30MW-1	128.33		73.55	73.00	76.54	74.96	73.86	73.38	74.75	73.25	75.41	75.54	74.66	NM	73.66
BCPMW-1	125.73		73.16	72.67	76.26	74.66	73.43	72.94	74.75	72.94	75.05	75.23	74.29	74.22	73.27
BCPMW-2	126.39		72.55	71.83	75.52	73.69	72.55	72.03	73.64	71.94	74.16	74.33	73.29	73.17	72.39
BCPMW-3	124.94		72.46	71.59	75.24	73.40	72.27	71.74	73.25	71.64	73.94	74.05	73.06	72.85	72.14
BCPMW-4-1	128.76		72.30	71.33	75.05	73.13	72.02	71.56	73.08	71.46	73.70	73.78	72.81	72.59	71.89
BCPMW-4-2	129.15		72.58	71.36	75.07	73.16	72.08	71.56	73.06	71.51	73.74	73.83	72.83	72.61	71.92
BCPMW-4-3	129.19		72.32	71.46	75.16	73.26	72.14	71.73	73.19	71.55	73.84	73.96	72.94	72.71	71.97
BCPMW-5-1	129.37		72.79	72.14	75.66	73.94	72.72	72.74	73.81	72.14	74.46	74.77	73.67	73.34	72.62
BCPMW-6-1	126.01		72.12	71.26	74.91	72.96	71.91	71.49	72.77	71.45	73.58	73.67	72.66	72.32	71.73
BCPMW-6-2	125.16		71.74	70.96	74.64	72.60	71.59	71.17	72.49	71.01	73.26	73.37	72.30	71.97	71.39
BCPMW-7-1	124.81		72.00	71.33	74.99	72.99	71.97	71.51	72.78	71.53	73.62	73.71	72.71	72.31	71.77
MW-200-1	123.49		72.16	71.37	75.07	73.14	72.08	71.72	72.98	71.52	73.69	73.83	72.76	72.59	71.91
MW-201-1	121.69		72.04	71.10	74.84	72.87	71.79	71.33	72.69	71.25	73.48	73.55	72.53	72.28	71.65
MW-202-1	119.27		71.90	71.13	74.83	72.82	71.77	71.32	72.66	71.21	73.46	73.57	73.51	72.23	71.6
MW-203-1	118.25		71.83	71.10	74.75	72.77	71.75	71.30	72.61	70.20	73.43	73.52	72.49	72.13	71.56
Piezometers															
PZ-1a	128.82		72.56	71.15	74.87	72.94	71.85	71.33	72.76	71.31	73.54	73.62	72.63	72.42	71.72
PZ-1b	128.92		72.47	71.09	74.78	72.88	71.82	71.28	72.70	71.24	73.47	73.55	72.56	72.36	71.64
PZ-1c	128.96		72.47	71.48	75.15	73.23	72.13	71.74	73.16	71.56	73.83	73.9	72.90	72.68	71.94
PZ-2a	128.36		72.47	71.09	74.82	72.87	71.81	71.34	72.74	71.30	73.45	73.57	72.57	72.32	71.64
PZ-2b	128.37		72.43	71.08	74.77	72.86	71.78	71.30	72.68	71.27	73.45	73.55	72.54	72.28	71.61
PZ-2c	128.55		72.41	71.40	75.05	73.15	72.05	71.68	73.05	71.52	73.74	73.87	72.82	72.55	71.88
PZ-3	124.99		72.52	70.94	74.69	72.71	71.65	70.93	72.55	71.08	73.28	73.4	72.35	72.16	71.44
PZ-4	125.31		72.50	71.07	74.81	72.83	71.78	71.45	72.64	71.32	73.42	73.52	72.54	72.32	71.63
PZ-5a	129.07		72.50	71.94	75.61	73.79	72.59	72.17	73.70	71.98	74.27	74.39	73.40	73.25	72.45
PZ-5b	129.06		72.50	71.84	75.53	73.69	72.51	72.08	73.67	71.88	74.16	74.29	73.29	73.15	72.35
PZ-6a	125.67		72.50	71.03	74.73	72.84	71.70	71.24	72.56	71.24	73.37	73.46	72.43	72.13	71.5
PZ-6b	125.74		72.50	70.93	74.7	72.65	71.58	71.11	72.46	71.14	73.28	73.37	72.34	72.05	71.43
PZ-7a	125.10		72.50	71.32	75.02	73.00	72.00	71.54	72.80	71.58	73.67	73.7	72.72	72.36	71.78
PZ-7b	125.06		72.50	71.21	74.85	72.83	71.83	71.37	72.68	71.26	73.45	73.53	72.51	72.13	71.54

Notes and Abbreviations:

(1) Baseline readings were taken prior to system start-up, which occurred on July 21, 2009.

(2) Measurement collected is believed to be anomalous

*: RW-3 water level measurement collected on September 9, 2010.

ft msl: feet relative to mean sea level

NM: not measured



Table 12. Summary of Calculated Vertical Groundwater Hydraulic Gradients, Groundwater Interim Remedial Measure, Operable Unit 3 (Former Grumman Settling Ponds), Bethpage, New York.

Observation Well Pairing			1/25/2012			5/2/2012			8/17/2012			10/5/2012		
Shallow	Deep	Vertical Distance Between Screens (ft)	Observed Head		Vertical Hydraulic Gradient (1) (ft/ft)	Observed Head		Vertical Hydraulic Gradient (1) (ft/ft)	Observed Head		Vertical Hydraulic Gradient (1) (ft/ft)	Observed Head		Vertical Hydraulic Gradient (1) (ft/ft)
			Shallow (ft msl)	Deep (ft msl)		Shallow (ft msl)	Deep (ft msl)		Shallow (ft msl)	Deep (ft msl)		Shallow (ft msl)	Deep (ft msl)	
PZ-1A	PZ-1B	20	73.62	73.55	-0.0035	72.63	72.56	-0.0035	72.42	72.36	-0.003	71.72	71.64	-0.004
PZ-1B	PZ-1C	50	73.55	73.90	0.007	72.56	72.90	0.0068	72.36	72.68	0.0064	71.64	71.94	0.006
PZ-2A	PZ-2B	20	73.57	73.55	-0.001	72.57	72.54	-0.0015	72.32	72.28	-0.002	71.64	71.61	-0.0015
PZ-2B	PZ-2C	50	73.55	73.87	0.0064	72.54	72.82	0.0056	72.28	72.55	0.0054	71.61	71.88	0.0054
PZ-5A	PZ-5B	45	74.39	74.29	-0.0022	73.40	73.29	-0.0024	73.25	73.15	-0.0022	72.45	72.35	-0.0022
PZ-6A	PZ-6B	25	73.46	73.37	-0.0036	72.43	72.34	-0.0036	72.13	72.05	-0.0032	71.5	71.43	-0.0028
PZ-7A	PZ-7B	48	73.70	73.53	-0.0035	72.72	72.51	-0.0044	72.36	72.13	-0.0048	71.78	71.54	-0.005
BCPMW-4-1	BCPMW-4-2	21	73.78	73.83	0.0024	72.81	72.83	0.001	72.59	72.61	0.001	71.89	71.92	0.0014
BCPMW-4-2	BCPMW-4-3	44	73.83	73.96	0.003	72.83	72.94	0.0025	72.61	72.71	0.0023	71.92	71.97	0.0011
BCPMW-6-1	BCPMW-6-2	44.5	73.67	73.37	-0.0072	72.66	72.30	-0.0067	72.32	71.97	-0.0081	71.73	71.39	-0.0079

Notes:

1. Positive groundwater hydraulic gradient indicates a vertically upward gradient and a negative groundwater hydraulic gradient indicates vertically downward gradient.

Table 13. Concentrations of Volatile Organic Compounds in Groundwater Samples Collected from Monitoring Wells, Groundwater Interim Remedial Measure, Operable Unit 3 (Former Grumman Settling Ponds), Bethpage, New York. ^(1,2,3)

COMPOUND (ug/L)	Sample Location: B24MW-2 B24MW-2 B24MW-2 B24MW-2 B24MW-3 B24MW-3 B24MW-3							
	Sample Date: 4/23/2009 10/4/2010 10/27/2011 10/3/2012 4/20/2009 10/6/2010 10/27/2011							
	NYSDEC SCGs							
1,1,1-Trichloroethane	5	< 5	< 5	< 5	< 5	0.62 J	< 5	< 5
1,1,2,2-Tetrachloroethane	5	< 5	< 5	< 5	< 5	< 5	< 5	< 5
1,1,2-Trichloroethane	1	< 5	< 5	< 5	< 5	< 5	< 5	< 5
1,1-Dichloroethane	5	< 5	< 5	< 5	< 5	< 5	< 5	< 5
1,1-Dichloroethene	5	< 5	< 5	< 5	< 5	< 5	< 5	< 5
1,2-Dichloroethane	0.6	< 5	< 5	< 5	< 5	< 5	< 5	< 5
1,2-Dichloropropane	1	< 5	< 5	< 5	< 5	< 5	< 5	< 5
2-Butanone	NE	< 50	< 50	< 50	< 50	< 50	< 50	< 50
2-Hexanone	50	< 50	< 50	< 50	< 50	< 50 J	< 50	< 50
4-methyl-2-pentanone	50	< 50	< 50	< 50	< 50	< 50 J	< 50	< 50
Acetone	NE	< 50 B	< 50	< 50 B	< 50	< 50	< 50	< 50
Benzene	1	< 0.7	< 0.7	< 0.7	< 0.7	< 0.7	< 0.7	< 0.7
Bromodichloromethane	50	< 5	< 5	< 5	< 5	< 5	< 5	< 5
Bromoform	50	< 5	< 5	< 5	< 5	< 5	< 5	< 5
Bromomethane	5	< 5	< 5	< 5	< 5	< 5	< 5	< 5
Carbon Disulfide	60	< 5	< 5	< 5	< 5	< 5	< 5	< 5
Carbon tetrachloride	5	< 5	< 5	< 5	< 5	< 5	< 5	< 5
Chlorobenzene	5	< 5	< 5	< 5	< 5	< 5	< 5	< 5
Chlorodifluoromethane (Freon 22)	NE	< 5	< 5	< 5	0.41 J	< 5	< 5	< 5
Chloroethane	5	< 5	< 5	< 5	< 5	< 5	< 5	< 5
Chloroform	7	< 5	0.3 J	< 5	1.3 J	< 5	< 5	0.32 J
Chloromethane	5	< 5	< 5	< 5	< 5	< 5	< 5	< 5
cis-1,2-dichloroethene	5	< 5	< 5	< 5	1.9 J	10	1.2 J	0.4 J
cis-1,3-dichloropropene	0.4	< 5	< 5	< 5	< 5	< 5	< 5	< 5
Dibromochloromethane	50	< 5	< 5	< 5	< 5	< 5	< 5	< 5
Dichlorodifluoromethane (Freon 12)	5	< 5	< 5	< 5	< 5	< 5	< 5	< 5
Ethylbenzene	5	< 5	< 5	< 5	< 5	< 5	< 5	< 5
Methyl tert-Butyl Ether	5	--	< 5	--	0.45 J	--	< 5	--
Methylene Chloride	5	< 5	< 5	< 5	< 5	< 5	< 5	< 5
Styrene	5	< 5	< 5	< 5	< 5	< 5	< 5	< 5
Tetrachloroethene	5	< 5	< 5	< 5	< 5	0.51 J	< 5	< 5
Toluene	5	< 5	< 5	< 5	< 5	< 5	< 5	< 5
trans-1,2-dichloroethene	5	< 5	< 5	< 5	< 5	< 5	< 5	< 5
trans-1,3-dichloropropene	0.4	< 5	< 5	< 5	< 5	< 5	< 5	< 5
Trichloroethene	5	3.7 J	4.4 J	3.2 J	25	45	5.9	1.4 J
Trichlorotrifluoroethane (Freon 113)	5	< 5	< 5	< 5	< 5	< 5	< 5	< 5
Vinyl Chloride	2	< 2	< 2	< 2	< 2	< 2	< 2	< 2
Xylene-o	5	< 5	< 5	< 5	< 5	< 5	< 5	< 5
Xylenes - m,p	5	< 5	< 5	< 5	< 5	< 5	< 5	< 5
Total VOCs ⁽⁴⁾		3.7	4.7	3.2	29	56	7.1	2.1
Project VOCs ⁽⁵⁾		3.7	4.4	3.2	27	56	7.1	1.8

See notes on last page.

Table 13. Concentrations of Volatile Organic Compounds in Groundwater Samples Collected from Monitoring Wells, Groundwater Interim Remedial Measure, Operable Unit 3 (Former Grumman Settling Ponds), Bethpage, New York. ^(1,2,3)

COMPOUND (ug/L)	Sample Location: Sample Date:	B24MW-3 10/4/2012	B30MW-1 4/23/2009	B30MW-1 10/4/2010	B30MW-1 10/27/2011	B30MW-1 10/3/2012	BCPMW-1 4/28/2009
	NYSDEC SCGs						
1,1,1-Trichloroethane	5	< 5	< 5	< 5	< 5	< 5	< 5
1,1,2,2-Tetrachloroethane	5	< 5	< 5	< 5	< 5	< 5	< 5
1,1,2-Trichloroethane	1	< 5	< 5	< 5	< 5	< 5	< 5
1,1-Dichloroethane	5	< 5	< 5	< 5	< 5	< 5	0.37 J
1,1-Dichloroethene	5	< 5	< 5	< 5	< 5	< 5	< 5
1,2-Dichloroethane	0.6	< 5	< 5	< 5	< 5	< 5	< 5
1,2-Dichloropropane	1	< 5	< 5	< 5	< 5	< 5	< 5
2-Butanone	NE	< 50	< 50	< 50	< 50	< 50	< 50
2-Hexanone	50	< 50	< 50	< 50	< 50	< 50	< 50
4-methyl-2-pentanone	50	< 50	< 50	< 50	< 50	< 50	< 50
Acetone	NE	< 50	< 50 B	< 50 B	< 50	< 50	< 50 B
Benzene	1	< 0.7	< 0.7	< 0.7	< 0.7	< 0.7	< 0.7
Bromodichloromethane	50	< 5	< 5	< 5	< 5	< 5	< 5
Bromoform	50	< 5	< 5	< 5	< 5	< 5	< 5
Bromomethane	5	< 5	< 5	< 5	< 5	< 5	< 5
Carbon Disulfide	60	< 5	< 5	< 5	< 5	< 5	< 5
Carbon tetrachloride	5	< 5	< 5	< 5	< 5	< 5	< 5
Chlorobenzene	5	< 5	< 5	< 5	< 5	< 5	< 5
Chlorodifluoromethane (Freon 22)	NE	< 5	< 5	< 5	< 5	< 5	< 5
Chloroethane	5	< 5	< 5	< 5	< 5	< 5	< 5
Chloroform	7	0.38 J	< 5	< 5	< 5	< 5	0.88 J
Chloromethane	5	< 5	< 5	< 5	< 5	< 5	< 5
cis-1,2-dichloroethene	5	0.62 J	< 5	< 5	< 5	< 5	22
cis-1,3-dichloropropene	0.4	< 5	< 5	< 5	< 5	< 5	< 5
Dibromochloromethane	50	< 5	< 5	< 5	< 5	< 5	< 5
Dichlorodifluoromethane (Freon 12)	5	< 5	< 5	< 5	< 5	< 5	< 5
Ethylbenzene	5	< 5	< 5	< 5	< 5	< 5	< 5
Methyl tert-Butyl Ether	5	< 5	--	< 5	--	< 5	--
Methylene Chloride	5	< 5	< 5	< 5	< 5	< 5	0.52 J
Styrene	5	< 5	< 5	< 5	< 5	< 5	< 5
Tetrachloroethene	5	< 5	< 5	< 5	< 5	< 5	< 5
Toluene	5	< 5	< 5	< 5	< 5	< 5	0.33 J
trans-1,2-dichloroethene	5	< 5	< 5	< 5	< 5	< 5	0.44 J
trans-1,3-dichloropropene	0.4	< 5	< 5	< 5	< 5	< 5	< 5
Trichloroethene	5	1 J	< 5	< 5	< 5	< 5	190
Trichlorotrifluoroethane (Freon 113)	5	< 5	< 5	< 5	< 5	< 5	< 5
Vinyl Chloride	2	< 2	< 2	< 2	< 2	< 2	< 2
Xylene-o	5	< 5	< 5	< 5	< 5	< 5	< 5
Xylenes - m,p	5	< 5	< 5	< 5	< 5	< 5	< 5
Total VOCs ⁽⁴⁾		2.0	0	0	0	0	220
Project VOCs ⁽⁵⁾		1.6	0	0	0	0	210

See notes on last page.

Table 13. Concentrations of Volatile Organic Compounds in Groundwater Samples Collected from Monitoring Wells, Groundwater Interim Remedial Measure, Operable Unit 3 (Former Grumman Settling Ponds), Bethpage, New York. ^(1,2,3)

COMPOUND (ug/L)	Sample Location: BCPMW-2		BCPMW-3	BCPMW-4-1	BCPMW-4-1	BCPMW-4-1	BCPMW-4-1
	Sample Date: 4/28/2009		4/29/2009	4/17/2009	12/1/2009	10/4/2010	10/28/2011
	NYSDEC SCGs						
1,1,1-Trichloroethane	5	< 10	< 25	< 25	2.4 J	14 J	10 J
1,1,2,2-Tetrachloroethane	5	< 10	< 25	< 25	< 5	< 25	< 25
1,1,2-Trichloroethane	1	< 10	< 25	< 25	0.38 J	< 25	< 25
1,1-Dichloroethane	5	8 J	9.6 J	6.5 J	46	38	18 J
1,1-Dichloroethene	5	3.8 J	43	1.8 J	14	21 J	13 J
1,2-Dichloroethane	0.6	0.68 J	< 25	< 25	0.65 J	< 25	2.1 J
1,2-Dichloropropane	1	< 10	< 25	< 25	4.7 J	3.8 J	1.9 J
2-Butanone	NE	< 100	< 250	< 250	< 50	< 250	< 250
2-Hexanone	50	< 100	< 250	< 250 J	< 50	< 250	< 250
4-methyl-2-pentanone	50	< 100	< 250	< 250 J	< 50	< 250	< 250
Acetone	NE	< 100	< 250	< 250 J	< 50	< 250	< 250B
Benzene	1	< 1.4	< 3.5	< 3.5	0.44 J	< 3.5	< 3.5
Bromodichloromethane	50	< 10	< 25	< 25	< 5	< 25	< 25
Bromoform	50	< 10	< 25	< 25	< 5	< 25	< 25
Bromomethane	5	< 10	< 25	< 25	R	< 25	< 25
Carbon Disulfide	60	< 10	< 25	< 25	< 5	< 25	< 25
Carbon tetrachloride	5	< 10	< 25	< 25	< 5	< 25	< 25
Chlorobenzene	5	< 10	< 25	< 25	< 5	< 25	< 25
Chlorodifluoromethane (Freon 22)	NE	< 10	< 25	17 J	6.2	4.3 J	2.5 J
Chloroethane	5	< 10	< 25	< 25	2.4 J	4.1 J	< 25
Chloroform	7	< 10	< 25	< 25	< 5	< 25	< 25
Chloromethane	5	< 10	< 25	< 25	R	< 25	< 25
cis-1,2-dichloroethene	5	310	900	1800 D	750 D	510	500
cis-1,3-dichloropropene	0.4	< 10	< 25	< 25	< 5	< 25	< 25
Dibromochloromethane	50	< 10	< 25	< 25	< 5	< 25	< 25
Dichlorodifluoromethane (Freon 12)	5	< 10	< 25	< 25	< 5	< 25	< 25
Ethylbenzene	5	< 10	< 25 B	< 25	< 5	< 25	< 25
Methyl tert-Butyl Ether	5	--	--	--	--	< 25	< 25
Methylene Chloride	5	< 10	< 25	< 25	< 5	< 25	< 25 B
Styrene	5	< 10	< 25	< 25	< 5	< 25	< 25
Tetrachloroethene	5	1.5 J	< 25	< 25	0.64 J	< 25	< 25
Toluene	5	< 10	< 25 B	< 25	< 5	< 25	< 25
trans-1,2-dichloroethene	5	2.4 J	8.9 J	110	2.5 J	3.9 J	1.3 J
trans-1,3-dichloropropene	0.4	< 10	< 25	< 25	< 5	< 25	< 25
Trichloroethene	5	180	470	22 J	170	45	43
Trichlorotrifluoroethane (Freon 113)	5	< 10	< 25	< 25	< 5	< 25	< 25
Vinyl Chloride	2	4.1	300	180	540 D	220	32
Xylene-o	5	< 10	< 25 B	< 25	8	< 25	< 25
Xylenes - m,p	5	< 10	< 25 B	< 25	< 5	< 25	< 25
Total VOCs ⁽⁴⁾		510	1,700	2,100	1,500	860	620
Project VOCs ⁽⁵⁾		510	1,700	2,100	1,500	850	620

See notes on last page.

Table 13. Concentrations of Volatile Organic Compounds in Groundwater Samples Collected from Monitoring Wells, Groundwater Interim Remedial Measure, Operable Unit 3 (Former Grumman Settling Ponds), Bethpage, New York. ^(1,2,3)

COMPOUND (ug/L)	Sample Location: <i>BCPMW-4-1</i> Sample Date: <i>10/3/2012</i>	<i>BCPMW-4-2</i> 4/17/2009	<i>BCPMW-4-2</i> 12/4/2009	<i>BCPMW-4-2</i> 10/7/2010	<i>BCPMW-4-2</i> 10/28/2011	<i>BCPMW-4-2</i> 10/3/2012
NYSDEC SCGs						
1,1,1-Trichloroethane	5	29	< 250	< 10	< 5	0.33 J 0.23 J
1,1,2,2-Tetrachloroethane	5	< 25	< 250	< 10	< 5	< 5
1,1,2-Trichloroethane	1	1.7 J	< 250	< 10	< 5	< 5
1,1-Dichloroethane	5	39	57 J	8.7 J	7.3	2.6 J 1.4 J
1,1-Dichloroethene	5	24 J	34 J	2.7 J	1.9 J	1.1 J 0.8 J
1,2-Dichloroethane	0.6	4.8 J	< 250	< 10	0.91 J 0.85 J	0.45 J
1,2-Dichloropropane	1	5.1 J	< 250	< 10	0.9 J 0.39 J	< 5
2-Butanone	NE	< 250	< 2500	< 100	< 50	< 50
2-Hexanone	50	< 250	< 2500 J	< 100	< 50	< 50
4-methyl-2-pentanone	50	< 250	< 2500 J	< 100	< 50	< 50
Acetone	NE	< 250	< 2500 J	< 100	< 50 B	< 50
Benzene	1	< 3.5	< 35	< 1.4	< 0.7	< 0.7 U < 0.7
Bromodichloromethane	50	< 25	< 250	< 10	< 5	< 5
Bromoform	50	< 25	< 250	< 10	< 5	< 5
Bromomethane	5	< 25	< 250	< 10	< 5	< 5
Carbon Disulfide	60	< 25	< 250	< 10	< 5	< 5
Carbon tetrachloride	5	< 25	< 250	< 10	< 5	< 5
Chlorobenzene	5	< 25	< 250	< 10	< 5	< 5
Chlorodifluoromethane (Freon 22)	NE	< 25	< 250	0.8 J	< 5	< 5
Chloroethane	5	1.6 J	< 250	1.1 J	0.79 J	< 5
Chloroform	7	< 25	< 250	< 10	0.96 J 0.62 J	0.54 J
Chloromethane	5	< 25	< 250	R	< 5	< 5
cis-1,2-dichloroethene	5	840	18000 D	270	99	59 70
cis-1,3-dichloropropene	0.4	< 25	< 250	< 10	< 5	< 5
Dibromochloromethane	50	< 25	< 250	< 10	< 5	< 5
Dichlorodifluoromethane (Freon 12)	5	< 25	< 250	< 10	< 5	< 5
Ethylbenzene	5	< 25	62 J	0.78 J	< 5	< 5
Methyl tert-Butyl Ether	5	< 25	--	--	0.35 J 0.28 J	0.29 J
Methylene Chloride	5	< 25	< 250	< 10	< 5	< 5
Styrene	5	< 25	< 250	< 10	< 5	< 5
Tetrachloroethene	5	< 25	< 250	0.82 J	0.73 J 0.59 J	0.91 J
Toluene	5	< 25	2400	< 10 B	< 5	< 5
trans-1,2-dichloroethene	5	2.2 J	< 250	1.3 J	0.65 J 0.41 J	0.5 J
trans-1,3-dichloropropene	0.4	< 25	< 250	< 10	< 5	< 5
Trichloroethene	5	110	< 250	310	66 50	68
Trichlorotrifluoroethane (Freon 113)	5	< 25	< 250	< 10	< 5	< 5
Vinyl Chloride	2	420	6300	58	54 20	9.5
Xylene-o	5	< 25	110 J	< 10 B	< 5	< 5
Xylenes - m,p	5	< 25	190 J	< 10 B	< 5	< 5
Total VOCs ⁽⁴⁾		1,500	27,000	660	230 140	150
Project VOCs ⁽⁵⁾		1,500	27,000	650	230 130	150

See notes on last page.

Table 13. Concentrations of Volatile Organic Compounds in Groundwater Samples Collected from Monitoring Wells, Groundwater Interim Remedial Measure, Operable Unit 3 (Former Grumman Settling Ponds), Bethpage, New York. ^(1,2,3)

COMPOUND (ug/L)	Sample Location: Sample Date:	BCPMW-4-3 4/17/2009	BCPMW-4-3 12/1/2009	BCPMW-4-3 10/7/2010	BCPMW-4-3 10/28/2011	BCPMW-4-3 10/3/2012	BCPMW-5-1 4/23/2009
	NYSDEC SCGs						
1,1,1-Trichloroethane	5	< 5	< 5	< 5	< 5	< 5	< 100
1,1,2,2-Tetrachloroethane	5	< 5	< 5	< 5	< 5	< 5	< 100
1,1,2-Trichloroethane	1	< 5	< 5	< 5	< 5	< 5	< 100
1,1-Dichloroethane	5	< 5	< 5	< 5	< 5	< 5	< 100
1,1-Dichloroethene	5	< 5	< 5	< 5	< 5	< 5	21 J
1,2-Dichloroethane	0.6	< 5	< 5	< 5	< 5	< 5	< 100
1,2-Dichloropropane	1	< 5	< 5	< 5	< 5	< 5	< 100
2-Butanone	NE	< 50	< 50	< 50	< 50	< 50	< 1000
2-Hexanone	50	< 50 J	< 50	< 50	< 50	< 50	< 1000
4-methyl-2-pentanone	50	< 50 J	< 50	< 50	< 50	< 50	< 1000
Acetone	NE	< 50 J	< 50	< 50	< 50	< 50	< 1000
Benzene	1	< 0.7	< 0.7	< 0.7	< 0.7	< 0.7	< 14
Bromodichloromethane	50	< 5	< 5	< 5	< 5	< 5	< 100
Bromoform	50	< 5	< 5	< 5	< 5	< 5	< 100
Bromomethane	5	< 5	< 5	< 5	< 5	< 5	< 100
Carbon Disulfide	60	< 5	< 5	< 5	< 5	< 5	< 100
Carbon tetrachloride	5	< 5	< 5	< 5	< 5	< 5	< 100
Chlorobenzene	5	< 5	< 5	< 5	< 5	< 5	< 100
Chlorodifluoromethane (Freon 22)	NE	< 5	< 5	< 5	< 5	< 5	< 100
Chloroethane	5	< 5	< 5	< 5	< 5	< 5	< 100
Chloroform	7	0.53 J	0.32 J	< 5	< 5	0.2 J	< 100
Chloromethane	5	< 5	R	< 5	< 5	< 5	< 100
cis-1,2-dichloroethene	5	0.37 J	< 5	< 5	< 5	< 5	960
cis-1,3-dichloropropene	0.4	< 5	< 5	< 5	< 5	< 5	< 100
Dibromochloromethane	50	< 5	< 5	< 5	< 5	< 5	< 100
Dichlorodifluoromethane (Freon 12)	5	< 5	< 5	< 5	< 5	< 5	< 100
Ethylbenzene	5	< 5	< 5	< 5	< 5	< 5	48 J
Methyl tert-Butyl Ether	5	--	--	< 5	< 5	< 5	--
Methylene Chloride	5	< 5	< 5	< 5	< 5	< 5	< 100
Styrene	5	< 5	< 5	< 5	< 5	< 5	< 100
Tetrachloroethene	5	< 5	< 5	< 5	0.27 J	0.3 J	< 100
Toluene	5	< 5	< 5	< 5	< 5	< 5	2700
trans-1,2-dichloroethene	5	< 5	< 5	< 5	< 5	< 5	< 100
trans-1,3-dichloropropene	0.4	< 5	< 5	< 5	< 5	< 5	< 100
Trichloroethene	5	0.56 J	0.51 J	0.41 J	0.74 J	0.84 J	220
Trichlorotrifluoroethane (Freon 113)	5	< 5	< 5	< 5	0.38 J	< 5	< 100
Vinyl Chloride	2	< 2	< 2	< 2	< 2	< 2	330
Xylene-o	5	< 5	< 5	< 5	< 5	< 5	40 J
Xylenes - m,p	5	< 5	< 5	< 5	< 5	< 5	110
Total VOCs ⁽⁴⁾		1.5	0.83	0.41	1.4	1.3	4,400
Project VOCs ⁽⁵⁾		0.93	0.51	0.41	1.0	1.1	4,400

See notes on last page.

Table 13. Concentrations of Volatile Organic Compounds in Groundwater Samples Collected from Monitoring Wells, Groundwater Interim Remedial Measure, Operable Unit 3 (Former Grumman Settling Ponds), Bethpage, New York. ^(1,2,3)

COMPOUND (ug/L)	Sample Location: BCPMW-6-1					
	Sample Date: 4/20/2009	12/4/2009	10/6/2010	10/31/2011	BCPMW-6-1 10/3/2012	
	NYSDEC SCGs					
1,1,1-Trichloroethane	5	< 5	< 5	< 100	< 250	< 100
1,1,2,2-Tetrachloroethane	5	< 5	< 5	< 100	< 250	< 100
1,1,2-Trichloroethane	1	< 5	< 5	< 100	< 250	< 100
1,1-Dichloroethane	5	0.3 J	< 5	< 100	< 250	< 100
1,1-Dichloroethene	5	< 5	< 5	< 100	< 250	< 100
1,2-Dichloroethane	0.6	< 5	< 5	< 100	< 250	< 100
1,2-Dichloropropane	1	< 5	< 5	< 100	< 250	< 100
2-Butanone	NE	< 50	< 50	< 1000	< 2500	< 1000
2-Hexanone	50	< 50 J	< 50	< 1000	< 2500	< 1000
4-methyl-2-pentanone	50	< 50 J	< 50	< 1000	< 2500	< 1000
Acetone	NE	< 50 J	< 50	< 1000	< 2500	< 1000
Benzene	1	< 0.7	< 0.7	< 14	< 35	< 14
Bromodichloromethane	50	< 5	< 5	< 100	< 250	< 100
Bromoform	50	< 5	< 5	< 100	< 250	< 100
Bromomethane	5	< 5	R	< 100	< 250	< 100
Carbon Disulfide	60	< 5	< 5	< 100	< 250	< 100
Carbon tetrachloride	5	< 5	< 5	< 100	< 250	< 100
Chlorobenzene	5	< 5	< 5	< 100	< 250	< 100
Chlorodifluoromethane (Freon 22)	NE	4500 D	1700 EJ	10000 D	7100	2100
Chloroethane	5	< 5	< 5	< 100	< 250	< 100
Chloroform	7	1.7 J	0.32 J	< 100	< 250	< 100
Chloromethane	5	< 5	R	< 100	< 250	< 100
cis-1,2-dichloroethene	5	21	1.7 J	< 100	< 250	< 100
cis-1,3-dichloropropene	0.4	< 5	< 5	< 100	< 250	< 100
Dibromochloromethane	50	< 5	< 5	< 100	< 250	< 100
Dichlorodifluoromethane (Freon 12)	5	< 5	< 5	< 100	< 250	< 100
Ethylbenzene	5	< 5	< 5	< 100	< 250	< 100
Methyl tert-Butyl Ether	5	--	--	< 100	< 250	< 100
Methylene Chloride	5	< 5	< 5	< 100	< 250	< 100
Styrene	5	< 5	< 5	< 100	< 250	< 100
Tetrachloroethene	5	0.34 J	< 5	< 100	< 250	< 100
Toluene	5	< 5	< 5	< 100	< 250	< 100
trans-1,2-dichloroethene	5	< 5	< 5	< 100	< 250	< 100
trans-1,3-dichloropropene	0.4	< 5	< 5	< 100	< 250	< 100
Trichloroethene	5	4.9 J	1.6 J	< 100	< 250	< 100
Trichlorotrifluoroethane (Freon 113)	5	< 5	< 5	< 100	< 250	< 100
Vinyl Chloride	2	< 2	< 2	< 40	< 100	< 40
Xylene-o	5	< 5	< 5	< 100	< 250	< 100
Xylenes - m,p	5	< 5	< 5	< 100	< 250	< 100
Total VOCs ⁽⁴⁾		4,500	1,700	10,000	7,100	2,100
Project VOCs ⁽⁵⁾		27	2.3	0	0	0

See notes on last page.

Table 13. Concentrations of Volatile Organic Compounds in Groundwater Samples Collected from Monitoring Wells, Groundwater Interim Remedial Measure, Operable Unit 3 (Former Grumman Settling Ponds), Bethpage, New York. ^(1,2,3)

COMPOUND (ug/L)	Sample Location: BCPMW-6-2					
	Sample Date:	5/8/2009	12/4/2009	10/6/2010	10/31/2011	BCPMW-6-2 10/3/2012
	NYSDEC SCGs					
1,1,1-Trichloroethane	5	< 5	0.78 J	< 5	< 5	< 5
1,1,2,2-Tetrachloroethane	5	< 5	< 5	< 5	< 5	< 5
1,1,2-Trichloroethane	1	< 5	< 5	< 5	< 5	< 5
1,1-Dichloroethane	5	0.37 J	0.65 J	0.47 J	0.41 J	0.23 J
1,1-Dichloroethene	5	< 5	0.44 J	< 5	0.3 J	< 5
1,2-Dichloroethane	0.6	< 5	< 5	< 5	< 5	< 5
1,2-Dichloropropane	1	< 5	< 5	< 5	< 5	< 5
2-Butanone	NE	< 50	< 50	< 50	< 50	< 50
2-Hexanone	50	< 50	< 50	< 50	< 50	< 50
4-methyl-2-pentanone	50	< 50	< 50	< 50	< 50	< 50
Acetone	NE	< 50	< 50	< 50	< 50	< 50
Benzene	1	< 0.7	< 0.7	< 0.7	< 0.7	< 0.7
Bromodichloromethane	50	< 5	< 5	< 5	< 5	< 5
Bromoform	50	< 5	< 5	< 5	< 5	< 5
Bromomethane	5	< 5	R	< 5	< 5	< 5
Carbon Disulfide	60	< 5	< 5	< 5	< 5	< 5
Carbon tetrachloride	5	< 5	< 5	< 5	< 5	< 5
Chlorobenzene	5	< 5	< 5	< 5	< 5	< 5
Chlorodifluoromethane (Freon 22)	NE	< 5	< 5	< 5	< 5	0.64 J
Chloroethane	5	< 5	< 5	< 5	< 5	< 5
Chloroform	7	0.53 J	< 5	0.41 J	0.3 J	0.38 J
Chloromethane	5	< 5	R	< 5	< 5	< 5
cis-1,2-dichloroethene	5	< 5	< 5	< 5	< 5	< 5
cis-1,3-dichloropropene	0.4	< 5	< 5	< 5	< 5	< 5
Dibromochloromethane	50	< 5	< 5	< 5	< 5	< 5
Dichlorodifluoromethane (Freon 12)	5	< 5	< 5	< 5	< 5	< 5
Ethylbenzene	5	< 5	< 5	< 5	< 5	< 5
Methyl tert-Butyl Ether	5	--	--	< 5	0.33 J	0.24 J
Methylene Chloride	5	< 5	< 5	< 5	< 5	< 5
Styrene	5	< 5	< 5	< 5	< 5	< 5
Tetrachloroethene	5	< 5	0.79 J	2.1 J	1.8 J	1.6 J
Toluene	5	< 5	< 5	< 5	< 5	< 5
trans-1,2-dichloroethene	5	< 5	< 5	< 5	< 5	< 5
trans-1,3-dichloropropene	0.4	< 5	< 5	< 5	< 5	< 5
Trichloroethene	5	< 5	0.45 J	< 5	< 5	< 5
Trichlorotrifluoroethane (Freon 113)	5	< 5	< 5	< 5	< 5	< 5
Vinyl Chloride	2	< 2	< 2	< 2	< 2	< 2
Xylene-o	5	< 5	< 5	< 5	< 5	< 5
Xylenes - m,p	5	< 5	< 5	< 5	< 5	< 5
Total VOCs ⁽⁴⁾		0.90	3.1	3.0	3.1	3.1
Project VOCs ⁽⁵⁾		0.37	3.1	2.6	2.5	1.8

See notes on last page.

Table 13. Concentrations of Volatile Organic Compounds in Groundwater Samples Collected from Monitoring Wells, Groundwater Interim Remedial Measure, Operable Unit 3 (Former Grumman Settling Ponds), Bethpage, New York. ^(1,2,3)

COMPOUND (ug/L)	Sample Location:	BCPMW-7-1	BCPMW-7-1	BCPMW-7-1	BCPMW-7-1	BCPMW-7-1	MW-200-1
	Sample Date:	4/20/2009	12/1/2009	10/7/2010	11/1/2011	10/4/2012	4/29/2009
	NYSDEC						
	SCGs						
1,1,1-Trichloroethane	5	< 5	< 5	< 5	< 5	< 5	< 5
1,1,2,2-Tetrachloroethane	5	< 5	< 5	< 5	< 5	< 5	< 5
1,1,2-Trichloroethane	1	< 5	< 5	< 5	< 5	< 5	< 5
1,1-Dichloroethane	5	< 5	< 5	< 5	< 5	< 5	0.79 J
1,1-Dichloroethene	5	< 5	< 5	< 5	< 5	< 5	< 5
1,2-Dichloroethane	0.6	< 5	< 5	< 5	< 5	< 5	< 5
1,2-Dichloropropane	1	< 5	< 5	< 5	< 5	< 5	< 5
2-Butanone	NE	< 50	< 50	< 50	< 50	< 50	< 50
2-Hexanone	50	< 50 J	< 50	< 50	< 50	< 50	< 50
4-methyl-2-pentanone	50	< 50 J	< 50	< 50	< 50	< 50	< 50
Acetone	NE	< 50	< 50	< 50	< 50	< 50	< 50 B
Benzene	1	< 0.7	< 0.7	< 0.7	< 0.7	< 0.7	< 0.7
Bromodichloromethane	50	< 5	< 5	< 5	< 5	< 5	< 5
Bromoform	50	< 5	< 5	< 5	< 5	< 5	< 5
Bromomethane	5	< 5	R	< 5	< 5	< 5	< 5
Carbon Disulfide	60	< 5	< 5	< 5	< 5	< 5	< 5
Carbon tetrachloride	5	< 5	< 5	< 5	< 5	< 5	< 5
Chlorobenzene	5	< 5	< 5	< 5	< 5	< 5	< 5
Chlorodifluoromethane (Freon 22)	NE	2.6 J	1.5 J	5.2	9.2	3.6 J	< 5
Chloroethane	5	< 5	< 5	< 5	< 5	< 5	< 5
Chloroform	7	< 5	< 5	< 5	< 5	0.37 J	2.3 J
Chloromethane	5	< 5	R	< 5	< 5	< 5	< 5
cis-1,2-dichloroethene	5	< 5	< 5	< 5	< 5	< 5	38
cis-1,3-dichloropropene	0.4	< 5	< 5	< 5	< 5	< 5	< 5
Dibromochloromethane	50	< 5	< 5	< 5	< 5	< 5	< 5
Dichlorodifluoromethane (Freon 12)	5	< 5	< 5	< 5	< 5	< 5	< 5
Ethylbenzene	5	< 5	< 5	< 5	< 5	< 5	< 5
Methyl tert-Butyl Ether	5	--	--	< 5	0.22 J	0.26 J	--
Methylene Chloride	5	< 5	< 5	< 5	< 5	< 5	< 5
Styrene	5	< 5	< 5	< 5	< 5	< 5	< 5
Tetrachloroethene	5	< 5	< 5	< 5	< 5	< 5	0.54 J
Toluene	5	< 5	< 5	< 5	< 5	< 5	< 5
trans-1,2-dichloroethene	5	< 5	< 5	< 5	< 5	< 5	0.3 J
trans-1,3-dichloropropene	0.4	< 5	< 5	< 5	< 5	< 5	< 5
Trichloroethene	5	< 5	< 5	< 5	< 5	< 5	34
Trichlorotrifluoroethane (Freon 113)	5	< 5	< 5	< 5	< 5	< 5	< 5
Vinyl Chloride	2	< 2	< 2	< 2	< 2	< 2	< 2
Xylene-o	5	< 5	< 5	< 5	< 5	< 5	< 5
Xylenes - m,p	5	< 5	< 5	< 5	< 5	< 5	< 5
Total VOCs ⁽⁴⁾		2.6	1.5	5.2	9.4	4.2	76
Project VOCs ⁽⁵⁾		0.0	0.0	0.0	0.22	0.0	74

See notes on last page.

Table 13. Concentrations of Volatile Organic Compounds in Groundwater Samples Collected from Monitoring Wells, Groundwater Interim Remedial Measure, Operable Unit 3 (Former Grumman Settling Ponds), Bethpage, New York. ^(1,2,3)

COMPOUND (ug/L)	Sample Location: MW-200-1 MW-200-1 MW-200-1 MW-200-1 MW-201-1 MW-201-1 MW-201-1							
	Sample Date: 12/2/2009 10/5/2010 11/3/2011 10/4/2012 5/1/2009 12/2/2009 10/5/2010							
	NYSDEC SCGs							
1,1,1-Trichloroethane	5	< 5	< 5	< 5	< 5	5.5 J	3.3 J	< 50
1,1,2,2-Tetrachloroethane	5	< 5	< 5	< 5	< 5	< 25	< 50	< 50
1,1,2-Trichloroethane	1	< 5	< 5	< 5	< 5	< 25	< 50	< 50
1,1-Dichloroethane	5	< 5	< 5	< 5	< 5	10 J	9 J	14 J
1,1-Dichloroethene	5	< 5	< 5	< 5	< 5	7.9 J	8.1 J	6.9 J
1,2-Dichloroethane	0.6	< 5	< 5	< 5	< 5	< 25	< 50	< 50
1,2-Dichloropropane	1	< 5	< 5	< 5	< 5	< 25	< 50	< 50
2-Butanone	NE	< 50	< 50	< 50	< 50	< 250	< 500	< 500
2-Hexanone	50	< 50	< 50	< 50	< 50	< 250	< 500	< 500
4-methyl-2-pentanone	50	< 50	< 50	< 50	< 50	< 250	< 500	< 500
Acetone	NE	< 50	< 50	< 50	< 50	< 250 B	< 500	< 500
Benzene	1	< 0.7	< 0.7	< 0.7	< 0.7	< 3.5	< 7	< 7
Bromodichloromethane	50	< 5	< 5	< 5	< 5	< 25	< 50	< 50
Bromoform	50	< 5	< 5	< 5	< 5	< 25	< 50	< 50
Bromomethane	5	R	< 5	< 5	< 5	< 25	< 50	< 50
Carbon Disulfide	60	< 5	< 5	< 5	< 5	< 25	< 50	< 50
Carbon tetrachloride	5	< 5	< 5	< 5	< 5	< 25	< 50	< 50
Chlorobenzene	5	< 5	< 5	< 5	< 5	< 25	< 50	< 50
Chlorodifluoromethane (Freon 22)	NE	< 5	< 5	< 5	< 5	< 25	< 50	< 50
Chloroethane	5	< 5	< 5	< 5	< 5	< 25	< 50	< 50
Chloroform	7	2.3 J	0.5 J	0.21 J	< 5	< 25	< 50	4.2 J
Chloromethane	5	R	< 5	< 5	< 5	< 25	R	< 50
cis-1,2-dichloroethene	5	5.7	3.5 J	11	1.5 J	970 D	1300	3900 D
cis-1,3-dichloropropene	0.4	< 5	< 5	< 5	< 5	< 25	< 50	< 50
Dibromochloromethane	50	< 5	< 5	< 5	< 5	< 25	< 50	< 50
Dichlorodifluoromethane (Freon 12)	5	< 5	< 5	< 5	< 5	< 25	< 50	< 50
Ethylbenzene	5	< 5	< 5	< 5	< 5	< 25	< 50	< 50
Methyl tert-Butyl Ether	5	--	< 5	< 5	< 5	--	--	< 50
Methylene Chloride	5	< 5	< 5	< 5	< 5	< 25	< 50	< 50
Styrene	5	< 5	< 5	< 5	< 5	< 25	< 50	< 50
Tetrachloroethene	5	< 5	< 5	0.43 J	< 5	< 25	< 50	< 50
Toluene	5	< 5	< 5	< 5	< 5	< 25	< 50	< 50
trans-1,2-dichloroethene	5	< 5	< 5	< 5	< 5	2.7 J	3.5 J	6.7 J
trans-1,3-dichloropropene	0.4	< 5	< 5	< 5	< 5	< 25	< 50	< 50
Trichloroethene	5	12	7	20	3.8 J	160	230	72
Trichlorotrifluoroethane (Freon 113)	5	< 5	< 5	< 5	< 5	< 25	< 50	< 50 U
Vinyl Chloride	2	< 2	< 2	< 2	< 2	< 10	38	820
Xylene-o	5	< 5	< 5	< 5	< 5	< 25	< 50	7.2 J
Xylenes - m,p	5	< 5	< 5	< 5	< 5	< 25	< 50	< 50
Total VOCs ⁽⁴⁾		20	11	32	5.3	1,200	1,600	4,800
Project VOCs ⁽⁵⁾		18	11	31	5.3	1,200	1,600	4,800

See notes on last page.

Table 13. Concentrations of Volatile Organic Compounds in Groundwater Samples Collected from Monitoring Wells, Groundwater Interim Remedial Measure, Operable Unit 3 (Former Grumman Settling Ponds), Bethpage, New York. ^(1,2,3)

COMPOUND (ug/L)	Sample Location: MW-201-1		MW-201-1	MW-202-1	MW-202-1	MW-202-1	MW-202-1
	Sample Date:	11/3/2011	MW-201-1 10/4/2012	5/1/2009	12/2/2009	10/6/2010	11/3/2011
	NYSDEC SCGs						
1,1,1-Trichloroethane	5	< 5	< 5	< 5	< 5	< 5	0.32 J
1,1,2,2-Tetrachloroethane	5	< 5	< 5	< 5	< 5	< 5	< 5
1,1,2-Trichloroethane	1	< 5	< 5	< 5	< 5	< 5	< 5
1,1-Dichloroethane	5	0.51 J	1.2 J	< 5	< 5	< 5	0.86 J
1,1-Dichloroethene	5	0.21 J	0.65 J	< 5	< 5	< 5	0.72 J
1,2-Dichloroethane	0.6	< 5	< 5	< 5	< 5	< 5	< 5
1,2-Dichloropropane	1	< 5	< 5	< 5	< 5	< 5	< 5
2-Butanone	NE	< 50	< 50	< 50	< 50	< 50	< 50
2-Hexanone	50	< 50	< 50	< 50	< 50	< 50	< 50
4-methyl-2-pentanone	50	< 50	< 50	< 50	< 50	< 50	< 50
Acetone	NE	< 50	< 50	< 50	< 50	< 50	< 50
Benzene	1	< 0.7	< 0.7	< 0.7	< 0.7	< 0.7	< 0.7
Bromodichloromethane	50	< 5	< 5	< 5	< 5	< 5	< 5
Bromoform	50	< 5	< 5	< 5	< 5	< 5	< 5
Bromomethane	5	< 5	< 5	< 5	< 5	< 5	< 5
Carbon Disulfide	60	< 5	< 5	< 5	< 5	< 5	< 5
Carbon tetrachloride	5	< 5	< 5	< 5	< 5	< 5	< 5
Chlorobenzene	5	< 5	< 5	< 5	< 5	< 5	< 5
Chlorodifluoromethane (Freon 22)	NE	< 5	< 5	< 5	< 5	0.61 J	0.21 J
Chloroethane	5	< 5	< 5	< 5	< 5	< 5	< 5
Chloroform	7	3.2 J	2.9 J	6.2	6.7	0.93 J	< 5
Chloromethane	5	< 5	< 5	< 5	< 5	< 5	< 5
cis-1,2-dichloroethene	5	61	180 D	0.64 J	0.58 J	< 5	< 5
cis-1,3-dichloropropene	0.4	< 5	< 5	< 5	< 5	< 5	< 5
Dibromochloromethane	50	< 5	< 5	< 5	< 5	< 5	< 5
Dichlorodifluoromethane (Freon 12)	5	< 5	< 5	< 5	< 5	< 5	< 5
Ethylbenzene	5	< 5	< 5	< 5	< 5	< 5	< 5
Methyl tert-Butyl Ether	5	0.75 J	0.22 J	--	--	< 5	0.37 J
Methylene Chloride	5	< 5	< 5	< 5	< 5	< 5	< 5
Styrene	5	< 5	< 5	< 5	< 5	< 5	< 5
Tetrachloroethene	5	0.24 J	0.24 J	< 5	< 5	0.48 J	0.92 J
Toluene	5	< 5 J	< 5	< 5	< 5	< 5	< 5
trans-1,2-dichloroethene	5	< 5	0.59 J	< 5	< 5	< 5	< 5
trans-1,3-dichloropropene	0.4	< 5	< 5	< 5	< 5	< 5	< 5
Trichloroethene	5	20	20	7.5	9.3	2.4 J	0.78 J
Trichlorotrifluoroethane (Freon 113)	5	< 5	< 5	< 5	< 5	0.43 J	0.44 J
Vinyl Chloride	2	< 2 U	13	< 2	< 2	< 2	< 2
Xylene-o	5	< 5	< 5	< 5	< 5	< 5	< 5
Xylenes - m,p	5	< 5	< 5	< 5	< 5	< 5	< 5
Total VOCs ⁽⁴⁾		86	220	14	17	4.9	4.6
Project VOCs ⁽⁵⁾		82	220	8.1	9.9	2.9	3.6

See notes on last page.

Table 13. Concentrations of Volatile Organic Compounds in Groundwater Samples Collected from Monitoring Wells, Groundwater Interim Remedial Measure, Operable Unit 3 (Former Grumman Settling Ponds), Bethpage, New York. ^(1,2,3)

COMPOUND (ug/L)	Sample Location:	MW-202-1	MW-203-1	MW-203-1	MW-203-1	MW-203-1	MW-203-1
	Sample Date:	10/4/2012	5/1/2009	12/2/2009	10/5/2010	11/1/2011	10/3/2012
	NYSDEC SCGs						
1,1,1-Trichloroethane	5	0.74 J	< 5	< 5	< 5	< 5	0.26 J
1,1,2,2-Tetrachloroethane	5	< 5	< 5	< 5	< 5	< 5	< 5
1,1,2-Trichloroethane	1	< 5	< 5	< 5	< 5	< 5	< 5
1,1-Dichloroethane	5	2.1 J	< 5	< 5	< 5	0.32 J	1 J
1,1-Dichloroethene	5	1.9 J	< 5	< 5	< 5	< 5	0.44 J
1,2-Dichloroethane	0.6	< 5	< 5	< 5	< 5	< 5	< 5
1,2-Dichloropropane	1	< 5	< 5	< 5	< 5	< 5	< 5
2-Butanone	NE	< 50	< 50	< 50	< 50	< 50	< 50
2-Hexanone	50	< 50	< 50	< 50	< 50	< 50	< 50
4-methyl-2-pentanone	50	< 50	< 50	< 50	< 50	< 50	< 50
Acetone	NE	< 50	< 50 B	< 50	< 50 B	< 50	< 50
Benzene	1	< 0.7	< 0.7	< 0.7	< 0.7	< 0.7	< 0.7
Bromodichloromethane	50	< 5	< 5	< 5	< 5	< 5	< 5
Bromoform	50	< 5	< 5	< 5	< 5	< 5	< 5
Bromomethane	5	< 5	< 5	< 5	< 5	< 5	< 5
Carbon Disulfide	60	< 5	< 5	< 5	< 5	< 5	< 5
Carbon tetrachloride	5	< 5	< 5	< 5	< 5	< 5	< 5
Chlorobenzene	5	< 5	< 5	< 5	< 5	< 5	< 5
Chlorodifluoromethane (Freon 22)	NE	< 5	73	17	29	8.9	3.6 J
Chloroethane	5	< 5	< 5	< 5	< 5	< 5	< 5
Chloroform	7	< 5	7.9	2.6 J	1.5 J	0.68 J	0.36 J
Chloromethane	5	< 5	< 5	< 5	< 5	< 5	< 5
cis-1,2-dichloroethene	5	0.4 J	1.6 J	0.83 J	0.97 J	1.4 J	0.62 J
cis-1,3-dichloropropene	0.4	< 5	< 5	< 5	< 5	< 5	< 5
Dibromochloromethane	50	< 5	< 5	< 5	< 5	< 5	< 5
Dichlorodifluoromethane (Freon 12)	5	< 5	< 5	< 5	< 5	< 5	< 5
Ethylbenzene	5	< 5	< 5	< 5	< 5	< 5	< 5
Methyl tert-Butyl Ether	5	< 5	--	--	0.88 J	0.41 J	0.21 J
Methylene Chloride	5	< 5	< 5	< 5	< 5	< 5	< 5
Styrene	5	< 5	< 5	< 5	< 5	< 5	< 5
Tetrachloroethene	5	1.7 J	< 5	< 5	< 5	0.35 J	0.59 J
Toluene	5	< 5	< 5	< 5	< 5	< 5	< 5
trans-1,2-dichloroethene	5	< 5	< 5	< 5	< 5	< 5	< 5
trans-1,3-dichloropropene	0.4	< 5	< 5	< 5	< 5	< 5	< 5
Trichloroethene	5	1.2 J	1.3 J	0.7 J	1.6 J	2.9 J	1.8 J
Trichlorotrifluoroethane (Freon 113)	5	0.76 J	< 5	< 5	< 5	< 5	1.1 J
Vinyl Chloride	2	< 2	< 2	< 2	< 2	< 2	< 2
Xylene-o	5	< 5	< 5	< 5	< 5	< 5	< 5
Xylenes - m,p	5	< 5	< 5	< 5	< 5	< 5	< 5
Total VOCs ⁽⁴⁾		8.8	84	21	34	15	10
Project VOCs ⁽⁵⁾		8.0	2.9	1.5	2.6	5	4.7

See notes on last page.

Table 13. Concentrations of Volatile Organic Compounds in Groundwater Samples Collected from Monitoring Wells, Groundwater Interim Remedial Measure, Operable Unit 3 (Former Grumman Settling Ponds), Bethpage, New York. ^(1,2,3)

Notes:

- (1) Results validated following protocols specified in Sampling and Analysis Plan in the December 2009 DRAFT OM&M Manual (ARCADIS 2009).
- (2) Samples analyzed for the TCL VOCs using NYSDEC ASP 2000 Method OLM4.2.
- (3) Sampling method changed from 3 well volume purge to HydraSleeve™ no purge method, see Section 6 of this report.
- (4) "Total VOCs" represents the sum of individual concentrations of the VOCs detected.
- (5) "Project VOCs" represents the sum of individual compound concentrations of 1,1,1-Trichloroethane; 1,1-Dichloroethane; 1,2-Dichloroethane; 1,1-Dichloroethene; Tetrachloroethene; Trichloroethene; Vinyl Chloride; cis-1,2-Dichloroethene; trans-1,2-Dichloroethene; Benzene; Toluene; and Xylenes-o,m, and p.

Acronyms\Key:

Indicates an exceedance of an SCG.

Bold value indicates a detection.

Concentration values are rounded to two significant figures.

Italicized samples collected with HydraSleeve™ no purge method.

RI/FS Remedial Investigation/Feasibility Study.

NYSDEC New York State Department of Environmental Conservation.

TCL Target compound list.

VOC Volatile Organic Compound.

ASP Analytical services protocol.

SCGs Standards, criteria, and guidance values.

ug/L Micrograms per liter.

NE Not established.

E Concentration for the constituent exceeded the calibration range.

J Value is estimated.

D Constituent identified from secondary dilution.

R Concentration for the constituent was rejected.

B Compound detected in associated blank sample.

< 5 Compound not detected above its laboratory quantification limit.

Table 14. Concentrations of Metals in Groundwater Samples Collected from Monitoring Wells, Groundwater Interim Remedial Measure, Operable Unit 3 (Former Grumman Settling Ponds), Bethpage, New York. ^(1,2)

COMPOUND (ug/L)	Sample Location: B24MW-2		B24MW-3	BCPMW-1	BCPMW-2	BCPMW-3	BCPMW-4-1	BCPMW-4-1	BCPMW-4-1	BCPMW-4-1	BCPMW-4-1
	Sample Date: 4/23/2009		4/20/2009	4/28/2009	4/28/2009	4/29/2009	4/17/2009	10/4/2010	10/28/2011	10/3/2012	10/4/2012
	NYSDEC SCGs										
Cadmium (total)	5	< 5	< 5	< 5	< 5	< 5	< 5	< 5	< 5	< 5	--
Cadmium (dissolved)	5	< 5	< 5	< 5	< 5	< 5	< 5	< 5	< 5	--	< 5
Chromium (total)	50	40.3	28.2	20.8	< 10	< 10	22.7	43	25	32	--
Chromium (dissolved)	50	< 10	10.6	< 10	< 10	< 10	12.8	41	22	--	26
Iron (total)	300	--	597	--	< 100	2,080	103	--	--	--	--
Iron (dissolved)	300	--	< 100	--	< 100	1,760	< 100	--	--	--	--
Manganese (total)	300	--	16.9	--	12.7	51.4	11.2	--	--	--	--
Manganese (dissolved)	300	--	13.7	--	11.3	49.2	< 10	--	--	--	--

See notes on last page.

Table 14. Concentrations of Metals in Groundwater Samples Collected from Monitoring Wells, Groundwater Interim Remedial Measure, Operable Unit 3 (Former Grumman Settling Ponds), Bethpage, New York. ^(1,2)

COMPOUND (ug/L)	Sample Location: BCPMW-4-2 BCPMW-4-2 BCPMW-4-2 BCPMW-4-2 BCPMW-4-2 BCPMW-4-3 BCPMW-4-3 BCPMW-4-3 BCPMW-4-3 BCPMW-4-3										
	Sample Date: 4/17/2009 10/7/2010 10/28/2011 10/3/2012 10/4/2012 4/17/2009 10/7/2010 10/28/2011 10/3/2012 10/4/2012										
	NYSDEC SCGs										
Cadmium (total)	5	< 5	< 5	< 5	< 5	--	< 5	< 5	< 5	< 5	--
Cadmium (dissolved)	5	< 5	--	< 5	--	< 5	< 5	< 5	< 5	--	< 5
Chromium (total)	50	10.6	< 10	< 10	< 10	--	< 10	< 10	< 10	< 10	--
Chromium (dissolved)	50	< 10	--	< 10	--	< 10	< 10	< 10	< 10	--	< 10
Iron (total)	300	4,630	--	--	--	--	< 100	--	--	--	--
Iron (dissolved)	300	4,080	--	--	--	--	< 100	--	--	--	--
Manganese (total)	300	228	--	--	--	--	< 10	--	--	--	--
Manganese (dissolved)	300	217	--	--	--	--	< 10	--	--	--	--

See notes on last page.

Table 14. Concentrations of Metals in Groundwater Samples Collected from Monitoring Wells, Groundwater Interim Remedial Measure, Operable Unit 3 (Former Grumman Settling Ponds), Bethpage, New York. ^(1,2)

COMPOUND (ug/L)	Sample Location: BCPMW-5-1		BCPMW-6-1	BCPMW-6-1	BCPMW-6-1	BCPMW-6-1	BCPMW-6-1	BCPMW-6-1	BCPMW-6-2	BCPMW-6-2	BCPMW-6-2	BCPMW-6-2	BCPMW-6-2
	Sample Date:	4/23/2009	4/20/2009	10/6/2010	10/31/2011	10/3/2012	10/4/2012		5/8/2009	10/6/2010	10/31/2011	10/3/2012	10/4/2012
	NYSDEC SCGs												
Cadmium (total)	5	< 5	< 5	<5	< 5	< 5	--		< 5	<5	<5	< 5	--
Cadmium (dissolved)	5	< 5	< 5	<5	< 5	--	< 5		< 5	<5	<5	< 5	< 5
Chromium (total)	50	< 10	< 10	< 10	14	< 10	--	10.3	<10	<10	<10	< 10	--
Chromium (dissolved)	50	< 10	< 10	<10	< 10	--	< 10		< 10	<10	<10	< 10	< 10
Iron (total)	300	7,420	< 100	--	--	--	--	--	--	--	--	--	--
Iron (dissolved)	300	6,370	< 100	--	--	--	--	--	--	--	--	--	--
Manganese (total)	300	145	< 10	--	--	--	--	--	--	--	--	--	--
Manganese (dissolved)	300	131	< 10	--	--	--	--	--	--	--	--	--	--

See notes on last page.

Table 14. Concentrations of Metals in Groundwater Samples Collected from Monitoring Wells, Groundwater Interim Remedial Measure, Operable Unit 3 (Former Grumman Settling Ponds), Bethpage, New York. ^(1,2)

COMPOUND (ug/L)	Sample Location: BCPMW-7-1 BCPMW-7-1 BCPMW-7-1 BCPMW-7-1 MW-200-1 MW-200-1 MW-200-1 MW-200-1 ⁽³⁾ MW-200-1 MW-201-1 MW-201-1											
	Sample Date: 4/20/2009 10/7/2010 11/1/2011 10/4/2012 4/29/2009 10/5/2010 11/3/2011 10/4/2012 4/15/2013 5/1/2009 10/5/2010											
	NYSDEC SCGs											
Cadmium (total)	5	< 5	< 5	< 5	< 5	< 5	< 5	< 5	< 5	--	< 5	< 5
Cadmium (dissolved)	5	< 5	< 5	< 5	< 5	< 5	< 5	< 5	< 5	--	< 5	< 5
Chromium (total)	50	< 10	< 10	< 10	< 10	< 10	14	48	1,130	86	< 10	< 10
Chromium (dissolved)	50	< 10	< 10	< 10	< 10	< 10	< 10	13	320	21	< 10	< 10
Iron (total)	300	< 100	--	--	--	--	--	--	--	--	--	--
Iron (dissolved)	300	< 100	--	--	--	--	--	--	--	--	--	--
Manganese (total)	300	106	--	--	--	--	--	--	--	--	--	--
Manganese (dissolved)	300	94.8	--	--	--	--	--	--	--	--	--	--

See notes on last page.



Table 14. Concentrations of Metals in Groundwater Samples Collected from Monitoring Wells, Groundwater Interim Remedial Measure, Operable Unit 3 (Former Grumman Settling Ponds), Bethpage, New York. ^(1,2)

COMPOUND (ug/L)	Sample Location:	MW-201-1	MW-201-1 ⁽³⁾	MW-201-1	MW-202-1	MW-202-1	MW-202-1	MW-202-1 ⁽³⁾	MW-202-1	MW-203-1	MW-203-1	MW-203-1	MW-203-1 ⁽³⁾
	Sample Date:	11/3/2011	10/4/2012	4/16/2013	5/1/2009	10/6/2010	11/3/2011	10/4/2012	4/16/2013	5/1/2009	10/5/2010	11/1/2011	10/3/2012
	NYSDEC SCGs												
Cadmium (total)	5	< 5	< 5	--	< 5	< 5	< 5	< 5	--	< 5	< 5	< 5	< 5
Cadmium (dissolved)	5	< 5	< 5	--	< 5	< 5	< 5	< 5	--	< 5	< 5	< 5	--
Chromium (total)	50	< 10	159	28	16.5	15	23	263 J	19	31.5	31	37	1,600
Chromium (dissolved)	50	< 10	42	17	< 10	< 10	< 10	22	< 10	< 10	< 10	< 10	--
Iron (total)	300	--	--	--	--	--	--	--	--	--	--	--	--
Iron (dissolved)	300	--	--	--	--	--	--	--	--	--	--	--	--
Manganese (total)	300	--	--	--	--	--	--	--	--	--	--	--	--
Manganese (dissolved)	300	--	--	--	--	--	--	--	--	--	--	--	--

See notes on last page.

Table 14. Concentrations of Metals in Groundwater Samples Collected from Monitoring Wells, Groundwater Interim Remedial Measure, Operable Unit 3 (Former Grumman Settling Ponds), Bethpage, New York. ^(1,2,3)

COMPOUND (ug/L)	Sample Location: MW-203-1		MW-203-1
	Sample Date: 10/4/2012		4/16/2013
	NYSDEC SCGs		
Cadmium (total)	5	--	--
Cadmium (dissolved)	5	< 5	--
Chromium (total)	50	--	155
Chromium (dissolved)	50	84	<10
Iron (total)	300	--	--
Iron (dissolved)	300	--	--
Manganese (total)	300	--	--
Manganese (dissolved)	300	--	--

Notes:

- (1) Results validated following protocols specified in Sampling and Analysis Plan in the December 2009 DRAFT OM&M Manual (ARCADIS 2009).
- (2) Samples analyzed for the metals using NYSDEC ASP Method 2000 ILM4.0.
- (3) Samples collected with HydraSleeve™ no purge method, all other samples collected by purge (3-Volume) method.

Acronyms/Key:

[Redacted] indicates an exceedance of an SCG.

Bold indicates a detection.

RI/FS Remedial Investigation/Feasibility Study.

NYSDEC New York State Department of Environmental Conservation.

ASP Analytical services protocol.

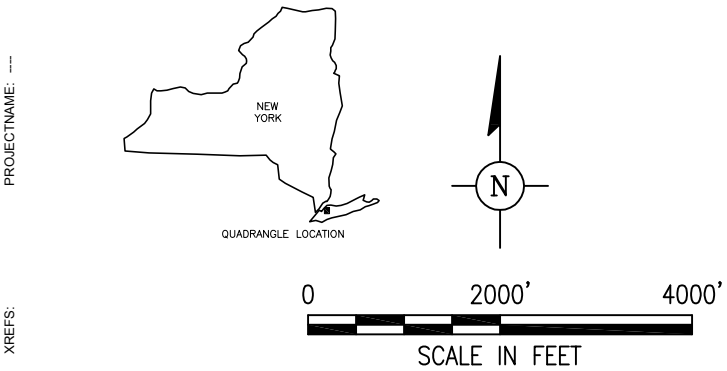
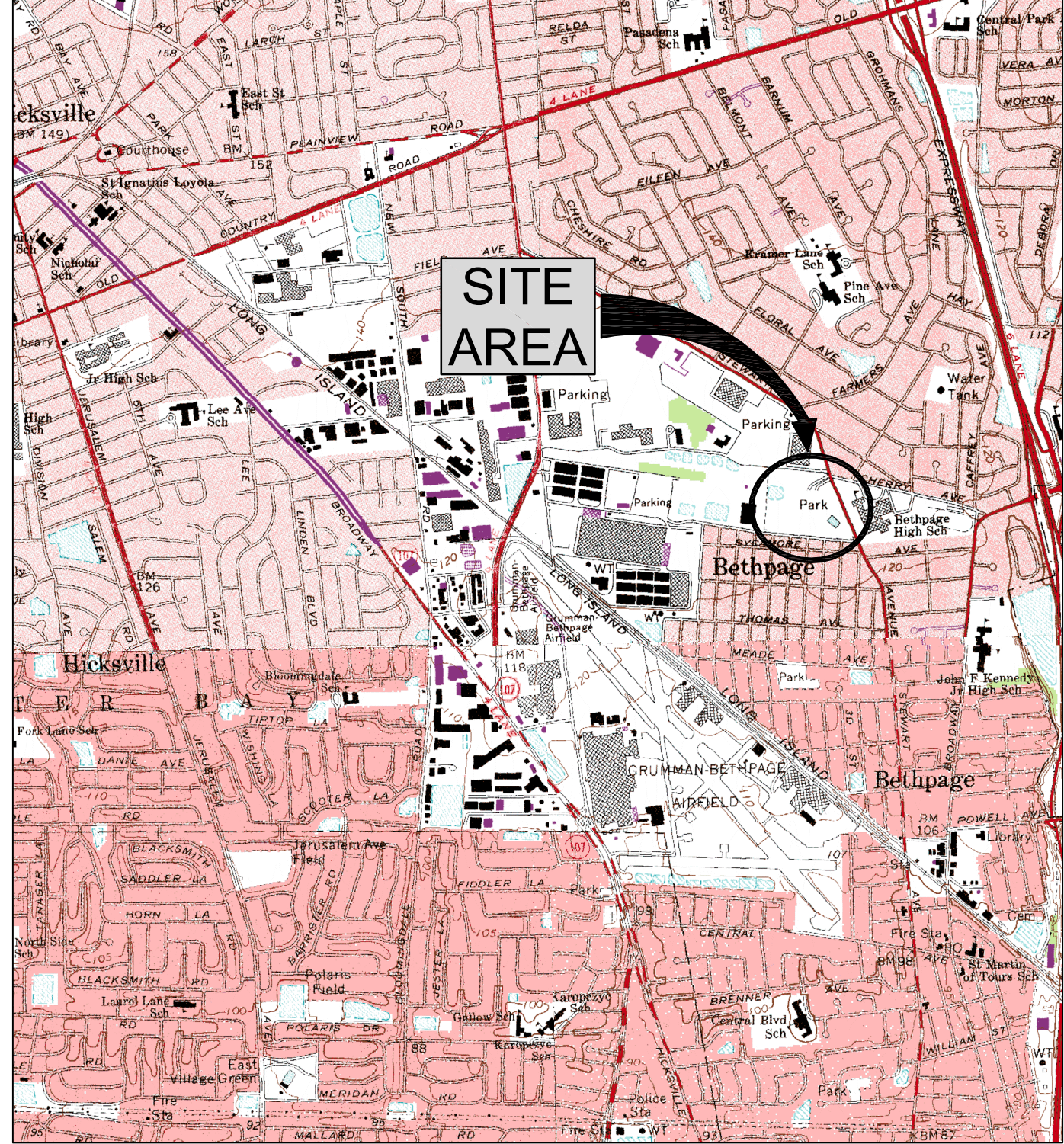
SCGs Standards, criteria, and guidance values.

ug/L Micrograms per liter.

-- Not analyzed.

< 5 Compound not detected above its laboratory quantification limit.

Figures



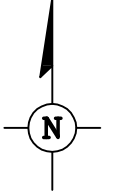
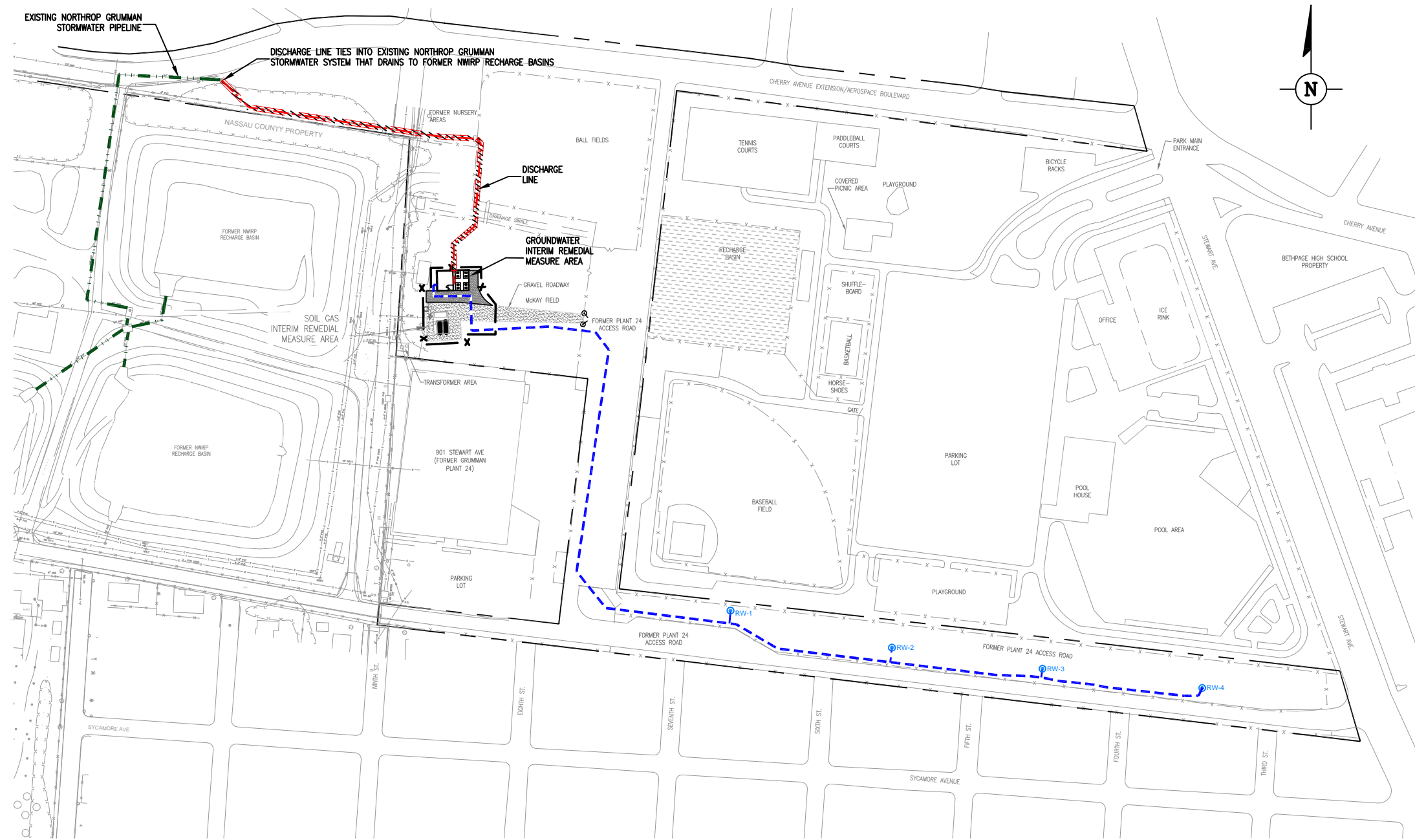
SOURCE:
 USGS 7.5 MIN. AMITYVILLE QUADRANGLE, AMITYVILLE, NY, 1994
 USGS 7.5 MIN. FREEPORT QUADRANGLE, FREEPORT, NY, 1994
 USGS 7.5 MIN. HICKSVILLE QUADRANGLE, HICKSVILLE, NY, 1967, PHOTOREVISED 1979
 USGS 7.5 MIN. HUNTINGTON QUADRANGLE, HUNTINGTON, NY, 1967, PHOTOREVISED 1979

GROUNDWATER INTERIM REMEDIAL MEASURE
 OPERABLE UNIT 3
 (FORMER GRUMMAN SETTLING PONDS)
 BETHPAGE, NEW YORK

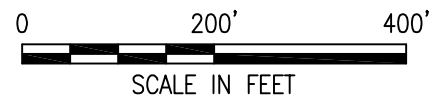
SITE AREA LOCATION



FIGURE
1



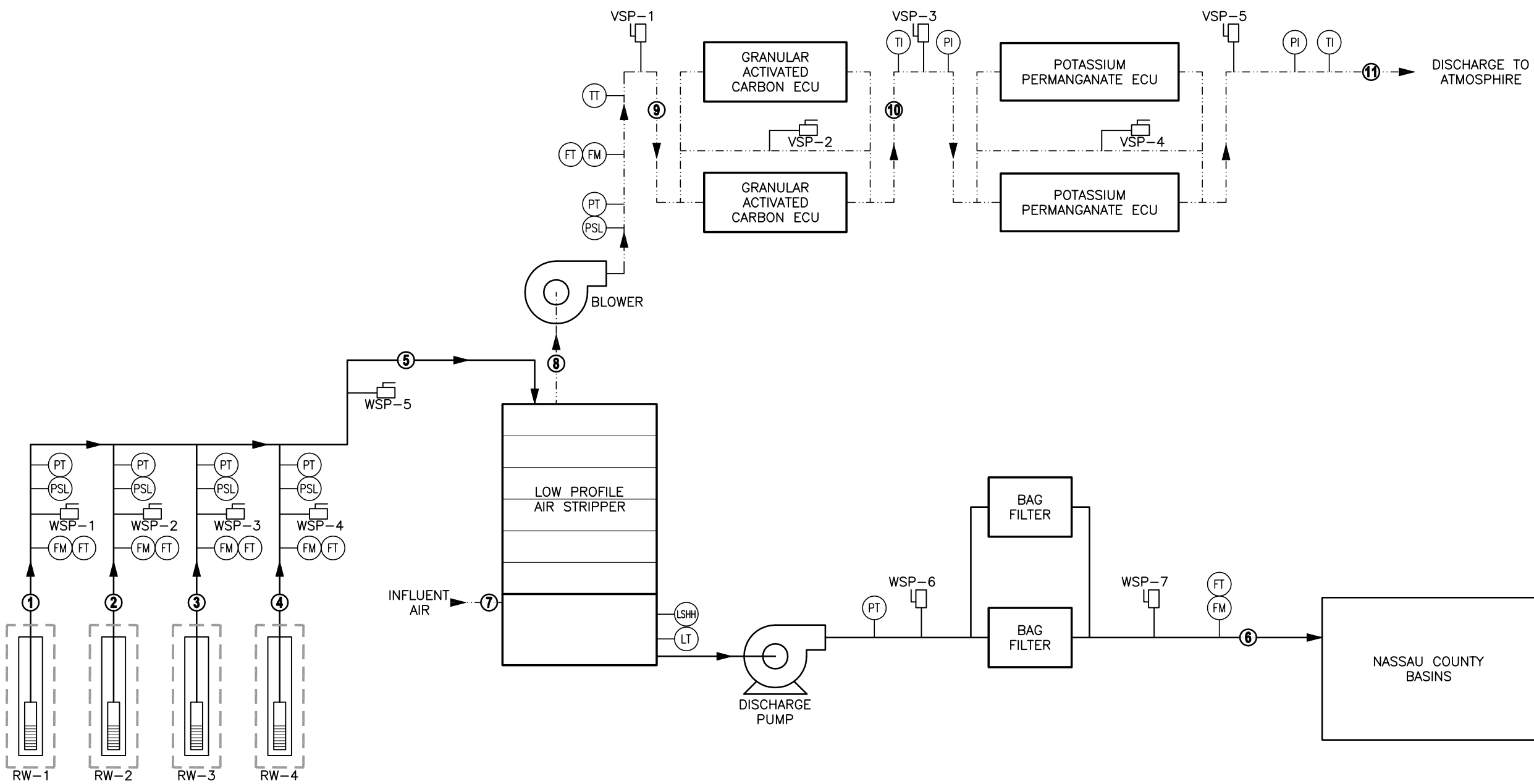
- LEGEND:**
- NORTHROP GRUMMAN PROPERTY LINE
 - X- FENCE
 - b.t. BITUMINOUS PAVEMENT
 - GROUNDWATER IRM INFLUENT PIPELINE AND ELECTRICAL CONDUITS
 - GROUNDWATER IRM EFFLUENT PIPELINE
 - EXISTING NORTHROP GRUMMAN STORMWATER PIPELINE
 - RW-4 GROUNDWATER INTERIM REMEDIAL MEASURE WELL
 - NWIRP NAVAL WEAPONS INDUSTRIAL RESERVE PLANT (NOW OWNED BY NASSAU COUNTY)



GROUNDWATER INTERIM REMEDIAL MEASURE
 OPERABLE UNIT 3
 (FORMER GRUMMAN SETTLING PONDS)
 BETHPAGE, NEW YORK

**SITE AND GROUNDWATER INTERIM
 REMEDIAL MEASURE LAYOUT**

ARCADIS



- LEGEND:**
- PROCESS WATER
 - - - PROCESS AIR
 - ⊖ INSTRUMENT
 - SAMPLE PORT
 - ▶ FLOW DIRECTION
 - FM FLOW METER
 - FT FLOW RATE TRANSMITTER
 - PSL PRESSURE VACUUM LOW
 - PT PRESSURE TRANSMITTER
 - PI PRESSURE INDICATOR
 - LSHH LEVEL SWITCH HIGH HIGH
 - LT LEVEL TRANSMITTER
 - TT TEMPERATURE TRANSMITTER
 - TI TEMPERATURE INDICATOR
 - ⑧ PROCESS DESIGNATION
 - WSP WATER SAMPLE PORT
 - VSP VAPOR SAMPLE PORT

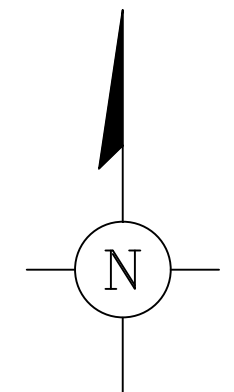
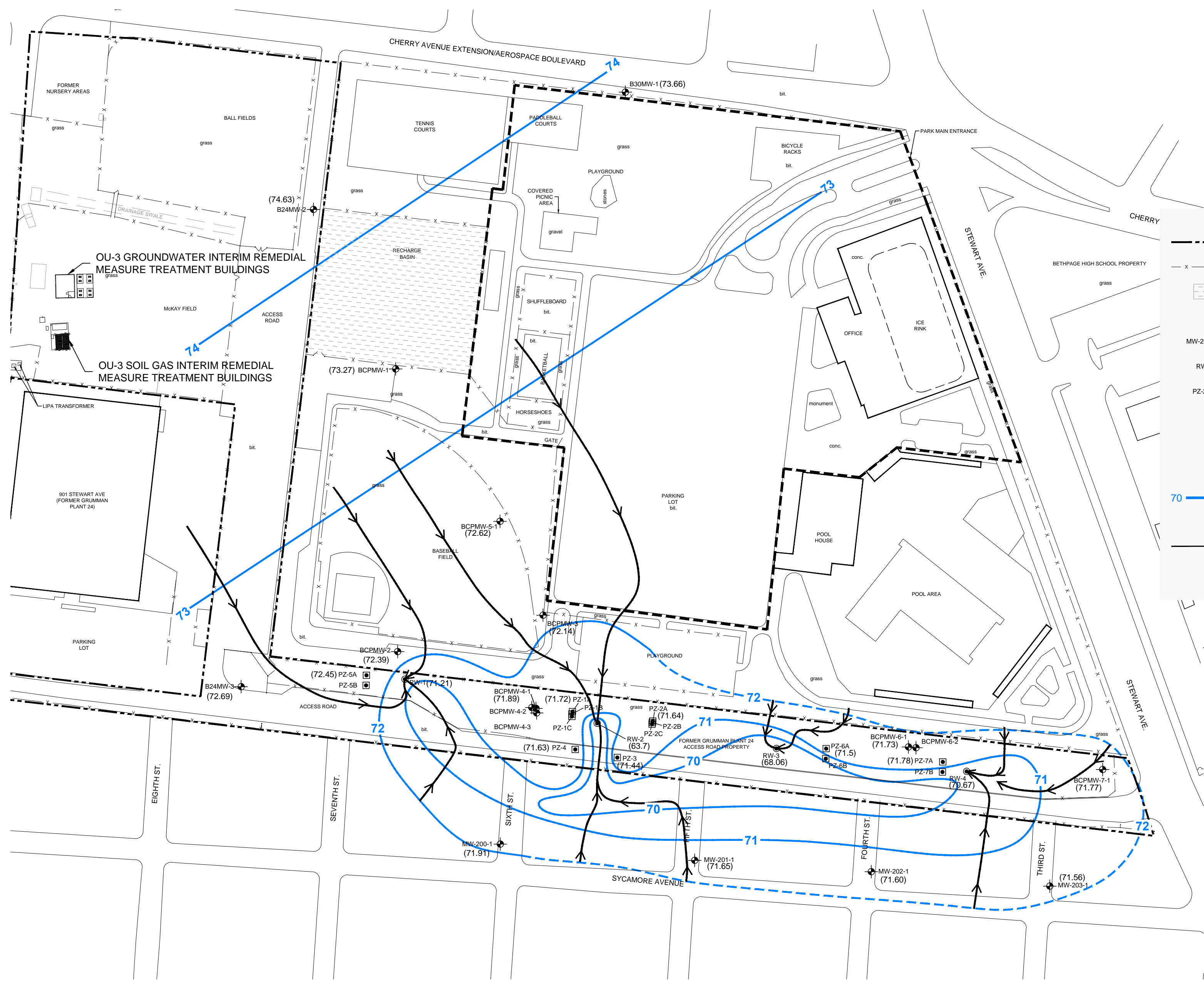
PROCESS	①	②	③	④	⑤	⑥	⑦	⑧	⑨	⑩	⑪
Mass Loading (lbs/day)											
Trichloroethene	0.009	0.041	0.082	0.008	0.140	<0.008	0.000	0.140	0.140	<0.014	<0.014
cis -1,2 Dichloroethene	0.007	1.877	0.431	0.030	2.346	<0.008	0.000	2.346	2.346	<0.235	<0.235
Vinyl Chloride	0.000	0.443	0.001	0.000	0.444	<0.003	0.000	0.444	0.444	0.444	<0.044
Flow Rate (gpm)	40	85	85	40	250	250	---	---	---	---	---
Flow Rate (CFM)	---	---	---	---	---	---	1,300 - 1,600	1,300	1,535	1,557	1,581
Pressure (feet of water)	10	10	10	10	8	15	---	---	---	---	---
Pressure (inches of water)	---	---	---	---	---	---	0	- 28 to - 38	12	6	0
pH	6.4	6.4	6.4	6.4	6.4	6.2	---	---	---	---	---
Temperature	55	55	55	55	55	55	10	55	97	95	95
Relative Humidity	---	---	---	---	---	---	20 - 80	100	<50	<50	<50

GROUNDWATER INTERIM REMEDIAL MEASURE
 OPERABLE UNIT 3
 (FORMER GRUMMAN SETTLING PONDS)
 BETHPAGE, NEW YORK

GROUNDWATER TREATMENT SYSTEM
 PROCESS SCHEMATIC,
 PROCESS FLOW DIAGRAM,
 AND MONITORING LOCATIONS

FIGURE
3

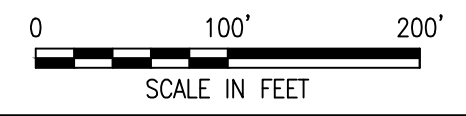
CITY (Rev. 0) DIVISION (Rev. 0) DE (Rev. 0) LD (Rev. 0) PC (Rev. 0) PM (Rev. 0) TM (Rev. 0) LVR (Rev. 0) OFF (Rev. 0) REF
 G:\ENV\CAD\SYSTEMS\ACTIVITY\001498112\GIS\4\2012_4th\DRY\1498_112_01\1498_112_01.dwg LAYOUT_4_SAVED: 3/14/2013 2:27 PM ACADVER: 18 IS LIMS TECH PAGESETUP: PLOTTED: 3/14/2013 2:49 PM BY: SANCHEZ, ADRIAN
 XREFS: IMAGES: PROJECTNAME: ...



EXPLANATION:

- NORTHROP GRUMMAN PROPERTY LINE
- FENCE
- BASIN
- BITUMINOUS PAVEMENT
- MW-200-1 MONITORING WELL
- RW-2 RECOVERY WELL
- PZ-2C PIEZOMETER
- (71.78) WATER-LEVEL ELEVATION (FEET MEAN SEA LEVEL)
- (AM) ANOMALOUS READING
- GROUNDWATER ELEVATION CONTOUR (RELATIVE TO MEAN SEA LEVEL) (DASHED WHERE WATER LEVEL DATA IS UNAVAILABLE)
- HORIZONTAL COMPONENT OF GROUNDWATER FLOW

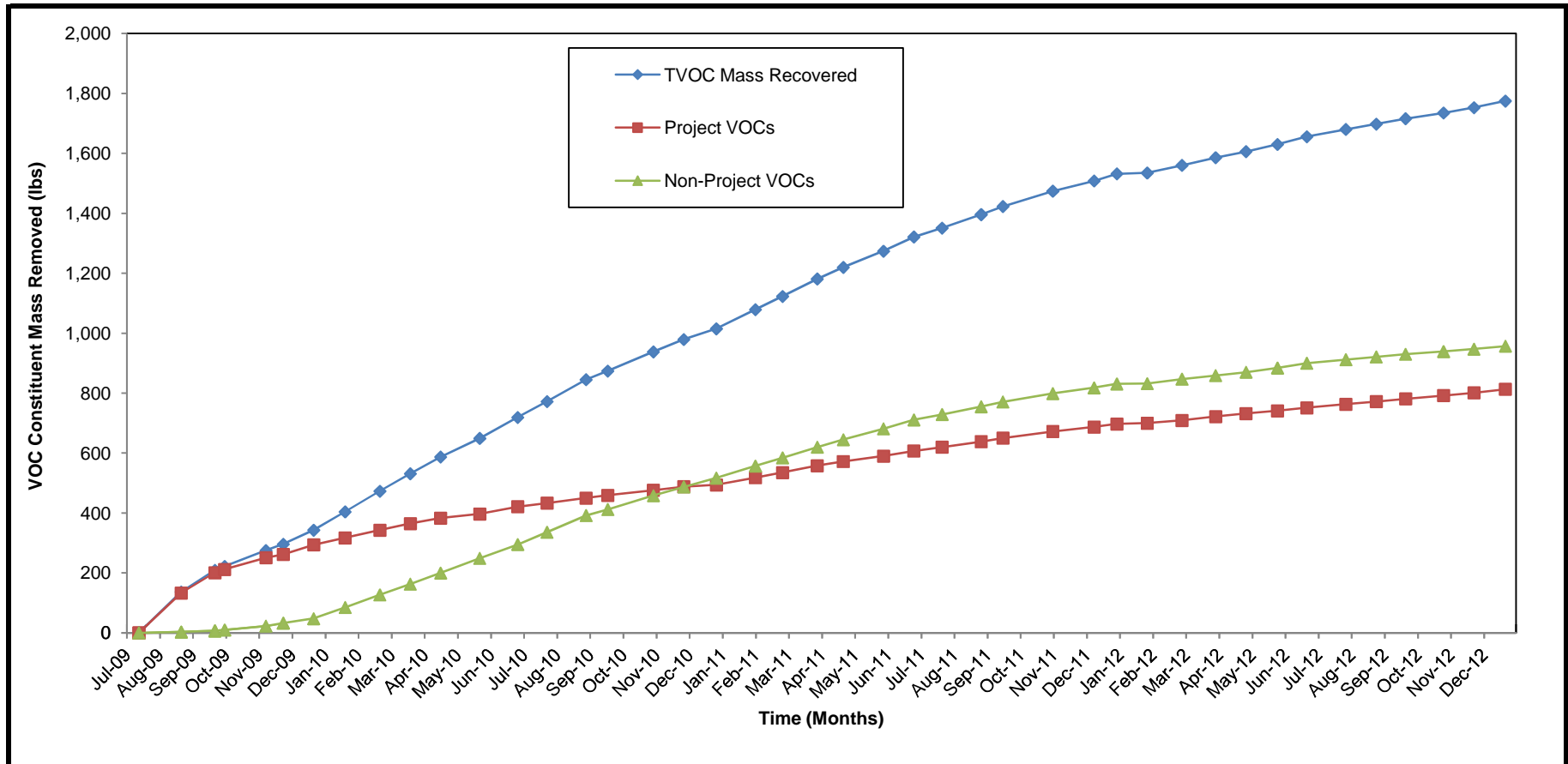
- NOTES:**
- MONITORING WELLS, RECOVERY WELLS, AND PIEZOMETERS SURVEYED TO NORTH AMERICAN DATUM (NAD) 83.
 - PARK FEATURES SHOWN WERE PRESENT PRIOR TO TOWN OF OYSTER BAY REDEVELOPMENT IN 2005.



NORTHROP GRUMMAN SYSTEMS CORPORATION
 OPERABLE UNIT 3
 (FORMER GRUMMAN SETTLEMENTS)
 BETHPAGE, NEW YORK

GROUNDWATER MONITORING WELL NETWORK AND CONFIGURATION OF THE SHALLOW POTENTIOMETRIC SURFACE AND GROUNDWATER FLOW DIRECTIONS
 FOURTH QUARTER 2012

FIGURE 4



Notes:

VOC = Volatile organic compound.

lbs = Pounds.


Total VOCs = Sum of VOCs detected.

Project VOCs = Sum of 1,1,1-Trichloroethane; 1,1-Dichloroethane; 1,2-Dichloroethane; 1,1-Dichloroethene; Tetrachloroethene; Trichloroethene; Vinyl Chloride; cis-1,2-Dichloroethene; trans-1,2-Dichloroethene; Benzene; Toluene; and Total Xylenes.

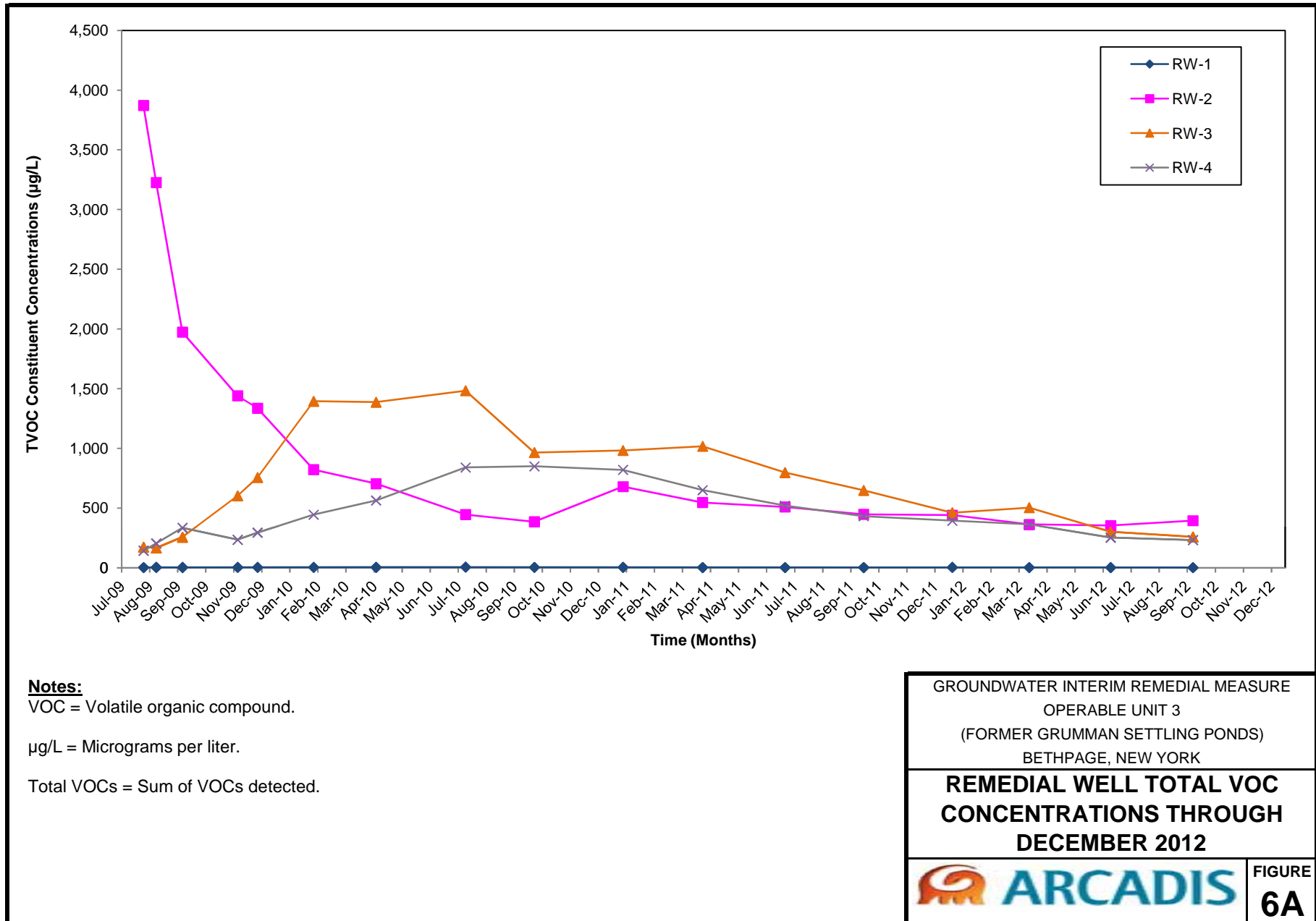
Non-Project VOCs = Sum of Total VOCs that are not Project VOCs.

GROUNDWATER INTERIM REMEDIAL MEASURE
OPERABLE UNIT 3
(FORMER GRUMMAN SETTLING PONDS)
BETHPAGE, NEW YORK

**CUMULATIVE TOTAL, PROJECT,
AND NON-PROJECT VOC MASS
REMOVED THROUGH
DECEMBER 2012**



**FIGURE
5**



Notes:

VOC = Volatile organic compound.

µg/L = Micrograms per liter.

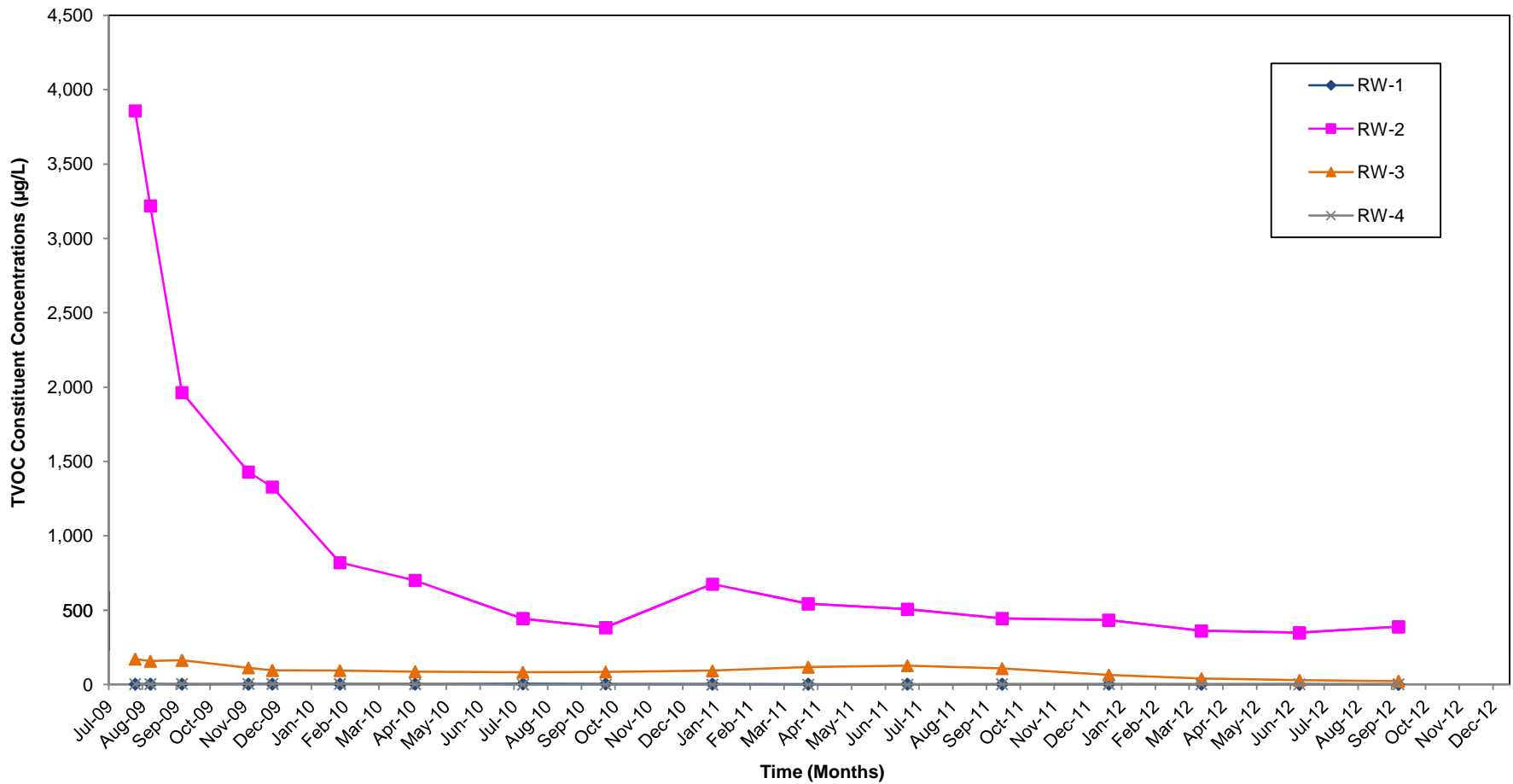
Total VOCs = Sum of VOCs detected.

GROUNDWATER INTERIM REMEDIAL MEASURE
OPERABLE UNIT 3
(FORMER GRUMMAN SETTLING PONDS)
BETHPAGE, NEW YORK

**REMEDIAL WELL TOTAL VOC
CONCENTRATIONS THROUGH
DECEMBER 2012**



FIGURE
6A



Notes:

VOC = Volatile organic compound.

µg/L = Micrograms per liter.

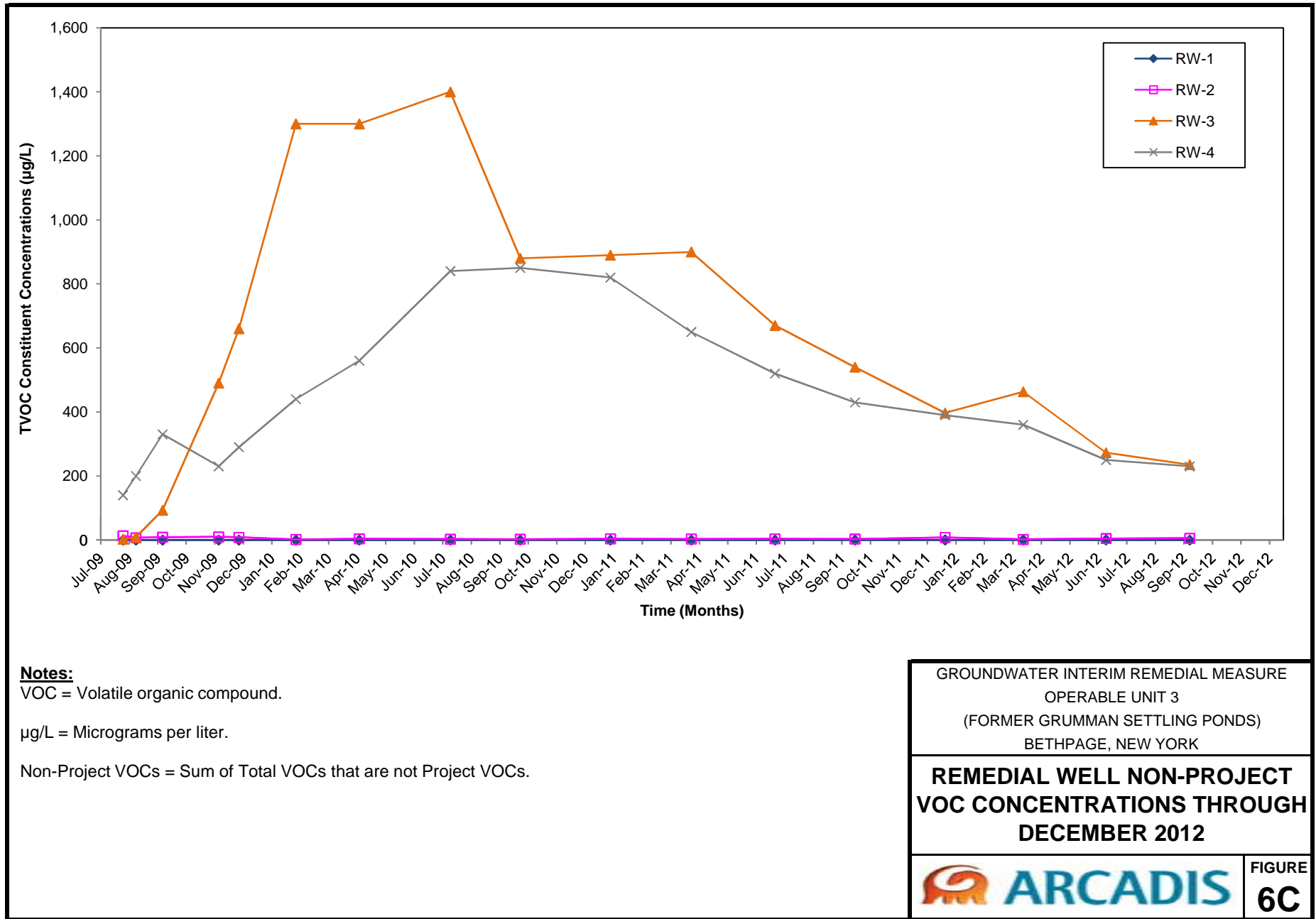
Project VOCs = Sum of 1,1,1-Trichloroethane; 1,1-Dichloroethane; 1,2- Dichloroethane; 1,1-Dichloroethene; Tetrachloroethene; Trichloroethene; Vinyl Chloride; cis-1,2-Dichloroethene; trans-1,2-Dichloroethene; Benzene; Toluene; and Total Xylenes.

GROUNDWATER INTERIM REMEDIAL MEASURE
 OPERABLE UNIT 3
 (FORMER GRUMMAN SETTLING PONDS)
 BETHPAGE, NEW YORK

**REMEDIAL WELL PROJECT VOC
 CONCENTRATIONS THROUGH
 DECEMBER 2012**



FIGURE
6B



Notes:


VOC = Volatile organic compound.

µg/L = Micrograms per liter.

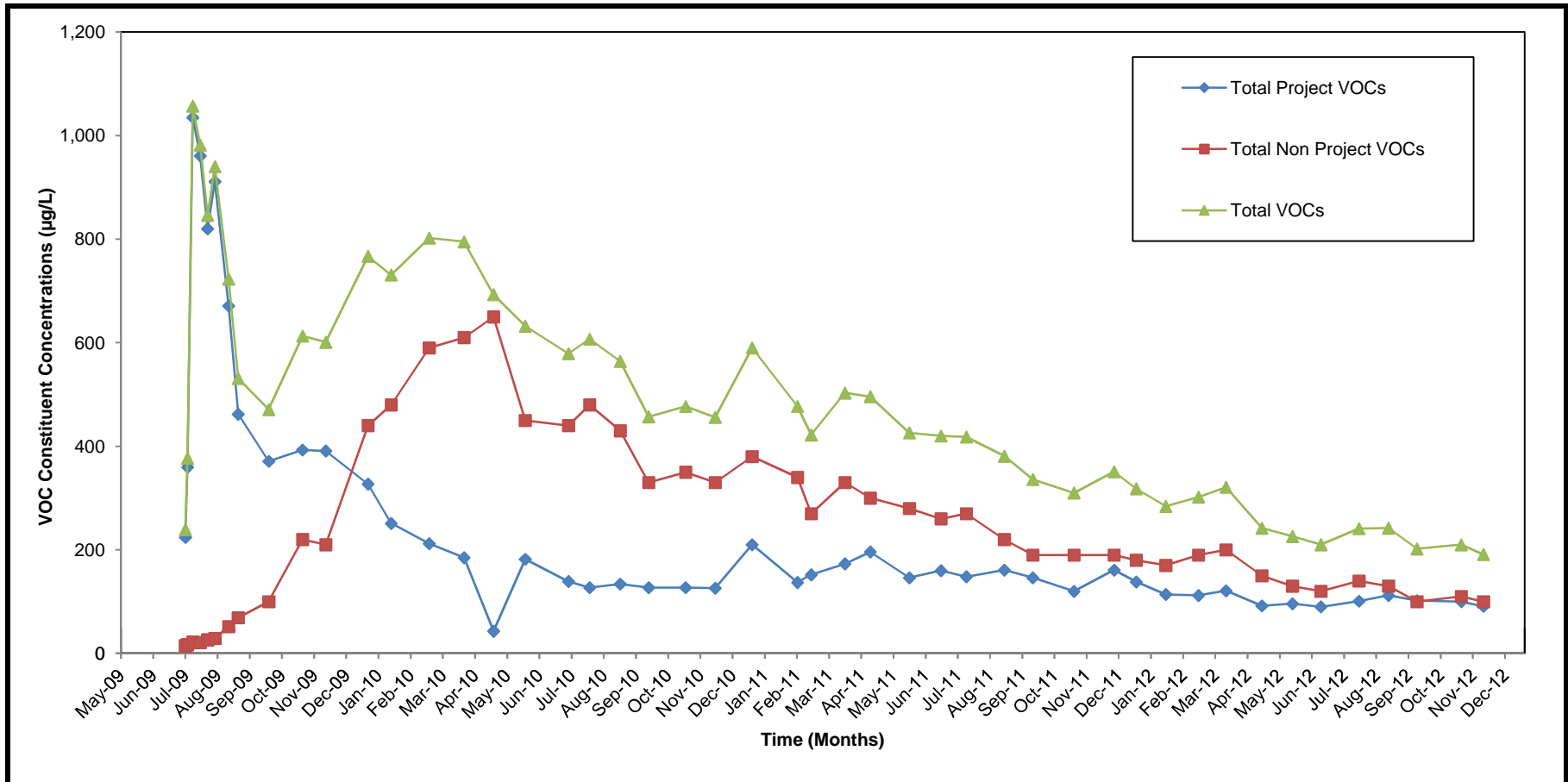
Non-Project VOCs = Sum of Total VOCs that are not Project VOCs.

GROUNDWATER INTERIM REMEDIAL MEASURE
OPERABLE UNIT 3
(FORMER GRUMMAN SETTLING PONDS)
BETHPAGE, NEW YORK

**REMEDIAL WELL NON-PROJECT
VOC CONCENTRATIONS THROUGH
DECEMBER 2012**



**FIGURE
6C**



Notes:

VOC = Volatile organic compound.

ug/L = Microgram per liter.

Total VOCs = Sum of VOCs detected.

Project VOCs = Sum of 1,1,1-Trichloroethane; 1,1-Dichloroethane; 1,2-Dichloroethane; 1,1-Dichloroethene; Tetrachloroethene; Trichloroethene; Vinyl Chloride; cis-1,2-Dichloroethene; trans-1,2-Dichloroethene; Benzene; Toluene; and Total Xylenes.

Non-Project VOCs = Sum of Total VOCs that are not Project VOCs.

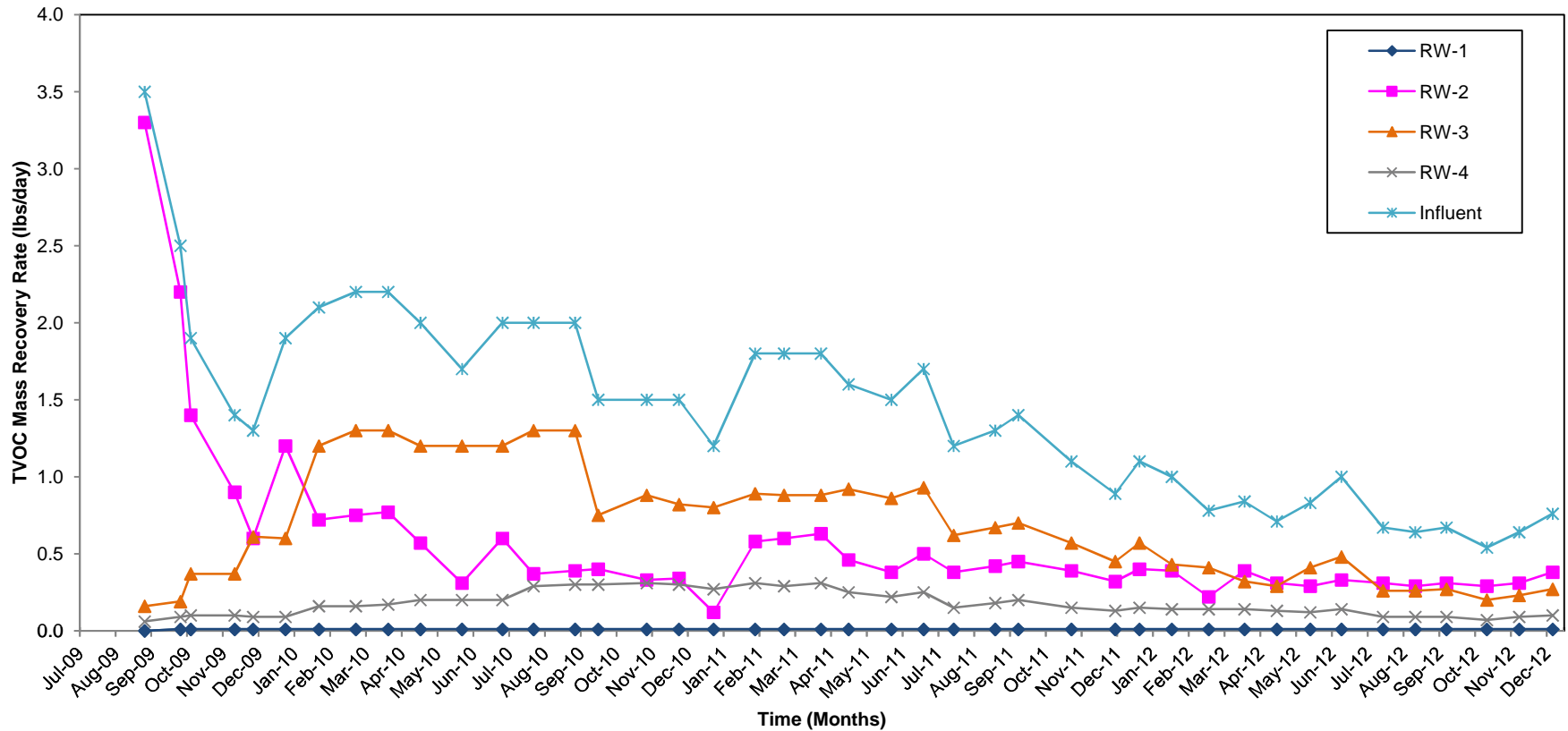
GROUNDWATER INTERIM REMEDIAL MEASURE
OPERABLE UNIT 3
(FORMER GRUMMAN SETTLING PONDS)
BETHPAGE, NEW YORK

**INFLUENT TOTAL, PROJECT,
AND NON-PROJECT
VOC CONCENTRATIONS
THROUGH DECEMBER 2012**



FIGURE

7



Notes:

VOC = Volatile organic compound.

lbs/day = Pounds per day.

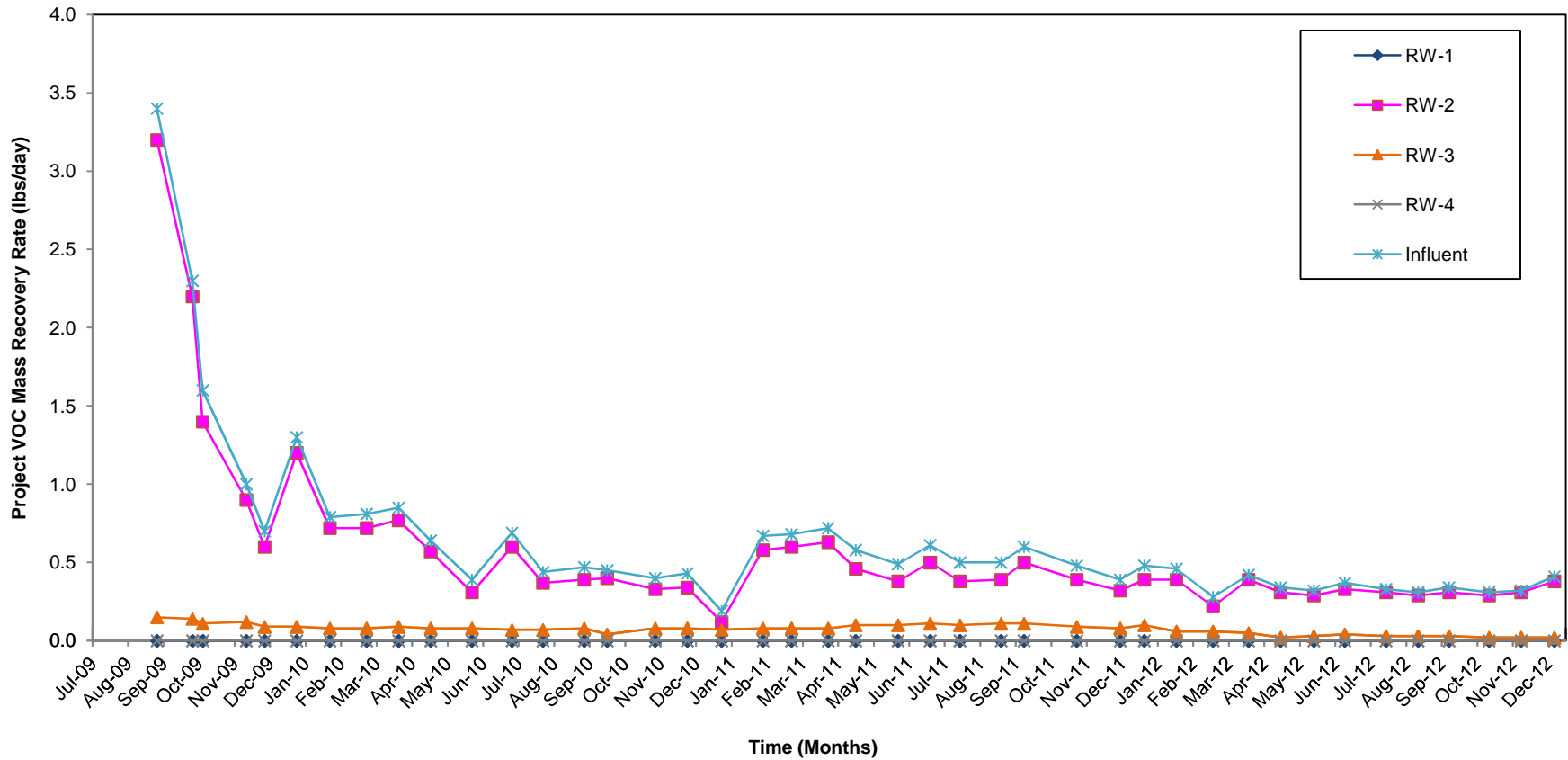
Total VOCs = Sum of VOCs detected.

GROUNDWATER INTERIM REMEDIAL MEASURE
 OPERABLE UNIT 3
 (FORMER GRUMMAN SETTLING PONDS)
 BETHPAGE, NEW YORK

**TOTAL VOC MASS RECOVERY RATES
 THROUGH
 DECEMBER 2012**



FIGURE
8A



Notes:

VOC = Volatile organic compound.

lbs/day = Pounds per day.

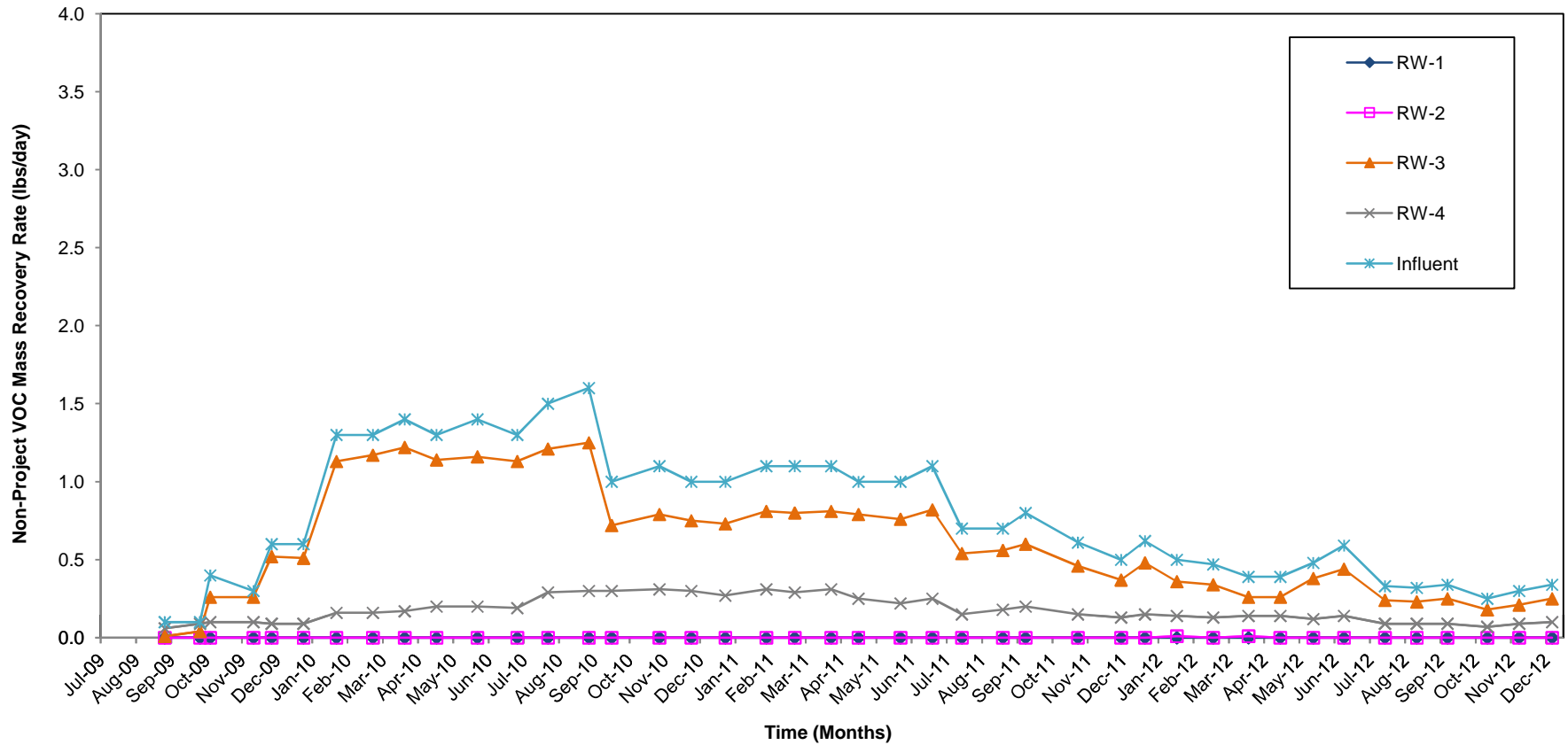
Project VOCs = Sum of 1,1,1-Trichloroethane; 1,1-Dichloroethane; 1,2-Dichloroethane; 1,1-Dichloroethene; Tetrachloroethene; Trichloroethene; Vinyl Chloride; cis-1,2-Dichloroethene; trans-1,2-Dichloroethene; Benzene; Toluene; and Total Xylenes.

GROUNDWATER INTERIM REMEDIAL MEASURE
OPERABLE UNIT 3
(FORMER GRUMMAN SETTLING PONDS)
BETHPAGE, NEW YORK

**PROJECT VOC MASS RECOVERY
RATES THROUGH
DECEMBER 2012**



FIGURE
8B



Notes:

VOC = Volatile organic compound.

lbs/day = Pounds per day.

Non-Project VOCs = Sum of Total VOCs that are not Project VOCs.

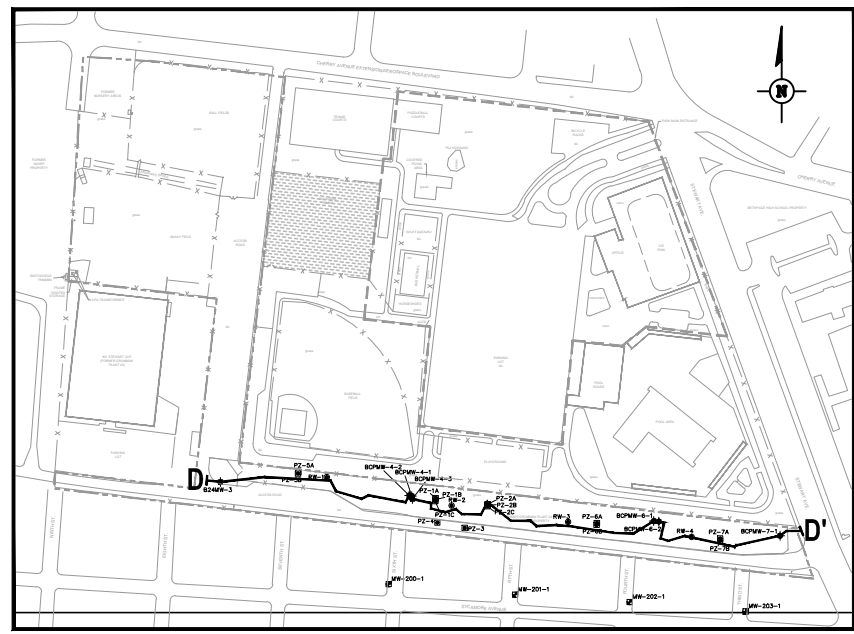
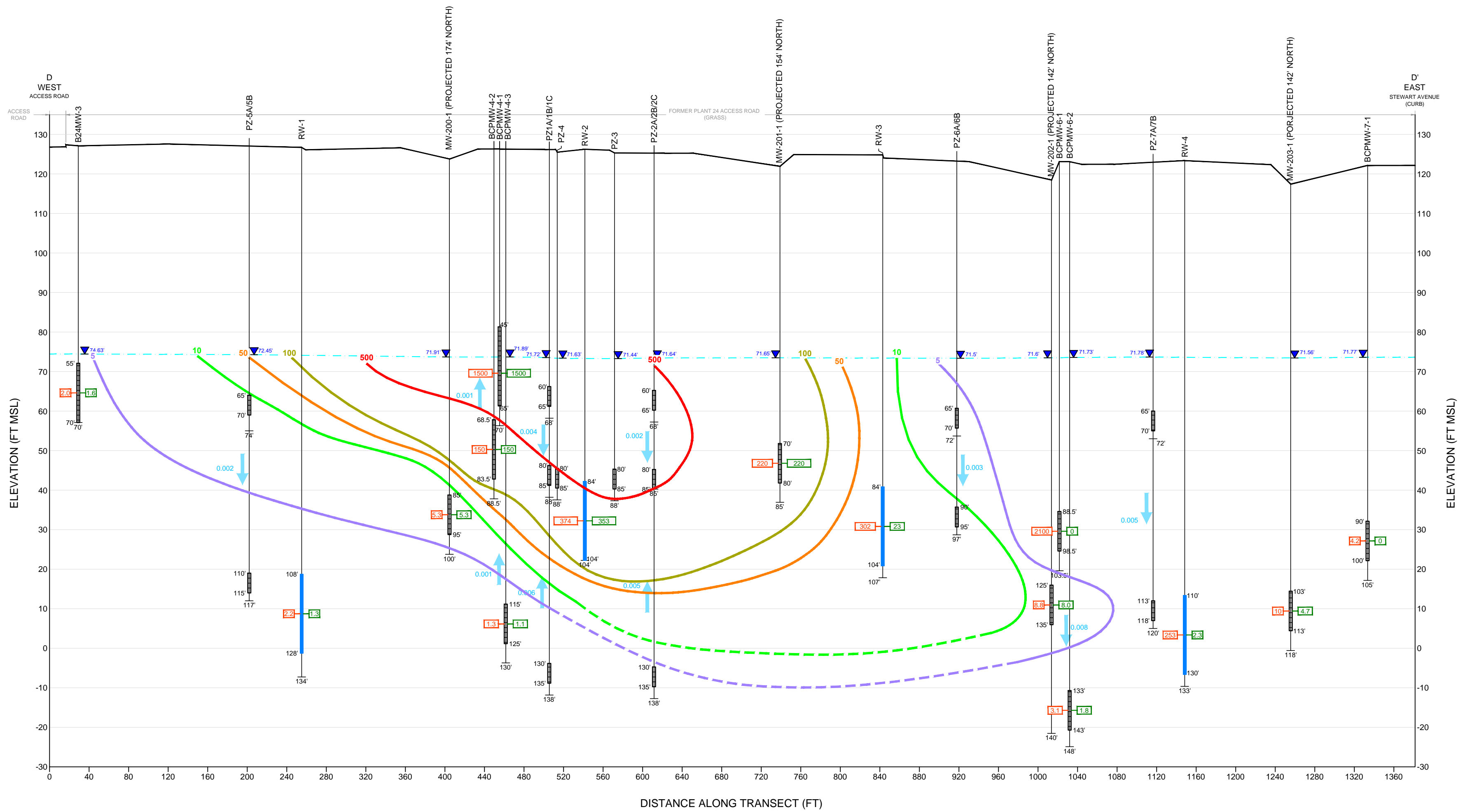
GROUNDWATER INTERIM REMEDIAL MEASURE
 OPERABLE UNIT 3
 (FORMER GRUMMAN SETTLING PONDS)
 BETHPAGE, NEW YORK

**NON-PROJECT VOC MASS
 RECOVERY RATES THROUGH
 DECEMBER 2012**

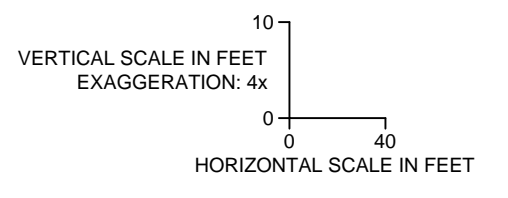
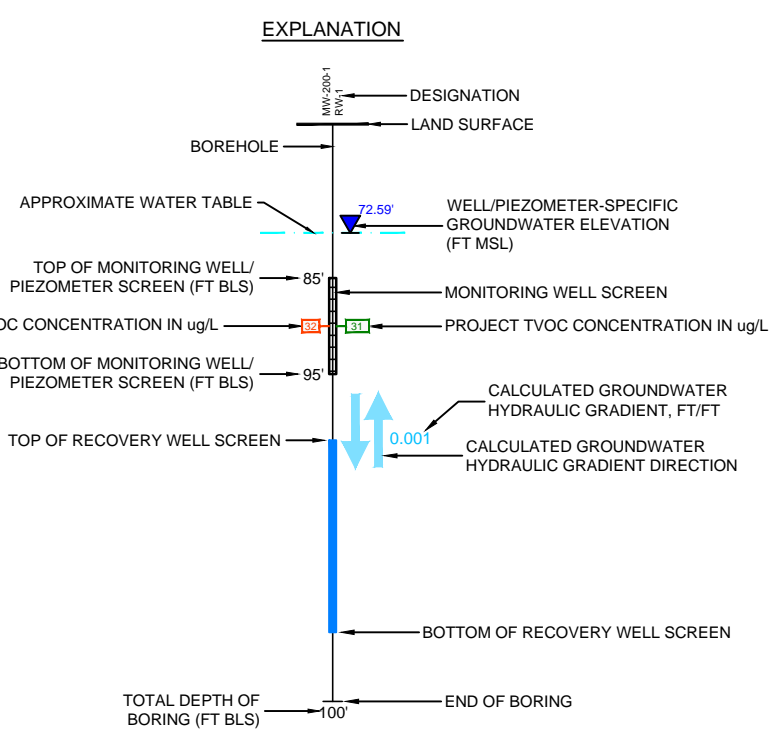


FIGURE
8C

CITY (Road) DIV (GROUP) (Rev) DE (Road) LD (City) PIC (City) PM (Road) TM (City) LTR (City) OFF (REF)
 G:\ENV\CCAS\TRAUSE\ACT\10014807\2\LAR\6\NY148_1112_GWSH_F03.dwg LAYOUT: 9 \$AVED: 4/29/2013 4:18 PM ACADVER: 18 IS (LMS TECH) PAGES: 10 PLOTSTYLE: TABLE: ... PLOTTED: 5/1/2013 8:36 AM BY: SANCHEZ, ADRIAN
 XREFS: IMAGES: PROJECTNAME: ...



KEY PLAN
 SHOWING CROSS SECTION D-D'



- DEFINITIONS:**
 FT - FEET
 MSL - MEAN SEA LEVEL
 TCE - TRICHLOROETHENE
 ug/L - MICROGRAMS PER LITER
 TVOC - TOTAL VOLATILE ORGANIC COMPOUND
- DEFINITION OF CONTOURS (DASHED WHERE INFERRED)**
- 5 5 µg/L
 - 10 10 µg/L
 - 50 50 µg/L
 - 100 100 µg/L
 - 500 500 µg/L
 - 1,000 1,000 µg/L

- NOTES:**
1. WATER LEVEL ELEVATIONS CALCULATED FROM DATA COLLECTED ON OCTOBER 5, 2012.
 2. MONITORING WELL TVOC/PROJECT TVOC DATA FROM THE OCTOBER 2012 SAMPLING ROUND. RESULT REPRESENTATIVE OF ENTIRE WELL SCREEN INTERVAL.
 3. CONTOURS ARE BASED ON PROJECT TVOC DATA, SEE NOTE 2.
 4. THE GROUNDWATER INTERIM REMEDIAL MEASURE (IRM) HAS BEEN DESIGNED TO ADDRESS GROUNDWATER THAT HAS TVOC CONCENTRATIONS GREATER THAN 5 µg/L IN THE UPPER 20 FEET OF THE SURFICIAL AQUIFER AND GROUNDWATER BELOW THE UPPER 20 FEET OF THE SURFICIAL AQUIFER THAT HAS TVOC CONCENTRATIONS GREATER THAN 50 µg/L.
 5. PROJECT VOCS ARE VOCS THAT MAY BE RELATED TO FORMER GRUMMAN HISTORICAL ACTIVITIES. NON-PROJECT VOCS ARE VOCS THAT ARE NOT RELATED TO FORMER GRUMMAN ACTIVITIES BUT HAVE BEEN DETECTED IN THE SITE AREA. PLEASE REFER TO THE REPORT TABLES FOR LISTS OF PROJECT AND NON-PROJECT VOCS.

NORTHROP GRUMMAN SYSTEMS CORPORATION
 OPERABLE UNIT 3
 (FORMER GRUMMAN SETTLING PONDS)
 BETHPAGE, NEW YORK

CROSS SECTION D-D' SHOWING TVOCs IN GROUNDWATER AND DIRECTION OF VERTICAL GROUNDWATER HYDRAULIC GRADIENTS FOURTH QUARTER 2012

FIGURE
9



Appendix A

Well Construction Information and
Environmental Effectiveness
Monitoring Program

Table A-1. Well Construction Information and Environmental Effectiveness Monitoring Program, Groundwater Interim Remedial Measure, Operable Unit 3 (Former Grumman Settling Ponds), Northrop Grumman Systems Corporation, Bethpage, New York. ^(1,2)

Well ID	Well Diameter (inches)	Depth to Screen		Screen Length (ft)	Well Depth (ft)	Well Materials	Water Levels ⁽³⁾	MONITORING ACTIVITY		
		Top (ft bls)	Bottom (ft bls)					WATER QUALITY ⁽⁴⁾		
								VOC	Cd/Cr	Fe/Mn
Monitoring Wells										
BCPMW-1	2	50	65	15	65	Sch. 40 PVC	Quarterly	Baseline	Baseline	--
BCPMW-2	2	60	75	15	75	Sch. 40 PVC	Quarterly	Baseline	Baseline	Baseline
BCPMW-3	2	59	74	15	74	Sch. 40 PVC	Quarterly	Baseline	Baseline	Baseline
BCPMW-4-1	4	45	65	20	70	Sch. 40 PVC	Quarterly	Baseline/Semiannual ⁽⁵⁾	Baseline/Annual	Baseline
BCPMW-4-2	4	68.5	83.5	15	88.5	Sch. 40 PVC	Quarterly	Baseline/Semiannual ⁽⁵⁾	Baseline/Annual	Baseline
BCPMW-4-3	4	115	125	10	130	Sch. 40 PVC	Quarterly	Baseline/Semiannual ⁽⁵⁾	Baseline/Annual	Baseline
BCPMW-5-1	4	50	65	15	70	Sch. 80 PVC/ SS	Quarterly	Baseline	Baseline	Baseline
BCPMW-6-1	4	88.5	98.5	10	103.5	Sch. 40 PVC	Quarterly	Baseline/Semiannual ⁽⁵⁾	Baseline/Annual	--
BCPMW-6-2	4	133	143	10	148	Sch. 40 PVC	Quarterly	Baseline/Semiannual ⁽⁵⁾	Baseline/Annual	--
BCPMW-7-1	4	90	100	10	105	Sch. 40 PVC	Quarterly	Baseline/Semiannual ⁽⁵⁾	Baseline/Annual	--
B24MW-2	2	54	74	20	74	PVC	Quarterly	Baseline/Annual	Baseline	--
B24MW-3	2	55	70	15	70	PVC	Quarterly	Baseline/Annual	Baseline	--
B30MW-1	2	57	72	15	72	PVC	Quarterly	Baseline/Annual	Baseline	--
MW-200-1	4	85	95	10	100	Sch. 40 PVC/ SS	Quarterly	Baseline/Semiannual ⁽⁵⁾	Baseline/Annual	--
MW-201-1	4	70	80	10	85	Sch. 40 PVC/ SS	Quarterly	Baseline/Semiannual ⁽⁵⁾	Baseline/Annual	--
MW-202-1	4	125	135	10	140	Sch. 40 PVC/ SS	Quarterly	Baseline/Semiannual ⁽⁵⁾	Baseline/Annual	--
MW-203-1	4	103	113	10	118	Sch. 40 PVC/ SS	Quarterly	Baseline/Semiannual ⁽⁵⁾	Baseline/Annual	--
Remedial Wells ⁽⁶⁾										
RW-01	8	108	128	20	134	Sch. 80 PVC/SS	Quarterly	Baseline/Quarterly	Baseline/Annual	--
RW-02	6	84	104	20	104	Steel/SS	Quarterly	Baseline/Quarterly	Baseline/Annual	--
RW-03	8	84	104	20	107	Sch. 80 PVC/SS	Quarterly	Baseline/Quarterly	Baseline/Annual	--
RW-04	8	110	130	20	133	Sch. 80 PVC/SS	Quarterly	Baseline/Quarterly	Baseline/Annual	--

See notes on last page.

Table A-1. Well Construction Information and Environmental Effectiveness Monitoring Program, Groundwater Interim Remedial Measure, Operable Unit 3 (Former Grumman Settling Ponds), Northrop Grumman Systems Corporation, Bethpage, New York. ^(1,2)

Well ID	Well Diameter (inches)	Depth to Screen		Screen Length (ft)	Well Depth (ft)	Well Materials	Water Levels ⁽³⁾	MONITORING ACTIVITY		
		Top (ft bls)	Bottom (ft bls)					WATER QUALITY ⁽⁴⁾		
								VOC	Cd/Cr	Fe/Mn
Piezometers										
PZ-01a	2	60	65	5	68	Sch. 40 PVC	Quarterly	--	--	--
PZ-01b	1	80	85	5	88	Sch. 40 PVC	Quarterly	--	--	--
PZ-01c	1	130	135	5	138	Sch. 40 PVC	Quarterly	--	--	--
PZ-02a	2	60	65	5	68	Sch. 40 PVC	Quarterly	--	--	--
PZ-02b	1	80	85	5	85	Sch. 40 PVC	Quarterly	--	--	--
PZ-02c	1	130	135	5	138	Sch. 40 PVC	Quarterly	--	--	--
PZ-03	1	80	85	5	88	Sch. 40 PVC	Quarterly	--	--	--
PZ-04	1	80	85	5	88	Sch. 40 PVC	Quarterly	--	--	--
PZ-05a	2	65	70	5	74	Sch. 40 PVC	Quarterly	--	--	--
PZ-05b	1	110	115	5	117	Sch. 40 PVC	Quarterly	--	--	--
PZ-06a	2	65	70	5	72	Sch. 40 PVC	Quarterly	--	--	--
PZ-06b	1	90	95	5	97	Sch. 40 PVC	Quarterly	--	--	--
PZ-07a	2	65	70	5	72	Sch. 40 PVC	Quarterly	--	--	--
PZ-07b	1	113	118	5	120	Sch. 40 PVC	Quarterly	--	--	--

Notes:

- (1) Water samples will be collected and analyzed in accordance with the method and procedures described in the Sampling and Analysis Plan (SAP).
- (2) Approximate locations of the wells and piezometers in the OU-3 Groundwater Interim Remedial Measure Monitoring Program are shown in Figure 1.
- (3) Water levels will be measured in all wells/piezometers during the baseline monitoring event. Water levels will be measured in accordance with the procedures presented in the SAP.
- (4) VOC: VOCs, per Table D-3 in the Quality Assurance Project Plan (QAPP), using NYSDEC ASP 2000 Method OLM 4.3.
Cd/Cr: Cadmium and Chromium using USEPA Method 6010.
Fe/Mn: Iron and Manganese using USEPA Method 6010, both total and dissolved.
- (5) Semiannual wells will be monitored annually after Year 1.
- (6) Some of the analyses listed here are also covered in the Remedial System Sampling Program (Table B-1) and some of the analyses and/or frequencies may be modified based on review of short-term and/or long-term testing results. (e.g. the Cd/Cr sampling frequency was changed from quarterly to annually in 2011).

Acronyms\Key:

Sch. 80 PVC	Schedule 80 polyvinyl chloride.
Sch. 40 PVC	schedule 40 polyvinyl chloride.
SS	Stainless steel.
Steel	Low carbon steel.
ft	Feet.
ft ms	Feet relative to mean sea level.
ft bls	Feet below land surface.
--	Not applicable.
VOC	Volatile organic compound.



Appendix B

Compliance and Performance
Program and Water Sample
Analytical Results

Table B-1. Compliance and Performance Program Elements, Groundwater Interim Remedial Measure, Operable Unit 3 (Former Grumman Settling Ponds), Northrop Grumman Systems Corporation, Bethpage, New York.

Sample Location/Instrument ⁽¹⁾	Parameter (Method) ⁽²⁾	Frequency			SCADA Data Acquisition
		Short-Term ⁽³⁾ (first month)	(five month period following first month)	Long-Term ⁽⁴⁾	
<u>Water Samples</u> ⁽⁵⁾					
Remedial Well 1 (WSP-1)	VOCs (NYSDEC 2000 OLM 4.3)	Bi-Weekly	Quarterly	Quarterly	NA
	Iron (USEPA 6010)	Bi-Weekly	Annually	Annually	NA
	Cadmium and Chromium (USEPA 6010) ⁽¹¹⁾	---			
Remedial Well 2 (WSP-2)	VOCs (NYSDEC 2000 OLM 4.3)	Bi-Weekly	Quarterly	Quarterly	NA
	Iron (USEPA 6010)	Bi-Weekly	Annually	Annually	NA
	Cadmium and Chromium (USEPA 6010) ⁽¹¹⁾	---			
Remedial Well 3 (WSP-3)	VOCs (NYSDEC 2000 OLM 4.3)	Bi-Weekly	Quarterly	Quarterly	NA
	Iron (USEPA 6010)	Bi-Weekly	Annually	Annually	NA
	Cadmium and Chromium (USEPA 6010) ⁽¹¹⁾	---			
Remedial Well 4 (WSP-4)	VOCs (NYSDEC 2000 OLM 4.3)	Bi-Weekly	Quarterly	Quarterly	NA
	Iron (USEPA 6010)	Bi-Weekly	Annually	Annually	NA
	Cadmium and Chromium (USEPA 6010) ⁽¹¹⁾	---	Annually	Annually	NA
Air Stripper Influent (WSP-5)	VOCs (NYSDEC 2000 OLM 4.3)	1-hr ⁽⁶⁾ ; Days 1, 3, & Weekly	Monthly	Quarterly	NA
	Iron (USEPA 6010)	1-hr ⁽⁶⁾ ; Days 1, 3, & Weekly	Monthly	Quarterly	NA
Air Stripper Effluent (WSP-6)	Iron (USEPA 6010)	1-hr ⁽⁶⁾ ; As Needed	As Needed	As Needed	NA
Plant Effluent (WSP-7)	VOCs (NYSDEC 2000 OLM 4.3)	1-hr ⁽⁶⁾; Days 1, 3, & Weekly	Monthly	Monthly	NA
	Iron (USEPA 6010)	1-hr ⁽⁶⁾; Days 1, 3, & Weekly	Monthly	Monthly	NA
	Mercury (USEPA 7470) ⁽⁷⁾	1-hr ⁽⁶⁾; Days 1, 3, & Weekly	Monthly	NA	NA
	pH (field) ⁽⁸⁾	1-hr ⁽⁶⁾; Days 1, 3, & Weekly	Monthly	Monthly	NA
	Cadmium and Chromium (USEPA 6010) ⁽¹¹⁾	---	Quarterly	Quarterly	NA
<u>Air Samples</u> ^{(9) (10)}					
Air Stripper Effluent/ECU-1 Influent (VSP-1)	VOCs (TO-15 Modified)	Monthly	Monthly	Quarterly	NA
ECU-1 Effluent/ECU-2 Influent (VSP-2)	VOCs (TO-15 Modified)	As Needed	As Needed	As Needed	NA
ECU-2 Effluent/ECU-3 Influent (VSP-3)	VOCs (TO-15 Modified)	As Needed	As Needed	As Needed	NA
ECU-3 Effluent/ECU-4 Influent (VSP-4)	VOCs (TO-15 Modified)	As Needed	As Needed	As Needed	NA
Total Effluent (VSP-5)	VOCs (TO-15 Modified)	Monthly	Monthly	Quarterly	NA

See notes on last page.

Table B-1. Compliance and Performance Program Elements, Groundwater Interim Remedial Measure, Operable Unit 3 (Former Grumman Settling Ponds), Northrop Grumman Systems Corporation, Bethpage, New York.

Sample Location/Instrument ⁽¹⁾	Parameter (Method) ⁽²⁾	Frequency			SCADA Data Acquisition
		Short-Term ⁽³⁾ (first month)	(five month period following first month)	Long-Term ⁽⁴⁾	
<u>Water Flow Measurements</u>					
Remedial Well RW-1 (FT - 110)	Flow rate (gpm + total gal.)	(Daily -1st week) Weekly	Weekly	Weekly	Continuously
Remedial Well RW-2 (FT - 120)	Flow rate (gpm + total gal.)	(Daily -1st week) Weekly	Weekly	Weekly	Continuously
Remedial Well RW-3 (FT - 130)	Flow rate (gpm + total gal.)	(Daily -1st week) Weekly	Weekly	Weekly	Continuously
Remedial Well RW-4 (FT - 140)	Flow rate (gpm + total gal.)	(Daily -1st week) Weekly	Weekly	Weekly	Continuously
Combined Influent (FR - 200)	Flow rate (gpm + total gal.)	(Daily -1st week) Weekly	Weekly	Weekly	Continuously
System Effluent (FT-700)	Flow rate (gpm + total gal.)	(Daily -1st week) Weekly	Weekly	Weekly	Continuously
<u>Air Flow Measurements</u>					
Air Stripper Effluent (FT-500)	Flow rate (SCFM)	(Daily -1st week) Weekly	Weekly	Weekly	Continuously
<u>Water Pressure Measurements</u>					
Remedial Well RW-1 (PT - 110)	Pressure (i.w.g.)	(Daily -1st week) Weekly	Weekly	Weekly	Continuously
Remedial Well RW-2 (PT - 120)	Pressure (i.w.g.)	(Daily -1st week) Weekly	Weekly	Weekly	Continuously
Remedial Well RW-3 (PT - 130)	Pressure (i.w.g.)	(Daily -1st week) Weekly	Weekly	Weekly	Continuously
Remedial Well RW-4 (PT - 140)	Pressure (i.w.g.)	(Daily -1st week) Weekly	Weekly	Weekly	Continuously
Air Stripper Effluent (PT-700)	Pressure (i.w.g.)	(Daily -1st week) Weekly	Weekly	Weekly	Continuously
<u>Air Temperature & Relatively Humidity Measurements</u>					
Air Stripper Effluent (TT-500)	Temperature	Weekly	Weekly	Weekly	Continuously
ECU Mid-Train (TI-503)	Temperature	Weekly	Weekly	Weekly	NA
Effluent (TI-603)	Temperature	Weekly	Weekly	Weekly	NA

See notes on last page.

Table B-1. Compliance and Performance Program Elements, Groundwater Interim Remedial Measure, Operable Unit 3 (Former Grumman Settling Ponds), Northrop Grumman Systems Corporation, Bethpage, New York.

Sample Location/Instrument ⁽¹⁾	Parameter (Method) ⁽²⁾	Frequency			SCADA Data Acquisition
		Short-Term ⁽³⁾ (first month)	(five month period following first month)	Long-Term ⁽⁴⁾	
<u>Air Pressure Measurements</u>					
Air Stripper Effluent (PT-500)	Pressure (i.w.g.)	(Daily -1st week) Weekly	Monthly	Quarterly	Continuously
ECU #1 Influent (PI-501)	Pressure (i.w.g.)	(Daily -1st week) Weekly	Monthly	Quarterly	NA
ECU #2 Influent (PI-502)	Pressure (i.w.g.)	(Daily -1st week) Weekly	Monthly	Quarterly	NA
ECU #3 Influent (PI-601)	Pressure (i.w.g.)	(Daily -1st week) Weekly	Monthly	Quarterly	NA
ECU #4 Influent (PI-602)	Pressure (i.w.g.)	(Daily -1st week) Weekly	Monthly	Quarterly	NA
System Effluent (PI-603)	Pressure (i.w.g.)	(Daily -1st week) Weekly	Monthly	Quarterly	NA

See notes on last page.

Table B-1. Compliance and Performance Program Elements, Groundwater Interim Remedial Measure, Operable Unit 3 (Former Grumman Settling Ponds), Northrop Grumman Systems Corporation, Bethpage, New York.

Notes:

- (1) Refer to Figure 3 of this Operation, Maintenance, & Monitoring (OM&M) Report and Appendix E of the Groundwater IRM OM&M Manual (OM&M Manual (ARCADIS 2009)) for a diagram showing referenced sample locations and measurement points.
- (2) Parameters/methods may be modified based on review of short-term and/or long-term testing results. Parameters shown in **Bold** indicate parameters that require NYSDEC notification/approval prior to change in monitoring schedule.
- (3) Short-term schedule is tentative. Modification may be required/recommended based on the results of start-up and performance testing.
- (4) Long-term schedule is tentative. Modification may be required/recommended based on the results of short-term testing or water quality trends.
- (5) Water samples will be collected in accordance with the methods described in the Sampling and Analysis Plan, which is included as Appendix A of the OM&M Manual (ARCADIS 2009). Samples will be analyzed in accordance with the methods and procedures described in the Sampling and Analysis Plan.
- (6) Per NYSDEC request, a 1-hr pilot test was performed during system shake-down. The 1-hr pilot test samples were also analyzed for Mercury (Hg).
- (7) Per the interim treated effluent (water) discharge criteria provided in the NYSDEC letter dated March 19, 2009, select samples were analyzed for Mercury (Hg).
- (8) As authorized by the NYSDEC, the pH monitoring frequency was reduced from weekly to monthly beginning on February 8, 2010.
- (9) Air samples collected and analyzed in accordance with methods described in the Sampling and Analysis Plan, which is included as Appendix A of the OM&M Manual (ARCADIS 2009).
- (10) Additional air samples will be collected to help calculate media usage rates and to help determine media changeout frequencies.
- (11) Cadmium and Chromium analyses are part of the Environmental Effectiveness Monitoring Program (Table A-1) and the original discharge permit application. They are included here for consistency.

Acronyms/Key:

NA	Not Applicable.
---	Not Required
ECU	Emissions control unit.
VOCs	Volatile organic compounds (refer Tables D-3 and D-5 in the Quality Assurance Project Plan (QAPP) (Appendix D of the OM&M Manual (ARCADIS 2009)) for the analyte lists for aqueous and air samples, respectively).
gal.	Gallons.
gpm	Gallons per minute.
i.w.g.	Inches water gauge.
NYSDEC	New York State Department of Environmental Conservation.
EPA	U.S. Environmental Protection Agency.
SCADA	Supervisory Control And Data Acquisition.
OM&M	Operation, maintenance and monitoring.

Table B-2. Water Sample Analytical Results - October 1, 2012, Groundwater Interim Remedial Measure, Operable Unit 3
 (Former Grumman Settling Ponds), Bethpage, New York. ^(1,2,3)

COMPOUND (ug/L)	Sample ID: Sample Location: Sample Date:	WSP-01 RW-1 10/1/2012	WSP-02 RW-2 10/1/2012	WSP-02 dup. RW-2 10/1/2012	WSP-03 RW-3 10/1/2012	WSP-04 RW-4 10/1/2012	WSP-05 Influent 10/1/2012	WSP-07 Effluent 10/1/2012
<u>Volatile Organic Compounds</u>								
1,1,1-Trichloroethane		< 5 U	0.51 J	0.5 J	< 10 U	< 10 U	< 5 U	< 5 U
1,1,2,2-Tetrachloroethane		< 5 U	< 5 U	< 5 U	< 10 U	< 10 U	< 5 U	< 5 U
1,1,2-Trichloroethane		< 5 U	< 5 U	< 5 U	< 10 U	< 10 U	< 5 U	< 5 U
1,1-Dichloroethane		< 5 U	1.6 J	1.7 J	< 10 U	0.54 J	0.47 J	< 5 U
1,1-Dichloroethene		< 5 U	1 J	1 J	< 10 U	< 10 U	0.36 J	< 5 U
1,2-Dichloroethane		< 5 U	< 5 U	< 5 U	< 10 U	< 10 U	< 5 U	< 5 U
1,2-Dichloropropane		< 5 U	0.28 J	< 5 U	< 10 U	< 10 U	< 5 U	< 5 U
2-Butanone (MEK)		< 50 U	< 50 U	< 50 U	< 100 U	< 100 U	< 50 U	< 50 U
2-Hexanone (MBK)		< 50 U	< 50 U	< 50 U	< 100 U	< 100 U	< 50 U	< 50 U
4-methyl-2-pentanone (MIK)		< 50 U	< 50 U	< 50 U	< 100 U	< 100 U	< 50 U	< 50 U
Acetone		< 50 U	< 50 U	< 50 U	< 100 U	< 100 U	< 50 U	< 50 U
Benzene		< 0.7 U	< 0.7 U	< 0.7 U	< 1.4 U	< 1.4 U	< 0.7 U	< 0.7 U
Bromodichloromethane		< 5 U	< 5 U	< 5 U	< 10 U	< 10 U	< 5 U	< 5 U
Bromoform		< 5 U	< 5 U	< 5 U	< 10 U	< 10 U	< 5 U	< 5 U
Bromomethane		< 5 U	< 5 U	< 5 U	< 10 U	< 10 U	< 5 U	< 5 U
Carbon Disulfide		< 5 U	< 5 U	< 5 U	< 10 U	< 10 U	< 5 U	< 5 U
Carbon tetrachloride		< 5 U	< 5 U	< 5 U	< 10 U	< 10 U	< 5 U	< 5 U
Chlorobenzene		< 5 U	< 5 U	< 5 U	< 10 U	< 10 U	< 5 U	< 5 U
Chlorodifluoromethane (Freon 22)		< 5 U	0.4 J	0.4 J	230	230	100	< 5 U
Chloroethane		< 5 U	< 5 U	< 5 U	< 10 U	< 10 U	< 5 U	< 5 U
Chloroform		< 5 U	1.9 J	1.9 J	5.3 J	< 10 U	2.4 J	< 5 U
Chloromethane		< 5 U	< 5 U	< 5 U	< 10 U	< 10 U	< 5 U	< 5 U
cis 1,2-dichloroethene		0.37 J	200	190 D	17	< 10 U	54	< 5 U
cis 1,3-dichloropropene		< 5 U	< 5 U	< 5 U	< 10 U	< 10 U	< 5 U	< 5 U
Dibromochloromethane		< 5 U	< 5 U	< 5 U	< 10 U	< 10 U	< 5 U	< 5 U
Dichlorodifluoromethane (Freon 12)		< 5 U	< 5 U	< 5 U	< 10 U	< 10 U	< 5 U	< 5 U
Ethylbenzene		< 5 U	3.3 J	3.4 J	< 10 U	< 10 U	0.84 J	< 5 U
Methyl tert-Butyl Ether		< 5 U	< 5 U	< 5 U	< 10 U	< 10 U	< 5 U	< 5 U
Methylene Chloride		< 5 U	< 5 U	< 5 U	< 10 U	< 10 U	< 5 U	< 5 U
Styrene		< 5 U	< 5 U	< 5 U	< 10 U	< 10 U	< 5 U	< 5 U
Tetrachloroethene		< 5 U	0.36 J	0.3 J	< 10 U	1 J	0.34 J	< 5 U
Toluene		< 5 U	96	94	< 10 U	< 10 U	23	< 5 U
trans 1,2-dichloroethene		< 5 U	0.26 J	< 5 U	< 10 U	< 10 U	< 5 U	< 5 U
trans 1,3-dichloropropene		< 5 U	< 5 U	< 5 U	< 10 U	< 10 U	< 5 U	< 5 U
Trichloroethylene		0.95 J	20	19	5.3 J	0.76 J	7	< 5 U
Trichlorofluoromethane (CFC-11)		< 5 U	< 5 U	< 5 U	< 10 U	< 10 U	< 5 U	< 5 U
Trichlorotrifluoroethane (Freon 113)		< 5 U	< 5 U	< 5 U	< 10 U	< 10 U	< 5 U	< 5 U
Vinyl Chloride		< 2 U	61	59	0.48 J	< 4 U	15	< 2 U
Xylene-o		< 5 U	2.7 J	2.9 J	< 10 U	< 10 U	0.71 J	< 5 U
Xylenes - m,p		< 5 U	5.8	5.8	< 10 U	< 10 U	1.2 J	< 5 U
Subtotal VOCs ⁽⁴⁾		1.3	395	380	258	232	205	0.0
Tentatively Identified Compounds		ND	ND	ND	ND	ND	ND	ND
Subtotal TICs ⁽⁵⁾		0	0	0	0	0	0	0
Total VOCs ⁽⁶⁾		1.3	395	380	258	232	205	0

See notes on last page.

Table B-2. Water Sample Analytical Results - October 1, 2012, Groundwater Interim Remedial Measure, Operable Unit 3
(Former Grumman Settling Ponds), Bethpage, New York. ^(1,2,3)

COMPOUND (ug/L)	Sample ID: Sample Location: Sample Date:	WSP-01 RW-1 10/1/2012	WSP-02 RW-2 10/1/2012	WSP-02 dup. RW-2 10/1/2012	WSP-03 RW-3 10/1/2012	WSP-04 RW-4 10/1/2012	WSP-05 Influent 10/1/2012	WSP-07 Effluent 10/1/2012
Metals								
Cadmium (Dissolved)		< 5 U	< 5 U	--	< 5 U	< 5 U	< 5 U	< 5 U
Cadmium (Total)		< 5 U	< 5 U	--	< 5 U	< 5 U	< 5 U	< 5 U
Chromium (Dissolved)		23	< 10 U	--	< 10 U	< 10 U	< 10 U	< 10 U
Chromium (Total)		23	< 10 U	--	< 10 U	< 10 U	< 10 U	< 10 U
Iron (Dissolved)		< 100 U	780	--	< 100 U	< 100 U	200	170
Iron (Total)		< 100 U	1,020	--	280	< 100 U	400	430
Manganese (Dissolved)		--	--	--	--	--	--	--
Manganese (Total)		--	--	--	--	--	--	--
Mercury (Dissolved)		--	--	--	--	--	--	--
Mercury (Total)		--	--	--	--	--	--	< 0.2 U

Notes:

- (1) Samples collected by ARCADIS on the dates shown and submitted to Columbia Analytical Services, Inc. for VOC analyses using New York State Department of Environmental Conservation ASP 2000 Method OLM 4.3 and metals using USEPA Method 6010, except for mercury, which was analyzed using USEPA Method 7470.
- (2) Refer to Figure 3 of this OM&M Report for schematic sample locations.
- (3) Results validated following protocols specified in the Sampling and Analysis Plan (Appendix A) of the Groundwater OM&M Manual (ARCADIS 2009).
- (4) "Subtotal VOCs" represents the sum of individual concentrations of VOCs detected. Values shown have been rounded to the nearest whole number.
- (5) "Subtotal TICs" represents the sum of individual TICs detected. Values shown have been rounded to the nearest whole number.
- (6) "Total VOCs" represent the sum of VOCs and TICs detected. Values shown have been rounded to the nearest whole number.

Acronyms\Key:

Bold value indicates a detection.

- D Compound reported from the diluted analyses as the concentration in the initial analysis was outside the calibration range.
- dup. Duplicate.
- J Estimated value.
- ND TIC not detected.
- OM&M Operation, maintenance and monitoring.
- TIC Tentatively identified compound.
- USEPA United States Environmental Protection Agency.
- VOC Volatile organic compound.
- ug/L Micrograms per liter.
- Not analyzed.
- < 5 U Compound not detected above its laboratory quantification limit.
- B Compound found in an associated blank sample, presence may be suspect
- UB Compound considered non-detect due to associated blank contamination.

Table B-3. Water Sample Analytical Results - November 12, 2012, Groundwater Interim Remedial Measure, Operable Unit 3
(Former Grumman Settling Ponds), Bethpage, New York. ^(1,2,3)

COMPOUND (ug/L)	Sample ID: Sample Location: Sample Date:	WSP-02 RW-2 11/12/2012	WSP-03 RW-3 11/12/2012	WSP-05 Influent 11/12/2012	WSP-07 Effluent 11/12/2012
<u>Volatile Organic Compounds</u>					
1,1,1-Trichloroethane		--	--	< 5 U	< 5 U
1,1,2,2-Tetrachloroethane		--	--	< 5 U	< 5 U
1,1,2-Trichloroethane		--	--	< 5 U	< 5 U
1,1-Dichloroethane		--	--	0.51 J	< 5 U
1,1-Dichloroethene		--	--	0.26 J	< 5 U
1,2-Dichloroethane		--	--	< 5 U	< 5 U
1,2-Dichloropropane		--	--	< 5 U	< 5 U
2-Butanone (MEK)		--	--	< 50 U	< 50 U
2-Hexanone (MBK)		--	--	< 50 U	< 50 U
4-methyl-2-pentanone (MIK)		--	--	< 50 U	< 50 U
Acetone		--	--	< 50 U	< 50 U
Benzene		--	--	< 0.7 U	< 0.7 U
Bromodichloromethane		--	--	< 5 U	< 5 U
Bromoform		--	--	< 5 U	< 5 U
Bromomethane		--	--	< 5 U	< 5 U
Carbon Disulfide		--	--	< 5 U	< 5 U
Carbon tetrachloride		--	--	< 5 U	< 5 U
Chlorobenzene		--	--	< 5 U	< 5 U
Chlorodifluoromethane (Freon 22)		--	--	110	< 5 U
Chloroethane		--	--	< 5 U	< 5 U
Chloroform		--	--	2.7 J	< 5 U
Chloromethane		--	--	< 5 U	< 5 U
cis 1,2-dichloroethene		--	--	47	< 5 U
cis 1,3-dichloropropene		--	--	< 5 U	< 5 U
Dibromochloromethane		--	--	< 5 U	< 5 U
Dichlorodifluoromethane (Freon 12)		--	--	< 5 U	< 5 U
Ethylbenzene		--	--	0.78 J	< 5 U
Methyl tert-Butyl Ether		--	--	< 5 U	< 5 U
Methylene Chloride		--	--	< 5 U	< 5 U
Styrene		--	--	< 5 U	< 5 U
Tetrachloroethene		--	--	0.31 J	< 5 U
Toluene		--	--	26	< 5 U
trans 1,2-dichloroethene		--	--	< 5 U	< 5 U
trans 1,3-dichloropropene		--	--	< 5 U	< 5 U
Trichloroethylene		--	--	6.8	< 5 U
Trichlorofluoromethane (CFC-11)		--	--	< 5 U	< 5 U
Trichlorotrifluoroethane (Freon 113)		--	--	< 5 U	< 5 U
Vinyl Chloride		--	--	17	< 2 U
Xylene-o		--	--	0.84 J	< 5 U
Xylenes - m,p		--	--	1.4 J	< 5 U
Subtotal VOCs ⁽⁴⁾		--	--	214	0
Tentatively Identified Compounds		--	--	ND	ND
Subtotal TICs ⁽⁵⁾		--	--	0.0	0.0
Total VOCs ⁽⁶⁾		--	--	214	0

See notes on last page.

Table B-3. Water Sample Analytical Results - November 12, 2012, Groundwater Interim Remedial Measure, Operable Unit 3 (Former Grumman Settling Ponds), Bethpage, New York. ^(1,2,3)

COMPOUND (ug/L)	Sample ID: Sample Location: Sample Date:	WSP-02 RW-2 11/12/2012	WSP-03 RW-3 11/12/2012	WSP-05 Influent 11/12/2012	WSP-07 Effluent 11/12/2012
Metals					
Cadmium (Dissolved)		--	--	--	--
Cadmium (Total)		--	--	--	--
Chromium (Dissolved)		--	--	--	--
Chromium (Total)		--	--	--	--
Iron (Dissolved)		610	100	180	140
Iron (Total)		750	220	330	270
Manganese (Dissolved)		--	--	--	--
Manganese (Total)		--	--	--	--
Mercury (Dissolved)		--	--	--	--
Mercury (Total)		--	--	--	< 0.2 U

Notes:

- (1) Samples collected by ARCADIS on the dates shown and submitted to Columbia Analytical Services, Inc. for VOC analyses using New York State Department of Environmental Conservation ASP 2000 Method OLM 4.3 and metals using USEPA Method 6010, except for mercury, which was analyzed using USEPA Method 7470.
- (2) Refer to Figure 3 of this OM&M Report for schematic sample locations.
- (3) Results validated following protocols specified in the Sampling and Analysis Plan (Appendix A) of the Groundwater OM&M Manual (ARCADIS 2009).
- (4) "Subtotal VOCs" represents the sum of individual concentrations of VOCs detected. Values shown have been rounded to the nearest whole number.
- (5) "Subtotal TICs" represents the sum of individual TICs detected. Values shown have been rounded to the nearest whole number.
- (6) "Total VOCs" represent the sum of VOCs and TICs detected. Values shown have been rounded to the nearest whole number.

Acronyms\Key:

Bold value indicates a detection.

- D Compound reported from the diluted analyses as the concentration in the initial analysis was outside the calibration range.
- dup. Duplicate.
- J Estimated value.
- ND TIC not detected.
- OM&M Operation, maintenance and monitoring.
- TIC Tentatively identified compound.
- USEPA United States Environmental Protection Agency.
- VOC Volatile organic compound.
- ug/L Micrograms per liter.
- Not analyzed.
- < 5 U Compound not detected above its laboratory quantification limit.
- B Compound found in an associated blank sample, presence may be suspect
- UB Compound considered non-detect due to associated blank contamination.

Table B-4. Water Sample Analytical Results - December 3, 2012, Groundwater Interim Remedial Measure, Operable Unit 3
(Former Grumman Settling Ponds), Bethpage, New York. ^(1,2,3)

COMPOUND (ug/L)	Sample ID: Sample Location: Sample Date:	WSP-02 RW-2 12/3/2012	WSP-03 RW-3 12/3/2012	WSP-05 Influent 12/3/2012	WSP-05 dup. Influent 12/3/2012	WSP-07 Effluent 12/3/2012
<u>Volatile Organic Compounds</u>						
1,1,1-Trichloroethane		--	--	< 5 U	< 5 U	< 5 U
1,1,2,2-Tetrachloroethane		--	--	< 5 U	< 5 U	< 5 U
1,1,2-Trichloroethane		--	--	< 5 U	< 5 U	< 5 U
1,1-Dichloroethane		--	--	0.53 J	0.65 J	< 5 U
1,1-Dichloroethene		--	--	0.34 J	0.29 J	< 5 U
1,2-Dichloroethane		--	--	< 5 U	< 5 U	< 5 U
1,2-Dichloropropane		--	--	< 5 U	< 5 U	< 5 U
2-Butanone (MEK)		--	--	< 50 U	< 50 U	< 50 U
2-Hexanone (MBK)		--	--	< 50 U	< 50 U	< 50 U
4-methyl-2-pentanone (MIK)		--	--	< 50 U	< 50 U	< 50 U
Acetone		--	--	< 50 U	< 50 U	< 50 U
Benzene		--	--	< 0.7 U	< 0.7 U	< 0.7 U
Bromodichloromethane		--	--	< 5 U	< 5 U	< 5 U
Bromoform		--	--	< 5 U	< 5 U	< 5 U
Bromomethane		--	--	< 5 U	< 5 U	< 5 U
Carbon Disulfide		--	--	< 5 U	< 5 U	< 5 U
Carbon tetrachloride		--	--	< 5 U	< 5 U	< 5 U
Chlorobenzene		--	--	< 5 U	< 5 U	< 5 U
Chlorodifluoromethane (Freon 22)		--	--	100	100	< 5 U
Chloroethane		--	--	< 5 U	< 5 U	< 5 U
Chloroform		--	--	2.6 J	2.9 J	< 5 U
Chloromethane		--	--	< 5 U	< 5 U	< 5 U
cis 1,2-dichloroethene		--	--	44	49	< 5 U
cis 1,3-dichloropropene		--	--	< 5 U	< 5 U	< 5 U
Dibromochloromethane		--	--	< 5 U	< 5 U	< 5 U
Dichlorodifluoromethane (Freon 12)		--	--	< 5 U	< 5 U	< 5 U
Ethylbenzene		--	--	0.62 J	0.59 J	< 5 U
Methyl tert-Butyl Ether		--	--	< 5 U	< 5 U	< 5 U
Methylene Chloride		--	--	< 5 U	< 5 U	< 5 U
Styrene		--	--	< 5 U	< 5 U	< 5 U
Tetrachloroethene		--	--	0.38 J	0.25 J	< 5 U
Toluene		--	--	21	21	< 5 U
trans 1,2-dichloroethene		--	--	< 5 U	< 5 U	< 5 U
trans 1,3-dichloropropene		--	--	< 5 U	< 5 U	< 5 U
Trichloroethylene		--	--	6.3	6.7	< 5 U
Trichlorofluoromethane (CFC-11)		--	--	< 5 U	< 5 U	< 5 U
Trichlorotrifluoroethane (Freon 113)		--	--	< 5 U	< 5 U	< 5 U
Vinyl Chloride		--	--	17	18	< 2 U
Xylene-o		--	--	0.75 J	0.78 J	< 5 U
Xylenes - m,p		--	--	1.1 J	1.3 J	< 5 U
Subtotal VOCs ⁽⁴⁾		--	--	195	201	0.0
Tentatively Identified Compounds		--	--	ND	ND	ND
Subtotal TICs ⁽⁵⁾		--	--	0.0	0.0	0.0
Total VOCs ⁽⁶⁾		--	--	195	201	0

See notes on last page.

Table B-4. Water Sample Analytical Results - December 3, 2012, Groundwater Interim Remedial Measure, Operable Unit 3 (Former Grumman Settling Ponds), Bethpage, New York. ^(1,2,3)

COMPOUND (ug/L)	Sample ID: Sample Location: Sample Date:	WSP-02 RW-2 12/3/2012	WSP-03 RW-3 12/3/2012	WSP-05 Influent 12/3/2012	WSP-05 dup. Influent 12/3/2012	WSP-07 Effluent 12/3/2012
Metals						
Cadmium (Dissolved)		--	--	--	--	--
Cadmium (Total)		--	--	--	--	--
Chromium (Dissolved)		--	--	--	--	--
Chromium (Total)		--	--	--	--	--
Iron (Dissolved)		540	< 100 U	120	--	< 100 U
Iron (Total)		670	210	840	--	230
Manganese (Dissolved)		--	--	--	--	--
Manganese (Total)		--	--	--	--	--
Mercury (Dissolved)		--	--	--	--	--
Mercury (Total)		--	--	--	--	< 0.2 U

Notes:

- (1) Samples collected by ARCADIS on the dates shown and submitted to Columbia Analytical Services, Inc. for VOC analyses using New York State Department of Environmental Conservation ASP 2000 Method OLM 4.3 and metals using USEPA Method 6010, except for mercury, which was analyzed using USEPA Method 7470.
- (2) Refer to Figure 3 of this OM&M Report for schematic sample locations.
- (3) Results validated following protocols specified in the Sampling and Analysis Plan (Appendix A) of the Groundwater OM&M Manual (ARCADIS 2009).
- (4) "Subtotal VOCs" represents the sum of individual concentrations of VOCs detected. Values shown have been rounded to the nearest whole number.
- (5) "Subtotal TICs" represents the sum of individual TICs detected. Values shown have been rounded to the nearest whole number.
- (6) "Total VOCs" represent the sum of VOCs and TICs detected. Values shown have been rounded to the nearest whole number.

Acronyms\Key:

Bold value indicates a detection.

- D Compound reported from the diluted analyses as the concentration in the initial analysis was outside the calibration range.
- dup. Duplicate.
- J Estimated value.
- ND TIC not detected.
- OM&M Operation, maintenance and monitoring.
- TIC Tentatively identified compound.
- USEPA United States Environmental Protection Agency.
- VOC Volatile organic compound.
- ug/L Micrograms per liter.
- Not analyzed.
- < 5 U Compound not detected above its laboratory quantification limit.
- B Compound found in an associated blank sample, presence may be suspect
- UB Compound considered non-detect due to associated blank contamination.



Appendix C

Vapor Sample Analytical Results

Table C-1. Vapor Sample Analytical Results - October 3, 2012, Groundwater Interim Remedial Measure, Operable Unit 3
 (Former Grumman Settling Ponds), Bethpage, New York. ^(1,2,3)

COMPOUND (ug/m ³)	Location ID: Sample Location Sample Date:	VSP-1 Influent 10/3/2012	VSP-2 VPGAC Mid-Train 10/3/2012	VSP-05 Effluent 10/3/2012
<u>Volatile Organic Compounds</u>				
1,1,1-Trichloroethane		< 5 U	< 1.8 U	< 0.82 U
1,1,2,2-Tetrachloroethane		< 5 U	< 1.8 U	< 0.82 U
1,1,2-Trichloroethane		< 5 U	< 1.8 U	< 0.82 U
1,1-Dichloroethane		8.9	9	1.1
1,1-Dichloroethene		< 5 U	8.4	< 0.82 U
1,2-Dichloroethane		< 5 U	< 1.8 U	< 0.82 U
1,2-Dichloropropane		< 5 U	< 1.8 U	< 0.82 U
1,3-butadiene		< 5 U	< 1.8 U	< 0.82 U
1-Chloro-1,1-difluoroethane (CFC 142b)		< 5 U	< 1.8 U	< 0.82 U
2-Butanone (MEK)		< 50 U	< 18 U	< 8.2 U
2-Hexanone (MBK)		< 5 U	< 1.8 U	< 0.82 U
4-methyl-2-pentanone (MIK)		< 5 U	< 1.8 U	< 0.82 U
Acetone		< 50 U	20	56
Benzene		< 5 U	< 1.8 U	< 0.82 U
Bromodichloromethane		< 5 U	< 1.8 U	< 0.82 U
Bromoform		< 5 U	< 1.8 U	< 0.82 U
Bromomethane		< 5 U	< 1.8 U	< 0.82 U
Carbon Disulfide		< 50 U	< 18 U	< 8.2 U
Carbon tetrachloride		< 5 U	< 1.8 U	< 0.82 U
Chlorobenzene		< 5 U	< 1.8 U	< 0.82 U
Chlorodifluoromethane (Freon 22)		1,000 D	1,000 D	1,000 D
Chloroethane		< 5 U	< 1.8 U	< 0.82 U
Chloroform		39	9.7	3.9
Chloromethane		< 5 U	< 1.8 U	< 0.82 U
cis 1,2-dichloroethene		900	830 D	9.6
cis 1,3-dichloropropene		< 5 U	< 1.8 U	< 0.82 U
Dibromochloromethane		< 5 U	< 1.8 U	< 0.82 U
Dichlorodifluoromethane (Freon 12)		< 5 U	3.1	3.1
Ethylbenzene		15	< 1.8 U	0.84
Methyl tert-Butyl Ether		< 5 U	< 1.8 U	< 0.82 U
Methylene Chloride		< 5 U	< 1.8 U	< 0.82 U
Styrene		< 5 U	< 1.8 U	< 0.82 U
Tetrachloroethene		5.3	< 1.8 U	< 0.82 U
Toluene		400	< 1.8 U	37
trans 1,2-dichloroethene		< 5 U	< 1.8 U	< 0.82 U
trans1,3-dichloropropene		< 5 U	< 1.8 U	< 0.82 U
Trichloroethylene		110	< 1.8 U	3.1
Trichlorofluoromethane (CFC-11)		< 5 U	2	1.9
Trichlorotrifluoroethane (Freon 113)		< 5 U	< 1.8 U	< 0.82 U
Vinyl Chloride		210	200	7.9
Xylene-o		12	< 1.8 U	0.91
Xylenes - m,p		27	< 3.5 U	1.9
Subtotal VOCs ⁽⁴⁾		2,727	2,082	1,127

See notes on last page.

Table C-1. Vapor Sample Analytical Results - October 3, 2012, Groundwater Interim Remedial Measure, Operable Unit 3
 (Former Grumman Settling Ponds), Bethpage, New York. ^(1,2,3)

COMPOUND (ug/m ³)	Location ID: Sample Location Sample Date:	VSP-1 Influent 10/3/2012	VSP-2 VPGAC Mid-Train 10/3/2012	VSP-05 Effluent 10/3/2012
<u>Tentatively Identified Compounds</u>				
2,5-Hexanedione		--	9 JN	--
2,6-Dimethylundecane		--	--	110 JN
2-Methyl-trans-Decalin		--	--	240 JN
2-Methylundecane		--	--	460 JN
2-Phenyl-2-Propanol		150 JN	96 JN	--
3-Methylundecane		--	--	360 JN
4-Methylundecane		--	--	220 JN
Acetophenone		22 JN	20 JN	--
Dodecane		--	--	110 JN
Hexamethyl Cyclotrisloxane		--	500 JN	--
METHYL DISULFIDE		550 JN	--	--
Methylpentylcyclohexane Isomers		--	--	160 JN
Trimethylsilanol		--	30 JN	--
Undecane		--	--	230 JN
Unidentified Siloxane		--	25 JN	--
Unknown C ₁₂ H ₂₆ Branched Alkane with the 1st highest Conc.		--	--	590 JN
Unknown C ₁₂ H ₂₆ Branched Alkane with the 2nd highest Conc.		--	--	230 JN
Unknown C ₁₂ H ₂₆ Branched Alkane with the 3rd highest Conc.		--	--	190 JN
Unknown C ₁₂ H ₂₆ Branched Alkane with the 4rd highest Conc.		--	--	84 JN
Unknown C ₁₂ H ₂₆ Branched Alkane with the 5th highest Conc.		--	--	75 JN
Unknown with the 1st highest Conc.		--	260 JN	140 JN
Unknown with the 2nd highest Conc.		--	--	93 JN
Unknown with the 3rd highest Conc.		--	--	93 JN
Unknown with the 4th highest Conc.		--	--	86 JN
Unknown with the 5th highest Conc.		--	--	66 JN
Unknown with the 6th highest Conc.		--	--	54 JN
Unknown with the 7th highest Conc.		--	--	52 JN
Subtotal TICs ⁽⁵⁾		722	940	3,643
Total VOCs ⁽⁶⁾		3,449	3,022	4,770

See notes on last page.

Table C-1. Vapor Sample Analytical Results - October 3, 2012, Groundwater Interim Remedial Measure, Operable Unit 3
(Former Grumman Settling Ponds), Bethpage, New York. ^(1,2,3)

Notes:

- (1) Samples collected by ARCADIS on the dates shown and submitted to Columbia Analytical Services, Inc. for VOC analyses per Modified USEPA Method TO-15.
- (2) Refer to Figure 3 of this OM&M Report for schematic sample locations.
- (3) Results validated following protocols specified in the Sampling and Analysis Plan (Appendix A) of the Groundwater OM&M (ARCADIS 2009).
- (4) "Subtotal VOCs" represents the sum of individual concentrations of VOCs detected. Values shown have been rounded to the nearest whole number.
- (5) "Subtotal TICs" represents the sum of individual top 20 TICs detected. Values shown have been rounded to the nearest whole number.
- (6) "Total VOCs" represent the sum of VOCs and TICs detected. Values shown have been rounded to the nearest whole number.

Acronyms\Key:

Bold value indicates a detection.

D	Concentration is based on a diluted sample analysis.
JN	Compound tentatively identified, concentration is estimated.
OM&M	Operation, maintenance and monitoring.
TIC	Tentatively identified compound.
USEPA	United States Environmental Protection Agency.
VOC	Volatile organic compound.
ug/m ³	Micrograms per cubic meter.
< 9.2 U	Compound not detected above its laboratory quantification limit.
--	TIC not detected.

Table C-2. Vapor Sample Analytical Results - December 3, 2012, Groundwater Interim Remedial Measure, Operable Unit 3
 (Former Grumman Settling Ponds), Bethpage, New York. ^(1,2,3)

COMPOUND (ug/m ³)	Location ID: Sample Location Sample Date:	VSP-1 Influent 12/3/2012	VSP-3 VPGAC Effluent 12/3/2012	VSP-4 PPZ Mid-Train 12/3/2012	VSP-05 Effluent 12/3/2012
<u>Volatile Organic Compounds</u>					
1,1,1-Trichloroethane		2.4	< 0.73 U	< 0.68 U	< 0.73 U
1,1,1,2-Tetrachloroethane		< 0.79 U	< 0.73 U	< 0.68 U	< 0.73 U
1,1,2-Trichloroethane		< 0.79 U	< 0.73 U	< 0.68 U	< 0.73 U
1,1-Dichloroethane		11	0.77	1.9	1.8
1,1-Dichloroethene		4.6	2.9	1.9	1.0
1,2-Dichloroethane		< 0.79 U	< 0.73 U	< 0.68 U	< 0.73 U
1,2-Dichloropropane		1.2	< 0.73 U	< 0.68 U	< 0.73 U
1,3-butadiene		0.88	< 0.73 U	< 0.68 U	< 0.73 U
1-Chloro-1,1-difluoroethane (CFC 142b)		< 0.79 U	< 0.73 U	< 0.68 U	< 0.73 U
2-Butanone (MEK)		< 7.9 U	17	25	< 7.3 U
2-Hexanone (MBK)		< 0.79 U	< 0.73 U	1.7	< 0.73 U
4-methyl-2-pentanone (MIK)		< 0.79 U	< 0.73 U	< 0.68 U	< 0.73 U
Acetone		8.7	450	2,200 D	98
Benzene		4.8	4.4	0.92	1.9
Bromodichloromethane		0.83	< 0.73 U	< 0.68 U	< 0.73 U
Bromoform		< 0.79 U	< 0.73 U	< 0.68 U	< 0.73 U
Bromomethane		< 0.79 U	< 0.73 U	< 0.68 U	< 0.73 U
Carbon Disulfide		< 7.9 U	< 7.3 U	< 6.8 U	< 7.3 U
Carbon tetrachloride		< 0.79 U	< 0.73 U	< 0.68 U	< 0.73 U
Chlorobenzene		< 0.79 U	< 0.73 U	< 0.68 U	< 0.73 U
Chlorodifluoromethane (Freon 22)		1,100 D	1,100 D	1,100 D	1,100 D
Chloroethane		< 0.79 U	< 0.73 U	< 0.68 U	< 0.73 U
Chloroform		50	< 0.73 U	5	5.6
Chloromethane		< 0.79 U	< 0.73 U	< 0.68 U	0.77
cis 1,2-dichloroethene		1,000 D	29	100	25
cis 1,3-dichloropropene		< 0.79 U	< 0.73 U	< 0.68 U	< 0.73 U
Dibromochloromethane		< 0.79 U	< 0.73 U	< 0.68 U	< 0.73 U
Dichlorodifluoromethane (Freon 12)		3.6	3.5	3.7	3.5
Ethylbenzene		14	< 0.73 U	1.3	0.96
Methyl tert-Butyl Ether		1.3	< 0.73 U	< 0.68 U	< 0.73 U
Methylene Chloride		< 0.79 U	< 0.73 U	0.69	< 0.73 U
Styrene		< 0.79 U	< 0.73 U	< 0.68 U	< 0.73 U
Tetrachloroethene		5.9	< 0.73 U	< 0.68 U	< 0.73 U
Toluene		420 D	< 0.73 U	39.0	38
trans 1,2-dichloroethene		1.3	< 0.73 U	< 0.68 U	< 0.73 U
trans 1,3-dichloropropene		< 0.79 U	< 0.73 U	< 0.68 U	< 0.73 U
Trichloroethylene		110	< 0.73 U	9.1	4.3
Trichlorofluoromethane (CFC-11)		1.9	3.1	3.1	3.0
Trichlorotrifluoroethane (Freon 113)		3.5	< 0.73 U	< 0.68 U	< 0.73 U
Vinyl Chloride		310 D	290 D	170 D	23
Xylene-o		16	< 0.73 U	1.3	1.5
Xylenes - m,p		32	< 1.5 U	3.1	2.8
		3,104	1,901	3,668	1,311
Subtotal VOCs ⁽⁴⁾					

See notes on last page.

Table C-2. Vapor Sample Analytical Results - December 3, 2012, Groundwater Interim Remedial Measure, Operable Unit 3
 (Former Grumman Settling Ponds), Bethpage, New York. ^(1,2,3)

COMPOUND (ug/m ³)	Location ID: Sample Location Sample Date:	VSP-1 Influent 12/3/2012	VSP-2 /PGAC Mid-Trai 12/3/2012	VSP-4 PPZ Mid-Train 12/3/2012	VSP-05 Effluent 12/3/2012
Tentatively Identified Compounds					
2,2,4-trimethyl-1,3-Dioxolane		--	--	15 JN	--
2,2,4-Trimethylpentane		5.1 JN	--	--	--
2-Butoxyethanol		--	43 JN	--	--
2-Ethyl- 1-Hexanol		9.2 JN	--	--	--
2-Methyl-1-Propene		3.8 JN	--	--	--
2-Methylbutane		21 JN	--	--	--
2-Methyl-cis-decalin		--	--	--	66 JN
2-Methylpentane		7 JN	--	--	--
2-Methyl-trans-Decalin		--	--	--	140 JN
2-Methylundecane		--	--	--	180 JN
2-Phenyl-2-Propanol		19 JN	480 JN	600 JN	48 JN
3-Methylpentane		3.6 JN	--	--	--
3-Methylundecane		--	--	--	160 JN
3-Penten-2-one		--	6.1 JN	53 JN	--
4-Methylundecane		--	--	--	110 JN
5-Methylundecane		--	--	--	140 JN
Acetaldehyde		--	8 JN	26 JN	--
ACETIC ACID		--	--	190 JN	--
Acetophenone		7.7 JN	200 JN	130 JN	55 JN
Alpha-Methyl Styrene		--	83 JN	80 JN	--
BUTANE		9.2 JN	--	--	--
Butyl-Cyclohexane		--	--	--	120 JN
Dimethylsilanediol		--	22 JN	--	--
Dipropylene glycol		--	--	13 JN	--
Fluorotrimethylsilane		--	3.4 JN	--	--
Hexamethyl Cyclotrisloxane		4.1 JN	200 JN	25 JN	78 JN
Isobutanol		--	3.8 JN	--	--
Isobutane		5.4 JN	--	--	--
Methylcyclohexane		6.6 JN	--	--	--
Pentane		8.8 JN	--	--	--
Phenol		--	5.7 JN	--	--
Propylene Glycol		--	100 JN	650 JN	--
Trimethylsilanol		--	87 JN	--	--
Undecane		--	--	--	87 JN
Unidentified Oxygenated Compound with Highest Conc.		--	--	38 JN	--
Unidentified Oxygenated Compound with Highest Conc.		--	--	22 JN	--
Unidentified Siloxane		--	14 JN	--	--
Unknown C12H26 Branched Alkane with the 1st highest Conc.		--	--	14 JN	100 JN
Unknown C12H26 Branched Alkane with the 2nd highest Conc.		--	--	14 JN	88 JN
Unknown C12H26 Branched Alkane with the 3rd highest Conc.		--	--	--	45 JN
Unknown C12H26 Branched Alkane with the 4rd highest Conc.		--	--	--	37 JN
Unknown C13H28 Branched Alkane with the 1st highest Conc.		--	--	--	50 JN
Unknown with the 1st highest Conc.		3.5 JN	75 JN	150 JN	77 JN
Unknown with the 2nd highest Conc.		--	21 JN	44 JN	52 JN
Unknown with the 3rd highest Conc.		--	18 JN	15 JN	50 JN
Unknown with the 4th highest Conc.		--	9.3 JN	15 JN	35 JN
Unknown with the 5th highest Conc.		--	4.4 JN	14 JN	--
Unknown with the 6th highest Conc.		--	3.9 JN	--	--
Subtotal TICs ⁽⁵⁾		114	1,388	2,132	1,718
Total VOCs ⁽⁶⁾		3,218	3,288	5,800	3,029

See notes on last page.

Table C-2. Vapor Sample Analytical Results - December 3, 2012, Groundwater Interim Remedial Measure, Operable Unit 3
(Former Grumman Settling Ponds), Bethpage, New York. ^(1,2,3)

Notes:

- (1) Samples collected by ARCADIS on the dates shown and submitted to Columbia Analytical Services, Inc. for VOC analyses per Modified USEPA Method TO-15.
- (2) Refer to Figure 3 of this OM&M Report for schematic sample locations.
- (3) Results validated following protocols specified in the Sampling and Analysis Plan (Appendix A) of the Groundwater OM&M (ARCADIS 2009).
- (4) "Subtotal VOCs" represents the sum of individual concentrations of VOCs detected. Values shown have been rounded to the nearest whole number.
- (5) "Subtotal TICs" represents the sum of individual top 20 TICs detected. Values shown have been rounded to the nearest whole number.
- (6) "Total VOCs" represent the sum of VOCs and TICs detected. Values shown have been rounded to the nearest whole number.

Acronyms\Key:

Bold value indicates a detection.

D	Concentration is based on a diluted sample analysis.
JN	Compound tentatively identified, concentration is estimated.
OM&M	Operation, maintenance and monitoring.
TIC	Tentatively identified compound.
USEPA	United States Environmental Protection Agency.
VOC	Volatile organic compound.
ug/m ³	Micrograms per cubic meter.
< 9.2 U	Compound not detected above its laboratory quantification limit.
--	TIC not detected.



Appendix D

Air Discharge Quality Evaluation

Table D-1. Annual Summary of SCREEN3 Model Input and Outputs, Groundwater Interim Remedial Measure, Operable Unit 3 (Former Grumman Settling Ponds), Bethpage, New York.

Parameters	Date Sampled:	01/09/12	04/03/12	07/05/12	10/03/12	12/03/12
SCREEN3 Model Input						
Source Type		Point	Point	Point	Point	Point
Emission Rate (g/s)		1	1	1	1	1
Stack Height (ft)		13.5	13.5	13.5	13.5	13.5
Stack Height (m)		4.1	4.1	4.1	4.1	4.1
Stack Inside Diameter (m)		0.36	0.36	0.36	0.36	0.36
Air Flow Rate (scfm) ^{(1),(9)}		2,049	2,079	2,020	1,813	1,962
Air Flow Rate (acfm @ stack temp) ⁽²⁾		2,057	2,087	2,053	1,839	1,974
Stack Gas Exit Temperature (K) ^{(1),(9),(10)}		296	296	299	299	296
Ambient Air Temperature (K) ⁽³⁾		278	284	302	294	284
Receptor Height (m) ⁽⁴⁾		1.5	1.5	1.5	1.5	1.5
Urban/Rural		Urban	Urban	Urban	Urban	Urban
Building Height (m)		2.6	2.6	2.6	2.6	2.6
Min Horizontal Bldg Dim (m)		7.9	7.9	7.9	7.9	7.9
Max Horizontal Bldg Dim (m)		9.8	9.8	9.8	9.8	9.8
Consider Bldg Downwash?		Yes	Yes	Yes	Yes	Yes
Simple/Complex Terrain Above Stack		Simple	Simple	Simple	Simple	Simple
Simple/Complex Terrain Above Stack Base		Simple	Simple	Simple	Simple	Simple
Meteorology		Full	Full	Full	Full	Full
Automated Distances Array		Yes	Yes	Yes	Yes	Yes
Terrain Height Above Stack Base		0	0	0	0	0
SCREEN3 Model Output						
1-HR Max Concentration at Receptor Height ($\mu\text{g}/\text{m}^3$) ⁽⁵⁾		1,961	1,936	1,950	2,229	2,059
Annualization Factor ⁽⁶⁾		0.08	0.08	0.08	0.08	0.08
Average Annual Concentration at Receptor Height ($\mu\text{g}/\text{m}^3$) ⁽⁷⁾		156.9	154.9	156	178.3	164.7
Distance To Max Concentration (m) ⁽⁸⁾		8	8	8	8	8

See notes on last page.

Table D-1. Annual Summary of SCREEN3 Model Input and Outputs, Groundwater Interim Remedial Measure, Operable Unit 3 (Former Grumman Settling Ponds), Bethpage, New York.

Notes:

- (1) The stack air flow rate (in scfm) and temperature were measured using inline instrumentation. Values were measured at the blower effluent location.
- (2) The stack air flow rate at the stack temperature (in acfm) was calculated by dividing the stack air flow rate in scfm by the ratio of the standard temperature to the actual stack gas exit temperature.
- (3) The ambient temperature was recorded from the weather.newsday.com and/or weather underground (www.wunderground.com) websites for Islip, New York. The mean actual temperature from the website(s) was used in model calculation.
- (4) The receptor height corresponds to the average inhalation level.
- (5) SCREEN3 calculated constituent concentration at listed conditions at the specified inhalation level.
- (6) A USEPA time averaging conversion factor of 1/0.08 was used to convert the 1-hour maximum concentration output to an annual average.
- (7) Average annual constituent concentration at the receptor height was calculated by multiplying the one hour maximum concentration by the annualization factor.
- (8) SCREEN3 calculated distance to the 1-hour maximum concentration.
- (9) Stack Air Flow Rate and Exit Temperature parameter readings were recorded on October 3, 2012 at the time of October 3, 2012 air sample collection.
- (10) Mid-Train temperature was used for stack exit temperature as stack exit temperature was not recorded at the time of October 3, 2012 air sample collection.

Acronyms/Key:

$\mu\text{g}/\text{m}^3$	Micrograms per cubic meter.
acfm	Actual cubic feet per minute.
ft	Feet.
g/s	Grams per second.
K	Kelvin.
m	Meters.
scfm	Standard cubic feet per minute.
USEPA	United States Environmental Protection Agency.

Table D-2. Annual Summary of Maximum Allowable Stack Concentration Calculations, Groundwater Interim Remedial Measure, Operable Unit 3 (Former Grumman Settling Ponds), Bethpage, New York.

Compound	Actual Effluent Concentrations ⁽¹⁾ (µg/m ³)				
	01/09/12	04/03/12	07/05/12	10/03/12	12/03/12
1,1 - Dichloroethane	0	0	0.82	1.1	1.8
1,1 - Dichloroethene	0	0	0	0	1.0
Acetone	460	260	140	56	98
Chloroform	0	0	3	3.9	5.6
Ethylbenzene	0	0	0	0.84	0.96
Xylenes (o)	0	0	0	0.91	1.5
Xylenes (m,p)	0	0	0	1.9	2.8
Chloromethane	0	0	0	0	0.77
Trichloroethene	0	0	1.6	3.1	4.3
Vinyl Chloride	8.1	8.4	0	7.9	23
cis 1,2-Dichloroethene	13	13	1.9	9.6	25
Benzene	11	13	0.96	0	1.9
Toluene	30	26	27	37	38
Trichlorofluoromethane (Freon 11)	0	0	0	1.9	3.0
Dichlorodifluoromethane (Freon 12)	0	0	2.9	3.1	3.5
Chlorodifluoromethane (Freon 22)	1,600	1,800	1,000	1,000	1,100

See notes on last page.

Table D-2. Annual Summary of Maximum Allowable Stack Concentration Calculations, Groundwater Interim Remedial Measure, Operable Unit 3 (Former Grumman Settling Ponds), Bethpage, New York.

Compound	AGC ⁽²⁾ ($\mu\text{g}/\text{m}^3$)	Maximum Allowable Stack Concentration ⁽³⁾ ($\mu\text{g}/\text{m}^3$)				
		01/09/12	04/03/12	07/05/12	10/03/12	12/03/12
1,1 - Dichloroethane	0.63	4.14E+03	4.13E+03	4.17E+03	4.07E+03	4.11E+03
1,1 - Dichloroethene	70	4.60E+05	4.59E+05	4.63E+05	4.52E+05	4.56E+05
Acetone	30,000	1.97E+08	1.97E+08	1.98E+08	1.94E+08	1.96E+08
Chloroform	0.043	2.82E+02	2.82E+02	2.84E+02	2.78E+02	2.80E+02
Ethylbenzene	1,000	6.57E+06	6.55E+06	6.62E+06	6.46E+06	6.52E+06
Xylenes (o)	100	6.57E+05	6.55E+05	6.62E+05	6.46E+05	6.52E+05
Xylenes (m,p)	100	6.57E+05	6.55E+05	6.62E+05	6.46E+05	6.52E+05
Chloromethane	90	5.91E+05	5.90E+05	5.95E+05	5.82E+05	5.87E+05
Trichloroethene	0.5	3.28E+03	3.28E+03	3.31E+03	3.23E+03	3.26E+03
Vinyl Chloride	0.11	7.22E+02	7.21E+02	7.28E+02	7.11E+02	7.17E+02
cis 1,2 Dichloroethene	63	4.14E+05	4.13E+05	4.17E+05	4.07E+05	4.11E+05
Benzene	0.13	8.53E+02	8.52E+02	8.60E+02	8.40E+02	8.47E+02
Toluene	5,000	3.28E+07	3.28E+07	3.31E+07	3.23E+07	3.26E+07
Trichlorofluoromethane (Freon 11)	5,000	3.28E+07	3.28E+07	3.31E+07	3.23E+07	3.26E+07
Dichlorodifluoromethane (Freon 12)	12,000	7.88E+07	7.87E+07	7.94E+07	7.75E+07	7.82E+07
Chlorodifluoromethane (Freon 22)	50,000	3.28E+08	3.28E+08	3.31E+08	3.23E+08	3.26E+08

See notes on last page.

Table D-2. Annual Summary of Maximum Allowable Stack Concentration Calculations, Groundwater Interim Remedial Measure, Operable Unit 3 (Former Grumman Settling Ponds), Bethpage, New York.

Compound	Percent of Maximum Allowable Stack Concentration ⁽⁴⁾				
	1/9/12	04/03/12	07/05/12	10/03/12	12/03/12
1,1 - Dichloroethane	0.00%	0.00%	0.02%	0.03%	0.04%
1,1 - Dichloroethene	0.00%	0.00%	0.00%	0.00%	0.00%
Acetone	0.00%	0.00%	0.00%	0.00%	0.00%
Chloroform	0.00%	0.00%	1.09%	1.40%	2.00%
Ethylbenzene	0.00%	0.00%	0.00%	0.00%	0.00%
Xylenes (o)	0.00%	0.00%	0.00%	0.00%	0.00%
Xylenes (m,p)	0.00%	0.00%	0.00%	0.00%	0.00%
Chloromethane	0.00%	0.00%	0.00%	0.00%	0.00%
Trichloroethene	0.00%	0.00%	0.05%	0.10%	0.13%
Vinyl Chloride	1.12%	1.17%	0.00%	1.11%	3.21%
cis 1,2 Dichloroethene	0.00%	0.00%	0.00%	0.00%	0.01%
Benzene	1.29%	1.53%	0.11%	0.00%	0.22%
Toluene	0.00%	0.00%	0.00%	0.00%	0.00%
Trichlorofluoromethane (Freon 11)	0.00%	0.00%	0.00%	0.00%	0.00%
Dichlorodifluoromethane (Freon 12)	0.00%	0.00%	0.00%	0.00%	0.00%
Chlorodifluoromethane (Freon 22)	0.00%	0.00%	0.00%	0.00%	0.00%

Notes:

- (1) Actual effluent concentrations are analytical results from air samples collected on the dates shown. Data in this table corresponds to approximately the past year of system operation.
- (2) AGC refers to the compound-specific annual guideline concentration per the NYSDEC DAR-1 AGC/SGC tables, revised October 18, 2010.
- (3) Maximum allowable stack concentrations were calculated by dividing the product of the annual guideline concentration of a compound and the ratio of the SCREEN3 gas emission rate and the SCREEN 3 average concentration at receptor height by the air flow rate at the stack temperature and multiplying by the appropriate conversion factors.
- (4) Percent of MASC was calculated by dividing the actual effluent concentration by the MASC for a given monitoring event.

Acronyms\Key:

$\mu\text{g}/\text{m}^3$	Micrograms per cubic meter.
AGC	Annual guideline concentration.
MASC	Maximum allowable stack concentration.