

Mr. Jason Pelton
Project Manager
New York State Department of Environmental Conservation
Remedial Bureau D
625 Broadway
Albany, NY 12233-7015

Arcadis of New York, Inc.
Two Huntington Quadrangle
Suite 1S10
Melville
New York 11747
Tel 631 249 7600
Fax 631 249 7610
www.arcadis.com

Subject:
2018 First Quarter System Operation and Monitoring,
Bethpage Park Soil Gas Containment System (BPSGCS),
Operable Unit 3 (OU3; Former Grumman Settling Ponds),
Bethpage, New York, NYSDEC Site #1-30-003A

Date:
May 24, 2018

Dear Jason:

Contact:
Christopher Engler

Enclosed is one electronic PDF copy of the 2018 First Quarter results of the OU3 BPSGCS operation and monitoring, performed in accordance with the NYSDEC-approved OU3 Soil Gas IRM OM&M Manual (Arcadis 2016) and the NYSDEC-approved Sampling and Analysis Plan (SAP; Arcadis 2016). As we have transitioned to electronic submittals (via PDF) in line with NYSDEC's paper reduction program, hard copies of the report can be provided on request.

Phone:
631.391.5284

Email:
christopher.engler@arcadis.com

If you have any questions, please do not hesitate to contact us.

Our ref:
NY001496.33TM.RPTI4

Sincerely,

Arcadis of New York, Inc.



Christopher Engler PE

Vice President

Enclosure

Jason Pelton
May 24, 2018

Copies:

Ed Hannon, Northrop Grumman
Donald Hesler, NYSDEC
Steven Karpinski, NYS Dept. of Health
John Lovejoy, Nassau County Dept. of Health
Lorenzo Thantu, USEPA
Carlo San Giovanni, Arcadis
Public Repository
File

TABLES



Table 1
General System Operating Parameters
Bethpage Park Soil Gas Containment System
Operable Unit 3 (Former Grumman Settling Ponds)
Bethpage, New York

Date	DW-7S Parameters			DW-7D Parameters			DW-3S Parameters			DW-3D Parameters			DW-5S Parameters			DW-5D Parameters			DW-6S Parameters			DW-6D Parameters		
	Flow Rate at Manifold	Vacuum at Manifold	Wellhead Vacuum	Flow Rate at Manifold	Vacuum at Manifold	Wellhead Vacuum	Flow Rate at Manifold	Vacuum at Manifold	Wellhead Vacuum	Flow Rate at Manifold	Vacuum at Manifold	Wellhead Vacuum	Flow Rate at Manifold	Vacuum at Manifold	Wellhead Vacuum	Flow Rate at Manifold	Vacuum at Manifold	Wellhead Vacuum	Flow Rate at Manifold	Vacuum at Manifold	Wellhead Vacuum	Flow Rate at Manifold	Vacuum at Manifold	Wellhead Vacuum
	scfm	iwc	iwc	scfm	iwc	iwc	scfm	iwc	iwc	scfm	iwc	iwc	scfm	iwc	iwc	scfm	iwc	iwc	scfm	iwc	iwc	scfm	iwc	iwc
6/14/17	120	-21	-1.6	4.5	-11	-0.50	12.0	-6.0	-0.33	10	-6.2	-0.42	62	-24	-1.1	13	-13	-2.2	85	-16	-1.7	4.0	-4.3	-1.8
9/21/17	100	-18	-1.8	5.0	-20	-0.56	5.0	-7.5	-0.26	11	-6.0	-0.36	86	-13	-1.3	14	-13	-2.5	80	-15	-1.6	6.2	-5.0	-1.2
12/11/17	103	-23	-1.7	8.0	-7.5	-0.49	8.0	-7.0	-0.25	13	-6.5	-0.42	99	-16	-1.6	14	-12	-2.5	95	-19	-1.9	7.0	-5.2	-1.4
2/6/18	85	-21	-1.5	7.5	-7.5	-0.49	7.0	-5.0	-0.22	10	-6.0	-0.33	85	-15	-1.4	16	-9	-2.7	75	-15	-1.6	6.4	-5.5	-1.2

Abbreviations, Notes, and Units on last page.

Table 1
General System Operating Parameters
Bethpage Park Soil Gas Containment System
Operable Unit 3 (Former Grumman Settling Ponds)
Bethpage, New York

Date	DW-1S Parameters			DW-1D Parameters			DW-4S Parameters			DW-4D Parameters			DW-8S Parameters			DW-9S Parameters			DW-2S Parameters			DW-2D Parameters		
	Flow Rate at Manifold	Vacuum at Manifold	Wellhead Vacuum	Flow Rate at Manifold	Vacuum at Manifold	Wellhead Vacuum	Flow Rate at Manifold	Vacuum at Manifold	Wellhead Vacuum	Flow Rate at Manifold	Vacuum at Manifold	Wellhead Vacuum	Flow Rate at Manifold	Vacuum at Manifold	Wellhead Vacuum	Flow Rate at Manifold	Vacuum at Manifold	Wellhead Vacuum	Flow Rate at Manifold	Vacuum at Manifold	Wellhead Vacuum	Flow Rate at Manifold	Vacuum at Manifold	Wellhead Vacuum
	scfm	iwc	iwc	scfm	iwc	iwc	scfm	iwc	iwc	scfm	iwc	iwc	scfm	iwc	iwc	scfm	iwc	iwc	scfm	iwc	iwc	scfm	iwc	iwc
6/14/17	90	-22	-1.9	4.6	-2.5	-1.3	69	-14	-1.3	5.0	-6.0	-0.56	65	-17	-1.8	43	-14	-1.7	22	-21	-1.4	39	-23	-2.2
9/21/17	85	-22	-2.0	5.1	-2.5	-1.5	75	-14	-1.5	7.0	-7.0	-0.76	73	-19	-2.1	35	-13	-1.4	33	-26	-2.0	36	-21	-2.2
12/11/17	100	-22	-2.4	5.5	-2.5	-1.6	95	-17	-2.1	9.0	-7.0	-0.87	75	-25	-2.2	42	-13	-1.7	23	-23	-1.6	43	-25	-2.6
2/6/18	95	-18	-2.3	5.2	-3.0	-1.6	75	-16	-1.7	7.0	-6.0	-0.68	75	-21	-2.5	35	-12	-1.4	24	-25	-1.5	38	-22	-2.3

Abbreviations, Notes, and Units on last page.

Table 1
General System Operating Parameters
Bethpage Park Soil Gas Containment System
Operable Unit 3 (Former Grumman Settling Ponds)
Bethpage, New York

Date	DW-10S Parameters			DW-11S Parameters			Knock Out Tank Parameters - Vacuum			Condensate Water Collected ¹	Blower Parameters BL-200			Blower Parameters BL-300			Blower Parameters BL-400			Combined Effluent Parameters				
	Flow Rate at Manifold	Vacuum at Manifold	Wellhead Vacuum	Flow Rate at Manifold	Vacuum at Manifold	Wellhead Vacuum	Influent KO-200	Influent KO-300	Influent KO-400	Influent ST-510	Influent Vacuum	Effluent Pressure	Blower Speed	Influent Vacuum	Effluent Pressure	Blower Speed	Influent Vacuum	Effluent Pressure	Blower Speed	Total Effluent Flow Rate (2)	Total Effluent PID	Heat Exchanger Influent Temp.	Total Effluent Pressure	Heat Exchanger Effluent Temp.
	scfm	iwc	iwc	scfm	iwc	iwc	iwc	iwc	iwc	Gallons	iwc	iwc	Hz	iwc	iwc	Hz	iwc	iwc	Hz	scfm	ppmv	°F	iwc	°F
6/14/17	35	-14	-1.9	34	-23	-2.0	NA	-32	NA	150	NA	NA	NA	-37	2.5	60	NA	NA	NA	664	0.0	111	0.0	100
9/21/17	34	-15	-1.9	24	-19	-1.6	NA	-36	NA	30	NA	NA	NA	-37	2.0	60	NA	NA	NA	670	0.1	120	2.9	106
12/11/17	40	-19	-2.2	30	-24	-2.1	NA	NA	-30	0	NA	NA	NA	NA	NA	NA	-35	3.0	60	653	0.1	104	3.0	85
2/6/18	60	-22	-3.6	31	-23	-1.5	NA	NA	-39	210	NA	NA	NA	NA	NA	NA	-39	1.5	60	759	0.0	103	2.7	83

Abbreviations, Notes, and Units on last page.

Table 1
General System Operating Parameters
Bethpage Park Soil Gas Containment System
Operable Unit 3 (Former Grumman Settling Ponds)
Bethpage, New York

Abbreviations, Notes, and Units:

DW	Depressurization Well
NA	Not Applicable
PID	Photoionization Detector

1. Total gallons of water accumulated at storage tank ST-510 per quarter. Values for Second Quarter 2017 are estimated based on average volume collected during condensate removal events. Values for Third and Fourth Quarter 2017 and First Quarter 2018 are taken from site operator condensate event logs.

2. Total effluent air velocity in feet per minute was measured using a hand-held anemometer at the stack effluent location. The total effluent flow rate in scfm was calculated by multiplying the measured air velocity by the pipe area, the ratio of the standard air temperature to the measured air temperature, and the ratio of the measured air pressure to the standard air pressure.

°F	degrees Fahrenheit
gal	gallons
Hz	Hertz
iwc	inches of water column
ppmv	parts per million by volume
scfm	standard cubic feet per minute

Table 2
Summary of Induced Vacuum Readings at Compliance Monitoring Points
Bethpage Park Soil Gas Containment System
Operable Unit 3 (Former Grumman Settling Ponds)
Bethpage, New York

Well ID:	DW-7S		DW-7D	DW-3S	DW-3D	DW-5S		DW-5D	DW-1S			DW-1D	DW-4D	DW-8S		DW-2S		DW-2D		DW-11S	
MP ID:	VMWC-14A	VMWC-14B	VMWC-14D	VMWC-11B	VMWC-12D	VMWC-15A	VMWC-15B	VMWC-15D	VMWC-3A	VMWC-3B	VMWC-3C	VMWC-3D	VMWC-16D	VMWC-16A	VMWC-16B	VMWC-7A	VMWC-7B	VMWC-13D	VMWC-17D	VMWC-18A	VMWC-18B
Date	iwc	iwc	iwc	iwc	iwc	iwc	iwc	iwc	iwc	iwc	iwc	iwc	iwc	iwc	iwc	iwc	iwc	iwc	iwc	iwc	iwc
06/14/17	-0.12	-0.18	-0.19	-0.11	-0.14	-0.11	-0.11	-0.13	-0.13	-0.14	-0.15	-0.17	-0.15	-0.12	-0.15	-0.12	-0.16	-0.12	-0.28	-0.11	-0.11
09/21/17	-0.10	-0.19	-0.19	-0.12	-0.56	-0.16	-0.14	-0.15	-0.14	-0.15	-0.15	-0.20	-0.27	-0.18	-0.17	-0.12	-0.13	-0.19	-0.24	-0.09	-0.10
12/11/17	-0.10	-0.18	-0.20	-0.12	-0.08	-0.10	-0.11	-0.10	-0.13	-0.14	-0.14	-0.11	-0.77	-0.21	0.00	-0.11	-0.13	-0.27	-0.26	-0.08	-0.09
02/06/18	-0.09	-0.17	-0.19	-0.21	-0.09	-0.13	-0.13	-0.09	-0.16	-0.17	-0.18	-0.19	-0.14	-0.21	-0.23	-0.15	-0.17	-0.16	-0.25	-0.12	-0.14
Time Weighted Rolling Average¹	-0.10	-0.18	-0.19	-0.14	-0.35	-0.14	-0.13	-0.13	-0.14	-0.15	-0.15	-0.18	-0.36	-0.19	-0.14	-0.12	-0.14	-0.20	-0.25	-0.09	-0.11

Gross Average Compliance Points ²	
02/06/18	-0.16

Abbreviations, Notes, and Units:

DW Depressurization Well
VMWC Vapor Monitoring Well Cluster

1. Compliance goal is -0.1 iwc of vacuum at all compliance monitoring points, based on a twelve-month rolling average. Time weighted rolling average calculated by summing the products of the instantaneous induced vacuum readings and the number of days between readings for a 12-month monitoring period, and dividing by the total time period between the first and last quarterly induced vacuum readings.
2. Gross average compliance points calculated by summing the induced vacuum values for the noted monitoring event and dividing by the number of readings.

iwc inches of water column

Table 3
Total Effluent Vapor Sample Analytical Results
Bethpage Park Soil Gas Containment System
Operable Unit 3 (Former Grumman Settling Ponds)
Bethpage, New York

Compound (units in µg/m ³)	Sample ID ¹ : Sample Date:	VSP-601 6/23/2017 ³	VSP-601 9/22/2017 ⁴	VSP-601 12/11/2017	VSP-601 2/6/2018
Project VOCs	CAS No.				
1,1,1-Trichloroethane	71-55-6	12	16	10	8.7
1,1-Dichloroethane	75-34-3	8.9	13	9.7	7.7
1,1-Dichloroethene	75-35-4	< 7.9 U	0.56 J	< 3.2 U	< 0.63 U
1,2-Dichloroethane	107-06-2	< 8.1 U	< 0.81 U	< 3.2 U	< 3.2 U
Benzene	71-43-2	< 6.4 U	< 0.64 U	< 2.6 U	1.4 J
cis-1,2-Dichloroethene	156-59-2	400	311	358	310
Tetrachloroethene	127-18-4	14	20	8.8	6.6
Toluene	108-88-3	< 7.5 U	1.7	< 3.0 U	< 3.0 U
trans-1,2-Dichloroethene	156-60-5	4.4 J	4.0	2.6 J	1.6 J
Trichloroethylene	79-01-6	437	429	378	306
Vinyl chloride	75-01-4	< 1.0 U	0.95	< 0.41 U	< 0.41 U
Xylene-O	95-47-6	< 8.7 U	0.43 J	< 3.5 U	< 3.5 U
Xylenes - M,P	1330-20-7	< 8.7 U	1.2	< 3.5 U	< 3.5 U
Subtotal Project VOCs		876	798	767	642
Non-Project VOCs					
1,1,2,2-Tetrachloroethane	79-34-5	< 6.9 U	< 0.69 U	< 2.7 U	< 2.7 U
1,1,2-Trichloroethane	79-00-5	< 5.5 U	< 0.55 U	< 2.2 U	< 2.2 U
1,2-Dichloropropane	78-87-5	< 9.2 U	< 0.92 U	< 3.7 U	< 3.7 U
1,3-Butadiene	106-99-0	< 4.4 U	< 0.44 U	< 1.8 U	< 1.8 U
1-Chloro-1,1-difluoroethane (Freon 142b)	75-68-3	200	220	69.1	48.5
2-Butanone	78-93-3	< 5.9 U	1.3	< 2.4 U	< 2.4 U
2-Hexanone	591-78-6	< 8.2 U	< 0.82 U	< 3.3 U	< 3.3 U
4-Methyl-2-Pentanone	108-10-1	< 8.2 U	< 0.82 U	< 3.3 U	< 3.3 U
Acetone	67-64-1	4.5 J	5.5	4.3	3.1
Bromodichloromethane	75-27-4	< 6.7 U	< 0.67 U	< 2.7 U	< 2.7 U
Bromoform	75-25-2	< 4.1 U	< 0.41 U	< 1.7 U	< 1.7 U
Bromomethane	74-83-9	< 7.8 U	< 0.78 U	< 3.1 U	< 3.1 U
Carbon Disulfide	75-15-0	< 6.2 U	< 0.62 U	< 2.5 U	< 2.5 U
Carbon Tetrachloride	56-23-5	< 2.5 U	1.4	< 1.0 U	< 1.0 U

Abbreviations, Notes, Qualifiers, and Units on last page.

Table 3
Total Effluent Vapor Sample Analytical Results
Bethpage Park Soil Gas Containment System
Operable Unit 3 (Former Grumman Settling Ponds)
Bethpage, New York

Compound (units in µg/m ³)	Sample ID ¹ : Sample Date:	VSP-601 6/23/2017 ³	VSP-601 9/22/2017 ⁴	VSP-601 12/11/2017	VSP-601 2/6/2018
Non-Project VOCs	CAS No.				
Chlorobenzene	108-90-7	< 9.2 U	< 0.92 U	< 3.7 U	< 3.7 U
Chlorodibromomethane	124-48-1	< 8.5 U	< 0.85 U	< 3.4 U	< 3.4 U
Chloroethane	75-00-3	< 5.3 U	< 0.53 U	< 2.1 U	< 2.1 U
Chlorodifluoromethane (Freon 22)	75-45-6	2.3 J	< 0.070 U	< 2.8 U	< 2.8 U
Chloroform	67-66-3	25	45	33	29
Chloromethane	74-87-3	< 4.1 U	< 0.41 U	< 1.7 U	< 1.7 U
cis-1,3-Dichloropropene	10061-01-5	< 9.1 U	< 0.91 U	< 3.6 U	< 3.6 U
Dichlorodifluoromethane (Freon 12)	75-71-8	< 9.9 U	3.8	3.0 J	2.4 J
Ethylbenzene	100-41-4	< 8.7 U	< 0.87 U	< 3.5 U	< 3.5 U
Methylene Chloride	75-09-2	4.5 J	< 0.69 U	3.8	< 2.8 U
Methyl Tert-Butyl Ether	1634-04-4	< 7.2 U	< 0.72 U	< 2.9 U	< 2.9 U
Styrene	100-42-5	< 8.5 U	< 0.85 U	< 3.4 U	< 3.4 U
Trans-1,3-Dichloropropene	10061-02-6	< 9.1 U	< 0.91 U	< 3.6 U	< 3.6 U
Trichlorofluoromethane (Freon 11)	75-69-4	< 5.6 U	2.1	< 2.2 U	< 2.2 U
Trichlorotrifluoroethane (Freon 113)	76-13-1	< 7.7 U	0.74 J	< 3.1 U	< 3.1 U
Subtotal Non-Project VOCs		236	280	113	83
TVOC²		1,113	1,078	880	725

Abbreviations, Notes, Qualifiers, and Units on last page.

Table 3
Total Effluent Vapor Sample Analytical Results
Bethpage Park Soil Gas Containment System
Operable Unit 3 (Former Grumman Settling Ponds)
Bethpage, New York

Abbreviations, Notes, Qualifiers, and Units:

- CAS No. Chemical Abstracts Service list number
- ELAP Environmental Laboratory Approval Program
- NYSDOH New York State Department of Health
- NYSDDEC New York State Department of Environmental Conservation.
- TVOC Total Volatile Organic Compounds
- USEPA United States Environmental Protection Agency
- VOC Volatile Organic Compound

1. Vapor samples collected by Arcadis and submitted to a NYSDOH ELAP certified laboratory for VOC analyses per Modified USEPA Method TO-15.
2. TVOC determined by summing individual detections and rounding to the nearest whole number.
3. 6/23/2017 sample taken 7 days after parameter and vacuum readings.
4. 9/22/2017 sample taken 1 day after parameter and vacuum readings.

- 29** Bolding indicates that the analyte was detected at or above laboratory reporting limit
- < 1.0 U Compound not detected above its laboratory quantification limit
- J** Compound detected below laboratory reporting limit; result is estimated
- µg/m³ micrograms per cubic meter

Table 4
Total Effluent Vapor Sample Analytical Results
Tentatively Identified Compounds
Bethpage Park Soil Gas Containment System
Operable Unit 3 (Former Grumman Settling Ponds)
Bethpage, New York

Sample ID:	VSP-601	VSP-601	VSP-601	VSP-601
Sample Date ¹ :	6/23/2017 ³	9/22/2017 ⁴	12/11/2017	2/6/2018
Units:	ppbv	ppbv	ppbv	ppbv
Tentatively Identified Compounds ²				
Carbon Dioxide	ND	35 JNB	690 JNB	ND
Unknown	ND	10 J	ND	ND

Abbreviations, Notes, Qualifiers, and Units:

- ND Not Detected
- ELAP Environmental Laboratory Approval Program
- NYSDOH New York State Department of Health
- USEPA U.S. Environmental Protection Agency
- VOC Volatile Organic Compound

1. Vapor samples collected by Arcadis on the dates shown and submitted to a NYSDOH ELAP certified laboratory for VOC analyses per Modified USEPA Method TO-15.
2. Tentatively identified compounds are identified based on review of mass spectrometry results via a comprehensive library search of all organic compounds.
3. VSP-601 6/23/2017 sample taken 7 days after parameter and vacuum readings.
4. VSP-601 9/22/2017 sample taken 1 day after parameter and vacuum readings.

- B** Indicates analyte found in associated method blank
- J** Indicates an estimated value
- JN** Compound tentatively identified, concentration is estimated
- ppbv parts per billion by volume

Table 5
Air Quality Impact Analysis
Bethpage Park Soil Gas Containment System
Operable Unit 3 (Former Grumman Settling Ponds)
Bethpage, New York

Toxic Air Contaminant	CAS#	VSP-601 Vapor Effluent ($\mu\text{g}/\text{m}^3$) 2/6/2018	Emission Rate ¹			Scaled Impact - Hourly ² ($\mu\text{g}/\text{m}^3$)	Scaled Impact - Annual ² ($\mu\text{g}/\text{m}^3$)	SGC ³ ($\mu\text{g}/\text{m}^3$)	AGC ³ ($\mu\text{g}/\text{m}^3$)	% of SGC	% of AGC
			lb/yr	lb/hr	g/s						
Project VOCs											
1,1,1 - Trichloroethane	71-55-6	8.7	2.2E-01	2.5E-05	3.1E-06	1.4E-03	6.2E-05	9,000	5,000	0.0%	0.0%
1,1 - Dichloroethane	75-34-3	7.7	1.9E-01	2.2E-05	2.8E-06	1.3E-03	5.5E-05	NS	0.63	NS	0.0%
Benzene	71-43-2	1.4 J	3.5E-02	4.0E-06	5.0E-07	2.3E-04	1.0E-05	1300	0.13	0.0%	0.0%
cis- 1,2-Dichloroethene	156-59-2	310	7.7E+00	8.8E-04	1.1E-04	5.1E-02	2.2E-03	NS	63	NS	0.0%
Tetrachloroethene	127-18-4	6.6	1.6E-01	1.9E-05	2.4E-06	1.1E-03	4.7E-05	300	4.0	0.0	0.0%
trans- 1,2-Dichloroethene	156-60-5	1.6 J	4.0E-02	4.5E-06	5.7E-07	2.6E-04	1.1E-05	NS	63	NS	0.0%
Trichloroethene	79-01-6	306	7.6E+00	8.7E-04	1.1E-04	5.1E-02	2.2E-03	20	0.2	0.3%	1.1%
Non-Project VOCs											
1-Chloro-1,1-difluoroethane (Freon 142b)	75-68-3	48.5	1.2E+00	1.4E-04	1.7E-05	8.1E-03	3.5E-04	NS	50,000	NS	0.0%
Acetone	67-64-1	3.1	7.8E-02	8.9E-06	1.1E-06	5.2E-04	2.2E-05	180,000	30,000	0.0%	0.0%
Chloroform	67-66-3	29	7.3E-01	8.3E-05	1.0E-05	4.8E-03	2.1E-04	150	14.7	0.0%	0.0%
Dichlorodifluoromethane (Freon 12)	75-71-8	2.4 J	6.0E-02	6.9E-06	8.7E-07	4.0E-04	1.7E-05	NS	12,000	NS	0.0%

Abbreviations, Notes, and Units on last page.

Table 5
Air Quality Impact Analysis
Bethpage Park Soil Gas Containment System
Operable Unit 3 (Former Grumman Settling Ponds)
Bethpage, New York

Abbreviations, Notes, and Units:

AGC	Annual Guideline Concentration
CAS#	Chemical Abstracts Service Registry Number
DAR-1	Division of Air Resources-1
NS	None Specified
NYSDEC	New York State Department of Environmental Conservation
SGC	Short-term Guideline Concentration
VSP	Vapor Sampling Point

1. Emission rate calculated based on VSP-601 effluent concentration and an exit air flow rate of 759 ft³/min for 2/6/2018.

$$\text{TCE (lb/hr)} = \text{TCE } [\mu\text{g}/\text{m}^3] \times \text{Air Flow Rate } [\text{ft}^3/\text{min}] \times (1 \text{ m}^3/35.3147 \text{ ft}^3) \times (60 \text{ min/hr}) \times (0.000001 \text{ g/1 } \mu\text{g}) \times (0.0022 \text{ lb/g})$$

$$\text{lb/yr} = \text{lb/hr} \times 8,760 \text{ hrs/yr}$$

$$\text{g/s} = \text{lb/hr} \times 1 \text{ hr/3,600 sec} \times 453.59 \text{ g/lb}$$

2. Ambient impact based on AERMOD modeling using normalized rate of 1 g/s is scaled to the actual emission rate of the pollutant. Modeling was performed using the representative meteorological data from the nearest station (Farmingdale) for the years 2011 through 2015. The maximum impact from all the years was used for the calculations.

$$\text{Scaled hourly impact } (\mu\text{g}/\text{m}^3) = \text{AERMOD predicted hourly ambient impact at 1 g/s } ([\mu\text{g}/\text{m}^3]/[\text{g}/\text{s}]) \times \text{Actual emission rate (g/s)}$$

$$\text{Scaled annual impact } (\mu\text{g}/\text{m}^3) = \text{AERMOD predicted annual ambient impact at 1 g/s } ([\mu\text{g}/\text{m}^3]/[\text{g}/\text{s}]) \times \text{Actual emission rate (g/s)}$$

AERMOD Normalized Ambient Impact at 1 g/s	
Hourly ([\mu\text{g}/\text{m}^3]/[\text{g}/\text{s}])	Annual ([\mu\text{g}/\text{m}^3]/[\text{g}/\text{s}])
462.83	20.02

3. Short-term and annual guideline concentrations specified in the NYSDEC DAR-1 AGC/SGC tables revised August 10, 2016.

4. Only contaminants with detected concentrations are included in the table.

ft ³ /min	cubic feet per minute
g/s	grams per second
μg/m ³	micrograms per cubic meter
lb/hr	pounds per hour

FIGURES



CITY:SYRACUSE-NY DIV:GROUP:ENV DBA:SANCHEZ LDALS PIC:(Op) PM:(Reg) TM:(Op) LXR:(Op)ON*-OFF-REF*
 Z:\ENVCAD\STRACUSE\ACT\N1001469\Site\Map\Map.dwg LAYOUT:BP - SAVED: 3/15/2017 9:38 AM ACADVER: 19.15 (LMS TECH) PAGES:1UP - PLOTSTYLETABLE: PLT\FULL.CTB PLOTTED: 3/15/2017 9:38 AM BY: SANCHEZ, ADRIAN
 XREFS: IMAGES: PROJECTNAME: 2013A:il.ville.dwg 2013F:freeport.dwg 2013H:ic.sville.dwg 2013H:ntington.dwg

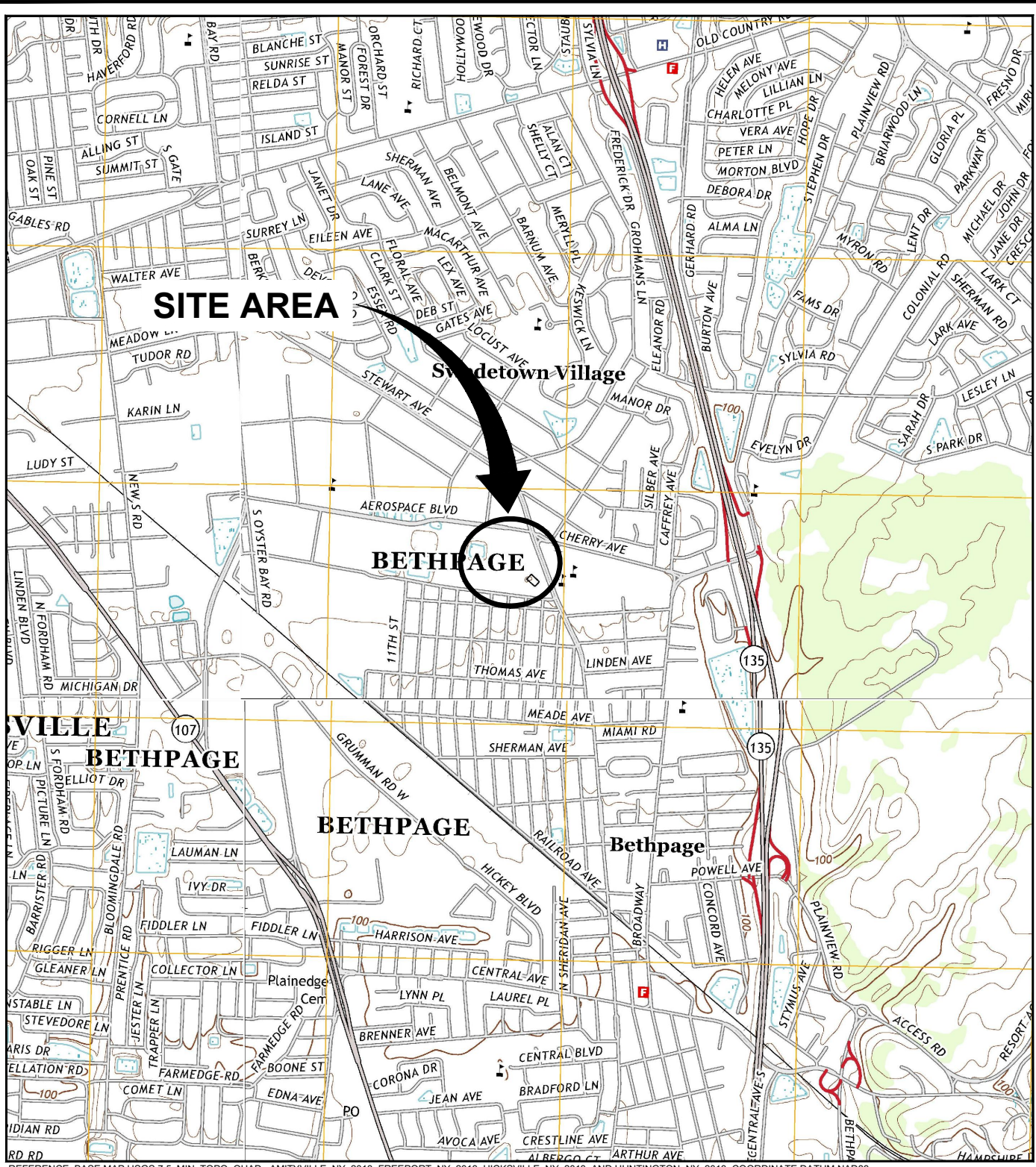

REFERENCE: BASE MAP USGS 7.5 MIN. TOPO. QUAD., AMITYVILLE, NY, 2013, FREEPORT, NY, 2013, HICKSVILLE, NY, 2013, AND HUNTINGTON, NY, 2013, COORDINATE DATUM NAD83.

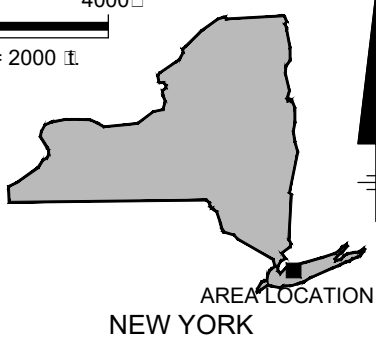
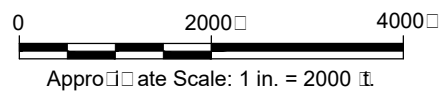

NORTHROP GRUMMAN SYSTEMS CORPORATION
 BETHPAGE PARK SOIL GAS CONTAINMENT SYSTEM
 BETHPAGE, NEW YORK
OPERABLE UNIT 3
 (FORMER GRUMMAN SETTLING PONDS)

SITE LOCATION MAP

FIGURE
1

ARCADIS Design & Consultancy
 for natural and built assets

CITY:SYRACUSE,NY DIV:GROUP:ENV DB:A,SANCHEZ LD:ALS PIC:Opti PM:(Recd) TM:(Opt) LVR:(Opt)ON="OFF=REF" PLOTSTYLETABLE: PLOTTED: 10/12/2017 6:59 PM BY: SANCHEZ, ADRIAN
 Z:\ENVCAD\SYRACUSE\ACT\NY001496\1616\RP14\NY1496\F02-3a.dwg LAYOUT: 2 SAVED: 10/12/2017 6:38 PM ACADVER: 19.15 (LMS TECH) PAGESETUP: PLOTSTYLETABLE: PLOTTED: 10/12/2017 6:59 PM BY: SANCHEZ, ADRIAN
 XREFS: XI:49B\01 X:6DR-DL

PROPERTY OWNED BY TOWN OF OYSTER BAY

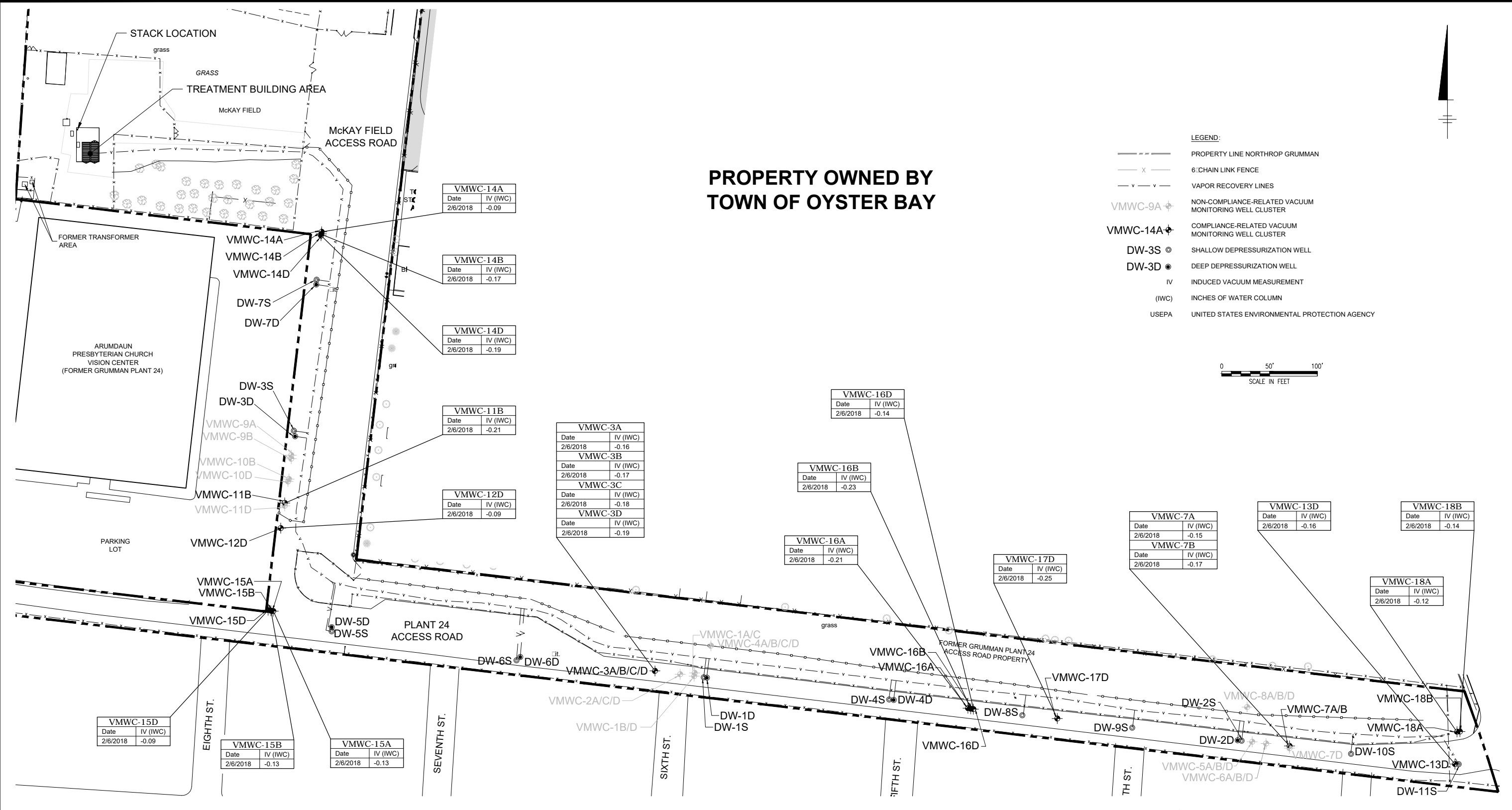

- LEGEND:
- PROPERTY LINE NORTHROP GRUMMAN
 - x- 6' CHAIN LINK FENCE
 - v- VAPOR RECOVERY LINES
 - VMWC-9A ◊ NON-COMPLIANCE-RELATED VACUUM MONITORING WELL CLUSTER
 - VMWC-14A ◊ COMPLIANCE-RELATED VACUUM MONITORING WELL CLUSTER
 - DW-3S ⊙ SHALLOW DEPRESSURIZATION WELL
 - DW-3D ⊙ DEEP DEPRESSURIZATION WELL
 - IV INDUCED VACUUM MEASUREMENT
 - (IWC) INCHES OF WATER COLUMN
 - USEPA UNITED STATES ENVIRONMENTAL PROTECTION AGENCY

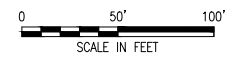

- NOTES:
- USEPA'S RADON GUIDANCE RECOMMENDS NEGATIVE PRESSURE OF 0.035 INCHES OF WATER FOR THE CONTROL OF SOIL VAPOR (EPA 625/R-93-011, 1993).
 - SYSTEM DESIGN OBJECTIVE IS TO MAINTAIN -0.1 IWC OF INDUCED VACUUM AT ALL COMPLIANCE-RELATED VACUUM MONITORING WELLS ON A 12-MONTH ROLLING AVERAGE (ARCADIS 2007).
 - DATA SHOWN HEREIN ARE COLLECTED FROM COMPLIANCE-RELATED VACUUM MONITORING WELLS ONLY.

NORTHROP GRUMMAN SYSTEMS CORPORATION
 BETHPAGE PARK SOIL GAS CONTAINMENT SYSTEM
 BETHPAGE, NEW YORK
OPERABLE UNIT 3
 (FORMER GRUMMAN SETTLING PONDS)

**GENERAL SITE PLAN AND
 MONITORING WELL VACUUM MEASUREMENTS
 FIRST QUARTER 2018**

CITY: SYRACUSE, NY; DIVISION: ENVIRONMENTAL; DRAWING: PFD; PROJECT: NORTHROP GRUMMAN BETHPAGE; SHEET: PFD-03; DATE: 11/15/2017; 1:15 PM; ACADVER: 2.10; PLOTTER: HP DesignJet 2400; PLOTTED: 2/28/2018 7:44 PM; BY: SANCHEZ, ADRIAN; PROJECT NAME: XIBDR-DL; XREFS: IMAGES:

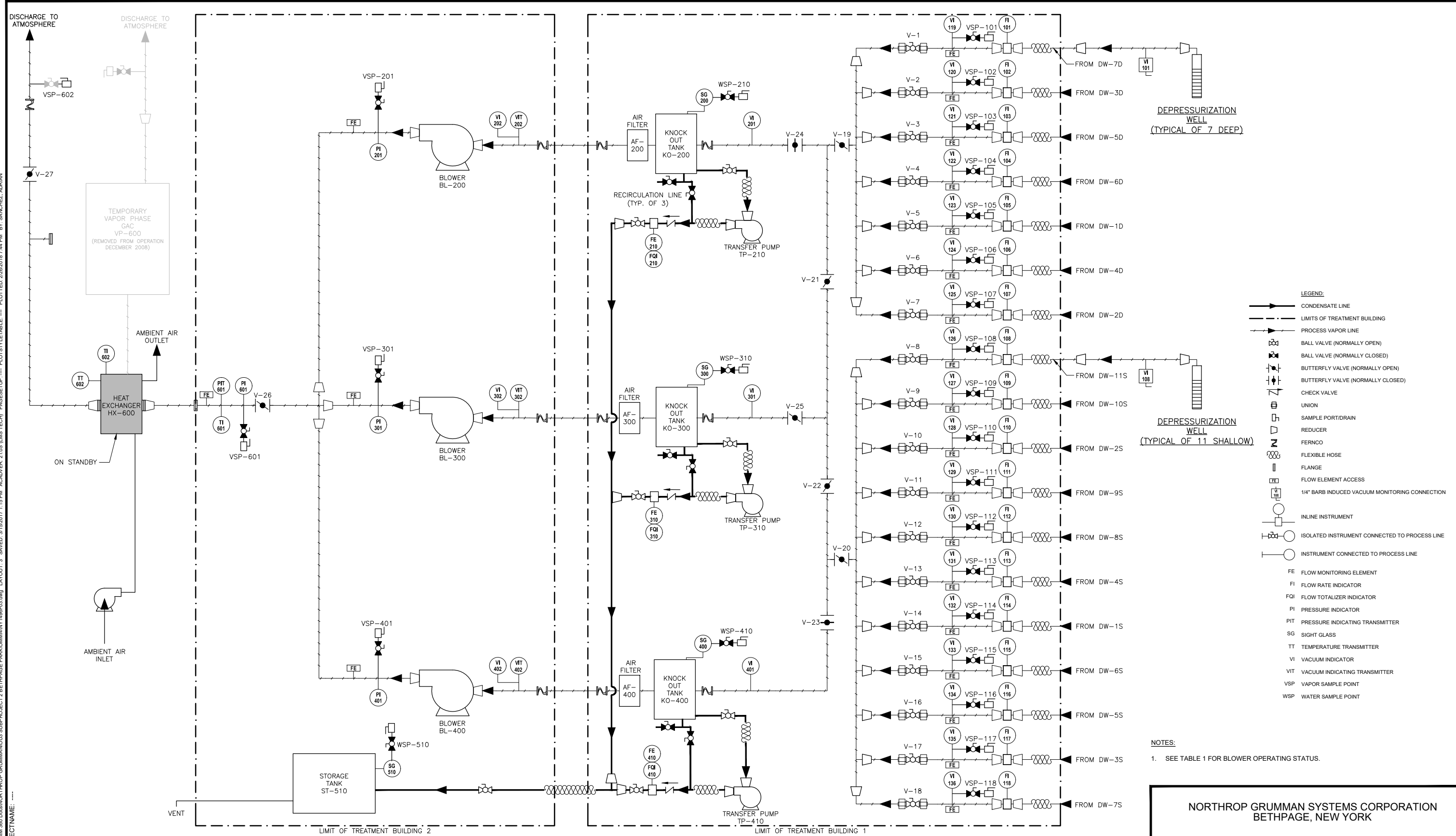

- LEGEND:**
- CONDENSATE LINE
 - LIMITS OF TREATMENT BUILDING
 - PROCESS VAPOR LINE
 - BALL VALVE (NORMALLY OPEN)
 - BALL VALVE (NORMALLY CLOSED)
 - BUTTERFLY VALVE (NORMALLY OPEN)
 - BUTTERFLY VALVE (NORMALLY CLOSED)
 - CHECK VALVE
 - UNION
 - SAMPLE PORT/DRAIN
 - REDUCER
 - FERNCO
 - FLEXIBLE HOSE
 - FLANGE
 - FLOW ELEMENT ACCESS
 - 1/4" BARB INDUCED VACUUM MONITORING CONNECTION
 - INLINE INSTRUMENT
 - ISOLATED INSTRUMENT CONNECTED TO PROCESS LINE
 - INSTRUMENT CONNECTED TO PROCESS LINE
- FE FLOW MONITORING ELEMENT
 FI FLOW RATE INDICATOR
 FQI FLOW TOTALIZER INDICATOR
 PI PRESSURE INDICATOR
 PIT PRESSURE INDICATING TRANSMITTER
 SG SIGHT GLASS
 TT TEMPERATURE TRANSMITTER
 VI VACUUM INDICATOR
 VIT VACUUM INDICATING TRANSMITTER
 VSP VAPOR SAMPLE POINT
 WSP WATER SAMPLE POINT

NOTES:
 1. SEE TABLE 1 FOR BLOWER OPERATING STATUS.

NORTHROP GRUMMAN SYSTEMS CORPORATION
 BETHPAGE, NEW YORK

PROCESS FLOW DIAGRAM

Design & Consultancy
 for natural and built assets

FIGURE
 3

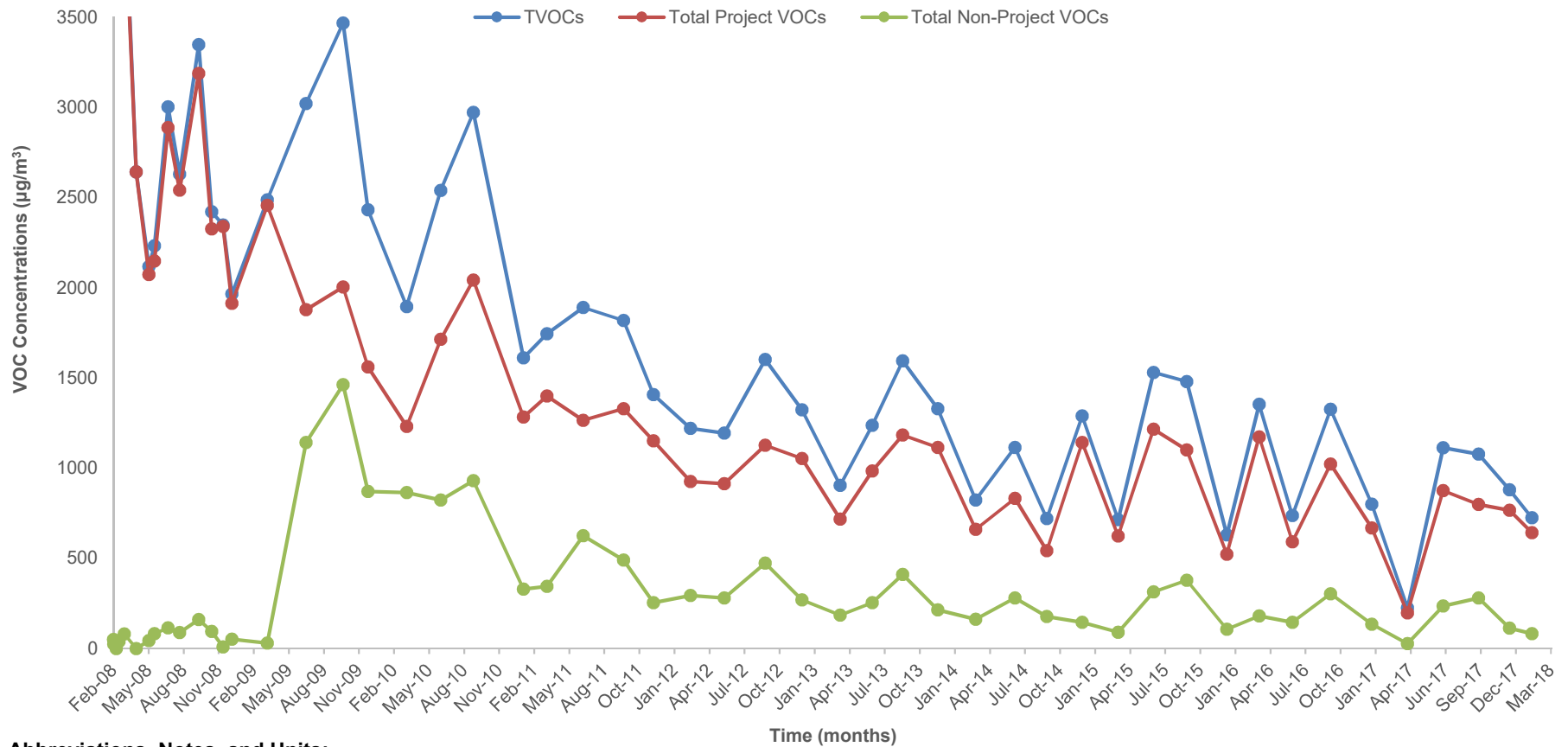

Abbreviations, Notes, and Units:

VOCs = Volatile Organic Compounds
 TVOCs = Total VOCs detected

Total Project VOCs = Sum of 1,1,1-trichloroethane; 1,1-dichloroethane; 1,2-dichloroethane; 1,1-dichloroethene; tetrachloroethene; trichloroethene; vinyl chloride; cis-1,2-dichloroethene; trans-1,2-dichloroethene; benzene; toluene; and total xylenes.

Total Non-Project VOCs = Sum of VOCs that are not Project VOCs.

1. Samples were collected at Vapor Sample Port-601 (VSP-601); refer to Figure 3 of this OM&M report for the location of VSP-601.
2. Results prior to April 16, 2008 are not shown to improve figure clarity. The TVOC and Total Project VOC concentrations are greater than 3,500 µg/m³. See previous reports for full data set.
3. The sample results from December 3, 2010 are not consistent with historical data and the results are excluded from this figure. The TVOC concentration for December 3, 2010 was 13 µg/m³.

µg/m³ = micrograms per cubic meter

NORTHROP GRUMMAN SYSTEMS CORPORATION BETHPAGE PARK SOIL GAS CONTAINMENT SYSTEM BETHPAGE, NEW YORK, OPERABLE UNIT 3 (FORMER GRUMMAN SETTLING PONDS)	
SOIL GAS VOC CONCENTRATIONS	
 ARCADIS <small>Design & Consultancy for natural and built assets</small>	FIGURE 4

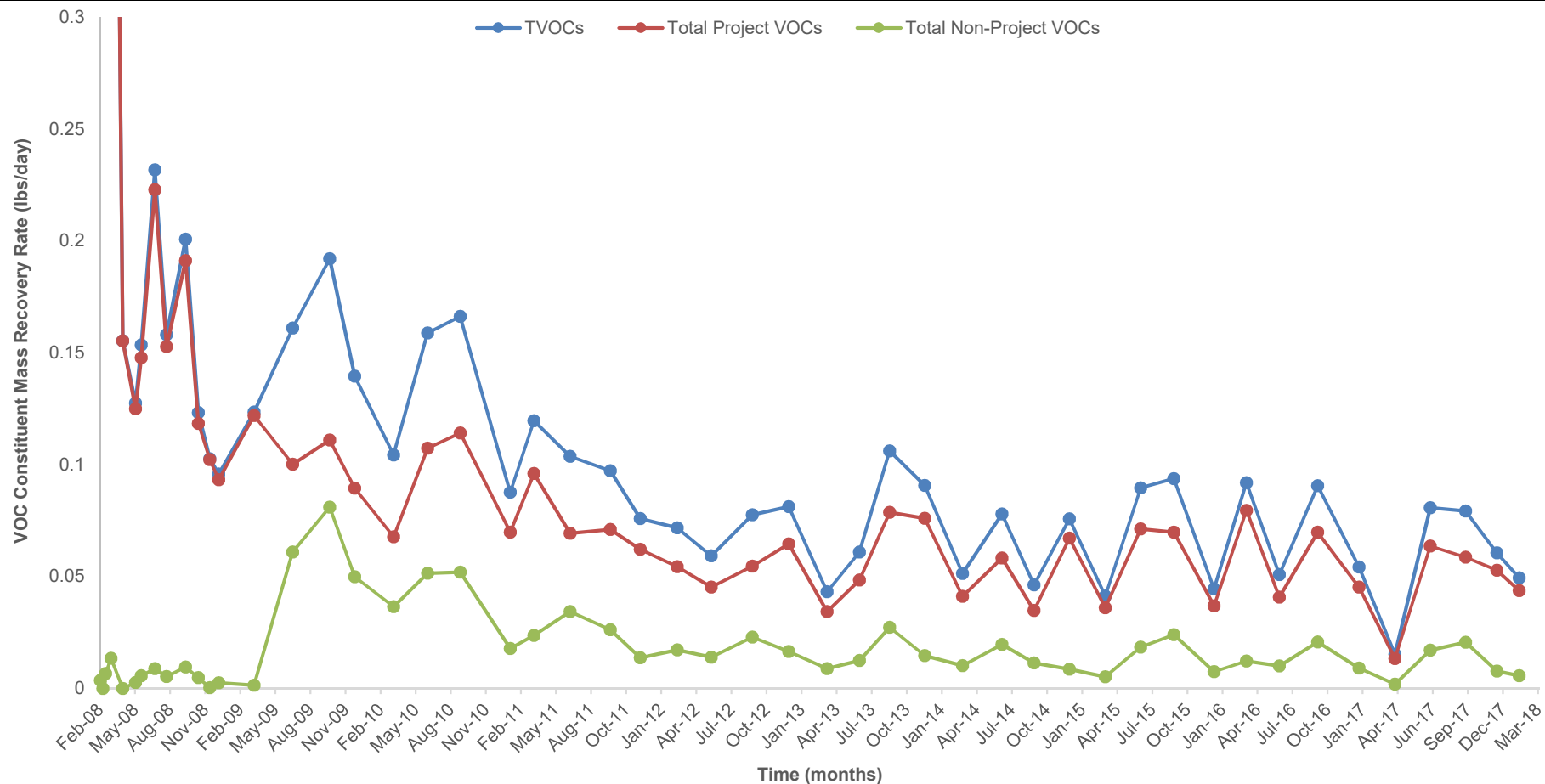

Abbreviations, Notes, and Units:

VOCs = Volatile Organic Compounds

TVOCs = Total VOCs detected

Total Project VOCs = Sum of 1,1,1-trichloroethane; 1,1-dichloroethane; 1,2-dichloroethane; 1,1-dichloroethene; tetrachloroethene; trichloroethene; vinyl chloride; cis-1,2-dichloroethene; trans-1,2-dichloroethene; benzene; toluene; and total xylenes.

Total Non-Project VOCs = Sum of VOCs that are not Project VOCs.

1. Results prior to April 16, 2008 are not shown to improve figure clarity. The TVOC and Total Project VOC concentrations are greater than 0.3 lbs/day. See previous reports for full data set.

2. The sample results from December 3, 2010 are not consistent with historical data and the results are excluded from this figure. The TVOC concentration for December 3, 2010 was 13 µg/L.

lbs/day = pounds per day

NORTHROP GRUMMAN SYSTEMS CORPORATION
 BETHPAGE PARK SOIL GAS CONTAINMENT SYSTEM
 BETHPAGE, NEW YORK, OPERABLE UNIT 3
 (FORMER GRUMMAN SETTLING PONDS)

VOC MASS RECOVERY RATES



FIGURE

6