

Mr. Jason Pelton
Project Manager
New York State Department of Environmental Conservation
Remedial Bureau D
625 Broadway
Albany, NY 12233-7015

Arcadis of New York, Inc.
Two Huntington Quadrangle
Suite 1S10
Melville
New York 11747
Tel 631 249 7600
Fax 631 249 7610
www.arcadis.com

Subject:
2019 Annual Summary Report for the
Bethpage Park Soil Gas Containment System (BPSGCS),
Operable Unit 3 (OU3; Former Grumman Settling Ponds),
Bethpage, New York, NYSDEC Site #1-30-003A

Date:
March 30, 2020

Dear Jason:

Contact:
Christopher Engler

Enclosed is one electronic PDF copy of the 2019 Annual Summary Report for the BPSGCS operation and monitoring, performed in accordance with the NYSDEC-approved OU3 Soil Gas IRM OM&M Manual (Arcadis 2016) and the NYSDEC-approved Sampling and Analysis Plan (SAP; Arcadis 2016). As we have transitioned to electronic submittals (via PDF) in line with NYSDEC's paper reduction program, hard copies of the report can be provided on request.

Phone:
315.409.6579

Email:
christopher.engler@arcadis.com

If you have any questions, please do not hesitate to contact me.

Our ref:
30037970

Sincerely,

Arcadis of New York, Inc.



Christopher Engler PE

Vice President

Enclosure

Jason Pelton
March 30, 2020

Copies:

Ed Hannon, Northrop Grumman
Donald Hesler, NYSDEC
Steven Karpinski, NYS Dept. of Health
John Lovejoy, Nassau County Dept. of Health
Carlo San Giovanni, Arcadis
Nidal Azzam, USEPA
Carol Stein, USEPA
Public Repository
File

Northrop Grumman Systems Corporation

2019 ANNUAL SUMMARY REPORT

Operation, Maintenance, and Monitoring Report for
the Bethpage Park Soil Gas Containment System

Operable Unit 3 (Former Grumman Settling Ponds)
Bethpage, New York
NYSDEC ID # 1-30-003A

March 30, 2020

2019 ANNUAL SUMMARY REPORT
Operable Unit 3 (Former Grumman Settling Ponds)
Bethpage, New York
NYSDEC ID # 1-30-003A



Albina Redzepagic
Task Manager



Christopher Engler, PE
Engineer of Record | New York PE-069748



Carlo San Giovanni
Project Manager

2019 ANNUAL SUMMARY REPORT

Operation, Maintenance, and Monitoring
Report for the Bethpage Park Soil Gas
Containment System

Operable Unit 3 (Former Grumman
Settling Ponds), Bethpage, New York
NYSDEC ID # 1-30-003A

Prepared for:
Northrop Grumman Systems Corporation

Prepared by:
Arcadis of New York, Inc.
Two Huntington Quadrangle
Suite 1S10
Melville
New York 11747
Tel 631 249 7600
Fax 631 249 7610

Our Ref.:
30037970

Date:
March 30, 2020

*This document is intended only for the use of
the individual or entity for which it was
prepared and may contain information that is
privileged, confidential and exempt from
disclosure under applicable law. Any
dissemination, distribution or copying of this
document is strictly prohibited.*

CONTENTS

1	Introduction.....	1
2	Bethpage Park Soil Gas Containment System Objectives	2
3	Bethpage Park Soil Gas Containment System Description	2
4	Operation and Maintenance Activities	3
4.1	Summary of O&M Completed During the Annual Reporting Period.....	3
4.2	Performance Evaluation.....	4
4.3	Conclusions and Recommendations for O&M.....	4
5	Monitoring.....	4
5.1	Summary of Monitoring Completed	4
5.2	Summary of Monitoring Results.....	5
5.2.1	Containment System Performance Monitoring.....	5
5.2.1.1	Annual Reporting Period System Operating Parameters.....	5
5.2.1.2	Vapor Screening	5
5.2.2	Containment System Compliance Monitoring	5
5.2.2.1	System Operating Parameters	5
5.2.2.2	Vapor Sample	5
5.2.2.3	Condensate Sample	6
5.2.3	Air Emissions Model	6
6	Conclusions and Recommendations	7
6.1	Conclusions.....	7
6.2	Recommendations	8
7	Certification	9
8	References.....	10

TABLES

Table 1	General System Operating Parameters
Table 2	Induced Vacuum Readings at Compliance Monitoring Points
Table 3	Total Effluent Vapor Sample Analytical Results
Table 4	Total Effluent Vapor Sample Analytical Results, Tentatively Identified Compounds
Table 5	Air Quality Impacts Analysis

FIGURES

Figure 1	Site Location Map
Figure 2	General Site Plan and Monitoring Well Vacuum Measurements, Bethpage Park Soil Gas Containment System Annual 2019
Figure 3	Process Flow Diagram, Bethpage Park Soil Gas Containment System
Figure 4	Soil Gas TVOC Concentrations
Figure 5	Cumulative Total, Project and Non-Project VOC Mass Removed
Figure 6	VOC Mass Recovery Rates

1 INTRODUCTION

Pursuant to the Administrative Order on Consent (AOC) Index #W1-0018-04-01 (New York State Department of Environmental Conservation [NYSDEC] 2005) and the Operable Unit 3 (OU3) Record of Decision (NYSDEC 2013), Arcadis of New York, Inc. (Arcadis), on behalf of Northrop Grumman Systems Corporation (Northrop Grumman), has prepared this OU3 Bethpage Park Soil Gas Containment System (BPSGCS) Annual Summary Report for submittal to the NYSDEC. The present-day Bethpage Community Park property (Park) and Plant 24 Access Driveway, which the NYSDEC has termed the “Former Grumman Settling Ponds Area” and designated as OU3, are referred to herein as the Site Area. Figure 1 provides a Site Area location map.

The BPSGCS (previously referred to as the Soil Gas Interim Remedial Measure [IRM]) has operated since February 18, 2008. The operation, maintenance, and monitoring (OM&M) activities performed during 2019 (i.e., January 1 through December 31, 2019 [the “annual reporting period”]) are summarized in this Annual Summary Report. Data summaries for the previous three 2019 operational quarterly periods are available in the following letter reports:

- Results of 2019 First Quarter Operation and Monitoring for the Bethpage Park Soil Gas Containment System, May 2019 (Arcadis 2019a)
- Results of 2019 Second Quarter Operation and Monitoring for the Bethpage Park Soil Gas Containment System, August 2019 (Arcadis 2019b)
- Results of 2019 Third Quarter Operation and Monitoring for the Bethpage Park Soil Gas Containment System, November 2019 (Arcadis 2019c)

During 2019, the BPSGCS system OM&M was conducted in accordance with the NYSDEC-approved OU3 Soil Gas IRM OM&M Manual (Arcadis 2016) and the NYSDEC-approved Sampling and Analysis Plan (SAP) (Arcadis 2016).

As discussed in the Remedial Investigation Report (RI Report), [Arcadis 2011], Northrop Grumman does not take responsibility for certain compounds (e.g., Freon 12 and Freon 22) present in the Site Area. Throughout this report, a distinction is made between the “Project” and “Non-project” volatile organic compounds (VOCs), which are defined as follows:

- **Project VOCs:** VOCs that may be related to former Northrop Grumman historical activities. For this report, Project VOCs include 1,1,1-trichloroethane; 1,1-dichloroethane; 1,2-dichloroethane; 1,1-dichloroethene; tetrachloroethene; trichloroethylene; vinyl chloride; cis-1,2-dichloroethene; trans-1,2-dichloroethene; benzene; toluene; and total xylenes.
- **Non-project VOCs:** VOCs, such as Freon 12 and Freon 22, which are understood to be unrelated to former Northrop Grumman activities but have been detected in the Site Area. As noted in the RI Report, a groundwater sub-plume of Freon 22 has been identified originating from the area of the Town of Oyster Bay’s (Town’s) former ice rink. Based on Town information (Zervos 2007), Freon 22 was used by the Town and released to the environment.

2 BETHPAGE PARK SOIL GAS CONTAINMENT SYSTEM OBJECTIVES

The remedial action objectives (RAOs) of the BPSGCS are as follows:

- To mitigate the off-site migration of Project VOCs in the on-site soil gas through the implementation of a soil gas containment system installed along the Plant 24 Access Driveway and McKay Field Access Road, south and west of the Park, respectively, and;
- To comply with applicable NYSDEC Standards, Criteria, and Guidelines (SCGs)

The compliance objectives of the BPSGCS are as follows:

- To mitigate the off-site migration of soil gas, the system was designed to maintain -0.1 inch of water column (iwc) within a negative pressure curtain established within the vadose zone along the Plant 24 Access Driveway and along the McKay Field Access Road, from the boundary of the Plant 24 Access Driveway to approximately 400 feet north along the MacKay Field Access Road, based on a 12-month rolling average.
- To treat extracted vapors until it is demonstrated that all VOCs in the influent (untreated) vapor stream are present at concentrations lower than the NYSDEC Division of Air Resources Guide-1 (DAR-1) Annual Guidance Concentrations (AGCs) on a 12-month rolling average and Short-term Guidance Concentrations (SGCs) for any given grab sample (NYSDEC 2016). On December 29, 2008, NYSDEC approved removal of vapor phase treatment (NYSDEC 2008).
- To manage condensate via one of the following two methods: (1) collect and convey condensate to the Town of Oyster Bay's Cedar Creek treatment facility via the Nassau County Department of Public Works (NCDPW) sanitary sewer, in accordance with the requirements set forth by the NCDPW (NCDPW 2007, 2008), or (2) collect and convey to the Bethpage Park Groundwater Containment System (BPGWCS) treatment system that discharges treated groundwater to the NCDPW recharge basins west of the site.

3 BETHPAGE PARK SOIL GAS CONTAINMENT SYSTEM DESCRIPTION

Following review and approval of the Soil Gas IRM 95% Design Report and Design Drawings by the NYSDEC (Arcadis 2007b), the design package was finalized and the BPSGCS constructed. A general site plan (Figure 2) shows the treatment building, which houses the major process equipment, including two 20-horsepower (hp) and one 30 hp regenerative-type depressurization blowers, and three 52-gallon moisture separators and associated transfer pumps. Remaining system components are located outside the treatment building and include one 35.65-foot tall by 16-inch diameter effluent stack, one heat exchanger, the 18 depressurization wells, and the 47 induced vacuum monitoring wells, also shown on Figure 2. Monitoring well vacuum measurements collected during 2019 are also provided on Figure 2. A process flow diagram that shows sampling and monitoring locations is provided as Figure 3. A detailed

description of the system and a complete set of record drawings are provided in the OM&M Manual (Arcadis 2016).

4 OPERATION AND MAINTENANCE ACTIVITIES

The following sections summarize the routine and non-routine operation and maintenance (O&M) activities completed during the annual reporting period (Section 4.1); the performance evaluation of the BPSGCS (Section 4.2); and the conclusions and recommendations regarding O&M for the BPSGCS (Section 4.3).

4.1 Summary of O&M Completed During the Annual Reporting Period

The O&M of the BPSGCS was conducted in accordance with the OM&M Manual (Arcadis 2016a), and consisted of the following routine maintenance/activities:

- Continuous monitoring of system performance parameters by the Supervisory Control and Data Acquisition (SCADA) system.
- Weekly site checks to monitor and record key process parameters to evaluate system operation, to assess whether a process parameter has changed or is out of range, and to provide information that may be helpful to identify and/or troubleshoot an operational concern.
- Quarterly monitoring events to monitor and record key process parameters (including induced vacuums), to confirm proper system operation, make adjustments as needed, and to collect vapor samples to demonstrate operational compliance. A summary of the quarterly monitoring data collected for the BPSGCS is provided in Tables 1, 2, 3 and 4.
- Routine maintenance of equipment was generally performed in accordance with the manufacturers' specifications as needed.
- Maintenance of equipment and system components in response to alarm conditions or system parameters operating outside of their normal operating ranges. These conditions did not have a significant impact on system performance and have been proactively addressed to minimize system downtime.

During the annual reporting period, condensate removal was conducted during routine BPSGCS maintenance. Collected condensate was treated at the BPGWCS and discharged along with the treated groundwater to the NCDPW recharge basins west of the site. As of 2015, condensate removal is conducted, as needed, by manipulating manifold vacuums and flow rates for brief periods of time. This process does not entirely vacate the below grade lines of condensate, though it enables the system to maintain adequate flow and vacuum at the manifolds without requiring a vacuum truck and a full day shutdown event.

The following non-routine activities occurred during the annual reporting period:

- Non-routine system shutdown from July 16 to July 18, 2019 shutdown due to failed power supply and equipment calibrations.

4.2 Performance Evaluation

The OU3 BPSGCS operated continuously during the annual reporting period with the exception of brief shutdown events for routine and non-routine system maintenance. An operational summary of the depressurization wells, monitoring wells, flow rates and vacuums for the annual reporting period are provided in Tables 1 and 2. In summary:

- The system operated during the annual reporting period for approximately 363 days out of a total 365 days (99.5% uptime).
- An annual rolling average vacuum of -0.1 iwc or greater was maintained at all induced vacuum monitoring points throughout the annual reporting period. Data recorded at several wells indicated that vacuum induced at the well heads was slightly less than the targeted -0.1 iwc, during November 2019. Northrop Grumman will continue to proactively manage this issue through condensate removal and system rebalancing of the manifold flow.

4.3 Conclusions and Recommendations for O&M

The O&M activities conducted during the annual reporting period met the requirements of the O&M Manual.

5 MONITORING

The following sections summarize the monitoring completed during the annual reporting period (Section 5.1); the 2019 monitoring data, comparisons of the results with applicable AGCs and SGCs, and additional data evaluations describing the performance effectiveness of the OU3 BPSGCS (Section 5.2); and the conclusions and recommendations regarding monitoring for the Site (Section 5.3).

5.1 Summary of Monitoring Completed

In general, the monitoring of the OU3 BPSGCS was completed in accordance with the OU3 BPSGCS OM&M Manual (Arcadis 2016). A summary of the monitoring completed during this annual reporting period is provided below:

- Quarterly system performance monitoring:
 - Instantaneous vacuum measurements at compliance measurement points and system operating measurements at influent manifolds, blower inlet and outlet, and system effluent were collected to assess the system performance. Summaries of the measurements are provided in Tables 1 and 2.
- Quarterly system compliance monitoring:

- Containment system air quality monitoring was completed to monitor the performance of the containment system and to compare the levels to applicable AGCs and SGCs. Summaries of the results are provided in Tables 3, 4, and 5.

5.2 Summary of Monitoring Results

5.2.1 Containment System Performance Monitoring

5.2.1.1 Annual Reporting Period System Operating Parameters

System operating parameters measured during the annual reporting period are summarized in Tables 1 and 2. The system components generally operated within their recommended ranges during the annual reporting period.

5.2.1.2 Vapor Screening

The total effluent screening level vapor samples (i.e., photoionization detector [PID] reading) measured during the annual reporting period are provided in Table 1. The screening results were non-detect throughout the annual reporting period.

5.2.2 Containment System Compliance Monitoring

5.2.2.1 System Operating Parameters

Instantaneous vacuum measurements in compliance monitoring wells from the annual reporting period and annual time-weighted rolling averages are summarized in Table 2. Quarterly vacuum measurement data from the annual reporting period are also shown on Figure 2.

As shown on Table 2, during the annual reporting period, the instantaneous induced vacuum at all compliance-related monitoring points met or exceeded the minimum performance standard (greater than or equal to -0.1 iwc), with the exceptions of VMWC-14A, VMWC-15D, VMWC-18A, and VMWC-18B. Although these instantaneous induced vacuum measurements were slightly lower than -0.1 iwc, the annual time-weighted rolling average of induced vacuum readings at all compliance-related monitoring points were maintained at greater than or equal to -0.1 iwc. Therefore, the BPSGCS is meeting the operational compliance objectives.

5.2.2.2 Vapor Sample

Effluent vapor samples were collected on a quarterly basis throughout the annual reporting period. The total volatile organic compound (TVOC) concentrations ranged from 240 micrograms per cubic meter ($\mu\text{g}/\text{m}^3$) in November 2019 to 758 $\mu\text{g}/\text{m}^3$ in June 2019, as shown in Table 3. The Project TVOC concentrations ranged from 207 $\mu\text{g}/\text{m}^3$ in November 2019 to 632 $\mu\text{g}/\text{m}^3$ in June 2019. The Non-project TVOC concentrations ranged from 33 $\mu\text{g}/\text{m}^3$ in November 2019 to 187 $\mu\text{g}/\text{m}^3$ in March 2019.

The TVOC concentration in effluent vapor has generally declined since system startup. Figure 4 provides an overview of the concentration trend over the report period. During the reporting period the containment system has removed 18.9 pounds of TVOCs, with 14.7 pounds of Project TVOCs (77.8%) and 4.2 pounds of Non-project TVOCs (22.2 %). The containment system has removed a total of 379.2 pounds of TVOCs, 302.2 pounds of Project TVOCs (79.7%), and 77.0 pounds of Non-project TVOCs (20.3%) since startup in February 18, 2008, as shown on Figure 5. Figure 6 presents the mass removal rate, which has declined since system startup.

Benzene, carbon tetrachloride, trichloroethene (trichloroethylene) and vinyl chloride, classified as environmentally "A"-rated compounds as defined in DAR-1 AGC/SGC tables (NYSDEC 2016), were detected in the effluent vapor sample during the annual reporting period and the concentrations were consistent with historical data.

The concentrations of the tentatively identified compounds (TICs) were consistent with data collected throughout previous annual reporting periods. A total of 2 TICs were identified during the annual reporting period as shown in Table 4. The most common TIC identified over the annual reporting period was carbon dioxide.

5.2.2.3 Condensate Sample

Collection of a compliance monitoring condensate sample was not required during the annual reporting period as all condensate was transferred to the BPGWCS system for treatment.

5.2.3 Air Emissions Model

Vapor concentrations for the annual period were compared with the degree of cleaning required pursuant to 6NYCRR III A Part 212-2.3(b) (Rule 212), Table 4 - Degree of Air Cleaning Required for Non-Criteria Air Contaminants. Concentrations of all compounds detected during the Fourth Quarter were less than 13,934 $\mu\text{g}/\text{m}^3$ (concentration equivalent to 0.1 pounds per hour at a flow rate of 1,920 cubic feet per minute), as shown in Table 5 of this report. Therefore, in accordance with the requirements of Table 4 of the NYSDEC regulations, air dispersion modeling was performed to demonstrate that the maximum off-site air concentration is less than the NYSDEC DAR-1 AGC/SGC values issued August 10, 2016.

The U.S. Environmental Protection Agency (USEPA) air quality dispersion model AERMOD was executed to estimate the highest ambient air concentration of the compounds detected during the Fourth Quarter. AERMOD is the USEPA's recommended best state-of-the-art practice Gaussian plume dispersion model. Gaussian models are the most widely used techniques for estimating the impact of non-reactive pollutants, per Appendix W of Title 40 Code of Federal Regulations (CFR) 51 – Guideline of Air Quality Models.

The following parameters were used for the AERMOD model analysis:

- Urban dispersion coefficients
- AERMAP base and terrain elevations, processed using National Elevation Dataset (NED) digitized terrain data

- Surface and upper air observations measured at the Nation Weather Service stations located at Farmingdale and Brookhaven airports for calendar years 2011-2015, in accordance with NYSDEC's DAR-10 Air Dispersion Modeling Guidance Document. This longer period of time was reviewed for the model run, to provide a conservative estimate of atmospheric impacts on the off-site concentrations.
- Discrete receptor grids, per the following methodology:
 - Receptors were located along the property boundary at distances not exceeding 25 meters;
 - A 1.5 km x 1.5 km Cartesian grid receptors with distances of 50 meters between the receptors; and
 - A 3.0 km x 3.0 km Cartesian grid receptors with distances of 100 meters between the receptors.
- Emission rate: 1 gram per second (g/s)

Vapor concentrations for the annual period were compared to 6NYCRR III A Part 212-2.3(b), Table 4 – Degree of Air Cleaning Required for Non-Criteria Air Contaminants. Concentrations of all compounds detected during the Fourth Quarter were less than 13,934 µg/m³ (concentration equivalent to 0.1 pounds per hour at a flow rate of 1,920 cubic feet per minute), as shown in Table 5 of this report. In accordance with the requirements of Table 4 of the NYSDEC regulations, air dispersion modeling was performed to demonstrate that the maximum off-site air concentration is less than the NYSDEC DAR-1 AGC/SGC values, issued August 10, 2016.

Based on the ambient modeling analysis conducted in the annual reporting period, the BPSGCS continues to meet all of the requirements for DAR-1 and is below the Rule 212 requirements without add on controls (i.e. vapor phase GAC treatment).

6 CONCLUSIONS AND RECOMMENDATIONS

6.1 Conclusions

The following conclusions are provided regarding the performance and ability of the OU3 BPSGCS to comply with the remedial action and compliance objectives:

- OM&M requirements of the OU3 BPSGCS OM&M Manual were met during the annual reporting period.
- The BPSGCS generally operated as designed during the annual reporting period to mitigate the off-site migration of soil gas.
 - The BPSGCS operated continuously with the exception of brief shutdown periods for routine and non-routine maintenance (99.5% uptime).
 - A total of 18.9 pounds of VOCs were removed from the subsurface during the annual reporting period, and a total of 379.2 pounds of VOCs were removed since system startup in 2008.

- An annual rolling average vacuum of -0.1 iwc or greater was maintained at all induced vacuum monitoring points throughout the annual reporting period. Data recorded at some wells indicated that vacuum induced at the well heads was slightly less than the targeted -0.1 iwc, during March and November 2019. Northrop Grumman will continue to proactively manage this issue through condensate removal and system rebalancing of the manifold flow.
- The operation of the BPSGCS complied with applicable NYSDEC SCGs during the annual reporting period.
- Effluent vapor emissions met applicable AGC and SGC air discharge criteria during the annual reporting period. Based on the ambient modeling analysis conducted in the annual reporting period, the BPSGCS continues to meet all of the requirements for DAR-1 and is below the Rule 212 requirements without add on controls (i.e. vapor phase GAC treatment).

6.2 Recommendations

Based on the information provided herein, Arcadis recommends to continue operation of the BPSGCS, to maintain compliance with the RAOs. No modifications or upgrades are needed at this time.

7 CERTIFICATION

Statement of Certification

On behalf of Northrop Grumman Systems Corporation, I hereby certify and attest that the Operable Unit 3 Bethpage Park Soil Gas Containment System is operated in compliance with the remedial action objectives provided within the NYSDEC approved Soil Gas Interim Remedial Measure Work Plan (Arcadis 2007a), which was prepared pursuant to NYSDEC Administrative Order on Consent Index # W1-0018-04-01 (NYSDEC 2005) referencing the Former Grumman Settling Ponds Site and dated July 4, 2005.

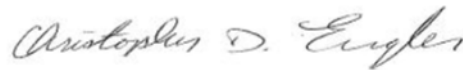

Christopher Engler, P.E.
Engineer of Record
License # 069748

8 REFERENCES

- Arcadis of New York, Inc. 2007a. Operable Unit 3 – Soil Gas Interim Remedial Measure Work Plan, Former Grumman Settling Ponds, Bethpage, New York, Site #1-30-003A. February 16, 2007.
- Arcadis of New York, Inc. 2007b. 95% Design Report, Operable Unit 3 Soil Gas Interim Remedial Measure, Former Grumman Settling Ponds, Bethpage, New York, Site #1-30-003A. September 7, 2007.
- Arcadis of New York, Inc. 2016 Operable Unit 3, Operation, Maintenance, and Monitoring Manual, Bethpage Park Soil Gas Containment System (Formerly Soil Gas Interim Remedial Measure), Former Grumman Settling Ponds, Bethpage, New York, Site #1-30-003A. Revision 3: March 17, 2016.
- Arcadis of New York, Inc. 2011. Remedial Investigation Report (Site Area), Operable Unit 3 (Former Grumman Settling Ponds), Bethpage, New York, Site #1-30-003A. Revised: February 8, 2011.
- Arcadis of New York, Inc. 2019a. Results of First Quarter 2019 Operation and Monitoring for the Bethpage Park Soil Gas Containment System, Operable Unit 3 (Former Grumman Settling Ponds), Bethpage, New York, Site #1-30-003A.
- Arcadis of New York, Inc. 2019b. Results of Second Quarter 2019 Operation and Monitoring for the Bethpage Park Soil Gas Containment System, Operable Unit 3 (Former Grumman Settling Ponds), Bethpage, New York, Site #1-30-003A.
- Arcadis of New York, Inc. 2019c. Results of Third Quarter 2019 Operation and Monitoring for the Bethpage Park Soil Gas Containment System, Operable Unit 3 (Former Grumman Settling Ponds), Bethpage, New York, Site #1-30-003A.
- County of Nassau Department of Public Works (NCDPW). 2007. Letter Regarding Discharge of IRM Condensate Water, Northrop Grumman, OU3 Site, Bethpage, New York. October 16, 2007.
- NCDPW. 2008. Letter Regarding Discharge of IRM Condensate Water Northrop, Grumman, OU3 Site, Bethpage, New York. September 17, 2008.
- New York State Department of Environmental Conservation (NYSDEC). 2005. Order on Consent Index #WI-0018-04-01, Site # 1-30-003A. July 4, 2005.
- NYSDEC. 2008. Letter of Approval For Proposed Modifications. December 12, 2008.
- NYSDEC. 2013. Record of Decision. Northrop Grumman – Bethpage Facility, Operable Unit Number: 03, State Superfund Project, Bethpage, Nassau County, Site #1-30-003A. March, 2013.
- NYSDEC. 2016. DAR-1 AGC/SGC Tables. Revised August 10, 2016.
- Zervos, Theodore. 2007. Deposition of Theodore Zervos in the matter Town of Oyster Bay v. Northrop Grumman Systems Corporation et al. Case No. 05-CV-1945 (TCP)(AKT). January 22, 2007.

TABLES



Table 1
General System Operating Parameters
Bethpage Park Soil Gas Containment System
Operable Unit 3 (Former Grumman Settling Ponds)
Bethpage, New York

Date	DW-7S Parameters			DW-7D Parameters			DW-3S Parameters			DW-3D Parameters			DW-5S Parameters			DW-5D Parameters			DW-6S Parameters			DW-6D Parameters		
	Flow Rate at Manifold	Vacuum at Manifold	Wellhead Vacuum	Flow Rate at Manifold	Vacuum at Manifold	Wellhead Vacuum	Flow Rate at Manifold	Vacuum at Manifold	Wellhead Vacuum	Flow Rate at Manifold	Vacuum at Manifold	Wellhead Vacuum	Flow Rate at Manifold	Vacuum at Manifold	Wellhead Vacuum	Flow Rate at Manifold	Vacuum at Manifold	Wellhead Vacuum	Flow Rate at Manifold	Vacuum at Manifold	Wellhead Vacuum	Flow Rate at Manifold	Vacuum at Manifold	Wellhead Vacuum
	scfm	iwc	iwc	scfm	iwc	iwc	scfm	iwc	iwc	scfm	iwc	iwc	scfm	iwc	iwc	scfm	iwc	iwc	scfm	iwc	iwc	scfm	iwc	iwc
3/20/19	77	-19	-1.4	6.0	-24.0	-0.36	17.0	-7.5	-0.38	8.0	-11.0	-0.39	53	-18.0	-0.73	15	-9	-2.4 ⁽⁴⁾	85	-17	-1.8	8.0	-6.0	-1.4 ⁽³⁾
6/27/19	100	-18	-1.8	7.0	-7.0	-0.52	7.0	-5.0	-0.27	12.0	-9.0	-0.47	71	-11.5	-0.85	13	-8	-1.8	68	-14	-1.4	6.4	-5.4	-1.5
9/10/19	98	-17	-1.8	7.0	-7.0	-0.52	6.0	-7.5	-0.25	11.5	-9.5	-0.46	70	-11.5	-0.82	13	-7	-1.7	67	-13	-1.4	6.2	-5.2	-1.4
11/26/19	85	-22	-1.6	5.0	-14.0	-0.48	6.0	-5.0	-0.27	11.0	-10.0	-0.47	70	-12.5	-0.99	15	-9	-2.2	87	-19	-1.7	6.9	-5.0	-1.4

Abbreviations, Notes, and Units on last page.

Table 1
General System Operating Parameters
Bethpage Park Soil Gas Containment System
Operable Unit 3 (Former Grumman Settling Ponds)
Bethpage, New York

Date	DW-1S Parameters			DW-1D Parameters			DW-4S Parameters			DW-4D Parameters			DW-8S Parameters			DW-9S Parameters			DW-2S Parameters			DW-2D Parameters		
	Flow Rate at Manifold	Vacuum at Manifold	Wellhead Vacuum	Flow Rate at Manifold	Vacuum at Manifold	Wellhead Vacuum	Flow Rate at Manifold	Vacuum at Manifold	Wellhead Vacuum	Flow Rate at Manifold	Vacuum at Manifold	Wellhead Vacuum	Flow Rate at Manifold	Vacuum at Manifold	Wellhead Vacuum	Flow Rate at Manifold	Vacuum at Manifold	Wellhead Vacuum	Flow Rate at Manifold	Vacuum at Manifold	Wellhead Vacuum	Flow Rate at Manifold	Vacuum at Manifold	Wellhead Vacuum
	scfm	iwc	iwc	scfm	iwc	iwc	scfm	iwc	iwc	scfm	iwc	iwc	scfm	iwc	iwc	scfm	iwc	iwc	scfm	iwc	iwc	scfm	iwc	iwc
3/20/19	100	-24	-2.6	6.4	-3.0	-2.0	60	-15	-1.7	11.0	-6.5	-0.83	75	-24	-2.3	65	-20	-3.0	40	-30	-2.3	35	-20	-2.2
6/27/19	67	-21	-1.6	5.2	-3.0	-1.6	83	-16	-1.1	7.5	-7.0	-0.74	77	-20	-2.4	40	-13	-1.6	49	-32	-2.5	39	-23	-2.5
9/10/19	74	-19	-1.7	5.1	-3.0	-1.3	78	-16	-1.6	7.5	-5.5	-0.73	55	-15	-1.7	38	-13	-1.6	48	-32	-2.5	38	-23	-2.5
11/26/19	90	-21	-2.1	5.1	-3.0	-1.8	82	-16.5	-1.8	7.0	-6.0	-0.76	68	-21	-2.3	37	-10	-1.6	29	-21	-1.6	39	-24	-2.6

Abbreviations, Notes, and Units on last page.

Table 1
General System Operating Parameters
Bethpage Park Soil Gas Containment System
Operable Unit 3 (Former Grumman Settling Ponds)
Bethpage, New York

Date	DW-10S Parameters			DW-11S Parameters			Knock Out Tank Parameters - Vacuum			Condensate Water Collected ⁽¹⁾	Blower Parameters BL-200			Blower Parameters BL-300			Blower Parameters BL-400			Combined Effluent Parameters				
	Flow Rate at Manifold	Vacuum at Manifold	Wellhead Vacuum	Flow Rate at Manifold	Vacuum at Manifold	Wellhead Vacuum	Influent KO-200	Influent KO-300	Influent KO-400	Influent ST-510	Influent Vacuum	Effluent Pressure	Blower Speed	Influent Vacuum	Effluent Pressure	Blower Speed	Influent Vacuum	Effluent Pressure	Blower Speed	Total Effluent Flow Rate ⁽²⁾	Total Effluent PID	Heat Exchanger Influent Temp.	Total Effluent Pressure	Heat Exchanger Effluent Temp.
	scfm	iwc	iwc	scfm	iwc	iwc	iwc	iwc	iwc	Gallons	iwc	iwc	Hz	iwc	iwc	Hz	iwc	iwc	Hz	scfm	ppmv	°F	iwc	°F
3/20/19	50	-18	-2.2	24 ⁽⁵⁾	-35	-0.75	-45	NA	NA	105	-58.0	-1.0	59	NA	NA	NA	NA	NA	NA	715	0.1	103	2.0	91
6/27/19	35	-14	-1.5	35	-23	-2.5	-44	NA	NA	60	-47.0	-4.0	59	NA	NA	NA	NA	NA	NA	670	0.8	120	2.0	111
9/10/2019 ⁽⁶⁾	34	-14	-1.9	30	-26	-2.8	-41.5	NA	NA	0	-44.0	NM ⁽⁷⁾	59	NA	NA	NA	-5	14	60	1516	0.1	125	13.0	111
11/26/19	35	-18	-1.9	25 ⁽⁸⁾	-35	-0.5	-43	NA	NA	140	-46.4	-14.1	59	NA	NA	NA	-5	12	60	1920	0.0	117	12.0	106

Abbreviations, Notes, and Units on last page.

Table 1
General System Operating Parameters
Bethpage Park Soil Gas Containment System
Operable Unit 3 (Former Grumman Settling Ponds)
Bethpage, New York

Abbreviations, Notes, and Units:

DW	Depressurization Well
NA	Not Applicable
NM	Not Measured

1. Total gallons of water accumulated at storage tank ST-510 per quarter are based on storage tank level and condensate removed as documented in site operator condensate discharge logs.
2. Total effluent air velocity in feet per minute was measured using a hand-held anemometer at the stack effluent location. The total effluent flow rate in scfm was calculated by multiplying the measured air velocity by the pipe area, the ratio of the standard air temperature to the measured air temperature, and the ratio of the measured air pressure to the standard air pressure.
3. Monitoring point was confirmed to be in vacuum on a second event on April 11, 2019 following condensate removal and system rebalancing.
4. Monitoring point was confirmed to be in vacuum on a third event on April 25, 2019 due to calibration maintenance during the April 11, 2019 event.
5. Reading taken by site operator on March 18, 2019.
6. On 08/14/19, the system began operating with two active blowers to increase system effluent flow rate.
7. Pressure not measured due to broken BL-200 effluent pressure gauge.
8. Reading estimated due to gauge variability.

°F	degrees Fahrenheit
Hz	Hertz
iwc	inches of water column
scfm	standard cubic feet per minute

Table 2
Summary of Induced Vacuum Readings at Compliance Monitoring Points
Bethpage Park Soil Gas Containment System
Operable Unit 3 (Former Grumman Settling Ponds)
Bethpage, New York

Well ID:	DW-7S		DW-7D	DW-3S	DW-3D	DW-5S		DW-5D	DW-1S			DW-1D	DW-4D	DW-8S		DW-2S		DW-2D		DW-11S	
MP ID:	VMWC-14A	VMWC-14B	VMWC-14D	VMWC-11B	VMWC-12D	VMWC-15A	VMWC-15B	VMWC-15D	VMWC-3A	VMWC-3B	VMWC-3C	VMWC-3D	VMWC-16D	VMWC-16A	VMWC-16B	VMWC-7A	VMWC-7B	VMWC-13D	VMWC-17D	VMWC-18A	VMWC-18B
Date	iwc	iwc	iwc	iwc	iwc	iwc	iwc	iwc	iwc	iwc	iwc	iwc	iwc	iwc	iwc	iwc	iwc	iwc	iwc	iwc	iwc
03/20/19	-0.08 ⁽³⁾	-0.12	-0.16	-0.10	-0.11	-0.11	-0.11	-0.15 ⁽³⁾	-0.15	-0.17	-0.15	-0.14	-0.19	-0.17	-0.18	-1.53 ⁽⁵⁾	-0.43	-0.15	-0.14	-0.11 ⁽⁴⁾	-0.11
06/27/19	-0.12	-0.21	-0.21	-0.12	-0.12	-0.11	-0.11	-0.11	-0.13	-0.14	-0.14	-0.16	-0.82	-0.43	-0.87	-0.55	-0.38	-0.21	-0.20	-0.13	-0.42
09/10/19	-0.11	-0.19	-0.20	-0.10	-0.10	-0.12	-0.12	-0.13	-0.11	-0.13	-0.14	-0.13	-0.22	-1.78	-0.14	-0.14	-0.14	-0.17	-0.22	-0.10	-0.13
11/26/19 ⁽⁵⁾	-0.95	-0.19	-0.19	-0.12	-0.11	-0.12	-0.10	-0.07	-0.14	-0.14	-0.15	-1.41	-0.25	-0.20	-0.22	-0.10	-0.40	-0.25	-0.26	-0.03	-0.03
Time Weighted Rolling Average⁽¹⁾	-0.25	-0.17	-0.18	-0.11	-0.11	-0.11	-0.11	-0.12	-0.13	-0.15	-0.15	-0.38	-0.35	-0.52	-0.34	-0.78	-0.36	-0.19	-0.19	-0.10	-0.17

Gross Average Compliance Points^(1/2)	
11/26/19	-0.23

Abbreviations, Notes, and Units:

DW Depressurization Well
iwc inches of water column
VMWC Vapor Monitoring Well Cluster

1. Compliance goal is -0.1 iwc of vacuum at all compliance monitoring points, based on a twelve-month rolling average. Time weighted rolling average calculated by summing the products of the instantaneous induced vacuum readings and the number of days between readings for a 12-month monitoring period, and dividing by the total time period between the first and last quarterly induced vacuum readings.
2. Gross average compliance points calculated by summing the induced vacuum values for the noted monitoring event and dividing by the number of readings.
3. Monitoring point was confirmed to be in vacuum on a second event on April 11, 2019 following condensate removal and system rebalancing.
4. Monitoring point was confirmed to be in vacuum on a third event on April 25, 2019 following instrument calibration maintenance during the April 11, 2019 event.
5. Monitoring point vacuum was collected before condensate removal and system rebalancing.

Table 3
Total Effluent Vapor Sample Analytical Results
Bethpage Park Soil Gas Containment System
Operable Unit 3 (Former Grumman Settling Ponds)
Bethpage, New York

Compound (units in µg/m ³)	Sample ID ¹ : Sample Date:	VSP-601 3/20/2019	VSP-601 6/27/2019	VSP-601 9/10/2019	VSP-601 11/26/2019
Project VOCs					
	CAS No.				
1,1,1-Trichloroethane	71-55-6	5.5	4.9	4.8	3.9
1,1-Dichloroethane	75-34-3	6.1	5.3	3.6	3.7
1,1-Dichloroethene	75-35-4	1.1	0.79	< 0.16	< 0.16
1,2-Dichloroethane	107-06-2	< 1.6	< 0.81	< 0.81	< 0.81
Benzene	71-43-2	1.8	< 0.64	< 0.64	0.7
cis-1,2-Dichloroethene	156-59-2	189	324	79.7	67.8
Tetrachloroethene	127-18-4	31	8.8	6.2	3.8
Toluene	108-88-3	15	< 0.75	1.8	< 0.75
trans-1,2-Dichloroethene	156-60-5	1.4 J	1.8	1.2	1.1
Trichloroethylene	79-01-6	254	286	173	126
Vinyl chloride	75-01-4	1.0	0.54	< 0.10	< 0.10
Xylenes - O	95-47-6	< 1.7	< 0.87	< 0.87	< 0.87
Xylenes - M,P	1330-20-7	0.83 J	< 0.87	0.52 J	< 0.87
Subtotal Project VOCs		507	632	271	207
Non-Project VOCs					
1,1,2,2-Tetrachloroethane	79-34-5	< 1.4	< 0.69	< 0.69	< 0.69
1,1,2-Trichloroethane	79-00-5	3.2	< 0.55	< 0.55	< 0.55
1,2-Dichloropropane	78-87-5	< 1.8	< 0.92	< 0.92	< 0.92
1,3-Butadiene	106-99-0	< 0.88	< 0.44	< 0.44	< 0.44
1-Chloro-1,1-difluoroethane (Freon 142B)	75-68-3	53.8	106	58.8	19
2-Butanone	78-93-3	< 1.2	0.83	1.4	< 0.59
2-Hexanone	591-78-6	< 1.6	< 0.82	< 0.82	< 0.82
4-Methyl-2-Pentanone	108-10-1	< 1.6	< 0.82	0.70 J	< 0.82
Acetone	67-64-1	2.6	4.0	26.8	4.5
Bromodichloromethane	75-27-4	< 1.3	< 0.67	< 0.67	< 0.67
Bromoform	75-25-2	< 0.83	< 0.41	< 0.41	< 0.41
Bromomethane	74-83-9	< 1.6	< 0.78	< 0.78	< 0.78
Carbon Disulfide	75-15-0	< 1.2	< 0.62	< 0.62	< 0.62
Carbon Tetrachloride	56-23-5	59	0.75	0.75	< 0.25
Chlorobenzene	108-90-7	< 1.8	< 0.92	< 0.92	< 0.92
Chlorodibromomethane	124-48-1	< 1.7	< 0.85	< 0.85	< 0.85
Chloroethane	75-00-3	< 1.1	< 0.53	< 0.53	< 0.53
Chlorodifluoromethane (Freon 22)	75-45-6	< 1.4	1.1	< 0.70	0.88
Chloroform	67-66-3	62.5	8.8	4.9	7.8
Chloromethane	74-87-3	< 0.83	< 0.41	< 0.41	< 0.41
cis-1,3-Dichloropropene	10061-01-5	< 1.8	< 0.91	< 0.91	< 0.91
Dichlorodifluoromethane (Freon 12)	75-71-8	2.2	2.1	< 0.99	< 0.99
Ethylbenzene	100-41-4	< 1.7	< 0.87	< 0.87	< 0.87
Methylene Chloride	75-09-2	2.0	0.97	1.0	< 0.69
Methyl Tert-Butyl Ether	1634-04-4	< 1.4	< 0.72	< 0.72	< 0.72
Styrene	100-42-5	< 1.7	< 0.85	< 0.85	< 0.85
trans-1,3-Dichloropropene	10061-02-6	< 1.8	< 0.91	< 0.91	< 0.91
Trichlorofluoromethane (Freon 11)	75-69-4	1.3	1.8	< 0.56	1.1
Trichlorotrifluoroethane (Freon 113)	76-13-1	< 1.5	< 0.77	< 1.5	< 0.77
Subtotal Non-Project VOCs		187	126	94	33
TVOC²		693	758	365	240

Abbreviations, Notes, Qualifiers, and Units on last page.

Table 3
Total Effluent Vapor Sample Analytical Results
Bethpage Park Soil Gas Containment System
Operable Unit 3 (Former Grumman Settling Ponds)
Bethpage, New York

Abbreviations, Notes, Qualifiers, and Units:

CAS No.	Chemical Abstracts Service list number
ELAP	Environmental Laboratory Approval Program
NYSDOH	New York State Department of Health
NYSDEC	New York State Department of Environmental Conservation.
TVOC	Total Volatile Organic Compounds
USEPA	United States Environmental Protection Agency
VOC	Volatile Organic Compound

1. Vapor samples collected by Arcadis and submitted to a NYSDOH ELAP certified laboratory for VOC analyses per Modified USEPA Method TO-15.
2. TVOC determined by summing individual detections and rounding to the nearest whole number.

4.8	Bolding indicates that the analyte was detected at or above laboratory reporting limit
< 0.16	Compound not detected above its laboratory quantification limit
J	Compound detected below laboratory reporting limit; result is estimated
$\mu\text{g}/\text{m}^3$	micrograms per cubic meter

Table 4
Total Effluent Vapor Sample Analytical Results
Tentatively Identified Compounds
Bethpage Park Soil Gas Containment System
Operable Unit 3 (Former Grumman Settling Ponds)
Bethpage, New York

	Sample ID:	VSP-601	VSP-601	VSP - 601	VSP - 601
	Sample Date ¹ :	3/20/2019	6/27/2019	9/10/2019	11/26/2019
	Units:	ppbv	ppbv	ppbv	ppbv
Tentatively Identified Compounds²					
Carbon Dioxide		1,300 JB	29 JNB	87 JB	12 JNB
Alkane		ND	ND	ND	5.4 J

Abbreviations, Notes, Qualifiers, and Units:

ND	Not Detected
ELAP	Environmental Laboratory Approval Program
NYSDOH	New York State Department of Health
USEPA	U.S. Environmental Protection Agency
VOC	Volatile Organic Compound

1. Vapor samples collected by Arcadis on the dates shown and submitted to a NYSDOH ELAP certified laboratory for VOC analyses per Modified USEPA Method TO-15.

2. Tentatively identified compounds are identified based on review of mass spectrometry results via a comprehensive library search of all organic compounds.

B	Indicates analyte found in associated method blank
J	Indicates an estimated value
JN	Compound tentatively identified, concentration is estimated
ppbv	parts per billion by volume

Table 5
Air Quality Impact Analysis
Bethpage Park Soil Gas Containment System
Operable Unit 3 (Former Grumman Settling Ponds)
Bethpage, New York

Toxic Air Contaminant ⁽⁴⁾	CAS#	VSP-601 Vapor Effluent (µg/m ³) 11/26/2019	Emission Rate ¹			Scaled Impact - Hourly ² (µg/m ³)	Scaled Impact - Annual ² (µg/m ³)	SGC ³ (µg/m ³)	AGC ³ (µg/m ³)	% of SGC	% of AGC
			lb/yr	lb/hr	g/s						
Project VOCs											
1,1,1 - Trichloroethane	71-55-6	3.9	2.5E-01	2.8E-05	3.5E-06	1.6E-03	7.1E-05	9,000	5,000	0.0%	0.0%
1,1 - Dichloroethane	75-34-3	3.7	2.3E-01	2.7E-05	3.3E-06	1.5E-03	6.7E-05	NS	0.63	NS	0.0%
Benzene	71-43-2	0.7	4.4E-02	5.0E-06	6.3E-07	2.9E-04	1.3E-05	1300	0.13	0.0%	0.0%
cis- 1,2-Dichloroethene	156-59-2	67.8	4.3E+00	4.9E-04	6.1E-05	2.8E-02	1.2E-03	NS	63	NS	0.0%
Tetrachloroethene	127-18-4	3.8	2.4E-01	2.7E-05	3.4E-06	1.6E-03	6.9E-05	300	4	0.0%	0.0%
trans- 1,2-Dichloroethene	156-60-5	1.1	6.9E-02	7.9E-06	9.9E-07	4.6E-04	2.0E-05	NS	63	NS	0.0%
Trichloroethene	79-01-6	126	7.9E+00	9.0E-04	1.1E-04	5.3E-02	2.3E-03	20	0.2	0.3%	1.1%
Non-Project VOCs											
1-Chloro-1,1-difluoroethane (Freon 142B)	75-68-3	19	1.2E+00	1.4E-04	1.7E-05	8.0E-03	3.4E-04	NS	50,000	NS	0.0%
Acetone	67-64-1	4.5	2.8E-01	3.2E-05	4.1E-06	1.9E-03	8.1E-05	180,000	30,000	0.0%	0.0%
Chlorodifluoromethane (Freon 22)	75-45-6	0.88	5.5E-02	6.3E-06	8.0E-07	3.7E-04	1.6E-05	--	50,000	--	0.0%
Chloroform	67-66-3	7.8	4.9E-01	5.6E-05	7.1E-06	3.3E-03	1.4E-04	150	15	0.0%	0.0%
Trichlorofluoromethane (Freon 11)	75-69-4	1.1	6.9E-02	7.9E-06	9.9E-07	4.6E-04	2.0E-05	9,000	5,000	0.0%	0.0%

Abbreviations, Notes, and Units on last page.

Table 5
Air Quality Impact Analysis
Bethpage Park Soil Gas Containment System
Operable Unit 3 (Former Grumman Settling Ponds)
Bethpage, New York

Abbreviations, Notes, and Units:

AGC	Annual Guideline Concentration
CAS#	Chemical Abstracts Service Registry Number
DAR-1	Division of Air Resources-1
NS	None Specified
NYSDEC	New York State Department of Environmental Conservation
SGC	Short-term Guideline Concentration
VSP	Vapor Sampling Point

1. Emission rate calculated based on VSP-601 effluent concentration and an exit air flow rate of 1920 ft³/min for 11/26/19.

$$\text{TCE (lb/hr)} = \text{TCE } [\mu\text{g}/\text{m}^3] \times \text{Air Flow Rate } [\text{ft}^3/\text{min}] \times (1 \text{ m}^3/35.3147 \text{ ft}^3) \times (60 \text{ min/hr}) \times (0.000001 \text{ g/1 } \mu\text{g}) \times (0.0022 \text{ lb/g})$$

$$\text{lb/yr} = \text{lb/hr} \times 8,760 \text{ hrs/yr}$$

$$\text{g/s} = \text{lb/hr} \times 1 \text{ hr/3,600 sec} \times 453.59 \text{ g/lb}$$

2. Ambient impact based on AERMOD modeling using normalized rate of 1 g/s is scaled to the actual emission rate of the pollutant. Modeling was performed using the representative meteorological data from the nearest station (Farmingdale) for the years 2011 through 2015. The maximum impact from all the years was used for the calculations.

$$\text{Scaled hourly impact } (\mu\text{g}/\text{m}^3) = \text{AERMOD predicted hourly ambient impact at 1 g/s } ([\mu\text{g}/\text{m}^3]/[\text{g}/\text{s}]) \times \text{Actual emission rate (g/s)}$$

$$\text{Scaled annual impact } (\mu\text{g}/\text{m}^3) = \text{AERMOD predicted annual ambient impact at 1 g/s } ([\mu\text{g}/\text{m}^3]/[\text{g}/\text{s}]) \times \text{Actual emission rate (g/s)}$$

AERMOD Normalized Ambient Impact at 1 g/s	
Hourly ([\mu\text{g}/\text{m}^3]/[\text{g}/\text{s}])	Annual ([\mu\text{g}/\text{m}^3]/[\text{g}/\text{s}])
462.83	20.02

3. Short-term and annual guideline concentrations specified in the NYSDEC DAR-1 AGC/SGC tables revised August 10, 2016.

4. Only contaminants with detected concentrations are included in the table.

ft ³ /min	cubic feet per minute
g/s	grams per second
μg/m ³	micrograms per cubic meter
lb/hr	pounds per hour

FIGURES



CITY:SYRACUSE-NY DIV:GROUP:ENV DB:A.SANCHEZ TM:(Orig) L:Y:(OPTION="OFF-REF" PM:(Red) 3/15/2017 9:38 AM ACAD:VER: 19.15 (LMS TECH) PAGES:SETUP: PLOT:STYLE:TABLE: PLT:FULL:CTB PLOTTED: 3/15/2017 9:38 AM BY: SANCHEZ, ADRIAN
 Z:\NEW\CAD\STRACUSE\ENVTN\10049696\Site\04map.dwg LAYOUT: BP - SAVED: 3/15/2017 9:38 AM XREFS: IMAGES: PROJECTNAME: 2013Amityville.jpg 2013Freeport.jpg 2013Hicksville.jpg 2013Huntington.jpg

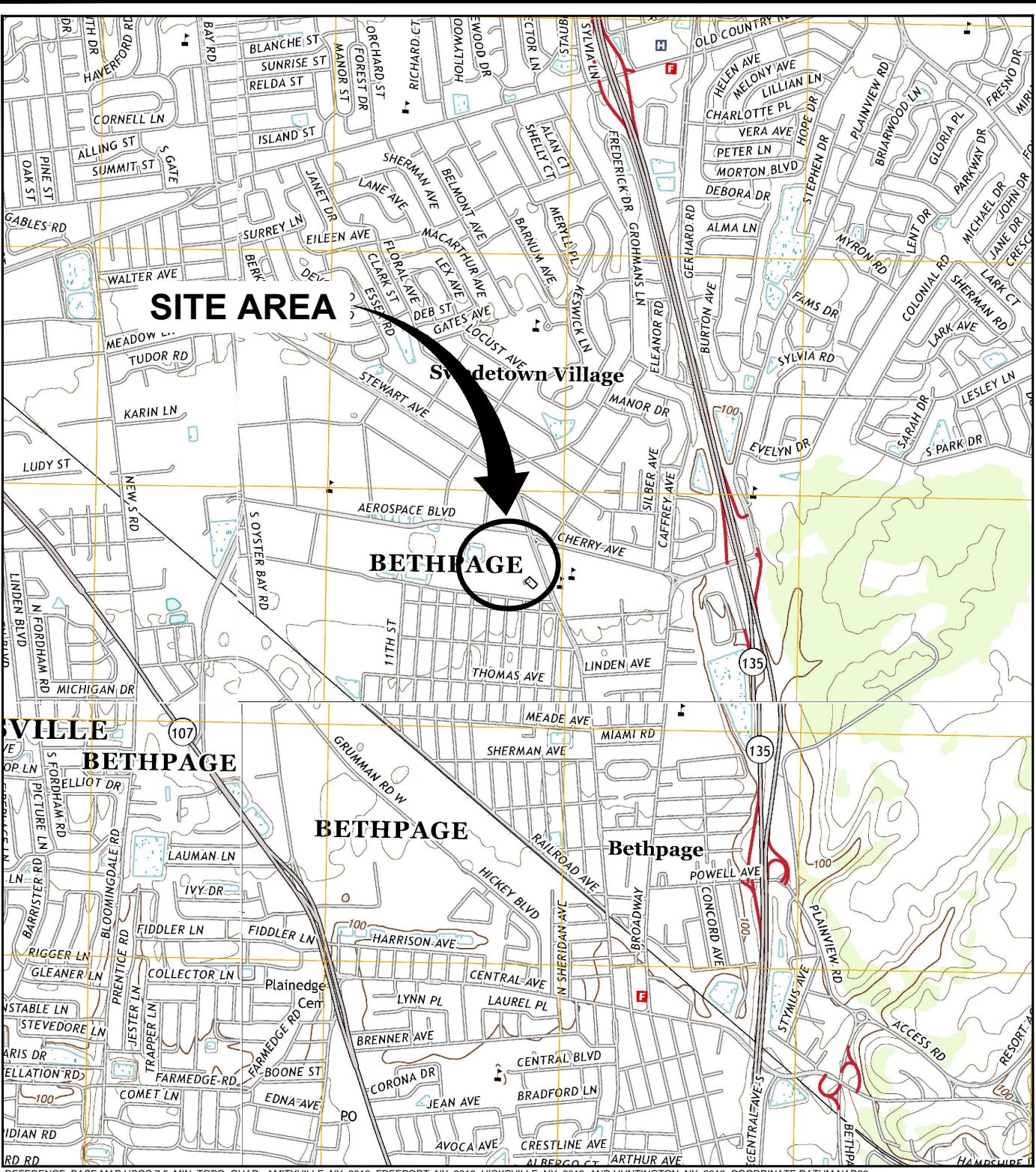

REFERENCE: BASE MAP USGS 7.5 MIN. TOPO. QUAD., AMITYVILLE, NY, 2013, FREEPORT, NY, 2013, HICKSVILLE, NY, 2013, AND HUNTINGTON, NY, 2013, COORDINATE DATUM NAD83.

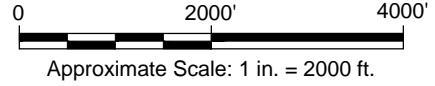

NORTHROP GRUMMAN SYSTEMS CORPORATION
 BETHPAGE PARK SOIL GAS CONTAINMENT SYSTEM
 BETHPAGE, NEW YORK
OPERABLE UNIT 3
 (FORMER GRUMMAN SETTLING PONDS)

SITE LOCATION MAP

ARCADIS Design & Consultancy for natural and built assets

FIGURE 1

CITY: SYRACUSE, NY; DIVISION: ENVIRONMENTAL; DRAWING NO.: 300; PROJECT: NORTHROP GRUMMAN BETHPAGE; DATE: 11/15/2017; 1:15 PM; ACADVER: 2.10; LAYOUT: 3; PLOTTED: 2/28/2018 7:44 PM; BY: SANCHEZ, ADRIAN; PLOTSTYLE: A3.ctb; PROJECT NAME: ...

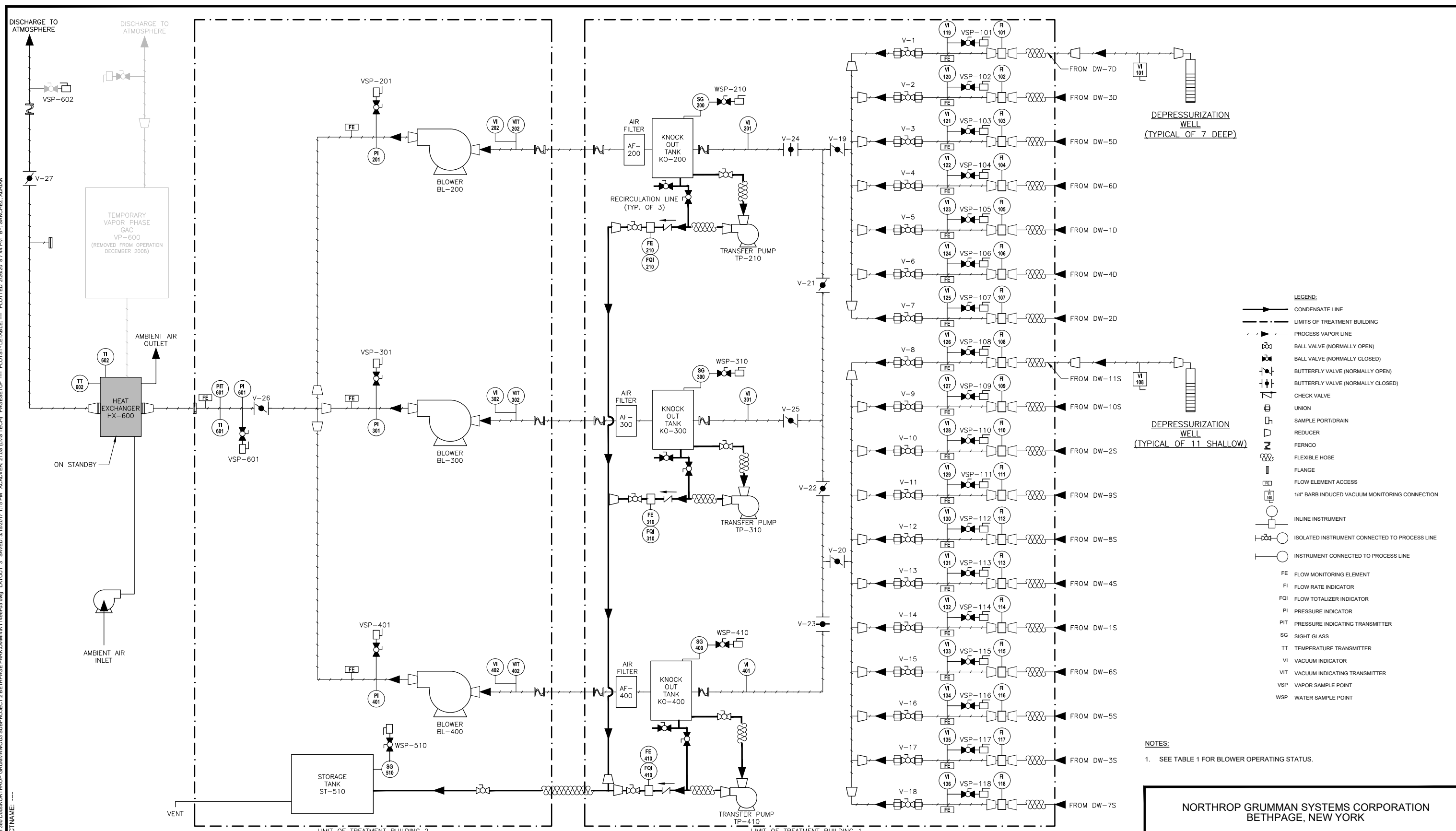

- LEGEND:**
- CONDENSATE LINE
 - LIMITS OF TREATMENT BUILDING
 - PROCESS VAPOR LINE
 - BALL VALVE (NORMALLY OPEN)
 - ◻ BALL VALVE (NORMALLY CLOSED)
 - ◻ BUTTERFLY VALVE (NORMALLY OPEN)
 - ◻ BUTTERFLY VALVE (NORMALLY CLOSED)
 - ◻ CHECK VALVE
 - ◻ UNION
 - ◻ SAMPLE PORT/DRAIN
 - ◻ REDUCER
 - ◻ FERNCO
 - ◻ FLEXIBLE HOSE
 - ◻ FLANGE
 - ◻ FLOW ELEMENT ACCESS
 - ◻ 1/4" BARB INDUCED VACUUM MONITORING CONNECTION
 - INLINE INSTRUMENT
 - ISOLATED INSTRUMENT CONNECTED TO PROCESS LINE
 - INSTRUMENT CONNECTED TO PROCESS LINE
- FE FLOW MONITORING ELEMENT
 FI FLOW RATE INDICATOR
 FQI FLOW TOTALIZER INDICATOR
 PI PRESSURE INDICATOR
 PIT PRESSURE INDICATING TRANSMITTER
 SG SIGHT GLASS
 TT TEMPERATURE TRANSMITTER
 VI VACUUM INDICATOR
 VIT VACUUM INDICATING TRANSMITTER
 VSP VAPOR SAMPLE POINT
 WSP WATER SAMPLE POINT

NOTES:
 1. SEE TABLE 1 FOR BLOWER OPERATING STATUS.

NORTHROP GRUMMAN SYSTEMS CORPORATION
 BETHPAGE, NEW YORK

PROCESS FLOW DIAGRAM

Design & Consultancy
 for natural and built assets

FIGURE
 3

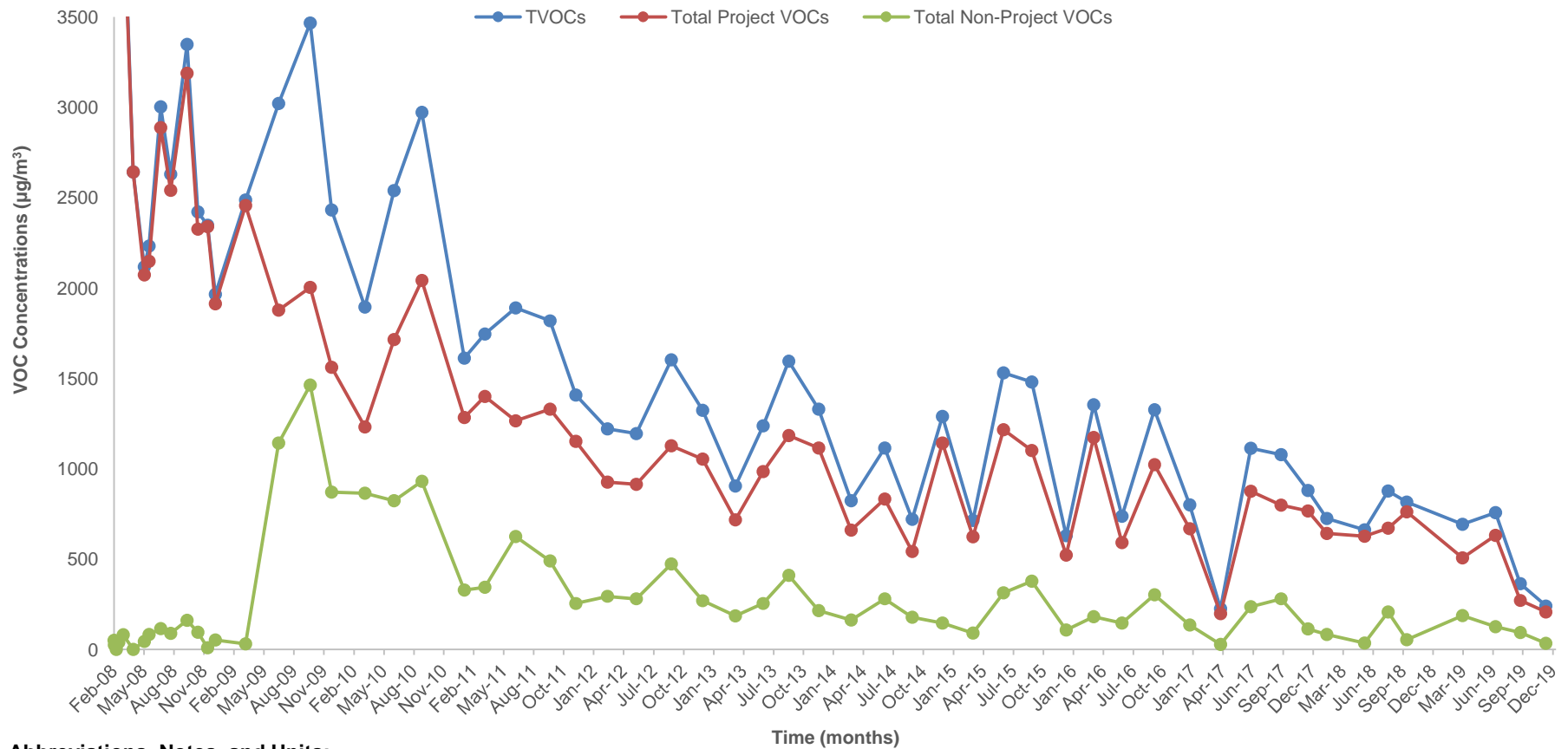

Abbreviations, Notes, and Units:

VOCs = Volatile Organic Compounds
 TVOCs = Total VOCs detected

Total Project VOCs = Sum of 1,1,1-trichloroethane; 1,1-dichloroethane; 1,2-dichloroethane; 1,1-dichloroethene; tetrachloroethene; trichloroethene; vinyl chloride; cis-1,2-dichloroethene; trans-1,2-dichloroethene; benzene; toluene; and total xylenes.

Total Non-Project VOCs = Sum of VOCs that are not Project VOCs.

1. Samples were collected at Vapor Sample Port-601 (VSP-601); refer to Figure 3 of this OM&M report for the location of VSP-601.
2. Results prior to April 16, 2008 are not shown to improve figure clarity. The TVOC and Total Project VOC concentrations are greater than 3,500 µg/m³. See previous reports for full data set.
3. The sample results from December 3, 2010 are not consistent with historical data and the results are excluded from this figure. The TVOC concentration for December 3, 2010 was 13 µg/m³.

µg/m³ = micrograms per cubic meter

NORTHROP GRUMMAN SYSTEMS CORPORATION BETHPAGE PARK SOIL GAS CONTAINMENT SYSTEM BETHPAGE, NEW YORK, OPERABLE UNIT 3 (FORMER GRUMMAN SETTLING PONDS)	
SOIL GAS VOC CONCENTRATIONS	
 ARCADIS <small>Design & Consultancy for natural and built assets</small>	FIGURE 4

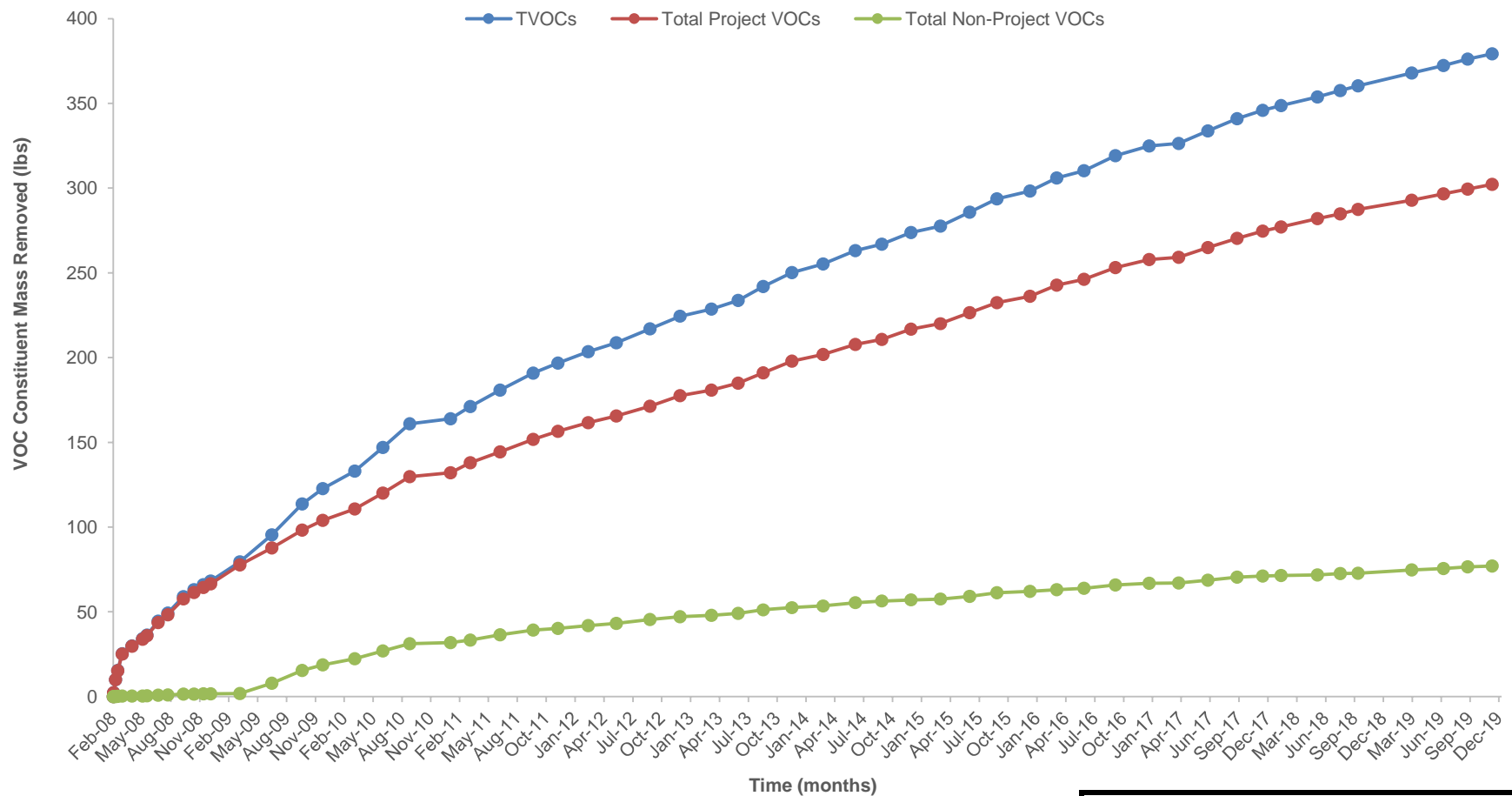

Abbreviations, Notes, and Units:

VOCs = Volatile Organic Compounds

TVOCs = Total VOCs detected

Total Project VOCs = Sum of 1,1,1-trichloroethane; 1,1-dichloroethane; 1,2-dichloroethane; 1,1-dichloroethene; tetrachloroethene; trichloroethene; vinyl chloride; cis-1,2-dichloroethene; trans-1,2-dichloroethene; benzene; toluene; and total xylenes.

Total Non-Project VOCs = Sum of VOCs that are not Project VOCs.

1. The sample results from December 3, 2010 are not consistent with historical data and the results are excluded from this figure.

lbs = pounds

NORTHROP GRUMMAN SYSTEMS CORPORATION
 BETHPAGE PARK SOIL GAS CONTAINMENT SYSTEM
 BETHPAGE, NEW YORK, OPERABLE UNIT 3
 (FORMER GRUMMAN SETTLING PONDS)

**CUMULATIVE TOTAL, PROJECT, AND
 NON-PROJECT VOC MASS REMOVED**



FIGURE

5

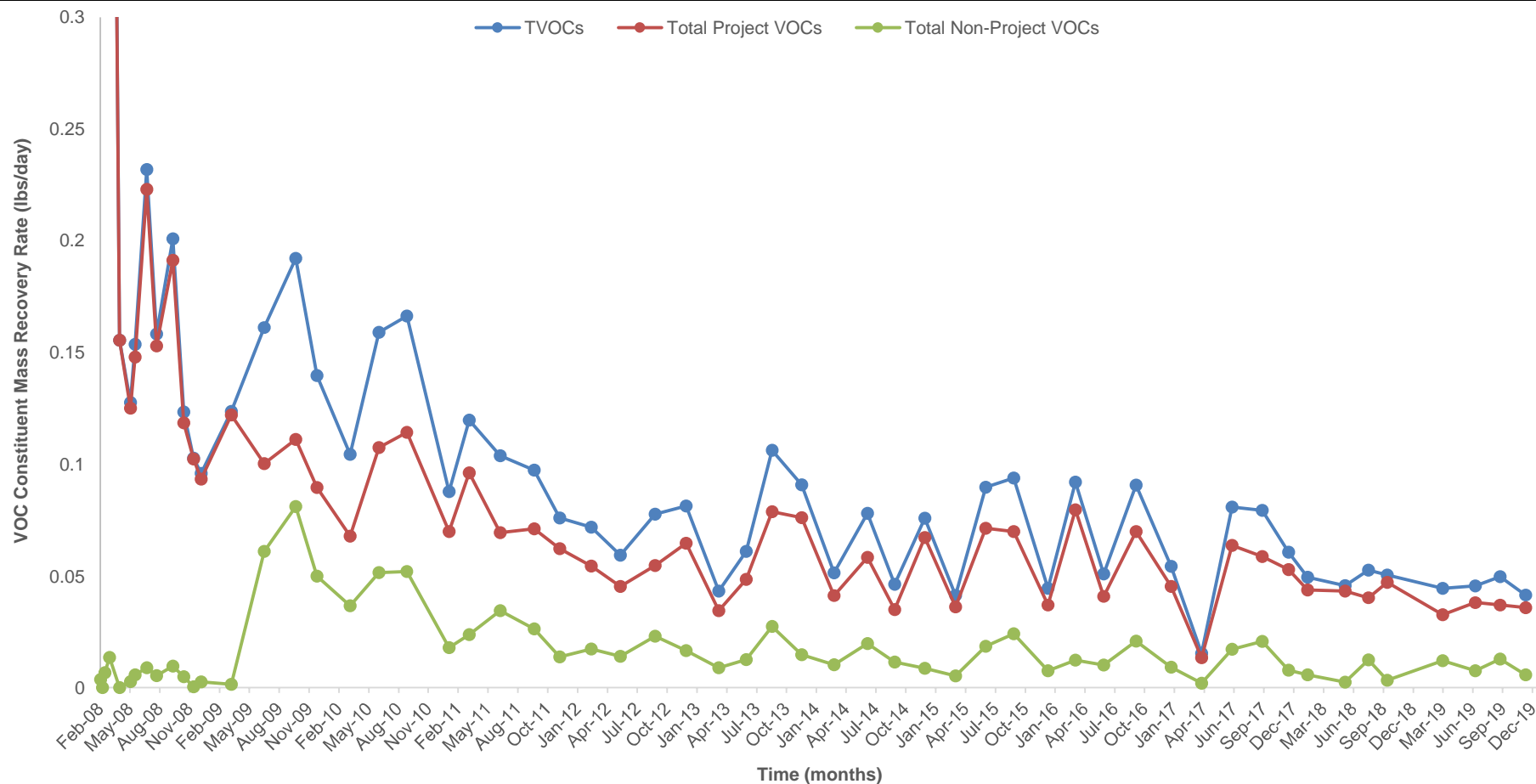

Abbreviations, Notes, and Units:

VOCs = Volatile Organic Compounds

TVOCs = Total VOCs detected

Total Project VOCs = Sum of 1,1,1-trichloroethane; 1,1-dichloroethane; 1,2-dichloroethane; 1,1-dichloroethene; tetrachloroethene; trichloroethene; vinyl chloride; cis-1,2-dichloroethene; trans-1,2-dichloroethene; benzene; toluene; and total xylenes.

Total Non-Project VOCs = Sum of VOCs that are not Project VOCs.

1. Results prior to April 16, 2008 are not shown to improve figure clarity. The TVOC and Total Project VOC concentrations are greater than 0.3 lbs/day. See previous reports for full data set.

2. The sample results from December 3, 2010 are not consistent with historical data and the results are excluded from this figure. The TVOC concentration for December 3, 2010 was 13 µg/L.

lbs/day = pounds per day

NORTHROP GRUMMAN SYSTEMS CORPORATION
 BETHPAGE PARK SOIL GAS CONTAINMENT SYSTEM
 BETHPAGE, NEW YORK, OPERABLE UNIT 3
 (FORMER GRUMMAN SETTLING PONDS)

VOC MASS RECOVERY RATES



FIGURE

6

Arcadis of New York, Inc.

Two Huntington Quadrangle

Suite 1S10

Melville, New York 11747

Tel 631 249 7600

Fax 631 249 7610

www.arcadis.com