

Mr. Jason Pelton
Project Manager
New York State Department of Environmental Conservation
Remedial Bureau D
625 Broadway
Albany, NY 12233-7015

Arcadis of New York, Inc.
Two Huntington
Quadrangle
Suite 1S10
Melville
New York 11747
Phone: 631 249 7600
Fax: 631 249 7610

www.arcadis.com

Date: November 24, 2021

Our Ref: 30059268

Subject: Results of Third Quarter 2021 System Operation and Monitoring,
Bethpage Park Soil Gas Containment System (BPSGCS),
Operable Unit 3 (OU3; Former Grumman Settling Ponds),
Bethpage, New York, NYSDEC Site #1-30-003A.

Dear Jason,

Enclosed is one electronic PDF copy of the 2021 Third Quarter results of the OU3 BPSGCS operation and monitoring, performed in accordance with the NYSDEC-approved OU3 Soil Gas IRM (although approved as an IRM, based on the 2013 NYSDEC ROD, it is the approved soil gas remedy for the Site) OM&M Manual (Arcadis 2016) and the NYSDEC-approved Sampling and Analysis Plan (SAP; Arcadis 2016). As we have transitioned to electronic submittals (via PDF) in line with NYSDEC's paper reduction program, hard copies of the report can be provided on request.

A notable increase in concentrations of cis-1,2-Dichloroethene, Trichloroethylene, and Vinyl Chloride was detected in the first quarter sampling event, conducted on March 23, 2021, compared to previous quarters (Table 3 and Figures 4 through 6). This increase was likely due to the ongoing ISTR system activities on the Bethpage Community Park property. However, the air quality impact analysis (Table 5) shows that none of the detected compounds exceed the SGCs or AGCs specified in NYSDEC DAR-1. Additionally, laboratory analytical results for the Second Quarter sampling event conducted on May 17, 2021 and the Third Quarter sampling event conducted on July 27, 2021 indicate a significant decrease in concentrations of cis-1,2-Dichloroethene, Trichloroethylene, and Vinyl Chloride in the soil gas discharge compared to the First Quarter. These 3 compounds decreased from March to May to July as follows: Cis-1,2-Dichloroethene decreased from 354 ug/m³ to 199 ug/m³ to 135 ug/m³, Trichloroethylene decreased from 1,550 ug/m³ to 736 ug/m³ to 457ug/m³i, and Vinyl Chloride decreased from 28.1 ug/m³ to 5.9 ug/m³ to 1.5 ug/m³. Based on the trends shown on Figures 4 through 6 it appears that peak soil gas concentrations, due to the ongoing ISTR system activities, have passed. We will continue monitoring this situation during subsequent quarterly monitoring rounds.

If you have any questions, please do not hesitate to contact me.

Sincerely,
Arcadis of New York, Inc.



Christopher Engler, PE New York PE-069748
Vice President

Mr. Jason Pelton
NYSDEC
November 24, 2021

Email: Christopher.Engler@arcadis.com
Direct Line: 315.409.6579

CC. Ed Hannon, Northrop Grumman
Donald Hesler, NYSDEC
Jim Sullivan, NYS Dept. of Health
Donald Irwin, Nassau County Dept. of Health
Robin Putnam, Nassau County Dept. of Health
Richard Castle, Nassau County Dept. of Health
Carlo San Giovanni, Arcadis
Nidal Azzam, USEPA
Alexis Stabulas, USEPA
Public Repository
File

Table 1
General System Operating Parameters
Bethpage Park Soil Gas Containment System
Operable Unit 3 (Former Grumman Settling Ponds)
Northrop Grumman,
Bethpage, New York



Date	DW-7S Parameters			DW-7D Parameters			DW-3S Parameters			DW-3D Parameters			DW-5S Parameters			DW-5D Parameters			DW-6S Parameters			DW-6D Parameters		
	Flow Rate at Manifold	Vacuum at Manifold	Wellhead Vacuum	Flow Rate at Manifold	Vacuum at Manifold	Wellhead Vacuum	Flow Rate at Manifold	Vacuum at Manifold	Wellhead Vacuum	Flow Rate at Manifold	Vacuum at Manifold	Wellhead Vacuum	Flow Rate at Manifold	Vacuum at Manifold	Wellhead Vacuum	Flow Rate at Manifold	Vacuum at Manifold	Wellhead Vacuum	Flow Rate at Manifold	Vacuum at Manifold	Wellhead Vacuum	Flow Rate at Manifold	Vacuum at Manifold	Wellhead Vacuum
	scfm	iwc	iwc	scfm	iwc	iwc	scfm	iwc	iwc	scfm	iwc	iwc	scfm	iwc	iwc	scfm	iwc	iwc	scfm	iwc	iwc	scfm	iwc	iwc
10/27/20	75	-16	-1.36	5.5	-8.0	-0.40	6.0	-7.5	-0.20	8.0	-9.0	-0.34	74	-12.0	-0.77	13	-7.0	-1.50	69	-13	-1.42	6.2	-5	-1.30
3/23/21	85	-20	-1.56	5.0	-15.0	-0.43	6.0	-5.0	-0.28	15.0	-7.0	-0.49	75	-17.0	-1.51	15	-10.0	-2.93	75	-15	-1.60	8.2	-6	-1.88
5/18/21	80	-17.5	-1.36	5.0	-20.0	-0.36	6.0	-6.0	-0.19	10.0	-10.0	-0.31	75	-13.0	-1.11	15	-9.0	-0.25	75	-14	-1.41	6.8	-5.4	-1.45
7/27/21	97	-18	-1.78	6.0	-15.0	-0.49	5.0	-5.5	-0.24	7.5	-9.0	-0.37	82	-13.0	-1.22	4.5	-9.5	-1.18	85	-15	-1.70	5.4	-5.4	-1.10

Notes, Abbreviations, and Units on last page.

Table 1
General System Operating Parameters
Bethpage Park Soil Gas Containment System
Operable Unit 3 (Former Grumman Settling Ponds)
Northrop Grumman,
Bethpage, New York



Date	DW-1S Parameters			DW-1D Parameters			DW-4S Parameters			DW-4D Parameters			DW-8S Parameters			DW-9S Parameters			DW-2S Parameters			DW-2D Parameters		
	Flow Rate at Manifold	Vacuum at Manifold	Wellhead Vacuum	Flow Rate at Manifold	Vacuum at Manifold	Wellhead Vacuum	Flow Rate at Manifold	Vacuum at Manifold	Wellhead Vacuum	Flow Rate at Manifold	Vacuum at Manifold	Wellhead Vacuum	Flow Rate at Manifold	Vacuum at Manifold	Wellhead Vacuum	Flow Rate at Manifold	Vacuum at Manifold	Wellhead Vacuum	Flow Rate at Manifold	Vacuum at Manifold	Wellhead Vacuum	Flow Rate at Manifold	Vacuum at Manifold	Wellhead Vacuum
	scfm	iwc	iwc	scfm	iwc	iwc	scfm	iwc	iwc	scfm	iwc	iwc	scfm	iwc	iwc	scfm	iwc	iwc	scfm	iwc	iwc	scfm	iwc	iwc
10/27/20	66	-18.5	-1.53	5.1	-2.5	-1.53	69 ⁽⁴⁾	-15.0	-1.46	7.0	-5.6	-0.70	59	-18.0	-1.80	30	-12	-1.33	29	-21	-1.8	37	-21	-2.36
3/23/21	85	-23.5	-2.32	6.1	-3	-1.94	0	-15.0	-0.30	8.0	-6	-0.39	48	-17.0	-1.40	34	-12	-1.41	28	-14	-2.88	43	-28	-1.15
5/18/21	70	-21	-1.63	5	-6	-1.48	74	-16.0	-1.43	5.0	-22	-0.54	76	-20.0	-2.32	30	-12	-1.27	28	-23	-1.55	37	-23	-2.38
7/27/21	65	-19	-1.61	5	-2.5	-1.62	69	-15.0	-1.43	6.0	-6.5	-0.59	63	-18.0	-2.03	30	-12	-1.32	26	-19	-1.57	30	-20	-2.15

Notes, Abbreviations, and Units on last page.

Table 1
General System Operating Parameters
Bethpage Park Soil Gas Containment System
Operable Unit 3 (Former Grumman Settling Ponds)
Northrop Grumman,
Bethpage, New York



Date	DW-10S Parameters			DW-11S Parameters			Knock Out Tank Parameters - Vacuum			Condensate Water Collected ⁽¹⁾	Blower Parameters BL-200			Blower Parameters BL-300			Blower Parameters BL-400			Combined Effluent Parameters				
	Flow Rate at Manifold	Vacuum at Manifold	Wellhead Vacuum	Flow Rate at Manifold	Vacuum at Manifold	Wellhead Vacuum	Influent KO-200	Influent KO-300	Influent KO-400	Influent ST-510	Influent Vacuum	Affluent Pressure	Blower Speed	Influent Vacuum	Affluent Pressure	Blower Speed	Influent Vacuum	Affluent Pressure	Blower Speed	Total Effluent Flow Rate ⁽²⁾	Total Effluent PID	Heat Exchanger Influent Temp.	Total Effluent Pressure	Heat Exchanger Effluent Temp.
	scfm	iwc	iwc	scfm	iwc	iwc	iwc	iwc	iwc	Gallons	iwc	iwc	Hz	iwc	iwc	Hz	iwc	iwc	Hz	scfm	ppmv	°F	iwc	°F
10/27/20	35	-14	-2.06	29	-26	-2.20	NA	-30	NA	100	NA	NA	NA	35	15	60	7	12	60	1479	0.1	113	14.0	102
3/23/21	27	-12	-1.50	35	-27	-2.86	NA	-39	NA	180	NA	NA	NA	43	14	60	17	11	60	1727	1.0	120	12.0	118
5/18/21	35	-13.5	-1.78	15	-27	-0.61	NA	-22	NA	0	NA	NA	NA	36	14	60	22	11	60	1203	0.2	127	11.0	125
7/27/21	30	-13	-1.83	27	-22	-2.15	NA	-24	NA	0	NA	NA	NA	33	11	60	42	9	60	1141	0.1	140	10.0	120

Notes, Abbreviations, and Units on last page.

Table 1
General System Operating Parameters
Bethpage Park Soil Gas Containment System
Operable Unit 3 (Former Grumman Settling Ponds)
Northrop Grumman,
Bethpage, New York



Notes, Abbreviations, and Units:

1. Total gallons of water accumulated at storage tank ST-510 per quarter are based on storage tank level and condensate removed as documented in site operator condensate discharge logs.
2. Total effluent air velocity in feet per minute was measured using a hand-held anemometer at the stack effluent location. The total effluent flow rate in scfm was calculated by multiplying the measured air velocity by the pipe area, the ratio of the standard air temperature to the measured air temperature, and the ratio of the measured air pressure to the standard air pressure.

DW	Depressurization Well
NA	Not Applicable
NM	Not Measured
°F	degrees Fahrenheit
Hz	Hertz
iwc	inches of water column
scfm	standard cubic feet per minute

Table 2
Summary of Induced Vacuum Readings at Compliance Monitoring Points
Bethpage Park Soil Gas Containment System
Operable Unit 3 (Former Grumman Settling Ponds)
Northrop Grumman,
Bethpage, New York



Well ID:	DW-7S		DW-7D	DW-3S	DW-3D	DW-5S		DW-5D		DW-1S			DW-1D	DW-4D	DW-8S		DW-2S		DW-2D		DW-11S	
MP ID:	VMWC-14A	VMWC-14B	VMWC-14D	VMWC-11B	VMWC-12D	VMWC-15A	VMWC-15B	VMWC-15D	VMWC-15E	VMWC-3A	VMWC-3B	VMWC-3C	VMWC-3D	VMWC-16D	VMWC-16A	VMWC-16B	VMWC-7A	VMWC-7B	VMWC-13D	VMWC-17D	VMWC-18A	VMWC-18B
Date	iwc	iwc	iwc	iwc	iwc	iwc	iwc	iwc	iwc	iwc	iwc	iwc	iwc	iwc	iwc	iwc	iwc	iwc	iwc	iwc	iwc	iwc
10/27/20	-0.10	-0.16	-0.16	-0.15	-0.12	-0.14	-0.13	NA ⁽³⁾	-0.12	-0.14	-0.13	-0.16	-0.22	-0.16	-0.16	-0.14	-0.11	-0.14	-0.10	-0.16	-0.10	-0.11
03/23/21	-0.10	-0.19	-0.20	-0.14	-0.13	-0.15	-0.15	NA ⁽³⁾	-0.11	-0.15	-0.15	-0.16	-0.24	-0.10	-0.10	-0.10	-0.10	-0.10	-0.21	-0.11	-0.11	-0.14
05/18/21	-0.10	-0.14	-0.15	-0.10	-0.12	-0.11	-0.10	NA ⁽³⁾	-0.13	-0.12	-0.14	-0.13	-0.22	-0.13	-0.17	-0.10	-0.11	-0.10	-0.14	-0.14	-0.19	-0.21
07/27/21	-0.11	-0.20	-0.21	-0.12	-0.11	-0.12	-0.11	NA ⁽³⁾	-0.12	-0.12	-0.13	-0.13	-0.19	-0.17	-0.17	-0.02	-0.11	-0.11	-0.20	-0.17	-0.10	-0.12
Time Weighted Rolling Average⁽¹⁾	-0.10	-0.18	-0.18	-0.13	-0.12	-0.13	-0.13	-	-0.12	-0.14	-0.14	-0.15	-0.22	-0.13	-0.14	-0.10	-0.10	-0.11	-0.17	-0.14	-0.12	-0.14

Gross Average Compliance Points ^(1,2)	
07/27/21	-0.13

Notes, Abbreviations, and Units:

1. Compliance goal is -0.1 iwc of vacuum at all compliance monitoring points, based on a twelve-month rolling average. Time weighted rolling average calculated by summing the products of the instantaneous induced vacuum readings and the number of days between readings for a 12-month monitoring period, and dividing by the total time period between the first and last quarterly induced vacuum readings.
2. Gross average compliance points calculated by summing the induced vacuum values for the noted monitoring event and dividing by the number of readings.
3. Reading not measured due to well abandonment, replacement well VMWC-15E installed on 7/21/20.

DW	Depressurization Well
iwc	inches of water column
VMWC	Vapor Monitoring Well Cluster
NM	Not Measured
NA	Not Applicable

Table 3
Total Effluent Vapor Sample Analytical Results
Bethpage Park Soil Gas Containment System
Operable Unit 3 (Former Grumman Settling Ponds)
Northrop Grumman,
Bethpage, New York



Compound (units in µg/m ³)	Sample ID ¹ : Sample Date:	VSP-601 10/27/2020	VSP-601 3/23/2021	VSP-601 5/18/2021	VSP-601 7/27/2021
Project VOCs					
	CAS No.				
1,1,1-Trichloroethane	71-55-6	2.5	2.4	1.7 J	< 2.2
1,1-Dichloroethane	75-34-3	2.3	4.5	3.4	3.1 J
1,1-Dichloroethene	75-35-4	2.3	9.9	4.0	< 0.63
1,2-Dichloroethane	107-06-2	< 0.81	< 0.82	< 0.34	< 3.2
Benzene	71-43-2	1.0	2.1	2.1 J	< 2.6
cis-1,2-Dichloroethene	156-59-2	87.2	354	199	135
Tetrachloroethene	127-18-4	3.5	6.6	4.3	6.0
Toluene	108-88-3	0.83	2.1	< 0.22	< 3.0
trans-1,2-Dichloroethene	156-60-5	1.9	15.0	7.1	3.6
Trichloroethylene	79-01-6	222	1550	736	457
Vinyl chloride	75-01-4	42.7	28.1	5.9	1.5
Xylenes - O	95-47-6	0.40 J	0.48 J	<0.30	< 3.5
Xylenes - M,P	1330-20-7	1.0	0.56 J	<0.61	< 3.5
Subtotal Project VOCs		368	1976	964	606
Non-Project VOCs					
1,1,2,2-Tetrachloroethane	79-34-5	< 0.55	< 0.69	< 0.76	< 2.7
1,1, 2-Trichloroethane	79-00-5	< 0.44	< 0.55	< 0.65	< 2.2
1,2-Dichloropropane	78-87-5	< 0.74	< 0.92	< 0.36	< 3.7
1,3-Butadiene	106-99-0	1.5	< 0.44	< 0.40	< 1.8
1-Chloro-1,1-difluoroethane (Freon 142B)	75-68-3	30	16	50.1	58.4
2-Butanone	78-93-3	1.3	0.44 J	<0.50	< 2.4
2-Hexanone	591-78-6	< 0.65	< 0.82	< 0.61	< 3.3
4-Methyl-2-Pentanone	108-10-1	< 0.66	< 0.82	< 0.57	< 3.3
Acetone	67-64-1	10	3.1	10	7.6
Bromodichloromethane	75-27-4	< 0.54	< 0.67	< 0.74	< 2.7
Bromoform	75-25-2	< 0.33	< 0.41	< 1.6	< 1.7
Bromomethane	74-83-9	< 0.62	< 0.78	< 0.34	< 3.1
Carbon Disulfide	75-15-0	< 0.50	< 0.62	< 0.29	< 2.5
Carbon Tetrachloride	56-23-5	0.48	0.34	<0.59	< 1.0
Chlorobenzene	108-90-7	< 0.74	< 0.92	< 0.46	< 3.7
Chlorodibromomethane	124-48-1	< 0.68	< 0.85	< 1.1	< 3.4
Chloroethane	75-00-3	< 0.42	< 0.53	< 0.50	< 2.1
Chlorodifluoromethane (Freon 22)	75-45-6	0.91	0.56 J	< 1.5	< 2.8
Chloroform	67-66-3	6.3	15	14	15
Chloromethane	74-87-3	< 0.33	0.37 J	< 0.13	< 1.7
cis-1,3-Dichloropropene	10061-01-5	< 0.73	< 0.91	< 0.35	< 3.6
Dichlorodifluoromethane (Freon 12)	75-71-8	1.9	1.3	1.9 J	2.7 J
Ethylbenzene	100-41-4	< 0.69	< 0.87	< 0.26	< 3.5
Methylene Chloride	75-09-2	< 0.56	< 0.69	4.5	4.5
Methyl Tert-Butyl Ether	1634-04-4	< 0.58	< 0.72	< 0.28	< 2.9
Styrene	100-42-5	< 0.68	0.47	<0.32	< 3.4
trans-1,3-Dichloropropene	10061-02-6	< 0.73	< 0.91	< 0.35	< 3.6
Trichlorofluoromethane (Freon 11)	75-69-4	1.2	0.79	<0.62	< 2.2
Trichlorotrifluoroethane (Freon 113)	76-13-1	< 0.61	< 0.77	< 0.52	< 3.1
Subtotal Non-Project VOCs		54	38	81	88
TVOC⁽²⁾		421	2,014	1,044	694

Notes, Abbreviations, Qualifiers, and Units on last page.

Table 3
Total Effluent Vapor Sample Analytical Results
Bethpage Park Soil Gas Containment System
Operable Unit 3 (Former Grumman Settling Ponds)
Northrop Grumman,
Bethpage, New York



Notes, Abbreviations, Qualifiers, and Units:

1. Vapor samples collected by Arcadis and submitted to a NYSDOH ELAP certified laboratory for VOC analyses per Modified USEPA Method TO-15.
2. TVOC determined by summing individual detections and rounding to the nearest whole number.

CAS No. Chemical Abstracts Service list number
ELAP Environmental Laboratory Approval Program
NYSDOH New York State Department of Health
NYSDEC New York State Department of Environmental Conservation.
TVOC Total Volatile Organic Compounds
USEPA United States Environmental Protection Agency
VOC Volatile Organic Compound

15.0 Bolding indicates that the analyte was detected at or above laboratory reporting limit
<2.2 Compound not detected above its laboratory quantification limit
J Compound detected below laboratory reporting limit; result is estimated
 $\mu\text{g}/\text{m}^3$ micrograms per cubic meter

Table 4
Total Effluent Vapor Sample Analytical Results
Tentatively Identified Compounds
Bethpage Park Soil Gas Containment System
Operable Unit 3 (Former Grumman Settling Ponds)
Northrop Grumman,
Bethpage, New York

Sample ID: Sample Date ⁽¹⁾ : Units:	VSP - 601 10/27/2020 ppbv	VSP - 601 3/23/2021 ppbv	VSP - 601 5/18/2021 ppbv	VSP - 601 7/27/2021 ppbv
Tentatively Identified Compounds⁽²⁾				
Carbon Dioxide	360 JNB	670 JNB	1100 JNB	960 JNB
Alkane	ND	5.1 J	ND	ND
Ethanol	5.7 JN	ND	ND	ND
2-Ethylhexanol	3.5 JN	ND	ND	ND
2-Phenyl-2-Propanol	5.3 JN	ND	ND	ND
Acetophenone	6.1 JN	ND	6.8 JN	ND
2-Ethylhexyl acetate	ND	ND	ND	ND
Methylcyclohexane	ND	7.5 JN	ND	ND
Benzenemethanol, .alpha.,.alpha.-dimethy	ND	ND	15 JN	ND

Notes, Abbreviations, Qualifiers, and Units:

1. Vapor samples collected by Arcadis on the dates shown and submitted to a NYSDOH ELAP certified laboratory for VOC analyses
2. Tentatively identified compounds are identified based on review of mass spectrometry results via a comprehensive library search of

ND	Not Detected
ELAP	Environmental Laboratory Approval Program
NYSDOH	New York State Department of Health
USEPA	U.S. Environmental Protection Agency
VOC	Volatile Organic Compound
B	Indicates analyte found in associated method blank
J	Indicates an estimated value
JN	Compound tentatively identified, concentration i
ppbv	parts per billion by volume

Table 5
Air Quality Impact Analysis
Bethpage Park Soil Gas Containment System
Operable Unit 3 (Former Grumman Settling Ponds)
Northrop Grumman,
Bethpage, New York



Toxic Air Contaminant ⁽⁴⁾	CAS#	VSP-601 Vapor Effluent (µg/m ³) 7/27/2021	Emission Rate ⁽¹⁾			Scaled Impact - Hourly ⁽²⁾ (µg/m ³)	Scaled Impact - Annual ⁽²⁾ (µg/m ³)	SGC ⁽³⁾ (µg/m ³)	AGC ⁽³⁾ (µg/m ³)	% of SGC	% of AGC
			lb/yr	lb/hr	g/s						
Project VOCs											
1,1 - Dichloroethane	75-34-3	3.1 J	1.2E-01	1.3E-05	1.7E-06	2.0E-03	3.3E-05	NS	0.63	NS	0.0%
cis- 1,2-Dichloroethene	156-59-2	135.0	5.0E+00	5.8E-04	7.3E-05	8.8E-02	1.5E-03	NS	63	NS	0.0%
Tetrachloroethene	127-18-4	6.0	2.2E-01	2.6E-05	3.2E-06	3.9E-03	6.5E-05	300	4	0.0%	0.0%
trans- 1,2-Dichloroethene	156-60-5	3.6	1.3E-01	1.5E-05	1.9E-06	2.3E-03	3.9E-05	NS	63	NS	0.0%
Trichloroethene	79-01-6	457.0	1.7E+01	1.9E-03	2.5E-04	3.0E-01	4.9E-03	20	0.2	1.5%	2.5%
Vinyl Chloride	75-01-4	1.5	5.6E-02	6.4E-06	8.1E-07	9.8E-04	1.6E-05	180,000	0.11	0.0%	0.0%
Non-Project VOCs											
1-Chloro-1,1-difluoroethane (Freon 142B)	75-68-3	58.4	2.2E+00	2.5E-04	3.1E-05	3.8E-02	6.3E-04	NS	50,000	NS	0.0%
Acetone	67-64-1	7.6	2.8E-01	3.2E-05	4.1E-06	5.0E-03	8.2E-05	180,000	30,000	0.0%	0.0%
Chloroform	67-66-3	15	5.6E-01	6.4E-05	8.1E-06	9.8E-03	1.6E-04	150	15	0.0%	0.0%
Dichlorodifluoromethane (Freon 12)	75-71-8	2.7 J	1.0E-01	1.2E-05	1.5E-06	1.8E-03	2.9E-05	NS	12,000	NS	0.0%
Methylene Chloride	75-09-2	4.5	1.7E-01	1.9E-05	2.4E-06	2.9E-03	4.8E-05	14,000	60	0.0%	0.0%

Notes, Abbreviations, and Units on last page.

Table 5
Air Quality Impact Analysis
Bethpage Park Soil Gas Containment System
Operable Unit 3 (Former Grumman Settling Ponds)
Northrop Grumman,
Bethpage, New York



Notes, Abbreviations, and Units:

1. Emission rate calculated based on VSP-601 effluent concentration and an exit air flow rate of 1,141 ft³/min for 7/27/21. Emission rate standardized at 70 °F and 1 atm.

$$\text{TCE (lb/hr)} = \text{TCE } [\mu\text{g}/\text{m}^3] \times \text{Air Flow Rate } [\text{ft}^3/\text{min}] \times (1 \text{ m}^3/35.3147 \text{ ft}^3) \times (60 \text{ min/hr}) \times (0.000001 \text{ g/1 } \mu\text{g}) \times (0.0022 \text{ lb/g})$$

$$\text{lb/yr} = \text{lb/hr} \times 8,760 \text{ hrs/yr}$$

$$\text{g/s} = \text{lb/hr} \times 1 \text{ hr/3,600 sec} \times 453.59 \text{ g/lb}$$

2. Ambient impact based on AERMOD modeling using normalized rate of 1 g/s is scaled to the actual emission rate of the pollutant. Modeling was performed using the representative meteorological data from the nearest station (Farmingdale) for the years 2015 through 2019. The maximum impact from all the years was used for the calculations.

$$\text{Scaled hourly impact } (\mu\text{g}/\text{m}^3) = \text{AERMOD predicted hourly ambient impact at 1 g/s } ([\mu\text{g}/\text{m}^3]/[\text{g/s}]) \times \text{Actual emission rate (g/s)}$$

$$\text{Scaled annual impact } (\mu\text{g}/\text{m}^3) = \text{AERMOD predicted annual ambient impact at 1 g/s } ([\mu\text{g}/\text{m}^3]/[\text{g/s}]) \times \text{Actual emission rate (g/s)}$$

AERMOD Normalized Ambient Impact at 1 g/s	
Hourly ([\mu\text{g}/\text{m}^3]/[\text{g/s}])	Annual ([\mu\text{g}/\text{m}^3]/[\text{g/s}])
1,213.26	36.86

3. Short-term and annual guideline concentrations specified in the NYSDEC DAR-1 AGC/SGC tables revised August 10, 2016.

4. Only contaminants with detected concentrations are included in the table.

AGC	Annual Guideline Concentration
CAS#	Chemical Abstracts Service Registry Number
DAR-1	Division of Air Resources-1
NS	None Specified
NYSDEC	New York State Department of Environmental Conservation
SGC	Short-term Guideline Concentration
VSP	Vapor Sampling Point
J	Indicates an estimated value
ft ³ /min	cubic feet per minute
g/s	grams per second
μg/m ³	micrograms per cubic meter
lb/hr	pounds per hour

C:\Users\jamieell\OneDrive - ARCADIS\BIM 360 Docs\NORTHROP GRUMMAN\SUBPROJECT 2 BETHPAGE PARK\2021\2021\NGC-OUSSUB2-F02-MW\2021_03 REPORT.dwg LAYOUT: 2 - SAVED: 8/12/2021 11:42 AM ACADVER: 23.15 (LMS TECH) PAGES: 21 PLOTSTYLETABLE: ...
 XREFS: IMAGES: PROJECTNAME: ...
 X-ON-SITE-BASE SITE
 X-BDR-DL

PROPERTY OWNED BY TOWN OF OYSTER BAY

LEGEND:

- PROPERTY LINE NORTHROP GRUMMAN
- x- 6' CHAIN LINK FENCE
- v- VAPOR RECOVERY LINES
- VMWC-9A ◊ NON-COMPLIANCE-RELATED VACUUM MONITORING WELL CLUSTER
- VMWC-14A ◊ COMPLIANCE-RELATED VACUUM MONITORING WELL CLUSTER
- DW-3S ⊙ SHALLOW DEPRESSURIZATION WELL
- DW-3D ⊙ DEEP DEPRESSURIZATION WELL
- IV INDUCED VACUUM MEASUREMENT
- (IWC) INCHES OF WATER COLUMN
- USEPA UNITED STATES ENVIRONMENTAL PROTECTION AGENCY

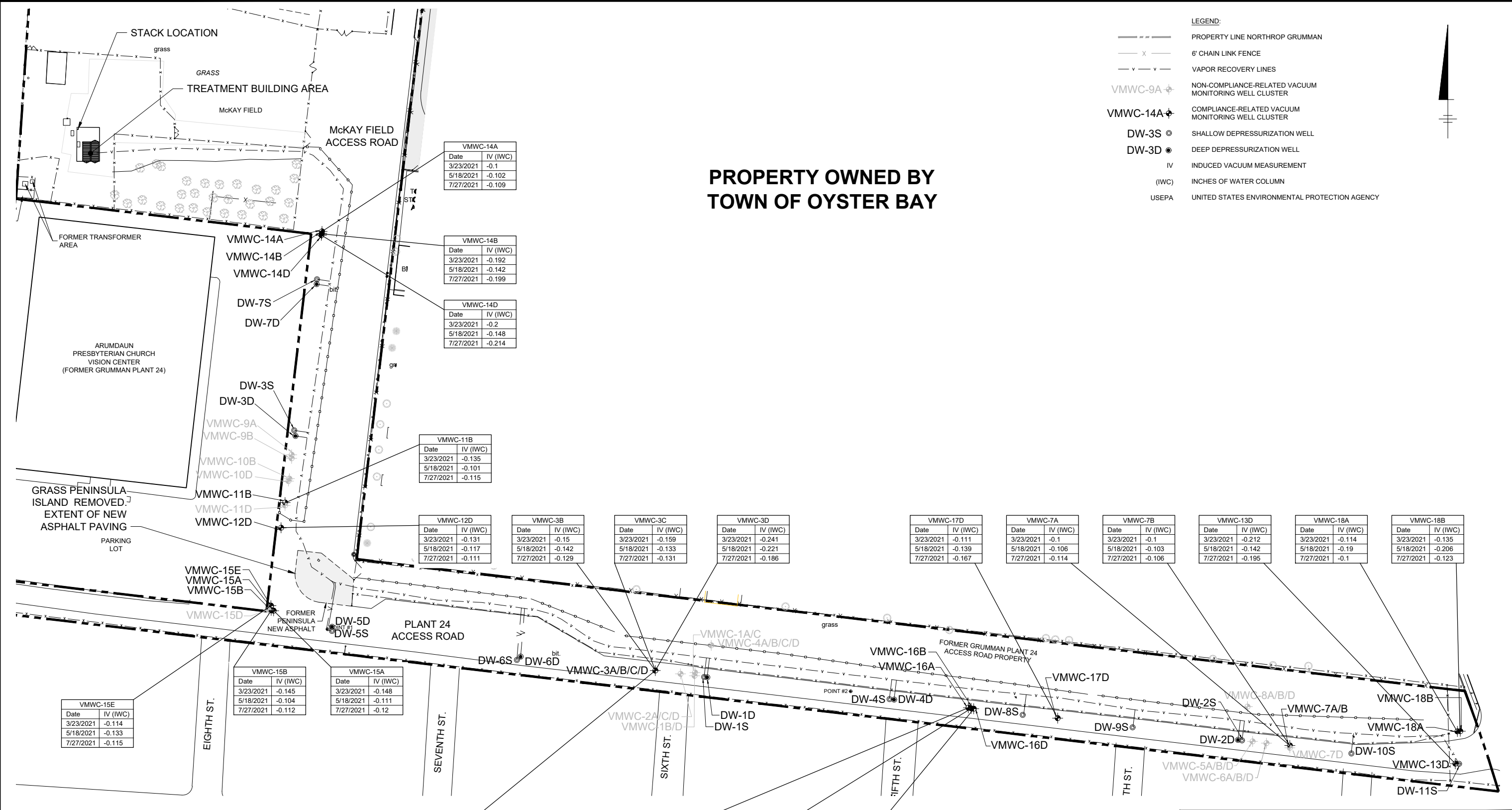

- NOTES:**
- USEPA'S RADON GUIDANCE RECOMMENDS NEGATIVE PRESSURE OF 0.035 INCHES OF WATER FOR THE CONTROL OF SOIL VAPOR (EPA 625/R-93-011, 1993).
 - SYSTEM DESIGN OBJECTIVE IS TO MAINTAIN -0.1 IWC OF INDUCED VACUUM AT ALL COMPLIANCE-RELATED VACUUM MONITORING WELLS ON A 12-MONTH ROLLING AVERAGE (ARCADIS 2007).
 - DATA SHOWN HEREIN ARE COLLECTED FROM COMPLIANCE-RELATED VACUUM MONITORING WELLS ONLY.

NORTHROP GRUMMAN
 BETHPAGE PARK SOIL GAS CONTAINMENT SYSTEM
 BETHPAGE, NEW YORK
OPERABLE UNIT 3
 (FORMER GRUMMAN SETTLING PONDS)

**GENERAL SITE PLAN AND
 MONITORING WELL VACUUM MEASUREMENTS
 THIRD QUARTER 2021**

ARCADIS

FIGURE
2

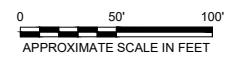

CITY: SYRACUSE, NY; DIV: GROUNDWATER; DBA: SANCHEZ, LDALS; PIC: (G); PM: (R); TM: (G); L:\V\CH\CH\CFE\REF-
 C:\Users\sbarnes\OneDrive - ARCADIS\BIM 360\Desktop\THROPT\GRUMMAN\03 SUBPROJECT 2 BETHPAGE PARK\MM\INT4\98F03.dwg; LAYOUT: 3; SAVED: 3/15/2017 1:15 PM; ACADVER: 21.0; US (LMS TECH); PAGES: 1; PLOT: 1; PLOTTABLE: 1; PLOTTED: 2/28/2018 7:44 PM; BY: SANCHEZ, ADRIAN
 XREFS: IMAGES: PROJECTNAME:

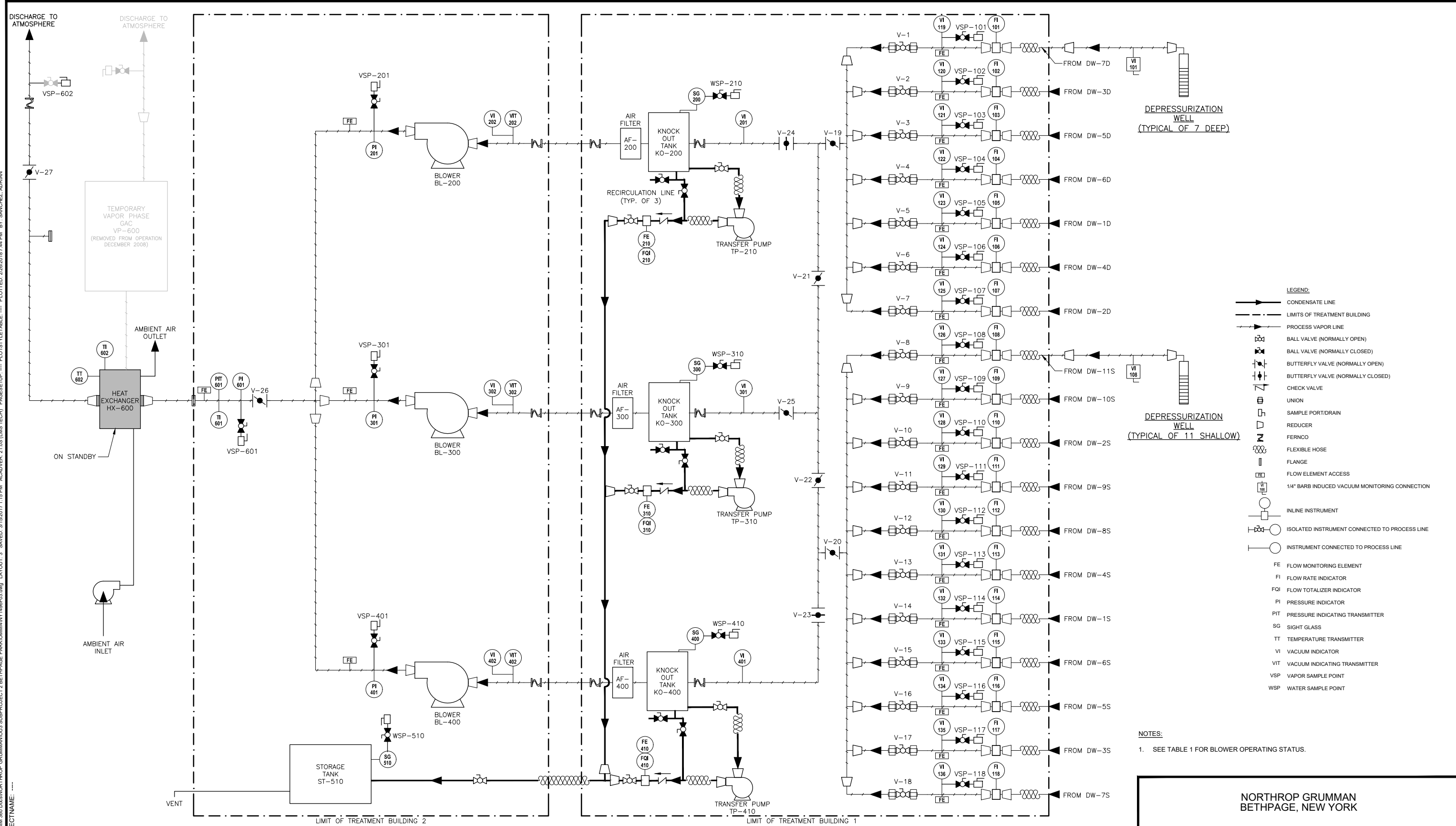

- LEGEND:**
- CONDENSATE LINE
 - - - LIMITS OF TREATMENT BUILDING
 - PROCESS VAPOR LINE
 - BALL VALVE (NORMALLY OPEN)
 - ◻ BALL VALVE (NORMALLY CLOSED)
 - ◻ BUTTERFLY VALVE (NORMALLY OPEN)
 - ◻ BUTTERFLY VALVE (NORMALLY CLOSED)
 - ◻ CHECK VALVE
 - ◻ UNION
 - ◻ SAMPLE PORT/DRAIN
 - ◻ REDUCER
 - ◻ FERNCO
 - ◻ FLEXIBLE HOSE
 - ◻ FLANGE
 - ◻ FLOW ELEMENT ACCESS
 - ◻ 1/4" BARB INDUCED VACUUM MONITORING CONNECTION
 - INLINE INSTRUMENT
 - ISOLATED INSTRUMENT CONNECTED TO PROCESS LINE
 - INSTRUMENT CONNECTED TO PROCESS LINE
- FE FLOW MONITORING ELEMENT
 FI FLOW RATE INDICATOR
 FOI FLOW TOTALIZER INDICATOR
 PI PRESSURE INDICATOR
 PIT PRESSURE INDICATING TRANSMITTER
 SG SIGHT GLASS
 TT TEMPERATURE TRANSMITTER
 VI VACUUM INDICATOR
 VIT VACUUM INDICATING TRANSMITTER
 VSP VAPOR SAMPLE POINT
 WSP WATER SAMPLE POINT

NOTES:
 1. SEE TABLE 1 FOR BLOWER OPERATING STATUS.

NORTHROP GRUMMAN
 BETHPAGE, NEW YORK

PROCESS FLOW DIAGRAM

3

FIGURE

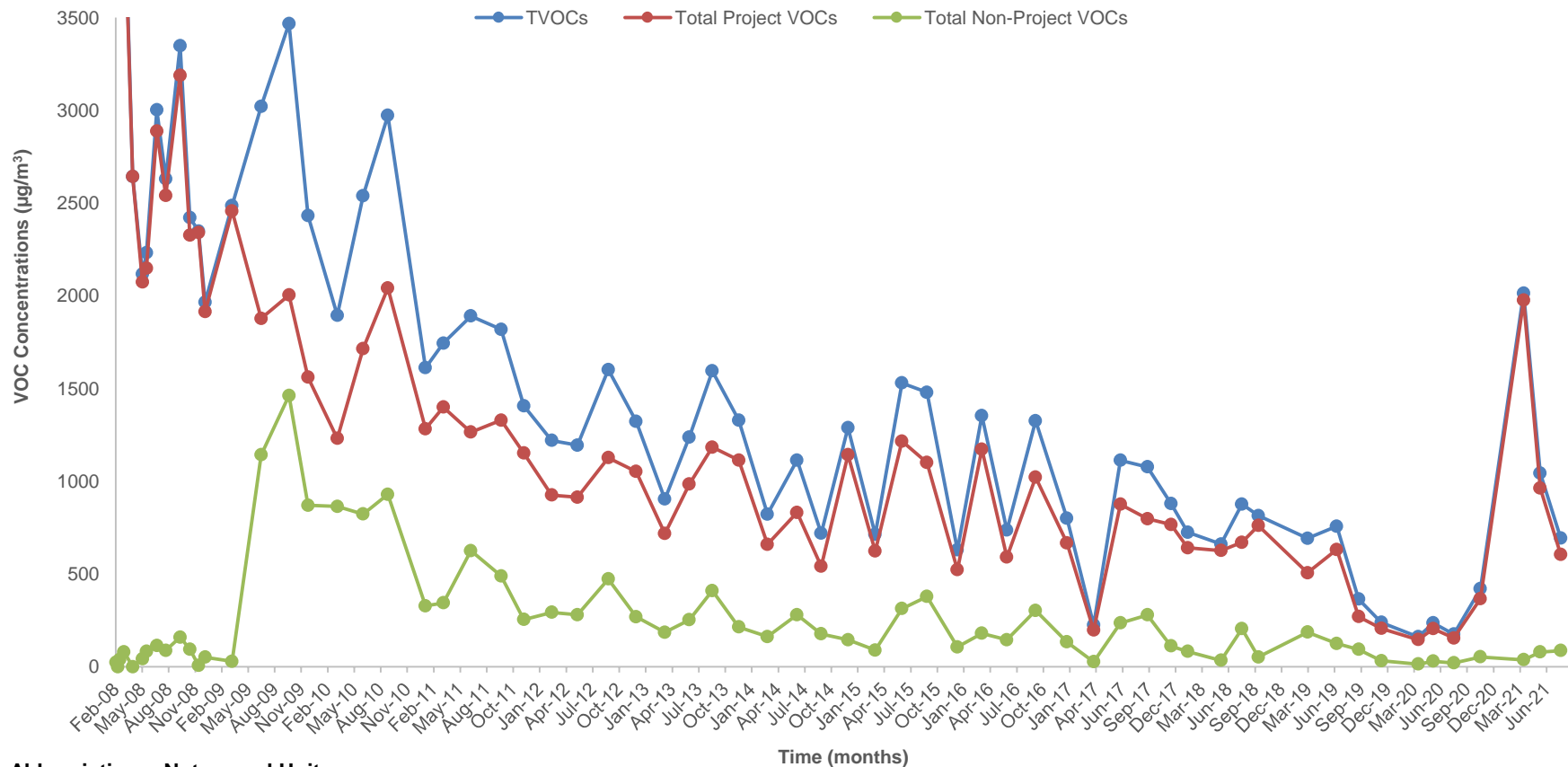

Abbreviations, Notes, and Units:

VOCs = Volatile Organic Compounds
 TVOCs = Total VOCs detected

Total Project VOCs = Sum of 1,1,1-trichloroethane; 1,1-dichloroethane; 1,2-dichloroethane; 1,1-dichloroethene; tetrachloroethene; trichloroethene; vinyl chloride; cis-1,2-dichloroethene; trans-1,2-dichloroethene; benzene; toluene; and total xylenes.

Total Non-Project VOCs = Sum of VOCs that are not Project VOCs.

1. Samples were collected at Vapor Sample Port-601 (VSP-601); refer to Figure 3 of this OM&M report for the location of VSP-601.
2. Results prior to April 16, 2008 are not shown to improve figure clarity. The TVOC and Total Project VOC concentrations are greater than 3,500 µg/m³. See previous reports for full data set.
3. The sample results from December 3, 2010 are not consistent with historical data and the results are excluded from this figure. The TVOC concentration for December 3, 2010 was 13 µg/m³.

µg/m³ = micrograms per cubic meter

NORTHROP GRUMMAN BETHPAGE PARK SOIL GAS CONTAINMENT SYSTEM BETHPAGE, NEW YORK, OPERABLE UNIT 3 (FORMER GRUMMAN SETTLING PONDS)	
SOIL GAS VOC CONCENTRATIONS	
	FIGURE 4

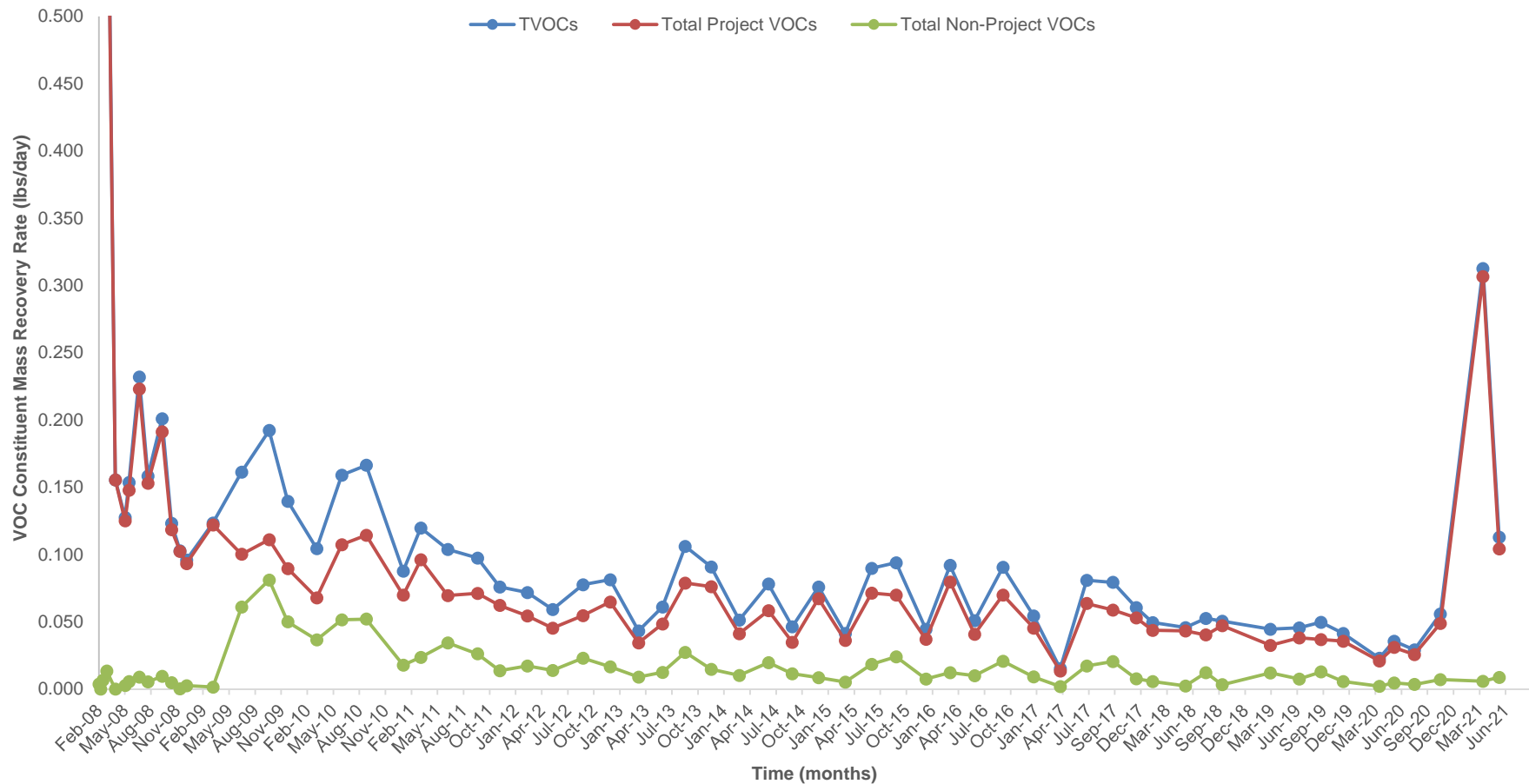

Abbreviations, Notes, and Units:

VOCs = Volatile Organic Compounds

TVOCs = Total VOCs detected

Total Project VOCs = Sum of 1,1,1-trichloroethane; 1,1-dichloroethane; 1,2-dichloroethane; 1,1-dichloroethene; tetrachloroethene; trichloroethene; vinyl chloride; cis-1,2-dichloroethene; trans-1,2-dichloroethene; benzene; toluene; and total xylenes.

Total Non-Project VOCs = Sum of VOCs that are not Project VOCs.

1. Results prior to April 16, 2008 are not shown to improve figure clarity. The TVOC and Total Project VOC concentrations are greater than 0.3 lbs/day. See previous reports for full data set.
2. The sample results from December 3, 2010 are not consistent with historical data and the results are excluded from this figure. The TVOC concentration for December 3, 2010 was 13 µg/L.

lbs/day = pounds per day

NORTHROP GRUMMAN BETHPAGE PARK SOIL GAS CONTAINMENT SYSTEM BETHPAGE, NEW YORK, OPERABLE UNIT 3 (FORMER GRUMMAN SETTLING PONDS)	
VOC MASS RECOVERY RATES	
	FIGURE 6