

R-49-2-92-1

**FINAL  
REMEDIAL INVESTIGATION REPORT  
NAVAL WEAPONS INDUSTRIAL  
RESERVE PLANT  
BETHPAGE, NEW YORK**

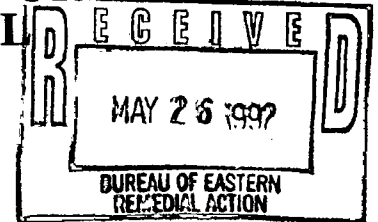

**VOLUME I**

**PREPARED BY**

**HALLIBURTON NUS  
ENVIRONMENTAL CORPORATION  
PITTSBURGH, PENNSYLVANIA**

**COMPREHENSIVE LONG-TERM  
ENVIRONMENTAL ACTION NAVY  
(CLEAN) PROGRAM**

**CONTRACT NO. N62472-90-D-1298  
CONTRACT TASK ORDER NUMBER 0003**

**MAY 1992**





661 ANDERSEN DRIVE • PITTSBURGH, PENNSYLVANIA 15220 • (412) 921-7090

R-49-2-92-1

**FINAL  
REMEDIAL INVESTIGATION REPORT  
NAVAL WEAPONS INDUSTRIAL RESERVE PLANT  
BETHPAGE, NEW YORK**

**COMPREHENSIVE LONG-TERM  
ENVIRONMENTAL ACTION NAVY (CLEAN) PROGRAM**

**Submitted to:  
Northern Division  
Environmental Branch, Code 1821/DF  
Naval Facilities Engineering Command  
Building 77-L, U.S. Naval Base  
Philadelphia, Pennsylvania 19112-5094**

**Submitted by:  
HALLIBURTON NUS Environmental Corporation  
661 Andersen Drive  
Pittsburgh, Pennsylvania 15220**

**Contract No. N62472-90-D-1298  
Contract Task Order Number 0003**

**MAY 1992**

**SUBMITTED FOR HALLIBURTON NUS BY:**

*David D. Brayack*  
\_\_\_\_\_  
**DAVID D. BRAYACK, P.E.  
PROJECT MANAGER**

**APPROVED:**

*John J. Trepanowski*  
\_\_\_\_\_  
**FOR JOHN J. TREPANOWSKI, P.E.  
PROGRAM MANAGER**

*technologies and services for a cleaner and safer world*

## TABLE OF CONTENTS

	<u>PAGE</u>
<b>1.0 INTRODUCTION</b>	<b>1-1</b>
1.1 Purpose of Report	1-1
1.2 Scope and Objectives	1-1
1.3 Activity Background Information	1-1
1.3.1 Activity Location and Description	1-1
1.3.2 Activity History	1-4
1.3.3 Site Description	1-6
1.3.3.1 Site 1: Former Drum Marshaling Area	1-6
1.3.3.2 Site 2: Recharge Basin Area	1-6
1.3.3.3 Site 3: Salvage Storage Area	1-7
1.4 Summary of Grumman RI/FS Activities	1-8
1.4.1 Previous Grumman Investigations	1-8
1.4.2 Grumman RI/FS Activities	1-9
1.5 Report Organization	1-11
<b>2.0 FIELD PROGRAM DESCRIPTIONS AND RATIONALE</b>	<b>2-1</b>
2.1 Scoping of Remedial Investigation	2-1
2.1.1 Data Limitations and Requirements	2-1
2.1.2 Data Quality Objectives	2-6
2.2 Soil-Gas Survey	2-6
2.3 Temporary Monitoring Well Survey	2-9
2.4 Soil Borings and Sampling	2-11
2.5 Surface Soil Sampling	2-11
2.6 Monitoring Well Installation	2-13
2.7 Groundwater Sampling	2-17
2.8 Surface Water and Sediment Sampling	2-19
2.9 Water-Level Measurements	2-19
2.10 Horizontal and Vertical Elevation Survey	2-21
<b>3.0 PHYSICAL CHARACTERISTICS OF STUDY AREA</b>	<b>3-1</b>
3.1 Surface Features	3-1
3.2 Geology	3-1
3.2.1 Summary	3-1
3.2.2 Stratigraphy	3-5

**TABLE OF CONTENTS (Cont'd)**

	<b><u>PAGE</u></b>	
3.2.2.1	Upper Glacial Formation	3-5
3.2.2.2	Magothy Formation	3-6
3.2.2.3	Raritan Formation	3-7
3.3	Hydrogeology	3-7
3.3.1	Summary	3-7
3.3.2	Aquifer Characteristics	3-8
3.3.3	Groundwater Flow Characteristics	3-13
3.3.3.1	Horizontal Flow	3-13
3.3.3.2	Vertical Flow	3-23
<b>4.0</b>	<b>NATURE AND EXTENT OF CONTAMINATION</b>	<b>4-1</b>
4.1	Former Drum Marshaling Area (Site 1)	4-1
4.1.1	Soil Gas	4-1
4.1.2	Temporary Monitoring Wells	4-6
4.1.3	Subsurface Soils	4-6
4.1.4	Groundwater Data	4-12
4.1.5	Surface Soils	4-32
4.1.6	Summary	4-38
4.2	Recharge Basins (Site 2)	4-39
4.2.1	Soil-Gas	4-39
4.2.2	Temporary Monitoring Wells	4-39
4.2.3	Subsurface Soils	4-44
4.2.4	Groundwater Data	4-50
4.2.5	Surface Water and Sediments	4-59
4.2.6	Surface Soils	4-59
4.2.7	Summary	4-66
4.3	Salvage Storage Area (Site 3)	4-70
4.3.1	Soil-Gas	4-70
4.3.2	Temporary Monitoring Wells	4-70
4.3.3	Subsurface Soils	4-77
4.3.4	Groundwater Data	4-77
4.3.5	Surface Soils	4-91
4.3.6	Summary	4-95
4.4	Overall Groundwater Considerations	4-96



TABLE OF CONTENTS (Cont'd)

	<u>PAGE</u>	
4.5	QA/QC Summary	4-96
4.5.1	Field QA/QC Samples	4-96
4.5.2	Analytical Methods	4-101
4.5.3	Laboratory QA/QC	4-106
4.5.4	Data Validation	4-106
<b>5.0</b>	<b>CONTAMINANT FATE AND TRANSPORT</b>	<b>5-1</b>
5.1	Potential Migration Routes	5-1
5.2	Contaminant Persistence	5-1
5.3	Contaminant Migration	5-6
<b>6.0</b>	<b>BASELINE RISK ASSESSMENT</b>	<b>6-1</b>
6.1	Data Evaluation	6-2
6.1.1	Representative Concentrations	6-2
6.1.2	Chemicals of Concern	6-3
6.1.2.1	Surface Soil	6-4
6.1.2.2	Subsurface Soil	6-7
6.1.2.3	Recharge Basins	6-7
6.1.2.4	Groundwater	6-10
6.1.2.5	Future Groundwater	6-10
6.2	Toxicity Assessment	6-14
6.2.1	Health Effects	6-14
6.2.1.1	Reference Doses (RfDs)	6-18
6.2.1.2	Carcinogenic Slope Factor (CSF)	6-18
6.2.1.3	EPA Weight-of-Evidence	6-19
6.2.2	Applicable or Relevant and Appropriate Requirements (ARARs)	6-19
6.2.2.1	Maximum Contaminant Levels (MCLs)	6-19
6.2.2.2	Maximum Contaminant Level Goals (MCLGs)	6-19
6.2.2.3	Ambient Water Quality Criteria (AWQC)	6-27
6.2.2.4	Drinking Water Health Advisories (DWHAs)	6-27

**TABLE OF CONTENTS (Cont'd)**

	<u>PAGE</u>	
6.2.3	Summary	6-27
6.3	Exposure Assessment	6-27
6.3.1	Exposure Routes	6-28
6.3.1.1	Groundwater	6-28
6.3.1.2	Soil	6-30
6.3.1.3	Surface Water/Sediment (Recharge Basins)	6-30
6.3.2	Exposure Estimates	6-30
6.3.2.1	Groundwater Exposure	6-31
6.3.2.2	Soil Exposure	6-36
6.4	Risk Characterization	6-41
6.4.1	Potential Current Groundwater Exposure	6-45
6.4.2	Potential Current Soil Exposure	6-48
6.4.3	Projected Groundwater Exposure	6-48
6.4.4	Projected Soil Exposure	6-56
6.4.5	Summary	6-56
6.5	Environmental Assessment	6-63
6.6	Uncertainty Analysis	6-64
<b>7.0</b>	<b>SUMMARY AND CONCLUSIONS</b>	<b>7-1</b>
7.1	Site 1 - Drum Marshaling Area	7-1
7.1.1	Field Activities	7-1
7.1.2	Geology/Hydrology	7-1
7.1.3	Nature and Extent of Contamination	7-3
7.1.4	Baseline Risk Assessment	7-3
7.1.5	Conclusions	7-4
7.1.6	Data Limitations and Recommendations	7-5
7.2	Site 2 - Recharge Basin Area	7-6
7.2.1	Field Activities	7-6
7.2.2	Geology/Hydrology	7-6
7.2.3	Nature and Extent of Contamination	7-8
7.2.4	Baseline Risk Assessment	7-8
7.2.5	Conclusions	7-9
7.2.6	Data Limitations and Recommendations	7-10

**TABLE OF CONTENTS (Cont'd)**

		<b><u>PAGE</u></b>
7.3	Site 3 - Salvage Storage Area	7-10
7.3.1	Field Activities	7-10
7.3.2	Geology/Hydrology	7-11
7.3.3	Nature and Extent of Contamination	7-12
7.3.4	Baseline Risk Assessment	7-13
7.3.5	Conclusions	7-13
7.3.6	Data Limitations	7-14

**TABLE OF CONTENTS (Cont'd)**

<u>TABLES</u>	<u>PAGE</u>
2-1 Basis of Analytical Testing	2-3
2-7 NEESA Level D Requirements	2-18
3-1 Wells Located on NWIRP Property	3-11
3-2 Groundwater Elevations	3-12
4-1 Soil-Gas Results - Site 1 (ug/l)	4-4
4-2 Temporary Monitoring Well Results (ug/l) Site 1	4-7
4-3 Occurrence and Distribution of Subsurface Soil Contaminants Site 1 - Organic (ug/kg)	4-8
4-4 Background Soil Contaminants - Organic (ug/kg)	4-13
4-5 Background Subsurface Soil Results - Inorganics (mg/kg)	4-14
4-6 Occurrence and Distribution of Subsurface Soil Contaminants - Site 1 - Organic (mg/kg)	4-15
4-7 Positive Detections of Organic Groundwater Contaminants - Site 1 (ug/l)	4-16
4-8 Positive Detections of Unfiltered Inorganic Groundwater Contaminants - Site 1 (ug/l)	4-27
4-9 Positive Detections of Filtered Inorganic Groundwater Contaminants - Site 1 (ug/l)	4-29
4-10 Occurrence and Distribution of Surface Soil Contaminants - Site 1 - Organic (ug/kg)	4-33
4-11 Occurrence and Distribution of Surface Soil Contaminants - Site 1 - Inorganic (mg/kg)	4-35
4-12 Soil-Gas Results - Site 2 (ug/l)	4-42
4-13 Temporary Monitoring Well - Site 2 - Organic Results (ug/l)	4-45
4-14 Occurrence and Distribution of Subsurface Soil Contaminants - Site 2 - Organic (ug/kg)	4-46
4-15 Occurrence and Distribution of Subsurface Soil Contaminants - Site 2 - Inorganic (mg/kg)	4-49
4-16 Positive Detections of Organic Groundwater Contaminants - Site 2 (ug/l)	4-51
4-17 Positive Detections of Unfiltered Inorganic Groundwater Contaminants - Site 2 (ug/l)	4-55
4-18 Positive Detections of Filtered Inorganic Groundwater Contaminants - Site 2 (ug/l)	4-56
4-19 Occurrence and Distribution of Surface Water Contaminants - Site 2 - Organic (ug/l)	4-60
4-20 Occurrence and Distribution of Surface Water Contaminants - Site 2 - Inorganic (ug/l)	4-61

**TABLE OF CONTENTS (Cont'd)**

<b><u>TABLES</u></b>	<b><u>PAGE</u></b>
4-21 Occurrence and Distribution of Recharge Basin Sediment - Organic (ug/kg)	4-63
4-22 Occurrence and Distribution of Recharge Basin Sediment - Organic (mg/kg)	4-64
4-23 Occurrence and Distribution of Subsurface Soil Contaminants - Site 2 - Organic (ug/kg)	4-67
4-24 Occurrence and Distribution of Surface Soil Contaminants - Site 2 - Inorganic (mg/kg)	4-68
4-25 Soil-Gas Results - Site 3 (ug/l)	4-73
4-26 Temporary Monitoring Well - Site 3 - Organic Results (ug/l)	4-76
4-27 Occurrence and Distribution of Subsurface Soil Contaminants - Site 3 - Organic (ug/kg)	4-78
4-28 Occurrence and Distribution of Subsurface Soil Contaminants - Site 3 - Inorganic (mg/kg)	4-81
4-29 Positive Detections of Organic Groundwater Contaminants - Site 3	4-82
4-30 Positive Detections of Organic Groundwater Contaminants - Site 3	4-89
4-31 Positive Detections of Unfiltered Inorganic Groundwater Contaminants - Site 3	4-90
4-32 Occurrence and Distribution of Surface Soil Contaminants - Site 3 - Organic (ug/kg)	4-93
4-33 Occurrence and Distribution of Surface Soil Contaminants - Site 3 - Inorganic (mg/kg)	4-94
4-34 Occurrence and Distribution of Groundwater Contamination - Organic (ug/l)	4-97
4-35 Occurrence and Distribution of Groundwater Inorganics - Unfiltered (ug/l)	4-98
4-36 Occurrence and Distribution of Groundwater Inorganics - Filtered (ug/l)	4-99
4-37 Occurrence and Distribution of Protection	4-100
4-38 Trip Blank Contamination (ug/l) - Summary	4-102
4-39 Rinsate Contamination (ug/l) - Summary	4-103
4-40 Field Blank Contamination (ug/l) - Summary	4-104
4-41 Analytical Methods (ug/l) - Summary	4-105
5-1 Hydrolysis Rate Constants for Organic Chemicals <sup>(1)</sup>	5-4
5-2 Mobility Parameters and Properties for Inorganic Chemicals	5-7
5-3 Mobility Parameters for Organic Chemicals	5-8
5-4 Engineering Parameter Results	5-12
5-5 Retardation Factors for Organic Subsoil	5-13

**TABLE OF CONTENTS (Cont'd)**

<b><u>TABLES</u></b>	<b><u>PAGE</u></b>
6-1 Organic Chemicals of Concern - Surface Soil (ug/kg)	6-5
6-2 Inorganic Chemicals of Concern - Surface Soil (mg/kg)	6-6
6-3 Organic Chemicals of Concern - Subsurface Soil (ug/kg)	6-8
6-4 Inorganic Chemicals of Concern - Subsurface Soil (mg/kg)	6-9
6-5 Organic Chemicals of Concern - Current Groundwater (ug/l)	6-11
6-6 Inorganic Chemicals of Concern - Current Groundwater (ug/l)	6-12
6-7 Future Groundwater Contamination - Organics	6-15
6-8 Chemicals of Concern - Future Groundwater (ug/l)	6-17
6-9 EPA Weight-of-Evidence Carcinogenic Classifications	6-20
6-10 Standards, Guidelines, and Dose-Response Parameters for Chemicals of Concern	6-21
6-11 Exposure Scenarios	6-29
6-12 Exposure Input Parameters - Groundwater Ingestion (Assuming Residential Use)	6-33
6-13 Exposure Input Parameters - Groundwater Ingestion (Nonresidential Scenarios)	6-34
6-14 Exposure Input Parameters - Groundwater Dermal Contact (Assuming Residential Use)	6-35
6-15 Exposure Input Parameters - Groundwater Inhalation (Assuming Residential Use)	6-37
6-16 Exposure Input Parameters - Soil Exposure, Dermal	6-39
6-17 Exposure Input Parameters - Soil Ingestion	6-40
6-18 Exposure Input Parameters - Soil Dust	6-42
6-19 Hazard Invoices - Exposure to Current Groundwater Concentrations	6-46
6-20 Carcinogenic Risks - Exposure to Current Groundwater Concentrations	6-47
6-21 Hazard Indices - Current Surface Soil Exposure	6-49
6-22 Carcinogenic Risks - Current Surface Soil Exposure	6-52
6-23 Hazard Indices - Future Groundwater Exposure	6-55
6-24 Carcinogenic Risks - Future Groundwater Exposure	6-57
6-25 Hazard Indices - Future Soil Exposure	6-58
6-26 Carcinogenic Risks - Future Soil Exposure	6-61

**TABLE OF CONTENTS (Cont'd)**

<b><u>FIGURES</u></b>	<b><u>PAGE</u></b>
1-1 General Location Map	1-2
1-2 Activity Layout	1-3
1-3 Site Layout	1-5
1-4 Location of Existing New-Regional Groundwater Wells	1-10
2-1 Soil-Gas Locations	2-7
2-2 Temporary Monitoring Well Locations	2-10
2-3 Soil Boring Locations	2-12
2-4 Surface Soil Sample Locations	2-14
2-5 Location of Monitoring Wells	2-15
2-6 Surface Water and Sediment Sample Locations	2-20
3-1 North-South Cross-Section Through the NWIRP	3-2
3-2 East-West Cross-Section Through the NWIRP	3-3
3-3 Cross-Section Locations	3-4
3-4 Grumman Facility Wells and Recharge Basins	3-10
3-5 Shallow Magothy Aquifer (Shallow Wells) December 18, 1991	3-15
3-6 Magothy Aquifer (Intermediate Wells) December 18, 1991	3-17
3-7 Shallow Magothy Aquifer (Shallow Wells) January 24, 1992	3-19
3-8 Magothy Aquifer (Intermediate Wells) January 24, 1992	3-21
4-1 Soil Gas Results - Shallow	4-2
4-2 Soil Gas Results - Deep	4-3
4-3 Site 1 - Subsurface Soil Results - TCE	4-9
4-4 Site 1 - Subsurface Soil Results - PCE	4-10
4-5 Site 1 - Subsurface Soil Results - 1,1,1-TCA	4-11
4-6 Groundwater Shallow Isoconcentration Contours - TCE	4-17
4-7 Groundwater Shallow Isoconcentration Contours - 1,1,1-TCA	4-18
4-8 Groundwater Shallow Isoconcentration Contours - PCE	4-19
4-9 Groundwater Intermediate Isoconcentration Contours - TCE	4-20

TABLE OF CONTENTS (Cont'd)

<u>FIGURES</u>	<u>PAGE</u>
4-10 Groundwater - Intermediate Isoconcentration Contours - 1,1,1-TCA	4-21
4-11 Groundwater - Intermediate Isoconcentration Contours - PCE	4-22
4-12 Shallow Groundwater Organics Above MCLS, ALS, RFD	4-23
4-13 Intermediate Groundwater Organics Above MCLS, ALS RFD	4-24
4-14 Groundwater Shallow Inorganics (Unfiltered)	4-30
4-15 Groundwater Intermediate Inorganics (Unfiltered)	4-31
4-16 Site 1 - Surface Soil Results -PCE	4-36
4-17 Site 1 - Surface Soil Results - TCE	4-37
4-18 Soil Gas Results - Shallow Remedial Investigation	4-40
4-19 Soil Gas Results - Deep Remedial Investigation	4-41
4-20 Site 2 - Subsurface Soil Results - TCE	4-47
4-21 Site 2 - Subsurface Soil Results - PCE	4-48
4-22 Shallow Groundwater Organics Above MCLS, ALS, RFD	4-52
4-23 Intermediate Groundwater Organics Above MCLS, ALS, RFD	4-53
4-24 Groundwater Shallow Inorganics (Unfiltered)	4-57
4-25 Groundwater Intermediate Inorganics (Unfiltered)	4-58
4-26 Site 2 - Surface Water Results - Organics	4-62
4-27 Site 2 - Sediment Results - Organics	4-65
4-28 Site 2 - Surface Soil Results - TCE	4-69
4-29 Soil Gas Results - Shallow	4-71
4-30 Soil Gas Results - Deep	4-72
4-31 Site 3 - Subsurface Results - TCE	4-79
4-32 Site 3 - Subsurface Results - PCE	4-80
4-33 Shallow Groundwater Organics Above MCLS, ALS, RFD	4-83
4-34 Intermediate Groundwater Organics Above MCLS, ALS, RFD	4-84
4-35 Groundwater Shallow Inorganics (Unfiltered)	4-87
4-36 Groundwater Intermediate Inorganics (Unfiltered)	4-88
4-37 Production Wells Organics Remedial Investigation	4-92



TABLE OF CONTENTS (Cont'd)

FIGURES

PAGE

5-1 Transformation Pathways for Various  
Chlorinated Volatile Hydrocarbons in  
Soil Systems

5-3

EXECUTIVE SUMMARY

## EXECUTIVE SUMMARY

### Purpose of Report

The work to be performed under Contract N62472-90-D-1298, Contract Task Order (CTO) 0003, is to conduct a Remedial Investigation (RI) at the Naval Weapons Industrial Reserve Plant (NWIRP), Bethpage, New York.

This work is part of the Navy's Installation Restoration Program, which is designed to identify contamination of Navy and Marine Corps lands/facilities resulting from past operations and to institute corrective measures, as needed.

### Scope and Objectives

The overall objective of this RI is to characterize the nature and extent of potential environmental contamination and associated risks to human health and the environment at the NWIRP. The data collected will also be used to evaluate potential remedial options. The specific objectives for the Bethpage activity are to identify the location and concentration of potential soil and groundwater contamination by solvents and metals at three sites identified in the Initial Assessment Study (IAS) and to determine whether these sites are the source or one of the sources of an organic compound contaminated groundwater plume in the Bethpage area. Similar investigations are currently underway at the Grumman Bethpage and RUCO Polymer Corporation (RUCO) facilities. Other potential sources of this contamination may exist.

### Activity Background Information

The NWIRP is situated on 108 acres in Nassau County in the Hamlet of Bethpage, Town of Oyster Bay, New York. The NWIRP lies entirely within the Grumman Aerospace complex, which covers approximately 605 acres. The NWIRP is bordered on the north, west, and south by Grumman facilities, and on the east by a residential neighborhood.

The histories of the NWIRP and Grumman Aerospace facilities are discussed in detail in the Initial Assessment Study of the NWIRP and the RI/FS Work Plan for the Grumman facility prepared by Geraghty and Miller. The following synopsis is from those discussions.

The NWIRP was established in 1933. Since its inception, the plant's primary mission has been the research prototyping, testing, design engineering, fabrication, and primary assembly of military aircraft.

The facilities at NWIRP include four plants (Nos. 3, 5, and 20, used for assembly and prototype testing; and No. 10, a group of

quality control laboratories), two warehouse complexes (north and south), a salvage storage area, water recharge basins, the Industrial Wastewater Treatment Plant (to process chemical effluents from the activity's manufacturing operations), and several smaller support buildings.

An Initial Assessment Study (IAS) of NWIRP Bethpage, New York, and NWIRP Calverton, New York, conducted in 1986 indicated that three areas at the Bethpage Plant may pose a threat to human health or the environment. These three sites are Site 1 - Former Drum Marshaling Area, Site 2 - Recharge Basin Area, and Site 3 - Salvage Storage Area. Based on the historic data presented in the IAS, there is the potential for volatile organic, semivolatile organic, and inorganic contamination at each of the three sites.

Grumman Aerospace Corporation is conducting a parallel investigation at its facility. The purpose of the Grumman RI/FS was to execute a series of tasks that would lead to the identification and definition of potential contamination attributable to the Grumman facility and provide sufficient data for the conceptual design of a remedial action alternative (if needed) for the site. The Grumman RI/FS is being conducted in a phased approach. Phase 1 (the initial field investigation) was intended to define the nature and extent of potential onsite contamination attributable to the Grumman facility. Applicable results of the Phase 1 study have been included in this report. A work plan for the Phase 2 Remedial Investigations, which will address on- and off-site areas, was recently submitted to the NYDEC.

#### **Geology/Hydrology**

The NWIRP is underlain by approximately 1,100 feet of unconsolidated sediments that unconformably overlie crystalline bedrock. The unconsolidated sediments consist of four distinct geologic units that, in descending order, are the Upper Glacial Formation, the Magothy Formation, the Raritan Clay Member of the Raritan Formation, and the Lloyd Sand Member of the Raritan Formation. The crystalline bedrock consists primarily of schist, gneiss, and granite. The regional dip is to the south and southeast. All of the geologic units dip in these directions, although to varying degrees.

The Upper Glacial and the Magothy Formations were penetrated and sampled; the Raritan Formation lies below the total depth of this investigation. The Upper Glacial Formation, which is about 30 to 45 feet thick, consists chiefly of coarse sands and gravels. The upper Magothy Formation consists chiefly of coarse sands to a depth of about 100 feet, below which finer sands, silts, and clays predominate. The clay is fairly common but laterally discontinuous; no individual clay horizon of regional extent underlies the NWIRP.

The Upper Glacial Formation, the Magothy Formation, and the Lloyd Sand are regional aquifers. Because of their proximity to the land surface, the principal aquifers of concern in this investigation are the Upper Glacial and Magothy aquifers. Of these two aquifers, the Magothy aquifer is the major source of public water in Nassau County. Because of its depth the Lloyd Sand is not widely exploited. Furthermore, the Lloyd Sand is isolated from the shallower aquifers by the Raritan Clay confining unit.

The water table beneath the NWIRP occurred completely within the Magothy Formation in December 1991. The magnitude of the seasonal water-table fluctuation beneath the site is unknown, but it is unlikely that the water table rises to the Upper Glacial Formation. The high permeability of the glacial deposits, however, allows for the rapid recharge of precipitation to the underlying Magothy.

The geologic and hydrologic information obtained from this study indicates that the Upper Glacial and upper Magothy aquifers beneath the NWIRP are interconnected and may be considered a common aquifer. This confirms the theory that the site-specific geology is similar to the regional geology, as described in published reports. Groundwater in this aquifer occurs under water-table or unconfined conditions. The number and thickness of clay lenses increase with depth within the Magothy, but the horizontally discontinuous nature of these units prevents any one of them from singularly functioning as an aquitard or semiconfining unit.

The groundwater beneath the NWIRP dominantly flows to the southwest and, to a lesser extent, to the south. The flow is greatly influenced by the groundwater mounding that occurs at the recharge basins and by the groundwater withdrawal at the numerous facility wells. The wells have the potential to significantly change the local flow pattern. These wells operate on an irregular basis and in various combinations. Consequently, their influence on the local flow regime at any particular time is difficult to predict.

The horizontal hydraulic gradient varies throughout the NWIRP due to the recharge basins and facility wells. The average gradient calculated across the activity is about 5.3 feet/mile, which is significantly lower than the published regional gradient of 10 feet/mile. The average linear velocity of the groundwater at the water table is estimated to range from 0.2 ft/day to 0.9 ft/day, which is significantly less than the previously estimated 50 to 70 ft/day.

The NWIRP occupies an area of recharge. Vertical hydraulic gradients are in a downward direction, but are very low. This agrees with previously published regional data.

## Site 1: Former Drum Marshaling Area

### History

Starting in 1969, hazardous waste management practices for Grumman facilities on Long Island included marshaling of drummed wastes on the Navy property at NWIRP Bethpage. Such storage first took place on a cinder-covered surface over the cesspool field east of Plant 03. From the early 1950s through about 1978, drums containing liquid cadmium waste were stored here. In 1978, the collection and marshaling point was moved a few yards south of the original unpaved site, to an area on a 100- by 100-foot concrete pad. This pad had no cover, nor did it have berms for containment of spills. In 1982, drummed waste storage was transferred to the present Drum Marshaling facility, located in the Salvage Storage Area (Site 3); a cover was added in 1983.

Reportedly, all drums of waste marshaled at the Former Drum Marshaling Areas were taken off-activity by a private contractor for treatment or disposal. There are no reports of leaks or spills of drum contents.

Materials stored at the Former Drum Marshaling Areas included waste halogenated and nonhalogenated solvents. Cadmium and cyanide were also stored in this area from the early 1950s through 1974. Reportedly, 200 to 300 drums were stored at each area at any one time.

### Field Activities

The field investigation consisted of collecting 32 soil-gas samples at 16 locations, 7 surface soil samples, 18 subsurface soil samples at 10 locations, and 10 temporary monitoring well samples; installing 7 permanent monitoring wells at 3 locations; and sampling 8 permanent monitoring wells.

All of the samples were analyzed for volatile organic constituents. The surface soil samples, shallow subsurface soil samples (less than 5 feet deep), surface water, sediment, and groundwater samples were analyzed for inorganic and semivolatile organic constituents. The groundwater samples were also analyzed for soluble inorganic constituents (less than 0.45 microns) and hexavalent chromium. In addition, subsurface soils that were observed to be oil stained were analyzed for PCBs and pesticides. Select soil and groundwater samples were analyzed for engineering-type parameters. For soil, these included total organic carbon (TOC), bulk density, grain size, moisture contents and pH. For groundwater, pH, total dissolved solids (TDS), alkalinity, hardness, biochemical oxygen demand (BOD<sub>5</sub>), total organic carbon (TOC), and total suspended solids were analyzed.

### Nature and Extent of Contamination

Volatile organic compound (VOC) contamination, especially by chlorinated ethanes and chlorinated ethenes, is evident in soil and groundwater. The highest concentrations at the NWIRP were reported in Site 1, especially near the drum marshaling areas. VOC contamination was greater in shallow wells than intermediate. VOC contamination was also greater in subsurface than in surface soil. PCBs were reported at various locations in soil.

Notable levels of certain inorganics, including chromium, arsenic, and cyanide, were detected in onsite media. Surface soil in Site 3 and subsurface soil in Site 2 exhibited the highest levels of inorganics. There is no clear pattern in the concentrations of inorganics in groundwater; notable levels of metals, including arsenic, vanadium, chromium, lead and cyanide, were reported in some wells.

### Baseline Risk Assessment

To assess the risks to human health from the site contaminants, exposure scenarios were developed. For contaminated soil, the scenarios include direct contact with contaminants in surface soils through dermal contact, ingestion, and inhalation (current soil exposure); potential direct contact with subsurface soils following excavation of such soils; (future soil exposure); and indirect exposure through soil contaminants leaching to groundwater, and the contaminated groundwater being consumed (future groundwater exposure). The receptors include onsite adult workers and offsite adult and child residents. The receptors for direct contact were employees only. For the contaminated groundwater, the scenarios include residential and employee consumption of the contaminated groundwater (current groundwater exposure).

In general an acceptable range for carcinogenic risk (as defined by the NCP) ranges from  $10^{-4}$  (1 in 10,000) to  $10^{-6}$  (1 in 1 million). Remedial alternatives should be designed to attain a  $10^{16}$  risk level although factors related to exposure, uncertainty, and technical limitations may justify a deviation. For noncarcinogenic risks, a hazard index (HI) in excess of unity (1.0) reflects a potential health risk associated with exposure to a chemical mixture.

Hazard Indices calculated for current and future soil exposure are all below 1.0; adverse noncarcinogenic health effects for these pathways are not indicated. Total cancer risks for current soil exposure range from  $2E-7$  to  $4E-6$ , with the highest risk occurring for the adult employee dermal exposure scenario. Aroclor 1248 in Site 1 was the major factor in these potential dermal cancer risks. Estimated total cancer risks for future soil exposure ranged from  $9E-11$  to  $9E-6$ , with the highest risks occurring for the adult

resident dust inhalation scenario at Site 1. Arsenic at Site 1 was primarily responsible for these projected cancer risks.

For potential exposure to current groundwater concentrations, Hazard Indices exceeded 1.0 for all three potential receptors (employee, adult resident, child resident). Individual Hazard Quotients for several chemicals exceeded 1.0, including both metals and VOCs. Estimated total cancer risks ranged from  $8E-4$  to  $3E-3$ , with TCE risks comprising a large portion of the total risk.

For potential exposure to future groundwater concentrations, Hazard Indices exceeded 1.0 for the resident ingestion/dermal pathways. This was due primarily to PCE, for which the Hazard Quotient exceeded 1.0. Estimated total cancer risks ranged from  $6E-6$  to  $6E-4$ , with TCE, PCE, and Aroclor 1248 posing the greatest risks.

Based on current risk assessment modeling, it has been determined that groundwater concentrations of VOCs and inorganics are the most significant sources of noncarcinogenic and carcinogenic risk at the Bethpage site. In addition, many groundwater constituents exceeded Federal and state drinking water standards. PCBs in surface and subsurface soil at Bethpage may pose the greatest cancer risk, especially because of their high CSF.

#### Conclusions

Based on volatile organic isoconcentration contour maps, Site 1 is a likely source of on-site and near-site (Grumman) groundwater contamination. It is anticipated that additional work will be required to define the overall extent of contamination.

The soils at Site 1 contain sufficient residual volatile organic contamination to confirm the source of groundwater contamination as being near or at the former drum marshaling areas. Based on observed groundwater contamination patterns, there are potentially other source areas at the NWIRP including sumps and tanks at Plant 3 and a former coal storage pile near Plant 3.

The contaminants in the soils at the NWIRP (under the current or in future scenarios) do not represent a significant, direct, non-carcinogenic risk to onsite workers or offsite residents (hazard index is less than 1.0). Likewise, incremental carcinogenic risks are not indicated for offsite residents under the current soil scenario (excess cancer risk less than  $1 \times 10^{-6}$ ). However, carcinogenic risks to onsite workers (under the current and future soil scenarios) and offsite residents (under future soil scenarios) exceed an excess cancer risk of  $1 \times 10^{-6}$ . The risks do not, however, exceed an excess cancer risk of  $1 \times 10^{-4}$ .

The groundwater at Bethpage, if used as a potable water source, would be expected to result in significant carcinogenic risks (excess cancer risk greater than  $1 \times 10^{-4}$ ) and noncarcinogenic



risks (hazard index greater 1.0) to residents and employees under the current and future groundwater scenarios. The one exception to this is that the hazard index to employees under the future groundwater exposure would be about 0.5.

## **Site 2: Recharge Basin Area**

### History

Surface water drainage on Long Island is, for the most part, locally controlled, with numerous recharge basins used to channel this resource back to the groundwater. Several such recharge basins are located at NWIRP Bethpage.

Prior to 1984, some Plant 03 production-line rinse waters were discharged to the recharge basins. The Environmental/Energy Survey of the activity, published in 1976, states that 1.85 million gallons per week were discharged to the recharge basins. These waters were directly exposed to chemicals used in industrial processes (involving the rinsing of manufactured parts). Reportedly, these discharges of dilute rinse waters did not contain chromates, based on the Initial Assessment Study (IAS).

Since about 1977, the discharge rate has been 14 million gallons per week of noncontact cooling water. All discharge currently goes to the Industrial Wastewater Treatment Plant.

Also, adjacent to the recharge basins are the former sludge drying beds. Sludge from the Plant 02 Industrial Waste Treatment Facility was dewatered in the drying beds before offsite disposal.

On at least one occasion, sampling performed by the Nassau County Department of Health detected levels of hexavalent chromium in excess of allowable limits. Grumman was notified of this noncompliance and asked to perform remedial actions necessary to eliminate the problem. Reportedly, Grumman complied with the request.

Contaminants of concern include hexavalent (and other valence) chromium, aluminum, nitric acid, and sulfuric acid.

### Field Activities

The field investigation consisted of collecting 48 soil-gas samples at 24 locations, 13 surface soil samples, 14 subsurface soil samples at 13 locations, 11 temporary monitoring well samples, 2 surface water samples, and 4 sediment samples; installing 3 permanent monitoring wells at 2 locations; and sampling 3 permanent monitoring wells.

All of the samples were analyzed for volatile organics constituents. The surface soil samples, shallow subsurface soil

samples (less than 5 feet deep), surface water, sediment, and groundwater samples were analyzed for inorganic and semivolatile organic constituents. The groundwater and surface water samples were also analyzed for soluble inorganic constituents (less than 0.45 microns) and hexavalent chromium. In addition, surface and subsurface soils that were observed to be oil stained were analyzed for PCBs and pesticides. Select soil and groundwater samples were analyzed for engineering-type parameters.

#### Nature and Extent of Contamination

VOC contamination, especially by chlorinated ethanes and chlorinated ethenes, is present in soil, surface water, and groundwater. However, the concentrations detected at Site 2 are significantly lower than detected at Sites 1 and 3. Also, the upgradient monitoring wells at Site 2 were also observed to contain similar volatile organics. VOC contamination was also greater in subsurface than in surface soil. PCBs were reported at various locations in soil. Recharge basin surface water and sediment exhibited trace to low levels of VOCs.

Notable levels of certain inorganics, including chromium, arsenic, and cyanide, were detected in onsite media. Subsurface soil in Site 2 exhibited the highest levels of inorganics of the three sites. There is no clear pattern in the concentrations of inorganics in groundwater; notable levels of metals, including arsenic, vanadium, chromium, lead and cyanide, were reported in some wells.

#### Baseline Risk Assessment

To assess the risks to human health from the site contaminants, exposure scenarios were developed. For contaminated soil, the scenarios include direct contact with contaminants in surface soils through dermal contact, ingestion, and inhalation (current soil exposure); potential direct contact with subsurface soils following excavation of such soils; (future soil exposure); and indirect exposure through soil contaminants leaching to groundwater, and the contaminated groundwater being consumed (future groundwater exposure). The receptors include onsite adult workers and offsite adult and child residents. For the contaminated groundwater, the scenarios include residential and employee consumption of the contaminated groundwater (current groundwater exposure).

Hazard Indices calculated for current and future soil exposure are all below 1.0; adverse noncarcinogenic health effects for these pathways are not indicated. Total cancer risks for current soil exposure range from  $5E-8$  to  $2E-6$ , with the highest risk occurring for the adult employee dermal exposure scenario. Aroclor 1248 in Site 2 was the major factors in these potential dermal cancer risks. Estimated total cancer risks for future soil exposure ranged from  $5E-8$  to  $3E-6$ , with the highest risks occurring for the

employee dermal absorption at Site 2. Aroclor 1248 at Site 2 was primarily responsible for these projected cancer risks.

For potential exposure to current groundwater concentrations, Hazard Indices exceeded 1.0 for all three potential receptors (employee, adult resident, child resident). Individual Hazard Quotients for several chemicals exceeded 1.0, including both metals and VOCs. Estimated total cancer risks ranged from  $8E-4$  to  $3E-3$ , with TCE risks comprising a large portion of the total risk.

For potential exposure to future groundwater concentrations, Hazard Indices exceeded 1.0 for the resident ingestion/dermal pathways. This was due primarily to PCE, for which the Hazard Quotient exceeded 1.0. Estimated total cancer risks ranged from  $6E-6$  to  $6E-4$ , with TCE, PCE, and Aroclor 1248 posing the greatest risks.

Based on current risk assessment modeling, it has been determined that groundwater concentrations of VOCs and inorganics are the most significant sources of noncarcinogenic and carcinogenic risk at the Bethpage site. In addition, many groundwater constituents exceeded Federal and state drinking water standards. PCBs in surface and subsurface soil at Bethpage may pose the greatest cancer risk, especially because of their high CSF.

#### Conclusions

Based on volatile organic isoconcentration contour maps, Site 2 is not a likely source of onsite groundwater contamination.

Minimal volatile organic contamination of the soils or groundwater is present at Site 2. The surface water entering the recharge basins contains sufficient concentrations of volatile organics to result in groundwater contamination. However, the concentrations are not high enough to account for the volatile organic concentrations detected at Site 1. Based on the relative concentration of volatile organics found in the production wells, it is likely that the recharge basins are just redistributing the contaminated groundwater. Also, it should be noted that since the concentration of volatile organics in the surface water is lower than in the production wells, the systems likely to result in partial treatment of the groundwater by volatilization.

The contaminants in the soils at the NWIRP (under the current or in future scenarios) do not represent a significant, direct, non-carcinogenic risk to onsite workers or offsite residents (hazard index is less than 1.0). Likewise, incremental carcinogenic risks are not indicated for offsite residences under the current soil scenario (excess cancer risk less than  $1 \times 10^{-6}$ ). However, carcinogenic risks to onsite workers (under the current and future soil scenarios) and offsite residents (under future soil scenarios) exceed an excess cancer risk of  $1 \times 10^{-6}$ . The risks do not, however, exceed an excess cancer risk of  $1 \times 10^{-4}$ .

The groundwater at Bethpage, if used as a potable water source, would be expected to result in significant carcinogenic risks (excess cancer risk greater than  $1 \times 10^{-4}$ ) and noncarcinogenic risks (hazard index greater 1.0) to residents and employees under the current and future groundwater scenarios. The one exception to this is that the hazard index to employees under the future groundwater exposure would be about 0.5.

### Site 3: Salvage Storage Area

#### History

The NWIRP Bethpage Salvage Storage Area is located north of the Plant 03. Fixtures, tools, and metallic wastes were stored here from the early 1950s through 1969, prior to recycling.

Stored materials included aluminum and titanium scraps and shavings. While in storage, cutting oils dripped from some of this metal. In 1985, IAS team members observed oil-stained ground at the site. However, soil tests performed by Grumman in 1984 revealed that oil stains were superficial; oil residues were not detected below the top several inches of soil material in the Salvage Storage Area at the locations tested.

About 1960, the Salvage Storage Area was reduced in size to accommodate parking. About 1970, it was reduced again for the same reason. Consequently, storage facility locations at this site have been periodically moved to accommodate changes in storage area size.

In addition to salvage storage, a 100- by 100-foot area within the boundary of the Salvage Storage Area was used for the marshaling of drummed waste. This area was covered with coal ash cinders. Drum marshaling continued here from the early 1950s to 1969. Wastes marshaled throughout the area included waste oils as well as waste halogenated and nonhalogenated solvents. The exact location of this former drum marshaling area is uncertain, however, it is suspected to be near the current drum marshaling area.

Potential contaminants of concern at Site 3 (from both drum marshaling and salvage storage) include cutting oils, aluminum, titanium, and halogenated and nonhalogenated solvents.

#### Field Activities

The field investigation consisted of collecting 60 soil-gas samples at 30 locations, 8 surface soil samples, 14 subsurface soil samples at 9 locations, and 9 temporary monitoring well samples; installing 5 permanent monitoring wells at 2 locations; and sampling 5 permanent monitoring wells and four production wells.

All of the samples were analyzed for volatile organic constituents. The surface soil samples, shallow subsurface soil samples (less than 5 feet deep), surface water, sediment, and groundwater samples were analyzed for inorganic and semivolatile organic constituents. The groundwater and production well samples were also analyzed for soluble inorganic constituents (less 0.45 microns) and hexavalent chromium. In addition, surface and subsurface soils that were observed to be oil stained were analyzed for PCBs and pesticides. Select soil and groundwater samples were analyzed for engineering-type parameters.

#### Nature and Extent of Contamination

VOC contamination, especially by chlorinated ethanes and chlorinated ethenes, is evident in soil and groundwater. One well, HN24I, located southwest of Site 3, exhibited a significant concentration of TCE. VOCs were detected in groundwater at greater concentrations south of Site 3 than north. However, these contaminant concentrations were less than those at Site 1. With the exception of HN24I, VOC contamination was greater in shallow wells than intermediate. VOC contamination was also greater in subsurface than in surface soil. PCBs were reported at various locations in soil.

Notable levels of certain inorganics, including lead, arsenic, and cyanide, were detected in onsite media. Surface soil in Site 3 exhibited the highest levels of inorganics for the three sites. There is no clear pattern in the concentrations of inorganics in groundwater; notable levels of metals, including arsenic, vanadium, chromium, lead and cyanide, were reported in some wells.

#### Baseline Risk Assessment

To assess the risks to human health from the site contaminants, exposure scenarios were developed. For contaminated soil, the scenarios include direct contact with contaminants in surface soils through dermal contact, ingestion, and inhalation (current soil exposure); potential direct contact with subsurface soils following excavation of such soils; (future soil exposure); and indirect exposure through soil contaminants leaching to groundwater, and the contaminated groundwater being consumed (future groundwater exposure). The receptors include onsite adult workers and offsite adult and child residents. For the contaminated groundwater, the scenarios include residential and employee consumption of the contaminated groundwater (current groundwater exposure).

Hazard Indices calculated for current and future soil exposure are all below 1.0; adverse noncarcinogenic health effects for these pathways are not indicated. Total cancer risks for current soil exposure range from 6E-8 to 2E-6, with the highest risk occurring for the adult employee dermal exposure scenario. Benzo[a]pyrene in Site 3 was the major factors in these potential dermal cancer

risks.

For potential exposure to current groundwater concentrations, Hazard Indices exceeded 1.0 for all three potential receptors (employee, adult resident, child resident). Individual Hazard Quotients for several chemicals exceeded 1.0, including both metals and VOCs. Estimated total cancer risks ranged from 8E-4 to 3E-3, with TCE risks comprising a large portion of the total risk.

For potential exposure to future groundwater concentrations, Hazard Indices exceeded 1.0 for the resident ingestion/dermal pathways. This was due primarily to PCE, for which the Hazard Quotient exceeded 1.0. Estimated total cancer risks ranged from 6E-6 to 6E-4, with TCE, PCE, and Aroclor 1248 posing the greatest risks.

Based on current risk assessment modeling, it has been determined that groundwater concentrations of VOCs and inorganics are the most significant sources of noncarcinogenic and carcinogenic risk at the Bethpage site. In addition, many groundwater constituents exceeded Federal and state drinking water standards. PCBs in surface and subsurface soil at Bethpage may pose the greatest cancer risk, especially because of their high CSF.

#### Conclusions

Based on volatile organic isoconcentration contour maps, Site 3 is a likely source of onsite groundwater contamination. It is anticipated that the work associated with Site 1-related groundwater will define the extent of this contamination.

Only low concentrations of volatile organics were detected in the soils at Site 3. Therefore, the source area of the volatile organic plume either is no longer present or was not found during the RI.

Based on the relative concentration of volatile organics found in the production wells, the recharge basins are likely to be redistributing the contaminated groundwater. Also, it should be noted that since the concentration of volatile organics in the surface water is lower than in the production wells, the system is likely to result in partial treatment of the groundwater by volatilization.

The contaminants in the soils at the NWIRP (under the current or in future scenarios) do not represent a significant, direct, non-carcinogenic risk to onsite workers or offsite residents (hazard index is less than 1.0). Likewise, incremental carcinogenic risks are not indicated for offsite residences under the current soil scenario (excess cancer risk less than  $1 \times 10^{-6}$ ). However, carcinogenic risks to onsite workers (under the current and future soil scenarios) and offsite residents (under future soil scenarios) exceed an excess cancer risk of  $1 \times 10^{-6}$ . The risks do not,

however, exceed an excess cancer risk of  $1 \times 10^{-4}$ .

The groundwater at Bethpage, if used as a potable water source, would be expected to result in significant carcinogenic risks (excess cancer risk greater than  $1 \times 10^{-4}$ ) and noncarcinogenic risks (hazard index greater 1.0) to residents and employees under the current and future groundwater scenarios. The one exception to this is that the hazard index to employees under the future groundwater exposure would be about 0.5.





## **1.0 INTRODUCTION**

### **1.1 Purpose of Report**

The work to be performed under Contract N62472-90-D-1298, Contract Task Order (CTO) 0003, is to conduct a Remedial Investigation (RI) at the Naval Weapons Industrial Reserve Plant (NWIRP), Bethpage, New York.

This work is part of the Navy's Installation Restoration Program, which is designed to identify contamination of Navy and Marine Corps lands/facilities resulting from past operations and to institute corrective measures, as needed. There are typically four distinct phases. Phase 1 is the Preliminary Assessment (formerly known as the Initial Assessment Study). Phase 2 is a Site Investigation, which augments the information collected in the Preliminary Assessment. Phase 3 is the Remedial Investigation/Feasibility Study (RI/FS), which characterizes the contamination at a facility and develops options for remediating the site. Phase 4 is the Remedial Action, which results in the control or cleanup of contamination at sites. This report was prepared under Phase 3 (RI/FS).

### **1.2 Scope and Objectives**

The overall objective of this RI is to characterize the nature and extent of potential environmental contamination and associated risks to human health and the environment at the NWIRP. The data collected will also be used to evaluate potential remedial options. The specific objectives for the Bethpage activity are to identify the location and concentration of potential soil and groundwater contamination by solvents and metals at three sites identified in the Initial Assessment Study (IAS) (RGH 1986) and to determine whether these sites are the source or one of the sources of an organic compound contaminated groundwater plume in the Bethpage area. Similar investigations are currently under way at the Grumman Bethpage and RUCO Polymer Corporation (RUCO) facilities. Other potential sources of this contamination may exist.

### **1.3 Activity Background Information**

#### **1.3.1 Activity Location and Description**

The NWIRP is situated on 108 acres in Nassau County in the Hamlet of Bethpage, Town of Oyster Bay, New York (see Figure 1-1). The NWIRP lies entirely within the Grumman Aerospace complex, which covers approximately 605 acres (see Figure 1-2). The NWIRP is bordered on the north, west, and south by Grumman facilities, and on the east by a residential neighborhood.

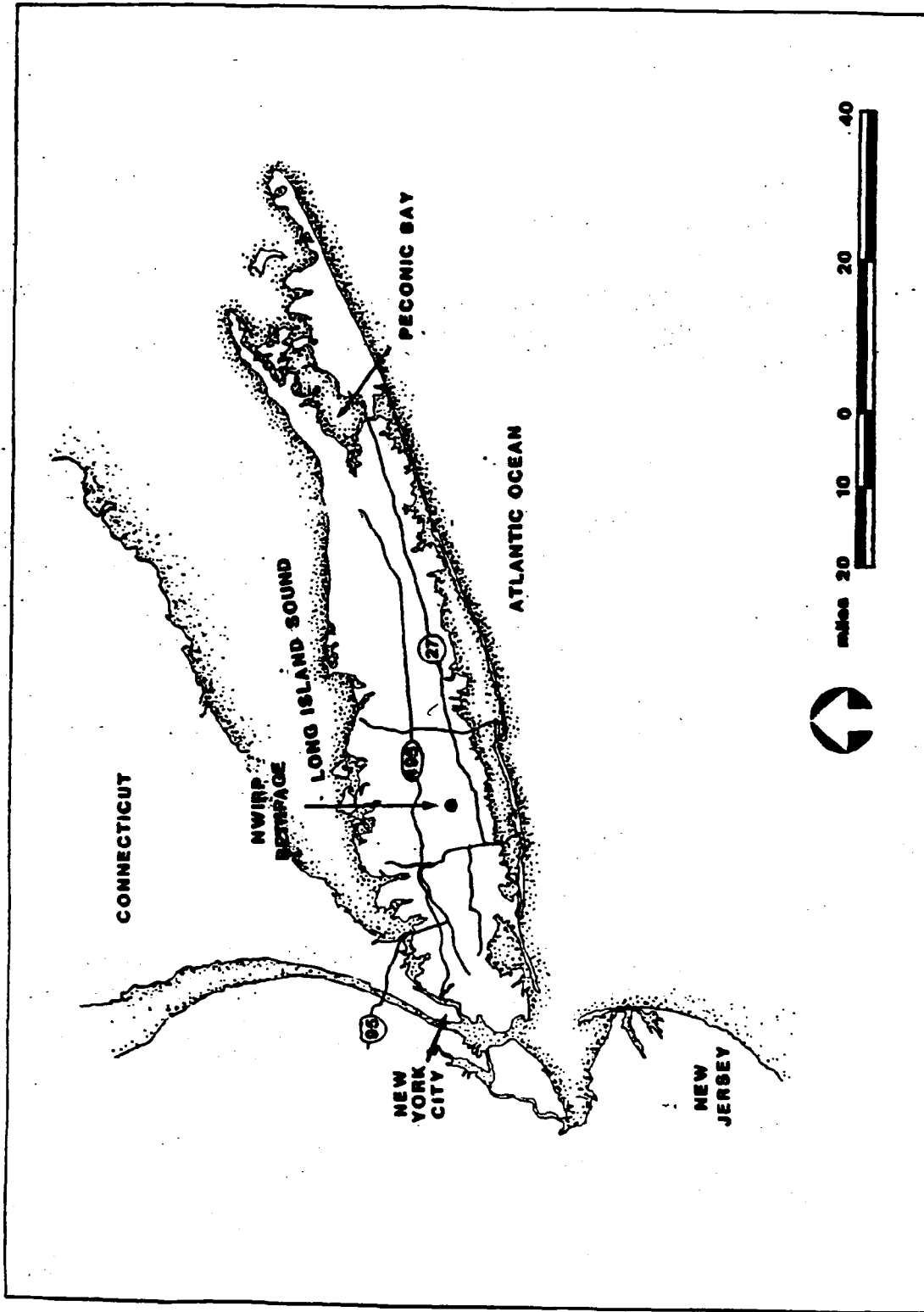

  
**Naval Weapons Industrial  
 Reserve Plant  
 Bethpage  
 Long Island, New York**

**Figure 1-1  
 General Location Map,  
 MWIRP Bethpage, New York**

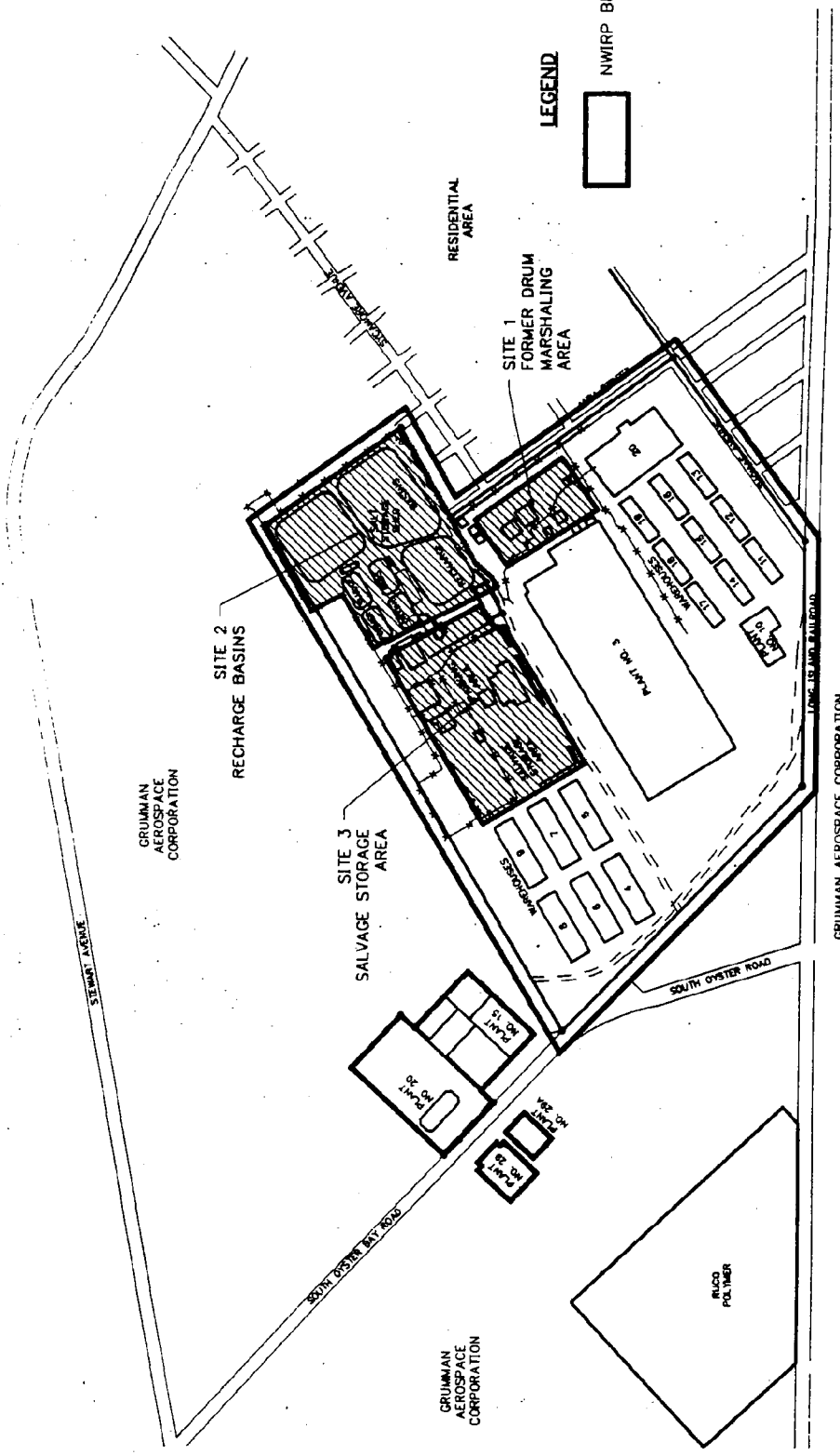

**LEGEND**



**FIGURE 1-2**



**ACTIVITY LAYOUT  
REMEDIAL INVESTIGATION  
NWIRP..BETHPAGE..NY**



The climate at NWIRP is described as a fairly humid, modified continental climate. The nearby Atlantic Ocean and Long Island Sound tend to reduce the temperature range commonly encountered further inland. The highest monthly mean temperature occurs in July (74.9 degrees); the lowest occurs in January (31.4 degrees). The mean annual precipitation is 45 inches, and the mean annual evapotranspiration is about 22 inches (RGH, 1986).

### 1.3.2 Activity History

The histories of the NWIRP and Grumman Aerospace facilities are discussed in detail in the Initial Assessment Study of the NWIRP and the RI/FS Work Plan for the Grumman facility prepared by Geraghty and Miller (G&M, 1990). The following synopsis is from those discussions.

The NWIRP was established in 1933. Since its inception, the plant's primary mission has been the research prototyping, testing, design engineering, fabrication, and primary assembly of military aircraft.

The facilities at NWIRP (see Figure 1-3) include four plants (Nos. 3, 5, and 20, used for assembly and prototype testing; and No. 10, a group of quality control laboratories), two warehouse complexes (north and south), a salvage storage area, water recharge basins, the Industrial Wastewater Treatment Plant (to process chemical effluents from the activity's manufacturing operations), and several smaller support buildings.

An Initial Assessment Study (IAS) of NWIRP Bethpage, New York, and NWIRP Calverton, New York, conducted in 1986 (RGH, 1986) indicated that three areas at the Bethpage Plant may pose a threat to human health or the environment. These three sites are Site 1 - Former Drum Marshaling Area (identified as Site 7 in the IAS), Site 2 - Recharge Basin Area (identified as Site 8 in the IAS), and Site 3 - Salvage Storage Area (identified as Site 9 in the IAS). (These sites were renumbered to avoid confusion with the site designations at the Calverton Plant.) Figure 1-3 presents the location and general layout of the three sites at Bethpage.

Based on the historic data presented in the IAS, there is the potential for volatile organic, semivolatile organic, and inorganic contamination at each of the three sites. Also, although there are no historical records, there is the potential that transformers (containing possibly PCBs) may have been stored at the sites based on transformers observed by HALLIBURTON NUS during a site visit. It is unknown whether or not the transformers were properly drained prior to storage.

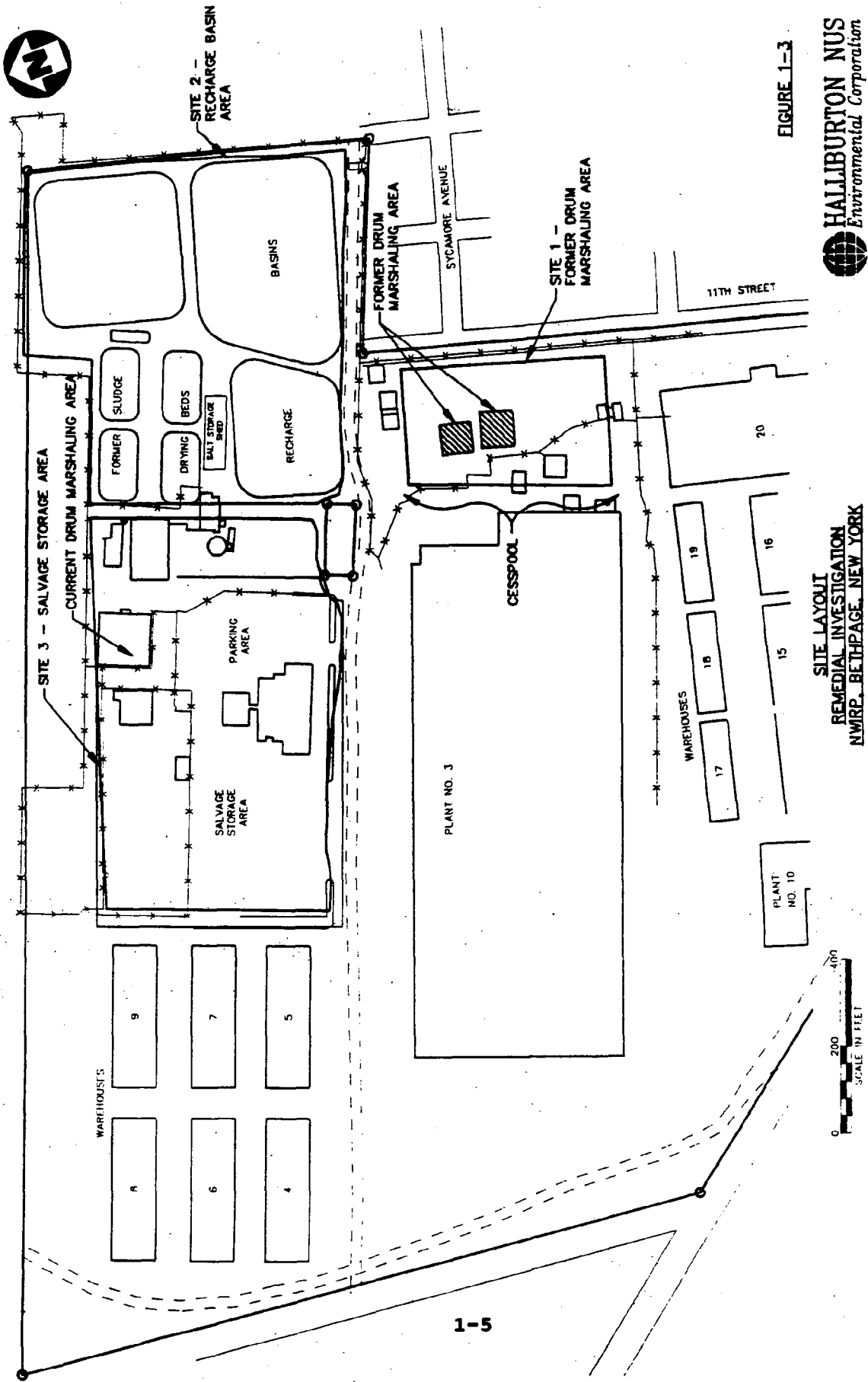

FIGURE 1-3

**HALLIBURTON NUS**  
Environmental Corporation

**SITE LAYOUT  
REMEDIAL INVESTIGATION  
NWIRP, BETHPAGE, NEW YORK**

1-5

### 1.3.3 Site Description

#### 1.3.3.1 Site 1: Former Drum Marshaling Area

Starting in 1969, hazardous waste management practices for Grumman facilities on Long Island included marshaling of drummed wastes on the Navy property at NWIRP Bethpage. Such storage first took place on a cinder-covered surface over the cesspool field east of Plant 03 (See Figure 1-3). From the early 1950s through about 1978, drums containing liquid cadmium waste were stored here. In 1978, the collection and marshaling point was moved a few yards south of the original unpaved site, to an area on a 100- by 100-foot concrete pad. This pad had no cover, nor did it have berms for containment of spills. In 1982, drummed waste storage was transferred to the present Drum Marshaling facility, located in the Salvage Storage Area (Site 3); a cover was added in 1983.

Reportedly, all drums of waste marshaled at the Former Drum Marshaling Areas were taken off-activity by a private contractor for treatment or disposal. There are no reports of leaks or spills of drum contents.

Materials stored at the Former Drum Marshaling Areas included waste halogenated and nonhalogenated solvents. Cadmium and cyanide were also stored in this area from the early 1950s through 1974. Reportedly, 200 to 300 drums were stored at each area at any one time.

#### 1.3.3.2 Site 2: Recharge Basin Area

Surface water drainage on Long Island is, for the most part, locally controlled, with numerous recharge basins used to channel this resource back to the groundwater. Several such recharge basins are located at NWIRP Bethpage (See Figure 1-3).

Prior to 1984, some Plant 03 production-line rinse waters were discharged to the recharge basins. The Environmental/Energy Survey of the activity, published in 1976, states that 1.85 million gallons per week were discharged to the recharge basins. These waters were directly exposed to chemicals used in industrial processes (involving the rinsing of manufactured parts). Reportedly, these discharges of dilute rinse waters did not contain chromates. Halogenated and nonhalogenated solvents may have been present in the rinse waters discharge to the recharge basins.

Since about 1977, the discharge rate has been 14 million gallons per week of noncontact cooling water. All discharge currently goes to the Industrial Wastewater Treatment Plant.

Also, adjacent to the recharge basins are the former sludge drying beds. Sludge from the Plant 02 Industrial Waste Treatment Facility was dewatered in the drying beds before offsite disposal.

On at least one occasion, sampling performed by the Nassau County Department of Health detected levels of hexavalent chromium in excess of allowable limits (RGH, 1986). Grumman was notified of this noncompliance and asked to perform remedial actions necessary to eliminate the problem. Reportedly, Grumman complied with the request.

Contaminants of concern include hexavalent (and other valence) chromium, aluminum, nitric acid, and sulfuric acid.

### 1.3.3.3 Site 3: Salvage Storage Area

The NWIRP Bethpage Salvage Storage Area is located north of the Plant 03 (see Figure 1-3). Fixtures, tools, and metallic wastes were stored here from the early 1950s through 1969, prior to recycling.

Stored materials included aluminum and titanium scraps and shavings. While in storage, cutting oils dripped from some of this metal. In 1985, IAS team members observed oil-stained ground at the site. However, soil tests performed by Grumman in 1984 revealed that oil stains were superficial; oil residues were not detected below the top several inches of soil material in the Salvage Storage Area at the locations tested (RGH, 1986).

About 1960, the Salvage Storage Area was reduced in size to accommodate parking. About 1970, it was reduced again for the same reason. Consequently, storage facility locations at this site have been periodically moved to accommodate changes in storage area size.

In addition to salvage storage, a 100- by 100-foot area within the boundary of the Salvage Storage Area was used for the marshaling of drummed waste. This area was covered with coal ash cinders. Drum marshaling continued here from the early 1950s to 1969. Wastes marshaled throughout the area included waste oils as well as waste halogenated and nonhalogenated solvents. The exact location of this former drum marshaling area is uncertain, however, it is suspected to be near the current drum marshaling area.

Potential contaminants of concern at Site 3 (from both drum marshaling and salvage storage) include cutting oils, aluminum, titanium, and halogenated and nonhalogenated solvents.

**1.4 Summary of Grumman RI/FS Activities**

**1.4.1 Previous Grumman Investigations**

The two media which are potentially contaminated at the NWIRP Bethpage are soil and groundwater. No data are available on the potential soil contamination. However, there is a significant amount of data available on regional groundwater contamination (G&M, 1990). The Grumman Work Plan presents results of volatile organic testing of groundwater from monitoring wells within a 3-mile radius of the activity. The sample dates varied from 1982 to 1989. The location of the wells, a description of the wells, and the detailed analytical data are presented in Appendix A. The five volatile organics detected in the groundwater at the highest concentrations and greater frequency are as follows:

**MAXIMUM VOLATILE ORGANIC CONCENTRATIONS  
IN GROUNDWATER**

<b>Parameter</b>	<b>Concentration (ug/l)</b>	<b>Location</b>
Trichloroethene	1,600	Well 7635
Tetrachloroethene	2,400	Well 10595
1,1,1-Trichloroethane	650	Well 10595
1,1-Dichloroethane	160	Well 10595
1,2-Dichloroethane	340	Well 10629

Wells 10595 and 10629 are located about 800 feet south of Site 1; Well 7635 is located about 1300 feet southwest of Site 3 (See Figure 1-4). Analytical data on wells located on or near the Navy property are summarized as follows:



**GROUNDWATER ANALYTICAL DATA  
FOR WELLS ON THE NWIRP  
MAXIMUM CONCENTRATIONS (ug/l)**

Parameter	Well 10623 (USGS Well)	Well 7637	Well 7636	Well 10625	Well 8816	Well 7535	Well 8643	Well 10594
Screened Interval (ft)	68- 72	-	-	-	-	-	-	73-76
Trichloroethene	580	14	54	120	35	150	37	440
Tetrachloroethene	550	6	5	25	6	160	120	ND
1,1,1- Trichloroethane	260	2	9	31	4	130	1	4
Vinyl Chloride	21	1	3	1	4	4	3	1
1,1-Dichloroethane	26	ND	ND	2	ND	ND	ND	ND
1,1-Dichloroethene	38	ND	ND	ND	ND	-	-	ND
1,2-Dichloroethene	130	ND	ND	ND	ND	-	-	ND

ND: None detected

:- Indicates that data are not available

There are currently analytical data on only one additional groundwater well located within 1000 feet north of the Navy property. (Well 8454 is believed to be hydraulically upgradient of the NWIRP.) This well was found to have low (less than 10 ug/l) or nondetectable concentrations of volatile organics.

Only minimal data were available on potential metal and semivolatile organic contamination in the groundwater. In 1956, the recharge basin water for Plant No. 3 was measured to contain 0.24 parts per million (ppm) of hexavalent chromium and 0.04 ppm of cadmium.

#### 1.4.2 Grumman RI/FS Activities

The RI/FS currently underway at the Grumman Bethpage facility is consistent with USEPA guidance documents, NYDEC policies, the NCP, and is being overseen by the NYDEC. The purpose of the Grumman RI/FS was to execute a series of tasks that would lead to the identification and definition of potential contamination attributable to the Grumman facility and provide sufficient data for the conceptual design of a remedial action alternative (if needed) for the site. The Grumman RI/FS is being conducted in a phased approach. Phase 1 (the initial field investigation) was intended to define the nature and extent of potential onsite contamination attributable to the Grumman facility. Applicable results of the Phase 1 study have been included in this report. A work plan for the Phase 2 Remedial Investigation, which will address on-site and off-site areas, was recently submitted to the NYDEC.

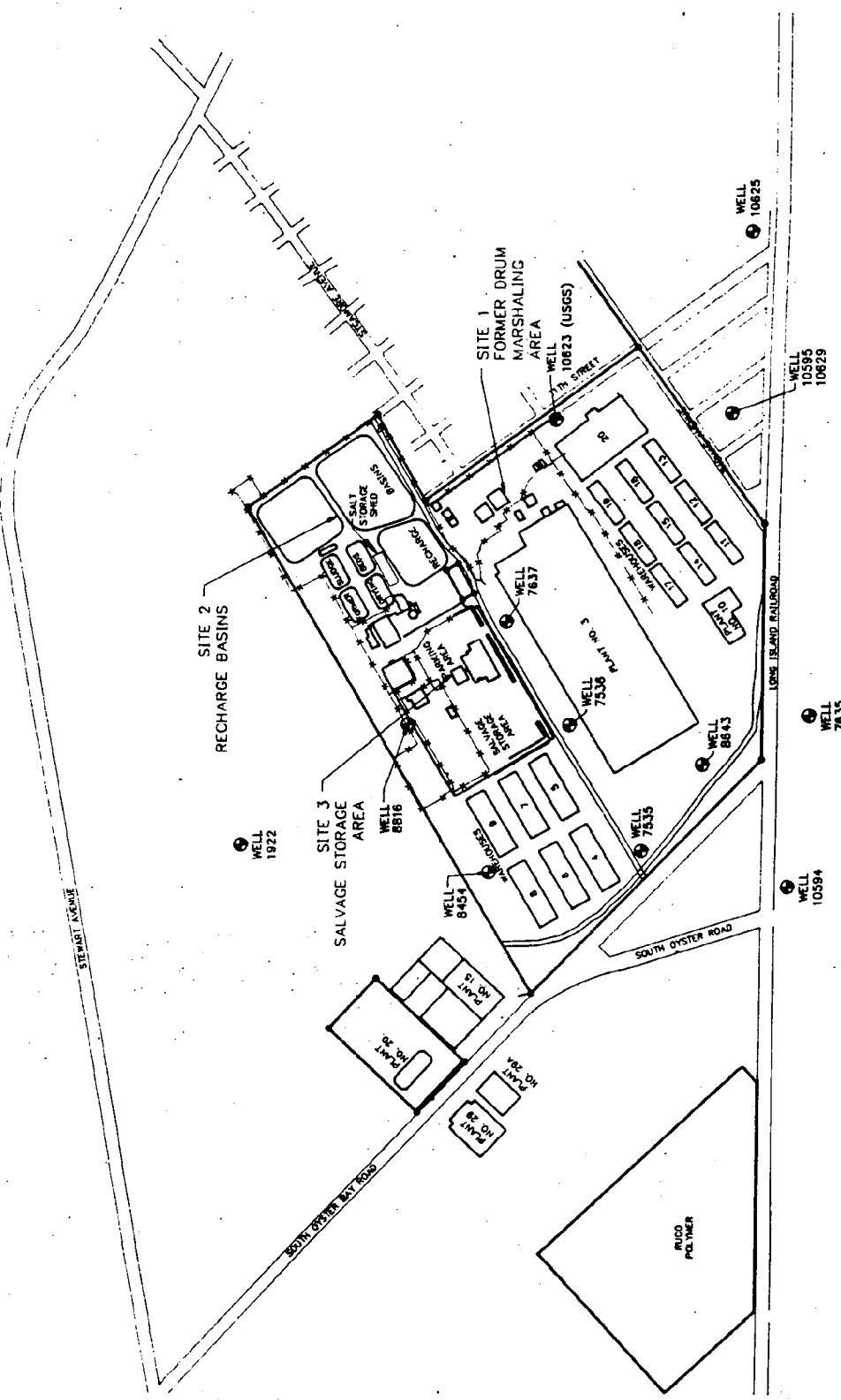
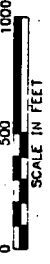

FIGURE 1-4



LOCATION OF EXISTING REGIONAL GROUNDWATER WELLS  
 REMEDIAL INVESTIGATION  
 NWRP, BETHPAGE, NY



Phase 1 included a limited soil-gas survey, collection and analysis of water and bottom-sediment samples from four of the seven south recharge basins, installation and/or sampling of several shallow soil borings (3 locations) and monitoring well clusters (new and existing - 23 locations), and measurement of onsite water levels (23 locations). Phase 2 will include drilling, installing, and sampling of additional on- and/or offsite borings and monitoring wells. The location of these sampling activities is presented in Appendix A.

Three of the Grumman well clusters are located north of Site 2 and Site 3, (GM-6, GM-7, and GM-8). These well clusters were used for upgradient wells for the NWIRP.

### **1.5 Report Organization**

This report consists of seven sections. Section 1.0 is this introduction. Section 2.0 presents a description of the field activities. Section 3.0 provides the site geology and hydrogeology. Section 4.0 presents a description of the nature and extent of contamination. Section 5.0 describes the contaminant fate and transport data. Section 6.0 provides a baseline risk assessment. Section 7.0 provides the summary of the findings and conclusions.



## 2.0 FIELD PROGRAM DESCRIPTIONS AND RATIONALE

This section presents the basis for the RI scoping and a description of each of the field investigation tasks performed at the NWIRP Bethpage to meet the objectives of the RI.

Between August 19, 1991, and January 29, 1992, the following field activities were conducted:

- Soil-gas survey and analysis of samples at 73 locations (Section 2.2).
- Drilling and installation of 29 temporary wells and sampling and analysis of the groundwater (Section 2.3).
- Sampling and analysis of 48 subsurface soil samples at 29 locations and 29 surface soil locations (Section 2.4).
- Drilling and installation of 17 monitoring wells (Section 2.5).
- Groundwater sampling and analysis from selected existing monitoring and production wells and newly installed monitoring wells (Section 2.6).
- Surface water and sediment sampling and analysis from existing recharge basins (Section 2.7).
- Water-level measurements of groundwater obtained from monitoring wells (Section 2.8).
- Surveying the locations and vertical elevations of all newly installed monitoring wells, a USGS well, and soil-gas points (Section 2.9).

### 2.1 Scoping of Remedial Investigation

This section presents the data limitations and requirements, and data quality objectives.

#### 2.1.1 Data Limitations and Requirements

The existing analytical data focused on volatile organic contamination in groundwater on a regional basis; there were no data available for soil contamination.

Additional data was required to identify the nature and extent of soil and groundwater contamination on the NWIRP and to assess risks to human health and the environment. To identify the nature and extent of contamination, analytical testing of surface and subsurface soils, recharge basin water and sediment, and groundwater was required. The history of the sites indicated that

there was the potential for these media to be contaminated with volatile organics, semivolatile organics, metals, and cyanide. Also, there was the potential for PCBs and pesticides to be present in the soils.

A preliminary assessment of risk to human health and the environment at the NWIRP Bethpage site revealed two potential exposure scenarios: (1) direct contact of contaminated media by activity personnel and (2) contaminant migration within the groundwater. The direct contact risks can occur as a result of accidental ingestion of contaminated soils or groundwater, and inhalation of dust or organics volatilized from groundwater. The contaminant migration occurs as a result of precipitation infiltration contacting contaminated soils and leaching contaminants into the groundwater, recharge basin water discharge to groundwater and interactions with potentially contaminated sediments, and groundwater migration.

Since there was minimal data available regarding the source and location of potential soil and groundwater contamination, a phased approach was planned to optimize soil and groundwater testing efforts. To accomplish this, three phases were used. These phases overlapped to minimize schedule delays. The first phase consists of site-wide soil-gas survey coupled with the use of a field gas chromatograph (GC) to initially identify potential areas of subsurface soil and/or groundwater contamination. The second phase constituted the collection of groundwater samples for field GC analysis and soil samples for fixed-base laboratory analysis. The field GC groundwater analysis results were used to select the location of the permanent groundwater monitoring wells. The soil samples were used to quantify soil contamination. The third phase consists of collecting groundwater samples for fixed-base laboratory analysis to quantify groundwater contamination. During the third phase, sampling and analysis of the Recharge Basins sediment and surface water, wastes at the former sludge drying beds (if present), and surface soils were conducted to characterize the potential contamination of these media. The basis for selecting the fixed-base analytical parameters for each media is presented in Table 2-1.

Additional data were required regarding groundwater flow patterns at the NWIRP and interaction of groundwater with the surrounding areas. To accomplish this, water-level measurements and pumping/slug tests are typically required. The water-level measurements are being conducted at the adjacent Grumman Plant and should be applicable to the NWIRP; however, additional measurements at the NWIRP was required. The pump tests will be conducted later if necessary.

TABLE 2-1

BASIS OF ANALYTICAL TESTING  
MWIRP, BETHPAGE, NEW YORK

Site	Sample Type	Number of Samples	Rationale
1	Soils	Five to ten borings located in the field based on the results of the soil-gas testing with one to two samples per boring. Samples were collected at depths where elevated soil-gas readings were detected. Sample depths were be at 5 feet and/or 21 feet. Surface samples were collected in a grid pattern with two additional samples selected, based on apparent visual contamination. Analysis: TCL VOA on all samples plus SVOA, TCL metals, and cyanide on samples collected at the surface and at a depth of 5 feet. TCL PCBs and pesticides were also conducted on visually stained soils. CLP procedures were used.	Site 1 was used to store halogenated and nonhalogenated solvents, cyanide, and cadmium wastes. Although there were no reported spills in the area, there are potential unreported spills and leaks in this area. Transformers (possibly PCB-filled) and pesticides may also have been stored at the area. It is unknown whether or not transformers were properly drained prior to storage. Residual soil contamination may remain at the site. Two of the samples were tested for the general engineering/ remediation parameters of TOC, bulk density, grain size, moisture content, and pH.
	Groundwater	Three well clusters located in the field based on soil-gas and temporary monitoring well testing with two to three wells per cluster and one sample per well. Well clusters were located along the hydraulic upgradient and downgradient borders of the site. Analysis: TCL VOA and SVOA, TCL metals, Cr <sup>6+</sup> , and cyanide using CLP procedures.	Site 1 was used to store halogenated and nonhalogenated solvents, cyanide, and cadmium wastes. Although there were no reported spills in the area, there are potential unreported spills and leaks in this area. Any potential spills may have migrated to the groundwater. One sample was analyzed for the general engineering/remediation parameters of TDS, alkalinity, hardness, BOD, TOC, and TSS.
2	Soils	Five to ten borings located in the field based on the results of the soil-gas testing with one to two samples per boring. Samples were collected at depths where elevated soil-gas readings were detected. Sample depths were at 5 feet and/or 21 feet. Surface samples were collected in a grid pattern with two additional samples selected, based on apparent visual contamination. Analysis: TCL VOA on all samples plus SVOA, TCL metals, and cyanide on samples collected at the surface and at a depth of 5 feet. TCL PCBs and pesticides were also conducted on visually stained soils. CLP procedures were used.	Site 2 was used to treat and discharge production wastewaters. Halogenated and nonhalogenated solvents, metals, and cyanide may have been present in the treatment plant waste waters and sludges. These sludges were dried on site prior to offsite disposal. Transformers (possibly PCB-filled) and pesticides may also have been stored at the area. It is unknown whether or not transformers were properly drained prior to storage. Residual soil contamination may remain at the site. Two of the samples were tested for the general engineering/ remediation parameters of TOC, bulk density, grain size, moisture content, and pH.

**TABLE 2-1  
BASIS OF ANALYTICAL TESTING  
NWIRP, BETHPAGE, NEW YORK  
PAGE TWO**

Site	Sample Type	Number of Samples	Rationale
2 (cont'd)	Groundwater	Two well clusters located in the field based on soil-gas and temporary monitoring well testing with one to two wells per cluster and one sample per well. Well clusters were located along the hydraulic upgradient and downgradient borders of the site. A Grumman well cluster was used as an additional upgradient data point, and a Site 1 well cluster were used as an additional down gradient data point. Analysis: TCL VOA and SVOA, TCL metals, Cr <sup>6+</sup> , and cyanide using CLP procedures.	Site 2 was used to treat and discharge production wastewaters. Halogenated and nonhalogenated solvents, metals, and cyanide may have been present in the treatment plant waste waters and sludges. These sludges were dried on site prior to off site disposal. Any releases of contaminants may have migrated to the groundwater. One sample was analyzed for the general engineering/remediation parameters of TDS, alkalinity, hardness, BOD, TOC, and TSS.
	Surface Water	Collect two surface water samples from the influent to the operating basin. One sample was collected during normal operations, and one sample was collected during a precipitation event. Analysis: TCL VOA and SVOA, TCL metals, Cr <sup>6+</sup> , and cyanide using CLP procedures.	Site 2 was used to treat and discharge production wastewaters. Halogenated and nonhalogenated solvents, metals, and cyanide may have been present in the treatment plant waste waters and sludges. These sludges were dried on site prior to offsite disposal. Currently it is reported that this water is noncontact; however, this classification needs to be confirmed. The precipitation event sample would be collected to determine whether contaminated runoff is entering the basins.
	Sediment	Sample each active recharge basins with two samples per basin. Only two of the three recharge basins were active during the RI. Analysis: TCL VOA and SVOA, TCL metals, and cyanide using CLP procedures.	Site 2 was used to treat and discharge production wastewaters. Halogenated and nonhalogenated solvents, metals, and cyanide may have been present in the treatment plant wastewaters and sludges. These sludges were dried on site prior to offsite disposal. These sediments may be contaminated from past practices or from periodic current contamination.
	Waste	If encountered during drilling activities, one sample of the waste was to be obtained from the former sludge-drying areas. No waste materials were encountered during the RI. Analysis: TCL VOA and SVOA, TCL metals, Cr <sup>6+</sup> , and cyanide using CLP procedures.	Site 2 was used to treat and discharge production wastewaters. Halogenated and nonhalogenated solvents, metals, and cyanide may have been present in the treatment plant wastewaters and sludges. These sludges were dried on site prior to offsite disposal. There is no evidence that the sludges remain at the site; however, if during the drilling program sludges are encountered, they will be sampled.



**TABLE 2-1  
BASIS OF ANALYTICAL TESTING  
NWIRP, BETHPAGE, NEW YORK  
PAGE THREE**

Site	Sample Type	Number of Samples	Rationale
3	Soils	Five to ten borings located in the field based on the results of the soil-gas testing with one to two samples per boring. Samples were collected at depths where elevated soils gas readings were detected. Sample depths were at 5 feet and/or 21 feet. Surface samples were collected in a grid pattern with two additional samples selected, based on apparent visual contamination. Analysis: TCL VOA on all samples plus SVOA, TCL metals, and cyanide on samples collected at the surface and at a depth of five feet. TCL PCBs and pesticides were also conducted on visually stained soils. CLP procedures were used.	Site 3 was used to store halogenated and nonhalogenated solvents, cyanide, and cadmium wastes. Although there were no reported spills in the area, there are potential unreported spills and leaks in this area. Site 3 was also used to store fixtures, tools, and metallic wastes. There are also reports of surface oil contamination. Transformers (possibly PCB-filled) and pesticides may also have been stored at the area. It is unknown whether or not transformers were properly drained prior to storage. Residual soil contamination may remain at the site. Two of the samples were tested for the general engineering/ remediation parameters of TOC, bulk density, grain size, moisture content, and pH.
	Groundwater	Three well clusters. One well cluster was located southwest of Plant 3. This well point was used to fill in a data gap for the overall Bethpage plant. The other two clusters were located downgradient of Site 3. Exact locations for the two well cluster at Site 3 were determined in the field based on soil-gas and temporary monitoring well testing with two wells per cluster and one sample per well. Two Grumman monitoring wells were used as upgradient wells. Analysis: TCL VOA and SVOA, TCL metals, Cr <sup>6+</sup> and cyanide using CLP procedures.	Site 3 was used to store halogenated and nonhalogenated solvents, cyanide, and cadmium wastes. Although there were no reported spills in the area, there are potential unreported spills and leaks in this area. Site 3 was also used to store fixtures, tools, and metallic wastes. There are also reports of surface oil contamination. These contaminants may have migrated into the groundwater. One sample was analyzed for the general engineering/remediation parameters of TDS, alkalinity, hardness, BOD, TOC, and TSS.
None	Groundwater	Collect one groundwater sample from each of four operating production wells and the USGS well located at the NWIRP in Bethpage. Analysis: TCL VOA and SVOA, TCL metals, Cr <sup>6+</sup> , and cyanide using CLP procedures.	These samples provided an indication of local groundwater quality at the NWIRP.

### **2.1.2 Data Quality Objectives**

The overall objective of the RI was to characterize the nature and extent of potential environmental contamination and associated risks to human health and the environment at the NWIRP. The data collected was also used to evaluate potential remedial options. The specific objectives for the Bethpage plant were to identify the location and concentration of potential solvent and metal contamination of soil and groundwater at three sites identified in the Initial Assessment Study (RGH 1986) and to determine whether these sites are the source of a trichloroethene (TCE) contaminated groundwater plume in the Bethpage area. The NWIRP, Grumman, and RUCO are potential sources of this contamination.

The uses of the data collected were to characterize the nature and extent of contamination, to assess the potential risks to human health and the environment, and, for engineering purposes, to develop remedial actions. The nature and extent of contamination included the areas and depths of contamination and contaminant concentrations. The risk assessment addressed the contaminants, receptors, and pathways for exposure. The engineering parameters were selected based on potential remedial actions including groundwater pump-and-treat options and soil treatment/offsite disposal options.

The NWIRP, Bethpage, is not currently on the CERCLA National Priorities List (NPL). However, it is possible that the site may be placed on the National Priorities List (NPL) list and that legal actions may be taken in the future. In accordance with Naval Energy and Environmental Support Activity (NEESA), for sites which are on or about to be placed on the NPL, Data Quality Objective (DQO) Level D quality control and CLP methods and protocol are to be used. These sites are typically near populated areas and are likely to undergo litigation.

DQO Level D QC includes review and approval of the laboratory QA plan, the site work plan, and the field QA plan. The laboratory must successfully analyze a performance sample, undergo an audit, correct deficiencies found during the audit, and provide monthly progress reports on QA. The laboratory that performs Level D QC must have passed the performance sample furnished through the Superfund Contract Laboratory Protocol (CLP) and must be able to generate the CLP deliverables.

### **2.2 Soil-Gas Survey**

The soil-gas survey was performed to identify potential soil and groundwater contamination. The survey consisted of a uniform grid of soil-gas samples in each of the three sites (See Figure 2-1). A grid spacing of 150-foot centers was used. In addition, opportunity locations were selected in the field, based on results

F. PU 1/8 STUWALMG PS-BH1 05/18/02 MAJ 2-11AT

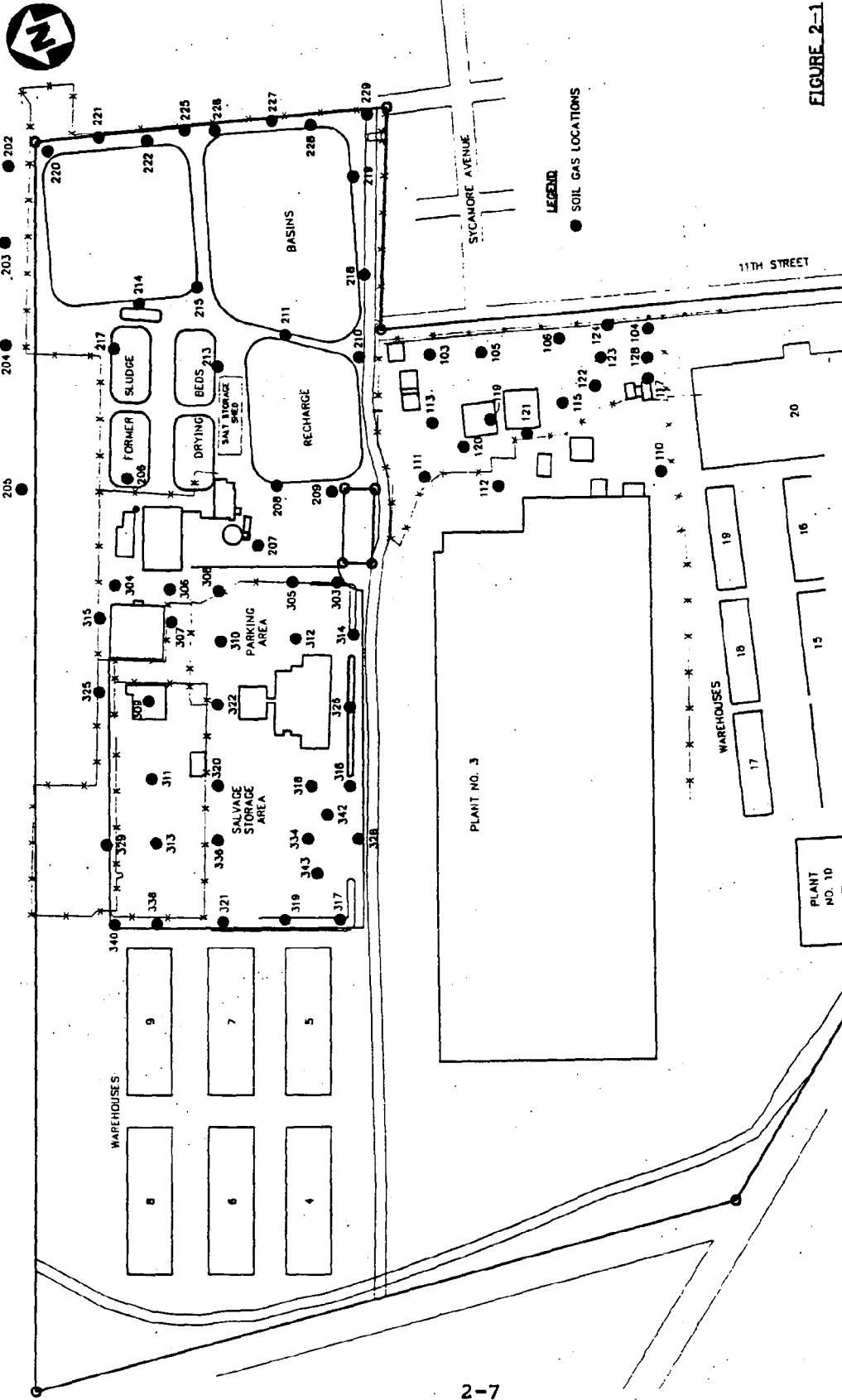

FIGURE 2-1

SOIL-GAS LOCATIONS  
REMEDIAL INVESTIGATION  
NWTRP, BETHPAGE, NEW YORK



from grid pattern soil-gas locations, as well as areas of suspected contamination. At each location, soil-gas samples were obtained at two depths: 5 feet and 21 feet. The 5-foot depth represents potential contamination in the soil near the source of a spill. Elevated soil-gas measurements at this depth would likely be an indication of surface soil contamination. The 21-foot depth represents the practical depth of this technique, and the result would likely be influenced by both soil and groundwater contamination. The samples were analyzed in the field using a portable gas chromatograph equipped with an electron capture detector (GC/ECD).

The subcontractor used their own fixed-base laboratory for duplicate testing of samples in accordance with their QA Plan. Also, at one point, the capacity of the onsite laboratory was exceeded. Excess samples were shipped to the subcontractor's fixed-base laboratory to meet holding time requirements.

Based on this testing, temporary well point sample locations and soil sample locations and depths were selected. If minimal or no elevated soil-gas readings were found for any particular site, then temporary well sample points were located primarily along the upgradient and downgradient boundaries of that site. If elevated soil-gas readings were found, then 2 to 3 temporary well points were located along the hydraulic downgradient boundary of the site; 2 to 3 temporary well points were located along the hydraulic upgradient border of the site; and 3 to 4 temporary well points were located in the center of the contamination of the site.

Soil-gas samples were collected at a total of 73 locations over the NWIRP. Sixteen samples were taken at Site 1, twenty-five samples were taken at Site 2, and thirty-two samples were taken at Site 3.

Shallow (5 foot) and deep (21 foot) samples were collected at each location. To collect the samples, a van-mounted hydraulic probe was used to advance connected, 3-foot sections of 1-inch-diameter threaded steel casing to a depth of 5 feet. The entire sampling system was purged with ambient air drawn through an organic vapor filter cartridge. A Teflon line was inserted into the casing to the bottom of the hole, and the bottom-hole line perforations were isolated from the up-hole annulus by an inflatable packer. A sample of in-situ soil-gas was then withdrawn through the probe and used to purge atmospheric air from the sampling system. A second sample of soil-gas was withdrawn through the probe and encapsulated in a pre-evacuated glass vial at two atmospheres of pressure (15 pounds per square inch-gauge). The self-sealing vial was detached from the sampling system, packaged, labeled, and stored for laboratory analysis.

The hydraulic probe was then further advanced to a depth of 21 feet, and a deep sample was collected in the same manner as above.

Prior to the day's field activities all sampling equipment and probes were decontaminated by washing with soapy water and rinsing thoroughly. Internal surfaces were flushed dry using pre-purified nitrogen or filtered ambient air, and external surfaces were wiped clean using paper towels. After the collection of each sample, all equipment that contacted the soil (the stainless-steel pipes) was pressure washed prior to its reuse.

For quality assurance/quality control, field control samples were collected at the beginning of each day's field activities, after every twentieth soil-gas sample, and at the end of each day's field activities. These QA/QC samples were obtained by inserting the probe tip into a tube flushed by a 20 psi flow of pre-purified nitrogen and collecting a sample in the manner described above. Field Control Samples 101, 102, 109, 201, 224, 301, 302, and 332 were collected at the beginning of the day's field activities. Field Control Samples 106, 107, 114, 222, 323, 330, 331, and 344 were collected at the end of the day's field activities. These results are discussed in Section 4.0.

### **2.3 Temporary Monitoring Well Survey**

A temporary monitoring well survey was conducted to aid in the placement of the permanent monitoring wells. The temporary well points were selected based on the results of the soil-gas survey. Twenty-nine temporary wells were installed, sampled, and analyzed for the following parameters: vinyl chloride; 1,1,-dichloroethene; trans-1,2-dichloroethene; 1,1-dichloroethane; cis-1,2-dichloroethene; 1,1,1-trichloroethane; 1,2-dichloroethane; trichloroethene; and tetrachloroethene. The location of the temporary wells is illustrated in Figure 2-2).

The temporary wells were drilled with a Mobil B-57 drilling rig. Hollow-stem augers were used to advance the borings through the overburden with a minimum borehole diameter of 6 inches. All 29 temporary wells were screened in the shallow part of the overburden aquifer. The well point consisted of a 2-inch well screen installed through the hollow-stem auger; the augers were pulled back to expose the screen. All temporary wells were constructed with 2-inch inside diameter, Schedule 40, flush-joint threaded, polyvinyl chloride (PVC) pipe and a 10-foot length of PVC screen with a slot size of 0.010 inches, capped at the bottom by a PVC end plug. The well point was purged a minimum of three volumes with a stainless- steel bailer and a sample was collected using the bailer.

Twenty-nine temporary wells were sampled and analyzed for the following volatile organics at the site: vinyl chloride; 1,1-dichloroethene (1,1-DCE); trans-1,2-dichloroethene (t-1,2-DCE); 1,1-dichloroethane (1,1-DCA); cis-1,2-dichloroethene (c-1,2-DCE); 1,1,1-trichloroethene (1,1,1-TCA); 1,2-dichloroethane (1,2-DCA); trichloroethene (TCE); and tetrachloroethene (PCE).

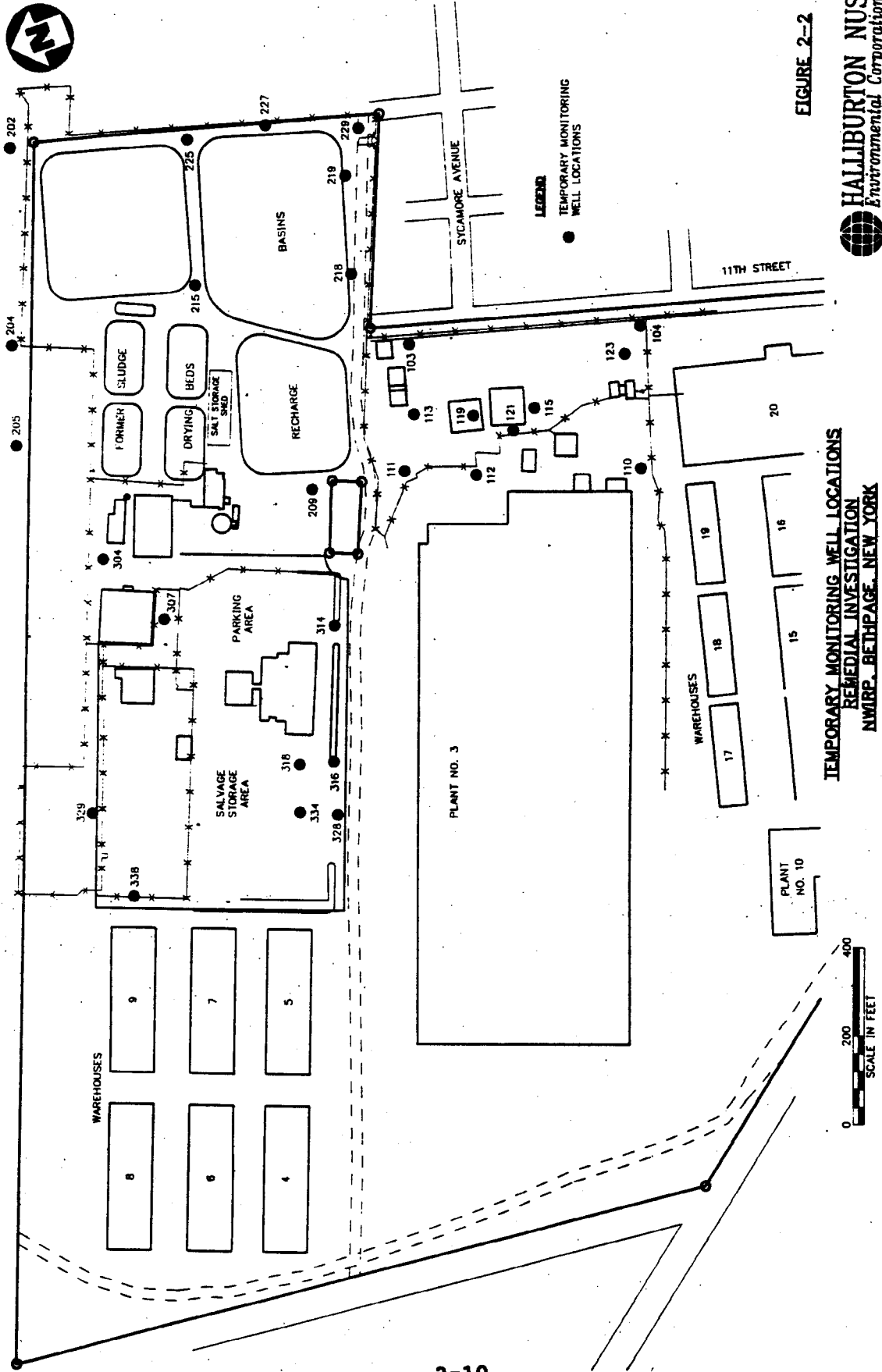

FIGURE 2-2



TEMPORARY MONITORING WELL LOCATIONS  
REMEDIAL INVESTIGATION  
NWRP, BETHPAGE, NEW YORK

## **2.4 Soil Borings and Sampling**

Forty-eight subsurface soil samples and four duplicate samples were collected at the 29 temporary monitoring well locations during temporary well drilling operations. The locations of the soil borings are presented in Figure 2-3.

The subsurface soil samples were collected at a depth of 3 to 5 feet and/or 19 to 21 feet. For each location, the decision to sample was dependent on the soil-gas measurement at that location and depth. In general, if volatile organics were detected at that point, then a soil sample was obtained for offsite, fixed-base, laboratory analysis. If volatile organics were not detected at that point, then a soil sample was not obtained. However, several soil samples were collected at points where soil-gas measurements indicated the absence of soil contamination. These samples were analyzed off site at a fixed-base laboratory to confirm the absence of soil contamination.

The samples were collected by driving a 2-inch-outside-diameter by 24-inch length split-barrel sampler with repeated blows using a 140-pound weight falling a distance of 30 inches. A portion of the soil recovered was placed in appropriate jars for shipping and analysis. Sample log sheets for all soil samples are included in Appendix B.

All the samples were analyzed for TCL volatile organics. The near-surface (3 to 5 feet deep) soil samples were also analyzed for semivolatile organics, TAL metals, and cyanide. Four samples identified as stained were also analyzed for PCBs and pesticides.

In addition to these chemical analyses, six select samples were evaluated for engineering parameters. Two samples were selected at each site plus one duplicate sample (for a total of seven), based on the field screening data. For each site, one sample represented a relatively low level of contamination, and the second sample represented an intermediate or high level of contamination. The engineering parameters consist of

- Total organic carbon (TOC) to evaluate the potential for groundwater contamination through an estimate of the contaminant soil/water partition coefficient.
- Bulk density, grain size, moisture content, and pH for general engineering considerations.

## **2.5 Surface Soil Sampling**

Twenty-nine surface soil samples and four duplicate samples were collected from locations that consisted of points in a relatively uniform, 300-foot by 300-foot grid plus field opportunity sample locations. In addition, four samples identified as stained were analyzed for PCBs and pesticides.

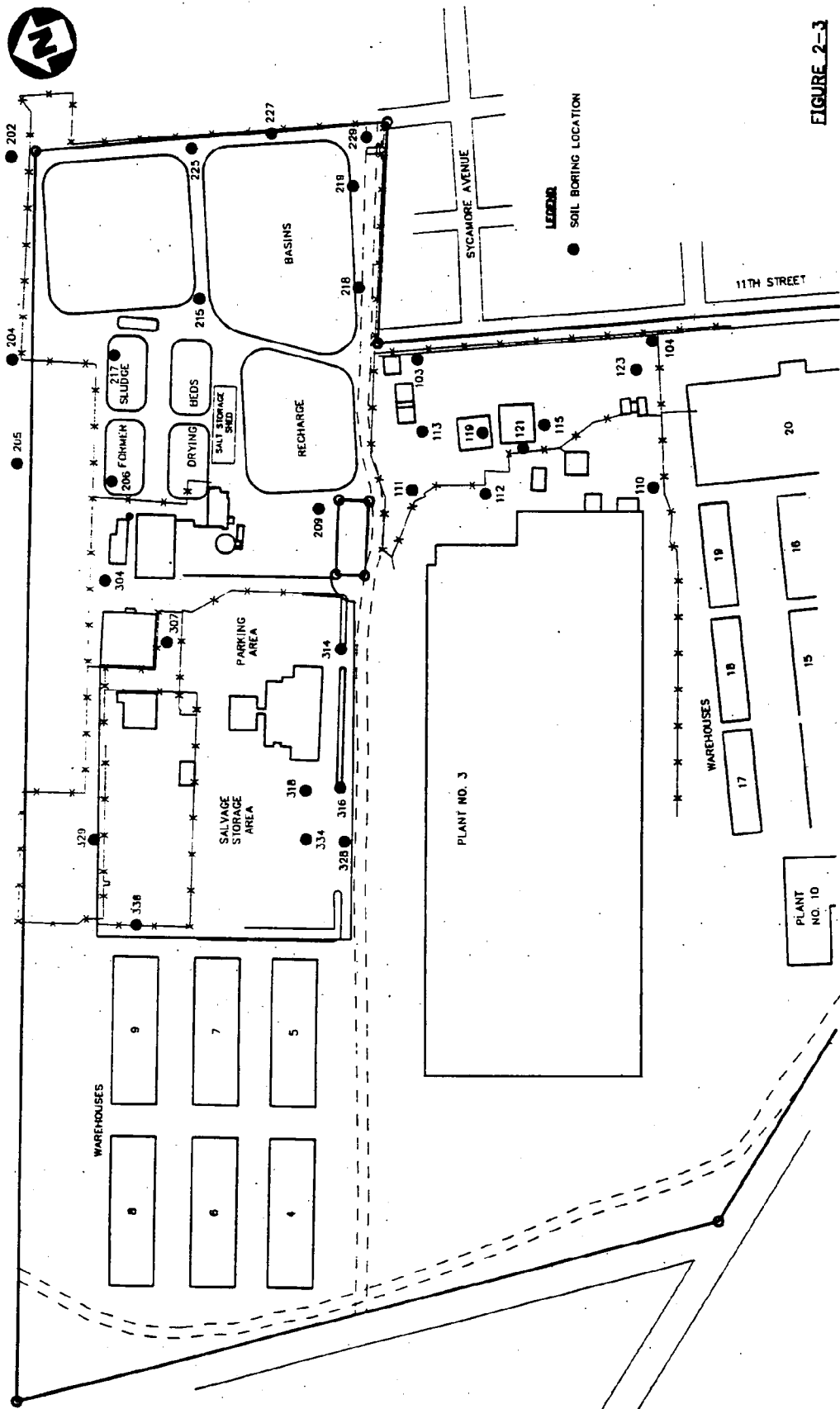

FIGURE 2-3

SOIL BORING LOCATIONS  
REMEDIAL INVESTIGATION  
NWIRE, BETHPAGE, NEW YORK





The surface soil sample locations are illustrated in Figure 2-4. There was a 2-point by 3-point grid at Site 1; a 3-point by 4-point grid at Site 2; and a 2-point by 3-point grid at Site 3. The opportunity samples were selected in the field during the sampling activities. Soils which appeared to be stained or visually discolored were selected. The samples were collected at a depth of 1 to 6 inches and were analyzed for TCL volatile and semivolatile organics, TAL metals, cyanide, and PCBs/pesticides. The samples were collected with a stainless-steel trowel and were placed in appropriate jars for shipping and analysis. The analytical results are discussed in Section 4.0. The chain-of-custody forms are provided in Appendix C.

## **2.6 Monitoring Well Installation**

Monitoring wells were installed to evaluate the impact of the three sites on the local groundwater quality and to assess the potential vertical and lateral migration of any contaminants. The potential vertical migration of the contaminants was investigated through the construction of well clusters composed of shallow (49- to 59-foot deep), intermediate (110-to 158-foot deep), and deep (198- to 230-foot deep) monitoring wells. These yield groundwater quality analyses from various depths and define the magnitude and direction of local vertical hydraulic gradients. The potential lateral migration of contaminants was investigated through the placement of wells both upgradient and downgradient from the sites. The results of the soil-gas survey and of the temporary wells were used to determine the location of the monitoring wells.

A total of 17 monitoring wells (7 shallow, 7 intermediate, and 3 deep) were installed at the NWIRP. The location of these monitoring wells is provided in Figure 2-5. The shallow wells were drilled with a CME 75 drilling rig. Hollow-stem augers were used to advance the borings through the overburden with a minimum borehole diameter of 10 inches. The shallow wells were constructed to be screened across the water table. The depth of each well was selected so that 8 feet of the 10-foot screen was below the water table and 2 feet was above the water table.

To determine the screened interval for the intermediate and deep monitoring wells, a pilot hole was drilled at each well cluster with 6-inch outside diameter (OD) hollow-stem augers. Split-barrel samples were taken every 10 feet and put in glass jars. Headspace readings were taken with a portable photoionizer (Hnu) field instrument for each sample. A gamma ray logger was run in each pilot hole to identify the lithologies present at the non-sampled intervals. The screened interval for the intermediate and deep wells was determined based upon the results of the gamma ray log and the headspace readings. Complete boring logs for all wells are included in Appendix D.

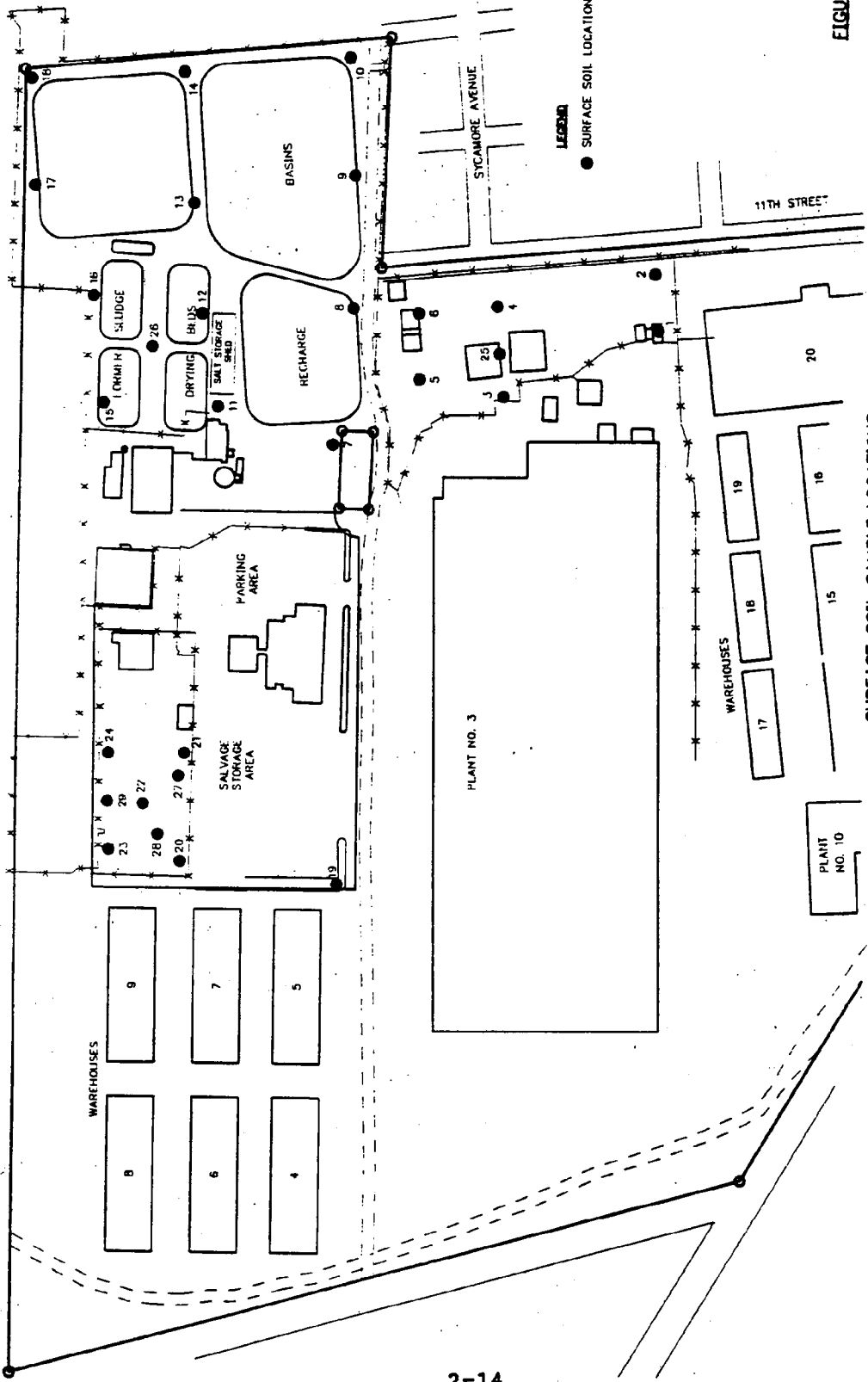
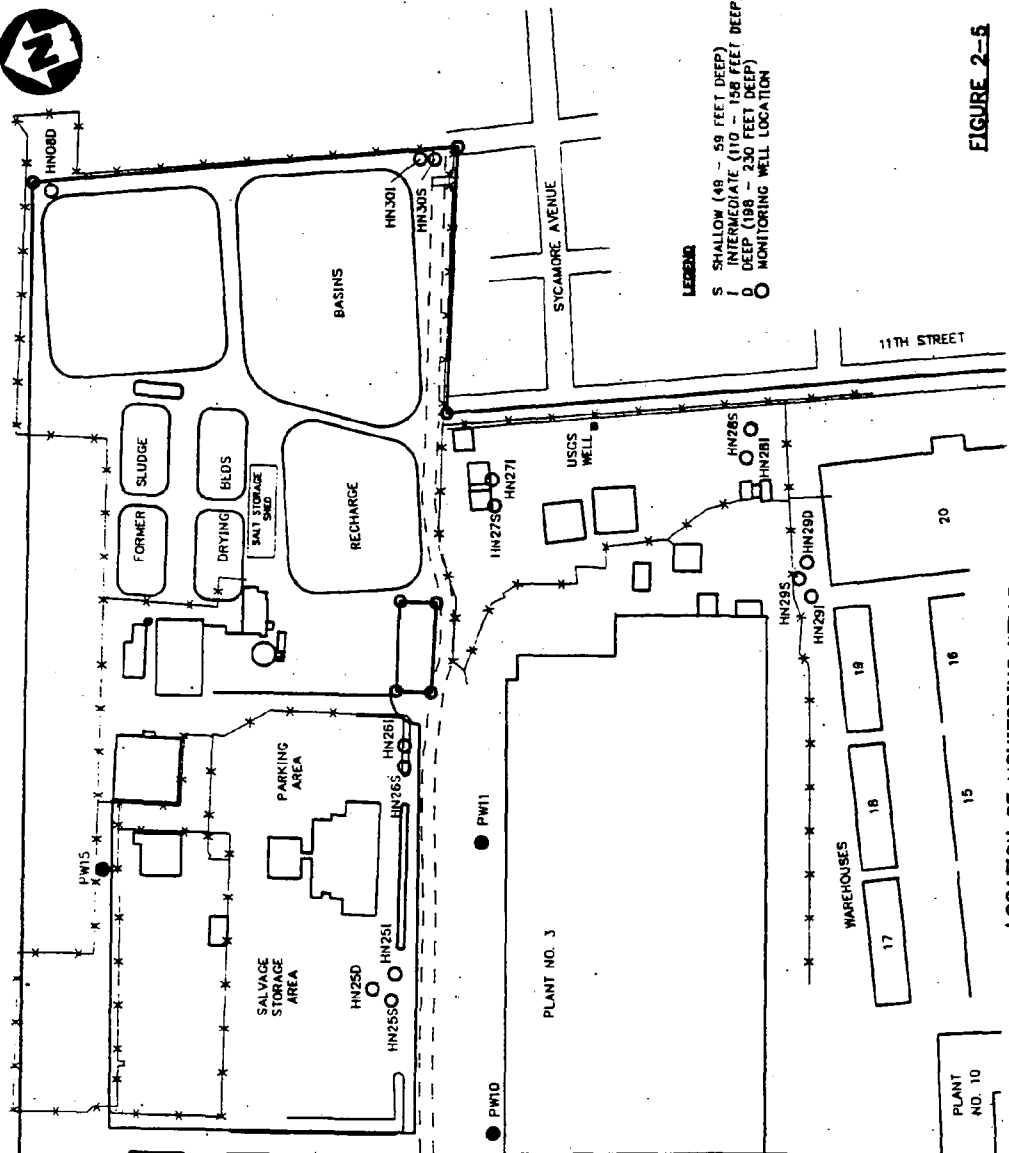

FIGURE 2-4

**SURFACE SOIL SAMPLE LOCATIONS  
REMEDIAL INVESTIGATION  
NWIRP, BETHPAGE, NEW YORK**





**LEGEND**  
 S SHALLOW (48 - 59 FEET DEEP)  
 I INTERMEDIATE (110 - 156 FEET DEEP)  
 D DEEP (198 - 230 FEET DEEP)  
 O MONITORING WELL LOCATION

FIGURE 2-5



**LOCATION OF MONITORING WELLS  
 REMEDIAL INVESTIGATION  
 NWARP, BETHPAGE, NEW YORK**

WELL CONSTRUCTION DETAILS				
WELL No.	ELEVATION (FEET msl)	DEPTH OF BORING (FEET)	SCREENED INTERVAL	DATE COMPLETED
HN24-S	122.73	58	48.6 - 58.6	09-04-91
HN24-I	121.76	156	148 - 156	10-25-91
HN25-S	125.69	59.3	49 - 59	09-05-91
HN25-I	123.91	130.4	120 - 130	11-21-91
HN25-D	124.82	210	200 - 210	01-22-92
HN26-S	125.00	55.0	45.3 - 54	09-05-91
HN26-I	124.84	153	143.3 - 153	09-04-91
HN26-D	128.59	155.3	100 - 110	11-01-91
HN27-S	122.82	54.3	44 - 54	09-03-91
HN28-S	119.04	155	131 - 141	11-08-91
HN28-I	116.42	130.4	39 - 49	09-04-91
HN28-D	115.11	220.0	120 - 130	11-28-91
HN30-S	129.10	57.3	210 - 220	01-08-92
HN30-I	126.27	155	47 - 57	09-05-91
HN30-D	125.91	195.4	110 - 120	10-21-91
HN308-D	125.91	195.4	168 - 198	12-19-91

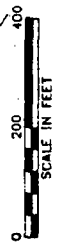

The intermediate wells were drilled using a Failing F-10 rig. Hollow-stem augers were used to advance the borings through the overburden with a minimum borehole diameter of 10 inches.

The deep wells were also drilled using a Failing F-10 rig. The borings were drilled with the mud rotary technique to a depth of 20 feet above the top of the screened interval. At this depth, the mud was pumped out of the borehole, and a reverse-circulation, water rotary technique was used to advance the borehole through the interval to be screened to the total depth of the well. Samples were not collected during the drilling of the deep wells due to the drilling methods employed.

The monitoring wells were constructed with a 4-inch-diameter, Schedule 40 PVC well casing and 010-slot PVC well screen. The well screens were 10 feet in length, capped at the bottom with a PVC end plug. The annular space between the PVC well screen and the borehole was backfilled with a clean quartz sand pack composed of Morie No. 1 sand to a height of 3-5 feet above the top of the screen. For the shallow wells, a pellet bentonite seal with a minimum thickness of 2 feet was emplaced above the filter pack. For the intermediate and deep wells, a masonry sand seal of 2 to 4 feet thick was emplaced above the filter pack. A bentonite slurry of a minimum 3 foot thickness was emplaced by tremie above the masonry sand seal. The remainder of the annulus for all intermediate and deep wells and most shallow wells was backfilled with a bentonite/cement grout to a depth approximately 3 feet below ground elevation. Wells 24S, 27S, and 28S were backfilled with a thick bentonite grout.

All wells were developed a minimum of 48 hours after installation. As directed by the New York State Department of Environmental Conservation (NYSDEC), an attempt was made to develop each well to a water turbidity level of less than 50 NTU. This level was achieved at every well but one (HN-29S). In addition, the groundwater temperature, pH, and conductivity were monitored during development. The well development logs are included as Appendix E.

The shallow wells were developed with a submersible pump. These wells, with one exception, developed quickly and to a turbidity of less than 50 NTU after a maximum of approximately 500 gallons had been pumped. Well HN-29S was the exception. Despite repeated effort and the pumpage of more than 1,000 gallons, the turbidity readings of this well remained above the upper limit of the indicating range of the instrument, or above 200 NTU. The pH and temperature readings, however, indicated that stable conditions had been reached. After consultation with the onsite NYSDEC representative, it was decided that further development was not needed.

The intermediate and deep wells were developed through air lifting. These wells, with one exception, developed quickly and to a turbidity of less than 50 NTU. Well HN-28I was the exception.

This well required surge-blocking before it developed to a turbidity of less than 50 NTU. The amount of water developed from the wells was also controlled by the amount of water added to the borehole to control running sands during hollow-stem auguring and/or the amount of water estimated to have been lost to the formation during the reverse-circulation drilling. In all cases, the amount of water removed during development greatly exceeded the amount introduced during well installation. In general, between 3,500 and 7,000 gallons of water were pumped from each well during development.

## **2.7 Groundwater Sampling**

Sampling and analysis of groundwater was conducted to determine the current level and extent of contamination and to provide data for use in the risk assessment and the evaluation of remedial action alternatives for the Feasibility Study. The groundwater sampling was conducted from December 3 through December 11, 1991, and included 19 wells: 14 shallow and intermediate wells, 1 USGS well, and 4 process wells. The groundwater sampling for the three deep wells was conducted on February 11 and 12, 1992. Monitoring well locations are shown in Figure 2-5.

The groundwater sampling and analysis program and sampling procedures are described in the Final RI Work Plan and Quality Assurance Plan.

Field measurements collected during sampling were pH, temperature, specific conductivity, and turbidity. These results are provided in Appendix E. Groundwater samples were submitted to a Naval Energy and Environmental Support Activity (NEESA) approved laboratory using CLP methods. All groundwater samples were analyzed for Target Compound List (TCL) volatile organics, TCL semivolatile organics, Target Analyte List (TAL) metals (total and dissolved), cyanide, and hexavalent chromium. Sample log sheets for all wells are included in Appendix B.

In addition to the chemical analysis used for the nature and extent of contamination and risk assessment, select samples were also evaluated for engineering parameters. Three samples were selected from all of the monitoring wells based on the field screening data; one sample representing a relatively low level of contamination (HN25-I), one sample representing an intermediate level of contamination (HN27-I), and one sample representing a high level of contamination (HN29-S). These engineering parameters consisted of the following -- pH, total dissolved solids (TDS), alkalinity, and hardness to evaluate the scaling potential of the groundwater; biochemical oxygen demand-5 day (BOD), total organic carbon (TOC), and total suspended solids (TSS) -- to evaluate other contamination in the groundwater and potential treatment requirements.

Quality control samples, including field duplicates, trip blanks, and rinsate blanks, were collected and analyzed for each sampling round as specified in Table 2-7.

**TABLE 2-7**

**NEESA LEVEL D REQUIREMENTS  
NWIRP, BETHPAGE, NY**

QA/QC TYPE	NEESA REQUIREMENT
Field Duplicate	One duplicate in 10 samples per sample matrix.
Rinsate Blank	One sample of the final rinse during decontamination of sampling equipment per day. Initially, samples from every other day are analyzed. If analytes pertinent to the project are found in the rinsate, the remaining samples are analyzed.
Field Blank	One sample of each source water used for decontamination of sampling equipment for each sampling event.
Trip Blank	One sample of analyte-free water per day, for each shipment of samples, for volatile organic analysis.
Matrix Spike/ Matrix Spike Duplicate (MS/MSD)	One sample in 20 samples per sample matrix.

The analytical results for groundwater sampling are discussed in Section 4.0.

### **2.8 Surface Water and Sediment Sampling**

Two samples of surface water were collected at the site. One surface water sample was taken from the influent cooling water recharge basin to evaluate potential contamination in process-generated wastewaters, and the other sample was collected during a precipitation event from the influent storm water discharge recharge basin to evaluate the potential transport of contamination into the basins via storm water discharge.

Surface water sampling was conducted on December 4, 1991 following a day (December 3) of steady rain. There were intermittent snow showers at the time the sample was collected. The samples were submitted to a NEESA-approved laboratory using CLP methods. All surface water samples were analyzed for TCL volatile organics, TCL semivolatile organics, TAL metals (total and dissolved), cyanide, and hexavalent chromium.

Four sediment samples were collected at the site. Two sediment samples were taken in each active basin. A third basin at the site was not sampled because it is not currently in use and the sediment has been stripped away. Sediment sampling was conducted on August 27, 1991, and on December 11, 1991. All sediment samples were analyzed for TCL volatile and semivolatile organics, TAL metals, and cyanide.

Sampling point locations for surface water and sediment samples are illustrated in Figure 2-6. The analytical results for surface water and sediment sampling are discussed in Section 4.0.

Quality control samples including field duplicates, trip blanks, and rinsate blanks were collected and analyzed as specified in the Final Quality Assurance Plan and the Final Work Plan.

### **2.9 Water-Level Measurements**

Two complete rounds of groundwater-level measurements were taken on December 18, 1991, and January 24, 1992, from 30 wells throughout the study area to better define groundwater flow paths and horizontal and vertical gradients. It should be noted that groundwater level measurements taken on December 18, 1991, exclude wells HN-25D, HN-29D, and HN-08D, which had not been drilled when the measurements were taken.

All groundwater-level readings were conducted using calibrated electrical water-level indicators (M-scopes), or a weighted tape measure coated with chalk if moisture on the side of the well casing was affecting the M-scope. All measurements were measured from a marked point on the top of the PVC well riser pipe. On four wells (GM-7S, 7I, 7D, 13D), measurements were taken from the top of a surface casing, which was on top of the well. Geraghty and Miller

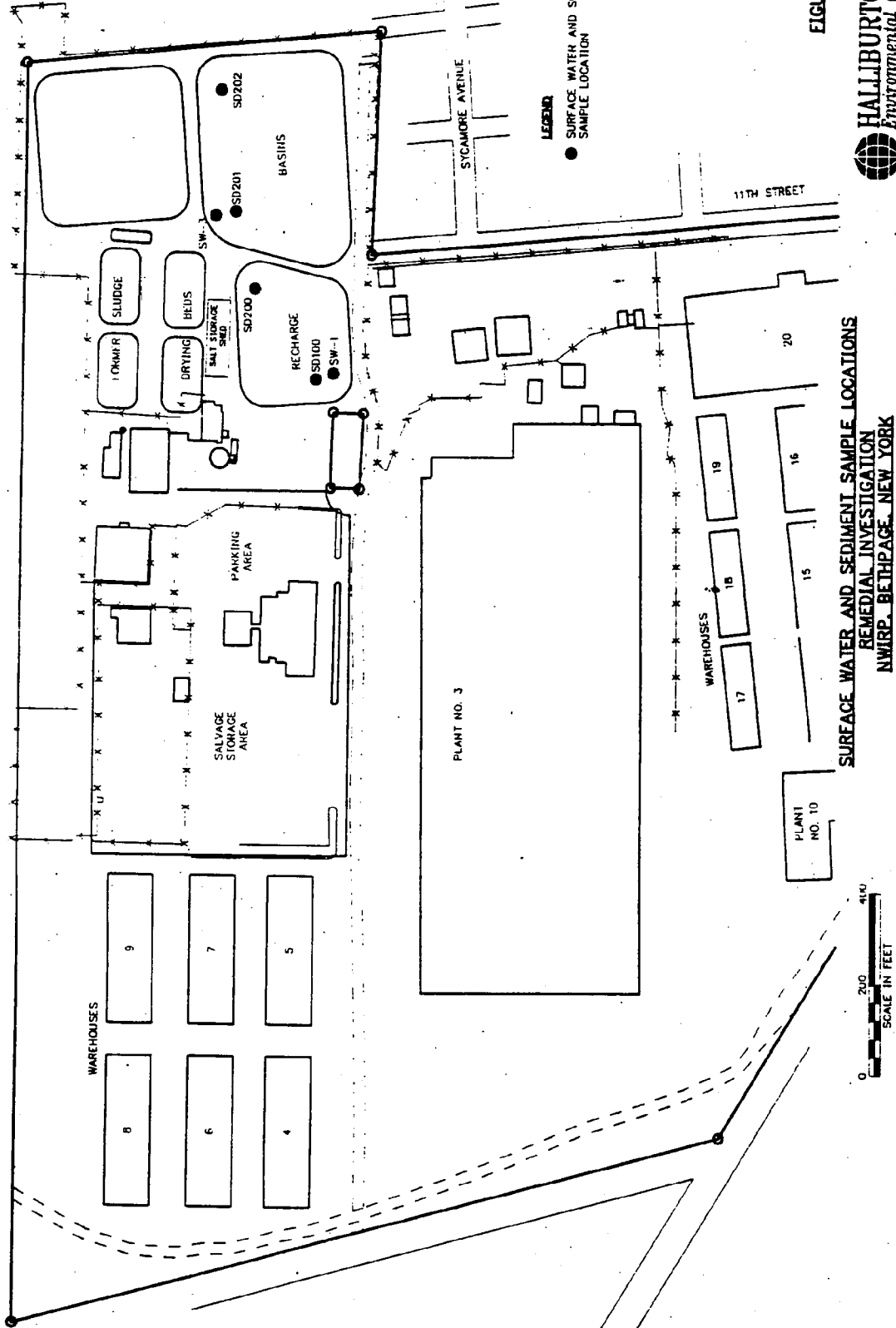

2-20

FIGURE 2-6

 **HALLIBURTON NUS**  
Environmental Corporation

**SURFACE WATER AND SEDIMENT SAMPLE LOCATIONS**  
REMEDIAL INVESTIGATION  
NWRP, BETHPAGE, NEW YORK



has provided the necessary information to convert the readings to the top of polyvinyl chloride (PVC). All measurements were recorded to the nearest 0.01 foot. Measurements for each water level round were conducted within a 24-hour period of consistent weather conditions to minimize precipitation/atmospheric effects on groundwater levels.

Groundwater contour maps developed using these measurements are presented in Section 3.0.

#### **2.10 Horizontal and Vertical Elevation Survey**

Between December 19, 1991, and January 29, 1992, horizontal locations and vertical elevations were surveyed at 17 newly installed monitoring wells a previously installed USGS well, 29 surface soil locations, and 73 soil gas locations.

Surveying for each well included the elevation of the ground surface adjacent to the well, and the top of the PVC riser. Surveying for all other locations was conducted at the spot of the sample. Surveying notes are provided in Appendix F.



### **3.0 PHYSICAL CHARACTERISTICS OF STUDY AREA**

#### **3.1 Surface Features**

The NWIRP Bethpage is located on Long Island, New York. It is located on a relatively flat, featureless, glacial outwash plain. The site and nearby vicinity are highly urbanized. Because of this, most of the natural physical features have been reshaped or destroyed. The topography of the activity is relatively flat with a gentle slope toward the south. Elevations range from greater than 140 feet (above mean sea level, MSL) in the north to less than 110 feet (above MSL) at the southwest corner (RGH, 1986).

The NWIRP is about 108 acres in size. The dominant features at the activity are Plant No. 3 (the manufacturing plant) and three groundwater recharge basins located at Site 2. The recharge basins are each approximately 1.5 to 2.5 acres in area and about 30 feet deep. Other notable features at the site are a wastewater treatment plant at Site 2, an office building at Site 3, and a drum marshaling area at Site 3.

#### **3.2 Geology**

##### **3.2.1 Summary**

The NWIRP is underlain by approximately 1,100 feet of unconsolidated sediments that unconformably overlie crystalline bedrock. The unconsolidated sediments consist of four distinct geologic units that, in descending order, are the Upper Glacial Formation, the Magothy Formation, the Raritan Clay Member of the Raritan Formation, and the Lloyd Sand Member of the Raritan Formation. The crystalline bedrock consists primarily of metamorphic and igneous rocks including schist, gneiss, and granite. The regional dip of the bedrock is to the south and southeast. All of the geologic units dip in these directions, although to varying degrees (Isbister, 1966).

The Upper Glacial and the Magothy Formations were penetrated and sampled; the Raritan Formation lies below the depth of this investigation. The Upper Glacial Formation, which is about 30 to 45 feet thick, consists chiefly of coarse sands and gravels. The upper Magothy Formation consists chiefly of coarse sands to a depth of about 100 feet, below which finer sands, silts, and clays predominate. The clay is fairly common but laterally discontinuous; no individual clay horizon of regional extent underlies the NWIRP. Two cross-sections (Figures 3-1, North-South and 3-2, East-West) illustrate the geological conditions beneath the NWIRP. Cross-section locations are illustrated in Figure 3-3.

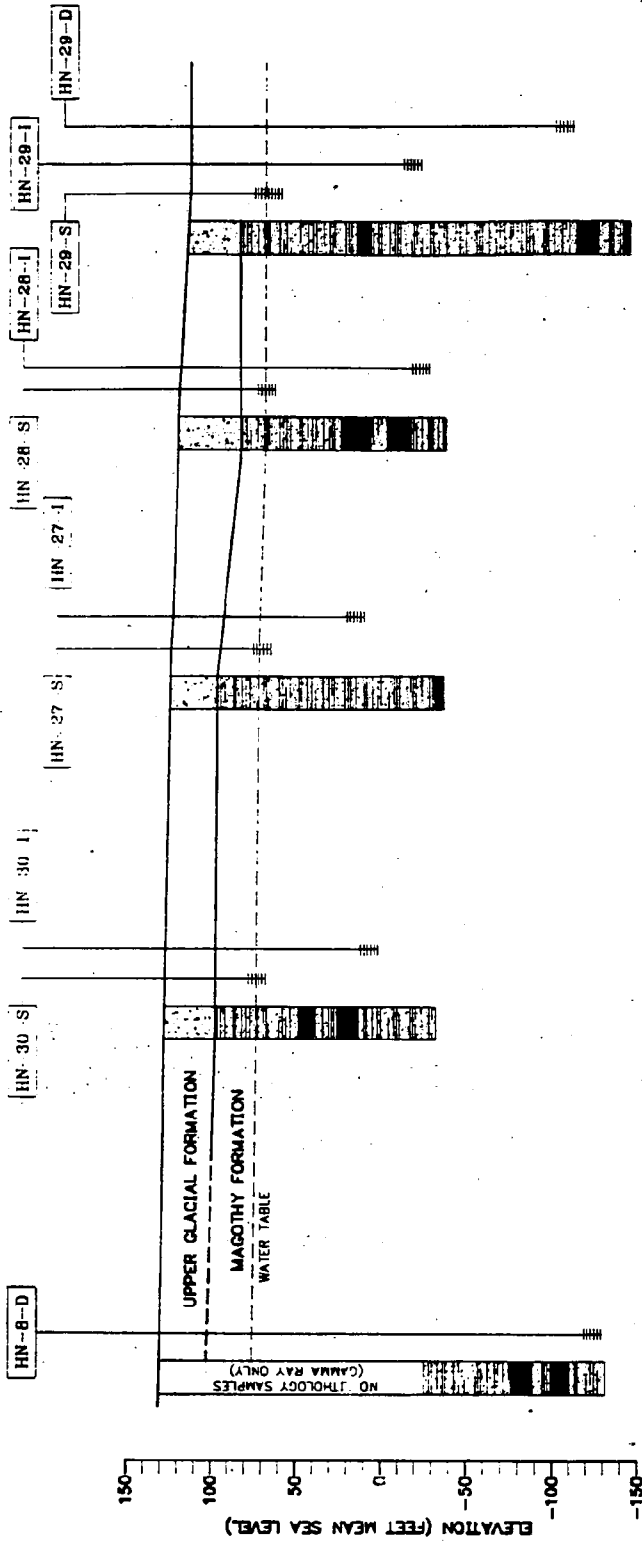

3-2

**LEGEND**



UPPER GLACIAL FORMATION: dominantly coarse brown sands & gravels

MAGOTHY FORMATION: interbedded sands, silts, and clayey and silty sands. Generally coarser grained at top, becoming increasingly finer grained with depth.

MAGOTHY FORMATION: clays. Lithologies range from black, very hard and brittle clays to gray, soft and plastic clays.

**NOTES**

1. WELLS ARE NOT TO HORIZONTAL SCALE.
2. SEE FIGURE 3-3 FOR WELL LOCATIONS.

FIGURE 3-1

**NORTH-SOUTH CROSS-SECTION THROUGH THE NWIRP  
REMEDIAL INVESTIGATION  
NWIRP, BETHPAGE, NEW YORK**



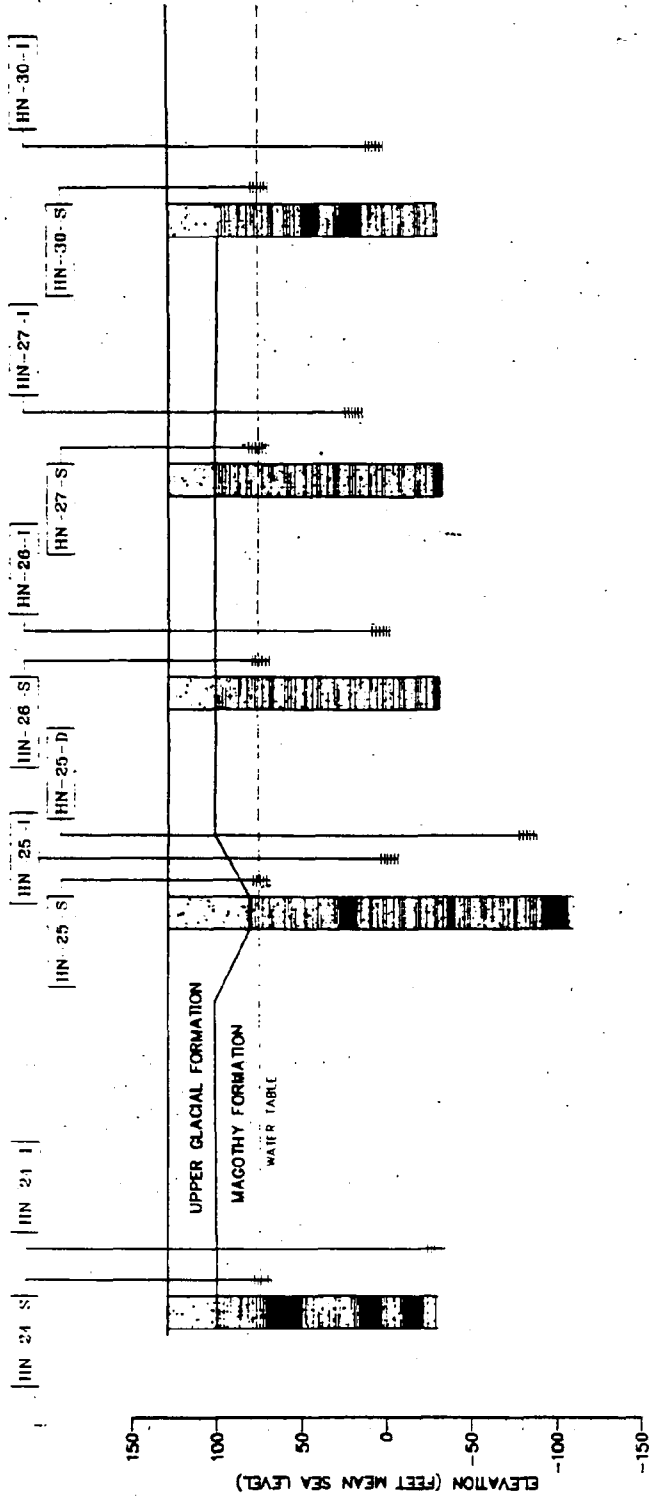

3-3

**LEGEND**

-  UPPER GLACIAL FORMATION: dominantly coarse brown sands & gravels
-  MAGOTHY FORMATION: interbedded sands, silts, and clayey and silty sands. Generally coarser grained at top, becoming increasingly finer grained with depth.
-  MAGOTHY FORMATION: clays. Lithologies range from black, very hard and brittle clays to gray, soft and plastic clays.

**NOTES**

1. WELLS ARE NOT TO HORIZONTAL SCALE.
2. SEE FIGURE 3-3 FOR WELL LOCATIONS.

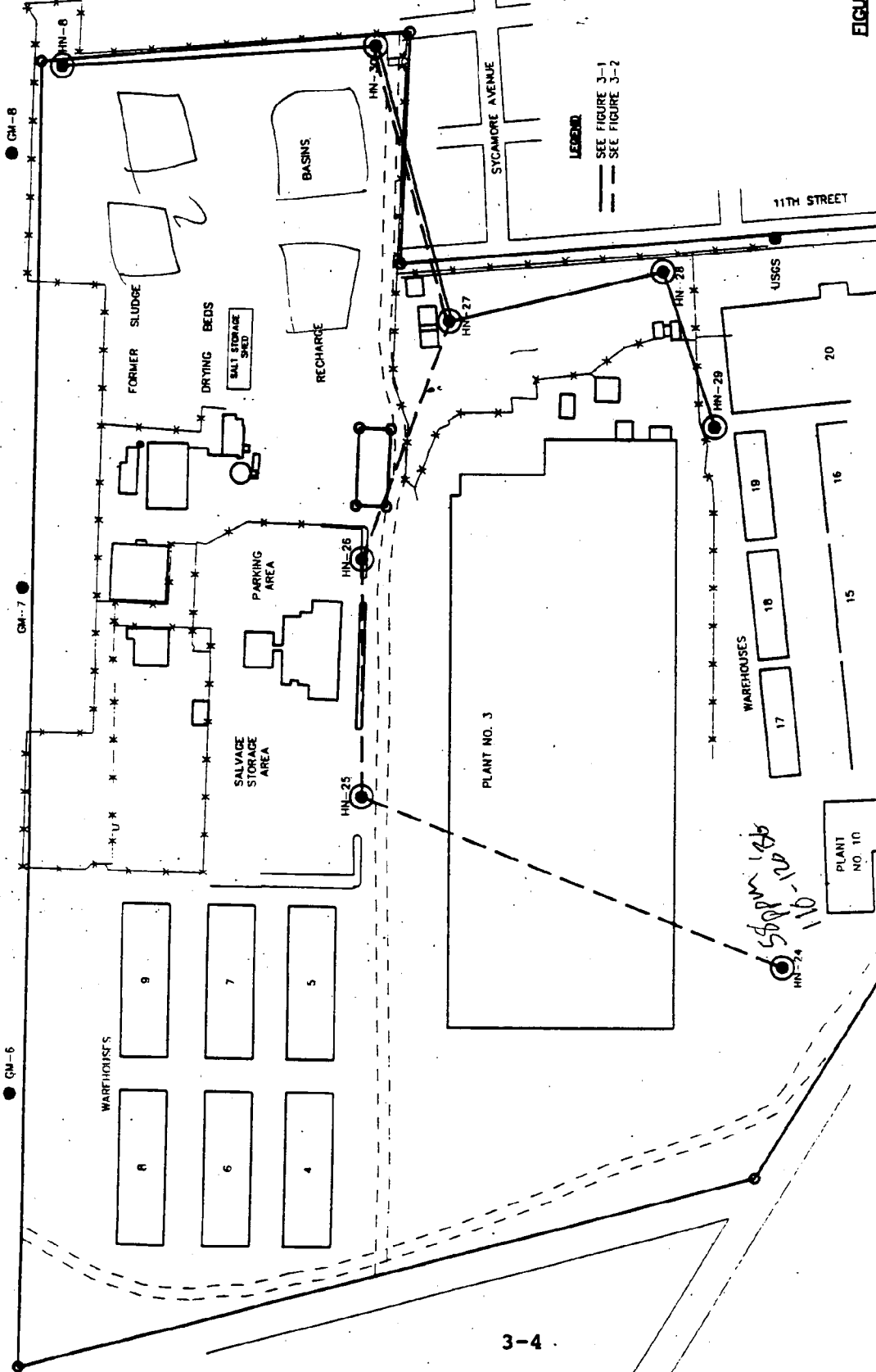

FIGURE 3-3

CROSS-SECTION LOCATIONS  
REMEDIATION INVESTIGATION  
NWRRP, BETHPAGE, NEW YORK



HALLIBURTON NUS  
Environmental Corporation

### 3.2.2 Stratigraphy

#### 3.2.2.1 Upper Glacial Formation

The NWIRP lies on a featureless glacial outwash plain that slopes gently to the south. The Long Island region was subjected to several episodes of glaciation during the Pleistocene Period that resulted in the deposition of two moraines. The younger, Harbor Hill end moraine trends roughly east-west along Long Island's northern shore, approximately 10 miles north of the activity. The older, Ronkonkoma terminal moraine lies several miles north of the site, trends east-west, and basically bisects Long Island. As the glaciers retreated, large volumes of sediment were transported downgradient by meltwater-supplied streams and were deposited either in intermorainal areas or, south of the Ronkonkoma moraine, on large, topographically subdued glacial outwash plains. The NWIRP lies upon such an outwash plain (Isbister, 1966; McClymonds and Franke, 1972).

The Upper Glacial Formation (commonly referred to as glacial deposits) forms the surface deposits across the entire NWIRP. The formation penetrated beneath the NWIRP consists of coarse brown sands and gravels. Gravel recovered during onsite drilling operations in the split-spoons was as large as 2.5 inches in size. Larger pieces were brought to the surface by the hollow-stem augers. The gravels occurred either in beds dominated by a coarse sand matrix, in thin, discrete gravel beds, or in thicker gravel lenses. The base of the glacial deposits (top of the Magothy Formation) was defined in the field as the horizon where gravel becomes very rare to absent, and variegated finer sands, silts, and clays predominate. This agrees with the formation's description as reported in the literature (Isbister, 1966). It should be noted, however, that the generally coarse nature of both formations near their contact often makes their differentiation rather subjective.

The extensive construction activity that has taken place at each site has undoubtedly destroyed the natural stratigraphic profile. The surface sediments described as and assigned to the Upper Glacial Formation possibly consist of disturbed material in some instances. An abandoned septic drainage field, for example, underlies a large part of Site 1. Some areas of Site 2 have been excavated and/or graded during the construction of the recharge basins or the construction and subsequent abandonment of the sludge drying beds. The depth of disturbance at these areas is not known. Differentiation between disturbed and natural material was made more difficult by the apparent backfilling of the disturbed areas with the same glacial deposits. An attempt was made in all cases to identify non-native material.

The combined thickness of the glacial deposits beneath the entire Grumman complex is reported in the literature to range between 40

to 130 feet (G&M, 1990). The results of the current soil boring and well installation program indicate that beneath the NWIRP the glacial deposits are generally thinner, and range in thickness from approximately 30 to 45 feet (see soil boring and monitoring well drilling logs, Appendices C and D).

The base of the glacial deposits (the contact with the Magothy Formation) is an irregular and undulating, unconformable surface formed by the large-scale erosion and/or deposition of sediments by glacial outwash streams (Isbister, 1966). This relationship is apparent at location HN-25. Here, abundant gravels were encountered to depths of 45 feet, whereas at a location only several hundred feet away (HN-26), and along strike, the base of the gravel was at a depth of 26 feet.

Another characteristic of glacial outwash deposits is their lateral heterogeneity. Again, this is clearly seen at location HN-25. As stated, a thick gravel lense was encountered to a depth of 45 feet. This lense was such a hindrance during drilling operations that several boreholes had to be abandoned. A successful borehole was completed approximately 30 feet east of the original borehole, where little gravel was encountered. The origin of these stratigraphic units is unknown, but it is hypothesized that the gravel lense is a Pleistocene channel point-bar or braided stream deposit.

#### 3.2.2.2 Magothy Formation

The Magothy Formation regionally consists of "interbedded gray, buff, and white fine sand and clayey sand and black, gray, white, buff, and some red clay." (Isbister, 1966) The drilling program at NWIRP confirms that the local lithology is similar to the regional description, with the addition of numerous silty intervals.

A general lithologic trend observed in the Magothy Formation during the drilling program is a decrease in average grain size with increasing depth. The upper Magothy is chiefly composed of thick beds of fine to coarse sands to a depth of about 100 feet. Below this depth, the relative abundance of finer-grained sediments increases sharply, and the formation is composed of fine to medium sand, silt, and clay. The coarser grained sands are relatively rare and occur in thinner, more discrete beds. Rather than exhibiting a continuous or "blanket sand" type geometry, these sands are found in lenses distributed throughout the finer grained matrix. Gravels are relatively rare to absent throughout the entire Magothy section.

Although fine-grained sediments are common within the Magothy Formation, no clays of "activity-wide" extent were penetrated to the depths of this investigation, or 250 feet (see cross-sections, Figures 3-1 and 3-2). For example, in the southern part of Site 1 (locations HN28 and HN29), an extremely dense and hard clay occurs



at a depth of approximately 100 feet. This clay is absent in the northern part of Site 1 (location HN27), which is only several hundred feet to the north. A very sticky clay occurs at a depth of about 120 feet in HN28, but it is absent at HN29, which is along strike and only a short distance away.

As will be discussed in Section 3.3, the lack of any clay layers with regional extent has significant hydrological significance because it interconnects the glacial deposits and all horizons of the Magothy Formation, at least to the depth limits of this investigation.

The Magothy Formation has a reported thickness beneath the NWIRP of approximately 600 feet. The basal Magothy consists of a highly permeable and productive gravel. This horizon was not penetrated or sampled in this investigation (Isbister, 1966; G&M, 1990).

### 3.2.2.3 Raritan Formation

The Raritan Formation underlies the Magothy Formation at subsurface depths of about 700 - 1,100 feet beneath the NWIRP. The formation lies completely below the depths of investigation for this study. Regionally, the Raritan Formation is composed of the Raritan Clay (about 100 to 150 feet thick) and the underlying Lloyd Sand Member of the Raritan Formation (about 300 feet thick) (Isbister, 1966).

## 3.3 Hydrogeology

### 3.3.1 Summary

The Upper Glacial Formation, the Magothy Formation, and the Lloyd Sand Member (Raritan Formation) are regional aquifers. The principal aquifers of concern in this investigation are the Upper Glacial and Magothy aquifers because of their shallow depths. The Magothy aquifer is the major source of public water in Nassau County. The Lloyd Sand is not widely exploited because of its depth. In addition, the Lloyd Sand is isolated from the shallower aquifers by the Raritan Clay confining unit (RGH, 1986; G&M, 1990).

The water table beneath the NWIRP occurred completely within the Magothy Formation in December 1991. The magnitude of the seasonal water table fluctuation beneath the site is unknown, but it is unlikely that the water table rises to the Upper Glacial Formation.

The geologic and hydrologic information obtained from this study indicate that the Upper Glacial and upper Magothy aquifers beneath the NWIRP are interconnected and may be considered a common aquifer. This confirms the fact that the site-specific geology is similar to the regional geology, as described in published reports. Groundwater in this aquifer occurs under water-table or unconfined conditions. The number and thickness of clay lenses increase with depth within the Magothy, but the horizontally discontinuous nature

of these units prevents any one of them from functioning as an aquitard or semiconfining unit.

The groundwater beneath the NWIRP predominantly flows to the southwest and, to a lesser extent, to the south. The flow is greatly influenced by the groundwater mounding that occurs at the recharge basins and the groundwater withdrawal at the numerous facility wells. The wells have the potential to significantly change the local flow pattern. These wells operate on an irregular basis and in various combinations, which makes their influence on the local flow regime at any particular time difficult to predict.

The horizontal hydraulic gradient varies throughout the NWIRP due to the recharge basins and facility wells. The average hydraulic gradient calculated across the activity is about 5.3 feet/mile, which is significantly lower than the published regional gradient of 10 feet/mile. The average linear velocity of the groundwater at the water table is estimated to range from 0.2 ft/day to 0.9 ft/day, which is significantly less than the previously estimated 50 to 70 ft/day (see Appendix G for calculations).

The NWIRP occupies an area of recharge. Vertical hydraulic gradients are in a downward direction, but are very low. This agrees with previously published regional data.

### 3.3.2 Aquifer Characteristics

Although considered a common aquifer at NWIRP, the hydrologic characteristics of the Upper Glacial and Magothy aquifers are discussed individually in this section because hydrologic data for these aquifers are reported separately in the literature.

The water table beneath the NWIRP occurred completely within the Magothy Formation in December 1991 (Figures 3-1 and 3-2). The magnitude of the seasonal water table fluctuation is unknown, but it is unlikely that the water table rises to the Upper Glacial Formation. Regionally, the seasonal water table variation is reported to be approximately 4 feet (Isbister, 1966).

Although not the primary service of potable water for the area, the Upper Glacial aquifer is an important source of potable water in Nassau County; well yields as high as 1,100 gallons per minute (gpm) have been reported. The glacial deposits are characterized by a high primary porosity and permeability; the porosity is reported to exceed 30 percent. The estimated average values of hydraulic conductivity and transmissivity for the outwash deposits in the Bethpage area are 2,000 gallons per day per square foot (gpd/ft<sup>2</sup>) and 100,000 gallons per day per foot (gpd/ft), respectively. Although the water table beneath the NWIRP lies below these deposits, the high permeability of the glacial deposits allows for the rapid recharge of precipitation to the underlying Magothy (Isbister, 1966; McClymonds and Franke, 1972).

The Magothy aquifer is the major source of public water in Nassau County. The most productive water-bearing zones are the discontinuous lenses of sand and gravel that occur within the siltier matrix. The major water-bearing zone is the basal gravel. The NWIRP facility wells produce from the Magothy (see Table 3-1 and Figure 3-4). These wells, which are between 357 and 560 feet deep, each have a capacity of 1,200 gpm. According to Grumman personnel, the wells often are pumped near capacity (G&M, 1990).

The average hydraulic conductivity of the Magothy aquifer decreases in a southeastward direction as it thickens and the coarser grained lenses become thinner and less persistent. The average transmissivity, however, tends to increase in this same direction due to the abrupt thickening of the aquifer. The estimated average values of hydraulic conductivity and transmissivity for the Magothy in the Bethpage area are 420 gpd/ft<sup>2</sup> and 250,000 gpd/ft, respectively (G&M, 1990; Isbister, 1966; McClymonds and Franke, 1972).

The Upper Glacial and the Magothy aquifers are commonly regarded as a common aquifer. One reported pump test in Hicksville, New York, a short distance from the study area, showed hydraulic interconnection between the glacial outwash deposits and the underlying deposits of the upper Magothy Formation (Isbister, 1966).

The site-specific lithologic and hydrologic information obtained from the current drilling program indicates that the Upper Glacial and Magothy aquifers beneath the NWIRP are similarly interconnected and function as a common aquifer. The gravels and coarse sands of the Upper Glacial aquifer are in direct contact with the permeable sands of the Magothy aquifer. There was no evidence of any clay layer or finer grained interval that could have served as even a local aquitard or semi-confining layer (see soil boring and monitoring well drilling logs, Appendices C and D, and geologic cross-sections, Figures 3-1 and 3-2).

The static water levels of the NWIRP monitoring wells, as measured on December 18, 1991, are presented in Table 3-2. Note that for any particular cluster, the static water elevations for the shallow and intermediate wells vary from 0.01 feet to about 5 feet, indicating highly variable vertical gradients. According to one published report, the potentiometric surface of confined aquifers in central Long Island is typically 30 to 40 feet below the water table (McClymonds and Franke, 1972). The water level elevations for the NWIRP wells, therefore, appear to confirm that both the Upper Glacial and upper Magothy aquifers are unconfined and function as a common aquifer.

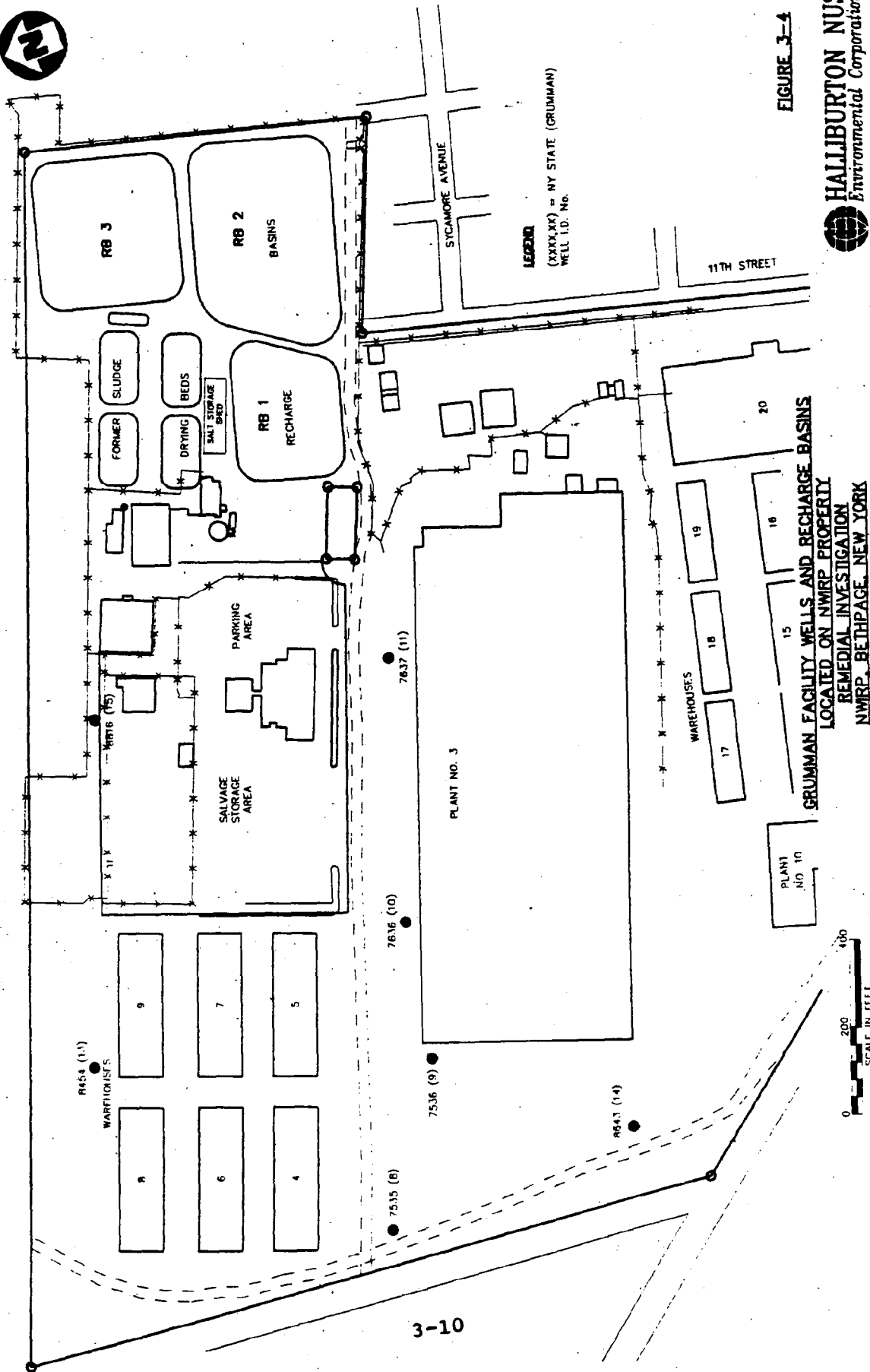

FIGURE 3-4



3-10

TABLE 3-1

WELLS LOCATED ON NWIRP PROPERTY  
(SEE FIGURE 3-4 FOR WELL LOCATIONS)  
NWIRP, BETHPAGE, NY

NY STATE ID	GRUMMAN ID	DEPTH (FT)	SCREENED INTERVAL (FT)	CAPACITY (GPM)	AQUIFER
7536	9	436	375-436	1200	Magothy
7535	8	357	280-290 305-357	1200	Magothy
7636	10	373	312-373	1200	Magothy
7637	11	490	429-489	1200	Magothy
8454	13	560	499-560	1200	Magothy
8643	14	467	416-467	1200	Magothy
8816	15	500	450-500	1200	Magothy

**TABLE 3-2  
GROUNDWATER ELEVATIONS  
NWIRP, BETHPAGE, NY**

WELL #	TOP OF PVC (FEET NSL)	DECEMBER 18, 1991		January 24, 1992	
		DEPTH TO WATER (FEET)	WATER ELEVATION (FEET NSL)	DEPTH TO WATER (FEET)	WATER ELEVATION (FEET NSL)
HN24-S	122.73	49.74	72.99	50.38	72.35
HN24-I	121.78	49.16	72.62	50.05	71.73
HN25-S	125.69	51.85	73.84	52.61	73.08
HN25-I	125.51	51.68	73.83	52.49	73.02
HN25-D	124.82	NA	NA	53.81	71.01
HN26-S	125.00	49.62	75.38	50.49	74.51
HN26-I	124.84	49.98	74.86	50.60	74.24
HN27-S	128.21	52.83	75.38	53.57	74.64
HN27-I	128.59	53.71	74.88	54.50	74.09
HN28-S	122.82	49.24	73.58	50.17	72.65
HN28-I	122.73	49.87	72.86	50.82	71.91
HN29-S	119.04	45.28	73.76	46.28	72.76
HN29-I	116.42	43.59	73.83	44.45	71.97
HN29-D	115.11	NA	NA	44.99	70.12
HN30-S	129.10	54.54	74.56	55.05	74.05
HN30-I	126.27	52.30	73.97	51.46	74.81
USGS	120.84	48.40	72.44	49.27	71.57
GM-6S	134.30	59.76	74.54	60.42	73.88
GM-6I	124.72	55.22	69.50	56.03	68.69
GM-7S	127.51	54.06	73.45	54.99	72.52
GM-7I	127.44	54.44	73.00	55.34	72.10
GM-7D	127.64	55.49	72.15	56.63	71.01
GM-8S	127.19	52.05	75.14	52.89	74.30
GM-8I	127.09	52.45	74.64	53.15	73.94
HN-8D	125.91	NA	NA	54.50	71.41
GM-12S	120.55	48.10	72.45	48.85	71.70
GM-12I	120.51	48.35	72.16	49.18	71.33
GM-13S	115.88	43.21	72.67	44.70	71.18
GM-13I	115.75	43.85	71.90	44.57	71.18
GM-13D	113.97	45.02	68.95	45.96	68.01

NA = Not measured (wells were not yet installed)

The degree of confinement within the Magothy aquifer is reported to generally increase with depth due to stratification and the increasing presence of clay and silt. These finer grained sediments occur in lenses that are laterally discontinuous and individually do not constitute confining layers, but their cumulative effect through a thick vertical sequence is believed to significantly impede groundwater movement (Isbister, 1966; McClymonds and Franke, 1972).

As discussed, the intermediate and deep drilling programs at NWIRP confirm both the regional trend of an increase in silts and clays with depth within the Magothy and the irregular distribution of these lenses. Three intermediate wells (HN-24I, HN-28I, and HN-30I) are screened just below significant clay layers (Figures 3-1 and 3-2). Well 28I may even be considered as screened in a sand lens within a particularly clayey or fine-grained interval. As discussed above, however, the static water level elevations between these intermediate wells and the shallow wells of the same clusters are very similar (0.37 feet, 0.72 feet, and 0.59 feet, respectively), indicating unconfined conditions and hydraulic communication between the sands.

### **3.3.3 Groundwater Flow Characteristics**

#### **3.3.3.1 Horizontal Flow**

Most of Long Island is bisected by an east-west trending, regional groundwater divide. The NWIRP lies to the south of this divide. Groundwater beneath the site flows in a generally southward direction, toward the Atlantic Ocean. Most published data indicate that local groundwater flow is to the south and southeast. Geraghty and Miller, however, in its work plan for the surrounding Grumman complex, reported that recent data from local sources indicate a consistent horizontal flow direction to the south and southwest (Isbister, 1966; G&M, 1990).

The groundwater flow paths beneath the NWIRP and adjacent grounds are illustrated in Figures 3-5, 3-6, 3-7, and 3-8. Flow directions were determined through the static water elevations of the monitoring well network and were calculated for the water table (Figures 3-5 and 3-7) and the intermediate zone (100- to 150-foot depth) of the Magothy Formation (Figure 3-6 and 3-8) for December 1991 and January 1992. The iso-elevation lines were generated via direct interpolation between individual data points.

The groundwater flow dynamics beneath the NWIRP are complex. Seven deep (357 to 560 feet) production wells, each with a capacity of 1200 gpm, are located on the NWIRP (see Table 3-1 and Figure 3-4).

Nine others are located both up- and downgradient of the NWIRP on Grumman property. According to plant personnel, these wells operate on a pressure-controlled, as-needed basis. Therefore, any particular well may be turned on and off at frequent intervals, or may be turned on or off for extended periods. The resultant cones of depression formed by the possible well-usage combinations make local variations in the overall groundwater flow pattern difficult to predict.

The local groundwater flow pattern is also greatly influenced by the recharge basins located on the NWIRP. Here, the groundwater pumped by the facility wells is recharged to the aquifer through the recharge basins. The basins additionally receive storm runoff drainage. This influx of large quantities of water creates a "mounding" or local high, of the water table. The amount of water recharged through these basins is dependent on the amount of water withdrawn by the wells (generally greater in warmer weather) and the amount of precipitation.

The water-table configuration beneath the NWIRP is illustrated in Figures 3-5 and 3-7. The dominant direction of shallow groundwater flow is to the southwest and, to a lesser extent, to the south. Some radial flow from the mounding may introduce a minor component of eastward flow to Site 2 and westward flow to Site 3, but this most likely does not persist for any appreciable distance. The flow beneath Site 1 is dominantly to the southwest and south.

The horizontal gradients across the NWIRP are very low. As would be expected, the highest gradients are located near the recharge basin. The gradient across the site, as measured from well GM-8S in the north to GM-13S in the south, is approximately 5.3 feet per mile. This is much lower than the reported regional gradient of 10 feet per mile (Isbister, 1966).

The average linear velocity of the groundwater at the water table is approximately 0.9 ft/day in the glacial deposits and 0.2 ft/day in the Magothy Formation (Fetter, 1988). These values were calculated using the average hydraulic conductivities reported earlier and an assumed effective porosity of 30 percent. Both average linear velocities are several orders of magnitude lower than the 50 to 70 ft/day predicted in the Initial Assessment Study (RGH, 1986).

The groundwater flow (potentiometric surface) within the Magothy Formation (subsurface depth of 100 to 150 feet) is illustrated in Figures 3-6 and 3-8. The flow at this depth is apparently affected by both the well pumpage and the recharge basins. The groundwater beneath Site 1 and Site 2 flows in a predominantly south- to southwestward direction, similar to the flow at the water table. Groundwater beneath Site 3, however, exhibits a strong westward component due to the apparent effects of pumping at well 8454.



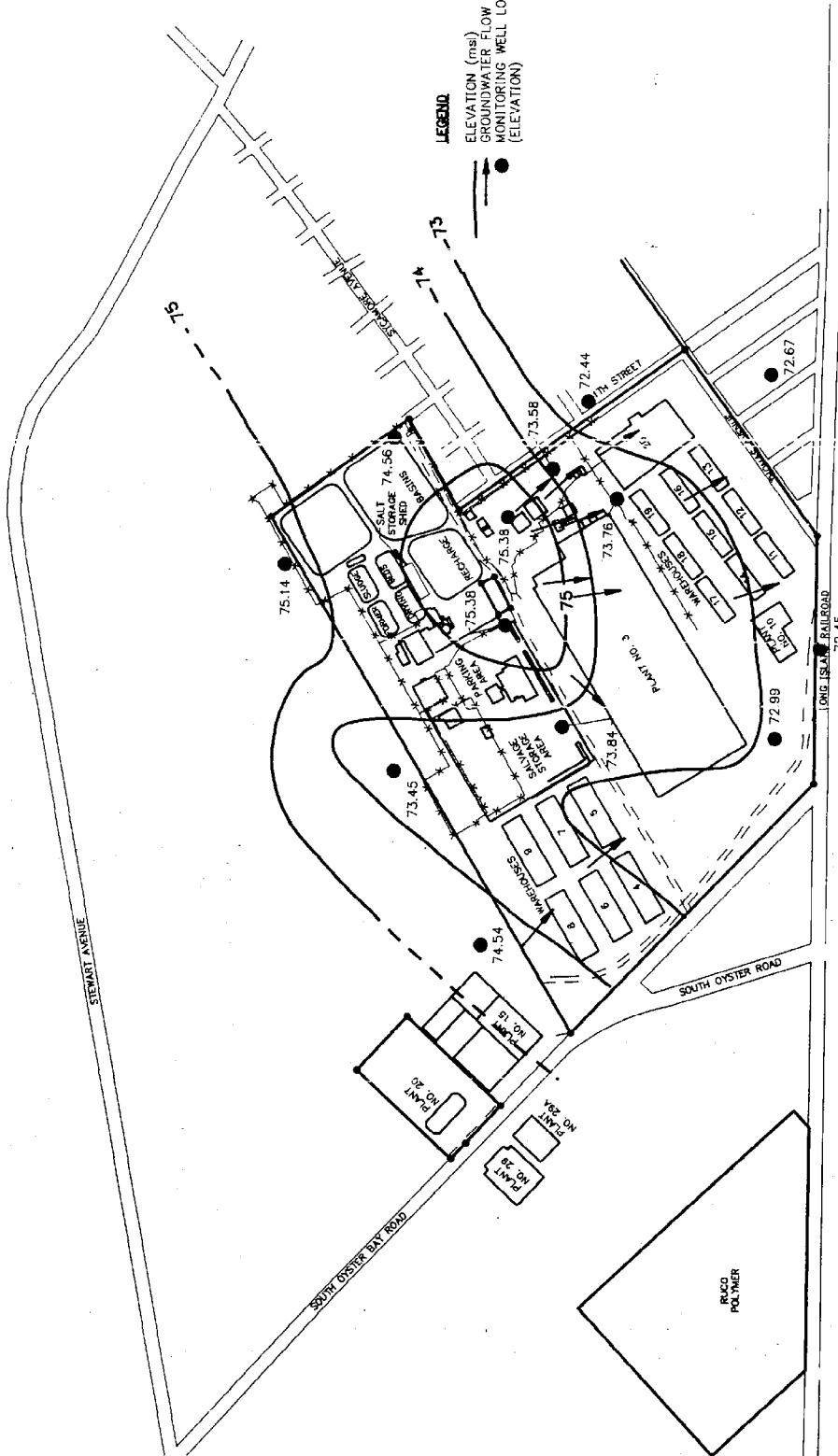
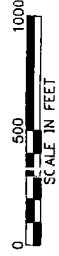

FIGURE 3-5



SHALLOW MAGOTHY AQUIFER (SHALLOW WELLS) DECEMBER 18, 1991  
 REMEDIAL INVESTIGATION  
 NWIRP, BETHPAGE, NY



ACAD 1281\B8AS6.DWG 02/27/82 MB 3-BLANK.LAY

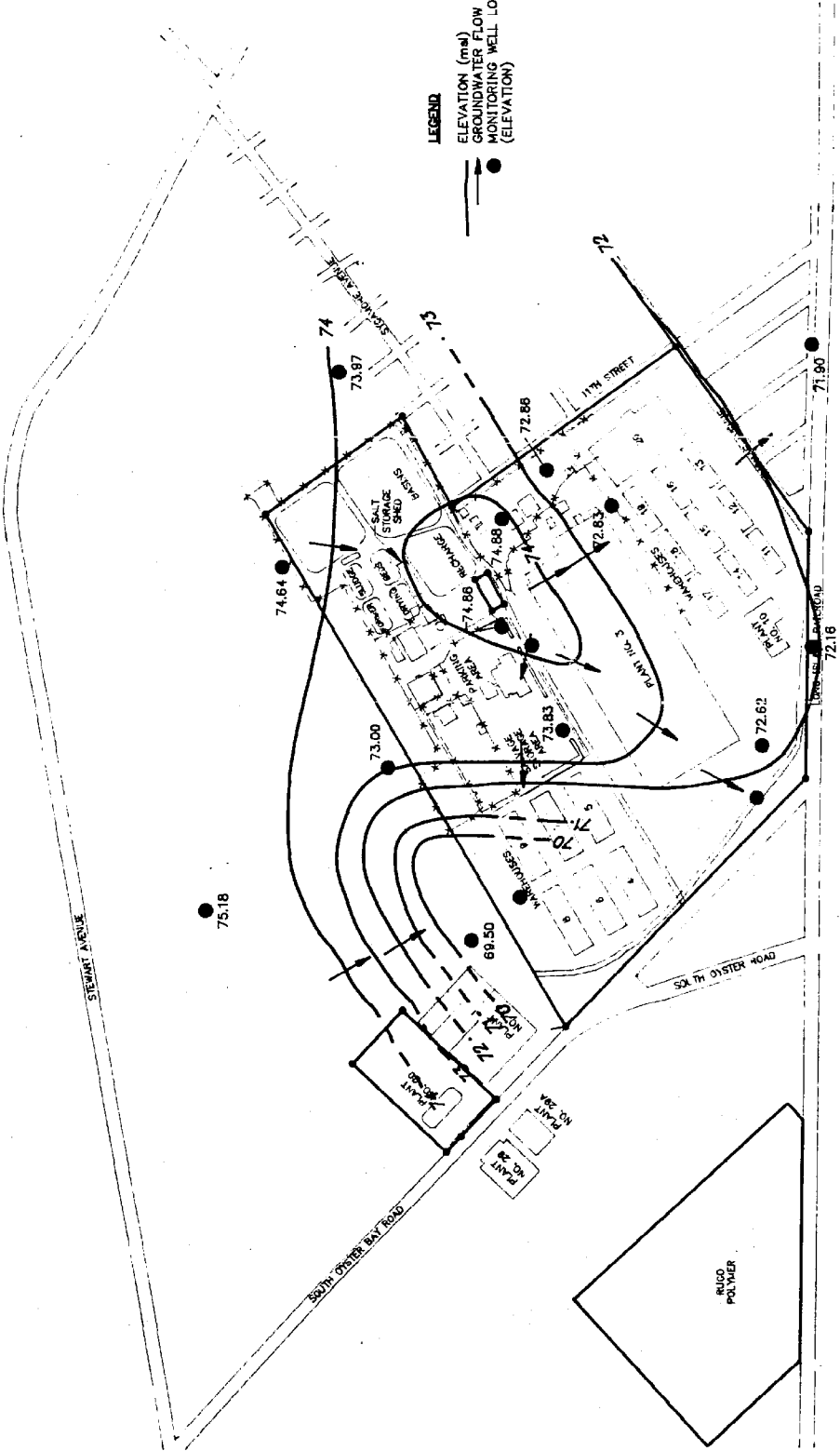

FIGURE 3-6



3-17



MAGOTHY AQUIFER (INTERMEDIATE WELLS) DECEMBER 18, 1991  
 REMEDIAL INVESTIGATION  
 NWIRP, BETHPAGE, NY

ACAD: 3281\984\SE.DWG 08/27/92 MJI 3-BLAY

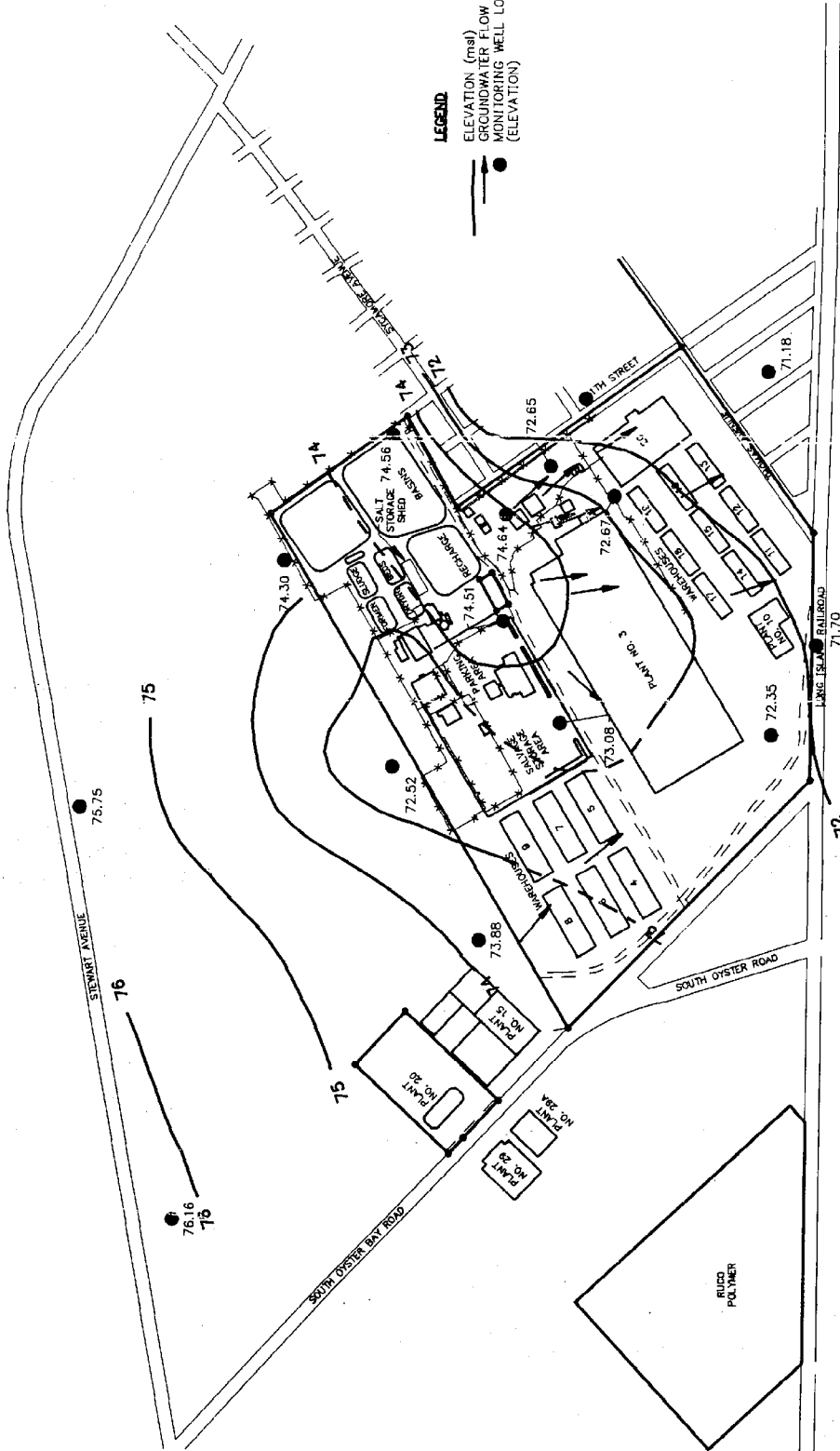
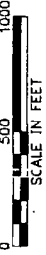

FIGURE 3-7



3-19

SHALLOW MAGOTHY AQUIFER (SHALLOW WELLS) JANUARY 24, 1992  
 REMEDIAL INVESTIGATION  
 NWIRP, BETHPAGE, NY

ACAD: 3281\BASK.OMC 02/27/92 MB 3-7LAV

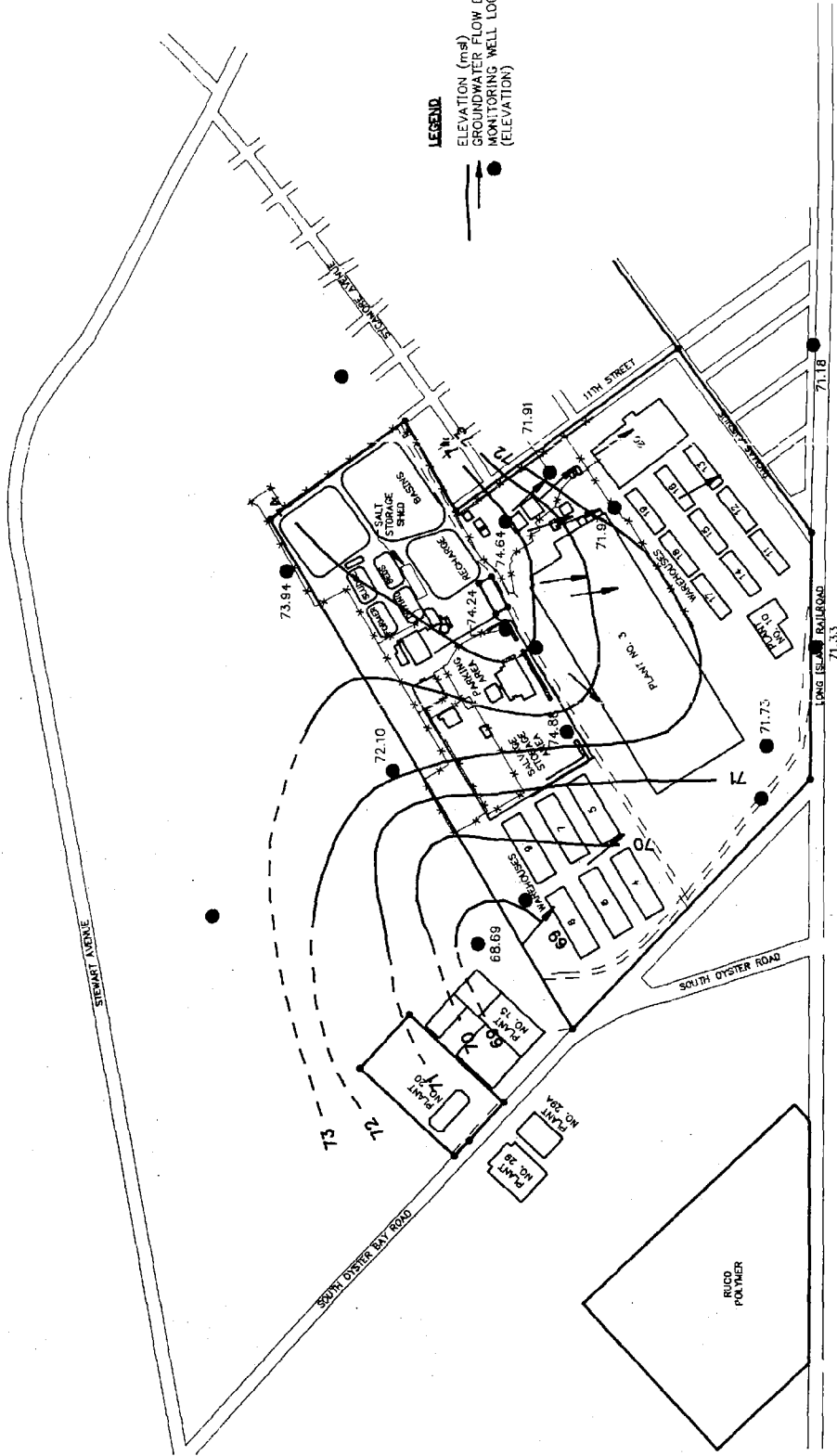
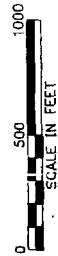

FIGURE 3-8



3-21

**MAGOTHY AQUIFER (INTERMEDIATE WELLS) JANUARY 24, 1992  
REMEDIAL INVESTIGATION  
NWIRP, BETHPAGE, NY**

As discussed, the Grumman facility wells may operate in many possible combinations. Because of this, the groundwater flow directions may vary locally, and any flow analysis can only be considered as representative for that particular time. For instance, neither well no. 7636 nor well no. 7637 was operating on December 18, due to low demand. Had they been pumping, the groundwater beneath Site 3 would have most likely have exhibited a much stronger component of southward, or regionally downgradient, flow.

The horizontal gradients within the Magothy aquifer vary in magnitude across the NWIRP. As evident from Figure 3-6, they are greatest near points of discharge and recharge. The gradient across the site away from these points (as measured from well GM-8I in the north to GM-13I in the south), is approximately 5.3 foot per mile.

#### 3.3.3.2 Vertical Flow

The static water elevations for the well clusters at the NWIRP (Table 3-2) indicate that the activity occupies an area of groundwater recharge. The vertical gradients at each site are in a downward direction, but are very low. As would be expected, the steepest gradients are located near points of recharge or discharge (well cluster GM-6, for example). The low vertical gradients beneath the activity are consistent with the regional pattern as reported in the literature (Isbister, 1966).

1  
2  
3  
4  
5  
6  
7  
8  
9  
10  
11  
12  
13  
14  
15  
16  
17  
18  
19  
20  
21  
22  
23  
24  
25

## 4.0 NATURE AND EXTENT OF CONTAMINATION

The nature and extent of environmental contamination at the Bethpage NWIRP site is discussed in this section. The validated analytical data generated during the 1991 Remedial Investigation provide the basis for this discussion. The complete analytical data base to date is included as Appendix H. The remainder of this section is structured by site and by the types of investigative activities at each site. Section 4.1 presents the results of the investigation at Site 1. Similarly, Section 4.2 and Section 4.3 present the results of the investigations for Sites 2 and 3, respectively.

### 4.1 Former Drum Marshaling Area (Site 1)

#### 4.1.1 Soil-Gas

Soil-gas sampling was done to help define the extent of volatile organic contamination and to assist in the selection of sampling locations. The analysis included the parameters of 1,1-dichloroethene (1,1-DCE), trans-1,2-dichloroethene (t-1,2-DCE), 1,1-dichloroethane (1,1-DCA), cis-1,2-dichloroethene (c-1,2-DCE), 1,1,1-trichloroethane (1,1,1-TCA), trichloroethene (TCE), and tetrachloroethene (PCE). Of these parameters, TCE and PCE were used as indicator chemicals. The concentrations referred to in this section are a sum of these two concentrations. Soil-gas sampling locations and results are presented in Figures 4-1 and 4-2.

Site 1 contained the highest soil-gas readings of the three sites (see Table 4-1 for soil-gas results at Site 1). DCE readings were as high as 728 ug/l in the deep samples and 832 ug/l in the shallow samples. Total TCE+PCE readings were greater than 100 ug/l. The high concentration readings in the shallow samples are located at the former drum marshaling area. This may be a result of surface spills. The high concentrations in the deep samples occur in the former drum marshaling area and downgradient of the former drum marshaling area. This may be due to outgassing of a plume that has migrated downgradient. One interesting result is the relatively "clean" analysis at location 110. This point corresponds to the most contaminated shallow groundwater sampled by either the temporary well points or the permanent monitoring wells. It is hypothesized that the numerous thin, clayey intervals at this location (as observed in the borings) may prevent the upward migration of the gas-phase contaminants.

QA/QC samples are also presented in Table 4-1. Analysis of the field control sample (blank) and laboratory blank results indicated minimal background contamination. The duplicate results were generally within +/- 30%. These results indicate that the data is of relatively good quality.

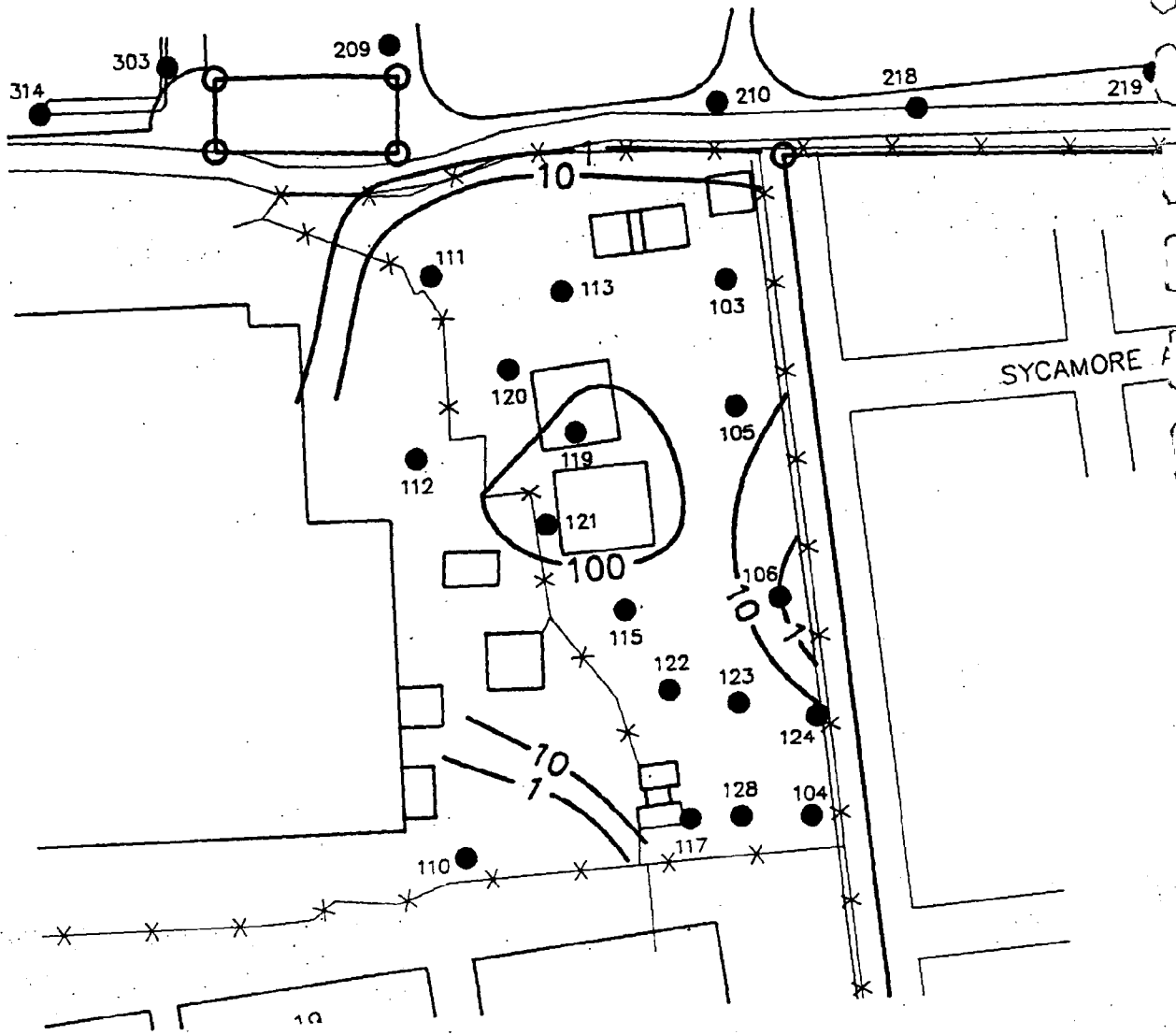

**LEGEND**

● SOIL GAS LOCATIONS

—10— TCE AND PCE (ug/l)

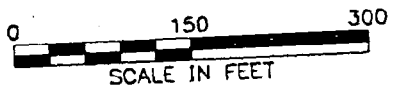
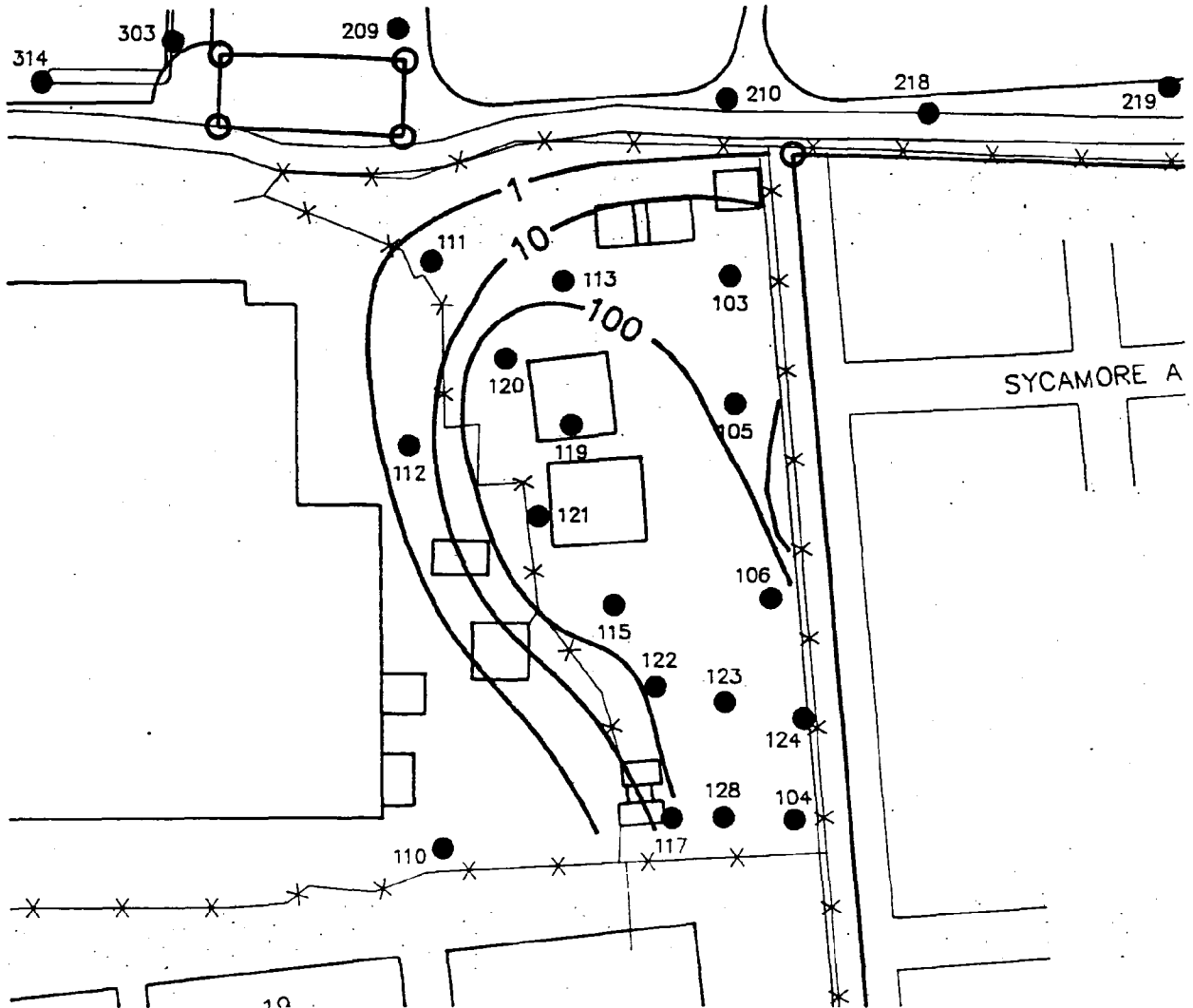

**FIGURE 4-1**

**SOIL GAS RESULTS - SHALLOW  
 REMEDIAL INVESTIGATION  
 NWIRP, BETHPAGE, NEW YORK**







**LEGEND**

● SOIL GAS LOCATIONS

—10— TCE AND PCE (ug/l)

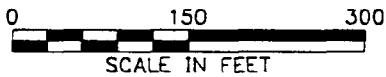

**FIGURE 4-2**

**SOIL GAS RESULTS - DEEP  
REMEDIAL INVESTIGATION  
NWIRP, BETHPAGE, NEW YORK**



TABLE 4-1  
SOIL-GAS RESULTS - SITE 1 (ug/L)  
MWIRP, BETHPAGE, NY

Sample	11DCE	t12DCE	11DCA	c12DCE	111TCA	TCE	PCE
103D	192	<1.0	2.7	1.6	18	15	11
103S	44	<1.0	<1.0	3.6	5.6	13	9.6
104D	7.4	<1.0	3.7	<1.0	89	143	5.7
104S	<1.0	<1.0	<1.0	<1.0	0.31	0.68	<0.05
105D	244	<1.0	<1.0	<1.0	14	9.7	27
105S	187	<1.0	<1.0	<1.0	9.9	7.7	19
106D	<1.0	<1.0	<1.0	<1.0	0.22	1.2	0.12
106S	6.1	<1.0	<1.0	<1.0	1.6	3.5	3.5
110D	3.6	<1.0	<1.0	<1.0	0.11	<0.10	0.78
110S	<1.0	<1.0	<1.0	<1.0	<1.0	<0.10	0.65
111D	59	<1.0	<1.0	<1.0	6.4	6.7	3.6
111S	125	<1.0	<1.0	<1.0	8.8	7.8	1.9
112D	85	<1.0	1.7	<1.0	9.0	4.9	6.7
112S	61	<1.0	<1.0	<1.0	9.4	3.7	9.4
113D	174	<1.0	<1.0	<1.0	15	11	16
113S	131	<1.0	<1.0	<1.0	8.3	15	12
115D*	80	<1.0	2.4	4.4	8.8	18	<0.05
115S	20	<1.0	<1.0	<1.0	9.5	14	70
117D	14	<1.0	<1.0	<1.0	26	40	21
117S	7.4	<1.0	<1.0	<1.0	10	18	14
119D	165	<1.0	3.1	26	24	21	70
119S	626	<1.0	6.9	37	70	63	138
120D	728	<1.0	18	16	107	45	174
120S	832	<1.0	30	48	122	68	479
121D	558	<1.0	19	50	101	96	617
121S	568	<1.0	21	48	125	159	765
122D	46	<1.0	<1.0	<1.0	19	19	77
122S	8.6	<1.0	<1.0	<1.0	6.4	17	35
123D	11	<1.0	3.9	<1.0	78	139	19
123S	4.9	<1.0	<1.0	<1.0	39	56	14
124D	11	<1.0	<1.0	<1.0	13	16	20
124S	2.7	<1.0	<1.0	<1.0	2.4	1.2	4.8

TABLE 4-1  
SOIL-GAS RESULTS - SITE 1 (ug/L)  
PAGE TWO

Sample	11DCE	t12DCE	11DCA	c12DCE	111TCA	TCE	PCE
<b>FIELD CONTROL SAMPLES</b>							
101	<1.0	<1.0	<1.0	<1.0	<0.10	<0.10	<0.05
102	<1.0	<1.0	<1.0	<1.0	<0.10	0.14	<0.05
107	<1.0	<1.0	<1.0	<1.0	<0.10	0.11	<0.05
108	<1.0	<1.0	<1.0	<1.0	<0.10	<0.10	<0.05
109	<1.0	<1.0	<1.0	<1.0	<0.10	<0.10	<0.05
114	<1.0	<1.0	<1.0	<1.0	<0.10	<0.1	0.09
125	<1.0	<1.0	<1.0	<1.0	<0.10	<0.10	0.40
<b>LABORATORY DUPLICATE ANALYSES</b>							
106D	<1.0	<1.0	<1.0	<1.0	0.22	1.2	0.12
106DR	<1.0	<1.0	<1.0	<1.0	0.20	1.3	0.13
110D	3.6	<1.0	<1.0	<1.0	0.11	<0.10	0.78
110DR	3.1	<1.0	<1.0	<1.0	<0.10	<0.10	0.67
113D	174	<1.0	<1.0	<1.0	15	11	16
113DR	165	<1.0	<1.0	<1.0	14	7.4	15
<b>LABORATORY BLANKS</b>							
106DB	<1.0	<1.0	<1.0	<1.0	<0.10	<0.10	<0.05
110DB	<1.0	<1.0	<1.0	<1.0	<0.10	<0.10	<0.05
113DB	<1.0	<1.0	<1.0	<1.0	<0.10	<0.10	<0.05

\* = SAMPLES MAY CONTAIN HIGHER CONCENTRATIONS OF 111TCA, TCE, AND/OR PCE

11DCE = 1,1-dichloroethene  
t12DCE = trans-1,2-dichloroethene  
11DCA = 1,1-dichloroethane  
c12DCE = cis-1,2-dichloroethene  
111TCA = 1,1,1-trichloroethane  
TCE = trichloroethene  
PCE = tetrachloroethene

S = Shallow  
D = Deep

#### 4.1.2 Temporary Monitoring Wells

Ten temporary wells at Site 1 were sampled and analyzed for volatile organics including vinyl chloride, 1,1-DCE, t-1,2-DCE, 1,1-DCA, c-1,2-DCE, 1,1,1-TCA, 1,2-dichloroethane (1,2-DCA), TCE, and PCE. The locations of the temporary monitoring wells are presented in Figure 2-2. A summary of the organic contaminants detected at Site 1 is provided in Table 4-2.

As evidenced on the above-referenced table, groundwater at Site 1 had the highest concentration readings and greatest number of contaminants detected in temporary wells at the NWIRP. Site 1 also contained the two most contaminated wells: G-110 (located downgradient of the Site 1), and G-121 (located in the middle of the site). PCE was present at a maximum concentration of 7,700 ug/l in temporary well G-121. It was also found at concentrations greater than 700 ug/l in temporary wells located in the former drum marshaling area and in the downgradient direction. TCE was present at a maximum concentration of 1,900 ug/l in well G-123. It was also found at concentrations greater than 100 ug/l in temporary wells located in the former drum marshaling area and in the downgradient direction. 1,1,1-TCA was present at a maximum concentration of 5,400 ug/l in temporary well G-110. It was also present at concentrations greater than 100 ug/l in the former drum marshaling area and in the downgradient direction. c-1,2-DCE was present at a maximum concentration of 1,600 ug/L in well G-110. It was also present at concentrations greater than 100 ug/l in temporary wells located in the source area. 1,1-DCA was present at a maximum concentration of 630 ug/l in temporary well G-110. It was also present at concentrations of greater than 100 ug/l in the former drum marshaling area and in the downgradient direction. 1,1-DCE was present at a maximum concentration of 100 ug/l at temporary well G-110. It was also found in lesser concentrations in the former drum marshaling area and in the downgradient direction.

#### 4.1.3 Subsurface Soils

Subsurface soil sample locations are presented in Figure 2-3. Table 4-3 presents the distribution of organic chemicals in subsurface soil. Low-level volatile organic chemicals (VOCs), especially TCE and PCE, were detected. Figures 4-3, 4-4, and 4-5 illustrate the subsurface distribution of detections of TCE, PCE, and 1,1,1-TCA. For the 3-foot depths of SB-113, SB-119, and SB-121, PCE was detected at 25 ug/kg, up to 4,800 ug/kg, and up to 26 ug/kg, respectively; it was also detected at 12 ug/kg at the 19-foot depth of SB-119. TCE at the 3-foot depth of SB-119 was detected at 200 ug/kg. Sample SB-119 was located in former drum marshaling area no. 2. In general, concentrations of compounds in samples obtained at 19 feet were not significantly greater than concentrations at 3 feet. There appears to be overall trace to low-level chlorinated ethene contamination at Site 1.

TABLE 4-2

TEMPORARY MONITORING WELL RESULTS (ug/l) - SITE 1  
NWIRP, BETHPAGE, NY

Temporary Well No.	VC	11DCE	t12DCE	11DCA	c12DCE	111TCA	112DCA	TCE	PCE
103	5U	5U	5U	5U	5U	5U	5U	28	5U
104	5U	5U	5U	5U	5U	94	5U	370	18
110	25U	25U	25	630	1600	5400	25U	950	5200
111	5U	5U	5U	5U	5U	5U	5U	5U	5U
112	5U	5U	5U	5U	5U	12	5U	10	5U
113	5U	5U	5U	5U	5U	8	5U	9	8
115	5U	5U	5U	43	150	180	5U	260	2000
119	5U	5U	5U	22	85	240	5U	280	1100
121	25U	25U	25U	110	540	110c	25U	1800	7700
123	5U	7	5U	22	48	200	5U	1900	780

U - Undetected

11DCE = 1,1-dichloroethene

t12DCE = trans-1,2-dichloroethene

11DCA = 1,1-dichloroethane

c12DCE = cis-1,2-dichloroethene

111TCA = 1,1,1-trichloroethane

TCE = trichloroethene

PCE = tetrachloroethene

VC = vinyl chloride

TABLE 4-3

OCURRENCE AND DISTRIBUTION OF SUBSURFACE SOIL CONTAMINANTS  
 SITE 1 - ORGANIC (ug/kg)  
 HWIRP, BETHPAGE, NY

Compound	CRQL	Number Positive Detections/ Samples Analyzed	Location of Maximum Concentration	Maximum Positive Concentration	Representative Concentration*
Trichloroethene	5	2/18	SB119	200J	36.5
Tetrachloroethene	5	16/18	SB119	4800J	834
1,2-Dichloroethene	5	1/18	SB119	6	3.1
1,1,1-Trichloroethane	5	1/18	SB119	72	14.5
Di-n-butyl phthalate	330	2/9	SB112	16J	16
Butyl benzyl phthalate	330	1/9		97.5	97.5
TIC PCBs	-	1/9	SB121	P	

Background soil concentrations are provided in Table 4-4.

\* Upper 95% confidence limit (UCL) on arithmetic average, or maximum if UCL exceeds maximum detected.

- = Not Detected

CRQL = Contract Required Quantitation Limit

P = Present

ACAD: 3281\SITE1.DWG  
 02/29/92  
 MB 4-3.LAY

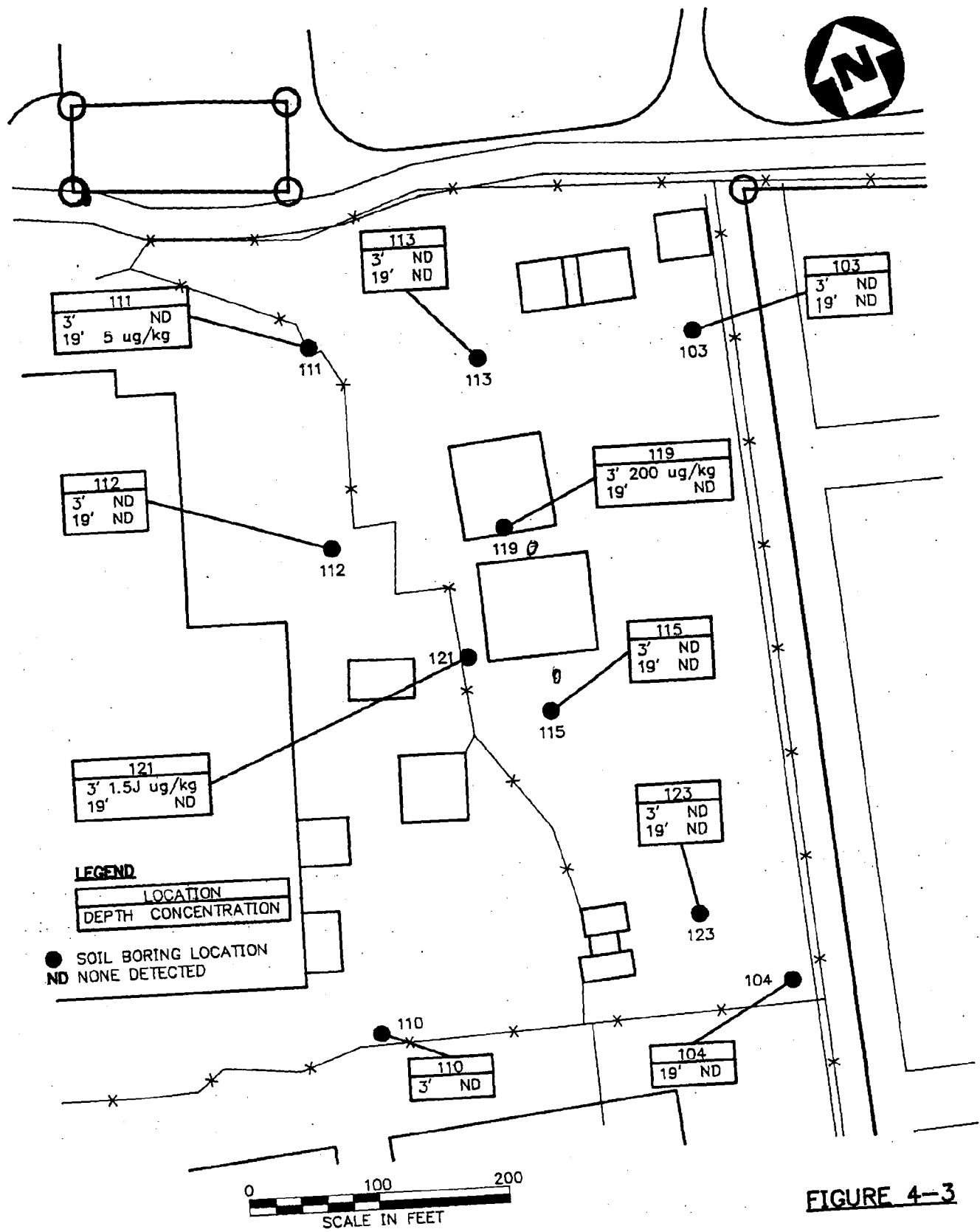

FIGURE 4-3

**SITE 1 - SUBSURFACE SOIL RESULTS - TCE**  
**REMEDIAL INVESTIGATION**  
**NWIRP, BETHPAGE, NY**

4-9



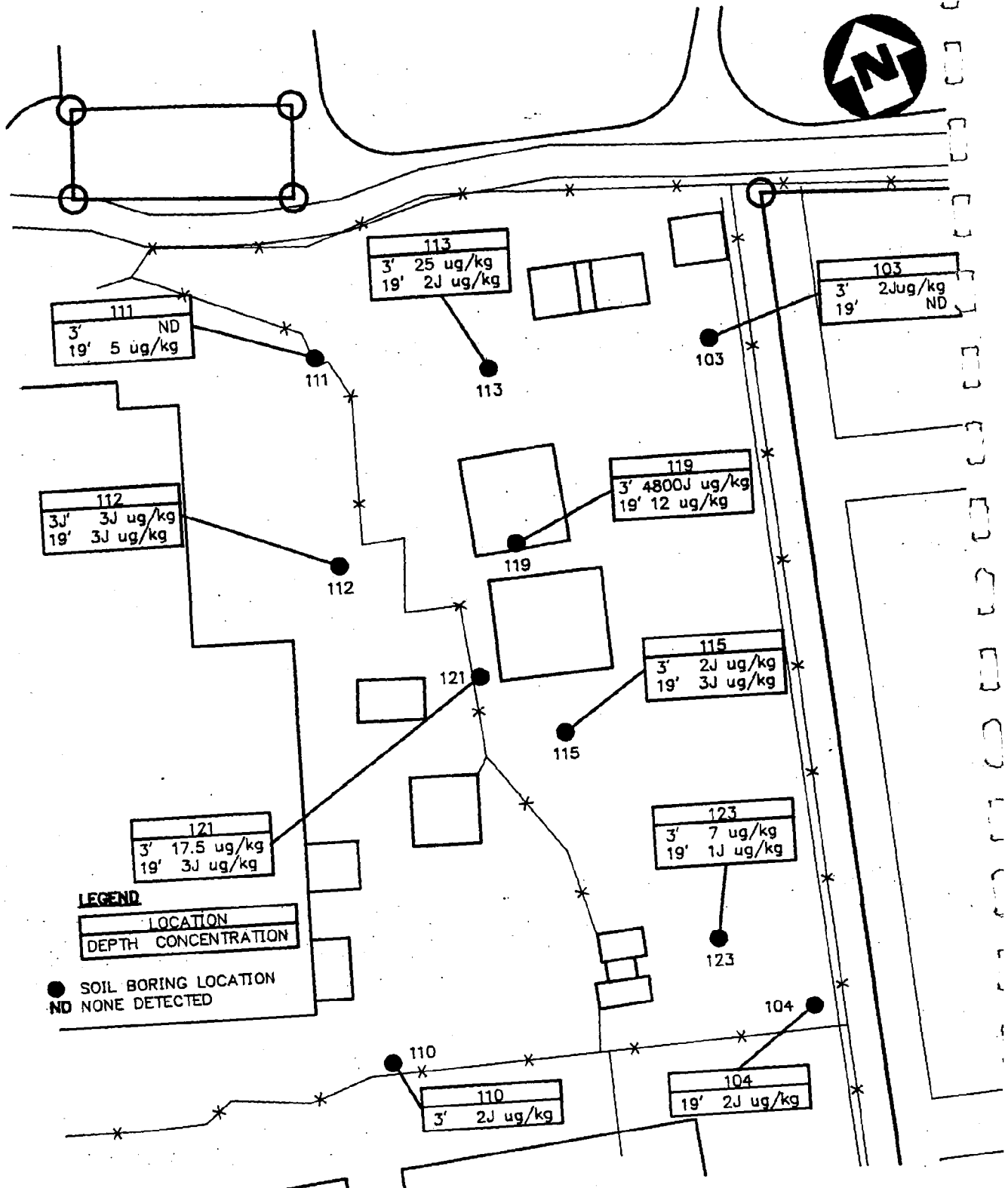

FIGURE 4-4

**SITE 1 - SUBSURFACE SOIL RESULTS - PCE  
 REMEDIAL INVESTIGATION  
 NWIRP, BETHPAGE, NY 4-10**



**HALLIBURTON NU**  
 Environmental Corporation



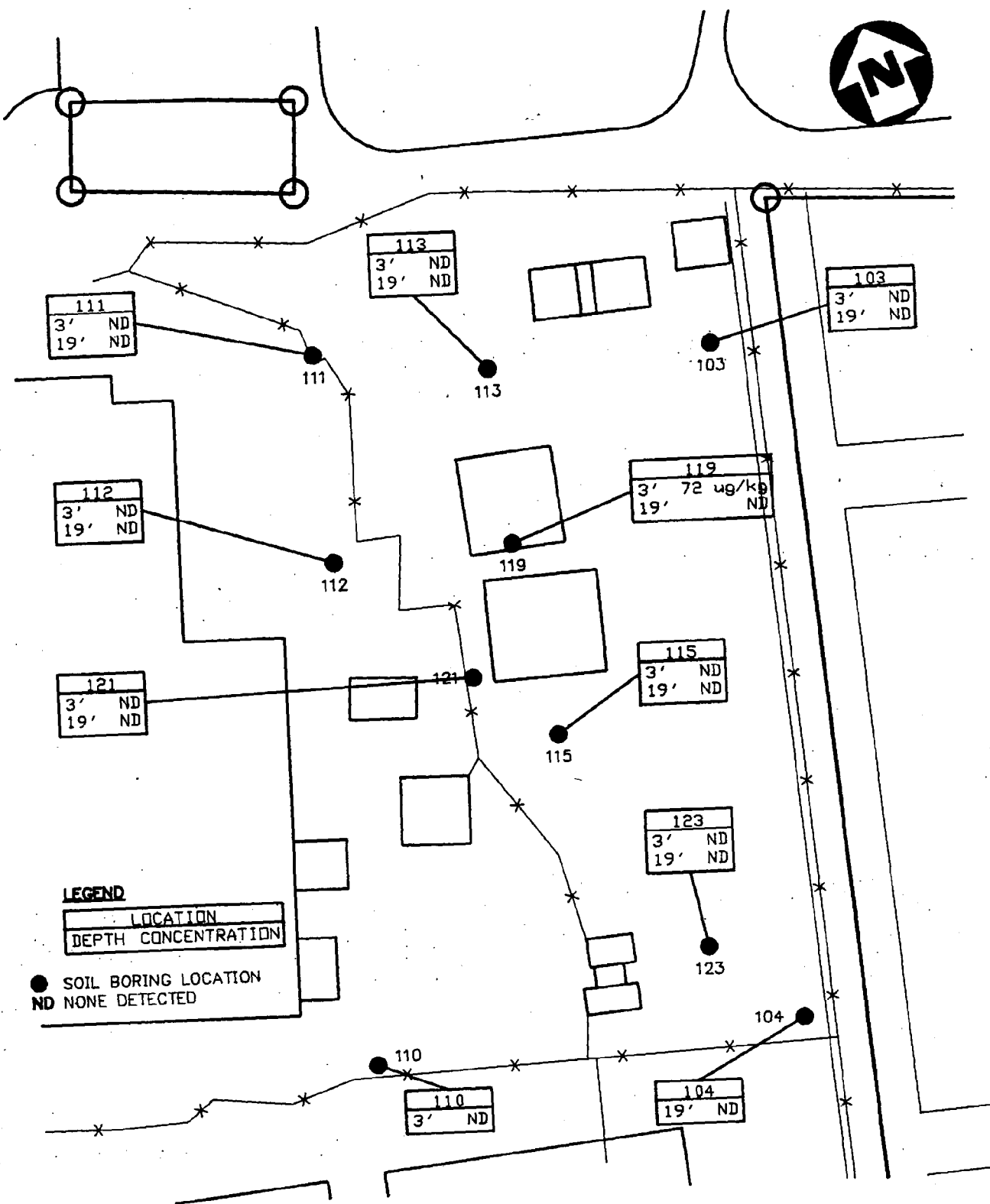

**LEGEND**

● SOIL BORING LOCATION  
 ND NONE DETECTED

LOCATION	DEPTH	CONCENTRATION
[Symbol]	3'	ND
[Symbol]	19'	ND

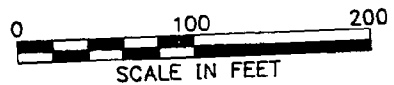

**FIGURE 4-5**

**SITE 1 - SUBSURFACE SOIL RESULTS - 1.1.1-TCA**  
**REMEDIAL INVESTIGATION**  
**NWIRP, BETHPAGE, NY**



**HALLIBURTON NUS**  
 Environmental Corporation

4-11

ACAD: 3281\SITE1.DWG  
 02/27/92  
 MB 4-5.LAY

PCBs were tentatively identified at one location at Site 1 (121, 3-foot depth). Phthalate, which are plasticizers and are also common environmental contaminants as well as common blank contaminants, were detected at low concentrations at one location at Site 1. PCBs as TICs are used mainly on a confirmation basis. TICs are not appropriate for quantitative risk assessment because their identities and quantities are uncertain (quantities may vary by an order of magnitude). Those PCBs and phthalate that were confidently identified are addressed quantitatively in Section 6.0. The TOX profiles in Appendix I contain quantitative information about the toxicity of PCBs and phthalate.

Chlorinated solvents were detected at trace levels in background soil samples (See Table 4-4). PAHs were also detected in background soil samples, up to approximately 7000 ug/kg.

Since inorganic parameters are commonly found in most soils, typically a background concentration for each chemical is determined. Table 4-5 presents the results of background (subsurface) soil inorganic analyses. All background samples were located north (upgradient) of the three sites. The mean, standard deviation, and maximum results for each element are shown. Also shown is the 95% upper confidence limit ["B", which equals mean + (1.645) (standard deviation)]. The maximum and B values are then compared to onsite inorganic soil results. Results rejected during data validation were not used. These comparisons will be used in Section 6.0 in the selection of the chemicals of concern.

Table 4-6 displays inorganic analytical results for subsurface soil at Site 1. The highest-concentration sample in Site 1 was one of a field duplicate pair at SB-121; this was located roughly in the center of Site 1, southwest of the former drum marshaling areas. However, the high arsenic result and the high result for cyanide in SB-119 are also notable. SB-119 is located at drum marshaling area No. 2.

#### 4.1.4 Groundwater Data

The monitoring well sample locations are displayed on Figure 2-5. For Site 1, monitoring HN-27 and, to a limited extent, HN-26 served as the upgradient monitoring wells. Monitoring well HN-28, HN-29, and, to an extent, the USGS well served as downgradient monitoring wells. The results of the organic analyses of monitoring wells are presented in Table 4-7. Groundwater contamination by the VOCs TCE, 1,1,1-TCA, and PCE is illustrated in Figures 4-6, 4-7, and 4-8 for shallow-screened wells and in Figures 4-9, 4-10, and 4-11 for wells screened at intermediate depths. The isoconcentration lines were generated via direct interpolation between individual data points. The distribution of organic contaminants detected above maximum contaminant levels (MCLs) is displayed on Figures 4-12 and 4-13.

TABLE 4-4

BACKGROUND SOIL CONTAMINANTS - ORGANIC (ug/kg)  
MWIRP, BETHPAGE, NY

Chemical	CRQL	SB202	SB204	SB205	SB329
Trichloroethene	5		1J		
1,1,2-Trichloroethane (TIC)	-		P	P	
Tetrachloroethene	5				4J
Carbon disulfide	5				1J
Phenanthrene	350				1030
Fluoranthene	350				1060
Pyrene	350				1000
Benzo[b]fluoranthene	350				450
Benzo[k]fluoranthene	350				410
Benzo[a]pyrene	350				540
Indeno[1,2,3,-c,d]pyrene	350				340J
Benzo[g,h,i]perylene	350				300J
Benzo[a]anthracene	350				510
Chrysene	350				510
Acenaphthene	350				270J
Naphthalene	350				61J
Dibenzofuran	350				68J
Fluorene	350				160J
Anthracene	350				230J
PAH (TIC)	-				P

PAH = Polynuclear aromatic hydrocarbon  
TIC = Tentatively identified compound  
\* = A blank indicates that the compound was not detected  
CRQL = Contract Required Quantitation Limit  
J = Estimated  
P = Present

TABLE 4-5  
BACKGROUND SUBSURFACE SOIL RESULTS - INORGANICS (mg/kg)  
HWIRP, BETHPAGE, NY

Element	CRDL	IDL	SR202	SR204	SR205	SR329	MEAN	STD	B	MAX
Aluminum	40	36.2	6350	9370	2900	10100	7180	3269	12558	10100
Antimony	12	2.9/4.9	-	-	-	<5.5	NC	NC	NC	<5.5
Arsenic	2	0.78	1.5J	2.9J	3J	2.6	2.5	0.68	3.6	3
Barium	40	1.7	14.9	29.9	6.2	22.6	18.4	10.13	35.1	29.9
Beryllium	1	0.76	<0.8	<0.84	<0.98	-	NC	NC	NC	<0.98
Cadmium	1	0.94	<0.99	<1.0	<1.2	<1.1	NC	NC	NC	<1.20
Calcium	1000	58.2	80.1	32*	37.35*	583	183	266	621	583
Chromium	2	2.1	-	-	-	12.7J	NC	NC	NC	12.7
Cobalt	10	4.4	-	-	<5.6	<4.9	NC	NC	NC	<5.6
Iron	20	7.0	-	-	-	11400	NC	NC	NC	11400
Lead	0.6	0.38/0.44	-	-	-	7.8	NC	NC	NC	7.8
Magnesium	1000	27.4	1030	1560	522	1080	1048	423	1743	1560
Manganese	3	1.0	-	-	-	167J	NC	NC	NC	167
Mercury	0.1	0.10	0.05*	0.055*	0.14	0.055*	0.075	0.04	0.15	0.14
Nickel	8	4.8	<5.0	-	<6.2	<5.4	NC	NC	NC	<6.2
Potassium	1000	72.0	478	644	503	353	494	119	690	644
Selenium	1	1.0	<1.0	<1.1	<1.3	<0.56	NC	NC	NC	<1.30
Silver	2	0.18/0.24	<0.25	<0.26	<0.31	<0.2	NC	NC	NC	<0.31
Sodium	100	48.0	-	-	-	190	NC	NC	NC	190
Thallium	2	0.64	<0.67	<0.7	<0.82	<0.72	NC	NC	NC	<0.82
Vanadium	10	3.7	-	-	-	17.9J	NC	NC	NC	17.9
Zinc	4	3.1	-	-	-	20	NC	NC	NC	20
Cyanide	2	2.0	<2.1	<2.2	<2.6	<2.25	NC	NC	NC	<2.60

MEAN = Arithmetic mean  
 STD = Standard deviation, with n-1 samples  
 MAX = Maximum reported background  
 B = 95% Upper Confidence Limit [(MEAN + (1.645) \* (STD))  
 NC = Not calculated  
 CRDL = Contract Required Detection Limit  
 \* Reported number is 1/2 detection limit; used for non-detects when at least one other reported result is positively detected.  
 IDL = Instrument Detection Limit

TABLE 4-6

**OCCURRENCE AND DISTRIBUTION OF SUBSURFACE SOIL CONTAMINANTS  
SITE 1 - INORGANIC (mg/kg)  
MWIRP, BETHPAGE, NY**

Element	CRDL	IDL	Number Positive Detections/ Samples Analyzed	Location of Maximum Concentration	Concentration Range	Representative Concentration*
Aluminum	40	36.2	9/9	SB112	1010-11429J	6832
Antimony	12	4.9	1/9	SB119	ND-9.8J	5.2
Arsenic	2	0.78	8/9	SB119	ND-3380	1244
Barium	40	1.7	9/9	SB112	4.1-30.73	17.6
Cadmium	1	0.94	2/9	SB103	ND-4.5	2.0
Chromium	2	2.1	9/9	SB112	2.7-10.94J	9.5
Cobalt	10	4.4	1/9	SB112	ND-4.3	3.0
Copper	5	1.7	3/3	SB112	3.1-7.9	7.9
Iron	20	7.0	9/9	SN112	2210-12913	8400
Lead	0.6	0.38	9/9	SB112	1J-5.4J	4.5
Manganese	3	1.0	9/9	SB111	15.1J-167J	126
Mercury	0.1	0.10	1/9	SB112	ND-0.108	0.07
Nickel	8	4.8	2/9	SB112	ND-6.0	4.3
Vanadium	10	3.7	7/9	SB112	ND-17.9	11.8
Zinc	4	3.1	6/6	SB123	8.8-17.9	14.5
Cyanide	2	2.0	2/9	SB119	ND-13.3	6.0
Thallium	2	0.64	1/9	SB112	ND-0.54	0.54

Background soil concentrations are provided in Table 4-5.

\* Upper 95% confidence limit (UCL) on arithmetic average, or maximum if UCL exceeds maximum detected.

ND = Not Detected

CRDL = Contract Required Detection Limit

IDL = Instrument Detection Limit

J = Estimated Value

TABLE 4-7

POSITIVE DETECTIONS OF ORGANIC GROUNDWATER CONTAMINANTS  
 SITE 1 (UG/1)  
 MWIRP, BETHPAGE, NEW YORK

Chemical	CRQL	HM-27S (Upgrad)	HM-26S	HM-26SD (DUP HM26S)	HM-29S	USGS	HM-27I (Upgrad)	HM-28I	HM-29I	HM-29D
Trichloroethene	5	16	1100	1100	780	12	13	9	6	11
Toluene	10				39					
1,1-Dichloroethane	5		29	32	880					4J
1,2-Dichloroethane	5		160	180	3600					7
1,1,1-Trichloroethane	5	8	220	240	10000	4J	3J		2J	48
Tetrachloroethene	5	10	430	360	250	11	2J	2J	2J	10
1,1-Dichloroethene	5		9	10	250					2J
Ethylbenzene	5				3J					
Xylenes	5				19					
Di-n-octylphthalate	10							17		
2-Methylphenol	10				2J					
4-Methylphenol	10				2J					
2,4-Dimethylphenol	10				7J					
Naphthalene	10				3J					
Acenaphthylene	10				1J					
Fluoranthene	10					2J				
Benzo(b)fluoranthene	10					2J				
Pyrene	10					2J				

J = Estimated  
 CRQL = Contract Required Quantitation Limit

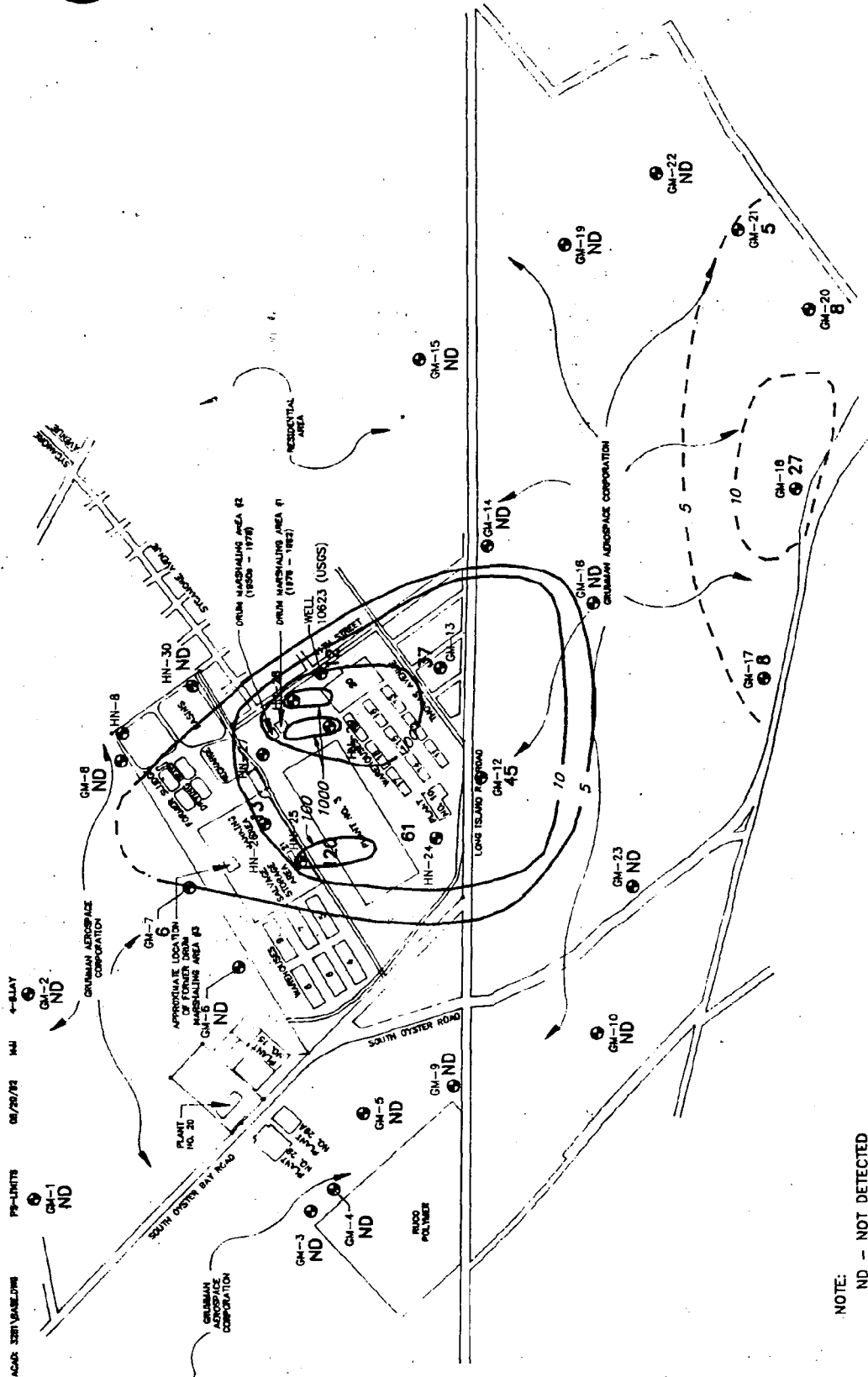

NOTE:  
ND - NOT DETECTED

FIGURE 4-6

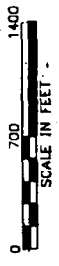

GROUNDWATER SHALLOW ISOCONCENTRATION CONTOURS - TCE (ug/l)  
REMEDIAL INVESTIGATION  
NWIRP, BETHPAGE, NEW YORK

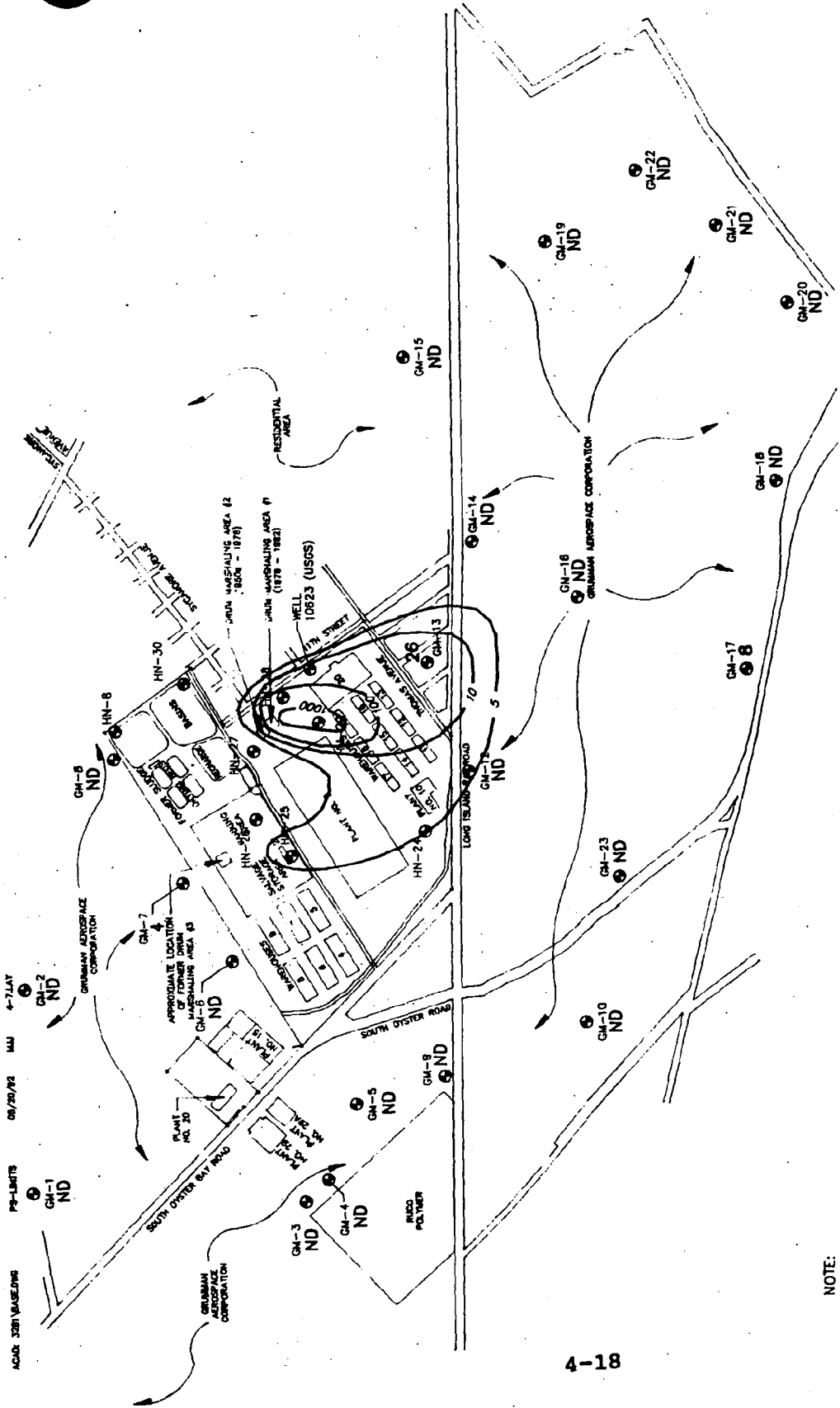

FIGURE 4-7



**GROUNDWATER SHALLOW ISOCONCENTRATION CONTOURS - 1,1,1-ICA (ug/l)**  
**REMEDIAL INVESTIGATION**  
**NWIRP, BETHPAGE, NEW YORK**

NOTE:  
 ND - NOT DETECTED



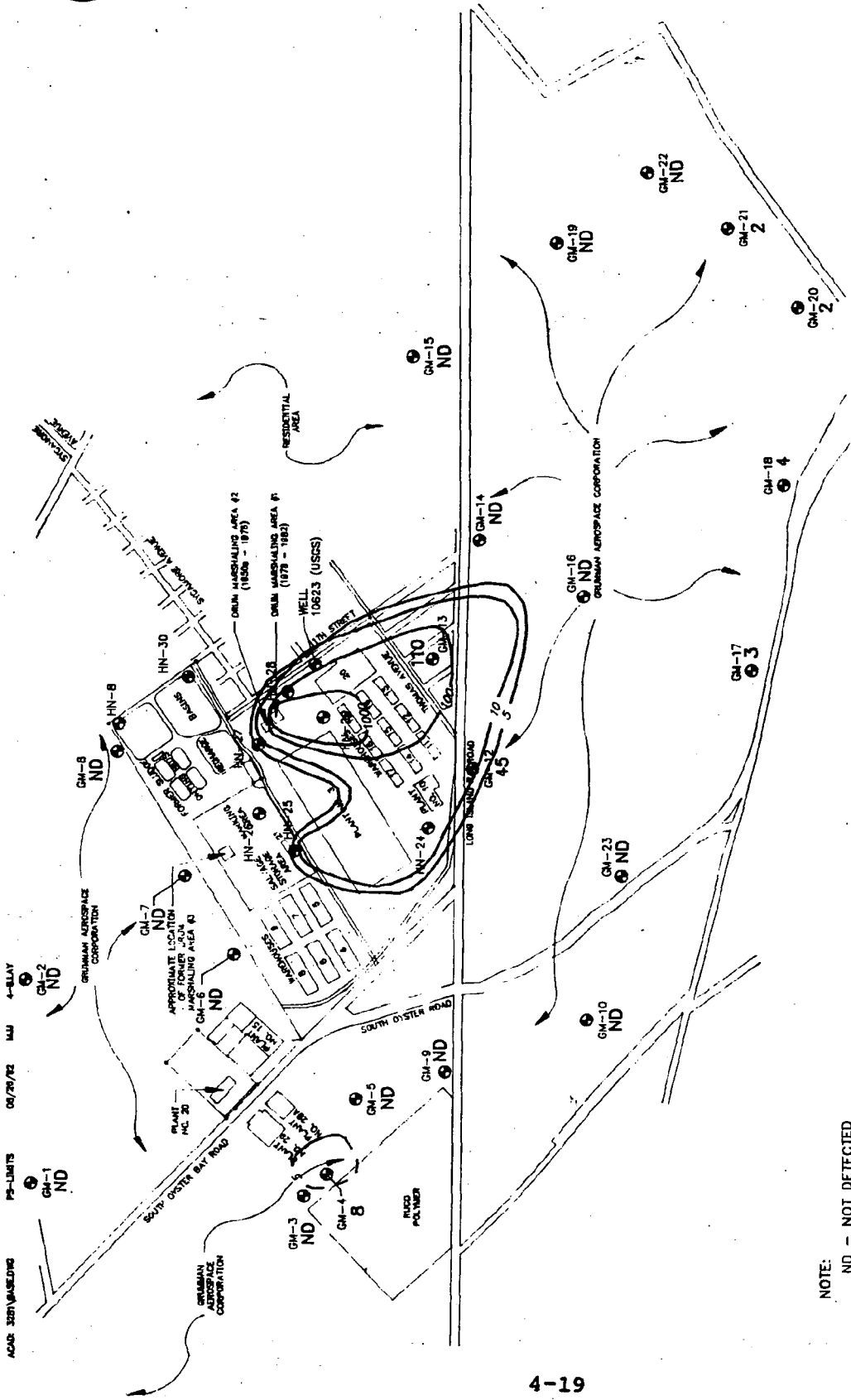

NOTE:  
ND - NOT DETECTED

**GROUNDWATER SHALLOW ISOCONCENTRATION CONTOURS - PCE (ug/l)**  
**REMEDIAL INVESTIGATION**  
**NWRR, BETHPAGE, NEW YORK**

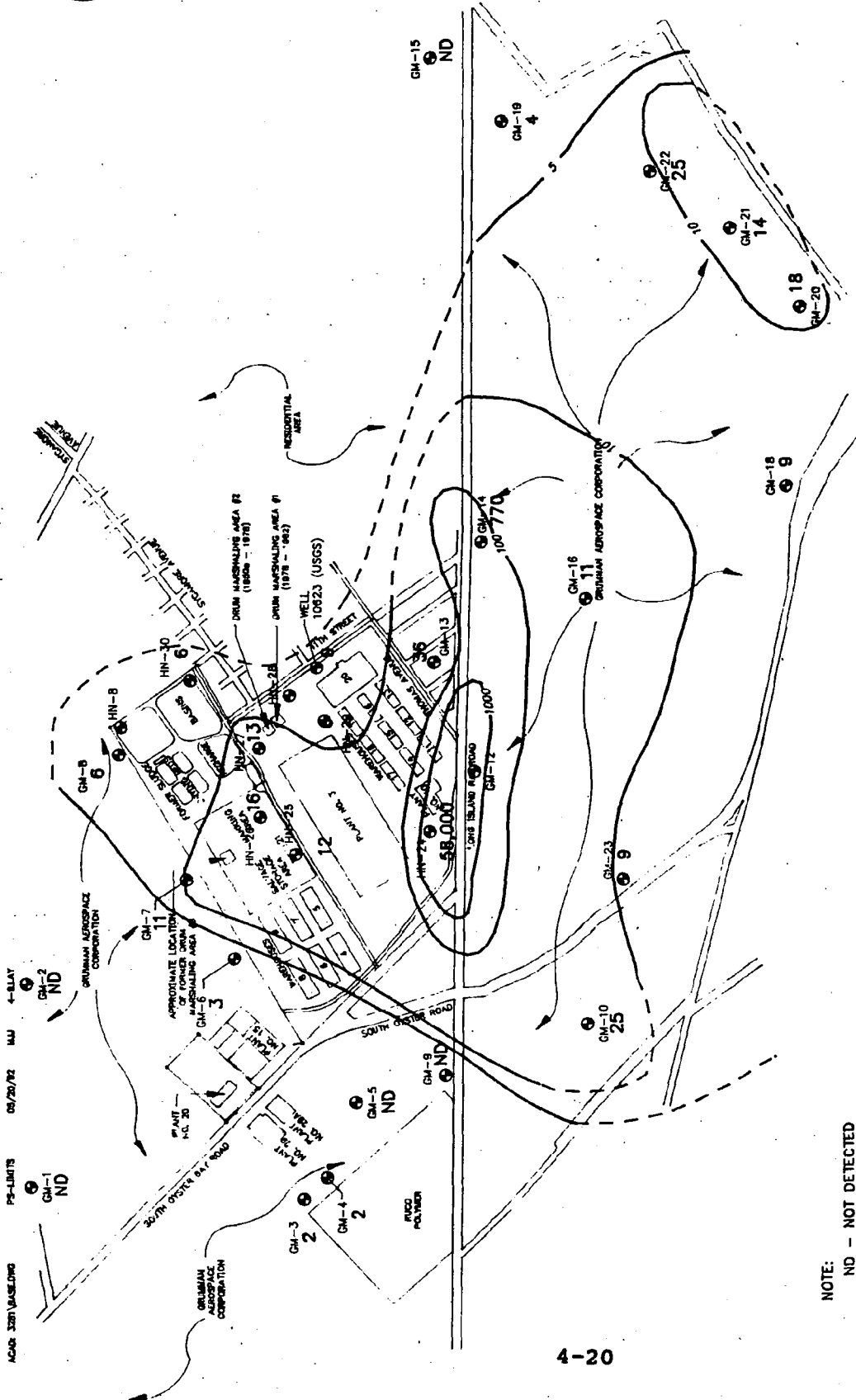

**GROUNDWATER INTERMEDIATE ISOCONCENTRATION CONTOURS - ICE (ug/l)**  
**REMEDIAL INVESTIGATION**  
**NWIRP, BEITHPAGE, NEW YORK**

NOTE:  
 ND - NOT DETECTED

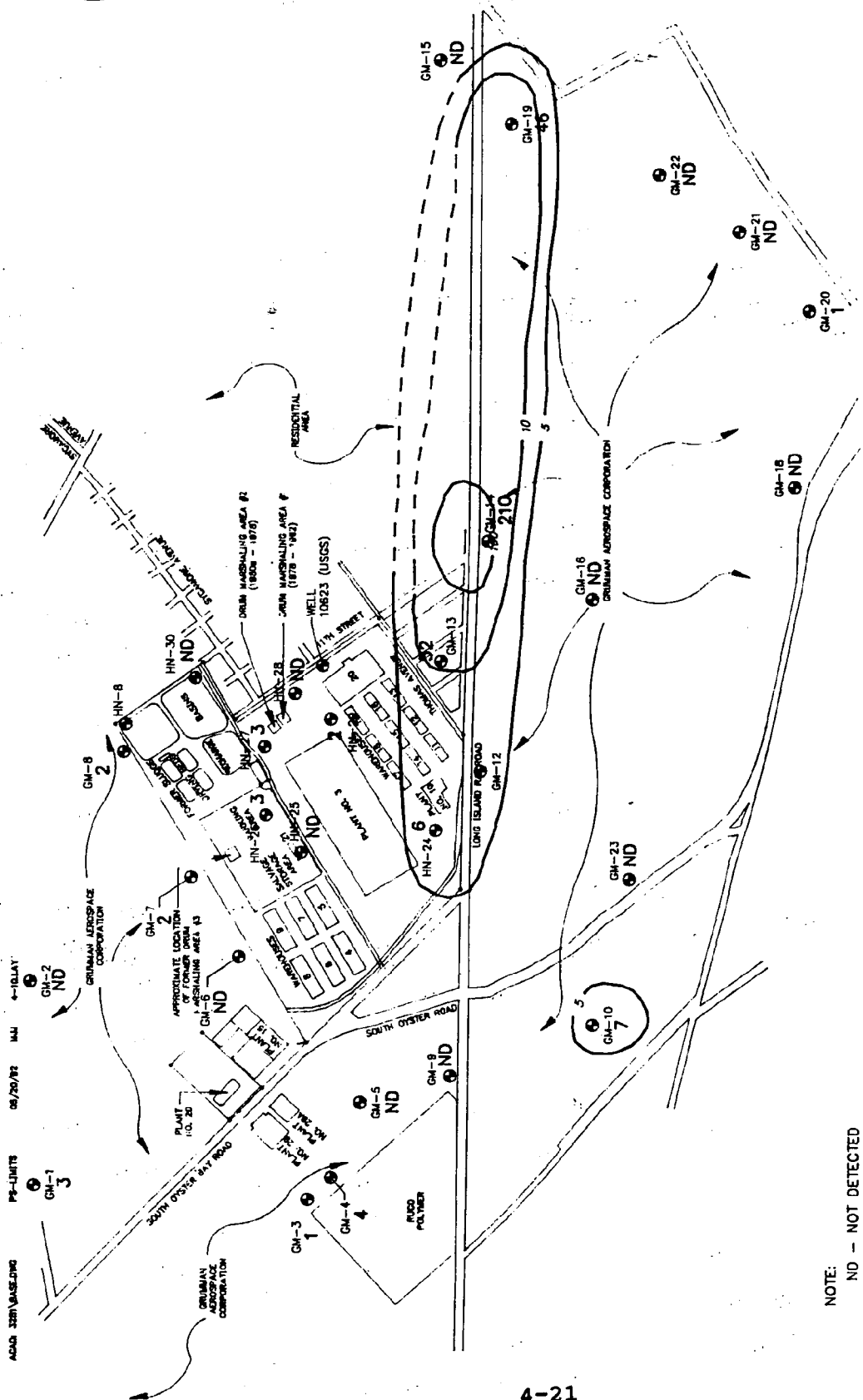

GROUNDWATER INTERMEDIATE ISOCONCENTRATION CONTOURS - 1.1.1-ICA (ug/l)  
 REMEDIAL INVESTIGATION  
 NWIRP, BETHPAGE, NEW YORK

NOTE:  
 ND - NOT DETECTED

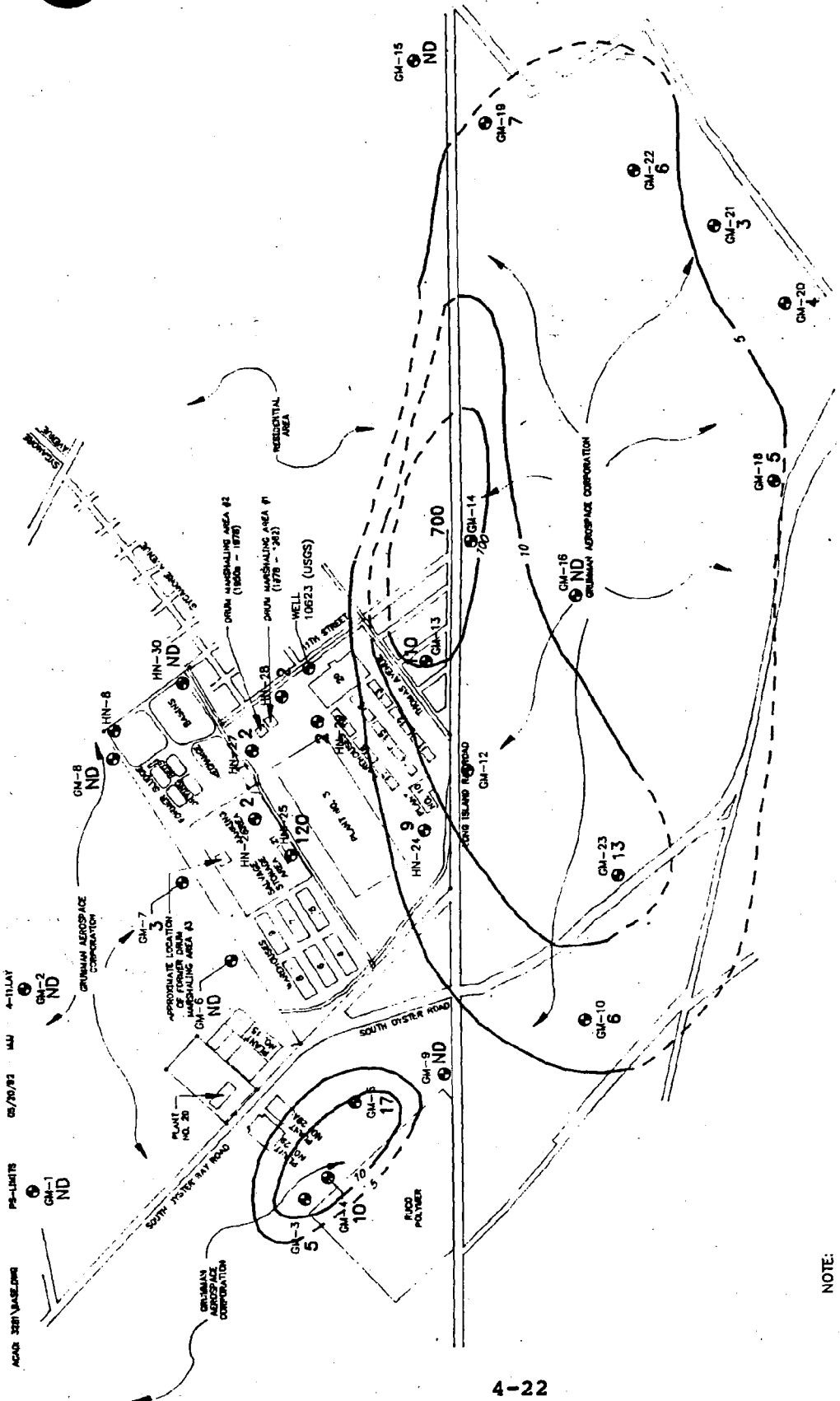

NOTE: ND - NOT DETECTED

GROUNDWATER INTERMEDIATE ISOCONCENTRATION CONTOURS - PCE (µg/l)  
 REMEDIAL INVESTIGATION  
 NWRP, BETHPAGE, NEW YORK

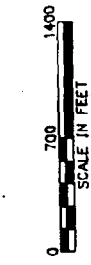

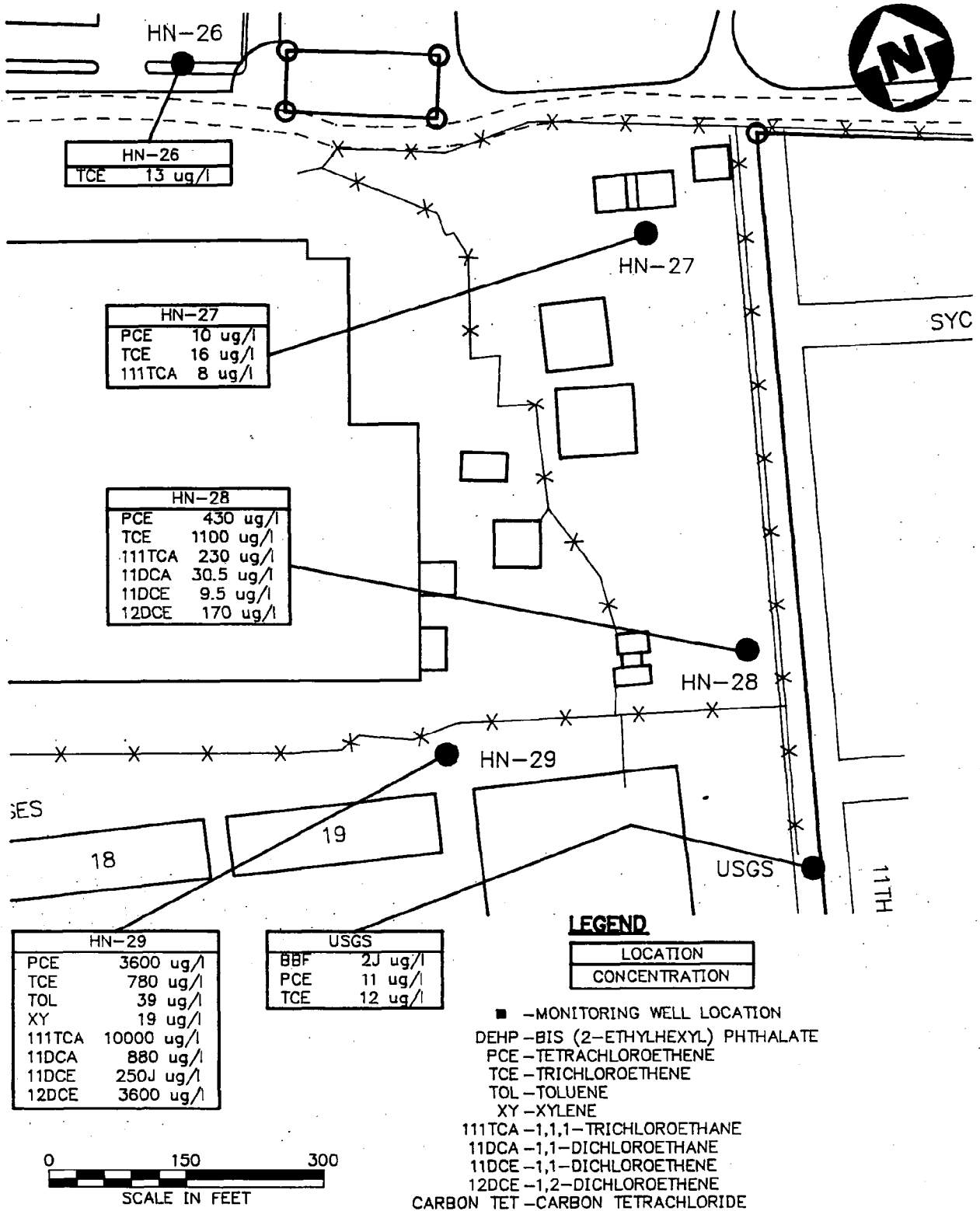

**SHALLOW GROUNDWATER ORGANICS  
 ABOVE MCLS. ALS. RFD  
 REMEDIAL INVESTIGATION  
 NWIRP. BETHPAGE, NEW YORK**

**FIGURE 4-12**



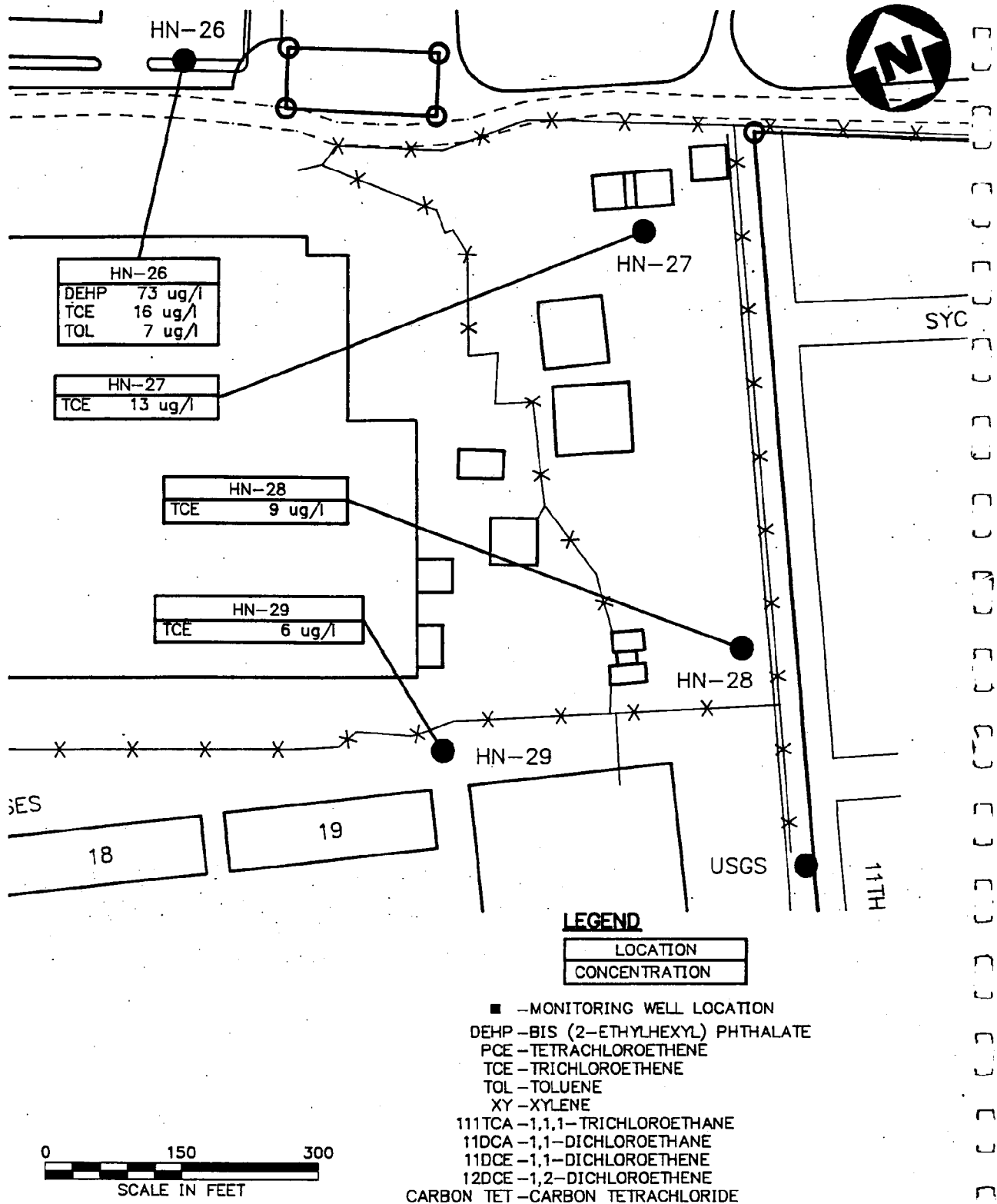

**INTERMEDIATE GROUNDWATER ORGANICS  
 ABOVE MCLS. ALS. RFD  
 REMEDIAL INVESTIGATION  
 NWIRP. BETHPAGE. NEW YORK**

**FIGURE 4-13**



From this data, it can be seen that chlorinated ethenes and ethanes were detected in most of the shallow and intermediate wells. Most notable at Site 1 were concentrations of TCE ranging up to 1,100 ug/l, concentrations of PCE ranging up to 3,600 ug/l, concentrations of 1,2-DCE ranging up to 3,600 ug/l, concentrations of 1,1-DCE ranging up to 250 ug/l, concentrations of 1,1,1-TCA ranging up to 10,000 ug/l, and concentrations of 1,1-DCA ranging up to 880 ug/l. Most of these maximum concentrations were reported in HN-29S, which is located in the southwestern part of Site 1. Concentrations of chlorinated ethenes and ethanes of several hundred ug/l were reported for HN-28S, which is located in the southeastern portion of Site 1. These wells are located south and hydraulically downgradient of the former drum marshaling areas, where significant VOC soil contamination was reported.

Generally, VOCs are greater in shallow wells than in the intermediate wells. Some VOCs were detected infrequently, including ethylbenzene. The ethylbenzene and xylenes, along with substituted phenols and PAHs, were all detected in HN-29S. It is unusual to find PAHs in groundwater; usually, they are assumed to be contained in the sediment (or oil) fractions of a monitoring well sample. Only one other well yielded PAHs (the USGS well). All PAHs were detected at trace concentrations in the southern part of Site 1.

A comparison of volatile organic results in the deep monitoring well (HN-29D) at Site 1 and the corresponding intermediate monitoring well (HN-29I), found slightly higher concentrations of several volatile organics (and particularly 1,1,1 TCA at 48 ug/l) in the deep monitoring well as compared to the intermediate monitoring well (1,1,1 TCA at 2 ug/l). This monitoring well is considered a downgradient monitoring well for Site 1 as well as for NWIRP. This finding indicates that groundwater contamination may be present at greater than 250 feet at this site. It should be noted that deep contamination was observed in the production wells at Site 3. Also, since higher concentrations are found at a greater depth, it is possible that there is a second deeper groundwater plume at Site 1. Groundwater in a single upgradient deep monitoring well at Site 2 (HN-8D) was found to have similar concentrations as the intermediate monitoring well at this location, thereby supporting the possibility of a second deeper plume. The relative significance of this potential second deep plume compared to the shallow plume cannot be determined because the depth of groundwater contamination in this area has not been defined and it is possible that higher concentrations of volatile organics are present at still greater depths. It is also possible that groundwater is contaminated at all depths with the highest organic concentrations occurring at the shallow depths.

TICs were detected in almost every well. TICs included PAHs, substituted benzenes, alkanes, substituted phenols, chlorinated ethenes, and carboxylic acids. Quantitative risk assessment is not

performed for TICs because the identities and quantities of TICs are uncertain. The quantities of TICs may be estimated, but these numbers are not appropriate for quantitative risk assessment since they may be over or under estimated by an order of magnitude. Those PAHs, benzenes, chlorinated ethenes and substituted phenols that were confidently identified are addressed quantitatively in Section 6.0. The TOX profiles in Appendix I contain quantitative information about the toxicity of chemicals from these classes of compounds.

Also included in Figures 4-6 through 4-11 are data collected during the Grumman Phase 1 RI. The combination of this data with the Navy data indicates that the contaminated groundwater plumes from Sites 1 and 3 merge below Plant 3. Also, the shallow groundwater contamination associated with Sites 1 and 3 end near the Long Island Railroad. At the same location and along the railroad toward areas southeast of Site 1, similar groundwater contamination is detected in the intermediate monitoring wells, indicating that the contaminated groundwater may have migrated into this zone. This downward migration of contaminants could be a result of production well operation (with screened intervals approximately 500 feet below the surface) and/or the effects of precipitation infiltration.

Further downgradient, near the runways, the intermediate groundwater contamination decreases significantly, indicating that either this distance is the extent of the bulk contamination migration in this direction or that the contamination has continued to sink in the aquifer, potentially toward the production wells. Increased groundwater contaminant concentrations are again found near Grumman's recharge basins at the southern boundary of the property.

Both filtered and unfiltered groundwater samples were obtained from onsite wells. The unfiltered inorganic results are presented in Table 4-8. These are the data which will be used in the quantitative risk assessment, in accordance with EPA policy. However, many monitoring wells contain significant amounts of sediment, which may result in overestimation of risks from metals in groundwater. Therefore, filtered results are also presented (see Table 4-9) and will be referred to as needed. The distribution of inorganics above MCLs or health-based levels in unfiltered monitoring wells is shown in Figures 4-14 and 4-15.

It can be seen from a comparison of Tables 4-8 and 4-9 that there are significantly lower concentrations of most metals in the filtered samples. Some inorganics, such as beryllium, cobalt, mercury, and nickel, were detected in the unfiltered samples but were not detected in the filtered samples.



TABLE 4-8  
 POSITIVE DETECTIONS OF UNFILTERED INORGANIC GROUNDWATER CONTAMINANTS  
 SITE 1 (UG/L)  
 MWIRP, BETHPAGE, NEW YORK

Chemical	CRDL	IDL	HN-275 (upgrad)	HN-28S	HN-28SD (DUP HN28S)	HN-29S	USGS	HN-271 (upgrad)	HN-281	HN-291	HN-290
Aluminum	200	25.0	33800	10600	9800	17100	4070	852	374		
Arsenic	10	1.0		15.4	17.4	10					
Barium	200	8.0	211	95.6	94.5	52.3	77.2	9.7	20.3		
Beryllium	5	1.0	2.9			2.8					
Cadmium	5	1.0	392								
Calcium	5000	13.0	8450	6280	6010	3860	7540	7580	5790	5160	6040
Chromium	10	8.0	169	19.8	17	30.1	85.7		59.2		
Chromium VI	10								61		
Cobalt	50	5.0	10.4			12.8	10.4				
Copper	25	2.0	823J	23.7	22.8	51.6	136	3.1			
Iron	100	21.0	106000	20700	19200	93000	125000	457	325		
Lead	3	1.0	43.4	7	7.4	18.8	124				
Magnesium	5000	45.0	2750	1550	1470	277	2820	1380	1440	1390	
Manganese	15	1.0	280	81.1J	78.8J	232J	1440J	28.5J	37.3J	26.9J	18.7
Mercury	0.2	0.20	0.2								
Nickel	40	8.0	26.6			10.9	62.9				
Potassium	5000	633	5230	4510	4360	7190	2060	5640	4940	10600	
Selenium	5	1.0				2.3					
Sodium	5000	21.0	19100	145000	143000	222000	19300	18400	16000	19100	15900
Vanadium	50	4.0	218	49.8	47	419	33.3				

TABLE 4-8  
 POSITIVE DETECTIONS OF UNFILTERED INORGANIC GROUNDWATER CONTAMINANTS  
 SITE 1 (UG/L)  
 MWBP, BETHPAGE, NEW YORK  
 PAGE TWO

Chemical	CRDL	IDL	HM-275 (upgrad)	HM-288	HM-288D (DUP H288)	HM-295	USGS	HM-271 (upgrad)	HM-281	HM-291	HM-290
Zinc	20	5.0	123J				217				
Cyanide	5	2.0	2690	144	145	49.4	19.8				

CRDL = Contract Required Detection Limits  
 IDL = Instrument Detection Limit  
 J = Estimated

TABLE 4-9  
 POSITIVE DETECTIONS OF FILTERED INORGANIC GROUNDWATER CONTAMINANTS  
 SITE 1 (UG/L)  
 MWIRP, BETHPAGE, NEW YORK

Chemical	CRDL	IDL	HN-27S (Upgrad)	HN-28S	HN-28SD (DUP HN28S)	HN-29S	USGS	HN-271 (Upgrad)	HN-281	HN-291	HN-29D
Aluminum	200	25.0				293					
Arsenic	10	1.0		14.1	13.6	43.2					
Barium	200	8.0	9				15.9		18.2	13	
Cadmium	5	1.0	91J					2.8J			
Calcium	5000	13.0	6230J	4980	5430	2730	6390	6920J	5620	5190	6160
Chromium	10	8.0							56.7		
Copper	25	2.0	2					2.3			
Iron	100	21.0	25.4			214	568				
Magnesium	5000	45.0	1660J	1150	1260		1910	1320J	1410	1300	
Manganese	15	1.0	16.5J	21.3J	23J	1.6J	572J	21.2J	35.4J	7.9J	15.8
Potassium	5000	633	1100	3880	3820	6260	1810	5500	4800	12400	
Selenium	5	1.0				3.1					
Sodium	5000	21.0	19500J	134000	138000	230000	18500	18700J	15900	18700	15700
Thallium	10	1.0				1.7J					
Vanadium	50	4.0		10.1	9.5	34.3					
Zinc	20	5.0	168J	97.7	94.4		178				

CRDL = Contract Required Detection Limit  
 IDL = Instrument Detection Limit  
 J = Estimated

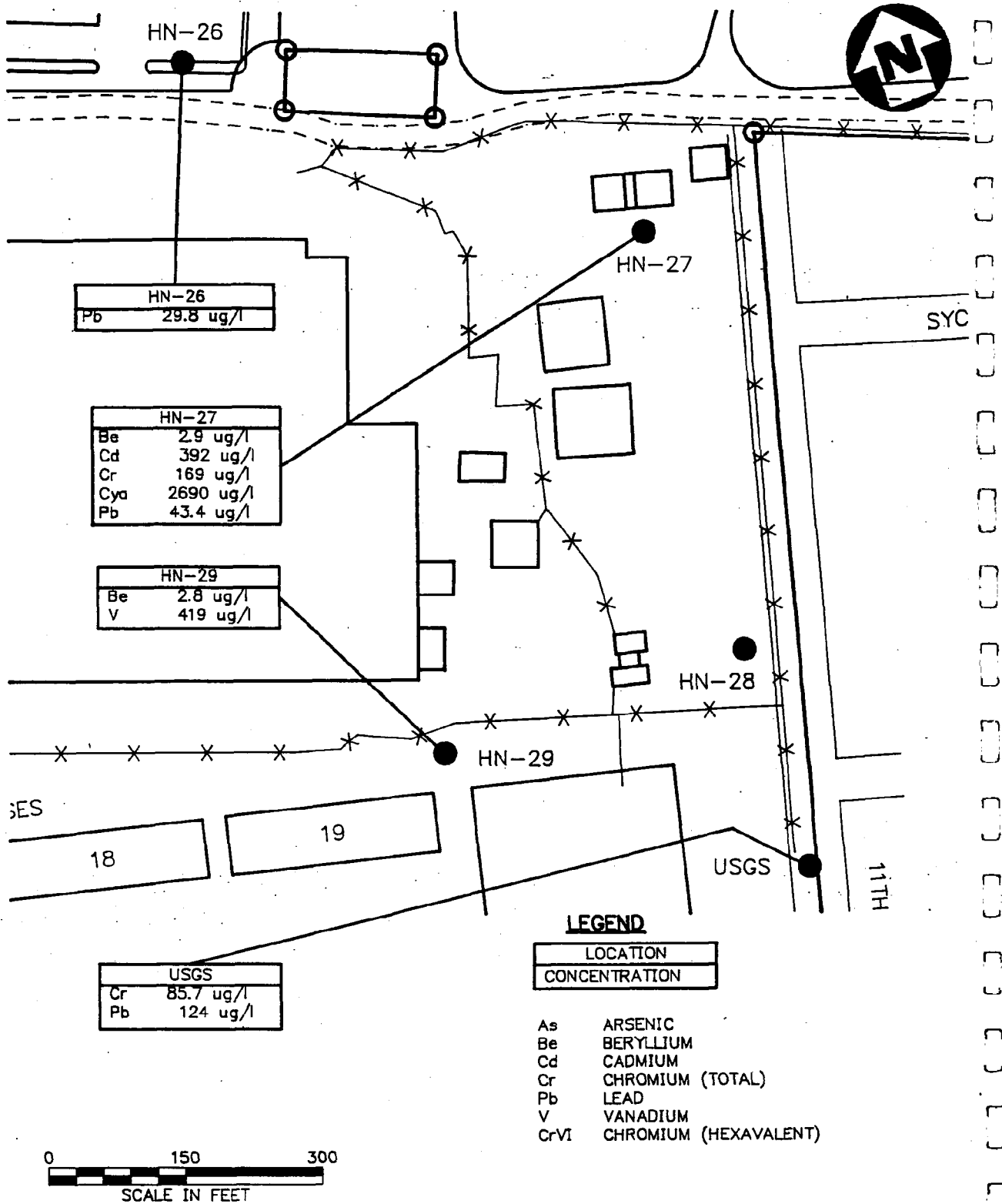

**GROUNDWATER SHALLOW INORGANICS  
(UNFILTERED)**

**REMEDIAL INVESTIGATION  
NWIRP, BETHPAGE, NEW YORK**

**FIGURE 4-14**



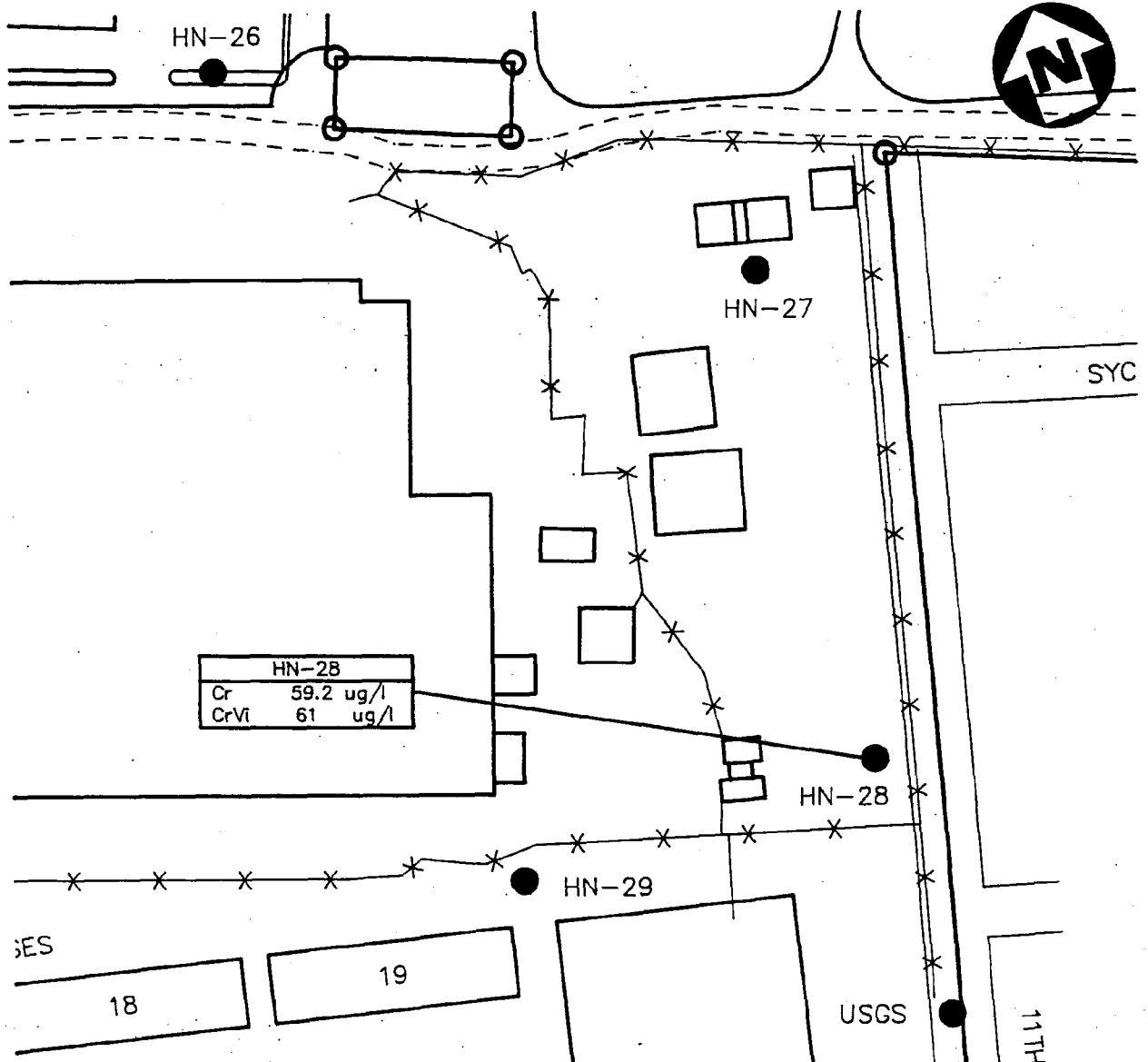

**GROUNDWATER INTERMEDIATE INORGANICS**

**FIGURE 4-15**

**(UNFILTERED)**

**REMEDIAL INVESTIGATION  
NWIRP, BETHPAGE, NEW YORK**



Results for total chromium and hexavalent chromium are presented in Table 4-8. Because the proportions of trivalent and hexavalent chromium in the total chromium cannot be accurately determined, both the total and hexavalent results are given. For purposes of risk assessment, chromium will be assumed to be hexavalent where hexavalent chromium was not analyzed. Total chromium will be treated as trivalent, and hexavalent chromium will be treated as hexavalent in the risk assessment for groundwater. Although this will result in some overestimation of risk, the toxicity of trivalent chromium is low enough, especially relative to hexavalent chromium, that its impact on the quantitative assessment will be negligible.

Notable results in unfiltered monitoring wells include beryllium in HN-27S (2.9 ug/l) and HN-29S (2.8 ug/l); cadmium in HN-27S (392 ug/l); chromium in HN-27S (169 ug/l), USGS (85.7 ug/l), and HN-28I (59.2 ug/l); iron in USGS (125,000 ug/l), HN-29S (93,000 ug/l), and HN-27S (106,000 ug/l); lead in USGS (124 ug/l); vanadium in HN-29S (419 ug/l). Notable results in filtered samples include cadmium in HN-27S (91 ug/l); chromium in HN-28I (56.7 ug/l); and thallium in HN-29S (1.7 ug/l). There is no clear pattern or definable plume of inorganic contamination, although inorganic concentrations were highest in HN-27S and HN-29S.

The concentration of the inorganics in the deep monitoring well as compared to the intermediate monitoring well are generally similar or lower. This indicates that inorganic contamination is limited to the shallow groundwater.

#### 4.1.5 Surface Soils

Seven surface soil samples were obtained at Site 1. Sampling locations were selected based on historical information regarding site chemical handling and disposal activities. Surface soil samples were collected at points on a relatively uniform, 300-foot by 300-foot grid and at one field-determined, opportune location.

Sample locations are displayed in Figure 2-4. The analytical results for the surface soil samples are summarized in Tables 4-10 and 4-11, which provide evidence of organic and inorganic contaminants, respectively. In general, trace to low levels of VOCs were detected in surface soil samples. The highest reported concentrations of these compounds occurred in a sample from the western part of Site 1 (PCE up to 51 ug/kg, TCE up to 11.5 ug/kg). The distribution of TCE and PCE in the surface soils is illustrated in Figures 4-16 and 4-17. The isoconcentration lines were generated via direct interpolation between individual data points. Another primary site contaminant, 1,1,1-trichloroethane (1,1,1-TCA), was not detected in surface soils.

TABLE 4-10

OCCURRENCE AND DISTRIBUTION OF SURFACE SOIL CONTAMINANTS  
 SITE 1 - ORGANIC (ug/kg)  
 MWIRP, BETHPAGE, NY

Compound	CRQL	Number Positive Detections/ Samples Analyzed	Maximum Positive Detection	Location of Maximum Concentration	Representative Concentration*
Trichloroethene	5	3/7	11.5	SS103	7.4
Tetrachloroethene	5	2/7	51	SS103	27.4
4,4'-DDE	17	1/2	270J	SS102	270
4,4'-DDT	17	1/2	170J	SS102	170
gamma-Chlordane	80	1/2	240J	SS102	240
Aroclor 1248	80	2/2	7900	SS102	7900
bis(2-Ethylhexyl)phthalate	330	5/7	200J	SS106	179
Butylbenzyl phthalate	330	3/7	180J	SS105	180
2-Methylnaphthalene	330	2/7	160J	SS106	160
Naphthalene	330	1/7	53J	SS106	53
Acenaphthene	330	3/7	53J	SS102	53
Phenanthrene	330	7/7	700	SS104	554
Anthracene	330	3/7	66J	SS104	66
Fluoranthene	330	7/7	1100	SS104	837
Pyrene	330	7/7	950	SS104	793
Benzo[a]anthracene	330	7/7	550	SS104	439
Chrysene	330	7/7	580	SS104	473
Benzo[b]fluoranthene	330	7/7	680	SS104	575
Benzo[k]fluoranthene	330	6/7	620	SS104	477

TABLE 4-10  
 OCCURRENCE AND DISTRIBUTION OF SURFACE SOIL CONTAMINANTS  
 SITE 1 - ORGANIC (ug/kg)  
 PAGE TWO

Compound	CRQL	Number Positive Detections/ Samples Analyzed	Maximum Positive Detection	Location of Maximum Concentration	Representative Concentration*
Benzo[a]pyrene	330	7/7	620	SS104	502
Indeno[1,2,3-c,d]pyrene	330	7/7	430	SS104	349
Dibenz[a,h]anthracene	330	2/7	150J	SS101	150
Benzo[g,h,i]perylene	330	7/7	420	SS104	350
Fluorene	330	2/7	44J	SS104	44
PCBs (TICs)		7/7	P	SS103	-

Background soil concentrations are presented in Table 4-4

\* Upper 95% confidence limit (UCL) on arithmetic average, or maximum if UCL exceeds maximum detected.

ND = Not Detected

TIC = Tentatively Identified Compound

PCB = Polychlorinated Biphenyl

CRQL = Contract Required Quantitation Limit

J = Estimated

P = Present



TABLE 4-11

OCCURRENCE AND DISTRIBUTION OF SURFACE SOIL CONTAMINANTS  
SITE 1 - INORGANIC (mg/kg)  
MWIRP, BETHPAGE, NY

Element	CRDL	IDL	Number Positive Detections/ Samples Analyzed	Concentration Range	Location of Maximum Concentration	Representative Concentration*
Aluminum	40	36.2	6/7	3370-10800	SS102	8468
Arsenic	2	0.78	6/7	3.4J-55.8J	SS106	33.1
Barium	40	0.48/0.78	6/7	10.8-59J	SS106	46.6
Chromium	2	2.1	6/7	18.8J-61.1	SS103	49.1
Cobalt	10	4.4	2/7	ND-5.3J	SS106	4.4
Iron	20	7.0/7.4	6/7	7266-15900	SS103	14708
Mercury	0.10	0.10	-	ND-5.54		2.8
Nickel	8	4.8	6/7	6.5J-19.2J	SS016	16.1
Silver	2	0.18	5/7	ND-6.3		3.5
Vanadium	10	3.7	6/7	13.7J-39.3J	SS103	30.4
Cyanide	2	2.0	1/7	ND-5.4	SS106	3.2

Background soil concentrations are presented in Table 4-5.

\* Upper 95% confidence limit (UCL) on arithmetic average, or maximum if UCL exceeds maximum detected.

ND = Not Detected

CRDL = Contract Required Detection Limit

IDL = Instrument Detection Limit

J = Estimated

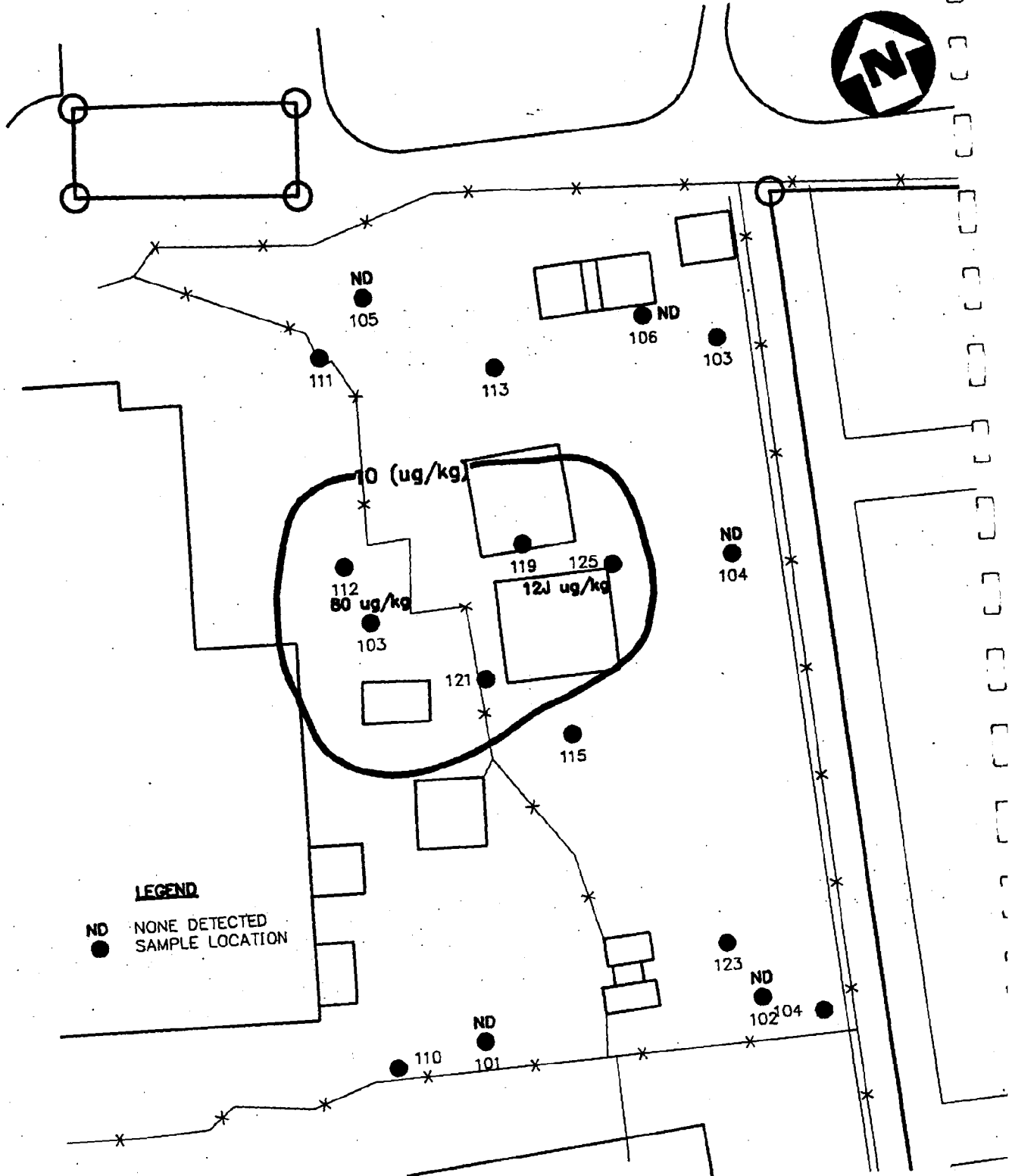

ACAD: 3281\SITE1.DWG  
 02/27/92  
 MB 4-16.LAY

**FIGURE 4-16**

**SITE 1 - SURFACE SOIL RESULTS - PCE  
 REMEDIAL INVESTIGATION  
 NWIRP, BETHPAGE, NY 4-36**



4-17.LAY  
MB  
02/27/82  
AGAU: J2B1\SITE1.DWG

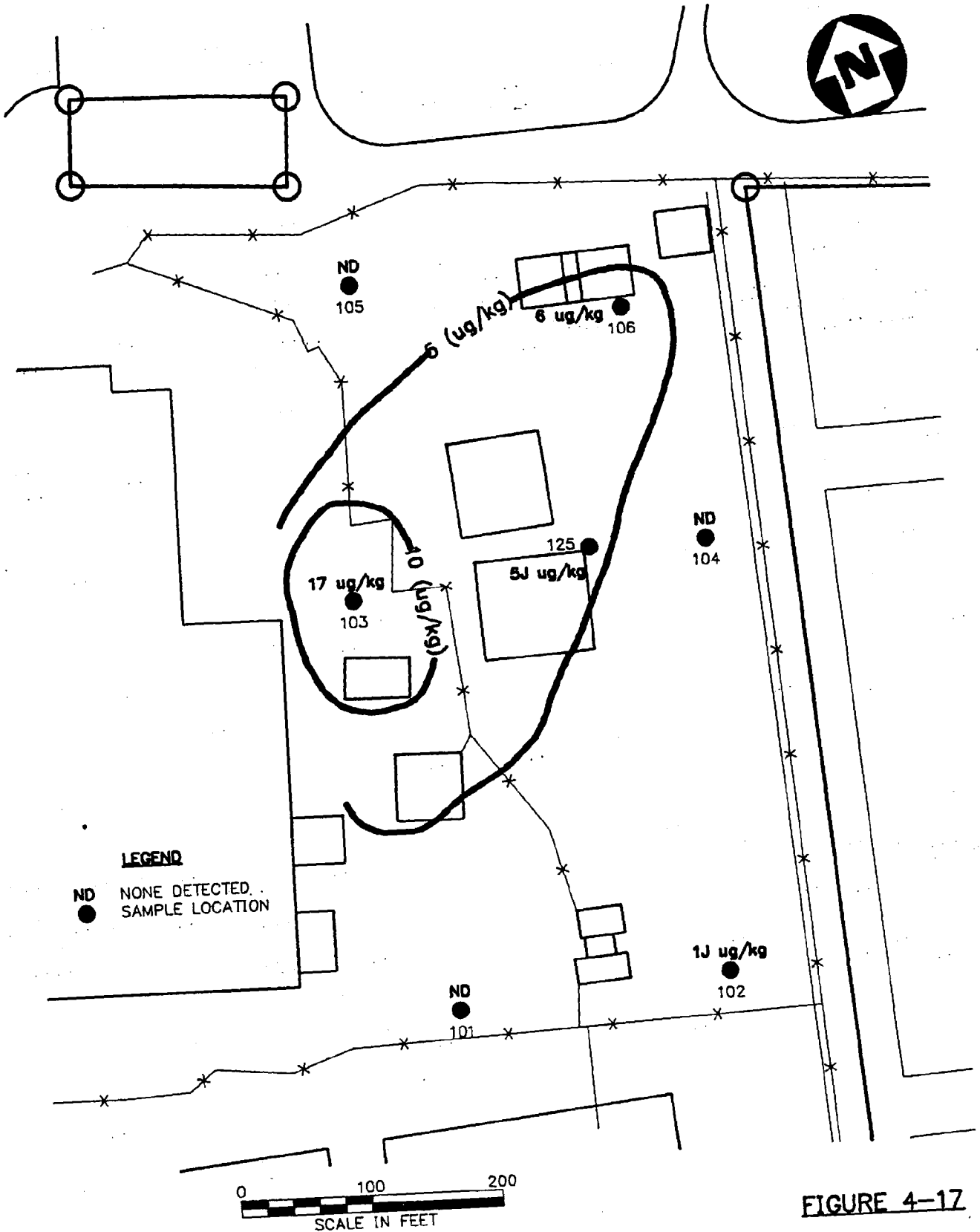

**SITE 1 - SURFACE SOIL RESULTS - ICE  
REMEDIAL INVESTIGATION  
NWIRP, BETHPAGE, NY**

4-37



**FIGURE 4-17**

Low to moderate concentrations of phthalate esters (under 300 ug/kg) and polynuclear aromatic hydrocarbons (PAHs) (under 20,000 ug/kg) were also detected throughout the site; no well-defined pattern of contamination by PAHs and phthalate is evident.

Polychlorinated biphenyls (PCBs) such as Aroclor 1248 and Aroclor 1254 were identified in surface soils. PCBs were detected in all areas of Site 1. Concentrations of PCBs ranged up to 7,900 ug/kg, with the highest concentration occurring in the southern portion of Site 1.

PCBs were tentatively identified in all Site 1 surface soil samples. In one duplicate pair, the estimated concentrations of PCBs varied widely, by a few orders of magnitude. PCBs as TICs are used mainly in a confirmation basis. TICs are not appropriate for quantitative risk assessment because their identities and quantities are uncertain. Those PCBs that were confidently identified are addressed quantitatively in Section 6.0. The TOX profiles in Appendix I contain qualitative information about the toxicity of PCBs.

Pesticides were detected in one surface sample from the southern part of Site 1. The pesticides included DDT and DDE (170 ug/kg and 270 ug/kg, respectively) and gamma-chlordane (240 ug/kg). These compounds were not detected at any other sample location.

For comparative purposes, concentrations of organic compounds in background (subsurface) soil sample are shown in Table 4-4. It can be seen that PAHs, which are common environmental contaminants, were detected at levels up to approximately 7,000 ug/kg in background soil.

Inorganic elements detected at Site 1 at the activity are displayed in Table 4-11. Many metals were detected above levels observed in background (subsurface) soil. Mercury and silver were found at scattered and inconsistent positive detections. Cyanide was detected at low levels (up to 5.36 mg/kg) in one sample. Substances associated particularly with plating detected at the two sites are nickel, silver, cyanide, and chromium (Sittig, 1985).

At Site 1, the highest-concentration sample was SS-6, which was located in the northeastern corner of Site 1. It is apparent that the patterns of distribution of organic and inorganic contaminants are quite different.

#### 4.1.6 Summary

The results of the soil-gas survey indicated that a source area of volatile organic contamination was present near the former drum marshaling area and extended to the south. The results of the soil boring program confirmed a source area of volatile organics near the former drum marshaling areas. Contaminants PCE and TCE at

levels up to 4,800 ug/kg and 200 ug/kg, respectively, were found in Site 1 subsurface soils. Levels of inorganic contamination were relatively low, when compared to the volatile organic contamination. Nevertheless, significant concentrations of PCBs (7,900 ug/kg), pesticides (440 ug/kg), PAHs, and inorganics were found in the soils at Site 1. There is no apparent distinct pattern associated with the nonvolatile organic contamination.

The temporary monitoring well program and monitoring well program confirmed that Site 1 is an apparent source area of groundwater contamination starting near the former drum marshaling area and extending southwest (hydraulically down gradient). TCE, PCE, and 1,1,1-TCA were detected at maximum concentrations of 1,500 ug/l, 7,700 ug/l, and 10,000 ug/l, respectively. Inorganic contamination was also found.

#### **4.2 Recharge Basins (Site 2)**

##### **4.2.1 Soil-Gas**

Soil-gas sampling was performed to help define the extent of volatile organic contamination and to assist in the selection of sampling locations. The analysis included the parameters of 1,1-DCE, t-1,2-DCE, 1,1-DCA, c-1,2-DCE, 1,1,1-TCA, TCE, and PCE. The concentrations referred to in this section are a sum of PCE and TCE concentrations. Soil-gas sampling locations and results are presented in Figures 4-18 and 4-19.

The results of the soil-gas analysis are presented in Table 4-12. Based on these results, there appears to be a source, in the approximate center of the site, where readings of 11.22 ug/l and 10 ug/l were obtained in the shallow soil-gas samples. Lesser concentrations (e.g., 3.05 ug/l, 0.79 ug/l) were obtained closer to the edges of Site 2, and non-detects of volatile organics were obtained at the far edges. The highest-concentration area of contaminants in Site 2 corresponds to the highest-concentration trichloroethene (up to 32 ug/kg at location 215, 3-foot depth) detected in Site 2 (see Section 4.3.2). Similar, but lower, concentrations were detected in the deep soil-gas results.

QA/QC samples are also presented in Table 4-12. Analysis of the field control sample (blank) and laboratory blank results indicated minimal background contamination. The duplicate results were generally within +/- 30%. These results indicate that the data is of relatively good quality.

##### **4.2.2 Temporary Monitoring Wells**

Eleven temporary wells at Site 2 were sampled and analyzed for volatile organics including vinyl chloride, 1,1-DCE, t-1,2-DCE, 1,1-DCA, c-1,2-DCE, 1,1,1-TCA, 1,2-DCA, TCE, PCE. The location of the temporary monitoring wells is presented in Figure 2-2. A

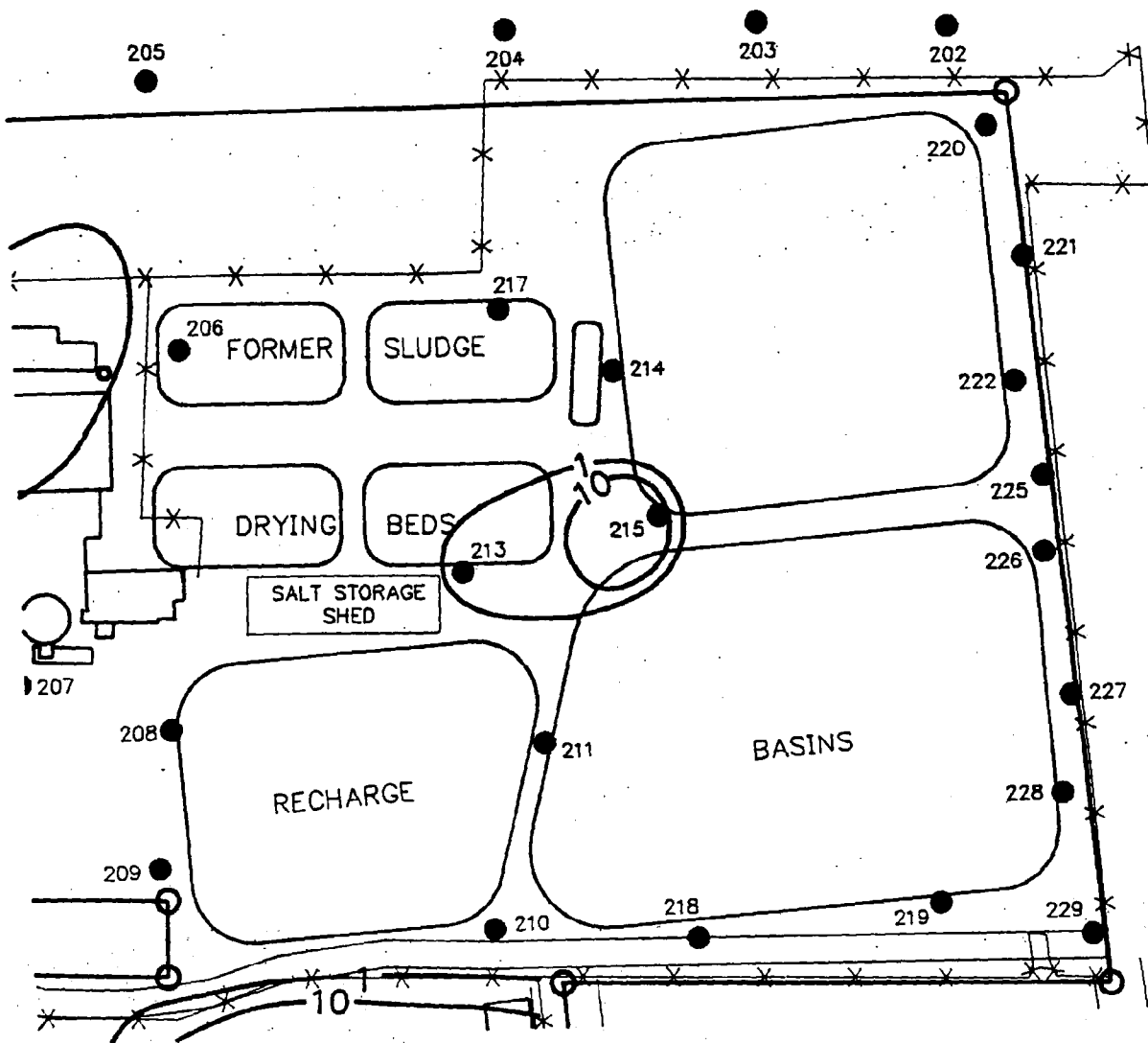

**LEGEND**

● SOIL GAS LOCATIONS

—10— TCE AND PCE (ug/l)

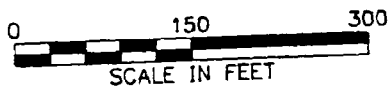

**FIGURE 4-18**

**SOIL GAS RESULTS - SHALLOW  
 REMEDIAL INVESTIGATION  
 NWIRP, BETHPAGE, NEW YORK**

4-40



**HALLIBURTON NUS**  
*Environmental Corporation*

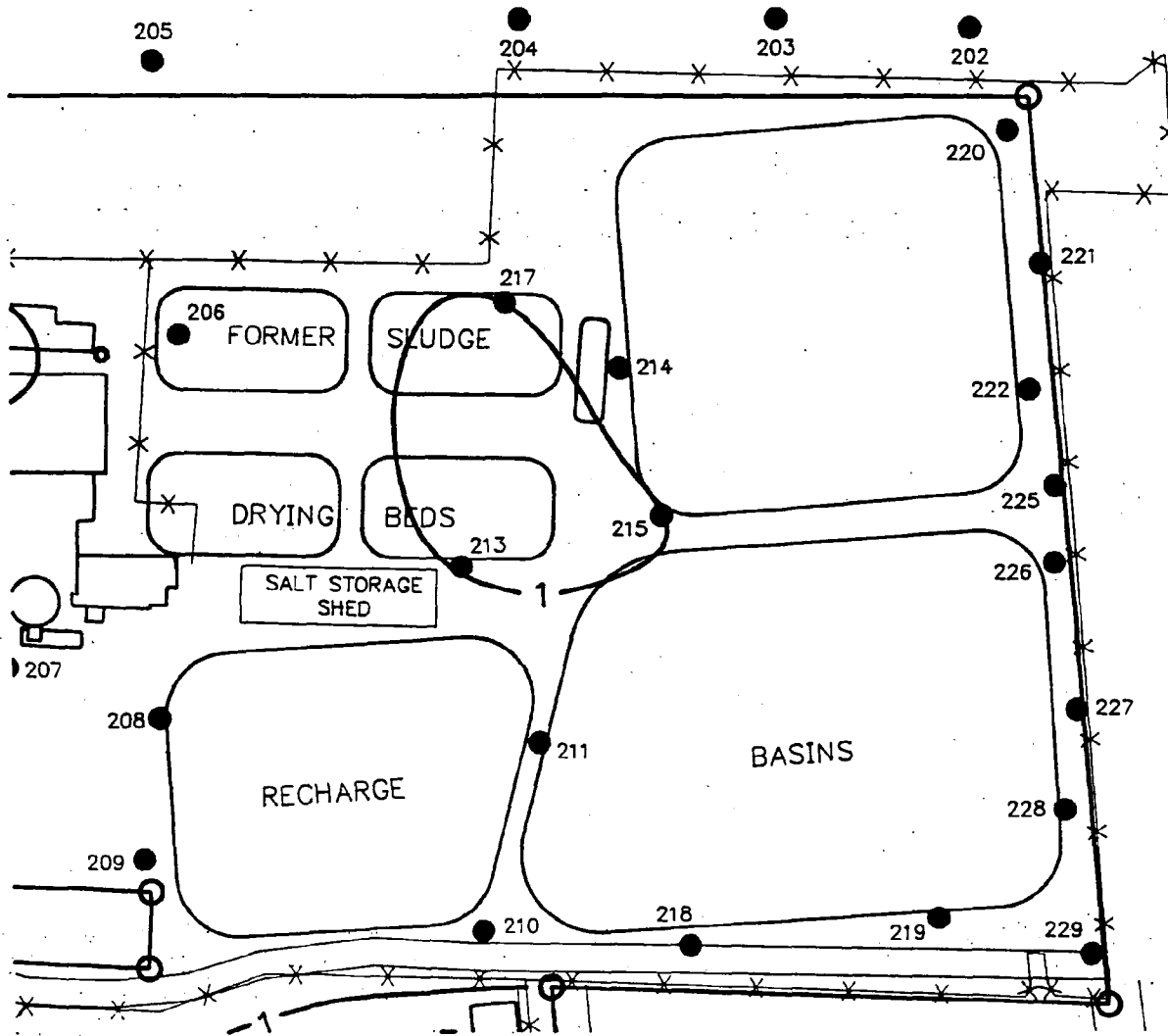

**LEGEND**

● SOIL GAS LOCATIONS

—10— TCE AND PCE (ug/l)

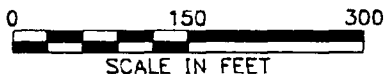

**FIGURE 4-19**

**SOIL GAS RESULTS - DEEP  
REMEDIAL INVESTIGATION  
NWIRP, BETHPAGE, NEW YORK**



TABLE 4-12  
SOIL-GAS RESULTS - SITE 2 (ug/l)  
MWIRP, BETHPAGE, NY

Sample	11DCE	t12DCE	11DCA	c12DCE	111TCA	TCE	PCE
202D	<1.0	<1.0	<1.0	<1.0	<1.0	<1.0	<0.05
202S	<1.0	<1.0	<1.0	<1.0	0.39	<0.10	<0.05
203D	<1.0	<1.0	<1.0	<1.0	<0.10	<0.10	<0.05
203S	<1.0	<1.0	<1.0	<1.0	<0.10	<0.10	<0.05
204S	<1.0	<1.0	<1.0	<1.0	<0.10	<0.10	<0.05
205D	<1.0	<1.0	<1.0	<1.0	<0.10	<0.10	0.07
206D	6.3	<1.0	<1.0	<1.0	<0.10	0.32	0.05
206S	1.2	<1.0	<1.0	<1.0	0.19	2.2	0.85
207D	2.8	<1.0	<1.0	<1.0	<0.10	<0.10	0.60
207S	20	<1.0	<1.0	<1.0	<0.10	0.21	0.11
208D	1.4	<1.0	<1.0	<1.0	<0.10	<0.10	0.41
208S	4.3	<1.0	<1.0	<1.0	0.17	0.54	0.25
209D	1.0	<1.0	<1.0	<1.0	<0.10	<0.10	0.06
209S	1.4	<1.0	<1.0	<1.0	<0.10	<0.10	0.17
210D	1.4	<1.0	<1.0	<1.0	<0.10	0.12	0.23
210S	1.2	<1.0	<1.0	<1.0	<0.10	<0.10	0.41
211D	<1.0	<1.0	<1.0	<1.0	<0.10	<0.10	<0.05
211S	<1.0	<1.0	<1.0	<1.0	<0.10	<0.10	0.50
213D	5.1	<1.0	<1.0	<1.0	1.3	2.2	0.42
213S	3.1	<1.0	<1.0	<1.0	1.0	0.88	0.18
214D	<1.0	<1.0	<1.0	<1.0	0.36	<0.10	<0.05
214S	<1.0	<1.0	<1.0	<1.0	<0.10	<0.10	<0.05
215D	6.4	<1.0	<1.0	<1.0	0.46	1.8	0.27
215S	1.3	<1.0	<1.0	<1.0	0.34	11	0.22
216D	1.2	<1.0	<1.0	<1.0	<0.10	<0.10	0.09
216S	<1.0	<1.0	<1.0	<1.0	<0.10	<0.10	0.28
217D	<1.0	<1.0	<1.0	<1.0	0.33	1.8	0.11
217S	<1.0	<1.0	<1.0	<1.0	<0.10	0.12	<0.05
218D	<1.0	<1.0	<1.0	<1.0	<0.10	<0.10	<0.05
218S	<1.0	<1.0	<1.0	<1.0	<0.10	<0.10	<0.05
219D	<1.0	<1.0	<1.0	<1.0	<0.10	<0.10	<0.05
219S	<1.0	<1.0	<1.0	<1.0	<0.10	<0.10	<0.05



TABLE 4-12  
SOIL-GAS RESULTS - SITE 2 (ug/L)  
PAGE TWO

Sample	11DCE	t12DCE	11DCA	c12DCE	111TCA	TCE	PCE
220D	<1.0	<1.0	<1.0	<1.0	<0.10	<0.10	<0.05
220S	<1.0	<1.0	<1.0	<1.0	<0.10	<0.10	<0.05
221D	2.0	<1.0	<1.0	<1.0	<0.10	0.15	<0.05
221S	<1.0	<1.0	<1.0	<1.0	<0.10	<0.10	<0.05
222D	<1.0	<1.0	<1.0	<1.0	<0.10	<0.10	<0.05
222S	<1.0	<1.0	<1.0	<1.0	<0.10	<0.10	<0.05
225D	<1.0	<1.0	<1.0	<1.0	<0.10	<0.1	<0.05
225S	<1.0	<1.0	<1.0	<1.0	<0.10	<0.10	<0.05
226D	<1.0	<1.0	<1.0	<1.0	<0.10	<0.10	<0.05
226S	<1.0	<1.0	<1.0	<1.0	<0.10	<0.10	<0.05
227D	14	<1.0	<1.0	<1.0	0.59	<0.10	<0.05
227S	<1.0	<1.0	<1.0	<1.0	<0.10	<0.10	<0.05
228D	2.0	<1.0	<1.0	<1.0	0.11	0.18	0.19
228S	<1.0	<1.0	<1.0	<1.0	<0.10	<0.10	<0.05
229D	<1.0	<1.0	<1.0	<1.0	<0.10	<0.10	<0.05
229S	<1.0	<1.0	<1.0	<1.0	<0.10	<0.10	<0.05
<b>FIELD CONTROL SAMPLES</b>							
201	<1.0	1.0	2.0	<1.0	<0.10	<0.10	<0.05
212	<1.0	<1.0	<1.0	<1.0	<0.10	<0.10	<0.05
223	<1.0	<1.0	<1.0	<1.0	<0.10	<0.10	<0.05
224	<1.0	<1.0	<1.0	<1.0	<0.10	<0.10	<0.05
<b>LABORATORY DUPLICATE ANALYSES</b>							
218D	<1.0	<1.0	<1.0	<1.0	<0.10	<0.10	<0.05
218DR	<1.0	<1.0	<1.0	<1.0	<0.10	<0.10	<0.05
223	<1.0	<1.0	<1.0	<1.0	<0.10	<0.10	<0.05
223R	<1.0	<1.0	<1.0	<1.0	<0.10	<0.10	<0.05
<b>LABORATORY BLANKS</b>							
218DB	<1.0	<1.0	<1.0	<1.0	<0.10	<0.10	<0.05
223B	<1.0	<1.0	<1.0	<1.0	<0.10	<0.10	<0.05

11DCE = 1,1-dichloroethene  
t12DCE = trans-1,2-dichloroethene  
11DCA = 1,1-dichloroethane  
c12DCE = cis-1,2-dichloroethene  
111TCA = 1,1,1-trichloroethane  
TCE = trichloroethene  
PCE = tetrachloroethene

S = Shallow  
D = Deep

summary of the organic contaminants detected at Site 2 is provided in Table 4-13.

TCE was the only volatile organic detected at Site 2. It was present at a low concentration (9 ug/l) and only detected in four temporary wells. Two wells contained the maximum concentration of TCE detected, or 9 ug/l (G-209, G-218). Both wells were located in the southern portion of the site.

#### 4.2.3 Subsurface Soils

Subsurface sample locations are presented in Figure 2-3. Table 4-14 presents the distribution of organic chemicals in subsurface soil. Low-level VOCs, especially TCE and PCE, were detected at the site. Figures 4-20 and 4-21 illustrate the subsurface distribution of detections of TCE and PCE. TCE was detected at the 3-foot depth of SB-215 at 32 ug/kg. In general, concentrations of compounds in samples obtained at 19 feet were not significantly greater than concentrations at 3 feet. There appears to be overall trace-to-low-level chlorinated ethene contamination at the site.

PCBs were confidently and tentatively identified at some locations in Site 2 (206 and 215, three-foot depth). The only confidently identified Aroclor was Aroclor 1248, which was detected up to 6,800 ug/kg.

PAHs, which are common environmental contaminants, were confidently and tentatively identified in subsoil throughout Site 2. Phthalate, which are plasticizers and are also common environmental contaminants as well as common blank contaminants, were detected at low concentrations (under 12,000 ug/kg) at several locations at Site 2. PCBs as TICs are used mainly on a confirmation basis. TICs are not appropriate for quantitative risk assessment because their identities and quantities are uncertain (quantities may vary by an order of magnitude). Those PCBs, PAHs, and phthalate that were confidently identified are addressed quantitatively in Section 6.0. The TOX profile in Appendix I contain qualitative information about the toxicity of PCBs, PAHs, and phthalates.

Chlorinated solvents were detected at trace levels in background soil samples (See Table 4-4). PAHs were also detected in background soil samples up to approximately 7,000 ug/kg.

Table 4-15 displays inorganic analytical results for subsurface soil. The following metals were detected at the highest concentrations in Site 2: mercury and silver. These metals can be associated with plating (Sittig, 1985). The highest-concentration samples in Site 2 were SB-229 and SB-217, with various high-concentration detections scattered throughout the site. SB-229 was located in the southwestern corner of Site 2, whereas SB-217 was located in the area of the former sludge drying beds. Sample SB-

TABLE 4-13

TEMPORARY MONITORING WELL  
 SITE 2 - ORGANIC RESULTS (ug/l)  
 MWIRP, BETHPAGE, NY

Temporary Well #	VC	11DCE	T12DCE	11DCA	C12DCE	111TCA	112DCA	TCE	PCE
202	5U	5U	5U	5U	5U	5U	5U	5U	5U
204	5U	5U	5U	5U	5U	5U	5U	5U	5U
205	5U	5U	5U	5U	5U	5U	5U	7	5U
209	5U	5U	5U	5U	5U	5U	5U	9	5U
215	5U	5U	5U	5U	5U	5U	5U	8	5U
218	5U	5U	5U	5U	5U	5U	5U	9	8
219	5U	5U	5U	5U	5U	5U	5U	5U	5U
225	5U	5U	5U	5U	5U	5U	5U	5U	5U
227	5U	5U	5U	5U	5U	5U	5U	5U	5U
229	5U	5U	5U	5U	5U	5U	5U	5U	5U

U - Undetected  
 11DCE = 1,1-dichloroethene  
 t12DCE = trans-1,2-dichloroethene  
 11DCA = 1,1-dichloroethane  
 c12DCE = cis-1,2-dichloroethene  
 111TCA = 1,1,1-trichloroethane  
 TCE = trichloroethene  
 PCE = tetrachloroethene  
 VC = vinyl chloride

TABLE 4-14

OCURRENCE AND DISTRIBUTION OF SUBSURFACE SOIL CONTAMINANTS  
 SITE 2 - ORGANIC (ug/kg)  
 NJIRP, BETHPAGE, NY

	CRQL	Number Positive Detections/ Samples Analyzed	Maximum Positive Concentration	Location of Maximum Concentration	Representative Concentration*
Trichloroethene	5	3/9	32J	SB215	13.8
Tetrachloroethene	5	3/9	6	SB219	4.0
Aroclor 1248	80	1/1	6800	SB229	6800
bis(2-ethylhexyl)phthalate	350	3/9	62J	SB217	62
Di-n-butyl phthalate	350	3/9	40J	SB227	40
Dibenzofuran	350	1/12	109J	SB217	109
Naphthalene	350	1/12	86J	SB217	86
Acenaphthene	350	1/12	270J	SB217	213
Fluorene	350	1/12	180J	SB217	180
Anthracene	350	1/12	220J	SB217	196
Phenanthrene	350	5/9	1300	SB217	564
Fluoranthene	350	5/9	1900	SB217	805
Pyrene	350	5/9	1800	SB217	760
Benzo[b]fluoranthene	350	3/9	980	SB217	462
Benzo[k]fluoranthene	350	3/9	730	SB217	369
Benzo[a]pyrene	350	3/9	810	SB217	397
Indeno[1,2,3,-c,d]pyrene	350	2/9	62J	SB229	62
Benzo[g,h,i]perylene	350	3/9	490	SB217	281
Benz[a]anthracene	350	2/9	740	SB217	379
Chrysene	350	2/9	910	SB217	444
2-Methylnaphthalene	350	1/9	52J	SB217	52
TIC PCBs	-	3/9	P	SB229	-

Background soil concentrations are presented in Table 4-4.

\* Upper 95% confidence limit (UCL) on arithmetic average, or maximum if UCL exceeds maximum detected.

- = Not Detected

CRQL = Contract Required Quantitation Limit

J = Estimated

P = Present

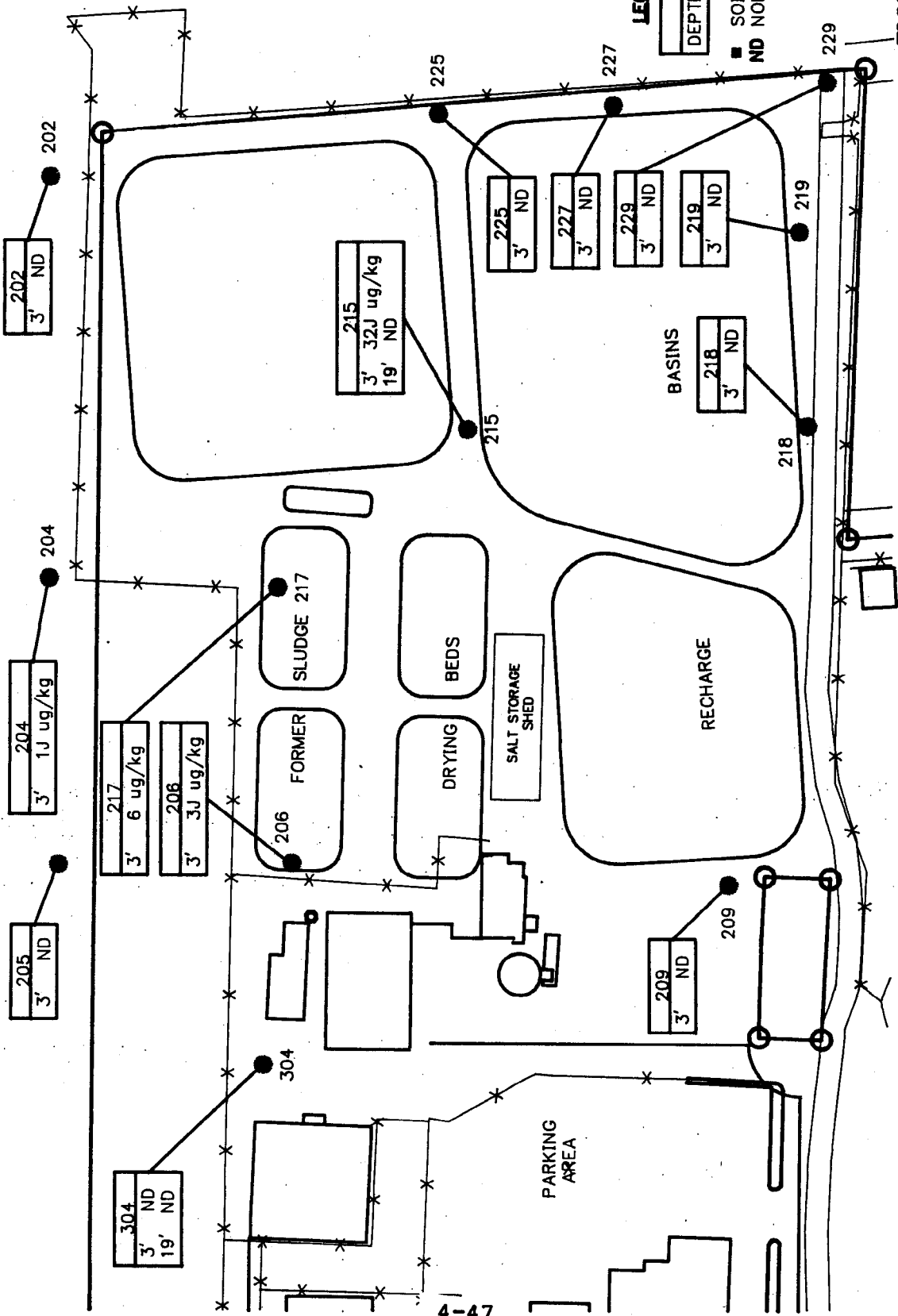
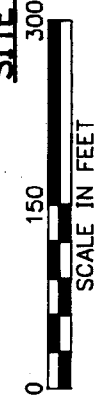
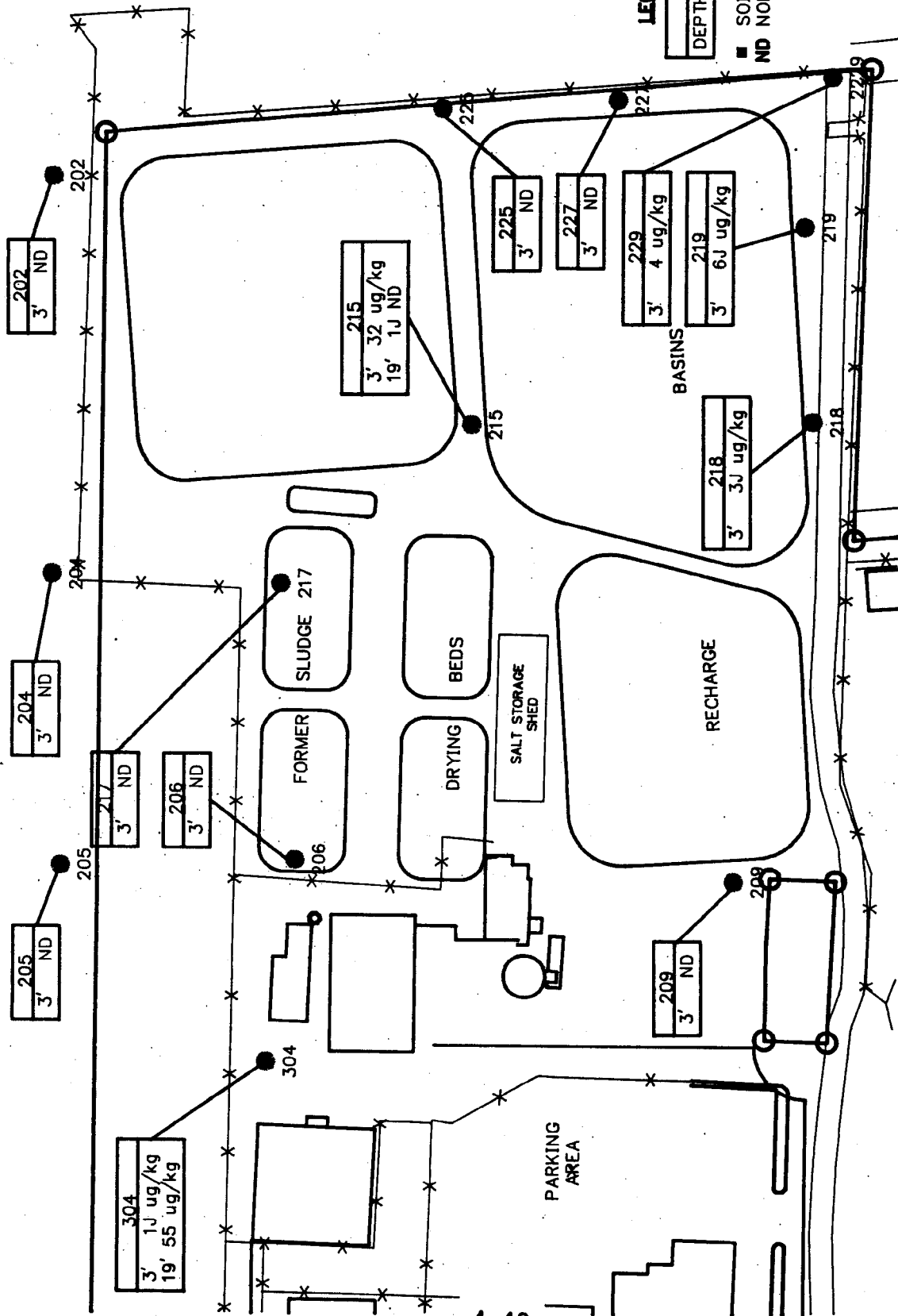

FIGURE 4-20

SITE 2 - SUBSURFACE SOIL RESULTS - ICE  
REMEDIAL INVESTIGATION  
NWIRP, BETHPAGE, NY





4-48

FIGURE 4-21

SITE 2 - SUBSURFACE SOIL RESULTS - PCE  
 REMEDIAL INVESTIGATION  
 NWRRP, BETHPAGE, NY

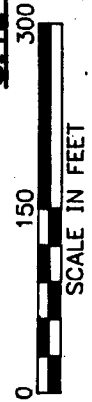

TABLE 4-15

OCCURRENCE AND DISTRIBUTION OF SUBSURFACE SOIL CONTAMINANTS  
 SITE 2 - INORGANIC (mg/kg)  
 MWIRP, BETHPAGE, NY

Element	CRDL	IDL	Number Positive Detections/ Samples Analyzed	Concentration Range	Location of Maximum Concentration	Representative Concentration
Aluminum	40	36.2	9/12	1600-9370	SB204 <sup>(1)</sup>	6767
Arsenic	2	0.78	7/12	ND-10.7	SB229	5.9
Barium	40	1.7	9/12	3.1-29.9	SB204 <sup>(1)</sup>	17.6
Mercury	0.1	0.10	4/12	ND-0.32	SB218	0.18
Silver	2	0.18/0.24	4/12	ND-2.65	SB206	1.3

Background soil concentrations are presented in Table 4-5.

\* Upper 95% confidence limit (UCL) on arithmetic average, or maximum if UCL exceeds maximum detected.

ND = Not Detected

CRDL = Contract Required Detection Limit

IDL = Instrument Detection Limit

(1) = Background sample

206, located near SB-217, also exhibited notable levels of several metals.

#### 4.2.4 Groundwater Data

The monitoring well sample locations are displayed on Figure 2-5. For Site 2, monitoring well GM-8 and, to a limited extent, GM-7 served as upgradient monitoring wells. Monitoring wells HN-30, HN-27, and HN-26 served as downgradient monitoring wells. The results of the organic analyses of monitoring wells are presented in Table 4-16. The distribution of organic contaminants detected above MCLs is displayed on Figures 4-22 and 4-23.

It can be seen that chlorinated ethenes and ethanes were detected in most wells, although at a much lower concentration than those found at Site 1. Most notable were concentrations of TCE ranging up to 11 ug/l, concentrations of PCE ranging up to 6 ug/l, concentrations of toluene ranging up to 10 ug/l, and concentrations of 1,1,1-TCA ranging up to 4 ug/l. Most of these maximum concentrations were reported in the hydraulically downgradient portions of the site.

For comparative purposes, VOCs detected in Grumman wells north (hydraulically upgradient) of Site 2 (sampled in October 1991) are displayed here:

Chemical	GM-7S	GM-7I	GM-7D	GM-8S	GM-8I
1,1,1-TCA	4J	2J	2J	ND	2J
TCE	6	11	8	ND	6
PCE	ND	3J	ND	ND	ND

(ND indicates that the chemical was not detected. J indicates that the value is estimated.)

A comparison of volatile organic results in the deep monitoring well (HN-08D) at Site 2 and the corresponding intermediate monitoring well (GM-8I), found similar or slightly lower concentrations of volatile organics in the deeper well. This monitoring well is considered an upgradient monitoring well for Site 2, although because of the influence of the recharge basins, this well may periodically also be considered a downgradient monitoring well. There are no significant new conclusions that can be determined from this data.

TICs were detected in almost every well. TICs included PAHs, substituted benzenes, alkanes, substituted phenols, chlorinated ethenes, and carboxylic acids. Quantitative risk assessment is not performed for TICs because the identities and quantities of TICs are uncertain. The quantities of TICs may be estimated, but these numbers are not appropriate for quantitative risk assessment since



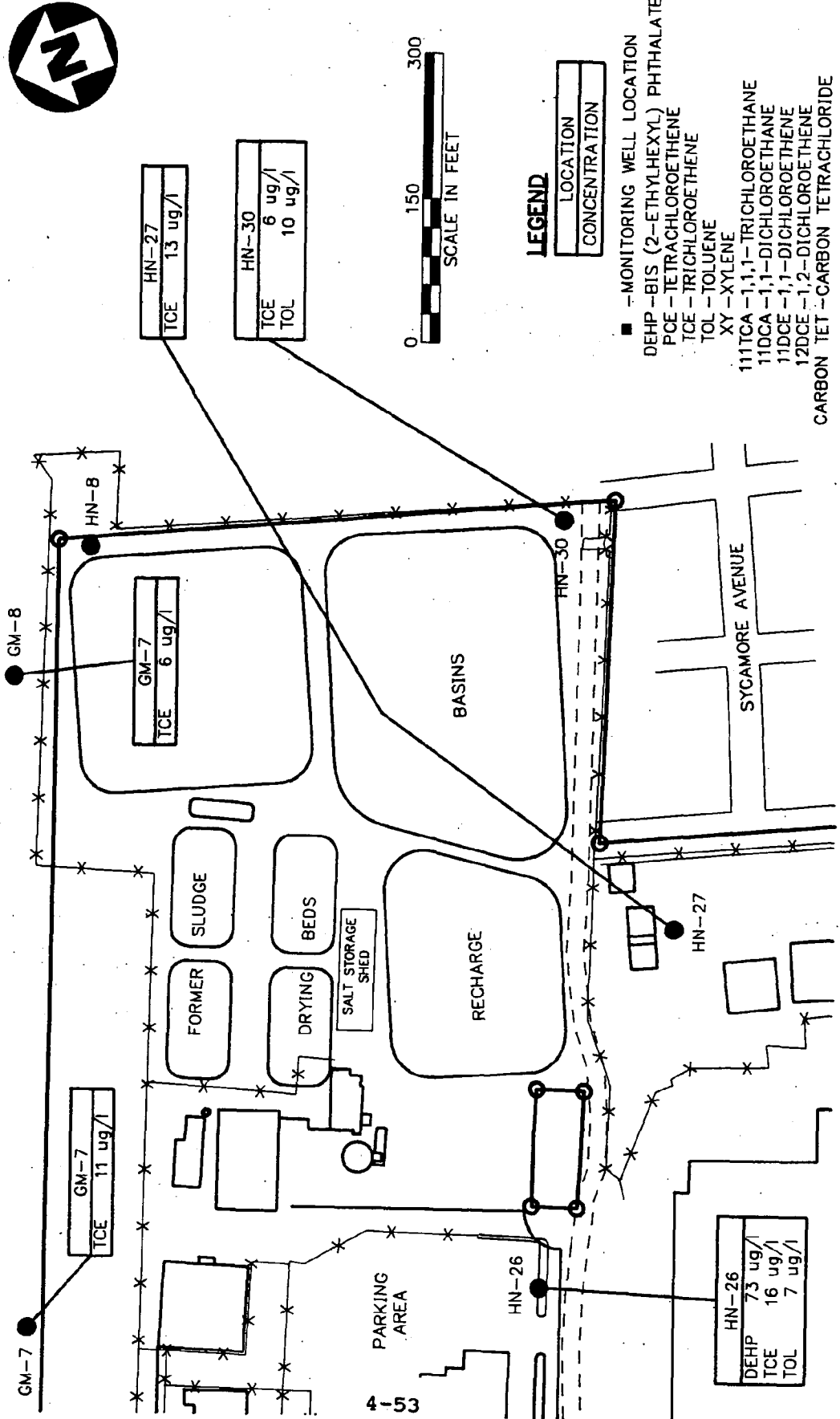

**INTERMEDIATE GROUNDWATER ORGANICS  
 ABOVE MCL'S. ALS. RFD  
 REMEDIAL INVESTIGATION  
 NWIRP, BETHPAGE, NEW YORK**

**FIGURE 4-23**



they may be over or under estimated by an order of magnitude. Those PAHs, benzenes, chlorinated ethenes, and substituted phenols that were confidently identified are addressed quantitatively in Section 6.0. The TOX profiles in Appendix I contain qualitative information about the toxicity of chemicals from these classes of compounds.

Both filtered and unfiltered groundwater samples were obtained from onsite wells (see Tables 4-17 and 4-18). The unfiltered inorganic results are presented in Table 4-17. This data will be used in the quantitative risk assessment, in accordance with EPA policy.

However, many monitoring wells contain significant amounts of sediment, which may result in overestimation of risks for metals in groundwater. Therefore, filtered results are also presented (see Table 4-18) and will be referred to as needed. The distribution of inorganics above MCLs or health-based levels in unfiltered monitoring wells is shown in Figures 4-24 and 4-25.

It can be seen from a comparison of Tables 4-17 and 4-18 that there are significantly lower concentrations of most metals in the filtered samples. Some inorganics, such as lead and nickel, were detected in the unfiltered samples but were not detected in the filtered samples.

Results for total chromium and hexavalent chromium are presented in Table 4-17. Because the proportions of trivalent and hexavalent chromium in the total chromium cannot be accurately determined, both the total and hexavalent results are given. For purposes of risk assessment, chromium will be assumed to be hexavalent where hexavalent chromium was not analyzed. Total chromium will be treated as trivalent and hexavalent chromium will be treated as hexavalent in the risk assessment for groundwater. Although this will result in some overestimation of risk, the toxicity of trivalent chromium is low enough, especially relative to hexavalent chromium, that its impact on the quantitative assessment will be negligible.

None of the inorganic results for HN-30 exceeded MCLS. The results were generally greater in HN-30I than HN-30S. There is no clear pattern or definable plume of inorganic contamination, although inorganic concentrations were highest in HN-27S. This well is considered a downgradient monitoring well for Site 2 and an upgradient monitoring well for Site 1. Wells upgradient of Site 2 were not analyzed for metals.

Generally, the concentration of the inorganics in the deep monitoring well as compared to the intermediate monitoring well are similar or lower. The only potentially significant difference is that hexavalent chromium was detected at 39 ug/l in the deep well, compared to 13 ug/l in the intermediate well. Whether or not this

TABLE 4-16  
 POSITIVE DETECTIONS OF ORGANIC GROUNDWATER CONTAMINANTS  
 SITE 2 (lb/l)  
 NJRIP, BETHPAGE, NEW YORK

Chemical	CRQL	GM-7S (upgrad)	GM-8S (upgrad)	HM-30S	HM-30SD (DUP. HM-30S)	GM-7I (upgrad)	GM-8I (upgrad)	HM-30I	HM-8D (upgrad)
Trichloroethene	5	6				11		6	5
Toluene	10							10	
1,1,1-Trichloroethane	5	4J		2J	3J	2J	2J		
Tetrachloroethene	5					3J	6J		

NA = Not Analyzed  
 CRQL = Contract Required Quantitation Limit  
 J = Estimated

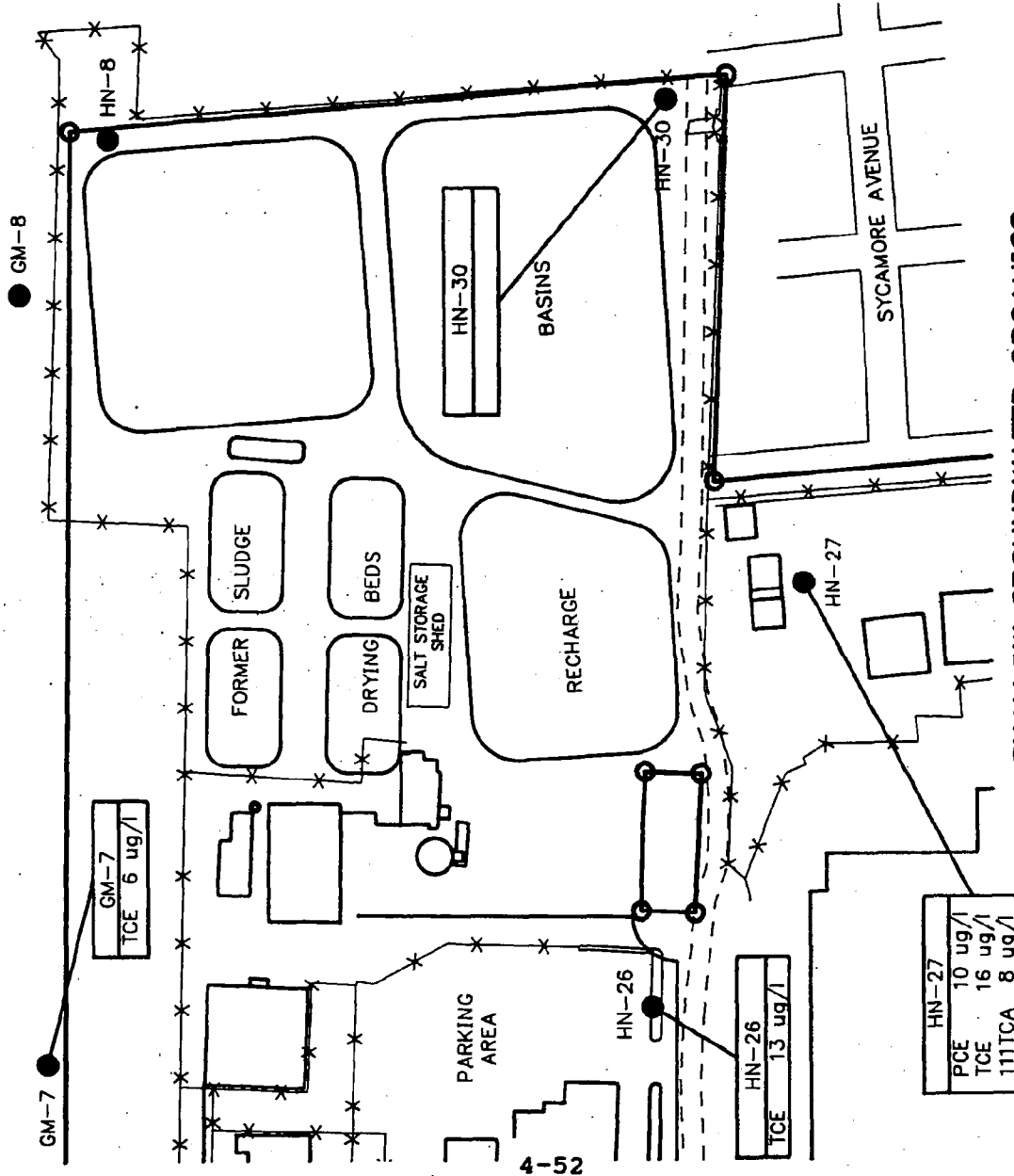

**SHALLOW GROUNDWATER ORGANICS**

**ABOVE MCLS. ALS. RFD**

**REMEDIAL INVESTIGATION**

**NWIRP, BETHPAGE, NEW YORK**

**FIGURE 4-22**



TABLE 4-17

POSITIVE DETECTIONS OF UNFILTERED INORGANIC GROUNDWATER CONTAMINANTS  
 SITE 2 (ug/l)  
 NJIRP, BETHPAGE, NEW YORK

Chemical	CRDL	IDL	GM-7S (Upgrad)	GM-BS (Upgrad)	HM-30S	HM-30SD (DUP. HM-30S)	GM-7I (Upgrad)	GM-8I (Upgrad)	HM-30I	HM-8D (Upgrad)
Aluminum	200	25.0	NA	NA	1210	2470J	NA	NA	1860	
Arsenic	10	1.0	NA	NA	1.8J	1.8J	NA	NA	9.7J	
Barium	200	8.0	NA	NA	39.6	52.2	NA	NA	42	
Cadmium	5	1.0	NA	NA	1.8		NA	NA		
Calcium	5000	13.0	NA	NA	7030	6650J	NA	NA	5770	6090
Chromium	10	8.0	NA	NA		8	NA	NA	13.8	39.8
Chromium VI	10	-	NA	NA			NA	NA	13	39
Copper	25	2.0	NA	NA	10.1	8.9	NA	NA	11.3	
Iron	100	21.0	NA	NA	6230	6980	NA	NA	4520	740
Lead	3	1.0	NA	NA	3	3J	NA	NA	3.6J	4.8
Magnesium	5000	45.0	NA	NA	2160	2070	NA	NA	1520	
Manganese	15	1.0	NA	NA	63.1	61.6	NA	NA	44.4	
Nickel	40	8.0	NA	NA		8.7	NA	NA		
Potassium	5000	633	NA	NA	1260	1530	NA	NA	7530	7750
Sodium	5000	21.0	NA	NA	1300	12100	NA	NA	18100	17600
Vanadium	50	4.0	NA	NA	7	9.9	NA	NA	23.6	
Zinc	20	5.0	NA	NA		49.4	NA	NA	35.8	27.1

NA = Not Analyzed  
 CRDL = Contract Required Detection Limit  
 IDL = Instrument Detection Limit  
 J = Estimated

TABLE 4-18  
 POSITIVE DETECTIONS OF FILTERED INORGANIC GROUNDWATER CONTAMINANTS  
 SITE 2 - (ug/l)  
 MWIRP, BETHPAGE, NEW YORK

Chemical	COOL	IDL	GM-7S (upgrad)	GM-8S (upgrad)	HM-30S	HM-30SD (DUP - HM-30S)	GM-7I (upgrad)	GM-8I (upgrad)	HM-30I	HM-8D (UPGRAD)
Aluminum	200	25.0	NA	NA			NA	NA	288J	
Arsenic	10	1.0	NA	NA		2.2J	NA	NA	11J	
Barium	200	8.0	NA	NA	8.8J	8.5J	NA	NA		
Cadmium	5	1.0	NA	NA		3.3J	NA	NA		
Calcium	5000	13.0	NA	NA	7480J	7490J	NA	NA	5490J	6540
Chromium	10	8.0	NA	NA			NA	NA	11.8J	36.9
Copper	25	2.0	NA	NA	3.4J	3.1J	NA	NA	3.1	
Iron	100	21.0	NA	NA	22.7J	27.9J	NA	NA	150J	
Magnesium	5000	45.0	NA	NA	2110J	2130J	NA	NA	1360J	
Manganese	15	1.0	NA	NA	8.1J	8.3J	NA	NA	2.5J	
Potassium	5000	633	NA	NA	1170	1150	NA	NA	8050J	10800
Sodium	5000	21.0	NA	NA	12800J	12800J	NA	NA	19200J	18800
Vanadium	50	4.0	NA	NA			NA	NA	8.1J	
Zinc	20	5.0	NA	NA		25.2J	NA	NA	7.7J	

IDL = Instrument Detection Limit  
 J = Estimated

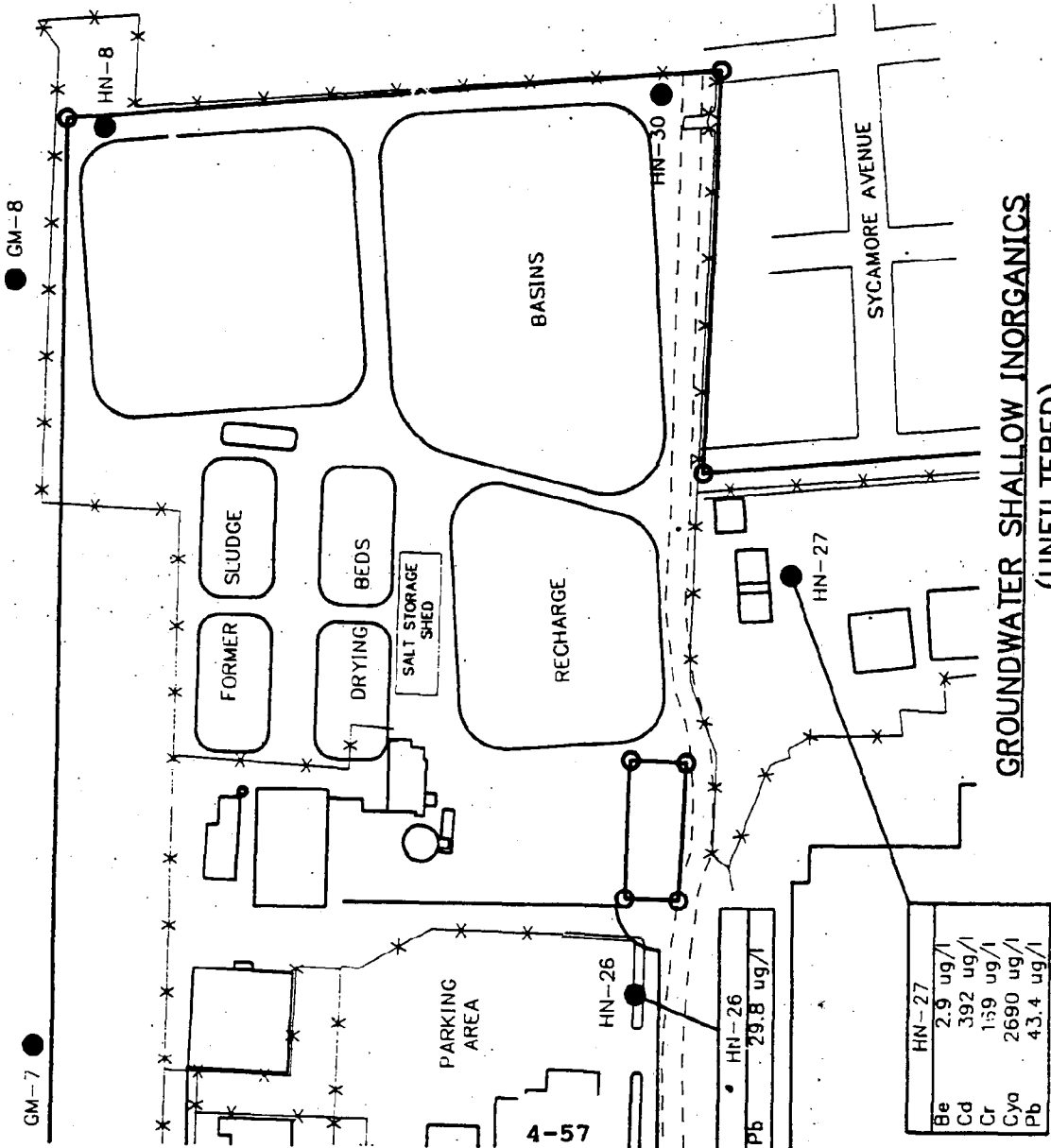

**GROUNDWATER SHALLOW INORGANICS (UNFILTERED)**

**REMEDIAL INVESTIGATION  
NWIRP, BETHPAGE, NEW YORK**

**FIGURE 4-24**



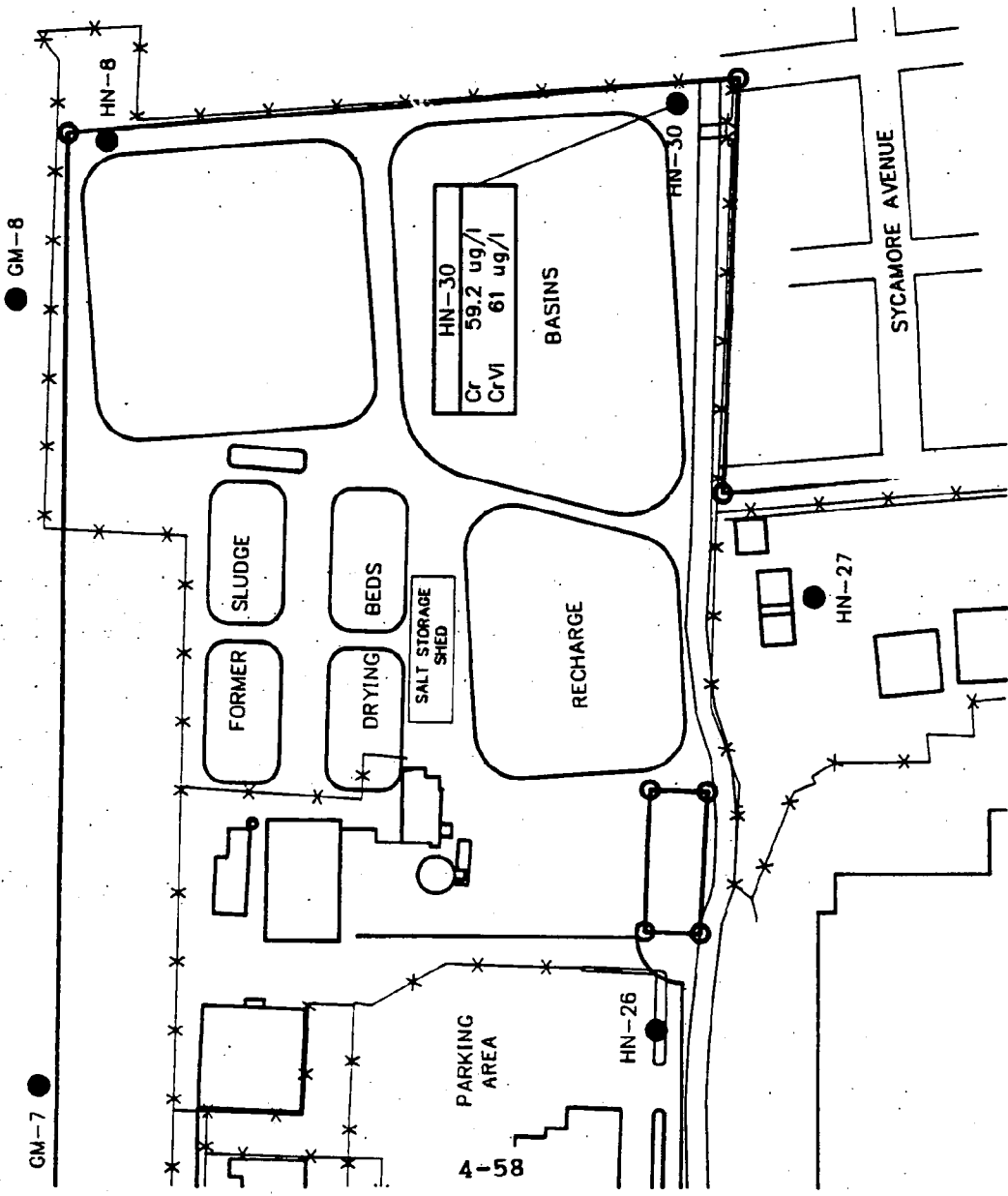

**LEGEND**

LOCATION	CONCENTRATION
----------	---------------

- As ARSENIC
- Be BERYLLIUM
- Cd CADMIUM
- Cr CHROMIUM (TOTAL)
- Pb LEAD
- V VANADIUM
- CrVI CHROMIUM (HEXAVALENT)

**GROUNDWATER INTERMEDIATE INORGANICS (UNFILTERED)**

**REMEDIAL INVESTIGATION  
NWIRP, BETHPAGE, NEW YORK**

**FIGURE 4-25**



**HALLIBURTON NUS**  
Environmental Corporation



is a significant difference cannot be determined from examining only one result.

#### 4.2.5 Surface Water and Sediments

Recharge basin surface water results are presented in Tables 4-19 and 4-20. Table 4-19 displays organic contaminants detected in surface water.

Trace to low-level VOCs were identified in the recharge basins. The most notable result is that of TCE at 35 ug/l. The distribution of TCE, PCE, and 1,1,1-TCA concentrations in surface water can be seen in Figure 4-26.

Table 4-20 displays inorganic elements detected in surface water. Both filtered and unfiltered samples were obtained. It can be seen that the filtered and unfiltered sample results for the recharge basin water are very similar, with only iron displaying a significant reduction in the filtered result. None of the results in Table 4-20 exceed drinking water criteria (See Table 6-10 in Section 6.0).

Recharge basin sediment samples were obtained at four locations in Site 2 on two dates (August and December 1991). Analytical results for these samples are summarized in Tables 4-21 and 4-22. PCE and TCE were detected at trace to very low levels in sediment (up to 8 ug/kg). Concentrations of the three major VOCs in sediment can be seen in Figure 4-27. PAHs (less than 3,000 ug/kg, total) and phthalate (less than 1,000 ug/kg, total) were also detected in sediment at concentrations similar to those reported elsewhere at the activity. A tentatively identified PCB, trichlorobiphenyl, was reported in sediment. PCBs as TICs are used mainly on a confirmation basis. TICs are not appropriate for quantitative risk assessment because their identities and quantities are uncertain. Those PCBs that were confidently identified are addressed quantitatively in Section 6.0. The TOX profiles in Appendix I contain qualitative information about the toxicity of PCBs.

Concentrations of metals in sediment were generally lower than concentrations reported in soil. Notable inorganic sediment contaminants included chromium (up to 27.5 mg/kg), copper (up to 141 mg/kg), lead, up to 23.2 mg/kg, mercury (up to 0.18 mg/kg), and silver (up to 0.3 mg/kg).

#### 4.2.6 Surface Soils

A total of 13 surface soil samples were obtained at Site 2. Sampling locations were selected based on historical information regarding site chemical handling and disposal activities. Surface soil samples were collected at points on a relatively uniform 300-foot by 300-foot grid and at field-determined, opportune locations. Sample locations are displayed on Figure 2-4. The analytical

TABLE 4-19

OCCURRENCE AND DISTRIBUTION OF  
 SURFACE WATER CONTAMINANTS SITE 2 - ORGANIC (ug/L)  
 MWIRP, BETHPAGE, NY

Compound	CRQL	Number Positive Detections/Samples Analyzed	Maximum Positive Concentration*	Location of Maximum Concentration
1,1-Dichloroethene	5	1/2	1J	SW01
1,1,1-Trichloroethane	5	2/2	6	SW01
Trichloroethene	5	2/2	35	SW01
1,1,2,2-Tetrachloroethane	5	1/2	3J	SW01

\* In a sample population of this size, the representative concentration equals the maximum positive concentration.

CRQL = Contract Required Quantitation Limit  
 J = Estimated

TABLE 4-21  
 OCCURRENCE AND DISTRIBUTION  
 OF RECHARGE BASIN SEDIMENT - ORGANIC (ug/kg)  
 MWIRP, BETHPAGE, NY

Compound	CRQL	Number Positive Detections/Samples Analyzed 8/28	Maximum Positive Concentration*	Location of Maximum Concentration 8/28	Number Positive Detections/Samples Analyzed 12/12	Maximum Positive Concentration *	Location of Maximum Detection 12/12
Trichloroethene	5	1/2	2.5J	SD201	2/2	8	SD200
Tetrachloroethene	5	2/2	6J	SD201	1/2	3J	SD200
Phenanthrene	330	2/2	175J	SD201	1/2	330J	SD100
Fluoranthene	330	2/2	225J	SD201	1/2	690J	SD100
Pyrene	330	2/2	235J	SD201	1/2	490J	SD100
Chrysene	330	2/2	125J	SD201	1/2	390J	SD100
Benzo[b]fluoranthene	330	2/2	126.5J	SD201	1/2	720J	SD100
Benzo[k]fluoranthene	330	2/2	130J	SD202,201	-	-	-
Benzo[a]pyrene	330	2/2	118.5J	SD201	1/2	250J	SD100
Benzo[g,h,i]perylene	330	2/2	99J	SD201	1/2	280J	SD100
Benzo[a]anthracene	330	1/2	69.75	SD201	1/2	230J	SD100
Indeno[1,2,3-c,d]pyrene	330	1/2	91J	SD202	1/2	300J	SD100
Di-n-butyl phthalate	330	1/2	102J	SD202	-	-	-
Butyl benzyl phthalate	330	1/2	250J	SD202	-	-	-
Bis(2-ethylhexyl)phthalate	330	2/2	310J	SD202	-	-	-
PCB (TIC - TCB)	-	2/2	P	-	-	-	-

J = Estimated  
 TIC = Tentatively Identified Compound  
 PCB = Polychlorinated biphenyl  
 TCB = Trichlorobiphenyl  
 \* In a sample population of this size, the representative concentration equals the maximum detection.  
 CRQL = Contract Required Quantitation Limit  
 P = Present

TABLE 4-22  
 OCCURRENCE AND DISTRIBUTION  
 OF RECHARGE BASIN SEDIMENT - INORGANIC (mg/kg)  
 WJTRP, BETHPAGE, NY

Compound	CRDL	IDL 12/12	IDL 8/28	Number Positive Detections/ Samples Analyzed - 8/28	Range of Concentrations*	Number Positive Detections/ Samples Analyzed - 12/12	Range of Concentrations	Location of Maximum Concentration 8/28	Location of Maximum Concentration 12/12
Aluminum	40	5.0	36.2	2/2	1030J-1110J	2/2	1020-1340	SD201	SD200
Arsenic	2	0.2	0.78	2/2	1.7-2.8	2/2	0.83-1.6	SD201	SD200
Barium	40	1.6	1.7	2/2	5.15-5.3	2/2	4-6.3	SD202	SD200
Calcium	1000	1000	58.2	0/2	ND-165.5	2/2	ND-176	SD201	SD200
Chromium	2	1.6	2.1	2/2	9.8J-18J	2/2	26.9-27.5	SD201	SD200
Copper	5	0.40	1.7	0/2	51.5-89.9	2/2	119J-141J	SD201	SD200
Iron	20	4.2	7.0	2/2	5610J-6480	2/2	2680-4510	SD201	SD200
Lead	0.6	0.2	0.38	2/2	4.2J-5.78J	2/2	15.3J-23.2J	SD201	SD200
Magnesium	1000	9.0	27.4	2/2	68.1-155.5	2/2	160-239	SD201	SD200
Manganese	3	0.2	1.0	2/2	19.8-74.7	2/2	19.8-28.6	SD202	SD200
Mercury	0.1	0.1	0.10	0/2	-	2/2	0.10-0.14	--	SD100
Nickel	8	1.6	4.8	0/2	-	2/2	3.2-3.8	--	SD200
Potassium	1000	127	72.0	1/2	ND-65.6	0/2	-	SD201	--
Silver	2	0.6	0.18	1/2	ND-0.3	1/2	ND-0.96	SD202	SD100
Sodium	1000	4.2	48.0	2/2	121-148.5	2/2	21.7-30.1	SD201	SD100
Vanadium	10	0.8	3.7	2/2	8.7-10.35	2/2	4.6-6.5	SD201	SD200
Zinc	4	1.0	3.1	-	-	2/2	14.1-19.2	--	SD200

TIC = Tentatively Identified Compound  
 IDL = Instrument Detection Limit  
 \* In a sample population of this size, the representative concentration equals the maximum detection.  
 CRDL = Contract Required Detection Limit

PCB = Polychlorinated biphenyl  
 J = Estimated  
 TCB = Trichlorobiphenyl  
 ND = Not detected

TABLE 4-20

OCURRENCE AND DISTRIBUTION  
OF SURFACE WATER CONTAMINANTS  
SITE 2 - INORGANIC (UG/L)  
WATRP, BETHPAGE, NY

Element	CRDL	IDL	Unfiltered Number Positive Detections/ Samples Analyzed	Maximum Positive Concentration*	Location of Maximum Concentration (Unfiltered)	Filtered Number Positive Detections/ Samples Analyzed	Maximum Positive Concentration*	Location of Maximum Concentration (Filtered)
Barium	200	8.0	2/2	10.6	SW003	2/2	10.6J	SW001
Calcium	5000	13.0	2/2	4700	SW003	2/2	4670J	SW003
Copper	25	2.0	2/2	109	SW003	2/2	99.2J	SW003
Iron	100	21.0	2/2	70.8	SW003	2/2	44.1J	SW001
Magnesium	5000	45.0	2/2	1510	SW003	2/2	1480J	SW003
Manganese	15	1.0	2/2	6.2	SW003	2/2	6.2J	SW003
Potassium	5000	633	2/2	1040	SW001	1/2	876	SW001
Sodium	5000	21.0	2/2	26000	SW001	2/2	27500J	SW001
Zinc	20	5.0	2/2	29.7	SW003	2/2	31J	SW003

\* In a sample population of this size, the representative concentration equals the maximum positive concentration.

CRDL = Contract Required Detection Limit.

IDL = Instrument Detection Limit.

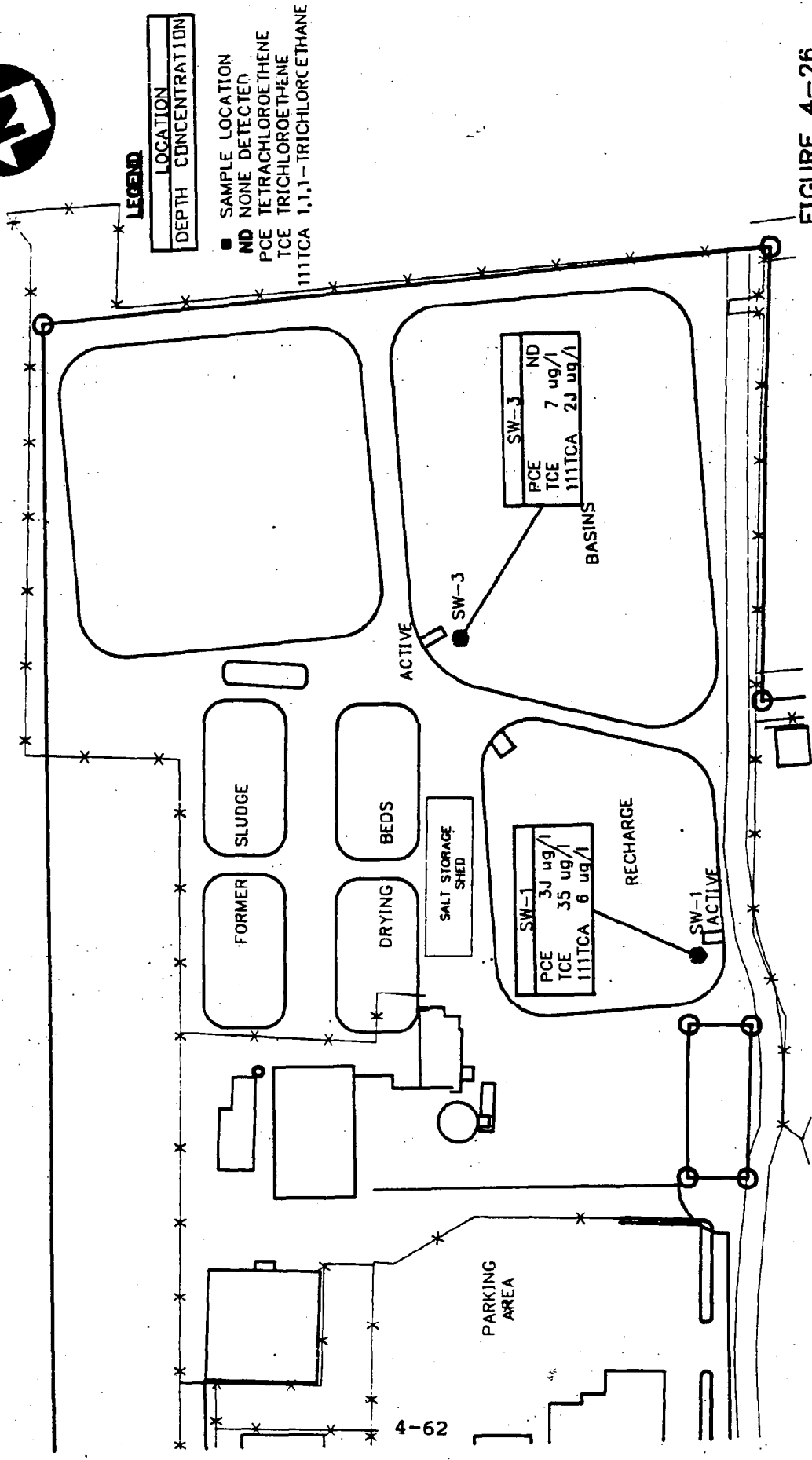
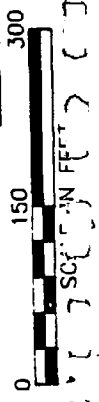

FIGURE 4-26

**SITE 2 - SURFACE WATER RESULTS - ORGANICS**  
**REMEDIAL INVESTIGATION**  
 NWRRP, BETHPAGE, NY



ACAD: 3281\SITE2.DWG 02/27/92 MB PS-LIMITS 4-27.LAY

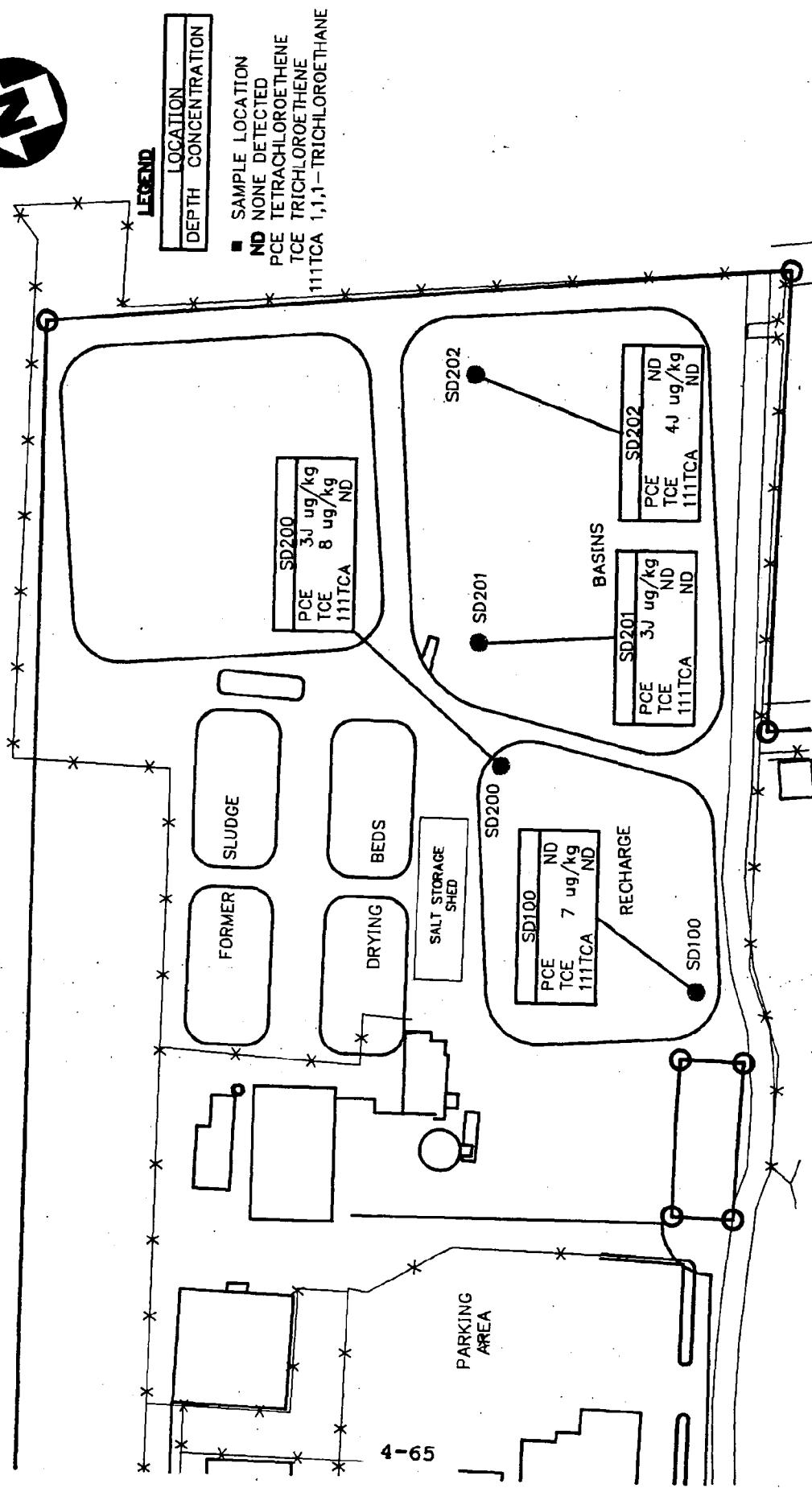
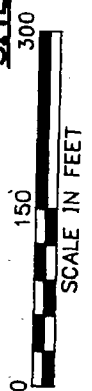

FIGURE 4-27

SITE 2 - SEDIMENT RESULTS - ORGANICS  
REMEDIAL INVESTIGATION  
NWIRP, BETHPAGE, NY



results for the surface soil samples are summarized in Tables 4-23 and 4-24. In general, trace to low levels of VOCs were detected in surface soil samples. The distribution of TCE is illustrated in Figure 4-28. TCE at 2.25 ug/kg was the only significant detection at Site 2.

Low to moderate concentrations of phthalate esters (under 1,200 ug/kg) and polynuclear aromatic hydrocarbons (PAHs) (under 20,000 ug/kg) were also detected throughout the site; no well-defined pattern of contamination by PAHs and phthalate is evident.

Polychlorinated biphenyls (PCBs), such as Aroclor 1248 and Aroclor 1254, were identified in surface soils. PCBs were detected in most areas of Site 2, especially the southern and western portions. Concentrations of PCBs ranged up to 3,000 ug/kg. For comparative purposes, concentrations of organic compounds in background (subsurface) soil sample are shown in Table 4-4. It can be seen that PAHs, which are common environmental contaminants, were detected up to approximately 2,190 ug/kg in background soil.

Inorganic elements detected at the activity are displayed in Table 4-24. Almost all metals were detected above levels observed in background (subsurface) soil. However, there was no apparent pattern associated with this contamination. At Site 2, the highest-concentration samples were SS-15 and SS-16, which were located in the northwestern part of Site 2. Cyanide was detected at low levels. Substances associated particularly with plating detected at the sites are nickel, silver, cyanide, copper, and chromium (Sittig, 1985).

#### 4.2.7 Summary

The soil-gas results for Site 2 indicated a potential volatile organic source area near the middle of the site. Subsequent soil sampling in this area found slightly elevated concentrations of volatile organics. However, when compared with Site 1, the concentrations detected were relatively minor. Elevated concentrations of PCBs (6,800 ug/kg), PAHs, and inorganics were found in the soils at Site 2. There is no apparent distinct pattern associated with the non-volatile organic contamination.

The investigation of the recharge basins found moderate volatile organic contamination of the surface waters (TCE at 35 ug/l) and of the sediments (TCE and PCE up to 8 ug/kg). Since the production well waters were found to be more highly contaminated, it is likely that these recharge basins just redistribute contaminated groundwater.

The temporary monitoring well program and monitoring well program did not indicate that Site 2 is a unique source area of groundwater contamination. TCE was detected at maximum concentrations of 16 ug/l. Upgradient groundwater was contaminated at a maximum



TABLE 4-23

OCCURRENCE AND DISTRIBUTION OF SURFACE SOIL CONTAMINANTS  
SITE 2 - ORGANIC (ug/kg)  
MWIRP, BETHPAGE, NY

Compound	CRQL	Number Positive Detections/ Samples Analyzed	Maximum Positive Concentration	Location of Maximum Concentration	Representative Concentration*
Trichloroethene	5	1/13	2.25	SS226	2.25
Chloroform	5	1/13	1J	SS207	1.0
Toluene	5	6/13	6J	SS210	2.8
4-Methylphenol	330	1/13	75J	SS216	75
Aroclor 1248	80	1/1	1900	SS226	1900
bis(2-ethylhexyl) phthalate	330	6/13	300J	SS216	300
Butyl benzyl phthalate	350	3/13	890	SS216	354
2-Methylnaphthalene	330	1/13	107J	SS211	107
Naphthalene	330	1/13	210J	SS211	186
Acenaphthene	350	2/13	610J	SS211	278
Dibenzofuran	330	1/13	330J	SS211	215
Phenanthrene	330	10/13	3700	SS211	1041
Anthracene	330	2/13	760	SS211	314
Fluoranthene	330	12/13	3500	SS211	1091
Pyrene	330	12/13	2500	SS211	815
Benzo[a]anthracene	330	7/13	1200	SS211	446
Chrysene	330	8/13	1100	SS211	433
Benzo[b]fluoranthene	330	8/13	920	SS211	411
Benzo[k]fluoranthene	330	8/13	1200	SS211	454
Benzo[a]pyrene	330	7/13	1200	SS211	463
Indeno[1,2,3-cd]pyrene	330	5/13	690	SS211	313
Dibenz[a,h]anthracene	330	1/1	310J	SS211	210
Benzo[g,h,i]perylene	330	4/13	630	SS211	305
Fluorene	330	1/13	560	SS211	271
PCBs (TICs)	-	7/13	P	SS216	--

Background soil concentrations are presented in Table 4-4.

\* Upper 95% confidence limit (UCL) on arithmetic average, or maximum if UCL exceeds maximum detected.

- = Not Detected

TIC = Tentatively Identified Compound

PCB = Polychlorinated Biphenyl

CRQL = Contract Required Quantitation Limit

J = Estimated

P = Present

TABLE 4-24

**OCCURRENCE AND DISTRIBUTION OF SURFACE SOIL CONTAMINANTS  
SITE 2 - INORGANIC (mg/kg)  
MWIRP, BETHPAGE, NY**

Element	CRDL	IDL	Number Positive Detections/ Samples Analyzed	Concentration Range	Location of Maximum Concentration	Representative Concentration*
Aluminum	40	17.5/36.2	13/13	1790-19500J	SS215	9627
Arsenic	2	0.72/0.78	13/13	0.95J-10.45J	SS210	6.4
Barium	40	2.6/0.48/ 0.78	13/13	4.6-51.6J	SS215	26.0
Beryllium	1	0.2/0.76	1/13	ND-0.88	SS215	0.48
Chromium	2	1.9/2.1	13/13	4.2J-419J	SS216	128
Cobalt	10	2.9/4.4	4/13	ND-15.2	SS215	5.9
Copper	5	1.7	1/2	ND-61.2	SS226	61.2
Iron	20	7.0/7.4	13/13	4810J-26600J	SS215	13007
Mercury	0.10	0.10	2/5	ND-0.22	SS216	0.11
Nickel	8	6.2/4.8	7/11	ND-10.7J	SS225	7.8
Silver	2	0.18	4/9	ND-6.3	SS225	0.82
Vanadium	10	2.9/3.7	13/13	7.3J-87.7J	SS215	32.2
Cyanide	2	3.1/2.0	1/13	ND-3.1	SS216	1.5

Background soil concentrations are presented in Table 4-5.

\* Upper 95% confidence limit (UCL) on arithmetic average, or maximum if UCL exceeds maximum detected

ND = Not Detected

CRDL = Contract Required Detection Limit

IDL = Instrument Detection Limit

J = Estimated

ACAD: 3281\SITE2.DWG

02/27/92

MB

PS-LIMITS

4-28.LAY

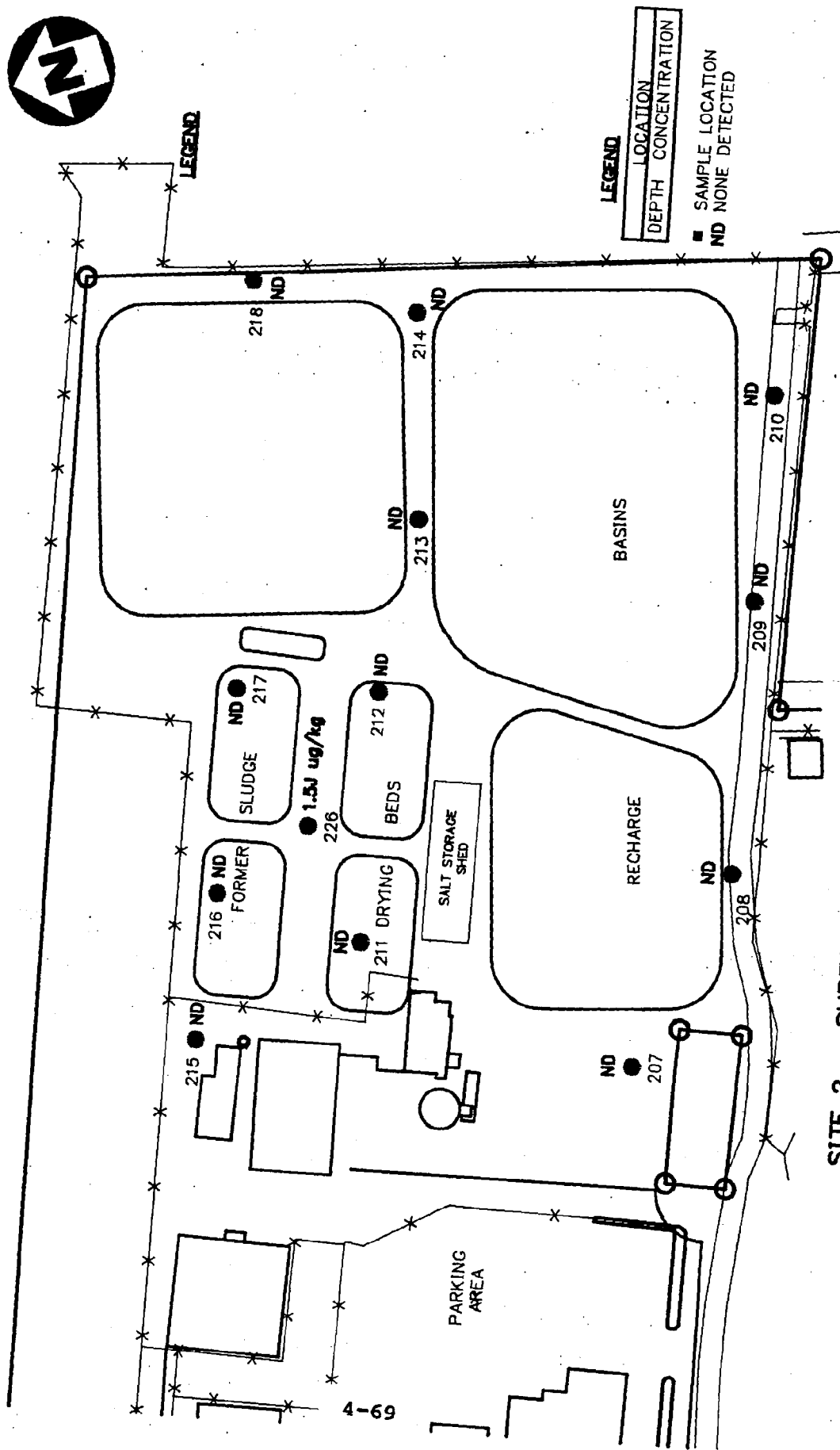

**SITE 2 - SURFACE SOIL RESULTS - ICE**  
**REMEDIAL INVESTIGATION**  
**NWRP, BETHPAGE, NY**

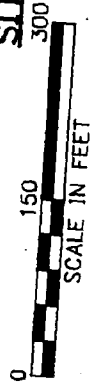

**FIGURE 4-28**

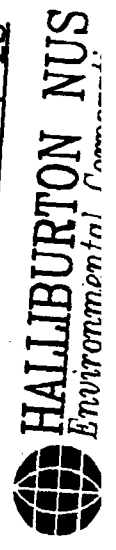

concentration of 11 ug/l. Inorganic contamination was also found and, similar to the organic contamination, was relatively minor compared to the organic contamination at the other sites.

#### **4.3 Salvage Storage Area (Site 3)**

##### **4.3.1 Soil-Gas**

Soil-gas sampling was done to help define the extent of volatile organic contamination and to assist in the selection of sampling locations. The analysis included the parameters of 1,1-DCE, t-1,2-DCE, 1,1-DCA, c-1,2-DCE, 1,1,1-TCA, TCE, and PCE. Of these parameters, TCE and PCE were used as indicator chemicals. The concentrations referred to in this section are a sum of these two concentrations. Soil-gas sampling locations and results are presented in Figures 4-29 and 4-30.

The analytical results for Site 3 soil gas sampling are presented in Table 4-25. The pattern of soil-gas readings in Site 3 is not as clear as in the other two sites. Soil-gas readings ranged from non-detects (especially in the southeast corner) to very low detections of less than 1 ug/l (especially at the northern edge of the site), to 92 ug/l total TCE + PCE in the southwestern, almost central, part of the site.

QA/QC samples are also presented in Table 4-25. Analysis of the field control sample (blank) and laboratory blank results indicated minimal background contamination. The duplicate results were generally within +/- 30%. These results indicate that the data is of relatively good quality.

##### **4.3.2 Temporary Monitoring Wells**

Nine temporary wells at Site 3 were sampled and analyzed for volatile organics including vinyl chloride; 1,1-DCE; t-1,2-DCE; 1,1-DCA; c-1,2-DCE; 1,1,1-TCA; 1,2-DCA; TCE; PCE. The location of the temporary monitoring wells is presented in Figure 2-2. A summary of the organic contaminants detected at Site 3 is provided in Table 4-26.

TCE was the most abundant contaminant found in Site 3. It was detected in 8 wells with a maximum concentration of 76 ug/l in G-328. It was also found throughout the site (in lesser concentrations), in no distinct patterns. G-328 (located in the downgradient direction) contained maximum concentrations of C-1,2-DCE of 31 ug/l, TCE of 76 ug/l, and PCE of 57 ug/l. Lesser concentrations of these contaminants were found throughout the site in no distinct patterns. Low levels of 1,1,1-TCA and 1,1-DCA were also detected.

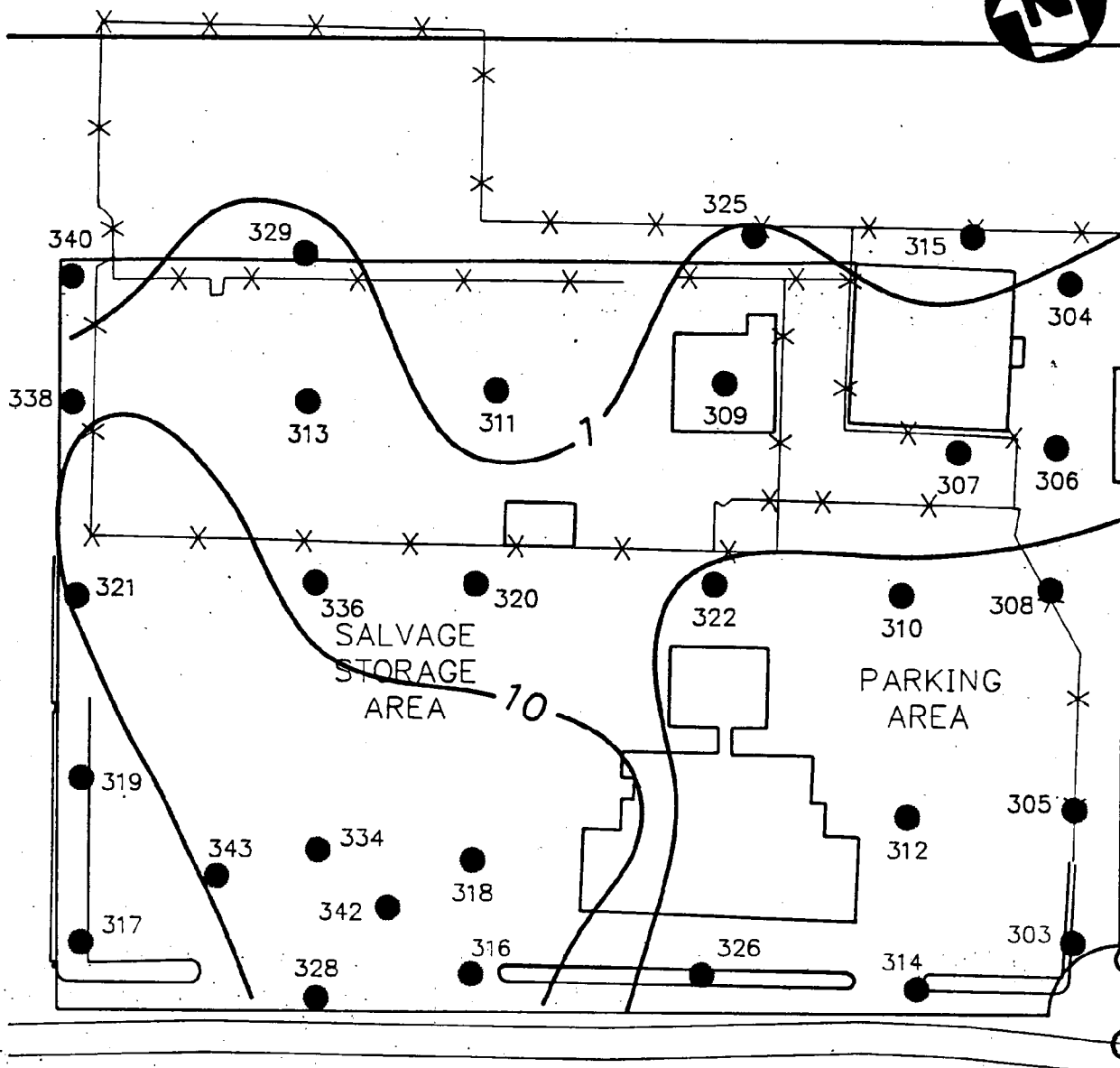

**LEGEND**

- SOIL GAS LOCATIONS
- 10 — TCE AND PCE (ug/l)

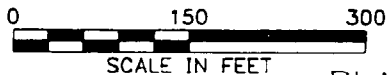

PLANT NO. 3

**FIGURE 4-29**

**SOIL GAS RESULTS - SHALLOW  
 REMEDIAL INVESTIGATION  
 NWIRP, BETHPAGE, NEW YORK 4-71**



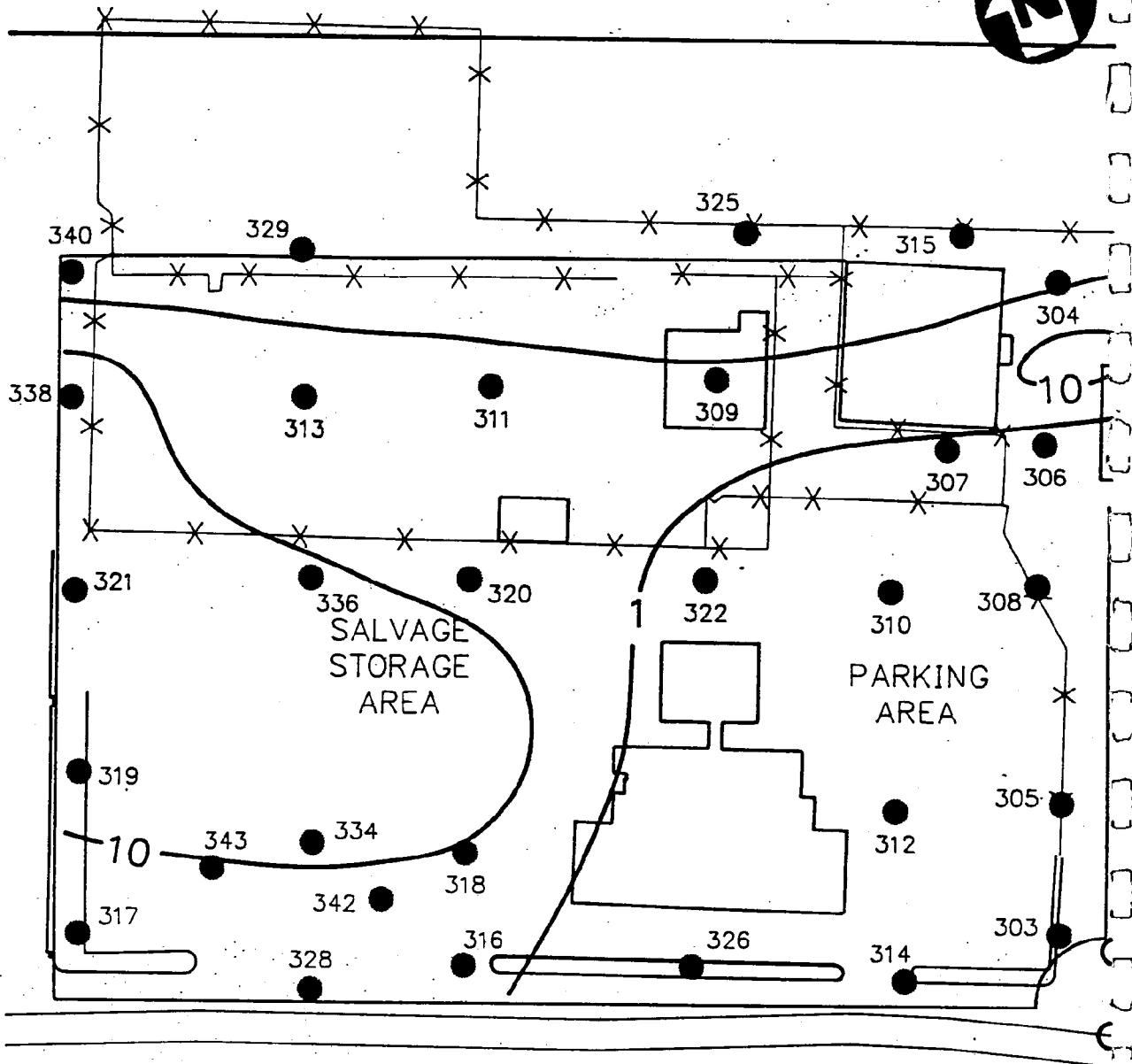

**LEGEND**

- SOIL GAS LOCATIONS
- 10 — TCE AND PCE (ug/l)

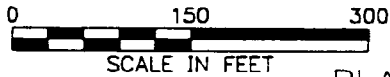

PLANT NO. 3

**FIGURE 4-30**

**SOIL GAS RESULTS - DEEP  
REMEDIAL INVESTIGATION  
NWIRP, BETHPAGE, NEW YORK**

4-72



TABLE 4-25  
SOIL-GAS RESULTS - SITE 3 (ug/l)  
MWIRP, BETHPAGE, NY

Sample	11DCE	t12DCE	11DCA	c12DCE	111TCA	TCE	PCE
303D	3.7	<1.0	<1.0	<1.0	0.14	0.13	0.20
303S	<1.0	<1.0	<1.0	<1.0	<0.10	<0.10	0.13
304D	43	<1.0	<1.0	<1.0	3.1	4.8	0.49
304S	17	<1.0	<1.0	<1.0	3.0	12	0.61
305D	14	<1.0	<1.0	<1.0	0.36	1.3	0.54
305S	3.3	<1.0	<1.0	<1.0	<0.10	0.21	0.12
306D	125	<1.0	<1.0	<1.0	37	9.7	0.67
306S	131	<1.0	<1.0	<1.0	46	12	0.67
307D	179	<1.0	<1.0	<1.0	48	9.2	0.76
307S	138	<1.0	<1.0	<1.0	60	10	0.97
308D	27	<1.0	<1.0	<1.0	0.54	0.87	0.46
308S	25	<1.0	<1.0	<1.0	0.51	0.52	0.33
309D	12	<1.0	<1.0	<1.0	0.37	0.28	1.4
309S	8.4	<1.0	<1.0	<1.0	0.19	0.37	2.3
310D	27	<1.0	<1.0	<1.0	0.30	<0.10	<0.05
310S	23	<1.0	<1.0	<1.0	0.30	<0.10	<0.05
311D	14	<1.0	<1.0	<1.0	14	2.2	0.05
311S	1.0	<1.0	<1.0	<1.0	0.50	<0.10	<0.05
312D	23	<1.0	<1.0	<1.0	0.15	<0.10	<0.05
312S	28	<1.0	<1.0	<1.0	0.14	<0.10	<0.05
313D	4.3	<1.0	<1.0	<1.0	1.3	1.00	0.35
313S	10	<1.0	<1.0	<1.0	2.8	2.7	1.7
314D	11	<1.0	<1.0	<1.0	0.12	<0.10	<0.05
314S	9.6	<1.0	<1.0	<1.0	<0.10	<0.10	<0.05
315D	<1.0	<1.0	<1.0	<1.0	<0.10	<0.10	<0.05
315S	4.5	<1.0	<1.0	<1.0	0.82	0.63	<0.05
316D	33	<1.0	<1.0	<1.0	3.0	3.6	8.5
316S	21	<1.0	<1.0	<1.0	1.9	1.7	8.9
317D	8.7	<1.0	<1.0	<1.0	0.70	0.88	0.87
317S	23	<1.0	<1.0	<1.0	1.9	1.8	3.5
318D	65	<1.0	1.1	7.4	4.9	47	51
318S	74	<1.0	<1.0	3.4	5.1	38	54

TABLE 4-25  
 SOIL-GAS RESULTS - SITE 3 (ug/l)  
 PAGE TWO

Sample	11DCE	t12DCE	11DCA	c12DCE	111TCA	TCE	PCE
319D	27	<1.0	<1.0	<1.0	2.3	4.4	9.6
319S	19	<1.0	<1.0	<1.0	1.7	4.0	2.7
320D	61	<1.0	<1.0	<1.0	3.8	0.95	0.93
320S	52	<1.0	<1.0	<1.0	3.0	0.23	1.0
321D	38	<1.0	9.3	20	11	17	4.4
321S	16	<1.0	1.8	3.6	5.8	15	2.6
322D	95	<1.0	<1.0	<1.0	2.1	0.35	0.24
322S	96	<1.0	<1.0	<1.0	2.4	0.28	0.31
325D	2.7	<1.0	<1.0	<1.0	0.22	0.12	0.49
325S	5.6	<1.0	<1.0	<1.0	0.63	0.32	0.89
326D	18	<1.0	<1.0	<1.0	0.23	<0.10	0.47
326S	5.0	<1.0	<1.0	<1.0	<0.10	<0.10	<0.05
327D	2.2	<1.0	<1.0	<1.0	<0.10	0.16	0.18
327S	3.8	<1.0	<1.0	<1.0	<0.10	0.20	0.34
328D	33	<1.0	<1.0	<1.0	2.4	9.7	2.8
328S	41	<1.0	<1.0	<1.0	4.0	4.9	5.5
329D	2.5	<1.0	<1.0	<1.0	<0.10	0.22	0.06
329S	2.6	<1.0	<1.0	<1.0	0.17	<0.10	0.08
334D	28	<1.0	11	1.6	3.5	13	12
334S*	50	<1.0	16	4.3	5.3	17	<0.05
336D	45	<1.0	3.9	<1.0	6.2	7.4	5.0
336S	26	<1.0	<1.0	<1.0	4.0	3.8	4.3
338D	42	<1.0	5.5	30	15	17	24
338S	28	<1.0	2.1	12	6.8	13	8.6
340D	5.4	<1.0	<1.0	<1.0	2.1	0.18	0.12
340S	<1.0	<1.0	<1.0	<1.0	0.15	0.16	0.16
341D*	71	<1.0	<1.0	<1.0	2.2	7.2	6.5
341S	39	<1.0	<1.0	<1.0	1.0	1.9	5.2
342D	18	<1.0	<1.0	<1.0	1.9	3.2	4.2
342S	31	<1.0	<1.0	<1.0	2.8	4.2	12
343D	9.5	<1.0	1.6	<1.0	1.1	1.5	1.6
343S	33	<1.0	<1.0	7.7	3.3	4.4	6.2



TABLE 4-25  
SOIL-GAS RESULTS - SITE 3 (ug/l)  
PAGE THREE

Sample	11DCE	t12DCE	11DCA	c12DCE	111TCA	TCE	PCE
<b>FIELD CONTROL SAMPLES</b>							
301	<1.0	<1.0	<1.0	<1.0	<0.10	<0.10	<0.05
302	<1.0	<1.0	<1.0	<1.0	<0.10	0.12	<0.05
323	<1.0	<1.0	<1.0	<1.0	<0.10	<0.10	0.05
324	<1.0	<1.0	<1.0	<1.0	<0.10	<0.10	<0.05
330	<1.0	<1.0	<1.0	<1.0	<0.10	<0.10	<0.05
331	<1.0	<1.0	<1.0	<1.0	<0.10	<0.10	<0.05
332	<1.0	<1.0	<1.0	<1.0	<0.10	<0.10	<0.05
342	<1.0	<1.0	<1.0	<1.0	<0.10	<0.10	<0.05
344	<1.0	<1.0	<1.0	<1.0	<0.10	<0.10	<0.05
<b>LABORATORY DUPLICATE ANALYSES</b>							
311D	14	<1.0	<1.0	<1.0	14	2.2	0.05
311DR	14	<1.0	<1.0	<1.0	14	2.2	0.07
312D	23	<1.0	<1.0	<1.0	0.15	<0.10	<0.05
312DR	22	<1.0	<1.0	<1.0	0.14	<0.10	<0.05
319D	27	<1.0	<1.0	<1.0	2.3	4.4	9.6
319DR	27	<1.0	<1.0	<1.0	2.3	4.4	9.0
336D	45	<1.0	3.9	<1.0	6.2	7.4	5.0
336DR	40	<1.0	2.3	<1.0	6.1	5.7	3.2
342D	18	<1.0	<1.0	<1.0	1.9	3.2	4.2
342DR	<1.0	<1.0	<1.0	<1.0	<0.10	<0.10	<0.05
<b>LABORATORY BLANKS</b>							
311DB	<1.0	<1.0	<1.0	<1.0	<0.10	<0.10	<0.05
B312DB	<1.0	<1.0	<1.0	<1.0	<0.10	<0.10	<0.05
319DB	<1.0	<1.0	<1.0	<1.0	<0.10	<0.10	<0.05
336DB	<1.0	<1.0	<1.0	<1.0	<0.10	<0.10	<0.05
342B	<1.0	<1.0	<1.0	<1.0	<0.10	<0.10	<0.05

11DCE = 1,1-dichloroethene  
t12DCE = trans-1,2-dichloroethene  
11DCA = 1,1-dichloroethane  
c12DCE = cis-1,2-dichloroethene  
111TCA = 1,1,1-trichloroethane  
TCE = trichloroethene  
PCE = tetrachloroethene

S = Shallow  
D = Deep

\* = Sample may contain higher concentrations of 111TCA, TCE and/or PCE.

TABLE 4-26  
 TEMPORARY MONITORING WELL  
 SITE 3 - ORGANIC RESULTS (ug/L)  
 MWIRP, BETHPAGE, NY

Temporary Well #	VC	11DCE	T12DCE	11DCA	C12DCE	111TCA	112DCA	2BTCE	PCE
304	5U	5U	5U	5U	5U	5U	5U	9	5U
307	5U	5U	5U	5U	5U	12	5U	12	5U
314	5U	5U	5U	5U	5U	5U	5U	8	5U
316	5U	5U	5U	5U	5U	5U	5U	12	5
318	5U	5U	5U	5U	5U	5U	5U	17	6
328	5U	5U	5U	5U	5U	7	5U	76	57
329	5U	5U	5U	5U	5U	5U	5U	5U	5U
334	5U	5U	5U	5U	5U	5U	5U	7	7
338	5U	5U	5U	22	10	10	5U	12	5U

U - Undetected  
 11DCE = 1,1-dichloroethene  
 t12DCE = trans-1,2-dichloroethene  
 11DCA = 1,1-dichloroethane  
 c12DCE = cis-1,2-dichloroethene  
 111TCA = 1,1,1-trichloroethane  
 TCE = trichloroethene  
 PCE = tetrachloroethene  
 VC = vinyl chloride

#### 4.3.3 Subsurface Soils

Subsurface sample locations are presented in Figure 2-3. Table 4-27 presents the distribution of organic chemicals in subsurface soil. Low-level VOCs, especially TCE and PCE, were detected at the site. Figures 4-31 and 4-32 illustrate the subsurface distribution of detections of TCE and PCE. At Site 3, PCE was detected at the 19-foot depth of SB-304 at 55 ug/kg. In general, concentrations of compounds in samples obtained at nineteen feet were not significantly greater than concentrations at 3 feet. There appears to be overall trace to low-level chlorinated ethene contamination at the site. PCBs were not confidently or tentatively identified in subsurface soils from Site 3.

PAHs, which are common environmental contaminants, were confidently and tentatively identified in subsoil throughout Site 3. Phthalate, which are plasticizers and are also common environmental contaminants as well as common blank contaminants, were detected at low concentrations at two locations at Site 3.

Quantitative risk assessment is not performed for TICs because the identities and quantities of TICs are uncertain. The quantities of TICs may be estimated, but these numbers are not appropriate for quantitative risk assessment since they may be over or under estimated by an order of magnitude. Those PAHs and phthalate that were confidently identified are addressed quantitatively in Section 6.0. The TOX profile in Appendix I contain qualitative information about the toxicity of PAHs and phthalate.

Chlorinated solvents were detected at trace levels in background soil samples (See Table 4-4). PAHs were also detected in background soil samples, up to approximately 7000 ug/kg.

Table 4-28 displays inorganic analytical results for subsurface soil. The highest-concentration samples in Site 3 are SB-334 and SB-328, which were located in the southwestern part of Site 3. The highest concentrations were only slightly above background levels.

#### 4.3.4 Groundwater Data

The results of organic analyses are shown in Table 4-29. For Site 3, monitoring wells GM-6 and GM-7 serve as upgradient monitoring wells. Monitoring wells HN-24, HN-25, and HN-26 serve as downgradient monitoring wells. The monitoring wells were sampled at shallow and intermediate depths. The monitoring well and production well sample locations are displayed on Figure 2-5.

Groundwater contamination by the VOCs TCE, PCE, and 1,1,1-TCA are illustrated in Figures 4-6, 4-7, and 4-8 for shallow-screened wells. The distribution of organic contaminants detected above MCLs is displayed on Figures 4-33 and 4-34.

TABLE 4-27

OCCURRENCE AND DISTRIBUTION OF SUBSURFACE SOIL CONTAMINANTS  
 SITE 3 - ORGANIC (ug/kg)  
 MWIRP, BETHPAGE, NY

Compound	CRQL	Number Positive Detections/ Samples Analyzed	Location of Maximum Concentration	Maximum Positive Concentration	Representative Concentration*
Acetone	10	1/15	SB316	65	17.7
2-Butanone	10	1/15	SB328	35	11.3
Trichloroethene	5	2/15	SB334	4J	3.0
Tetrachloroethene	5	11/15	SB304	55	13.9
1,2-Dichloroethene	5	1/15		4	2.8
1,1,2,2-Tetrachloroethane	5	1/15	SB318	1J	1.0
Toluene	5	1/15	SB328	1J	1.0
Bis(2-ethylhexyl)phthalate	330	1/8	SB304	140J	140
Butylbenzylphthalate	330	1/8		41	41
Fluoranthene	330	2/8	SB329	57	57
Pyrene	330	2/8	SB329	70	70
Benzo[b]fluoranthene	330	1/8	SB329	46	46
Benzo[k]fluoranthene	330	1/8	SB329	43	43
Benzo[a]pyrene	330	2/8	SB329	50	50
Benzo[g,h,i]perylene	330	1/8	SB329	41	41
Chrysene	330	2/8	SB329	43	43

Background concentrations are provided in Table 4-4.

\* Upper 95% confidence limit (UCL) on arithmetic average, or maximum if UCL exceeds maximum detected.

- = Not Detected

CRQL = Contract Required Quantitation Limit

J = Estimated

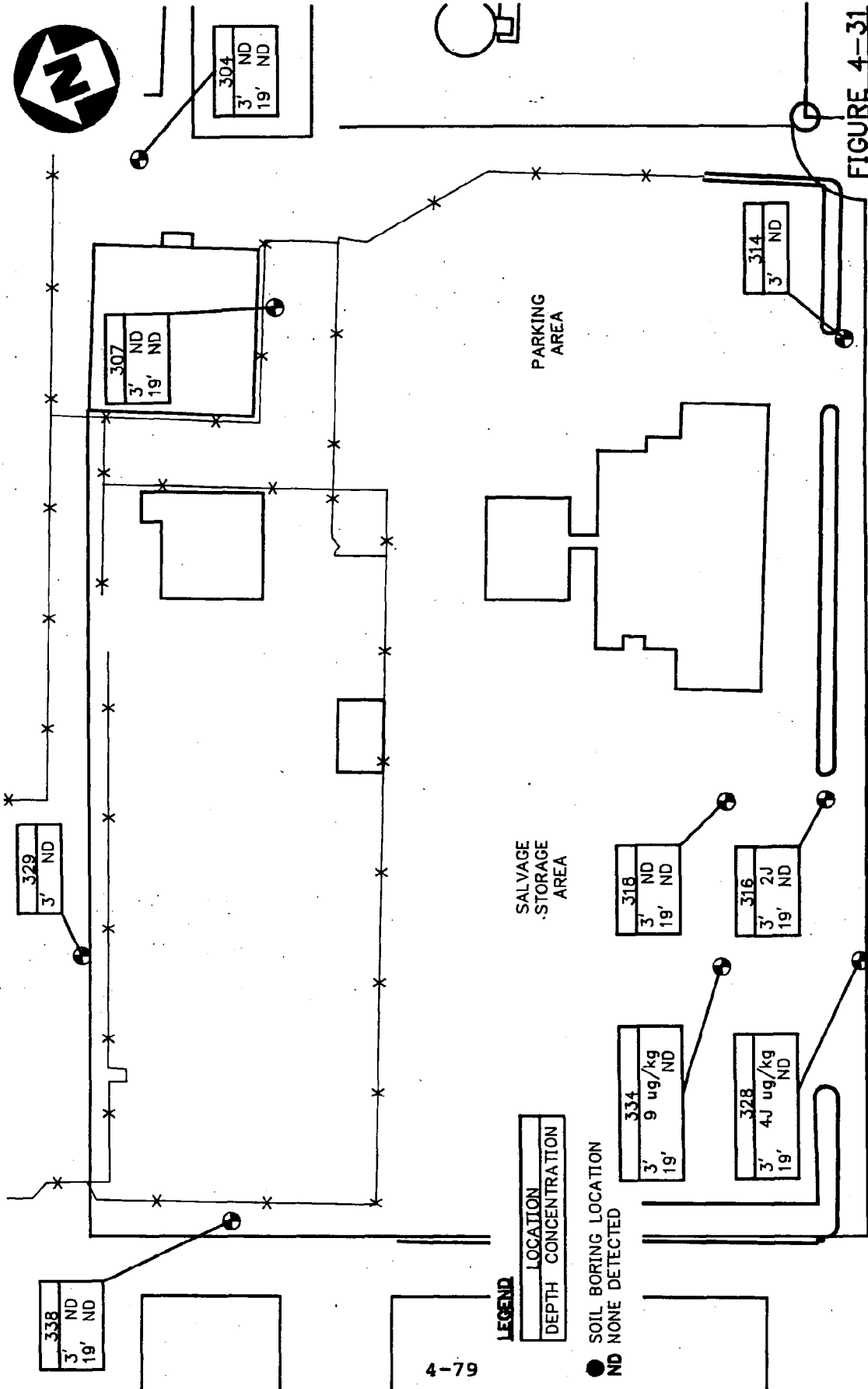

4-79

FIGURE 4-31

**SITE 3 - SUBSURFACE RESULTS - ICE  
REMEDIAL INVESTIGATION  
NWIRP, BETHPAGE, NY**

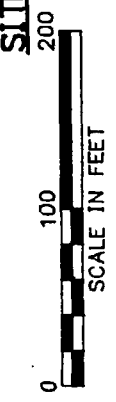

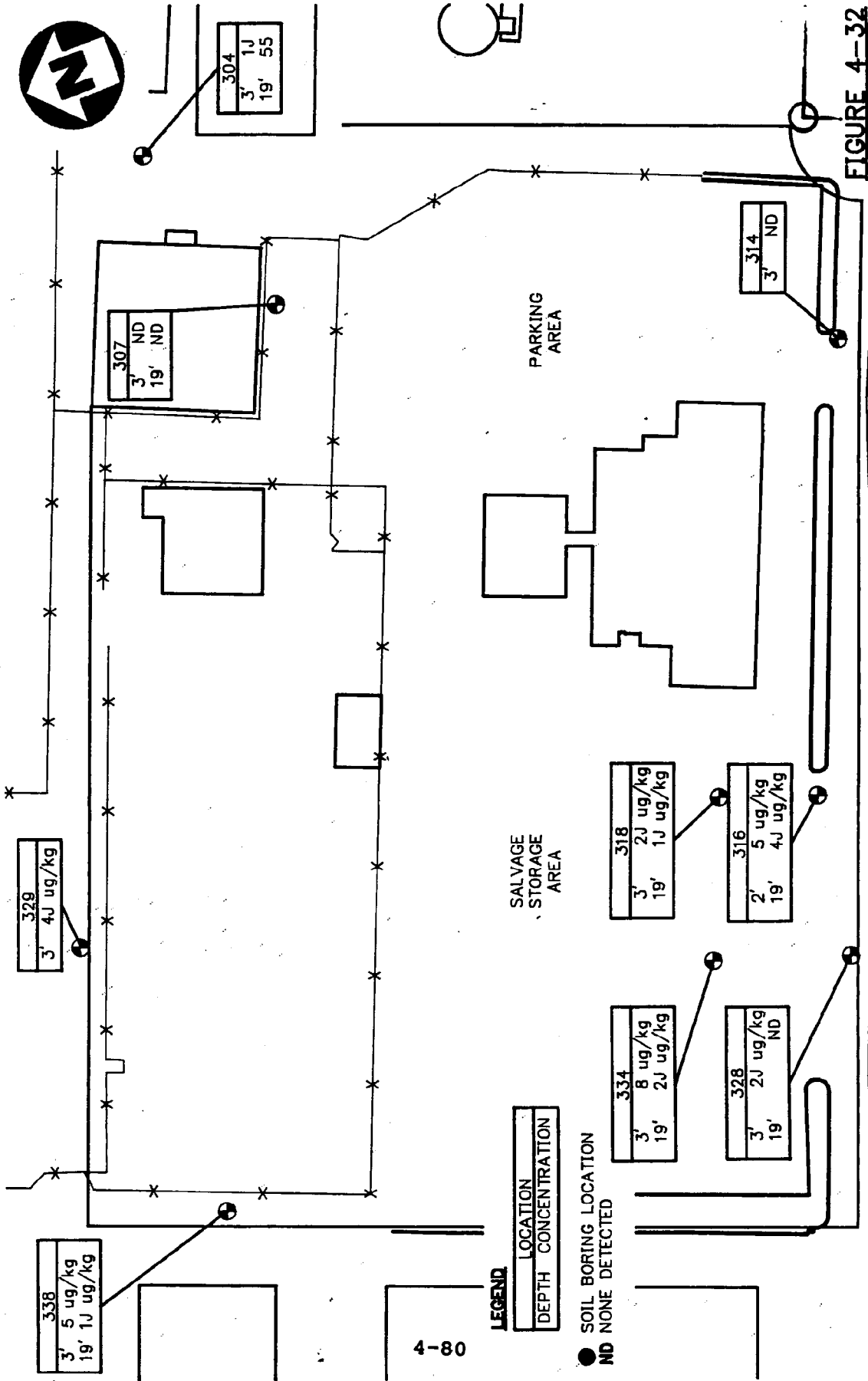

**SITE 3 - SUBSURFACE RESULTS - PCE**  
**REMEDIAL INVESTIGATION**  
**NWRP, BETHPAGE, NY**



**HALLIBURTON NUS**  
*Environmental Corporation*

FIGURE 4-32

TABLE 4-28

OCCURRENCE AND DISTRIBUTION OF SUBSURFACE SOIL CONTAMINANTS  
SITE 3 - INORGANIC (mg/kg)  
MWIRP, BETHPAGE, NY

Element	CRDL	IDL	Number Positive Detections/ Samples Analyzed	Location of Maximum Concentration	Concentration Range	Representative Concentration
Aluminum	40	36.2	8/8	SB328	1530-10400	6666
Arsenic	2	0.48/0.78	6/8	SB328	ND-4.6J	3.0
Barium	40	1.7	8/8	SB328	3.3-28.5	19.0
Chromium	2	2.1	5/5	SB329	2.4-12.7J	9.3
Copper	5	1.7	2/3	SB334	ND-8.8	8.8
Iron	20	7.0	5/5	SB329	4060-11400	8320
Lead	0.6	0.38/0.44	7/8	SB334	ND-12J	7.9
Manganese	3	1.0	6/6	SB334	52.1-267	195
Mercury	0.1	0.10	1/7	SB334	ND-0.18	0.11
Vanadium	10	3.7	5/5	SB329	4.3-17.9J	10.6
Zinc	4	3.1	3/3	SB329	7.4-20.0	20.1

Background concentrations are provided in Table 4-5.

\* Upper 95% confidence limit (UCL) on arithmetic average, or maximum if UCL exceeds maximum detected.

ND = Not Detected

- = Not detected

CRDL = Contract Required Detection Limit

IDL = Instrument Detection Limit

J = Estimated

TABLE 4-29  
 POSITIVE DETECTIONS OF ORGANIC CHLORINATED CONTAMINANTS - SITE 3  
 WASTEWATER, WESTWING, NEW YORK  
 (ug/l)

Chemicals	CRCL	CR-66 (ugrad)	CR-78 (ugrad)	CR-255 (ugrad)	CR-256 (ugrad)	CR-261 (ugrad)	CR-61 (ugrad)	CR-71 (ugrad)	CR-251 (ugrad)	CR-252 (ugrad)	CR-70 (ugrad)	CR-250 (DUP. OF CR-250)	PA-13	PA-15	PA-10	PA-11
Trichloroethene	5	6	120	13	61	380000	31	11	121	10	8	71	26	6	110	100
Toluene	5					9			51	51						
1,1-Dichloroethene	5			6												
1,2-Dichloroethene	5		100													
1,1,1-Trichloroethane	5	41	91	21	81	61		21			21		61		201	171
Tetrachloroethene	5		75	21	14	9		31				21	21	21	9	10
1,1-Dichloroethane	5				21	21							21		7	7
Bis(2-ethylhexyl)phthalate	10	NA	NA				NA	NA	44				32		95	180
Di-n-octylphthalate	10	NA	NA				NA	NA								
Di-n-butylphthalate	10	NA	NA				NA	NA								
Carbon Tetrachloride	5					8										

NA = Not Analyzed  
 CRCL = Contract Required Quantitation Limit  
 J = Estimated



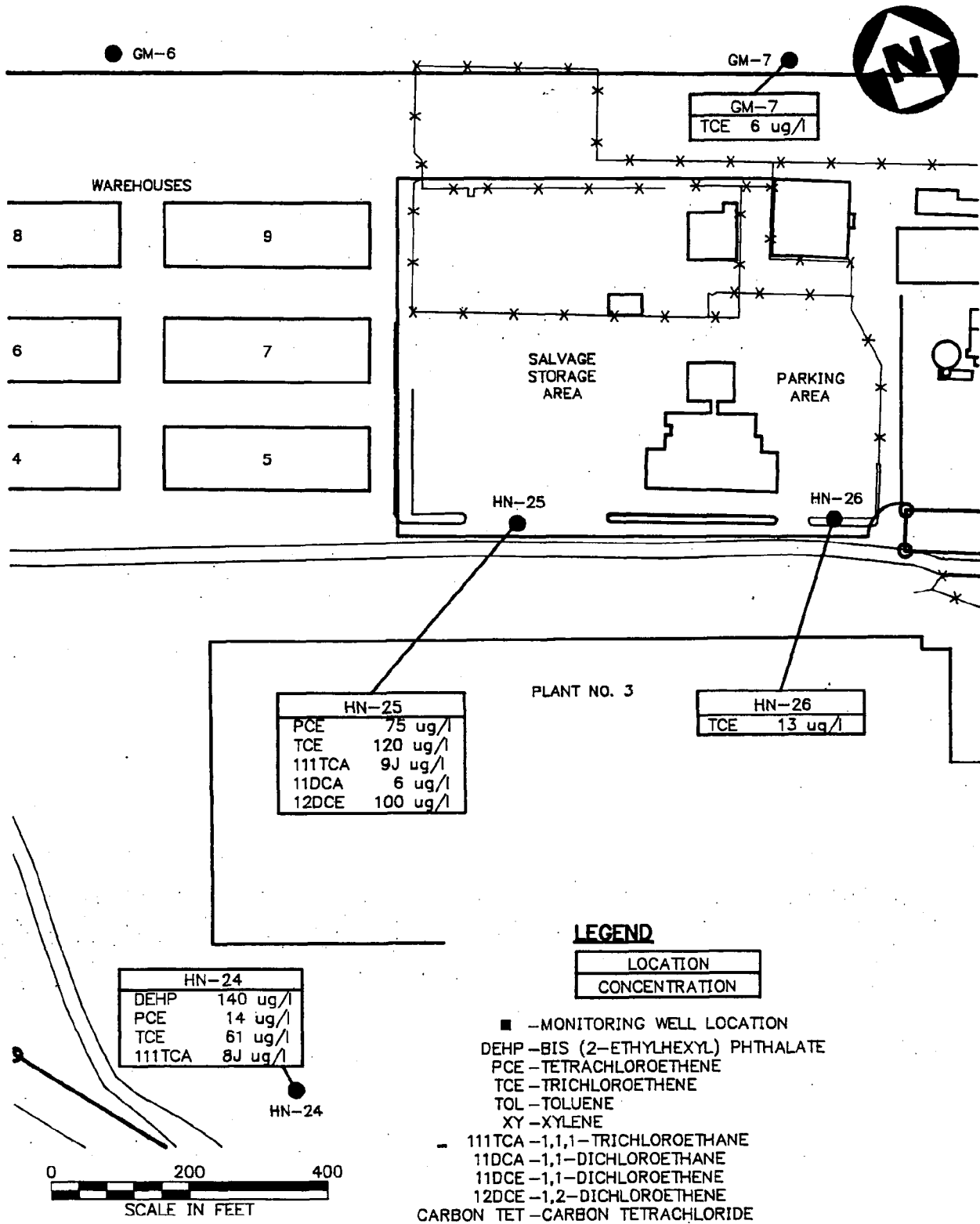

**SHALLOW GROUNDWATER ORGANICS**  
**ABOVE MCLS. ALS. RFD**  
**REMEDIAL INVESTIGATION**  
**NWIRP. BETHPAGE. NEW YORK**

**FIGURE 4-33**



**HALLIBURTON NUS**  
*Environmental Corporation*

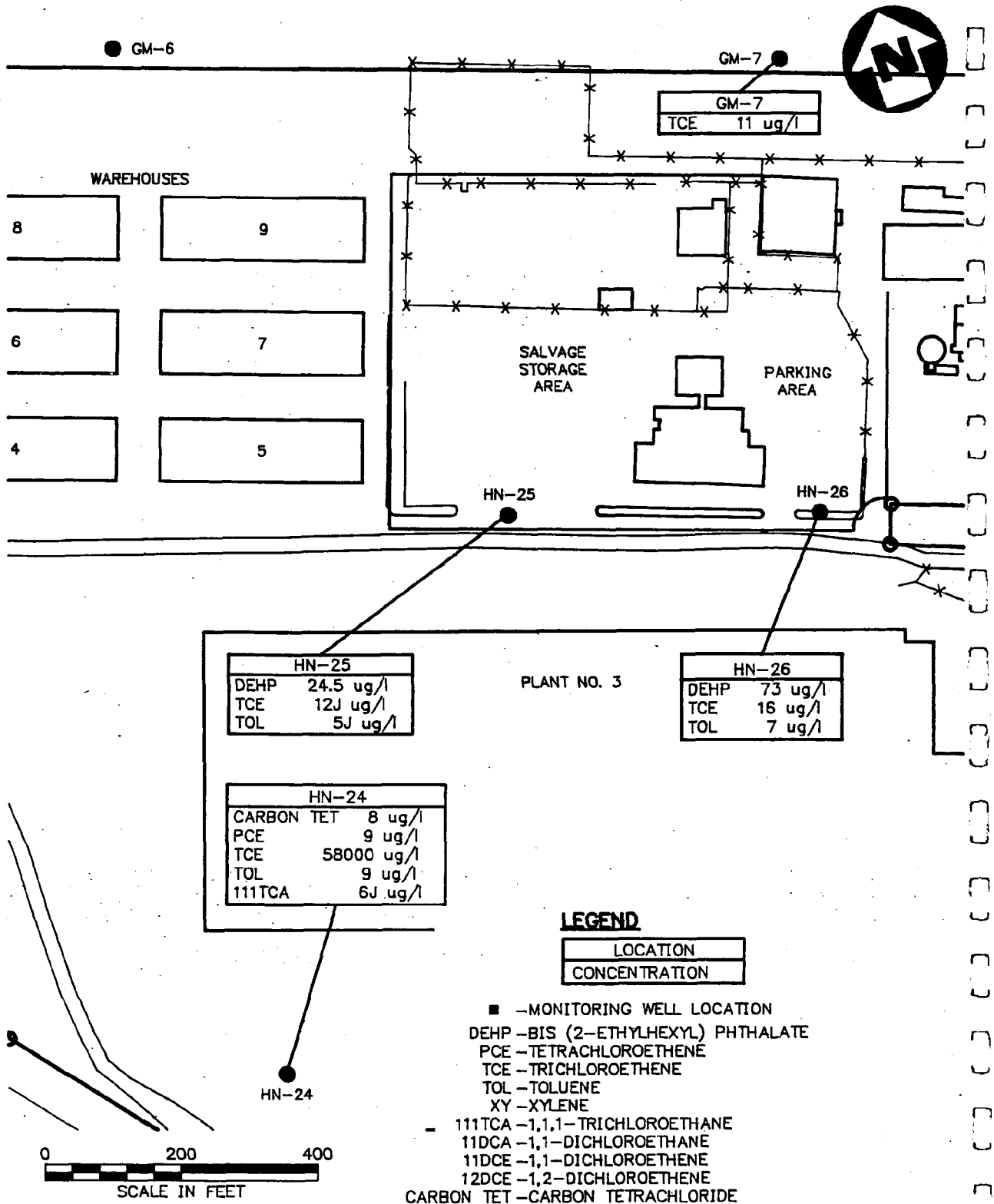

**INTERMEDIATE GROUNDWATER ORGANICS**

**FIGURE 4-34**

**ABOVE MCLS. ALS. RFD  
REMEDIAL INVESTIGATION  
NWIRP. BETHPAGE, NEW YORK**



It can be seen that chlorinated ethenes and ethanes were detected in most wells. Most notable were concentrations of TCE ranging up to 58,000 ug/l, concentrations of PCE ranging up to 75 ug/l, and concentrations of 1,2-DCE ranging up to 100 ug/l.

The maximum TCE concentration was detected in HN-24I, which was located at the southwestern corner of Plant No. 3. HN-25S also exhibited significant VOC contamination, although concentrations were less than those reported for HN-24.

For comparative purposes, VOCs detected in Grumman wells north of Site 3 (sampled in October 1991) are displayed here:

Chemical	GM-6S	GM-6I	GM-7S	GM-7I	GM-7D
1,1,1-TCA	ND	ND	4J	2J	2J
TCE	ND	3J	6	11	8
PCE	ND	ND	ND	3J	ND

(ND indicates that the chemical was not detected. J indicates that the value is estimated.)

It can be noted that concentrations of VOCs in HN-25I and HN-25S (in the southernmost part of Site 3) are greater than those of the Grumman wells. Thus the data indicates a potential source area at Plant 3 or groundwater from Site 1 may have migrated toward this area because of the influence of Production Wells.

Generally, VOCs are greater in shallow wells than in the intermediate wells, with the notable exception of TCE in HN-24I. Some VOCs were detected infrequently, including carbon tetrachloride and toluene.

A comparison of volatile organic results in the deep monitoring well (HN-25D) at Site 3 and the corresponding intermediate monitoring well (HN-25I) and a deep upgradient monitoring well (GM-7D), found similar or slightly lower concentrations of volatile organics. This monitoring well is considered a downgradient monitoring well for Site 3. There are no significant new conclusions that can be determined from this data.

Phthalate, which are common environmental contaminants, were detected in some wells. The highest DEHP levels occurred in HN-24S (140 ug/l), which is southwest of Plant No. 3.

TICs were detected in almost every well. TICs included PAHs, substituted benzenes, alkanes, substituted phenols, chlorinated ethenes, and carboxylic acids.

Quantitative risk assessment is not performed for TICs because the identities and quantities of TICs are uncertain. The quantities of TICs may be estimated, but these numbers are not appropriate for quantitative risk assessment since they may be over or under

estimated by an order of magnitude. Those PAHs, benzenes, chlorinated ethenes, and substituted phenols that were confidently identified are addressed quantitatively in Section 6.0. The TOX profiles in Appendix I contain qualitative information about the toxicity of chemicals from these classes of compounds.

Both filtered and unfiltered groundwater samples were obtained from onsite wells. The unfiltered inorganic results are presented in Table 4-30. These data will be used in the quantitative risk assessment, in accordance with EPA policy. However, many monitoring wells contain significant amounts of sediment, which may result in overestimation of risks for metals in groundwater. Therefore, filtered results are also presented (see Table 4-31) and will be referred to as needed. The distribution of inorganics above MCLs or health-based levels in unfiltered monitoring wells is shown in Figures 4-35 and 4-36.

It can be seen from a comparison of Tables 4-30 and 4-31 that there are significantly lower concentrations of most metals in the filtered samples. Some inorganics, such as cobalt, cadmium, mercury, and vanadium, were detected in the unfiltered samples but were not detected in the filtered samples.

Results for total chromium and hexavalent chromium are presented in Table 4-30. Because the proportions of trivalent and hexavalent chromium in the total chromium cannot be accurately determined, both the total and hexavalent results are given. For purposes of risk assessment, chromium will be assumed to be hexavalent where hexavalent chromium was not analyzed. Total chromium will be treated as trivalent, and hexavalent chromium will be treated as hexavalent in the risk assessment for groundwater. Although this will result in some overestimation of risk, the toxicity of trivalent chromium is low enough, especially relative to hexavalent chromium, that its impact on the quantitative assessment will be negligible.

Notable results in unfiltered monitoring wells include iron in HN-25S (155,000 ug/l); vanadium in HN-25S (359 ug/l); and thallium in HN-24I (3.1 ug/l). The only notable filtered result is thallium in HN-24S (17.1 ug/l). There is no clear pattern or definable plume of inorganic contamination, although inorganic concentrations were highest in HN-25S.

Generally, the concentration of the inorganics in the deep monitoring well as compared to the intermediate monitoring well are similar or lower. One significant difference is that hexavalent chromium was detected at 170 to 180 ug/l in the deep well as compared to 43 ug/l in the intermediate well. Since the deep upgradient monitoring well GM-7D was not sampled for inorganics, this data can not be used to confirm a chromium source area at Site 3. However, this result is likely to be a significant finding since the total chromium in the groundwater is greater than the MCL

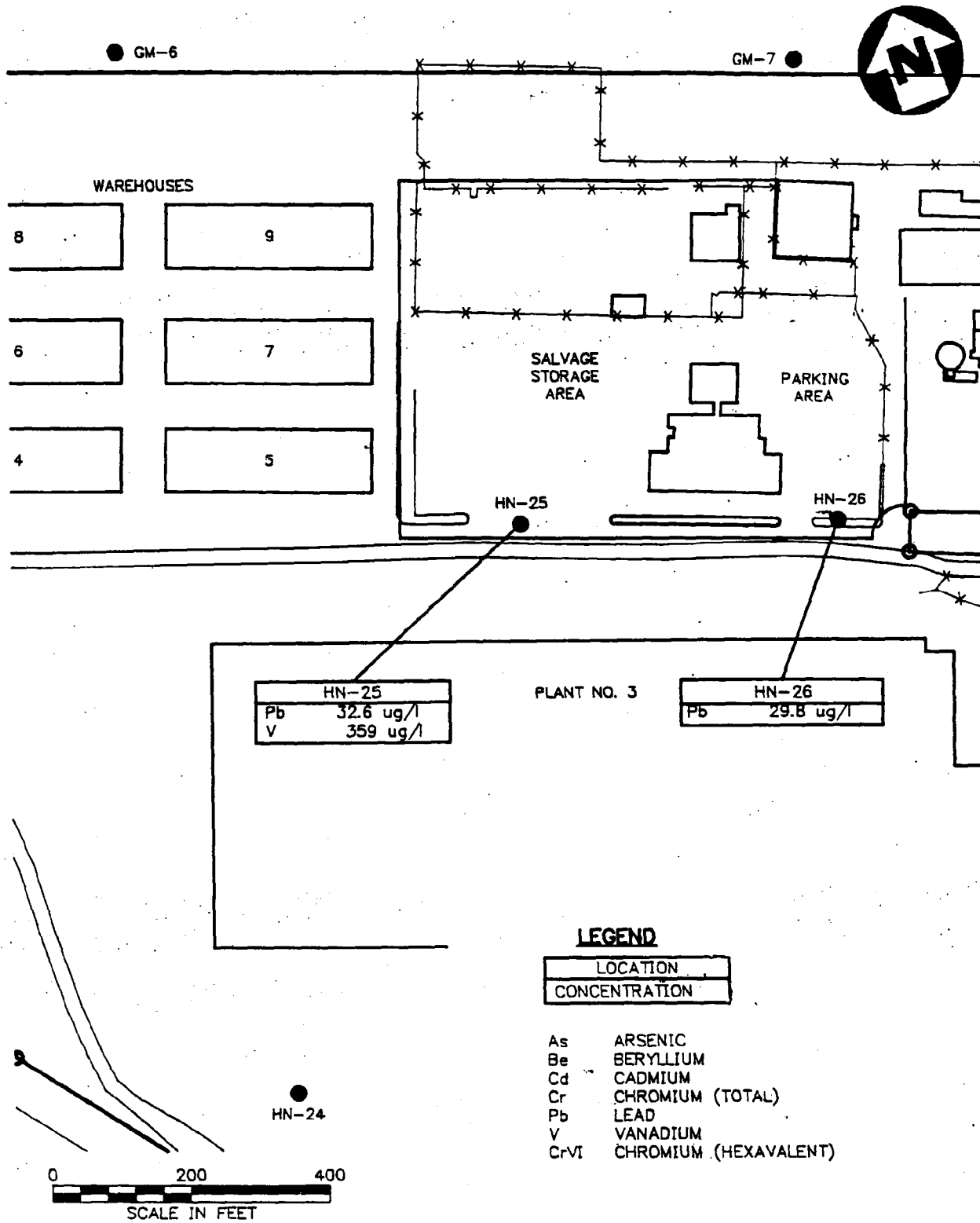

**GROUNDWATER SHALLOW INORGANICS  
(UNFILTERED)**

**REMEDIAL INVESTIGATION  
NWIRP, BETHPAGE, NEW YORK**

**FIGURE 4-35**



**HALLIBURTON NUS**  
*Environmental Corporation*

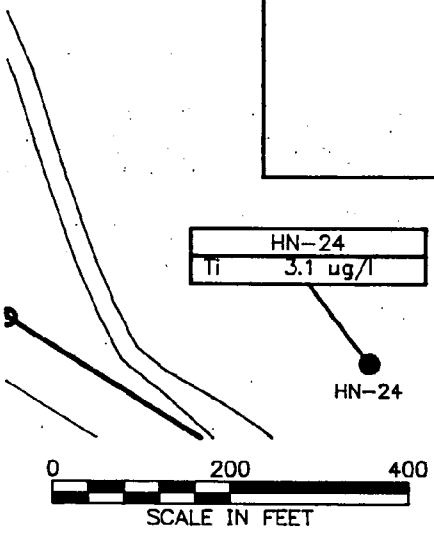
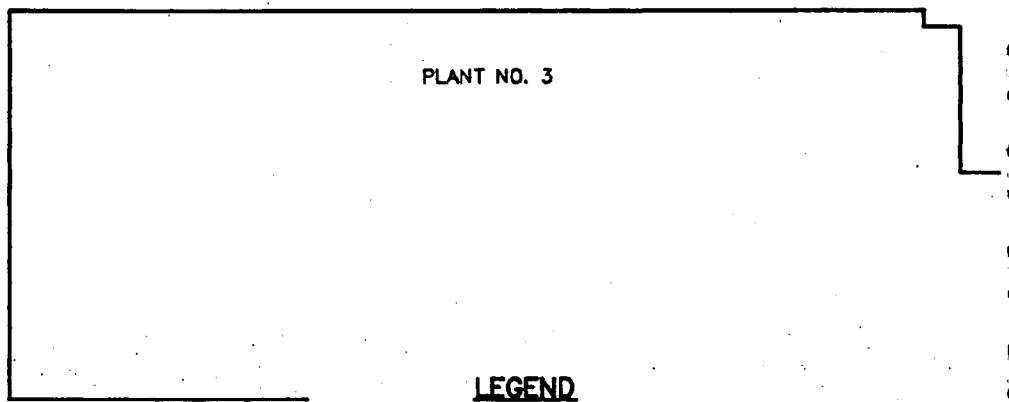
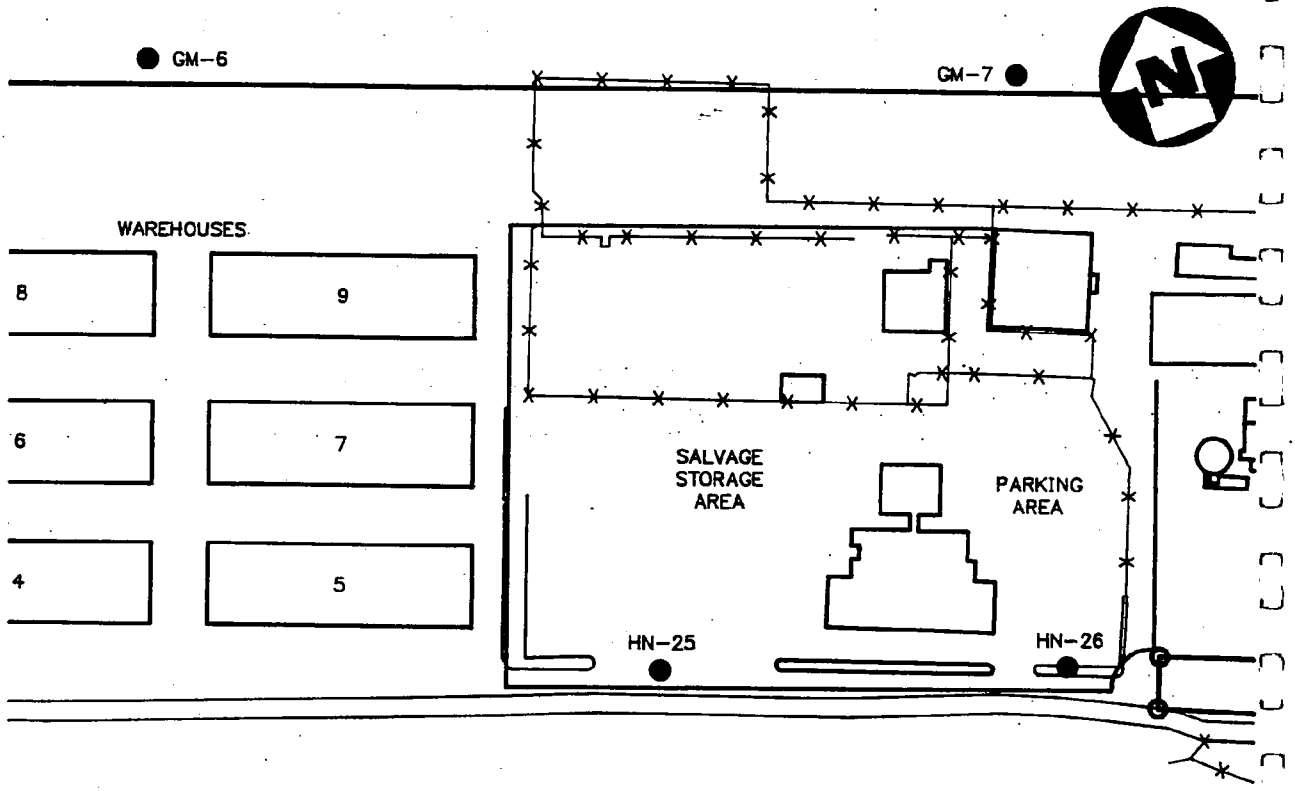

**LEGEND**

LOCATION
CONCENTRATION

- As ARSENIC
- Be BERYLLIUM
- Cd CADMIUM
- Cr CHROMIUM (TOTAL)
- Pb LEAD
- V VANADIUM
- CrVI CHROMIUM (HEXAVALENT)
- Tl THALLIUM

**GROUNDWATER INTERMEDIATE INORGANICS  
(UNFILTERED)**

**FIGURE 4-36**

**REMEDIAL INVESTIGATION  
NWIRP, BETHPAGE, NEW YORK**

4-88



**HALLIBURTON NUS**  
*Environmental Corporation*

TABLE 4-30  
 POSITIVE DETECTORS OF UNFILTERED INORGANIC GROUNDWATER CONTAMINANTS - SITE 3  
 HEMP, WESTPAC, NEW YORK  
 (ug/l)

Chemicals	CDL	IDL	GH-66 (Upper)	GH-78 (Upper)	MM-255	MM-265	MM-248	MM-241	GH-61 (Upper)	GH-71 (Upper)	MM-251 (UPP)	MM-2310 (UPP)	MM-281	MM-250	MM-2500 (UPP)	MM-13 (Upper)	MM-15 (Upper)	MM-10	MM-11
Aluminum	200	25.0	NA	NA	20200	16400	5490	1190	NA	NA	118	120	3360	437	271				
Arsenic	10	1.0	NA	NA				16.4	NA	NA						1.2			
Barium	200	8.0	NA	NA	192	131	97	30.7	NA	NA	17.9	17.4	41.1				8	10.1	11
Cadmium	5	1.0	NA	NA	1.8				NA	NA									
Calcium	5000	13.0	NA	NA	27400J	25700	10900	9640	NA	NA	4140	4080	5750		160	3450	2930	4480	4520
Chromium VI	10		NA	NA			12.6		NA	NA									
Cobalt	50	5.0	NA	NA	0.5				NA	NA									
Copper	25	2.0	NA	NA	32J	28.3J	26.8	10.8	NA	NA	5.1	2.9J	10.9			10.4	7.9J	7	26.8J
Iron	100	21.0	NA	NA	155000	25200	24900	2150	NA	NA	174	154	2890	616	420		73.4	25.8	181
Lead	3	1.0	NA	NA	32.5	29.8	8.1	11	NA	NA	1	1	3.5			4.4J		6.1J	
Magnesium	5000	45.0	NA	NA	7950	3180	2510	2320	NA	NA	1550	1320	1090			1220	956	1400	1410
Manganese	15	1.0	NA	NA	311	138	257J	93.1J	NA	NA	7.9J	7.4J	15.2J			3.4	10	1.1	6.6J
Mercury	0.2	0.2	NA	NA	0.2				NA	NA									
Nickel	40	8.0	NA	NA	10.1	19.5			NA	NA									
Potassium	5000	633	NA	NA	5560	3770	2620	35100	NA	NA	4320J	4240J	11900			643		716	698J
Sodium	5000	21.0	NA	NA	35600J	17200	12100	41700	NA	NA	16600	16400	20900	25300	24100	13800	10400	26600	26700
Thallium	10	1.0	NA	NA				3.1J	NA	NA								2600	
Vanadium	50	4.0	NA	NA	359	36.9	77.1	6.5	NA	NA			11.2						
Zinc	20	5.0	NA	NA	104J	72.8J			NA	NA	25.9	24.8	38			12.8	43.4	9.2	

NA = Not Analyzed  
 CDL = Contract Required Detection Limit  
 IDL = Instrument Detection Limit  
 J = Estimated

TABLE 4-31  
 POSITIVE DETECTIONS FILTERED INORGANIC DRINKING WATER CONTAMINANTS - SITE 3  
 WATAP, WETSPRING, NEW YORK  
 (ug/l)

Chemicals	CRDL	IDL	OP-66 (Upgrad)	OP-78 (Upgrad)	MF-245	MF-241	MF-251	MF-266	OP-61 (Upgrad)	OP-71 (Upgrad)	MF-251 (DUP. MF-251)	MF-251D (DUP. MF-251)	MF-261	MF-250	MF-280 (DUP. MF-280)	PF-13 (Upgrad)	PF-15 (Upgrad)	PF-10	PF-11
Aluminum	200	25.0	NA	NA					NA	NA			108						
Arsenic	10	1.0	NA	NA		10.4	1.0J		NA	NA	1.2								
Barium	200	8.0	NA	NA	23.9	17.4	89.14		NA	NA	17.4	16.8					8.2J	10J	10.4
Calcium	5000	13.0	NA	NA	11200	4350	31100J	13300J	NA	NA	4440J	4300J	5346J			3280J	2860J	6380	4380J
Chromium	10	8.0	NA	NA					NA	NA	32.6	32.1		137					
Copper	25	2.0	NA	NA					NA	NA	4.3	3.7J				4.64	8.9J	6.7J	24.64
Iron	100	21.0	NA	NA				25.6	NA	NA		37.8	34				51.5J	26.64	23.9
Lead	3	1.0	NA	NA		6			NA	NA						3.6J		7.8J	
Magnesium	5000	45.0	NA	NA	2380	1820	8330J	1270J	NA	NA	1610J	1570J	906J			1180J	973J	1350J	1330J
Manganese	15	1.0	NA	NA	68.5J		42.7J		NA	NA	6.1J	5.7J	1.2J			2.5J	10.2J	1.3J	5.1J
Potassium	5000	633	NA	NA	1800	3530	4410	1580	NA	NA	5300J	4960J	12000J			650	776	9938	918J
Sodium	5000	21.0	NA	NA	12100	41600	40000J	16900J	NA	NA	16800J	16100J	21200J	24000	29000	13600J	10500J	24200J	25400J
Thallium	10	1.0	NA	NA	17.1J		1.0J		NA	NA				1.0J					
Zinc	20	5.0	NA	NA	80		46.1	29.7	NA	NA	13.8	19.2	33.5	34.8	56.9	15.1J	42.8J	13.7J	

NA = NOT Analyzed  
 CRDL = Contract Required Detection Limit  
 IDL = Instrument Detection Limit  
 J = Estimated



limit of 50 ug/l and the MCLG limit of 100 ug/l. The filtered result for chromium in this well is reported to be 157 ug/l, which also exceeded the MCL and the MCLG.

Four production wells around Site 3 were sampled (see Figure 2-5). These wells, which are screened at a much greater depth than the monitoring wells, were reported to be used for industrial purposes such as cooling. The activity is reported to be supplied from public water supply wells. Therefore, these results will not be included in the quantitative risk assessment for wells screened at shallow and intermediate depths. Production well results are presented in Tables 4-29, 4-30 and 4-31. The distribution of concentrations of organics detected in production wells is shown on Figure 4-37.

Some organic compounds found in soil and in monitoring wells are also found in production wells (TCE, 1,1,1-TCA, PCE, and 1,1-DCE, as well as DEHP). Concentrations of organics in production wells are lower than those in monitoring wells, although they exceeded concentrations in the Grumman wells. Inorganics were detected at generally lower levels than those found in monitoring wells, which is not unusual when comparing constantly-pumped wells to seldom-pumped monitoring wells. There is also little difference between the filtered and unfiltered production well results.

#### 4.3.5 Surface Soils

A total of eight surface soil samples were obtained at Site 3. Sampling locations were based on historical information regarding site chemical handling and disposal activities. Surface soil samples were collected at points on a relatively uniform, 300-foot by 300-foot grid and at field-determined, opportune locations. Sample locations are displayed on Figure 2-4. The analytical results for the surface soil samples are summarized in Tables 4-32 and 4-33 inorganic contaminants. In general, trace to low levels of VOCs were detected in surface soil samples.

Low to moderate concentrations of phthalate esters (under 3,500 ug/g) and polynuclear aromatic hydrocarbons (PAHs) (under 20,000 ug/kg) were also detected throughout the site; no well-defined pattern of contamination by PAHs and phthalate is evident.

Polychlorinated biphenyls (PCBs), such as Aroclor 1248 and Aroclor 1254, were identified in surface soil. PCBs were detected in the northern and western portions of Site 3. Concentrations of PCBs ranged up to 830 ug/kg. PCBs were tentatively identified in one sample.

PCBs as TICs are used mainly on confirmatory basis. TICs are not appropriate for quantitative risk assessment because their identities and quantities are uncertain. Those PCBs that were confidently identified are addressed quantitatively in Section 6.0.

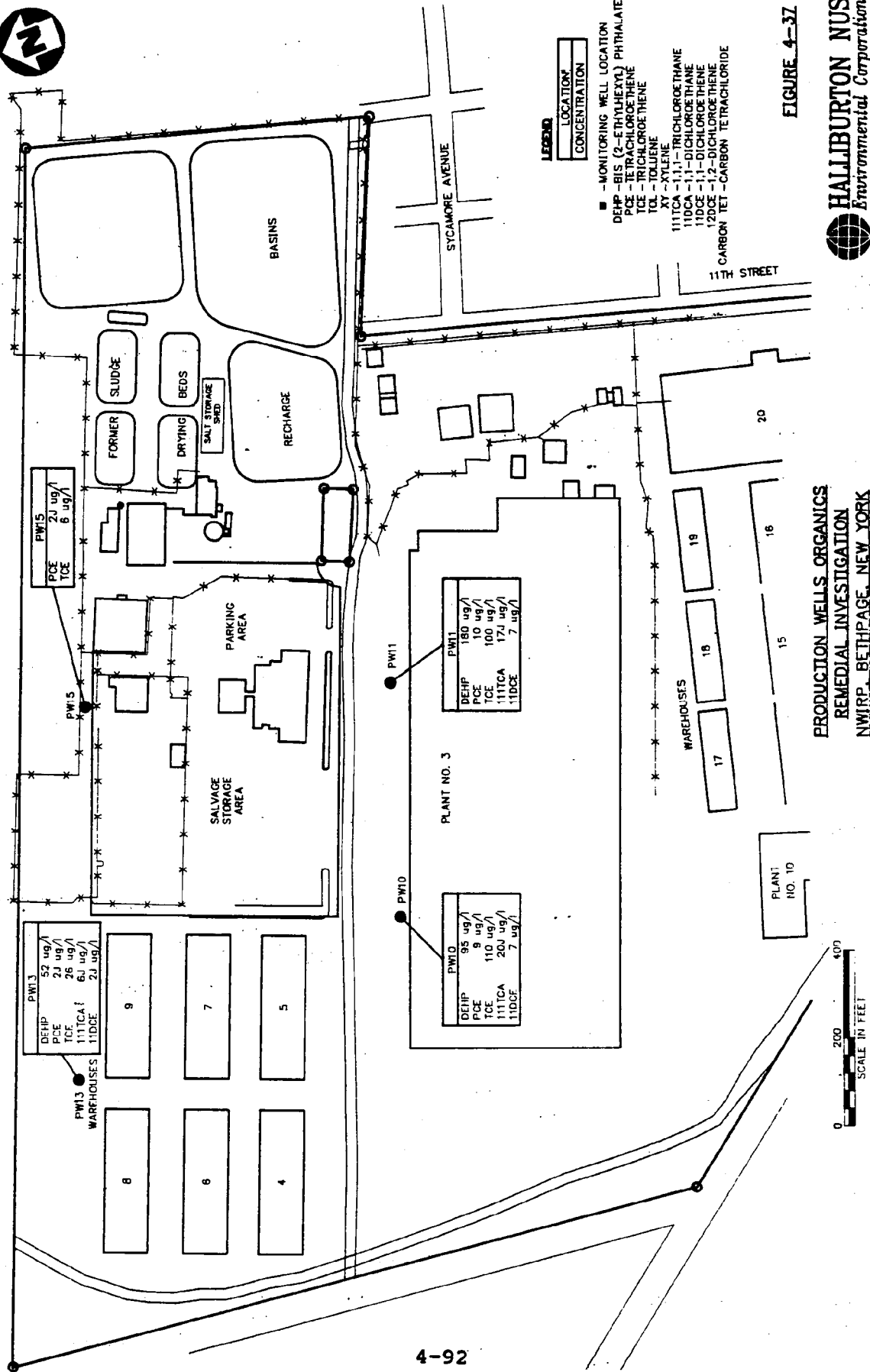

FIGURE 4-37



PRODUCTION WELLS ORGANICS  
REMEDIAL INVESTIGATION  
NWIRP, BETHPAGE, NEW YORK

TABLE 4-32

**OCCURRENCE AND DISTRIBUTION OF SURFACE SOIL CONTAMINANTS  
SITE 3 - ORGANIC (ug/kg)  
NWIRP, BETHPAGE, NY**

Compound	CRQL	Number Positive Detections/ Samples Analyzed	Location of Maximum Concentration	Maximum Positive Detection	Representative Concentration*
Chloroform	5	1/9	-	1	1.0
Toluene	5	5/9	SS327	8.5	4.8
Trichloroethene	5	1/9	SS323	3J	-
bis(2-Chloroethyl)ether	350	1/9	SS329	360J	360
Aroclor 1248	80	3/3	SS327	830J	830
Aroclor 1254	170	1/3	SS328	530J	530
bis(2-Ethylhexyl)phthalate	350	6/9	SS322	2400	1298
Butyl benzyl phthalate	330	4/9	SS328	660	508
Di-n-butyl phthalate	350	2/9	SS322	340J	340
Dimethyl phthalate	330	1/9	SS328	190J	190
2-Methylnaphthalene	350	1/9	SS322	54J	54
Acenaphthylene	350	1/9	SS321	150J	150
Acenaphthene	350	2/9	SS321	160J	160
Phenanthrene	340	7/9	SS320	1090J	697
Anthracene	350	4/9	SS320	610J	446
Fluoranthene	1800	9/9	SS321	1800	1052
Pyrene	1100	8/9	SS321	2500	1462
Benzo[a]anthracene	340	4/9	SS321	880J	637
Chrysene	340	5/9	SS320	1060J	739
Benzo[b]fluoranthene	340	5/9	SS321	1200	716
Benzo[k]fluoranthene	220	7/9	SS321	1400	857
Benzo[a]pyrene	340	5/9	SS321	1300	784
Indeno[1,2,3-c,d]pyrene	340	5/9	SS321	920J	580
Benzo[g,h,i]perylene	350	6/9	SS321	980J	636
Fluorene	350	2/9	SS320	180J	180
PCBs (TICs)	-	1/9	SS322	P	-

\* Upper 95% confidence limit (UCL) on arithmetic average, or maximum if UCL exceeds maximum detected.

ND = Not Detected

TIC = Tentatively Identified Compound

PCB = Polychlorinated Biphenyl

CRQL = Contract Required Quantitation Limit

J = Estimated

P = Present

Background soil concentrations are presented in Table 4-4.

TABLE 4-33

OCCURRENCE AND DISTRIBUTION OF SURFACE SOIL CONTAMINANTS  
 SITE 3 - INORGANIC (mg/kg)  
 MWIRP, BETHPAGE, NY

Element	CRDL	IDL	Number Positive Detections/ Samples Analyzed	Location of Maximum Concentration	Concentration Range	Representative Concentration*
Aluminum	40	17.5/36.2	9/9	SS322	8260-28000	19640
Antimony	12	2.2	3/9	SS327	ND-6.05	3.4
Arsenic	2	0.72/0.78	8/8	SS322	1.1-56.8	26.1
Barium	40	2.6	9/9	SS328	23.4-107J	76.2
Beryllium	1	0.2	8/9	SS322	ND-1.5	1.1
Chromium	2	1.9/2.1	8/9	SS328	ND-637J	258
Cobalt	10	2.0	9/9	SS328	3.6-19.2	16.1
Copper	5	1.7	2/2	SS328	279-400	400
Iron	20	7.0/7.4	9/9	SS328	11000-135000J	66563
Mercury	0.10	0.10	7/9	SS328	ND-0.5	0.21
Selenium	1	0.80	1/9	SS322	ND-1	1.0
Vanadium	10	2.9	9/9	SS328	20.5-1.9J	89.9
Cyanide	2	2.0	1/9	SS323	ND-4.2	2.3

Background soil concentrations are presented in Table 4-5.

\* Upper 95% confidence limit (UCL) on arithmetic average, or maximum if UCL exceeds maximum detected.

ND = Not Detected

CRDL = Contract Required Detection Limit

IDL = Instrument Detection Limit

J = Estimated

The TOX profiles in Appendix I contain qualitative information about the toxicity of PCBs.

The herbicide prometon was identified as a TIC (tentatively identified compound) in one sample at Site 3. Prometon was not used in the qualitative risk assessment since its identity and quantitation were uncertain. The TOX profile presented in Appendix I contains quantitative toxicological information about prometon.

For comparative purposes, concentrations of organic compounds in background (subsurface) soil samples are shown in Table 4-4. It can be seen that PAHs, which are common environmental contaminants, were detected up to approximately 7,000 ug/kg in background soil.

Inorganic elements detected at the activity are displayed in Table 4-33. Almost all metals were detected above levels observed in background (subsurface) soil. The highest concentrations of metals at the NWIRP were generally detected in Site 3. Especially notable were chromium and arsenic concentrations (up to 637 mg/kg and 56.8 mg/kg, respectively). Mercury is an example of a metal with scattered, inconsistent, positive detections. Cyanide was detected at low levels. Substances associated particularly with plating detected at the sites are cyanide, copper, and chromium (Sittig, 1985). The significance of elements with inconsistent and low-frequency detections, such as antimony and selenium, is questionable.

At Site 3, the highest-concentration samples were SS-28 and SS-22, which were located near Plant No. 3 and warehouses in the northwestern part of Site 3.

#### 4.3.6 Summary

The soil-gas results indicated a potential volatile organic source area near the south west and north east portion of Site 2. Subsequent soil sampling in this area found slightly elevated concentrations of volatile organics at these locations. However, when compared with Site 1, the concentrations detected were relatively minor. Elevated concentrations of PCBs (830 ug/kg), PAHs, and inorganics were found in the soils at Site 3. There is no apparent distinct pattern associated with the nonvolatile organic contamination. Of the three sites, Site 3 was found to have the highest inorganic contamination of the soils.

The temporary monitoring well program and monitoring well program indicates that Site 3 may be a unique source area of groundwater contamination. However, currently the source area plume is not nearly as distinct or significant as at Site 1. TCE was detected at maximum concentrations of 58,000 ug/l in the intermediate monitoring well south west of Plant 3. This contamination may or may not be associated with Site 3. Downgradient monitoring wells closer to Site 3 found TCE, PCE, and 1,1,1-TCA at maximum

concentrations of 120 ug/l, 75 ug/l, and 9 ug/l, respectively. As a result, the contamination found at monitoring well HN-24I may result from historic contamination in the area or an unknown source area near Plant 3 or Site 1. Inorganic contamination was also found. However, when the inorganic contamination is compared to the organic contamination at this site, it is relatively minor.

#### **4.4 Overall Groundwater Considerations**

The site-specific evaluations of groundwater contamination at NWIRP, Bethpage, were presented in Sections 4.1 through 4.3. Since the contaminated, on-site groundwater is not consumed and the contaminant plumes appear to merge prior to leaving the site, it is more appropriate to calculate the risks associated with the groundwater for the entire NWIRP rather than for the individual sites. No single well in the shallow or intermediate zone has been identified as a point of exposure; therefore, individual well concentrations will not be used for quantitative risk assessment. Concentrations in individual wells are compared to drinking water criteria in Section 6.0. Therefore, this section is provided to determine representative concentrations of contaminants to be used for the groundwater data evaluation in Section 6.0. Tables 4-34, 4-35, 4-36, and 4-37 provide the occurrence and distribution of groundwater contaminants for the organics, unfiltered inorganics, and filtered organic results, and production well results (not used for quantitative risk assessment), respectively.

#### **4.5 QA/QC Summary**

##### **4.5.1 Field QA/QC Samples**

Field quality assurance/quality control samples consist of field duplicates, rinsate blanks, field blanks, trip blanks, and matrix spikes/matrix spike duplicates. NEESA Level D QA/QC criteria were specified.

TABLE 4-34

OCCURRENCE AND DISTRIBUTION  
OF GROUNDWATER CONTAMINATION - ORGANIC (ug/l)  
MWIRP, BETHPAGE, NY

Compound	CRQL	Number Positive Detections/ Samples Analyzed	Location of Maximum Concentration	Maximum Positive Concentration	Representative Concentration
Trichloroethene	5	14/15	HN24I	58000	12285
Toluene	5	6/15	HN29S	39	11.5
1,1-Dichloroethane	5	3/15	HN29S	880	188
1,2-Dichloroethene	5	3/15	HN29S	3600	772
1,1,1-Trichloroethane	5	12/15	HN29S	10000	2113
Tetrachloroethene	5	12/15	HN28S	360	788
1,1-Dichloroethene	5	4/15	HN29S	250	54.7
Carbon Tetrachloride	5	1/15	HN24I	8	3.7
Ethylbenzene	5	1/15	HN29S	3J	2.6
Xylenes	5	1/15	HN29S	19	6.0
TICs		14/15	-	-	-
bis(2-ethylhexyl)phthalate	10	2/15	HN26I	73	21.5
Di-n-octyl phthalate	10	2/15	HN28I	17	7.7
2-Methylphenol	10	1/15	HN29S	2J	2
4-Methylphenol	10	1/15	HN29S	2J	2
2,4-Dimethylphenol	10	1/15	HN29S	7J	5.7
Naphthalene	10	1/15	HN29S	3J	3
Acenaphthylene	10	1/15	HN29S	1J	1
Fluoranthene	10	1/15	USGS	2J	2
Pyrene	10	1/15	USGS	2J	2
Benzo[b]fluoranthene	10	1/15	USGS	2J	2

TICs = Tentatively Identified Compounds

\* Upper 95% confidence limit on arithmetic average, or maximum if UCL exceeds maximum positive detection.

- Not detected

CRQL = Contract Required Quantitation Limit

(1) Excludes pumping wells PW10, PW11, PW13, and PW15.

TABLE 4-35

**OCCURRENCE AND DISTRIBUTION  
OF GROUNDWATER INORGANICS - UNFILTERED (ug/L)  
HWIRP, BETHPAGE, NY**

Element	CRDL	Number Positive Detections/ Samples Analyzed	Location of Maximum Concentration (1)	Concentration Range	Representative Concentration*
Aluminum	200	14/15	HN27S	ND-33800	13274
Arsenic	10	7/15	HN24I, HN28S	ND-16.4	11.7
Barium	200	15/15	HN27S	9.7-211	106.8
Beryllium	5	2/15	HN27S	ND-2.9	1.3
Cadmium	5	3/13	HN27S	ND-392	82.9
Calcium	5000	15/15	-	38602-27400	10597
Chromium	10	7/11	HN27S	ND-169	71.3
Hexavalent chromium	10	3/15	HN25	ND-174J	21.1
Cobalt	25	5/15	HN29S	ND-12.8	7.4
Copper	100	13/15	HN27S	ND-823J	194
Iron	3	15/15	HN25S	114-155000	67314
Lead	5000	12/15	USGS	ND-124	36.9
Magnesium	15	15/15	HN256	277-7950	2552
Manganese	0.2	15/15	USGS	7.65-1440J	402
Mercury	40	2/15	HN27S	ND-0.2	0.13
Nickel	5000	6/15	USGS	ND-62.9	20.2
Potassium	5	15/15	HN24I	1395-35100	12001
Selenium	5000	1/15	HN29S	ND-2.3	0.88
Sodium	10	15/15	HN29S	12100-222000	75164
Thallium	50	1/15	HN24I	ND-3.1J	1.0
Vanadium	20	11/15	HN29S	ND-419	159
Zinc	10	8/14	USGS	ND-217	89.1
Cyanide		4/15	HN27S	ND-2690	578

\* Upper 95% confidence limit on arithmetic average, or maximum positive concentration if UCL exceeds maximum.

ND = Not detected

CRDL = Contract Required Detection Limit

(1) Excludes pumping wells PW10, PW11, PW13, and PW15.



TABLE 4-36

OCCURRENCE AND DISTRIBUTION  
OF GROUNDWATER INORGANICS - FILTERED (ug/l)  
MWIRP, BETHPAGE, NY

Element	CRDL	Number Positive Detections/ Samples Analyzed	Location of Maximum Concentration (1)	Concentration Range	Representative Concentration*
Aluminum	200	4/15	HN29S	ND-293	111.4
Arsenic	10	7/15	HN29S	ND-43.2	12.0
Barium	200	9/15	HN25S	ND-89.1J	27.6
Cadmium	5	3/15	HN27S	ND-91J	19.7
Calcium	5000	15/15	HN25S	2730-31100J	11988
Chromium	10	3/15	HN281	ND-56.7	18.2
Copper	25	7/15	HN25I	ND-4.3	3.6
Iron	100	10/15	USGS	ND-568	163.4
Lead	3	1/15	HN24I	ND-6	1.65
Magnesium	5000	14/15	HN25S	ND-8330	2919
Manganese	15	13/15	USGS	ND-572J	133.9
Potassium	5000	15/15	HN24I	1100-35300	11775
Selenium	5	1/15	HN29S	ND-3.1	1.0
Sodium	5000	15/15	HN29S	12100-230000	75927
Thallium	10	4/15	HN24S	ND-17.1J	4.1
Vanadium	50	3/15	HN29S	ND-34.3	9.8
Zinc	20	10/14	USGS	ND-178	85.9

\* Upper 95% confidence limit on arithmetic average, or maximum positive detection if UCL exceeds maximum.

ND = Not detected

CRDL = Contract Required Detection Limit

(1) Excludes pumping wells PW10, PW11, PW13, and PW15.

**TABLE 4-37**  
**OCCURRENCE AND DISTRIBUTION**  
**OF PRODUCTION WELL RESULTS (ug/l)**  
**NWIRP, BETHPAGE, NY**

Chemical	CRQL	IDL	Number Positive Detections/ Samples Analyzed	Location of Maximum Concentration	Concentration Range*
<b>ORGANICS</b>					
Trichloroethene	5	-	4/4	PW10	6-110
1,1,1-Trichloroethane	5	-	3/4	PW10	ND-20J
Tetrachloroethene	5	-	4/4	PW11	2J-10
1,1-Dichloroethene	5	-	3/4	PW10,PW11	ND-7
bis(2-Ethylhexyl)phthalate	10	-	3/4	PW11	ND-180
TICs	5	-	3/4		-
<b>INORGANICS - UNFILTERED</b>					
Arsenic	10	1.0	1/3	PW13	ND-1J
Barium	200	8.0	3/4	PW11	ND-11
Calcium	5000	13.0	4/4	PW11	2930-4520
Copper	25	2.0	4/4	PW11	7-26.8J
Iron	100	21.0	3/4	PW11	ND-181
Lead	3	1.0	2/4	PW11	ND-6.1J
Magnesium	5000	45.0	4/4	PW11	986-1410
Manganese	15	1.0	4/4	PW15	1.1-10
Potassium	5000	633	3/4	PW10	ND-716
Sodium	5000	21.0	4/4	PW11	10400-26700
Zinc	20	5.0	3/3	PW15	9.2-43.4
<b>INORGANICS - FILTERED</b>					
Barium	200	8.0	3/4	PW11	ND-10.4
Calcium	5000	13.0	4/4	PW10	2860J-4380
Copper	25	2.0	4/4	PW11	4.6J-24.6J
Iron	100	21.0	3/4	PW15	ND-51.5J
Lead	3	1.0	2/4	PW10	ND-7.8J
Magnesium	5000	45.0	4/4	PW11	975J-1350J
Manganese	15	1.0	4/4	PW15	1.3J-10.2J
Potassium	5000	633	4/4	PW10	650-993B
Sodium	5000	21.0	4/4	PW10	10500J-26200J
Zinc	20	5.0	3/3	PW15	13.7J-42.8J

TIC = Tentatively identified compound

ND = Not detected

\* In a sample population of this size, the representative concentration equals the maximum positive concentration.

CRQL = Contract Required Quantitation Limit

IDL = Instrument Detection Limit

J = Estimated

NEESA requirements for Level D QA/QC samples are as follows.

QA/QC TYPE	NEESA REQUIREMENT
Field Duplicate	One duplicate in 10 samples per sample matrix.
Rinsate Blank	One sample of the final rinse during decontamination of sampling equipment per day. Initially, samples from every other day are analyzed. If analytes pertinent to the project are found in the rinsate, the remaining samples are analyzed.
Field Blank	One sample of each source water used for decontamination of sampling equipment for each sampling event.
Trip Blank	One sample of analyte-free water per day, for each shipment of samples for volatile organic analysis.
Matrix Spike/ Matrix Spike Duplicate (MS/MSD)	One sample in 20 samples per sample matrix.

The chemicals detected in field, rinsate, and trip blanks are presented in Tables 4-38, 4-39, and 4-40. The organic chemicals detected are common laboratory and field contaminants. The inorganics detected are commonly found in the water used.

#### 4.5.2 Analytical Methods

Three different laboratories were used to analyze the samples collected at NWIRP Bethpage. General Physics analyzed all the soil samples and some of the sediment samples for VOAs, SemiVOAs, inorganics, and/or PCBs/pesticides. Ortek analyzed all the groundwater samples, surface water samples, and the balance of the sediment samples for the same parameters. HALLIBURTON NUS Environmental Laboratories analyzed select soil and groundwater samples for engineering-type parameters. The analytical methods used are presented in Table 4-41.

**TABLE 4-38**

**TRIP BLANK CONTAMINATION (ug/l)  
SUMMARY  
SITE INVESTIGATION  
NWIRP CALVERTON, NEW YORK**

<b>PARAMETER</b>	<b>CONCENTRATION (ug/l)</b>
<b>Methylene chloride</b>	<b>ND to 5J</b>
<b>Acetone</b>	<b>ND to 25</b>

**ND** None detected.  
**J** Estimated.

TABLE 4-39

RINSATE CONTAMINATION (ug/l)  
 SUMMARY  
 SITE INVESTIGATION  
 NWIRP CALVERTON, NEW YORK

PARAMETER	MAXIMUM CONCENTRATION
Acetone	2J
Methylene Chloride	1J
Benzoic Acid	14J
Phenol	9J
2-Methyl-2-pentanone	7J
Di-n-butyl phthalate	6J
Anthracene	4J
Calcium	321
Copper	12.5
Chromium	10.2
Cobalt	25.5
Iron	115
Lead	182
Magnesium	58.1
Manganese	1.4J
Potassium	1,310
Sodium	1,127
Silver	11.2
Zinc	35.2

J Estimated.

TABLE 4-40

FIELD BLANK CONTAMINATION (ug/l)  
SUMMARY  
SITE INVESTIGATION  
NWIRP CALVERTON, NEW YORK

PARAMETER	MAXIMUM CONCENTRATION
Acetone	41
Di-n-butylphthalate	7J
Anthracene	7J
Aluminum	28.5
Calcium	507
Copper	12.2
Iron	45.0
Potassium	1150
Sodium	518
Zinc	5.9

J Estimated.

**TABLE 4-41****ANALYTICAL METHODS (ug/l)  
SUMMARY  
SITE INVESTIGATION  
NWIRP CALVERTON, NEW YORK**

<b>Parameter</b>	<b>Method</b>
VOAs	1/87 CLP SOW
SemiVOAs	1/87 CLP SOW
PCB/Pesticides	1/87 and 2/88 CLP SOW
Inorganics	7/88 CLP SOW
Hexavalent Chromium	EPA 218.4
pH	SW846-9045
TOC	MSA 29.3.5.2
Bulk Density	MS CH.13
Grain Size	ASTM-D22-63
Hardness	EPA 130.2
Alkalinity	EPA 310.1
Total dissolved solids	EPA 160.1
Total suspended solids	EPA 160.2
Biological oxygen demand	EPA 405.1
Chemical oxygen demand	EPA 410.2
Total organic carbon	EPA 415.1

#### 4.5.3 Laboratory QA/QC

Method or laboratory blanks found methylene chloride at up to 6 ug/l, bis(2-ethylhexyl) phthalate at up to 180 ug/l, di-n-octyl phthalate at up to 11 ug/l, 2-hexanone at up to 6 ug/l, acetone at up to 2 ug/kg, bromoform at up to 1 ug/l, 4-methyl 2-pentanone at up to 6 ug/l, 2-hexanone at up to 9 ug/l, chloroform at up to 2 ug/kg and toluene at up to 2 ug/kg. Low concentration of several metals were also detected in blank samples; however, based on the concentration detected, this did not affect the data.

Sample holding times were missed on several samples. The quality of the data is not believed to be significantly affected.

#### 4.5.4 Data Validation

The results of data validation have been transmitted to the Navy under separate cover. The following provides a discussion of the data validation process.

The data validation process serves three basic functions:

- An independent quality assurance check of the veracity of laboratory results.
- A means of evaluating laboratory performance and determining the impact of non-compliances to the data.
- Through the use of data qualifiers, it lends interpretive guidance as to the proper usage and limitations of the data.

The data validation process is a systematic review and evaluation of the data conducted according to the applicable relevant quality control criteria, such as:

- the USEPA National Functional Guidelines for Evaluating Laboratory Analyses,
- method-specific quality control criteria,
- Navy-specified technical guidelines,
- HALLIBURTON NUS data validation formats and S.O.P.s.

Organic data are evaluated based on:

- data completeness
- holding times
- GC/MS tuning and mass calibration (when applicable)
- initial and continuing calibrations
- laboratory blank analyses
- field blank analyses (when applicable)
- internal standards performance
- surrogate spike recoveries
- matrix spike/matrix spike duplicate results
- field duplicate precision (when applicable)



- compound detection limits
- compound identification
- compound quantitation
- Tentatively Identified Compound (TIC) evaluation (when applicable)

Inorganic data are evaluated based on:

- data completeness
- holding times
- initial calibration
- continuing calibration verification
- CRDL standard analyses
- laboratory blank analyses
- field blank analyses (when applicable)
- matrix spike results
- laboratory control sample results
- laboratory duplicate analyses
- field duplicate precision (when applicable)
- ICP interference check sample results
- ICP serial dilution analyses
- furnace atomic absorption results
- analyte detection limits
- analyte quantitation

In addition to the organic and inorganic data validation mentioned above, data from miscellaneous organic and inorganic analyses such as Total Petroleum Hydrocarbons (TPH), Biological Oxygen Demand (BOD), Chemical Oxygen Demand (COD), Total Organic Carbon (TOC), and others; alkalinity, acidity and other wet chemistry procedures, and data from geophysical parameters (e.g. grain size, bulk density, atterberg limits, etc.) are also validated. Data of this type are evaluated using an abbreviated version of the quality parameters lists given above.

Data validation memoranda (i.e. reports) are generated from the results and conclusions drawn from the validation process described above. These reports are submitted to the appropriate Project Manager. The specific format of the data validation report varies with the applicable protocol, but all data validation memoranda address the following:

- Explanation of the findings of the data evaluation process, giving interpretations of actions taken on the data and limits of data usability.
- Presentation of the qualified analytical results.
- A validation worksheet and/or support documentation section depicting the problem areas and non-compliances addressed in the data validation memoranda, and supporting the validation actions taken.

The formal data validation process and the subsequent memoranda and supporting documentation generated thereby, is essential for the following reasons:

- To ensure the accuracy and integrity of the analytical data.
- To ensure the defensibility of the data.
- To provide a secure platform from which remediation and risk assessment issues can be addressed.

1  
2  
3  
4  
5  
6  
7  
8  
9  
10  
11  
12  
13  
14  
15  
16  
17  
18  
19  
20

## **5.0 CONTAMINANT FATE AND TRANSPORT**

Various aspects of contaminant fate and transport at the NWIRP, Bethpage, are discussed in this section. Potential contaminant migration routes are identified and discussed in Section 5.1. Section 5.2 presents a brief discussion of contaminant persistence. Various chemical and physical properties affecting contaminant migration are discussed in Section 5.3.

### **5.1 Potential Migration Routes**

In general, numerous potential migration routes exist in areas contaminated with hazardous materials. Such migration routes include, but are not limited to, atmospheric migration via particulate or volatile/semivolatile/PCB emissions, overland migration of dissolved or adsorbed contaminants, lateral migration of gases through the subsurface, surface water transport, and migration via groundwater transport.

As a result of the nature of contamination at the Bethpage activity and various site-specific conditions, the following migration routes are considered significant: migration of volatile organic compounds (VOCs) through subsurface soil, fugitive dust emissions, and groundwater transport. The major portion of inorganic contamination is contained in the surface soil; the major portion of organic contamination is contained in the subsurface soil and groundwater, as discussed in Section 4.0 (Nature and Extent of Contamination).

Substantial evidence indicates that groundwater transport of dissolved organic species is a significant contaminant migration route. Substantial groundwater contamination has been detected in samples from monitoring wells at the activity. Contamination by the same chemicals was also reported in subsurface soil. Figures 4-6 through 4-11 show isoconcentration contours for three major VOC activity contaminants, using monitoring well data. As discussed in Section 4.0, VOC contamination generally increases from north to south across the Bethpage activity. Section 3.0 discusses geology and hydrogeology, including gradients and direction of groundwater flow.

### **5.2 Contaminant Persistence**

Several transformation processes are believed to affect the persistence of organic chemicals in the environment. The primary processes affecting contaminant fate in the environment include microbial, photolytic, and chemical degradation.

In general, photolytic degradation is not considered to be a relevant degradation mechanism for either chlorinated aliphatic compounds such as 1,1,1-TCA, TCE, or PCE, or for monocyclic aromatic compounds, such as toluene (USEPA, December 1982).

Furthermore, even if such compounds were subject to photolytic degradation, they must be present in media exposed to sunlight for such degradation to occur (such as surface water or surface soil). Since the VOCs occur, to a greater extent, in groundwater and subsoil, photolytic degradation is not expected. For PCBs, photolysis can occur, especially in the more highly chlorinated compounds, although the process is reported to be slow. Photolysis is considered to be insignificant for phthalates and of unknown significance for PAHs (USEPA, 1979).

Generally, organic molecules are subject to several chemical reactions under environmental conditions. Such reaction mechanisms include acid/base reactions, addition, elimination, and hydrolysis. However, chlorinated alkanes and alkenes and monocyclic aromatics are not particularly amenable to the majority of these degradation mechanisms. As can be seen in Table 5-1, hydrolysis is considered to be negligible for PAHs, halogenated hydrocarbon pesticides and PCBs. Alkyl halides and the phthalates can be more susceptible (USEPA, 1979; USEPA, Dec. 1982).

Hydrolysis reactions can occur under acidic, basic, or neutral conditions. Because the groundwater pH is variable (reported pH values range from 5 to 10), acidic, basic, or neutral hydrolysis could occur under the appropriate conditions.

Another possible type of degradation is the dechlorination of PCE and TCE to 1,2-DCE, 1,1-DCE, and ultimately vinyl chloride (Cline and Viste, 1984), (see Figure 5-1). A similar type of reaction has been reported for 1,1,1-TCA in degradation to 1,2-DCA, 1,1-DCA, and chloroethane. At Bethpage, only the higher chlorinated compounds were reported in soil. However, in groundwater, 1,1-DCE, 1,1-DCA, 1,2-DCE were detected, although vinyl chloride was not detected during this sampling round.

Bacterial degradation is a potential environmental fate mechanism. The compounds for which biodegradation is potentially considerable are toluene, 4-methylphenol, and to some extent, naphthalene and phthalates (USEPA, Dec. 1982; Verschueren, 1983). It should be noted that for cyanide, environmental fate is mainly controlled by biodegradation, (volatilization is a primary pathway for hydrogen cyanide.) Cyanides usually are not observed as widespread, high-level contaminants in the environment, since they are metabolized so readily. The frequency of cyanide detections at the Bethpage activity was relatively low, especially in soil, as can be seen in Section 4.0. Some metalocyanide complexes may be more persistent in the environment (USEPA, 1979).

This degradation is primarily biological and anaerobic conditions are typically required for these reactions to occur. The aerobic/anaerobic conditions in the groundwater at the NWIRP are unknown.

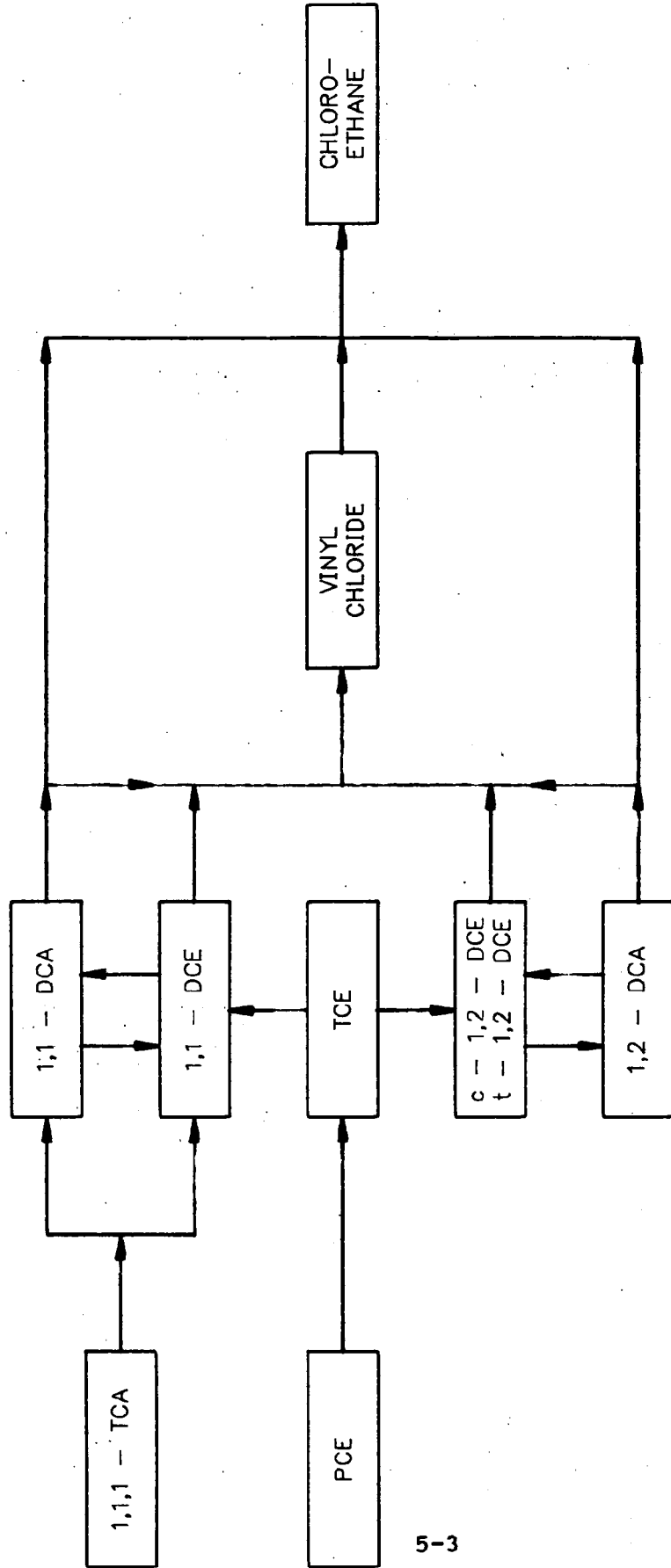

FIGURE 5-1

TRANSFORMATION PATHWAYS FOR VARIOUS  
CHLORINATED VOLATILE HYDROCARBONS IN SOIL SYSTEMS  
REMEDIAL INVESTIGATION  
NWIRP, BETHPAGE, NY



TABLE 5-1  
 HYDROLYSIS RATE CONSTANTS FOR ORGANIC CHEMICALS<sup>(1)</sup>  
 NMIRP, BETHPAGE, NY

Chemical	K <sub>acid</sub> (M <sup>-1</sup> hr <sup>-1</sup> )	K <sub>base</sub> (M <sup>-1</sup> hr <sup>-1</sup> )	K <sub>neutral</sub> (1 hr <sup>-1</sup> )	Reference Temperature (C)
Trichloroethene	0	0	0	-
Tetrachloroethene	0	0	0	-
Chloroform <sup>(2)</sup>	-	6.7 X 10 <sup>-6</sup>	1.56 X 10 <sup>-8</sup>	95/90
Toluene	0	0	0	-
4-Methylphenol	-	-	-	-
bis(2-Chloroethyl)ether	-	-	4 X 10 <sup>-6</sup>	25
DDT	0	36	6.8 X 10 <sup>-6</sup>	27
Chlordane	0	0	0	-
Aroclor 1248	0	0	0	-
Aroclor 1254	0	0	0	-
bis(2-Ethylhexyl)phthalate	4 X 10 <sup>-5</sup>	0.4	0	30
Butyl benzyl phthalate	7.92 X 10 <sup>-3</sup>	79.2	0	30
Di-n-butyl phthalate	7.92 X 10 <sup>-3</sup>	79.2	0	30
Dimethylphthalate	0.025	248	0	30
Naphthalene	0	0	0	-
Acenaphthene	0	0	0	-
Anthracene	0	0	0	-
Fluoranthene	0	0	0	-
Pyrene	0	0	0	-
Benz[a]anthracene	0	0	0	-
Chrysene	0	0	0	-
Benzo[b]fluoranthene	0	0	0	-
Benzo[k]fluoranthene	0	0	0	-
Benzo[a]pyrene	0	0	0	-
Indeno[1,2,3,-c,d]pyrene	0	0	0	-
Dibenz[a,h]anthracene	0	0	0	-
Benzo[g,h,i]perylene	0	0	0	-
Fluorene	0	0	0	-
trans-1,2-dichloroethene	0	0	0	-
1,1,1-Trichloroethane	0		1.7X10 <sup>-4</sup>	25

TABLE 5-1  
 HYDROLYSIS RATE CONSTANTS FOR ORGANIC CHEMICALS<sup>(1)</sup>  
 PAGE TWO

Chemical	$K_{acid}$ ( $M^{-1} hr^{-1}$ )	$K_{base}$ ( $M^{-1} hr^{-1}$ )	$K_{neutral}$ ( $hr^{-1}$ )	Reference Temperature (C)
1,1-Dichloroethane	0	-	$1.15 \times 10^{-7}$	25
1,1-Dichloroethene	0	0	0	-
Ethylbenzene	0	0	0	-
Xylenes	NR	NR	NR	-
Di-n-octyl phthalate	$7.92 \times 10^{-3}$	79.2	0	30
2-Methylphenol	NR	NR	NR	-
4-Methylphenol	NR	NR	NR	-
2,4-Dimethylphenol	0	0	0	-

NR = Not reported; chemicals of this type are generally resistant to hydrolysis.

(1) USEPA, December 1982.

(2) Lyman et al, 1990.



### 5.3 Contaminant Migration

This section provides a qualitative discussion of potential migration of the contaminants found at the Bethpage activity. The physical and chemical properties of the chemicals found at the activity, where available, are presented in Tables 5-2 and 5-3. These parameters may be used to assess the behavior of a chemical in the environment.

Empirically determined literature values of water solubility, octanol/water partition coefficient, organic carbon partition coefficient, vapor pressure, Henry's law constant, bioconcentration factor, and specific gravity are presented for organic chemicals, as available. Many of these parameters are not applicable to inorganic chemicals. For inorganics, specific gravity and bioconcentration factors have been presented, along with qualitative descriptions of important environmental fate properties. Calculated values, which were obtained using approximation methods, are presented when literature values are unavailable. A discussion of the environmental significance of each of these parameters follows.

The rate at which a chemical is leached from a waste deposit by infiltrating precipitation is proportional to its water solubility. More soluble chemicals are expected to enter water much more readily and rapidly than less soluble chemicals. The water solubilities presented in Table 5-3 indicate that the volatile organic chemicals are several orders of magnitude more water-soluble than semivolatile compounds (including phthalates and PAHs), pesticides, or PCBs. This conclusion is reinforced by the fact that VOCs were discovered, for the most part, more frequently and at greater concentrations in subsurface soil and groundwater than in surface soil. (Volatilization of VOCs from surface soil also is an important factor in the observed distribution of these chemicals.) The opposite is true for the metals, which are not noted for great solubility: higher concentrations were discovered in surface soil, for the most part.

Although phthalates, PAHs, and PCBs were detected in onsite soil samples, such compounds have not been detected, to a great extent in groundwater. When detected, they are observed in monitoring wells, where they may be part of the sediment in the sample instead of the aqueous fraction. This is a manifestation of their limited water solubility and tendency to adsorb onto soil/sediment particles.

The octanol/water partition coefficient ( $K_{ow}$ ) is a measure of the equilibrium partitioning of a chemical between octanol and water. The  $K_{ow}$  is also used to estimate bioconcentration factors in

TABLE 5-2  
 MOBILITY PARAMETERS AND PROPERTIES FOR INORGANIC CHEMICALS  
 MWIRP, BETHPAGE, NY

CHEMICAL	MOL. WT. (g)	SP. GRAV. (1) (at 20C)	BCF		DESCRIBED ENVIRONMENTAL FATE (2)
			(2)	(3)	
Arsenic	74.92	5.727	333	0-17	Sorption important
Antimony	121.75	6.684	40-16000	-	Sorption important; many species mobile
Barium	137.34	3.51	-	-	-
Beryllium	9.0122	1.85	100	19	Sorption important; many species insoluble
Cadmium	112.4	8.642	1000-4000	2-3520	Bioaccumulation, sorption important
Chromium	51.996	7.20	70-6000	<1-2.8	CrVI soluble, mobile; CrIII insoluble
Copper	63.54	8.92	12-30000	0-2000	Sorption, bioaccumulation important
Lead	207.19	11.3	60-200	42-1700	Sorption, bioaccumulation important
Manganese	55	7.2	-	-	-
Mercury	200.59	13.5939	1000-100,000	4994-64000	Some insoluble species; sorption, metabolism, bioaccumulation important
Nickel	58.71	8.9	40-100	0.8-192	Soluble species, some bioaccumulation, sorption
Silver	107.87	10.5	200-3080	<1-240	Sorption important, some bioaccumulation
Vanadium	50.942	5.96	-	-	-
Zinc	65.38	7.14	1000-40000	51-1130	Sorption, bioaccumulation important
Cyanide	-	-	-	-	Biodegradation important
Selenium	78.96	4.81	400-800	28-351	Sorption important
Thallium	204.38	11.85	100000-150000	34-130	Sorption, bioaccumulation important

Mol. Wt. = Molecular weight  
 Sp. Grav. = specific gravity  
 BCF = Bioconcentration or bioaccumulation factor; freshwater species  
 (1) Deast, 1988  
 (2) USEPA, 1979  
 (3) USEPA, August 19, 1983a; USEPA, August 19, 1983b; USEPA, August 19, 1983c; USEPA, February 18, 1986; USEPA, August 19, 1983d; USEPA, April 10, 1986; USEPA, March 27, 1986; USEPA, August 19, 1983e; USEPA, October 1980a; USEPA, October 1980b; USEPA, October 1980c; USEPA October 1980d

TABLE 5-3

MOBILITY PARAMETERS FOR ORGANIC CHEMICALS  
MWRP, BETHPAGE, NEW YORK

Chemical	Mol (1) Wt. (g)	Sol (1) (mg/L)	Log Kow (2)(3)(4)	V.P. (1) (mmHg, 20C)	R (1)(3) atm.m <sup>3</sup> mol	Bcf (1)	Sp Grav. (2) (20 C)	Koc (1)
Trichloroethene	131.39	1100	2.53	5.79E1	9.1E-3	9.7E1	1.46	1.262E2
Tetrachloroethene	165.83	200	2.6(20C)	1.4E1	1.53E-2	2.52E2	1.626	3.64E2
Chloroform	119.38	8200	1.97(20C)	1.5E2	2.88E-3	5.56(6)	1.489	4.4E1
Toluene	92.13	534.8(25C)	2.69(20C)	2.87E1	6.66E-3	2.5E1(6)	0.867	3E2
4-Methylphenol	108.1	4400	1.92/1.94	4E-2	1.29E-6	1.1E1(7)	1.0347	2.43E1
bis(2-Chloroethyl)ether	143	10200	1.58	7.1E-1	1.3E-5	9.8E-1(6)	1.22	1.39E1
DDT	354.5	0.0055(25C)	6.19(20C)	1.9E-7(25C)	1.58E-5	8E6	-	3.9E6
DDD	320	0.09(25C)	1.6x10 <sup>6</sup>	1.2x10 <sup>-7</sup> (30C)	2.2x10 <sup>-8</sup>	1.8x10 <sup>5</sup>	NA(9)	7.7x10 <sup>5</sup>
DDE	318	0.04	9.1x10 <sup>6</sup>	6.5x10 <sup>-6</sup>	4.8x10 <sup>-5</sup>	8.9x10 <sup>5</sup>	NA	4.4x10 <sup>6</sup>
Chlordane	409.8	0.056(25C)	2.78	1E-5(25C)	9.4E-5	4E4	-	1.4E5
Aroclor 1248	299.5(4)	0.054(4)	5.75	4.9E-6(25C)(4)	4.4E-4	-	-	-
Aroclor 1254	328.4	0.031(25C)	6.03	7.71E-5(25C)	2.6E-3	1.3E5	-	5.3E5
Bis(2-ethylhexyl)phthalate	390.62	0.4(25C)	5.3	2E-7	3E-7	2.3E8	0.99	2E9
Butyl benzyl phthalate	312	2.9	4.78	6E-5	8.3E-6	4.7E4	1.1(25C)	1.7E5
Di-n-butyl phthalate	278.3	13(25C)	5.2	1E-5(25C)	2.8E-7	4.7E4	1.0485	1.7E5
Dimethylphthalate	194.2	5000	1.87	4.19E-3	2.15E-6	1.6E1	1.19(25C)	1.74E1
Naphthalene	128.2	31.7(25C)	3.01/3.45	8.7E-3(25C)	4.6E-4	4.2E2	1.152	9.4E2
2-Methylnaphthalene	142.19(2)	26-28(25C)	4.26	0.087(25C)	6.0x10 <sup>-4</sup> (7)	1.0x10 <sup>3</sup> (7)	0.994	5.8x10 <sup>3</sup> (7)
Acenaphthene	154.2	3.42(25C)	3.92	1.55E-3(25C)	9.1E-5	1.8E3	1.0262	4.6E3
Acenaphthylene	152.2	3.95(25C)	3.72	2.9x10 <sup>-2</sup>	1.45x10 <sup>-3</sup>	1.0x10 <sup>3</sup>	NA	2.5x10 <sup>3</sup>
Anthracene	178.2	0.045(25C)	4.45	1.7E-5(25C)	8.6E-5	4.7E3	1.283	1.4E4
Fluoranthene	202.3	0.26(25C)	5.33	5E-6(25C)	6.5E-6	1.2E4	1.252	3.8E4
Pyrene	202.3	0.13(25C)	5.18	2.5E-6(25C)	5.1E-6	1.2E4	-	3.8E4
Phenanthrene	178.2	1.0(25C)	4.45	9.6x10 <sup>-4</sup> (25C)	2.3x10 <sup>-4</sup>	4.7x10 <sup>3</sup>	1.025	1.4x10 <sup>4</sup>
Benz(a)anthracene	228.28	0.0057	5.61	2.2E-8	1E-6	5.3E4	-	2E5
Chrysene	228.3	0.0018(25C)	5.61	6.3E-9(25C)	1.05E-6	5.3E4	1.274	2E5
Benzo(b)fluoranthene	252.3	0.0014(25C)	6.57	5E-7	1.22E-5	1.4E5	-	5.5E5
Benzo(k)fluoranthene	252.3	0.0043(25C)	6.84	5E-7	3.87E-5	1.4E5	-	5.5E5

TABLE 5-3  
 MOBILITY PARAMETERS FOR ORGANIC CHEMICALS  
 NJWRP, BETHPAGE, NEW YORK  
 PAGE TWO

Chemical	Mol <sup>(1)</sup> Wt. (g)	Sol <sup>(1)</sup> (mg/L)	Log Kow (2)(3)(4)	V.P. (1) (mmHg, 20C)	H <sup>(1)(3)</sup> atm.m <sup>3</sup> /mol	BCF <sup>(1)</sup>	Sp. Grav. (2) (20 C)	Koc <sup>(1)</sup>
Benzo[a]pyrene	252	0.0038(25C)	5.98	5.6E-9	4.9E-7	1.09E4(6)	-	5.5E6
Indeno[1,2,3-c,d]pyrene	276.3	0.00053(25C)	7.66	1E-10	6.95E-8	3.5E5	-	1.6E6
Dibenz[ <i>a,h</i> ]anthracene	278.4	0.0005(25C)	5.97	1E-10	7.3E-8	6.9E5	-	3.3E6
Benzo[ <i>g,h,i</i> ]perylene	276	0.00026(25C)	7.23	1.03E-10(25C)	1.44E-7	3.5E5	-	1.6E6
Fluorene	116.2	1.69(25C)	4.18	7.1E-4	6.4E-5	3.8E3	1.203	7.3E3
trans-1,2-Dichloroethene	96.94	600	1.48	3.26E2	6.7E-2	4.8E1	1.26	5.9E1
1,1,1-Trichloroethane	133.41	720	2.47	1.23E2(25C)	3E-2	8.1E1	1.35	1.52E1
Carbon disulfide	76.14	2300(22C)	1.84/2.16	2.6E2	1.13E-2(7)	1.1E1(7)	1.263	1.42E2
1,1-Dichloroethane	98.96	5500	1.79	1.8E2	4.26E-3	1.9E1	1.174	3E1
1,1-Dichloroethene	96.94	400	1.68	5.91E2	1.9E-1	5.3E1	1.218	6.5E1
Carbon tetrachloride	153.82	785	2.64	9E1	2.3E-2	2.11E2	1.59	4.39E2
Ethylbenzene	106.16	152	3.15	7E0	6.6E-3	6.68E1	0.867	1.1E3
Xylenes	106.16	187	2.77-3.2	6.5E0	4.33E-3	1.5E-2	0.86-0.88	2.48E2
Di-n-octylphthalate	391	3(25C)	9.2	1.4E-4	1.7E-5	3.9E8	0.99	3.6E9
2-Methylphenol	108.1	8700	1.95	2.4E1	3.92E-6	1.1E1	1.041	2.45E1
4-Methylphenol	108.1	4400	1.92/1.94	4E-2	1.29E-6	1.1E1	1.0347	2.43E1
2,4-Dimethylphenol	122.2	590(25C)	2.42	6.2E-2	1.7E-2	7.5E1	1.036	9.6E1

Mol. Wt. = Molecular weight  
 Sol. = Solubility  
 Kow = Octanol - water partition coefficient  
 V.P. = Vapor pressure  
 H = Henry's law constant  
 BCF = Bioconcentration factor  
 Sp. Grav. = Specific gravity  
 Koc = Organic carbon partition coefficient

(1) USEPA, December 1982  
 (2) Verschueren, 1983  
 (3) USEPA RREL  
 (4) USEPA, 1979  
 (5) Heast, 1988  
 (6) MLM, January 13, 1992  
 (7) Estimated as per Lyman, et al, 1990  
 (8) Estimated from MLM, January 13, 1992.  
 (9) Not Available

aquatic organisms. A linear relationship between the octanol/water partition coefficient and the uptake of chemicals by fatty tissues of animal and human receptors has been determined (Lyman et al, 1990). PAHs, phthalates, and PCBs are several orders of magnitude more likely to partition to fatty tissues than the more water-soluble VOCs. The  $K_{ow}$  is also useful in characterizing the sorption of compounds by organic soils when experimental values are not available.

The organic carbon partition coefficient ( $K_{oc}$ ) is related to the water solubility and the  $K_{ow}$ . This parameter indicates the tendency of a chemical to bind to soil particles containing organic carbon. Chemicals with high  $K_{oc}$  generally have low water solubilities, and vice versa. Chemicals such as phthalates, PAHs, pesticides, and PCBs are relatively immobile in the subsurface environment and are preferentially bound to the soil phase. These compounds are not subject to groundwater transport to the same extent as compounds with high water solubilities.

$K_{oc}$  may be used to infer the relative rates at which the more mobile chemicals are transported in the groundwater. The  $K_{oc}$  and the fractional organic carbon content of the soil (FOC) may be used to determine an equilibrium distribution coefficient ( $K_d$ ) for the solid and aqueous matrices:

$$K_d = FOC \times K_{oc}$$

where:  $K_d$  = distribution coefficient (ug/kg/ug/l)  
FOC = soil organic carbon content (kg/kg)  
 $K_{oc}$  = organic carbon partition coefficient (ug/kg organic carbon/ug/l)

Total organic carbon (TOC) results may be used to estimate FOC for soils. Two subsurface soil samples per site, taken from a depth of 1-3 feet, were analyzed for TOC. The average TOC values for sites 1, 2, and 3 were 595 mg/kg, 1330 mg/kg, and 15950 mg/kg, respectively. Thus:

$$\begin{aligned} FOC &= (595 \text{ mg/kg}) (1E-6 \text{ kg/mg}) \\ &= 5.95E-4 \text{ kg organic carbon/kg soil (Site 1)} \end{aligned}$$

$$\begin{aligned} FOC &= (1330 \text{ mg/kg}) (1E-6 \text{ kg/mg}) \\ &= 1.3E-3 \text{ kg organic carbon/kg soil (Site 2)} \end{aligned}$$

$$\begin{aligned} FOC &= (15950 \text{ mg/kg}) (1E-6 \text{ kg/mg}) \\ &= 1.6E-2 \text{ kg organic carbon/kg soil (Site 3)} \end{aligned}$$

The distribution coefficient can, in turn, be used to estimate the potential for attenuation of a contaminant as a result of adsorption. The following dimensionless parameter is commonly encountered in solute transport modeling (Javandel et al., 1984):

$$R = 1 + (\rho/n)K_d$$

where: R = retardation factor  
rho = soil bulk density (kg/l)  
n = effective porosity of the soil  
Kd = distribution coefficient

The retardation factor can be interpreted as the velocity of a contaminant relative to the velocity of the groundwater. A retardation factor close to 1.0 indicates that the contaminant has little tendency to bind to soils and, hence, moves freely in the groundwater. By contrast, the larger the value of R, the greater the tendency for a contaminant to bind to the soil matrix, and consequently the slower it will move in groundwater.

Two subsurface samples per site taken from a depth of 1-3 feet were analyzed for their bulk density. Engineering parameter results are displayed in Table 5-4. The average bulk density for Sites 1, 2, and 3 were 1.4 g/cc, 1.9 g/cc, and 2.0 g/cc, respectively. An effective porosity of 0.3 is representative of unconsolidated, mixed sand and gravel deposits (Fetter, 1988). Thus, values of R can be calculated for selected contaminants, as shown in Table 5-5. From the calculated values of R, it can be seen that phthalates and PAHs tend to move slowly, whereas TCE and 1,1,1-TCA tend to move more quickly through this soil.

Vapor pressure provides an indication of the rate at which a chemical volatilizes from both soil and water. It is of primary significance in instances where environmental interfaces such as surface soil/air and surface water/air are important, rather than in evaluation of groundwater and subsurface soils. Vapor pressures for VOCs are generally many times higher than vapor pressures for phthalate esters and PAHs. Chemicals with higher vapor pressures are expected to enter the atmosphere much more readily than chemicals with lower vapor pressures. Most of the primary contaminants detected at the Bethpage activity are volatile in nature. As previously mentioned, little surface contamination by VOCs was observed relative to subsurface and groundwater contamination. Volatilization has been reported to be one of the environmental fate pathways of PCBs. For example, of 700,000 pounds of PCBs in uncapped landfills in the Hudson River Basin area, an estimated 3,000 pounds (about 4 percent) volatilize annually (Lunsford, 1982). Volatilization depends upon such factors as total exposed surface area, PCB concentrations, and amount of organic matter in the soil.

**TABLE 5-4**

**ENGINEERING PARAMETER RESULTS  
NWIRP, BETHPAGE, NY**

<b>Soil Boring Location (Depth: 3-5 Feet)</b>	<b>TOC (mg/kg)</b>	<b>BD (g/cc)</b>	<b>MGS (mm)</b>	<b>pH (SU)</b>
328	24000	1.8	0.40	6.0
316	7900	2.2	0.80	5.8
110	620	1.4	1.00	4.8
115	570	1.4	1.20	5.9
215	2500	1.2	0.85	6.8
204	1100	2.5	0.09	4.1
204D	390	2.6	0.40	4.0

TOC = Total Organic Carbon.

BD = Bulk Density.

MGS = Median Grain Size.

G/CC = Grams per cubic centimeter.

mm = Millimeters.

SU = Standard Units.

TABLE 5-5

RETARDATION FACTORS FOR ORGANIC SUBSOIL CHEMICALS  
 NWIRP, BETHPAGE, NY

Chemical	Koc	Kd			R		
		Site 1	Site 2	Site 3	Site 1	Site 2	Site 3
Trichloroethene	1.26E2	0.075	0.17	2.0	1.35	2.08	14.3
Tetrachloroethene	3.64E2	0.22	0.48	5.8	2.03	4.04	39.7
Toluene	3E2	-	-	4.78	-	-	32.9
Aroclor 1248	1.5E5	-	199.5	-	-	1264.5	-
Bis(2-ethylhexyl)phthalate	2E9	-	2.66E6	3.19E7	-	1.7E7	2.1E8
Butylbenzylphthalate	1.7E5	101.1	-	2712	472.8	-	1.8E4
Di-n-butylphthalate	1.7E5	101.1	226.1	-	472.8	1433	-
Naphthalene	9.4E2	-	1.25	-	-	8.92	-
Acenaphthene	4.6E3	-	6.12	-	-	39.76	-
Anthracene	1.4E4	-	18.62	-	-	118.9	-
Fluoranthene	3.8E4	-	50.54	606.1	-	321.1	4042
Pyrene	3.8E4	-	50.54	606.1	-	321.1	4042
Benz[a]anthracene	2E5	-	266	-	-	1686	-
Chrysene	2E5	-	266	3190	-	1686	2.1E4
Benzo[b]fluoranthene	5.5E5	-	731.5	8772.5	-	4634	5.8E4
Benzo[k]fluoranthene	5.5E5	-	731.5	8772.5	-	4634	5.8E4
Benzo[a]pyrene	5.5E6	-	7315	87725	-	4.6E4	5.8E5
Indeno[1,2,3-c,d]pyrene	1.6E6	-	2128	-	-	1.3E4	-
Benzo[g,h,i]perylene	1.6E6	-	2128	25520	-	1.3E4	1.7E5
Fluorene	7.3E3	-	9.71	-	-	62.50	-
Trans-1,2-Dichloroethene	5.9E1	0.03	-	0.94	1.14	-	7.27
1,1,1-Trichloroethane	1.52E2	0.09	-	-	1.42	-	-

Koc = Organic carbon partition coefficient.  
 Kd = Distribution coefficient.  
 R = Retardation factor.



Both vapor pressure and water solubility are of use in determining volatilization rates from surface water bodies. The Henry's law constant (H) may also be used to calculate the equilibrium contaminant concentrations in the vapor versus liquid phases for dilute solutions commonly encountered in environmental settings. The Henry's law constant is also useful for mass transfer applications for air-stripping column design.

Bioconcentration factors (BCFs) represent the ratio of aquatic-organisms tissue concentration to water concentration. The ratio is both contaminant- and species-specific, as well as tissue-specific. When site-specific values are not measured, literature values may be used, or the BCF may be derived from the Kow. Phthalate esters, PAHs, and pesticides will bioconcentrate at orders of magnitude greater than those concentrations found in the water where the exposed species reside. Bioconcentration is a well-known property of PCBs; they can be stored in fatty tissues of exposed organisms at concentrations much higher than the environmental concentration. VOCs are not as readily bioconcentrated as the semivolatiles, pesticides, or PCBs.

Specific gravity is the ratio of the mass of a given volume of pure chemical at a specified temperature to the mass of the same volume of water at a given temperature. Its primary use is to determine whether pure compounds or very high concentrations of a contaminant will float or sink in water. As shown in Table 5-3, chlorinated aliphatic compounds (e.g., TCE, PCE) are generally denser than water. Based on Bethpage activity groundwater results, it appears that contaminant movement has not been affected by density.

As shown in Table 5-2, most of the inorganic chemicals have a strong tendency to adsorb onto sediment particles, a factor which greatly reduces their mobility. For some metals, such as cadmium, lead, and mercury, bioaccumulation also plays an important role in environmental fate. While the metals themselves are insoluble in water, soluble species of some metals, such as chromium and antimony, can increase contaminant mobility. For metals such as beryllium, many species are insoluble, and mobility is not notable. It should be noted that for cyanide, environmental fate is mainly controlled by biodegradation. (Volatilization is a primary pathway for hydrogen cyanide.) (USEPA, 1979)



## 6.0 BASELINE RISK ASSESSMENT

This section provides a description of the risk assessment method employed for NWIRP Bethpage, as well as a summary of the risk assessment results. The objectives of the risk assessment are to define the actual or potential risks to human health and the environment resulting from the presence of contamination in the groundwater, surface water, soil, and sediment, and to provide the basis for determining appropriate remedial measures for these media in the forthcoming Feasibility Study.

Three major aspects of chemical contamination must be considered when assessing public health risks: (1) contaminants with toxic characteristics must be found in environmental media and must be released by either natural processes or by human action; (2) potential exposure points must exist; and (3) human or environmental receptors must be present at the point of exposure. Risk is a function of both toxicity and exposure; without any one of the three factors listed above, there will be no risk.

The risk assessment estimates the potential for human health risk at the site. Information regarding the toxicity of the compounds detected in the various media, the distribution of contamination, and a site-specific estimate of chemical intake via assumed exposure routes will be combined to estimate potential risks. The processes used at this site are in accordance with current EPA risk assessment guidance (USEPA, December 1989; USEPA, March 25, 1991).

A risk assessment consists of four components: (1) Data Evaluation; (2) Toxicity Assessment; (3) Exposure Assessment; and (4) Risk Characterization. Each of these components is briefly discussed below.

- The Data Evaluation (Section 6.1) is primarily concerned with the selection of chemicals of concern that are representative of the type and magnitude of potential human health and/or environmental effects. Contaminant concentrations relative to background levels, contaminant release and environmental transport mechanisms, exposure routes, and toxicity are considered to develop a list of contaminants used to define the site-associated risks.
- The Toxicity Assessment (Section 6.2) presents available human health and environmental criteria for all of the chemicals of concern. Quantitative toxicity indices are presented where they are available, including any applicable regulatory standards and criteria. Enforceable standards such as Maximum Contaminant Levels (MCLs); regulatory guidelines such as Ambient Water Quality Criteria (AWQCs) and Health Advisories; and dose-response parameters, such as Reference Doses (RfDs) and Cancer Slope Factors (CSFs), are presented for each

chemical of concern. Chemicals classified by the EPA as Group A (human), B (probable human), or C (possible human) carcinogens were treated as carcinogens and other chemicals were treated as noncarcinogens. Carcinogens are discussed in detail in Section 6.2.1.2 and 6.2.1.3.

- The Exposure Assessment (Section 6.3) identifies potential human health or environmental exposures either at the source area or offsite. Exposure routes are developed from information on the source area concentrations, contaminant release mechanisms, patterns of human activity, and other pertinent information.
- The Risk Characterization (Section 6.4) defines the risks associated with threshold (noncarcinogenic) and nonthreshold (carcinogenic) effects of the chemicals of concern through the use of estimated intakes and the RfDs/CSFs.

An ecological risk assessment is presented in Section 6.5. Section 6.6 contains a discussion of uncertainties associated with the risk assessment.

## **6.1 Data Evaluation**

### **6.1.1 Representative Concentrations**

The risk assessment for NWIRP Bethpage was performed using a representative concentration for each chemical in each medium at each of the three sites identified at Bethpage. Refer to Section 2.0 for a description of the field program and rationale for sampling and analysis. Usability of results is discussed below. The representative concentration was calculated using the latest risk assessment guidance from the EPA (USEPA, December 1989).

The validated data were used to calculate representative concentrations. For chemicals with at least one positive detection, non-detects (sample quantitation limit - SQL) were assumed to be one-half the detection limit. Rejected values (R) were eliminated from further consideration. Estimated values (J) were used at the reported value. Duplicate samples were averaged together and considered as one result. For duplicates, where one result was positive and the other result was a non-detect, the problem of calculating an average result arose whenever half the detection limit exceeded the positive result. It was considered undesirable for the average to exceed the positive result; therefore, half the positive result was used to represent the non-detect in this case.

The calculation of the representative concentration is a two-step process. First, the standard deviation of the sample set must be determined, as follows:

$$S = \text{Sqrt} [\text{Sum } (X_i - X_m)^2 / (n-1)]$$

where: S = Standard deviation  
X<sub>i</sub> = Individual sample value  
X<sub>m</sub> = Arithmetic mean for the n samples  
n = Number of samples

The upper 95 percent confidence limit (UCL) was then calculated as follows:

$$\text{UCL} = X_m + ts/n^{1/2}$$

where: UCL = Representative concentration (upper confidence limit)  
X<sub>m</sub> = Arithmetic mean  
t = Two-sided t distribution factor  
s = Standard deviation  
n = Number of samples

For the UCL, t = t(0.975).

For small sample sets or sample sets in which all positive results equal less than one-half the detection limit, the UCL can exceed the maximum detected concentration. In these cases, the maximum concentration was selected as the representative concentration. A sample calculation is provided in Appendix I. UCLs for all contaminants, from which the representative concentrations are derived, are presented in Appendix I.

#### 6.1.2 Chemicals of Concern

Chemicals of concern are identified in this section, based on various aspects of their occurrence and distribution, mobility, persistence, and toxicity. These chemicals are selected to represent site contamination and will provide the framework for the quantitative risk assessment.

The occurrence and distribution of site contaminants was discussed in detail in Section 4.0 (Nature and Extent of Contamination). Volatile organic compounds (VOCs) are the primary contaminants at the NWIRP Bethpage, although PCBs and some metals are also considered significant. Phthalates and PAHs were also detected. Refer to the site history of Section 1.0.

Appendix I summarizes the toxic effects for selected chemicals of concern. The summaries are presented in the form of toxicity profiles. Adverse effects on both human and environmental

receptors are discussed. The chemical of concern selection process for each site medium is discussed in the remainder of this section.

#### 6.1.2.1 Surface Soil

Surface soil samples will be assessed in three groups: Sites 1, 2, and 3. Representative concentrations for surface soil contaminants were provided in Tables 4-10, 4-11, 4-23, 4-24, 2,27, and 4-28.

When selecting organic chemicals of concern, it is significant to ascertain whether or not the chemicals are naturally occurring. Because this could not be determined, virtually all organic chemicals detected in surface soil in Sites 1, 2, and 3 were selected, as shown in Table 6-1. The exceptions included 4-methylphenol, bis(2-chloroethyl)ether, 2-methylnaphthalene, dibenzofuran, acenaphthylene and various Tentatively Identified Compounds. 4-Methylphenol and bis(2-chloroethyl)ether were not included because of their very low frequency of detection (one sample each) and the lack of an identifiable connection with the site history. Other chemicals were not included because they were detected at low frequencies and low concentrations and because other chemicals with similar properties were selected as chemicals of concern. TICs are considered unsuitable for quantitative risk assessment since neither their identities or concentrations are known with certainty. Some chemicals with low frequencies of detection (e.g., TCE and PCE) were selected because of their historical association with the site and their detection at significant levels in groundwater.

DDT was used to represent the total isomers and degradation products of DDT detected at the site. Use of the DDT Reference Dose (RfD) for DDD and DDE is a common practice that the EPA has not taken exception to in the past. Since RfDs are not currently available for DDD/DDE, and because the chemicals are structurally similar, use of the DDT RfD is considered appropriate. The specific oral Cancer Slope Factors for DDT, DDD, and DDE were used for the carcinogenic risk assessment. Although the pesticides had low frequencies of detection, a limited number of samples was tested for pesticides. Adequate physicochemical and toxicological information exist for these chemicals and both DDT and DDE are Group B2 carcinogens. Therefore, the pesticides were included although it is quite possible that they may not be a widespread problem at the site.

Inorganic chemicals of concern for surface soil are presented in Table 6-2. Chemicals were not selected when they were below reported background concentrations, except for cyanide, which was

TABLE 6-1

ORGANIC CHEMICALS OF CONCERN - SURFACE SOIL (ug/kg)  
MWIRP, BETHPAGE, NY

Known or Potential Carcinogens	Rep. Conc.	Noncarcinogens	Rep. Conc.
<b>Site 1</b>			
Trichloroethene	7.4	Naphthalene	53
Tetrachloroethene	27.4	Anthracene	66
DDT	170	Fluoranthene	837
DDE	270	Pyrene	793
Chlordane	240	Benzo[g,h,i]perylene	350
Aroclor 1248	7900	Fluorene	44
Bis(2-ethylhexyl)phthalate	179	Acenaphthene	53
Butylbenzylphthalate	180	Phenanthrene	554
Benzo[a]anthracene	439		
Chrysene	473		
Benzo[b]fluoranthene	575		
Benzo[k]fluoranthene	477		
Benzo[a]pyrene	502		
Indeno[1,2,3,-c,d]pyrene	349		
Dibenzo[a,h]anthracene	150		
<b>Site 2</b>			
Trichloroethene	2.25	Toluene	2.8
Chloroform	1.0	Naphthalene	186
Aroclor 1248	1900	Anthracene	314
Bis(2-ethylhexyl)phthalate	188	Fluoranthene	1091
Butylbenzylphthalate	354	Pyrene	815
Benzo[a]anthracene	446	Benzo[g,h,i]perylene	305
Chrysene	433	Fluorene	221
Benzo[b]fluoranthene	411	Acenaphthene	278
Benzo[k]fluoranthene	454	Phenanthrene	1041
Benzo[a]pyrene	463		
Indeno[1,2,3,-c,d]pyrene	313		
Dibenzo[a,h]anthracene	210		
<b>Site 3</b>			
Chloroform	1.0	Toluene	4.8
Aroclor 1248	830	Di-n-butyl phthalate	340
Aroclor 1254	530	Dimethylphthalate	190
Bis(2-ethylhexyl)phthalate	1298	Acenaphthene	160
Butylbenzylphthalate	508	Anthracene	446
Benzo[a]anthracene	637	Fluoranthene	1052
Chrysene	739	Pyrene	1462
Benzo[b]fluoranthene	716	Benzo[g,h,i]perylene	636
Benzo[k]fluoranthene	857	Fluorene	180
Benzo[a]pyrene	784		
Indeno[1,2,3,-c,d]pyrene	580		

Rep. Conc. = Representative Concentration.

TABLE 6-2

INORGANIC CHEMICALS OF CONCERN - SURFACE SOIL (mg/kg)  
 HWIRP, BETHPAGE, NY

Known or Potential Carcinogens	Rep. Conc.	Noncarcinogens	Rep. Conc.
<b>Site 1</b>			
Arsenic	33.1	Barium	46.6
Chromium	49.1	Silver	3.5
Nickel	16.1	Vanadium	30.4
		Cyanide	3.2
<b>Site 2</b>			
Arsenic	6.4	Copper	61.2
Chromium	128	Silver	0.82
Nickel	7.8	Vanadium	32.2
		Cyanide	1.5
<b>Site 3</b>			
Arsenic	26.1	Barium	76.2
Beryllium	1.1	Copper	400
Chromium	258	Mercury	0.21
		Vanadium	89.9
		Cyanide	2.3

Rep. Conc. = Representative Concentration.



included because it is not expected to be naturally occurring and because it was detected in other media. The following metals were not selected because they were widely occurring essential nutrients with very low toxicity: iron, calcium, magnesium, potassium, and sodium. Aluminum, antimony, cobalt, and selenium were not selected because there were not high frequencies of detection based on a comparison of positive results to the background detection limit for non-detects, and there were no apparent connections with the site history. Additionally, the toxicities of aluminum and cobalt are relatively low. Antimony and selenium had very low frequencies of detection and were not detected above the highest detection limit reported for background soil. As discussed in Section 4.5.1; chromium was assumed to be hexavalent chromium. Hexavalent chromium has been reported on site in the past (Geraghty & Miller, 1990).

#### 6.1.2.2 Subsurface Soil

Subsurface soil samples will be assessed in three groups: Sites 1, 2, and 3. Representative concentrations for subsurface soil contaminants were provided in Tables 4-3, 4-6, 4-14, 4-15, 4-27, and 4-28.

As with surface soil, virtually all organic compounds detected in the subsurface soil were selected as chemicals of concern. These chemicals of concern are presented in Table 6-3. Dibenzofuran, 2-methylnaphthalene, 2-butanone, acetone, and 1,1,2,2-tetrachloroethane were not included because of their very low frequency of detection, very low concentrations, and lack of detection in other media. TICs were not included for the same reasons presented in 6.1.2.1. Inorganic chemicals of concern of subsurface soil are presented in Table 6-4. All elements except calcium and sodium detected above background concentrations were included; these corresponded well to chemicals of concern selected for surface soil, although fewer metals were detected at significant concentrations in subsurface soil.

#### 6.1.2.3 Recharge Basins

Surface water and sediment results were presented in Tables 4-19, 4-20, 4-21, and 4-22. Surface water results revealed trace to low levels of organic contaminants. Direct contact with this water is not expected to occur. Effects upon groundwater via recharge are expected to be negligible compared to current groundwater and subsurface soil chemical concentrations, both of which will be assessed. Therefore, quantitative risk assessment will not be performed using surface water results.

As can be seen from Tables 4-22 and 4-5, concentrations of chemicals in sediment were not very different from reported background concentrations (low-level PAHs, trace VOCs, low-level metals). Sediment is also less likely to be an exposure source

TABLE 6-3

ORGANIC CHEMICALS OF CONCERN - SUBSURFACE SOIL (ug/kg)  
MWIRP, BETHPAGE, NY

Known or Potential Carcinogens	Rep. Conc.	Noncarcinogens	Rep. Conc.
<b>Site 1</b>			
Trichloroethene	36.5	1,2-Dichloroethene	3.1
Tetrachloroethene	834	1,1,1-Trichloroethane	14.5
Butyl benzyl phthalate	97.5	Di-n-butylphthalate	16
<b>Site 2</b>			
Trichloroethene	13.8	Di-n-butyl phthalate	40
Tetrachloroethene	3.84	Naphthalene	86
Aroclor 1248	6800	Acenaphthene	213
bis(2-Ethylhexyl)phthalate	62	Fluorene	180
Benzo[b]fluoranthene	462	Anthracene	196
Benzo[k]fluoranthene	369	Fluoranthene	805
Benzo[a]pyrene	397	Pyrene	760
Indeno[1,2,3,-c,d]pyrene	62	Benzo[g,h,i]perylene	281
Benzo[a]anthracene	379	Phenanthrene	564
Chrysene	444		
<b>Site 3</b>			
Trichloroethene	3.0	1,2-Dichloroethene	2.8
Tetrachloroethene	13.9	Toluene	1.0
bis(2-Ethylhexyl)phthalate	140	Fluoranthene	57
Butyl benzyl phthalate	41	Pyrene	70
Benzo[b]fluoranthene	46	Benzo[g,h,i]perylene	41
Benzo[k]fluoranthene	43		
Benzo[a]pyrene	50		
Chrysene	43		

Rep. Conc. = Representative Concentration.

TABLE 6-4

INORGANIC CHEMICALS OF CONCERN - SUBSURFACE SOIL (mg/kg)  
 MWIRP, BETHPAGE, NY

Known or Potential Carcinogens	Rep. Conc.	Noncarcinogens	Rep. Conc.
<b>Site 1</b>			
Arsenic Cadmium	1244 2.0	Copper Cyanide	7.9 6.0
<b>Site 2</b>			
Arsenic	5.9	Mercury Silver	0.18 1.3
<b>Site 3</b>			
		Copper Manganese	8.8 195

Rep. Conc. = Representative Concentration.

for onsite personnel than surface soil, and fugitive dust is not applicable for this sediment. The risks associated with sediment relative to surface soil and other media are expected to be negligible. Therefore, a list of COCs was not generated and quantitative risk assessment was not performed using sediment results.

#### 6.1.2.4 Groundwater

Representative concentrations in groundwater were presented in Tables 4-34, 4-35, 4-36, and 4-37. Organic chemicals of concern for groundwater are presented in Table 6-5. Virtually all organic compounds detected in groundwater were selected for quantitative assessment. The exceptions were acenaphthylene and TICs. Acenaphthylene was not included because of its low frequency and low concentrations. Also, other chemicals with similar physicochemical and toxicological properties were selected as chemicals of concern. TICs were excluded, as previously discussed.

Inorganic chemicals of concern for groundwater are presented in Table 6-6. Unfiltered results will be used for risk assessment in accordance with EPA policy. However, as discussed in Section 4.5.2, the inorganic concentrations may be overestimated due to the presence of sediment in monitoring well water. Suspended solids (SS) and dissolved solids (DS) were measured in well water. Results were as follows: HN-29S, SS=670 mg/L, DS=3300 mg/L; HN-27I, SS=37 mg/L, DS=110 mg/L; HN-25I, SS=<10 mg/L, DS=87.5 mg/L. Both dissolved and suspended inorganic compounds are expected to contribute to total inorganics in these wells.

Drinking water criteria and guidelines were used to select inorganic chemicals of concerns since some elements are naturally occurring in groundwater. Iron was not selected because adequate quantitative toxicity information does not exist for this essential element. Vanadium was selected although it has no MCL because intakes from some wells would exceed the RfD, assuming a 2 L/day consumption by a 70-kg adult (USEPA, January 1991).

#### 6.1.2.5 Future Groundwater

Subsurface soil contaminant concentration was used to predict future groundwater contamination using a leachate generation model.

The leachate model was applied to organics only because most inorganics, as previously discussed, have negligible mobility in subsurface soil, especially when compared to organics such as TCE.

TABLE 6-5

ORGANIC CHEMICALS OF CONCERN-CURRENT GROUNDWATER (ug/L)  
 NWIRP, BETHPAGE, NY

Known or Potential Carcinogens	Rep. Conc.	Noncarcinogens	Rep. Conc.
Trichloroethene	12285	Toluene	11.5
1,1-Dichloroethane	188	1,2-Dichloroethene	772
Tetrachloroethene	788	1,1,1-Trichloroethane	2113
1,1-Dichloroethene	54.7	Ethylbenzene	2.6
Carbon Tetrachloride	3.7	Xylenes	6.0
bis(2-Ethylhexyl)phthalate	21.5	Di-n-octyl phthalate	7.7
2-Methylphenol	2	2,4-Dimethylphenol	5.7
4-Methylphenol	2	Naphthalene	3
Benzo[b]fluoranthene	2	Fluoranthene	2
		Pyrene	2

Rep. Conc. = Representative Concentration.

TABLE 6-6

INORGANIC CHEMICALS OF CONCERN - CURRENT GROUNDWATER (ug/L)  
 MWIRP, BETHPAGE, NY

Known or Potential Carcinogens	Rep. Conc.	Noncarcinogens	Rep. Conc.
Arsenic	11.7	Manganese	402
Beryllium	1.3	Vanadium	159
Cadmium	82.9	Cyanide	578
Chromium	59.7		
Hexavalent chromium	21.1		
Lead	36.9		
Nickel	20.2		
Thallium	1.0		

Rep. Conc. = Representative Concentration.

The distribution coefficient,  $K_d$ , was calculated from FOC and Koc as discussed in Section 5.3. The leachate concentration was then calculated as follows:

$$C_L = C_S / K_d$$

where:  $C_L$  = Leachate concentration (mg/l)  
 $C_S$  = Representative soil concentration (mg/kg)  
 $K_d$  = Distribution coefficient

The dilution in the groundwater was then calculated using a simple water balance as follows:

$$\text{Dilution Ratio} = \frac{(Q_{\text{groundwater}} + Q_{\text{infiltration}})}{Q_{\text{infiltration}}}$$

$Q_{\text{groundwater}}$  may be determined from the cross-sectional area of the aquifer below the site times the Darcy groundwater velocity (KI).  $Q_{\text{infiltration}}$  may be determined as the infiltration rate times the area of the site.

Assumptions are as follows (see Appendix I):

Net infiltration rate: 13.65 in./yr.  
Hydraulic conductivity: 0.02 cm/sec  
Hydraulic gradient: 0.0023 (average across the NWIRP)  
Mixing zone: 50 ft

Site 1

Area: 65000 ft<sup>2</sup>  
Infiltration rate: 73938 cu. ft. yr.  
Cross section: 11000 ft<sup>2</sup> (upgradient boundary X mixing zone depth)  
Flow-through rate: 523531 CFY  
Dilution Ratio: 8.1

Site 2

Area: 50000 ft<sup>2</sup> (former sludge drying beds only)  
Infiltration rate: 56875 cu. ft. yr.  
Cross section: 11000 ft<sup>2</sup> (upgradient boundary X mixing zone depth)  
Flow-through rate: 523531 cu. ft. yr.  
Dilution Ratio: 10.2

Site 3

Area: 60000 ft<sup>2</sup> (salvage area only)  
Infiltration rate: 68250 cu. ft. yr.  
Cross section: 11000 ft<sup>2</sup> (upgradient boundary X mixing zone depth)

Flow-through rate: 523531 cu. ft. yr.  
Dilution Ratio: 8.7

The groundwater concentration was then calculated as follows:

$$C_{GW} = C_L/DR$$

where:  $C_{GW}$  = Groundwater concentration (mg/l)  
 $C_L$  = Leachate concentration (mg/l)  
DR = Dilution ratio

The relative predicted contributions to groundwater from each site can be seen in Table 6-7. In selecting future groundwater chemicals of concern and representative concentrations for risk assessment, the highest concentration resulting from any one site was used. This approach was used for two reasons: (1) the representative concentration across the whole site would not be greater than this concentration; and (2) in all cases, the leachate contribution from one site was relatively much more significant than the contribution from other sites, as can be seen in Table 6-7.

Table 6-8 displays predicted groundwater chemicals of concern and representative concentrations. Only the organic compounds with predicted concentrations of at least 0.1 ug/l were used. Thus di-n-butyl phthalate, bis(2-ethylhexyl) phthalate, benzo[b]fluoranthene, benzo[k]fluoranthene, benzo[a]pyrene, indeno[1,2,3-c,d]pyrene, benzo[g,h,i]perylene, and toluene were eliminated from further consideration.

## 6.2 Toxicity Assessment

The purpose of this section is to identify the potential health hazards associated with exposure to each of the chemicals of concern. A toxicological evaluation characterizes the inherent toxicity of a compound. The literature indicates that the chemicals of concern cause carcinogenic and/or noncarcinogenic health effects in humans. In addition, many of the chemicals have adverse effects on environmental receptors. Although the chemicals of concern may cause adverse health effects, dose-response relationships and the potential for exposure must be evaluated before the risks to receptors can be determined. Dose-response relationships correlate the magnitude of the intake with the probability of toxic effects, as discussed below. All toxicity information is presented in Table 6-10 and Appendix I.

### 6.2.1 Health Effects

An important component of the risk assessment process is the relationship between the intake of a compound (the amount of a chemical that is absorbed by a receptor) and the potential for adverse health effects resulting from exposure to that dose.



TABLE 6-7  
 FUTURE GROUNDWATER CONTAMINATION - ORGANICS  
 MWIRP, BETHPAGE, NY

Chemical	Koc	Site 1 (TOC = 5.95E-4)			Site 2 (TOC = 1.33E-3)			Site 3 (TOC = 1.59E-2)			
		ug/Kg Conc	Kd	ug/L CEM	ug/L CL	ug/L CEM	ug/L CL	ug/L Conc	Kd	ug/L CL	ug/L CEM
TCE	126	36	7.5E-2	487	13.8	1.7E-1	82	3.0	2	1.5	0.2
PCE	364	830	2.2E-1	3850	3.8	4.8E-1	7.9	14	5.8	2	0.3
BBPHTH	1.7E5	97	1.0E2	1				41	2711	0.02	0.002
12DCE	59	3	3.5E-2	88	10.9			2.8	0.94	3.0	0.3
111TCA	152	14	9.0E-2	160	19.8						
DBPHTH	1.7E5	16	1.0E2	0.1	40	226	0.2	0.02			
PCB1248	1.5E5				6800	199	34	3.3			
DEHP	2E9				62	2.7E6	2.3E-5	2.3E-6	104	3.2E7	5E-7
BBF	5.5E5				462	730	0.6	0.06	46	8772	6E-4
BKF	5.5E5				369	730	0.5	0.05	43	8772	6E-4
BAP	5.5E6				397	7315	0.05	5E-3	50	8.8E4	1E-4
1INDENO	1.6E6				62	2128	0.03	3E-3			
BAA	2E5				379	266	1.4	0.1			
CHRY	2E5				444	266	1.7	0.2	43	3190	0.014
NAP	940				86	1.3	69	6.7			
ACEE	4600				213	6.1	34.8	3.4			
FLE	7300				180	9.7	18.5	1.8			
ANTH	14000				196	19	10.5	1			
FLA	38000				805	50	15.9	1.6	57	606	0.1
PY	38000				760	50	15.0	1.5	70	606	0.1
BGHP	1.6E6				281	2128	0.1	0.01	41	25520	2E-4
TOL	300								1.0	4.8	0.2
PHE	14,000				564	18.62		30.2	3		0.02

TABLE 6-7  
 FUTURE GROUNDWATER CONTAMINATION - ORGANICS  
 PAGE TWO

Koc = Organic Carbon Partition Coefficient  
 TOC = Total organic carbon  
 Conc = Representative Concentration (ug/kg)  
 Kd = Distribution Coefficient  
 CL = Leachate Concentration (ug/l)  
 CGW = Predicted groundwater Concentration (ug/l)

TCE = Trichloroethene  
 PCE = Tetrachloroethene  
 BBPHTH = Butylbenzylphthalate  
 12DCE = 1,2-dichloroethene  
 11TCA = 1,1,1-Trichloroethene  
 DBPHTH = Di-n-butyl phthalate  
 PCB 1248 = Arochlor 1248  
 DEHP = bis(2-ethylhexyl) phthalate

BBF = Benzo(b)fluoranthene  
 BKF = Benzo(k)fluoranthene  
 BAP = Benzo(a)pyrene  
 INDENO = Indeno(1,2,3-c,d)pyrene  
 BAA = Benz(a)anthracene  
 CHRYS = Chrysene  
 NAP = Naphthalene

FILE = Fluorene  
 ANTH = Anthracene  
 FLA = Fluoranthene  
 PY = Pyrene  
 BghiP = Benzo(g,h,i)perylene  
 TOL = Toluene  
 PHE = Phenanthrene

TABLE 6-8

CHEMICALS OF CONCERN - FUTURE GROUNDWATER (ug/L)  
 NWIRP, BETHPAGE, NY

Known or Potential Carcinogens	Rep. Conc.	Noncarcinogens	Rep. Conc.
Trichloroethene	60.1	trans-1,2-Dichloroethene	10.9
Tetrachloroethene	475.4	1,1,1-Trichloroethane	19.8
Butyl benzyl phthalate	0.1	Naphthalene	6.7
Aroclor 1248	3.3	Acenaphthene	3.4
Chrysene	0.2	Fluorene	1.8
Benzo[a]anthracene	0.1	Anthracene	1.0
		Fluoranthene	1.6
		Pyrene	1.5
		Phenanthrene	3.0

Rep. Conc. = Representative Concentration

Dose-response relationships provide a means by which potential public health impacts may be quantified. The published information of doses and responses is used in conjunction with information on the nature and magnitude of human exposure to develop an estimate of potential health risks.

Reference Doses (RfDs) and Cancer Slope Factors (CSFs) have been developed by the EPA for many organics and inorganics. This section provides a brief description of these parameters.

#### 6.2.1.1 Reference Doses (RfDs)

The RfD is developed by the EPA for chronic and/or subchronic human exposure to hazardous chemicals and is based solely on the noncarcinogenic effects of chemical substances. The RfD is usually expressed as a dose (mg) per unit body weight (kg) per unit time (day). It is generally derived by dividing a No-Observed-(Adverse)-Effect-Level (NOAEL or NOEL) or a Lowest-Observed-Adverse-Effect-Level (LOAEL) by an appropriate uncertainty factor. NOAELs, etc., are determined from laboratory or epidemiological toxicity studies. The uncertainty factor is based on the availability of toxicity data.

Uncertainty factors are generally applied as multiples of 10 to represent specific areas of uncertainty in the available data. A factor of 10 is used to account for variations in the general population (to protect sensitive subpopulations) (1) when extrapolating test results from animals to humans (to account for interspecies variability) (2) when a NOAEL derived from a subchronic study (instead of a chronic study) is used to develop the RfD, and (3) when a LOAEL is used instead of a NOAEL. In addition, EPA reserves the use of a modifying factor of up to 10 for professional judgment of uncertainties in the data base not already accounted for. The default value of the modifying factor is 1.

The RfD incorporates the surety of the evidence for chronic human health effects. Even if applicable human data exist, the RfD (as diminished by the uncertainty factor) still maintains a margin of safety so that chronic human health effects are not underestimated. Thus, the RfD is an acceptable guideline for evaluation of noncarcinogenic risk, although the associated uncertainties preclude its use for precise risk quantitation. RfDs for site contaminants are provided in Table 6-10.

#### 6.2.1.2 Carcinogenic Slope Factor (CSF)

CSFs are applicable for estimating the lifetime probability (assumed 70-year lifespan) of human receptors developing cancer as a result of exposure to known or potential carcinogens. This factor is generally reported in units of  $(\text{mg}/\text{kg}/\text{day})^{-1}$  and is derived through an assumed low-dosage linear relationship and an

extrapolation from high to low dose-responses determined from animal studies. The value used in reporting the slope factor is the upper 95 percent confidence limit. CSFs for site contaminants are provided in Table 6-10.

#### 6.2.1.3 EPA Weight-of-Evidence

The weight of evidence designations indicate the preponderance of evidence regarding carcinogenic effects in humans and animals. The categories are defined in Table 6-9.

#### 6.2.2 Applicable or Relevant and Appropriate Requirements (ARARs)

This section presents available regulatory standards or guidelines for the chemicals of concern selected in the preceding section. Currently, the only enforceable regulatory standards for exposure to groundwater contaminants are the Maximum Contaminant Levels (MCLs). However, MCLs have not been specified for many of the chemicals of concern. Therefore, other regulatory guidelines may be used for comparative purposes to infer health risks and environmental impacts. Relevant regulatory guidelines include Ambient Water Quality Criteria, MCL Goals, and EPA Drinking Water Health Advisories. ARARs and dose-response parameters (CSFs and RfDs) are presented in Table 6-10. The environmental criteria are discussed briefly below.

##### 6.2.2.1 Maximum Contaminant Levels (MCLs)

MCLs are enforceable standards promulgated under the Safe Drinking Water Act and are designed for the protection of human health. MCLs are based on laboratory or epidemiologic studies and apply to drinking water supplies consumed by a minimum of 25 persons. They are designed for prevention of human health effects associated with lifetime exposure (70 years) of an average adult (weighing 70 kg) consuming 2 liters of water per day, but they also reflect technical limits of removing the contaminant from water. These enforceable standards are also based upon the fraction of toxicant expected to be absorbed by the gastrointestinal tract.

##### 6.2.2.2 Maximum Contaminant Level Goals (MCLGs)

MCLGs are generally specified as zero for carcinogenic substances, based on the assumption of nonthreshold toxicity, and do not consider the technical or economic feasibility of achieving these goals. MCLGs are nonenforceable guidelines based entirely on health effects. The MCLs have been set as close to the MCLGs as is considered technologically and economically feasible.

TABLE 6-9

EPA WEIGHT-OF-EVIDENCE CARCINOGENIC CLASSIFICATIONS  
 MWIRP, BETHPAGE, NY

EPA Category	Description of Group	Description of Evidence
Group A	Human carcinogen	Sufficient evidence from epidemiologic studies to support a causal association between exposure and cancer.
Group B1	Probable human carcinogen	Limited evidence of carcinogenicity in humans from epidemiologic studies.
Group B2	Probable human carcinogen	Sufficient evidence of carcinogenicity in animals; inadequate evidence of carcinogenicity in humans.
Group C	Possible human carcinogen	Limited evidence of carcinogenicity in animals.
Group D	Not classified	Inadequate evidence of carcinogenicity in animals.
Group E	No evidence of carcinogenicity in humans	No evidence for carcinogenicity in at least two adequate animal tests or in both epidemiologic and animal studies.

Source: USEPA, January 1991

TABLE 6-10  
STANDARDS, GUIDELINES, AND DOSE-RESPONSE PARAMETERS FOR CHEMICALS OF CONCERN  
MUIP, BETWAPE, BY

Compound	CSF (1) (mg/kg/day) <sup>-1</sup>		Chronic RFD (1) (mg/kg/day)		REL/POUR (ug/L) MCL (2)(3)(4)(5)(6) (7)(8)	DMA (ug/L)	AMRC (ug/L) (9)			MIS (10) MCL (ug/L)
	Inhalation	Oral	Inhalation	Oral			Aquatic Life	Drinking Water & Fish	Fish Only	
Trichloroethene	1.7E-2 82	1.1E-2 82			5 G:0		21900(L)	2.7	80.7	5
Tetrachloroethene	1.8E-3 82	5.1E-2 82		1E-2	5 G:0	1-day child - 2000 10-day child - 2000 Longer term child - 1000 Longer term adult - 5000	840(L)	0.8	8.85	5
Chloroform	8.1E-2 82	6.1E-3 82		1E-2	100	1-day child - 4000 10-day child - 4000 Longer term child-100 Longer term adult-500	1240(L)	0.19	15.7	100 (total THM)
Toluene			6E-1	2E-1	1000 G:1000	1-day child - 2000 10-day child - 2000 Longer term child-2000 Longer term adult - 7000 Lifetime adult - 1000	17500(fa) (L)	14300	424000	5
4-Methylphenol	C	C		5E-2						50
bis(2-chloroethyl)ether	1.1 82	1.1 82								5
DDT	3.4E-1 82	3.4E-1 82		5E-4			0.001	0.000024	0.000024	50
Chlordane	1.3 82	1.3 82		6E-5	2 G:0	1-day child - 60 10-day child - 60	0.0043	0.00046	0.00048	50
Aroclor 1248	82	7.7 82			0.5 (PCBs) G:0		0.014 (PCBs)	0.000079 (PCBs)	0.000079 (PCBs)	50
Aroclor 1254	82	7.7 82			0.5 (PCBs) G:0		0.014 (PCBs)	0.000079 (PCBs)	0.000079 (PCBs)	50
bis(2-ethylhexyl)phthalate	82	1.4E-2 82		2E-2	6(P) G:0		3(L) (phthal) 560(P)	15000	5000	50
Butyl benzyl phthalate		C		2E-1	100 (P)		3(L) (phthal)			50
Di-n-butyl phthalate				1E-1			3(L) (phthal)	35000	154000	50

TABLE 6-10  
STANDARDS, GUIDELINES, AND DOSE-RESPONSE PARAMETERS FOR INDICATOR CHEMICALS  
PAGE TWO

Compound	CSF <sup>(1)</sup> (mg/kg/day) <sup>-1</sup>		Chronic RFD <sup>(1)</sup> (mg/kg/day)		MCL/MPAR MCL (ug/L) (1)(2)(3)(4) (5)(6)(7)(8)	DWA (ug/L)	MDC (ug/L)			MTE MCL (ug/L)
	Inhalation	Oral	Inhalation	Oral			Aquatic Life	Drinking Water & Fish	Fish Only	
Dimethyl phthalate				1E0	-	-	3(L) (phthal)	313000	2900000	50
Naphthalene				4E-3	-	1-day child - 500 10-day child - 500 Longer term child - 400 Longer term adult - 1000 Lifetime adult - 20	620(L)			50
Acenaphthene				6E-2	-		520(L)			50
Anthracene				3E-1	-		300(mg) (L)(PAHs)	0.0028 (PAHs)	0.0311 (PAHs)	50
Fluoranthene				4E-2	-		3960(mg) (L)	42	54	50
Pyrene				3E-2	-		300(mg) (L)(PAHs)	0.0028(PAHs)	0.0311 (PAHs)	50
Benzo(a)anthracene	B.845E-1 B2	1.6475 B2			0.1(P) G:0		300(mg) (L)(PAHs)	0.0028(PAHs)	0.0311 (PAHs)	50
Chrysene	2.684E-2 B2	5.08E-2 B2			0.2(P) G:0		300(mg) (L)(PAHs)	0.0028(PAHs)	0.0311 (PAHs)	50
Benzo(b)fluoranthene	B.54E-1 B2	1.61 B2			0.2(P) G:0		300(mg) (L)(PAHs)	0.0028(PAHs)	0.0311 (PAHs)	50
Benzo(k)fluoranthene	4.026E-1 B2	7.59E-1 B2			0.2(P) G:0		300(mg) (L)(PAHs)	0.0028(PAHs)	0.0311 (PAHs)	50
Benzo(a)pyrene	6.1 B2	1.15E1 B2			0.2(P) G:0		300(mg) (L)(PAHs)	0.0028(PAHs)	0.0311 (PAHs)	50
Indeno(1,2,3-c,d)pyrene	1.4152 B2	2.668 B2			0.4(P)		3(mg) (L)(PAHs)	0.0028(PAHs)	0.0311 (PAHs)	50



TABLE 6-10  
STANDARDS, GUIDELINES, AND DOSE-RESPONSE PARAMETERS FOR INDICATOR CHEMICALS  
PAGE THREE

Compound	CSF(1) (mg/kg/day) <sup>-1</sup>		Chronic RFD(1) (mg/kg/day)		MCL/MPOAR MCLG (ug/L) (2)(3)(4)(5)(6) (7)(8)	DWA (ug/L)	AMRC (ug/L)			MYS MCL (ug/L)
	Inhalation	Oral	Inhalation	Oral			Aquatic Life	Drinking Water & Fish	Fish Only	
Dibenz(a,h)anthracene	6.771 B2	1.2765E1 B2			0.3(P) 6:0		300(mg) (L)(PAHs)	0.0028(PAHs)	0.0311 (PAHs)	50
Benzo(a,h,i)perylene							300(mg) (L)(PAHs)	0.0028(PAHs)	0.0311 (PAHs)	50
Fluorene				4E-2			300(mg) (L)(PAHs)	0.0028(PAHs)	0.0311 (PAHs)	50
trans,1,2-Dichloroethene				2E-2	100 6:100 70(cis) 6:70(cis)	1-day child - 20000 10-day child - 2000 Longer term child - 2000 Longer term adult - 6000 Lifetime adult - 100	11600 (L)(fs)	0.033	1.85	5
1,1-Trichloroethane			3E-1	9E-2	200 6:200	1-day child - 100000 10-day child - 40000 Longer term child - 40000 Longer term adult - 100000 Lifetime adult - 200	31200(mg) (L)	18400	1030000	5
Carbon disulfide			3E-3	1E-1						50
Arsenic	5E1 A	A		1E-3	50(M) 6:0					50
Antimony				4E-4	10/5(P) 6:3	1-day child - 15 10-day child - 15 Longer term adult - 15 Lifetime adult - 3	1600(L) 30(P)	146	45000	-
Barium				5E-2	1000(M) 2000(F) 6:2000	Lifetime adult - 2000	1000			1000
Beryllium	6.4 B2	4.3 B2		5E-3	1(P) 6:0	1-day child - 30000 10-day child 30000 Longer term child - 4000 Longer term adult - 20000	5.3(L)	0.0068	0.117	-
Cadmium	6.1 B1			5E-4	10(M);5(F) 6:5	1-day child - 40 10-day child - 40 Longer term child - 5 Longer term adult - 20 Lifetime adult - 5	1.1 (+)	10		10

TABLE 6-10  
STANDARDS, GUIDELINES, AND DOSE-RESPONSE PARAMETERS FOR INDICATOR CHEMICALS  
PAGE FOUR

Compound	CSF (mg/kg/day) <sup>-1</sup>		Chronic RFD (mg/kg/day)		MCL/MPAR MCL (ug/L)	DWA (ug/L)	MCL (ug/L)			MIS MCL (ug/L)
	Inhalation	Oral	Inhalation	Oral			Aquatic Life	Drinking Water & Fish	Fish only	
Chromium	VI-4, 1E1 A		III-6E-7 VI-6E-7	III-1E0 VI-9E-3	50(M); 100(F) G:100	1-day child - 1000 10-day child - 1000 Longer term child - 200 Longer term adult - 800 Lifetime adult - 100	VI-11 III-210(+)	VI-50 III-170000	III- 3433000	50
Copper				4E-2	1300(A) G:1300		12(+)			1000(S)
Lead	B2	B2	4.3E-4	1.4E-3	50(M); 15(A) G:0		3.2(+)	50		50
Manganese			1E-4	1E-1	50(S)			50	100	300(S)
Mercury			9E-5	3E-4	2 G:2	Longer term adult - 2 Lifetime adult - 2	0.012	0.144	0.146	2
Nickel	8.4E-1 A			2E-2	100(P) G:100	1-day child - 1000 10-day child - 1000 Longer term child - 100 Longer term adult - 600 Lifetime adult - 100	160(+)	13.4	100	
Silver				3E-3	50(M)	1-day child - 200 10-day child - 200 Longer term child - 200 Longer term adult - 200 Lifetime adult - 100	0.12	50		50
Vanadium				7E-3		1-day child - 80 10-day child - 80 Longer term child - 30 Longer term adult - 110 Lifetime adult - 20				
Zinc				2E-1	5000(S)	1-day child - 4000 10-day child - 4000 Longer term child - 2000 Longer term adult - 9000 Lifetime adult - 2000	110(+)			5000(S)
Cyanide				2E-2	200(P) G:200	1-day child - 200 10-day child - 200 Longer term child - 200 Longer term adult - 800 Lifetime adult - 200	5.2	200		

TABLE 6-10  
STANDARDS, GUIDELINES, AND DOG-RESPONSE PARAMETERS FOR INDICATOR CHEMICALS  
PAGE FIVE

Compound	CSF (mg/kg/day) <sup>-1</sup>		Chronic RFD (mg/kg/day)		MCL/MPML MCLG (ug/L)	PMA (ug/L)	MDC (ug/L)			RFS MCL (ug/L)
	Inhalation	Oral	Inhalation	Oral			Aquatic Life	Drinking Water & Fish	Fish Only	
1,1-Dichloroethane			1E-1	1E-1	-					5
1,1-Dichloroethene	1.2 C	6E-1 C		9E-3	7 G:7	1-day child - 2000 10-day child - 1000 Longer term child - 1000 Longer term adult - 4000 Lifetime adult - 7	11600(fa) (L)	0.033	1.85	5
Carbon Tetrachloride	1.3E-1 B2	1.3E-1 B2		7E-4	5 G:0	1-day child - 4000 10-day child - 200 Longer term child - 70 Longer term adult - 300	35200(fa) (L)	0.4	6.94	5
Ethylbenzene			3E-1	1E-1	700 G:700	1-day child - 4000 10-day child - 3000 Longer term child - 1000 Longer term adult - 3000 Lifetime adult - 700	32000 (fa) (L)	1400	3260	5
Xylenes			9E-2	2	10000 G:700	1-day child - 40000 10-day child - 40000 Longer term child - 100000 Longer term adult - 100000 Lifetime adult - 10000				5
Di-n-octyl phthalate				2E-2	-		3(L) (partial)			50
Phenanthrene				2.9E-2			300(ma)(L) (PARTIAL)	0.002 8(PAHS)	0.0311	50
2-Methylphenol				5E-2						50
2,4-Dimethylphenol				2E-2			2120(fa) (L)			50
Selenium					50(P);10(G) G:50		5			10
Thallium				7E-5	27(P) G:0.5	1-day child - 7 10-day child - 7 Longer term child - 7 Longer term adult - 20 Lifetime adult - 0.4	40(L)	13	48	-

**TABLE 6-10  
STANDARDS, GUIDELINES, AND DOS-RESPONSE PARAMETERS FOR INDICATOR CHEMICALS  
PAGE SIX**

CSF = Cancer slope factor  
RFD = Risk reference dose  
G = MCLG = MCL Goal  
MCL = Maximum contaminant level  
N = NPDWR = National Primary Drinking Water Regulation  
P = Proposed  
DWHA = Drinking Water Health Advisory  
S = Secondary MCL  
AWQC = Ambient Water Quality Criterion (Chronic freshwater unless otherwise indicated)  
NYS = New York State  
L = Lowest observed effects level  
fa = Freshwater acute  
PCBs = Based on polychlorinated biphenyls  
Phthal = Based on total phthalates  
THM = Trihalomethanes  
A = Cancer weight of evidence A (human carcinogen)  
B1 = Cancer weight of evidence B1 (probable human carcinogen)  
B2 = Cancer weight of evidence B2 (probable human carcinogen)  
C = Cancer weight of evidence C (possible human carcinogen)  
PAHs = Polycyclic aromatic hydrocarbons  
Ms = Marine acute  
F = Final  
+ = Hardness - dependent  
A = Action Level

- (1) USEPA, January 1991
- (2) USEPA, January 30, 1991
- (3) USEPA, April 1991
- (4) USEPA, July 1990
- (5) USEPA, July 25, 1990
- (6) USEPA, July 1, 1991
- (7) USEPA, June 7, 1991
- (8) USEPA, July 18, 1991
- (9) USEPA, 1987
- (10) New York State Sanitary Code, July 3, 1991

#### 6.2.2.3 Ambient Water Quality Criteria (AWQC)

AWQC were developed under the Clean Water Act and are not enforceable Federal regulatory guidelines, but are of primary utility in assessing the potential for toxic effects in aquatic organisms as well as human receptors. AWQC consider acute and chronic human health effects from ingestion of both water (2 L/day) and aquatic organisms (6.5 g/day). The AWQC may also be adjusted to consider ingestion of water alone (2 L/day). The AWQC for protection of human health for carcinogenic substances are based on EPA's specified incremental cancer risk range of one additional case of cancer in an exposed population of 100,000 to 10,000,000 persons and are generally based on older toxicological data.

#### 6.2.2.4 Drinking Water Health Advisories (DWHAs)

DWHAs are guidelines developed by the EPA Office of Drinking Water for non-regulated contaminants in drinking water. These guidelines are designed to consider both acute and chronic toxic effects in children (with an assumed body weight of 10 kg) who consume 1 L of water per day and in adults (assumed body weight of 70 kg) who consume 2 L of water per day. Health Advisories are generally available for acute (1-day), subchronic (10-day), and chronic (longer term or lifetime) exposure scenarios. These guidelines are designed to consider only threshold effects and, as such, are not used to set acceptable levels for known or probable human carcinogens.

Values of the available regulatory standards and guidelines are presented in Table 6-10. Table 6-10 presents values for the chemicals of concern that are human, suspected human, or possible human carcinogens; for chemicals having only noncarcinogenic effects; and for chemicals having both carcinogenic and noncarcinogenic effects.

#### 6.2.3 Summary

Table 6-10 presents the values of the available Federal ARARs and dose-response parameters for both carcinogenic and noncarcinogenic chemicals of concern. If the concentration or intake of a chemical exceeds these standards or guidelines, the possibility exists that a receptor may experience adverse health effects. Expected intakes of each chemical are presented in the Exposure Assessment (Section 6.3).

#### 6.3 Exposure Assessment

The purpose of this section is to evaluate the potential for human exposure to the hazardous chemicals in the environmental media at NWIRP Bethpage. This section characterizes the exposed populations, identifies actual or potential exposure routes, and provides exposure estimates. The nature and extent of

contamination upon which the exposures are based was presented in Section 4.0.

To determine whether there is an actual or potential exposure at Bethpage, the most likely pathways of contaminant release and transport, as well as the human and environmental activity patterns at Bethpage must be considered. A complete exposure pathway has three components: a source, a route of transport, and an exposure point for receptors. These components are addressed in the following subsections.

### **6.3.1 Exposure Routes**

There are several environmental media at the site through which receptors can be either directly or indirectly exposed to site-related contaminants--groundwater, surface and subsurface soil, surface water, and sediment. Exposure routes involved include dermal contact, ingestion, and inhalation. Exposure scenarios are summarized in Table 6-11. Note that a child/adult trespasser scenario was not considered at any of the sites because of the stringent access restrictions in place.

#### **6.3.1.1 Groundwater**

Public supply wells and production wells for industrial use are located in the Bethpage area. Because of historical information indicating contamination of groundwater and the local usage of groundwater for drinking water, groundwater is the primary pathway of concern. Four groundwater exposure scenarios will be evaluated.

The first is residential use of groundwater, which will be evaluated using monitoring and production well data. Both children and adults will be considered as potential receptors. The second scenario for groundwater exposure involves potential employee exposures to work place wells; this scenario considers adult receptors only and involves limited exposure (i.e., exposures via showering are not applicable for the typical work place).

The third and fourth scenarios involve the future use of groundwater by employees and residents. Future groundwater concentrations were estimated from current subsurface soil concentrations, as described in Section 6.1.2.5.

TABLE 6-11

EXPOSURE SCENARIOS  
 MWIRP, BETHPAGE, NY

MEDIUM	RECEPTOR	EXPOSURE ROUTE	RATIONALE
<b>CURRENT SCENARIOS</b>			
Surface Soil	Adult Worker	Dermal, Incidental Ingestion	Access restrictions prevent trespassers, but workers are on site.
Surface Water	None	--	Recharge basins not used for drinking, recreation, or support of aquatic life; quantifiable exposure not anticipated.
Sediment	None	--	See above.
Groundwater	Adult Worker	Ingestion	Theoretical consumption of monitoring well water; showering ruled out as regular work place exposure.
	Adult Resident	Ingestion, Dermal, Inhalation	Theoretical consumption and showering using monitoring well water.
	Child Resident	Ingestion, Dermal	Theoretical consumption and bathing using monitoring well water.
Air (fugitive dust emissions)	Adult and Child Residents	Inhalation	Round-the-clock exposure to fugitive dust; residences located adjacent to site
<b>FUTURE SCENARIOS</b>			
Surface Soil (using current subsoil)	Adult Worker	Dermal, Incidental Ingestion	Access restrictions prevent trespassers, but workers are on site.
Groundwater (assuming leaching from current subsoil)	Adult Worker	Ingestion	Theoretical consumption of monitoring well water; showering ruled out as regular work place exposure.
	Adult Resident	Ingestion, Dermal, Inhalation	Theoretical consumption and showering using monitoring well water.
	Child Resident	Ingestion, Dermal	Theoretical consumption and bathing using monitoring well water.
Air (fugitive dust emissions)	Adult and Child Residents	Inhalation	Round-the-clock exposure to fugitive dust; residents located adjacent to site.

#### 6.3.1.2 Soil

Because the Bethpage Activity is managed by the Navy, access is restricted. Therefore, direct contact with soil (dermal contact and incidental ingestion) is assumed to be limited to adult workers. The dermal and ingestion pathways for soil will consider adult employee exposure only.

Fugitive dust emissions are considered to be a potential route of exposure for adult and child residents living near the site. Residential areas are reportedly adjacent to the site. Volatilization of contaminants from soil is considered to be negligible, since the contaminants most likely to volatilize are present in significant amounts in subsurface as opposed to surface soil.

Future contact with soil will be assessed, assuming that the subsurface soil might eventually be exposed. For this scenario, current subsoil concentrations were used, and direct contact (ingestion, dermal absorption) for adult employees was considered. Fugitive dust emissions and inhalation by adult and child residents were also considered.

#### 6.2.1.3 Surface Water/Sediment (Recharge Basins)

Surface water and sediment results were presented in Tables 4-19, 4-20, 4-21, and 4-22. Surface water results revealed trace to low levels of organic contaminants. Direct contact with this water is not expected to occur. Effects upon groundwater via recharge are expected to be negligible compared to current groundwater and subsurface soil chemical concentrations, both of which will be assessed. Therefore, quantitative risk assessment will not be performed using surface water results.

As can be seen from Tables 4-22 and 4-5, concentrations of chemicals in sediment were not very different from reported background concentrations (low-level PAHs, trace VOCs, low-level metals). Sediment is also less likely to be an exposure source for onsite personnel than surface soil, and fugitive dust is not applicable for this sediment. The risks associated with sediment relative to surface soil and other media are expected to be negligible. Therefore, a list of COCS was not generated and quantitative risk assessment was not performed using sediment results.

#### 6.3.2 Exposure Estimates

The estimation methods and models used in this section are consistent with current EPA risk assessment guidance (USEPA, December 1989; USEPA, March 25, 1991). Exposure estimates associated with each exposure route are presented below. All



exposure scenarios incorporate the representative contaminant concentrations in the estimation of intakes.

Noncarcinogenic risks are estimated using the concept of an average annual exposure. The intake incorporates terms describing the exposure time and/or frequency that represents the number of hours per day and the number of days per year that exposure occurs. This is used with a term known as the averaging time, which converts the daily exposure frequency and duration to an annual exposure by dividing by 365 days per year of exposure. Noncarcinogenic risks for some exposure routes (e.g., soil contact, when applicable) are generally greater for children than for adults because of the much lower body weights of children and their similar or higher ingestion rates.

Carcinogenic risks, on the other hand, are calculated as an incremental lifetime risk and, therefore, incorporate terms to represent the exposure duration (years) over the course of a lifetime (70 years, or 25,550 days). The approach used in this assessment is consistent with current EPA policy as outlined in "Standard Default Exposure Factors" (i.e., cancer risks are calculated for adult receptors since they are lifetime probability estimates). The only exception to this practice is for the residential soil/dust ingestion pathway, which is prorated for age-specific factors. However, given current access restrictions and anticipated future land use, an industrial/commercial soil exposure scenario was considered.

#### 6.3.2.1 Groundwater Exposure

Three potential exposure routes are associated with potential current and future groundwater use at the Bethpage Activity. These exposure routes include ingestion, inhalation of volatiles emitted during showering, and dermal contact. The methods used to assess these routes of exposure are discussed in the following text.

Ingestional exposures are characterized using the following expression (USEPA, December 1989):

$$IEX = (C \times IR \times EF \times ED) / (BW \times AT)$$

where: IEX = ingestional exposure dose (mg/kg/day)  
C = groundwater exposure concentration (mg/L)  
IR = ingestion rate (L/day)  
EF = exposure frequency (days/year)  
ED = exposure duration (years)  
BW = body weight (kg)  
AT = averaging time (days)

Under the residential use scenario, the following input parameters are used to estimate intakes. Adult residents are assumed to ingest 2 liters of water per day, 350 days per year, over 30 years

(USEPA, December 1989; USEPA, March 25, 1991). Child residents are assumed to ingest 1 liter of water per day, 350 days per year. Under the work place scenario, adult employees are assumed to ingest 1 liter of water per day, 250 days per year, for 25 years. Body weights are specified as 70 kg for adults and 15 kg for children. Input parameters and assumptions are listed in Tables 6-12 and 6-13. A sample calculation can be seen in Appendix I.7.

Dermal exposure during bathing (children) or showering (adults) is estimated as follows (USEPA, December 1989):

$$DEX = (C \times SA \times PC \times ET \times EF \times ED) / (BW \times AT \times CF)$$

where: DEX = dermal exposure dose (mg/kg/day)  
C = groundwater exposure concentration (mg/L)  
SA = skin surface area available for contact (cm<sup>2</sup>)  
PC = dermal permeability constant of water (cm/hr)  
ET = exposure time  
EF = exposure frequency (days/year)  
ED = exposure duration (years)  
BW = body weight (kg)  
AT = averaging time (days)  
CF = conversion factor (cm<sup>3</sup>/L: 1000)

This approach is based on the assumption that groundwater contaminants are present in dilute solution and that percutaneous absorption is controlled by the flux of water. The permeability constant of water is assumed to be 0.0008 cm/hour (USEPA, April 1988). Skin surface area available for contact is specified as 19400 cm<sup>2</sup> for adults and 7280 cm<sup>2</sup> for small children (USEPA, December 1989), assuming whole body contact. The exposure time is set at 0.2 hours/day, and the exposure frequency is set at 350 days/year. Exposure duration is set at 30 years for adults and 6 years for children. Input parameters and assumptions are listed in Table 6-14. A sample calculation is provided in Appendix I.5.

Inhalational exposures during showering were estimated using a mass transfer model developed for this exposure route, in combination with an intake estimation model. The mass transfer model accounts for inhalation that occurs during a shower, as well as after the shower while the receptor remains in the bathroom. The method employed is as follows (USEPA, December 1989; Foster and Chrostowski, 1987):

TABLE 6-12

EXPOSURE INPUT PARAMETERS - GROUNDWATER INGESTION  
(ASSUMING RESIDENTIAL USE)  
NWIRP, BETHPAGE, NY

Ingestion of Groundwater (Residents)			
Input Parameter	Description	Value	Rationale
C	Exposure concentration	UCL <sup>(1)</sup> (mg/kg) (wells in plume) or maximum	Upper 95% confidence limit on arithmetic average (USEPA, December 1989)
IR	Ingestion rate	Adult: 2 L/day Child: 1 L/day	Convention (USEPA, December 1989)
EF	Exposure frequency	350 days/year	Convention (USEPA, December, 1989)
ED	Exposure duration	Adult: 30 years Child: 6 years	90th percentile time at one residence (USEPA, December 1989)
BW	Body weight	Adult: 70 kg Child: 15 kg	Convention (USEPA, December 1989; USEPA, March 25, 1991)
AT	Averaging time	ED x 365 day/yr 70 years x 365 days/yr	Noncarcinogens Carcinogens (USEPA, December 1989)

(1) Upper 95% confidence limit (UCL) on arithmetic average, or maximum if UCL exceeds maximum detected.

TABLE 6-13

EXPOSURE INPUT PARAMETERS - GROUNDWATER INGESTION  
 (NONRESIDENTIAL SCENARIOS)  
 MWIRP, BETHPAGE, NY

Ingestion of Groundwater (Adult employees)			
Input Parameter	Description	Value	Rationale
C	Exposure concentration	UCL <sup>(1)</sup> (mg/kg)	Upper 95% confidence limit on arithmetic average (USEPA, December 1989)
IR	Ingestion rate	1 L/day	USEPA, December 1989
EF	Exposure frequency	250 days/year	USEPA, March 25, 1991
ED	Exposure duration	25 years	USEPA, March 25, 1991
BW	Body weight	70 kg	Convention (USEPA, December 1989)
AT	Averaging time	ED x 365 days/yr 70 years x 365 days/yr	Noncarcinogens Carcinogens (USEPA, December 1989)

(1) Upper 95% confidence limit (UCL) on arithmetic average, or maximum if UCL exceeds maximum detected.

TABLE 6-14

EXPOSURE INPUT PARAMETERS - GROUNDWATER DERMAL CONTACT  
(ASSUMING RESIDENTIAL USE)  
MWTRP, BETHPAGE, NY

Dermal Contact with Groundwater			
Input Parameter	Description	Value	Rationale
C	Exposure concentration	UCL <sup>(1)</sup> (mg/kg) (wells in plume) or maximum	Upper 95% confidence limit on arithmetic average (USEPA, December 1989)
SA	Skin surface area available for contact	Adult: 19,400 cm <sup>2</sup> /day Child: 7,280 cm <sup>2</sup> /day	50 percentile (USEPA, December 1989)
PC	Dermal permeability constant	0.0008 cm/hr	Assumes contaminants are in dissolved phase and flux controlled by permeation of water (USEPA, April 1988).
ET	Exposure time	0.2 hr/day	12 minutes/day (USEPA, December 1989).
EF	Exposure frequency	350 days/yr	Shower/bath every day (USEPA, March 25, 1991)
ED	Exposure duration	Adult: 30 years Child: 6 years	USEPA, March 25, 1991
BW	Body weight	Adult: 70 kg Child: 15 kg	Convention (USEPA, December, 1989; March 25, 1991)
AT	Averaging time	ED x 365 dys/yr 70 years x 365 days/yr	Noncarcinogens Carcinogens (USEPA, December 1989)

(1) Upper 95% confidence limit (UCL) on arithmetic average, or maximum if UCL exceeds maximum detected.

$$IEX = (S \times IR \times K \times EF \times ED) / (BW \times AT \times Ra \times CF)$$

$$K = Ds + \exp(-Ra \times Dt) / Ra - \text{EXP}[Ra(Ds - Dt)] / Ra$$

where: IEX = inhalational exposure dose (mg/kg/day)  
 S = volatile chemical generation rate (ug/m<sup>3</sup>/min)  
 IR = inhalation rate (L/min)  
 K = mass transfer coefficient  
 EF = exposure frequency (1/days)  
 ED = exposure duration (years)  
 BW = body weight (kg)  
 AT = averaging time or period of exposure (days)  
 Ra = air exchange rate (1/min)  
 CF = conversion factor (ug/mg/L/m<sup>3</sup>: 1000000)  
 Ds = shower duration (min)  
 Dt = total time in bathroom (min)

The volatile chemical generation rate was estimated using the Foster and Chrostowski mass transfer model, which is based on two-phase film theory. The model employs contaminant-specific mass transfer coefficients, Henry's law constants, droplet drop time, viscosity, temperature, etc. Specific details regarding the application of the mass transfer model are included in Appendix I.6.

It is assumed that small children do not take showers and, therefore, are not exposed in this manner.

The inhalation rate was specified as 10.4 L/min for a 70-kg adult. The exposure frequency was specified as 0.96 showers/day (i.e., one shower per day for 350 days), and the exposure duration was specified as 30 years over a 70-year lifetime. The air exchange rate was specified as 0.0083/min, the shower duration as 12 minutes, and the total time in the bathroom as 20 minutes.

Table 6-15 presents a summary of the input parameters for the groundwater exposure route described above.

#### 6.3.2.2 Soil Exposure

It is assumed that current and future soil exposure will occur to adult workers, on the hands and arms mostly, for about 30 days/year. The following equation is used to calculate dermal exposure to soil (USEPA, December 1989):

TABLE 6-15

**EXPOSURE INPUT PARAMETERS - GROUNDWATER INHALATION  
(ASSUMING RESIDENTIAL USE)  
MWIRP, BETHPAGE, NY**

Inhalation of Volatile Emissions During Showering (Adults only)			
Input Parameter	Description	Value	Rationale
C	Exposure Concentration	UCL <sup>(1)</sup> (mg/kg)	Used to calculate volatile chemical generation rate (ug/m <sup>3</sup> /min)
H	Henry's law constant	Contaminant-specific	Required for model application
K <sub>G</sub> K <sub>L</sub>	Gas and liquid phase mass transfer coefficients	Contaminant-specific	Required for model application
D <sub>S</sub>	Shower duration	12 minutes	Required for model application
D <sub>T</sub>	Total time in bathroom	20 minutes	Professional judgment
R <sub>a</sub>	Air exchange rate	0.0083 min <sup>-1</sup>	Foster and Chrostowski, 1987
IR	Inhalation rate	10.4 L/min	USEPA, December 1989
EF	Exposure frequency	0.96 day <sup>-1</sup>	One shower per day, 350 days/yr (USEPA, March 25, 1991)
ED	Exposure duration	30 years	90th percentile time at one residence (USEPA, December 1989)
BW	Body weight	70 kg	Convention (USEPA, December 1989)
AT	Averaging time	ED x 365 dys/yr 70 years x 365 days/yr	Noncarcinogens Carcinogens (USEPA, December 1989)

<sup>(1)</sup>Upper 95% confidence limit (UCL) on arithmetic average, or maximum if UCL exceeds maximum detected.

$$\text{DEX} = (\text{C} \times \text{SA} \times \text{AF} \times \text{ABS} \times \text{EF} \times \text{ED} \times \text{CF}) / (\text{BW} \times \text{AT})$$

where: DEX = dermal exposure dose (mg/kg/day)  
 C = exposure concentration (mg/kg)  
 SA = skin surface area available for contact (cm<sup>2</sup>/day)  
 AF = soil-to-skin adherence factor (mg/cm<sup>2</sup>)  
 ABS = absorption factor  
 EF = exposure frequency (days/year)  
 ED = exposure duration (years)  
 CF = conversion factor (kg/mg: 0.000001)  
 BW = body weight (kg)  
 AT = averaging time (days)

Dermal contact with soil could occur over a skin area of 2950 cm<sup>2</sup>, which is the average area of the forearms and hands of a typical 70-kg adult (USEPA, May 1989). Exposure frequencies, duration, and body weight are the same as for other adult employee scenarios. Potting soil adheres to the skin at a rate of 1.45 mg/cm<sup>2</sup>, and the absorption factor (ABS) (provided in Table 6-16) of various classes of chemicals was estimated as follows:

VOCs = 0.1  
 BNA, pesticide = 0.05  
 PCBs = 0.03  
 Inorganics = 0

The input parameters for this exposure route are presented in Table 6-16. A sample calculation is provided in Appendix I.8. Soil ingestion for this same scenario (adult employees) is calculated from the following equation:

$$\text{IEX} = (\text{C} \times \text{IR} \times \text{Fi} \times \text{EF} \times \text{ED}) / (\text{BW} \times \text{LT} \times \text{AT} \times \text{CF})$$

where: IEX = ingestion exposure (mg/kg/day)  
 C = chemical concentration in soil (mg/kg)  
 IR = soil ingestion rate (mg/day)  
 Fi = fraction from contaminated source  
 EF = exposure frequency (days/year)  
 ED = exposure duration (years)  
 BW = body weight (kg)  
 LT = lifetime (years)  
 AT = averaging time (days/year: 365)  
 CF = conversion factor (mg/kg: 1000000)

The soil ingestion rate for adult employees is assumed to be 50 mg/day. The fraction ingested from the contaminated source is assumed to be 0.1, based on anticipated activity patterns. Other parameters are the same as for the other adult employee scenarios. The inputs are presented in Table 6-17. A sample calculation is provided in Appendix I.9.



TABLE 6-16

EXPOSURE INPUT PARAMETERS - SOIL EXPOSURE, DERMAL  
MWIRP, BETHPAGE, NY

Dermal Contact with Soil (Adult Employees)			
Input Parameter	Description	Value	Rationale
C	Exposure concentration	UCL <sup>(1)</sup> (mg/kg)	Upper 95% confidence limit on arithmetic mean in soil
SA	Skin surface area available for contact	2950 cm <sup>2</sup> /day	Average area of forearms and hands of adult
AF	Soil-to-skin adherence factor	1.45 mg/cm <sup>2</sup>	Default value for commercial potting soil (USEPA, December 1989)
ABS	absorption factor	Volatiles: 0.10 Semivolatiles/Pesticides: 0.05 Metals: 0.0 PCBs: 0.03	Accounts for desorption from soil and percutaneous absorption (Feldman and Maibach, 1970; Wester and Maibach, 1985; USEPA, October 1984)
EF	Exposure frequency	30 days/yr <sup>(2)</sup>	Professional judgment based on current and projected land use and observed activity patterns.
ED	Exposure duration	25 years	Naval personnel or civilian contractors; professional judgment
BW	Body weight	70 kg	Convention (USEPA, December 1989)
AT	Averaging time	ED x 365 days/yr 70 years x 365 days/yr	Noncarcinogens Carcinogens (USEPA, December 1989)

(1) Upper 95% confidence limit (UCL) on arithmetic average, or maximum if UCL exceeds maximum detected.

(2) An exposure frequency of 30 days/year for these sites, although less than the 250 days/year specified in the Standard Default Exposure Factors (SDEF) developed by the EPA, is probably still a gross overestimate for base personnel.

TABLE 6-17

EXPOSURE INPUT PARAMETERS - SOIL INGESTION  
 MWIRP, BETHPAGE, NY

Incidental Ingestion of Soil (Adult Employees)			
Input Parameter	Description	Value	Rationale
C	Exposure concentration	UCL <sup>(1)</sup> (mg/kg)	Upper 95% confidence limit on arithmetic average (USEPA, December 1989)
IR	Ingestion rate	50 mg/day	Ingestion for workplace exposure
FI	Fraction Ingested from contaminated source	0.1	Professional judgement based on current and projected future land use and observed activity patterns.
EF	Exposure frequency	30 days/yr	Professional judgement based on current and projected future land use and observed activity patterns.
ED	Exposure duration	25 years	Naval personnel or civilian contractors; professional judgment
BW	Body weight	70 kg	Convention (USEPA, December 1989)
AT	Averaging time	ED x 365 days/yr 70 years x 365 days/yr	Noncarcinogens Carcinogens (USEPA, December 1989)

(1) Upper 95% confidence limit (UCL) on arithmetic average, or maximum if UCL exceeds maximum detected.

Fugitive dust emissions to nearby residents and subsequent inhalation under the current and future scenarios is a potential route of exposure. The following equation is used to calculate such exposure (Cowherd et al, 1984; EPA, December 1989):

$$IEX = (X \text{ IR} \times \text{ET} \times \text{EF} \times \text{ED}) / (\text{BW} \times \text{LT} \times \text{AT})$$

where: X = downwind air concentration (mg/m<sup>3</sup>)  
IR = inhalation rate (m<sup>3</sup>/hour)  
ET = exposure time (hr/day)  
EF = exposure frequency (days/yr)  
ED = exposure duration (years)  
BW = body weight (kg)  
LT = lifetime (years)  
AT = averaging time (days/year: 365)

The inhalation rate is assumed to be 0.63 m<sup>3</sup>/hr for children and 0.83 m<sup>3</sup>/hr for adults. Other parameters are the same for adult and child residents as in previous residential scenarios. The input parameters are presented in Table 6-18. A sample calculation is presented in Appendix I.1.

#### 6.4 Risk Characterization

Potential human health risks resulting from the exposures outlined in the preceding sections are characterized on a quantitative and qualitative basis in this section. Quantitative risk estimates are generated based on risk assessment methods outlined in current EPA guidance (USEPA, December 1989); whereas the qualitative assessment consists of a comparison of measured concentrations to standards or guidelines.

Noncarcinogenic risk estimates are presented in the form of Hazard Quotients and Hazard Indices that are determined through comparison of estimated intakes with published Reference Doses. Incremental cancer risk estimates are provided in the form of dimensionless probabilities based on Cancer Slope Factors.

Estimated human intakes were developed for each of the specific exposure routes discussed in the preceding sections. Both carcinogenic and noncarcinogenic risks are summarized for each exposure route on a series of tables in this section. Detailed calculations are provided in Appendix I.

Noncarcinogenic risk is assessed using the concept of Hazard Quotients and Hazard Indices. The Hazard Quotient is the ratio of the estimated intake and the Reference Dose (RfD) for a selected chemical of concern, as follows:

$$\text{Hazard Quotient} = \text{Intake/RfD}$$

TABLE 6-18  
EXPOSURE INPUT PARAMETERS - SOIL DUST  
MWIRP, BETHPAGE, NY

Fugitive Dust Emissions (Adult and Child Residents)			
Input Parameter	Description	Value	Rationale
C	Exposure concentration	UCL <sup>(1)</sup> (ng/kg)	Upper 95% confidence limit on arithmetic average (USEPA, December 1989)
F	Disturbance frequency	20 events/month	Professional judgment
V	Vegetative cover factor	Site 1: 0.2 Site 2: 0.2 Site 3: 0.75	Estimate from site visit
A	Source surface area	Site 1: 15000m <sup>2</sup> Site 2: 8000m <sup>2</sup> Site 3: 22000m <sup>2</sup>	Estimate from site visit
IR	Inhalation rate	Adult: 0.83 m <sup>3</sup> /hr Child: 0.63 m <sup>3</sup> /hr	USEPA, December 1989
EF	Exposure frequency	350 days/yr	Convention (USEPA, December 1989; USEPA, March 25, 1991)
ET	Exposure time	24 hrs/day	
BW	Body weight	Adult: 70kg Child: 15kg	Convention (USEPA, December 1989; USEPA, March 25, 1991)
ED	Exposure duration	30 years	90th percentile time at one residence (USEPA, December 1989)
LT	Lifetime	70 years	Convention
AF	Absorption fraction	GI tract: 0.625 Respiratory tract: 0.125	Cowherd et al, 1984
U+	Fastest wind speed	22.5 m/sec.	Cowherd et al, 1984 Table 4-1 (for New York, NY)
PE	Thornwaite's precipitation/evaporation index	139	Cowherd et al, 1984 Figure 4-2
PR	Regional climate factor	0.296	Cowherd et al, 1984 Figure 4-5, 4-7 (Region 7)
Fi	Unscaled concentration from erosion rate	Sites 1, 2: 3.837 ug/g/m <sup>3</sup> /sec Site 3: 1.735	Cowherd et al, 1984 Appendix D for Region 7, 100 mx 100m, wind to southeast at 200 m; site 3, 300m east
U * t	Threshold friction velocity	0.6m/s	Cowherd et al, 1984 Figure 3-4 Median particle size 0.8mm
Z <sub>0</sub>	Roughness height	10cm	Cowherd et al, 1984 Figure 3-6, for suburban residential to institutional

(1) Upper 95% confidence limit (UCL) on arithmetic average, or maximum if UCL exceeds maximum detected.

A Hazard Index is generated by summing the individual Hazard Quotients for the chemicals of concern. If the value of the Hazard Index exceeds unity (1.0), the potential for noncarcinogenic health risk associated with exposure to that particular chemical mixture cannot be ruled out (USEPA, September 24, 1986). In such a case, particular attention should be paid to the target organs affected by each chemical. The Hazard Index is not a mathematical prediction of the severity of toxic effects; it is simply a numerical indicator of the possibility of the occurrence of noncarcinogenic (threshold) effects. If the ratio of the intake and the RfD for any individual chemical exceeds unity, toxic effects could occur.

Incremental cancer risk estimates are generated for each of the exposure pathways using the estimated intakes and published Cancer Slope Factors (CSFs), as follows:

$$\text{Risk} = \text{Intake} \times \text{CSF}$$

If the above equation results in a risk greater than 0.01, the following equation is used:

$$\text{Risk} = 1 - [\exp(\text{Intake} \times \text{CSF})]$$

The risk determined using these equations is a unitless expression of an individual's likelihood of developing cancer as a result of exposure to carcinogenic chemicals. An incremental cancer risk of 1E-6 indicates that the exposed receptor has a one in a million chance of developing cancer under the defined exposure scenario. Alternatively, such a risk may be interpreted as representing one additional case of cancer in an exposed population of one million persons. The calculated cancer risks should be recognized as upper-limit estimates. CSFs are the upper 95 percent confidence limit of a dose-response curve generally derived from animal studies. Actual human risk, while not identifiable, is not expected to exceed the upper limit based on the CSFs, and may, in fact, be lower.

EPA has generally defined risks in the range of 1E-4 to 1E-6 as being acceptable for most hazardous waste facilities addressed under CERCLA. For CERCLA activities, residual risks on the order of 1E-6 are the primary goal, but are often modified by such regulatory requirements as MCLs or chemical-specific cleanup goals.

Carcinogenic and noncarcinogenic health risks are estimated using a number of different assumptions; therefore, the values presented in this section contain an inherent amount of uncertainty. The extent to which health risks can be characterized is primarily dependent upon the accuracy with which the toxicity of a chemical can be estimated and the accuracy of the exposure scenario assumptions. The toxicologic data that form the basis for all risk assessments contain uncertainty in the following areas:

- The extrapolation of nonthreshold (carcinogenic) effects from the high doses administered to laboratory animals to the low doses received under more common human exposure scenarios.
- The extrapolation of the results of laboratory animal studies to human or environmental receptors.
- The interspecies variation in toxicological endpoints used in characterizing potential health effects resulting from exposure to a chemical.
- The variations in sensitivity among individuals of any particular species.

In addition to these sources of uncertainty, the exposure estimates presented in Section 6.3 are also based on a number of simplifying assumptions. The assumptions made include the following:

- Receptor characteristics, such as age, body weight, and exposure duration, are based on published values.
- Land use and activity patterns in the area are limited to the observations made during the field investigation and known land uses in the surrounding area.
- There are no antagonistic or synergistic effects between the chemicals of concern.

The chemical-analytical data base also has some limitations in such areas as sample number and location, and the validity and representativeness of the laboratory results. However, every effort was made to collect samples that reflect actual site conditions.

The following section includes summaries of risks estimated by the exposure models. Complete descriptions and calculation results are presented for the models in Appendix I. Sample calculations are shown in Appendix I.

It should be noted that where Hazard Quotients are reported to be zero in the Section 6.0 tables, the HQs were actually not calculable because no RfD has been established. This is an additional source of uncertainty in the risk assessment. Cancer risks of zero generally indicate that the chemical is not carcinogenic or that a Cancer Slope Factor has not yet been developed.

#### 6.4.1 Potential Current Groundwater Exposure

As discussed in Section 6.1.2.4, exposures were estimated for potential use of [shallow] groundwater. The chemical-specific Hazard Quotients for current potential exposure to groundwater are presented in Table 6-19. The total Hazard Indices for adult employees, adult residents, and child residents via ingestion/dermal exposure all exceeded 1.0. For inhalation exposure, estimated for adult residents, the Hazard Index is less than 1.0. Thus, indicating that adverse noncarcinogenic health effects would not be expected for the inhalation pathway under these conditions.

For adult employees consuming groundwater, the only groundwater constituent that has a Hazard Quotient greater than 1.0 is cadmium. Other significant contributors to the total risk are PCE, 1,2-DCE, cyanide, arsenic, and lead. For potential exposure to adult residents, Hqs for PCE, 1,2-DCE, and cadmium all exceeded 1.0.

Consequently, these substances could pose a significant risk in and of themselves. For potential child residents, Hazard Quotients for 1,1,1-TCA, PCE, 1,2-DCE, lead, vanadium, and cyanide all exceeded 1.0.

When Hazard Indices exceed 1.0, consideration of the chemicals' effects on different target organs may be warranted. However, with Hazard Quotients of several individual chemicals exceeding 1.0, separation of the chemicals by target organ systems would not present a very different picture of estimated risk. The risks due to metals may be overestimated, as discussed previously, due to use of the unfiltered groundwater data. However, several VOCs, all of which have similar toxicological effects (dermal, nervous system, and liver toxicity), also have Hazard Quotients exceeding 1.0. When Hazard Quotients exceed 1.0, the potential for adverse effects cannot be ruled out.

Estimated incremental cancer risks associated with potential groundwater exposure for adult employees and residents are shown in Table 6-20. The estimated risks for adult employees would be approximately  $8E-4$ ; estimated risks for residents would be approximately  $3E-3$  via ingestion/dermal exposure and  $9E-4$  via inhalation. TCE is the major contributor to these risks, although significant contributions were also made by PCE, 1,1-DCE, and arsenic (all with individual estimated risks exceeding or approaching  $1E-4$ ).

TABLE 6-19

HAZARD INDICES - EXPOSURE TO CURRENT GROUNDWATER CONCENTRATIONS  
NWTRP, BETHPAGE, NY

Chemical	Hazard Index					
	Adult Employee Ing.	Adult Resident Ing./Derm		Adult Resident Inh.	Child Resident Ing./Derm	
		Ingestion	Dermal		Ingestion	Dermal
Toluene	5.5e-4	1.5e-3	2.4e-6	1.659e-4	3.6e-3	4.3e-6
Ethylbenzene	2.5e-4	7.1e-4	1.1e-6	7.116e-5	1.7e-3	1.9e-6
Xylenes	2.9e-5	8e-5	1.3e-7	5.396e-4	1.9e-4	2.2e-7
1,1,1-Trichloroethane	2.3e-1	6.4e-1	1e-3	5.419e-2	1.6	1.8e-3
1,1-Dichloroethane	1.8e-2	5.1e-2	8e-5	1.561e-2	1.2e-1	1.4e-4
Tetrachloroethene	7.7e-1	2.2	3.3e-3	0	5.0	5.9e-3
Trichloroethene	0	0	0	0	0	0
1,1-Dichloroethene	6.0e-2	1.7e-1	2.6e-4	0	3.9e-1	4.6e-4
1,2-Dichloroethene, trans	3.8e-1	1.1	1.6e-3	0	2.5	2.9e-3
Carbon tetrachloride	5.1e-2	1.4e-1	2.3e-4	0	3.4e-1	4e-4
bis(2-ethylhexyl)phthalate	1.1e-2	3e-2	4.5e-5	0	7e-2	8e-5
Di-n-octyl phthalate	3.7e-3	1.1e-2	1.7e-5	0	2.4e-2	2.9e-5
Benzo[b]fluoranthene	0	0	0	0	0	0
Fluoranthene	5.0e-4	1.4e-3	2.1e-6	0	3.2e-3	3.7e-6
Naphthalene	7.2e-3	2.1e-2	3.2e-5	0	4.8e-2	5.5e-5 2
Pyrene	6.7e-4	1.8e-3	2.8e-6	0	4.3e-3	5e-6
2-Methylphenol	4.0e-4	1.1e-3	1.7e-6	0	2.6e-3	3e-6
4-Methylphenol	4.0e-4	1.1e-3	1.7e-6	0	2.6e-3	3e-6
2,4-Dimethylphenol	2.8e-3	7.5e-3	1.2e-5	0	1.8e-2	2.1e-5
Arsenic	1.1e-1	3.2e-1	5e-4	0	7.5e-1	8.7e-4
Beryllium	2.6e-3	7.2e-3	1.1e-5	0	1.7e-2	1.9e-5
Cadmium	1.6e-4	4.6	7e-3	0	1.1e+1	1.2e-2
Chromium (III)	7.0e-4	1.9e-3	3e-6	0	4.6e-3	5.3e-6
Chromium (VI)	4.2e-2	1.2e-1	1.8e-4	0	2.6e-1	3.2e-4
Lead	2.6e-1	7.1e-1	1.1e-3	0	1.6	1.9e-3
Manganese	3.9e-2	1.1e-1	1.7e-4	0	2.6e-1	3e-4
Nickel	1.0e-2	2.8e-2	4.3e-5	0	6.5e-1	7.5e-4
Thallium	1.4e-1	3.9e-1	6e-4	0	9.1e-1	1.1e-3
Vanadium	2.3e-1	6.1e-1	9.7e-4	0	1.4	1.7e-3
Cyanide	2.8e-1	8e-1	1.2e-6	0	1.8	2.2e-3
<b>Total Hazard Index</b>	4.2927e0	1.2e+1	1.7e-2	7.058e-2	2.8e+1	3.3e-2

ING = INGESTION  
DERM = DERMAL  
INH = INHALATION



TABLE 6-20

**CARCINOGENIC RISKS - EXPOSURE TO CURRENT GROUNDWATER CONCENTRATIONS  
NWIRP, BETHPAGE, NY**

Chemical	Estimated Cancer Risk			
	Adult Employee Risk Cancer Ing.	Adult Resident Risk		Adult Resident Risk Cancer Inh.
		Ing.	Dermal	
Toluene	0	0	0	0
Ethylbenzene	0	0	0	0
Xylenes	0	0	0	0
1,1,1-Trichloroethane	0	0	0	0
1,1-Dichloroethane	0	0	0	0
Tetrachloroethene	1.4e-4	4.8e-4	7.2e-7	4.269e-6
Trichloroethene	4.7e-4	1.6e-3	2.5e-6	6.827e-4
1,1-Dichloroethene	1.2e-4	3.9e-4	5.9e-7	2.454e-4
1,2-Dichloroethene, trans	0	0	0	0
Carbon tetrachloride	1.7e-6	5.6e-6	8.9e-9	1.498e-6
bis(2-ethylhexyl)phthalate	1.1e-6	3.5e-6	5.5e-9	0
Di-n-octyl phthalate	0	0	0	0
Benzo[b]fluoranthene	1.2e-5	3.8e-5	5.9e-8	2.416e-7
Fluoranthene	0	0	0	0
Naphthalene	0	0	0	0
Pyrene	0	0	0	0
2-Methylphenol	0	0	0	0
4-Methylphenol	0	0	0	0
2,4-Dimethylphenol	0	0	0	0
Arsenic	6.9e-5	2.4e-4	3.8e-7	0
Beryllium	2.0e-5	6.6e-5	1.0e-7	0
Cadmium	0	0	0	0
Chromium (III)	0	0	0	0
Chromium (VI)	0	0	0	0
Lead	0	0	0	0
Manganese	0	0	0	0
Nickel	0	0	0	0
Thallium	0	0	0	0
Vanadium	0	0	0	0
Cyanide	0	0	0	0
<b>Total Risk</b>	<b>8.3E-4</b>	<b>2.8e-3</b>	<b>4.3e-6</b>	<b>9.341e-4</b>

Ing. = INGESTION  
Derm. = DERMAL  
Inh. = INHALATION

As seen in Section 4.0, certain well results contributed to a major portion of the calculated risks; they were HN-25S, HN-29S, HN-28S, and HN-24I. Comparisons of individual wells to drinking water criteria appear in Section 6.5.

#### 6.4.2 Potential Current Soil Exposure

As discussed in Section 6.1.2.1, current concentrations in surface soil were assessed for direct contact (incidental ingestion/dermal) with adult employees and fugitive dust emissions and inhalation by nearby adult and child residents. The chemical-specific Hazard Quotients are presented in Table 6-21. The relative risks from each of the three sites can be assessed.

For all three sites, all current soil exposure scenarios resulted in Hazard Indices of less than 1.0, indicating that adverse noncarcinogenic health effects are not expected to occur under such conditions. In Site 1, the major contributors to projected employee ingestion/dermal exposure are chromium (ingestion) and chlordane (dermal). Chromium was the major contributor to dust inhalation risk in Site 1 and to soil risks in Sites 2 and 3. This parameter was probably treated conservatively because the chromium was assumed to be the more toxic hexavalent species, whereas some or all of it may actually be trivalent. However, the Hazard for chromium Indices still did not exceed 1.0.

Table 6-22 displays estimated cancer risks for potential exposure to current surface soil via ingestion/dermal contact (employees) and dust inhalation (residents). Adult employee ingestion and adult resident inhalation exposures resulted in estimated cancer risks  $6E-7$  or less at all three sites.

Adult employee dermal risks are estimated at approximately  $4E-6$  for Site 1, and approximately  $2E-6$  for Sites 2 and 3. Aroclor 1248 was a significant contributor to dermal cancer risk at all three sites; benzo[a]pyrene was also significant at Sites 2 and 3. This is due primarily to the relatively high CSFs of these two compounds (7.7 and 11.5 mg/kg/day, respectively) (USEPA, January 1991). The carcinogenic status of PCBs is based on the effects of Aroclor 1260 in rats (USEPA, January 1991).

#### 6.4.3 Projected Groundwater Exposure

As discussed in Section 6.1.2.5, future groundwater concentrations were estimated from current subsurface soil concentrations. Hazard indices for potential groundwater users at Bethpage are presented in Table 6-23. It can be seen that projected groundwater risks are less than current risks.

TABLE 6-21

HAZARD INDICES - CURRENT SURFACE SOIL EXPOSURE  
MWIRP, BETHPAGE, NY

Chemical	Hazard Indices			
	Adult Employee Site 1 In.	Adult Employee Site 1 Derm.	Adult Resident Site 1 Dust Inh.	Child Resident Site 1 Dust In.
Tetrachloroethene	1.609E-8	1.376E-6	4.686E-9	1.66e-8
Trichloroethene	0	0	0	0
bis(2-ethylhexyl)phthalate	5.254e-8	2.248e-6	1.531e-8	5.422e-8
Butyl benzyl phthalate	5.284e-9	2.260e-7	1.539e-9	5.452e-9
Acenaphthene	5.186e-9	2.218e-7	1.511e-9	5.351e-9
Anthracene	1.292e-9	5.525e-8	3.76e-10	1.333e-9
Benzo[a]anthracene	0	0	0	0
Benzo[b]fluoranthene	0	0	0	0
Benzo[k]fluoranthene	0	0	0	0
Benzo[g,h,i]perylene	0	0	0	0
Benzo[a]pyrene	0	0	0	0
Chrysene	0	0	0	0
Dibenzo[a,h]anthracene	0	0	0	0
Fluoranthene	1.228e-7	5.255e-6	3.579e-8	1.268e-7
Fluorene	6.458e-9	2.762e-7	1.881e-9	6.664e-9
Indeno[1,2,3,-cd]pyrene	0	0	0	0
Naphthalene	7.779e-8	3.327e-6	2.266e-8	8.027e-8
Pyrene	1.552e-7	6.683e-6	4.521e-8	1.601e-7
Chlordane	2.348e-5	1.005e-3	6.841e-6	2.423e-5
4,4'-DDT	5.166e-6	2.210e-4	1.505e-6	5.331e-6
Arsenic	1.943e-4	0	5.661e-5	2.005e-4
Barium	5.472e-6	0	1.610e-4	5.703e-4
Chromium (VI)	5.765e-5	0	2.801e-2	9.921e-2
Nickel	4.726e-6	0	1.377e-6	4.877e-6
Silver	6.849e-6	0	1.995e-6	7.068e-6
Vanadium	2.550e-5	0	7.428e-6	2.631e-5
Cyanide	9.393e-7	0	2.737e-7	9.693e-7
Aroclor - 1248	0	0	0	0
Phenanthrene	1.122E-7	0	3.267E-8	1.157E-7
4,4'-DDE	3.170E-6	0	9.236e-7	3.2713-6
<b>Total</b>	<b>3.247E-4</b>	<b>1.245E-3</b>	<b>2.825E-2</b>	<b>1.00e-1</b>

TABLE 6-21  
HAZARD INDICES - CURRENT SURFACE SOIL EXPOSURE  
PAGE TWO

Chemical	Hazard Indices			
	Adult Employee Site 2 In.	Adult Employee Site 2 Derm.	Adult Resident Site 2 Dust Inh.	Child Resident Site 2 Dust Inh.
Toluene	8.22e-11	7.032e-9	1.36e-11	4.83e-11
Trichloroethene	0	0	0	0
Chloroform	5.87e-10	5.023e-8	9.12e-11	3.23e-10
bis(2-ethylhexyl)phthalate	5.519e-8	2.361e-6	8.574e-9	3.037e-8
Butyl benzyl phthalate	1.039e-8	4.445e-7	1.615e-9	5.719e-9
Acenaphthene	2.720e-8	1.164e-6	4.226e-9	1.497e-8
Anthracene	6.145e-9	2.628e-7	9.55e-10	3.282e-9
Benzo[a]anthracene	0	0	0	0
Benzo[b]fluoranthene	0	0	0	0
Benzo[k]fluoranthene	0	0	0	0
Benzo[g,h,i]perylene	0	0	0	0
Benzo[a]pyrene	0	0	0	0
Chrysene	0	0	0	0
Dibenzo[a,h]anthracene	0	0	0	0
Fluoranthene	1.601e-7	6.849e-6	2.488e-8	8.813e-8
Fluorene	3.244e-8	1.387e-6	5.040e-9	1.785e-8
Indeno[1,2,3,-cd]pyrene	0	0	0	0
Naphthalene	2.730e-7	1.168e-5	4.242e-8	1.502e-7
Pyrene	1.595e-7	6.822e-6	2.478e-8	8.778e-8
Arsenic	3.757e-5	0	5.838e-6	2.068e-5
Chromium (VI)	1.503e-4	0	3.894e-2	1.379e-1
Copper	8.982e-6	0	1.396e-6	4.94e-6
Nickel	2.29e-6	0	3.557e-7	1.26e-6
Silver	1.605e-6	0	2.493e-7	8.83e-7
Vanadium	2.701e-5	0	4.196e-6	1.486e-5
Cyanide	4.403e-7	0	6.841e-8	2.423e-7
Aroclor-1248	0	0	0	0
Phenanthrene	2.107E-7	0	3.274E-8	1.16E-7
<b>Total</b>	<b>2.291e-4</b>	<b>3.103e-5</b>	<b>3.896e-2</b>	<b>1.38e-1</b>

TABLE 6-21  
HAZARD INDICES - CURRENT SURFACE SOIL EXPOSURE  
PAGE THREE

Chemical	Hazard Indices			
	Adult Employee Site 3 Ing.	Adult Employee Site 3 Derm.	Adult Resident Site 3 Dust Inh.	Child Resident Site 3 Dust Inh.
Toluene	1.41e-10	1.205e-8	9.07e-12	3.21e-11
Chloroform	5.87e-10	5.023e-8	3.54e-11	1.26e-10
bis(2-ethylhexyl)phthalate	3.81e-7	1.63e-5	2.3e-8	8.149e-8
D-n-butyl phthalate	1.966e-8	8.538e-7	1.205e-9	4.269e-9
Butyl benzyl phthalate	1.491e-8	6.379e-7	9.00e-10	3.189e-9
Dimethyl phthalate	1.115e-9	4.771e-8	6.73e-11	2.39e-10
Acenaphthene	1.566e-8	6.697e-7	9.45e-10	3.348e-9
Anthracene	8.728e-9	3.733e-7	5.27e-10	1.867e-9
Benzo[a]anthracene	0	0	0	0
Benzo[b]fluoranthene	0	0	0	0
Benzo[k]fluoranthene	0	0	0	0
Benzo[g,h,i]perylene	0	0	0	0
Benzo[a]pyrene	0	0	0	0
Chrysene	0	0	0	0
Fluoranthene	1.544e-7	6.605e-6	9.322e-9	3.302e-8
Fluorene	2.642e-8	1.130e-6	1.595e-9	5.650e-9
Indeno[1,2,3,-cd]pyrene	0	0	0	0
Pyrene	2.861e-7	1.224e-5	1.727e-8	6.119e-8
Aroclor-1254	0	0	0	0
Arsenic	1.532e-4	0	9.251e-6	3.277e-5
Barium	8.947e-6	0	5.456e-5	1.933e-4
Beryllium	1.292e-6	0	7.798e-8	2.762e-7
Chromium (VI)	3.029e-4	0	3.050e-2	1.080e-1
Copper	5.871e-5	0	3.545e-6	1.256e-5
Mercury	4.11e-6	0	4.13e-7	1.465e-6
Vanadium	7.540e-5	0	4.552e-6	1.612e-5
Cyanide	6.751e-7	0	4.076e-8	1.444e-7
Aroclor-1248	0	0	0	0
<b>Total</b>	<b>6.062e-4</b>	<b>3.892e-5</b>	<b>3.057e-2</b>	<b>1.083e-1</b>

TABLE 6-22

CARCINOGENIC RISKS - CURRENT SURFACE SOIL EXPOSURE  
 MWIRP, BETHPAGE, NY

Chemical	Estimated Cancer Risk		
	Adult Employee Site 1 Ing.	Adult Employee Site 1 Derm.	Adult Resident Site 1 Dust Inh.
Tetrachloroethene	2.93E-12	2.51E-10	1.03E-12
Trichloroethene	1.71E-13	1.46E-11	7.81E-14
bis(2-ethylhexyl) phthalate	5.25e-12	2.25e-10	1.84e-12
Butyl benzyl phthalate	0	0	0
Acenaphthene	0	0	0
Anthracene	0	0	0
Benzo[a]anthracene	1.535e-9	6.565e-8	5.94e-10
Benzo[b]fluoranthene	1.941e-9	8.303e-8	7.51e-10
Benzo[k]fluoranthene	7.59e-10	3.247e-8	2.94e-10
Benzo[g,h,i]perylene	0	0	0
Benzo[a]pyrene	1.210e-8	5.178e-7	4.681e-9
Chrysene	5.02e-11	2.147e-9	1.94e-11
Dibenzo[a,h]anthracene	4.01e-9	1.171e-7	1.552e-9
Fluoranthene	0	0	0
Fluorene	0	0	0
Indeno[1,2,3,-cd]pyrene	1.952e-9	8.351e-8	7.55-10
Naphthalene	0	0	0
Pyrene	0	0	0
Chlordane	6.54e-10	2.798e-8	2.74e-10
4,4-DDT	3.14e-10	1.342e-8	1.32e-10
Arsenic	0	0	2.426e-7
Barium	0	0	0
Chromium (VI)	0	0	2.951e-7
Nickel	0	0	1.983e-9
Silver	0	0	0
Vanadium	0	0	0
Cyanide	0	0	0
Aroclor - 1248	1.275e-7	3.273e-6	4.459e-8
Phenanthrene	0	0	0
4,4'-DDE	1.92E-10	8.233E-9	1.35E-11
<b>Total</b>	<b>1.509e-7</b>	<b>4.272e-6</b>	<b>5.933E-7</b>

TABLE 6-22  
 CARCINOGENIC RISKS - CURRENT SURFACE SOIL EXPOSURE  
 PAGE TWO

Chemical	Estimated Cancer Risk		
	Adult Employee Site 2 Ing.	Adult Employee Site 2 Derm.	Adult Resident Site 2 Dust Inh.
Toluene	0	0	0
Trichloroethene	5.19e-14	4.44e-12	1.27e-14
Chloroform	1.28E-14	1.09E-12	8.72E-15
bis(2-ethylhexyl) phthalate	5.52e-12	2.36e-10	1.03e-12
Butyl benzyl phthalate	0	0	0
Acenaphthene	0	0	0
Anthracene	0	0	0
Benzo[a]anthracene	1.559e-9	6.670e-8	3.22e-10
Benzo[b]fluoranthene	1.387e-9	5.935e-8	2.86e-10
Benzo[k]fluoranthene	7.23e-10	3.091e-8	1.49e-10
Benzo[g,h,i]perylene	0	0	0
Benzo[a]pyrene	1.116e-8	4.775e-7	2.302e-9
Chrysene	4.59e-11	1.965e-9	9.47e-12
Dibenzo[a,h]anthracene	5.621e-9	2.404e-7	1.159e-9
Fluoranthene	0	0	0
Fluorene	0	0	0
Indeno[1,2,3,-cd]pyrene	1.751e-9	7.490e-8	3.61e-10
Naphthalene	0	0	0
Pyrene	0	0	0
Arsenic	0	0	2.502E-8
Chromium (VI)	0	0	4.103e-7
Copper	0	0	0
Nickel	0	0	5.12E-10
Silver	0	0	0
Vanadium	0	0	0
Cyanide	0	0	0
Aroclor-1248	3.068e-8	7.873e-7	5.719e-9
Phenanthrene	0	0	0
<b>Total</b>	<b>5.293e-8</b>	<b>1.739e-6</b>	<b>4.462E-7</b>

TABLE 6-22  
 CARCINOGENIC RISKS - CURRENT SURFACE SOIL EXPOSURE  
 PAGE THREE

Chemical	Estimated Cancer Risk		
	Adult Employee Site 3 Ing.	Adult Employee Site 3 Derna.	Adult Resident Site 3 Dust Inh.
Toluene	0	0	0
Chloroform	1.28e-14	1.09e-12	3.39e-15
bis(2-ethylhexyl) phthalate	3.81e-11	1.63e-9	2.76e-12
Di-n-butyl phthalate	0	0	0
Butylbenzyl phthalate	0	0	0
Dimethyl phthalate	0	0	0
Acenaphthene	0	0	0
Anthracene	2.224e-9	9.527e-8	1.78e-10
Benzo[a]anthracene	2.417e-9	1.034e-7	1.94e-10
Benzo[b]fluoranthene	1.364e-9	5.834e-8	1.10e-10
Benzo[k]fluoranthene	0	0	0
Benzo[g,h,i]perylene	1.890e-8	8.086e-7	1.515e-9
Benzo[a]pyrene	7.84e-11	3.354e-9	6.28e-12
Chrysene	0	0	0
Fluoranthene	0	0	0
Fluorene	3.245e-9	1.388e-7	2.60e-10
Indeno[1,2,3,-cd]pyrene	0	0	0
Pyrene	8.557e-9	2.196e-7	0
Aroclor-1254	0	0	6.2e-10
Arsenic	0	0	3/965e-8
Barium	9.918e-9	0	0
Beryllium	0	0	9.99e-10
Chromium (VI)	0	0	0
Copper	0	0	0
Mercury	0	0	0
Vanadium	0	0	0
Cyanide	1.340e-8	3.439e-7	9.71e-10
Aroclor-1248			
<b>Total</b>	<b>6.015E-8</b>	<b>1.773e-6</b>	<b>3.659e-7</b>



TABLE 6-23

HAZARD INDICES - FUTURE GROUNDWATER EXPOSURE  
MWIRP, BETHPAGE, NY

Chemical	Hazard Index					
	Adult Employee Ing.	Adult Resident		Adult Resident Inh.	Child Resident	
		Ingestion	Dermal		Ingestion	Dermal
1,1,1-Trichloroethane	2.1e-3	6e-3	9.3e-6	5.078e-4	1.4e-2	1.7e-5
Tetrachloroethene	4.6e-1	1.3	2e-3	0	3	3.5e-3
Trichloroethene	0	0	0	0	0	0
1,2-Dichloroethene, trans	5.5e-3	1.5e-2	2.3e-5	0	3.5e-2	4e-5
Butyl benzyl phthalate	4.9e-6	1.3e-5	2.1e-8	0	3.2e-5	3.7e-8
Acenaphthene	5.5e-4	1.5e-3	2.3e-6	0	3.7e-3	4.2e-6
Anthracene	3.3e-5	9e-5	1.4e-7	0	2.1e-4	2.5e-7
Benzo[a]anthracene	0	0	0	0	0	0
Chrysene	0	0	0	0	0	0
Fluoranthene	4.0e-4	1.1e-3	1.7e-6	0	2.5e-3	3e-6
Fluorene	4.5e-4	1.2e-2	1.9e-6	0	2.7e-3	3.2e-6
Naphthalene	1.7e-2	4.5e-2	7e-5	0	1.1e-1	1.3e-4
Pyrene	5.0e-4	1.4e-3	2.1e-6	0	3.2e-3	3.7e-6
Aroclor - 1248	0	0	0	0	0	0
Phenanthrene	1.0e-3	2.8e-3	4.5e-6	0	6.6e-3	7.6e-6
<b>Total</b>	<b>4.9e-1</b>	<b>1.4</b>	<b>2.13e</b>	<b>5.078e-4</b>	<b>3.2</b>	<b>3.7e-3</b>

Hazard Indices are less than 1.0 for projected adult employee exposure and for adult resident inhalation exposure at NWIRP Bethpage. The Hazard Index just exceeded 1.0 (1.38) for adult resident ingestion/dermal exposure and exceeded 1.0 (3.2) for child residents; this was due almost entirely to PCE. Because of significant PCE concentrations in subsurface soil and the great mobility of this compound in the environment, a significant PCE concentration (475 ug/l) was predicted. The PCE Hazard Quotient in itself exceeds 1.0; without it, these pathways would result in a Hazard Index less than 1.0. [This model estimated only the contribution of soil chemicals to groundwater; it did not attempt to sum up current plus future contaminants for a projected total groundwater concentration.]

Estimated carcinogenic risks for potential future groundwater use are summarized in Table 6-24. For adult employee exposure, the estimated total risk was approximately  $2E-4$ ; this was due primarily to PCE and Aroclor 1248. The inhalation risk of approximately  $6E-6$  was primarily due to TCE and PCE. The Aroclor 1248 groundwater concentration may be an overestimation, as PCBs are almost never detected in groundwater.

#### 6.4.4 Projected Soil Exposure

As described in Section 6.1.2.2, future surface soil conditions were estimated using a hypothetical scenario of the uncovering of subsurface soil. Hazard Indices for future soil exposure pathways are presented in Table 6-25.

All of the Hazard Indices for projected soil exposure are less than 1.0; they are also less than current soil noncarcinogenic risks. Although the VOC concentrations were higher in subsurface soil, metals concentrations were much lower. Primary contributors to these risks varied by site, receptor, and pathway, although arsenic in Sites 1 and 2 and manganese in Site 3 were among the major contributors.

Estimated cancer risks for projected soil exposure are presented in Table 6-26. All of the risks are less than  $1E-6$  except adult resident dust inhalation for site 1 ( $9E-6$ ) and adult employee dermal exposure for Site 2 ( $3E-6$ ). These risks are due to arsenic and Aroclor 1248, respectively.

#### 6.4.5 Summary

Hazard Indices calculated for current and future soil exposure are all below 1.0; adverse noncarcinogenic health effects for these pathways are not indicated. Total cancer risks for current soil exposure range from  $5E-8$  to  $4E-6$ , with the highest risk occurring for adult employee dermal exposure. Aroclor 1248 in Sites 1 and 2

TABLE 6-24

CARCINOGENIC RISKS - FUTURE GROUNDWATER EXPOSURE  
MWIRP, BETHPAGE, NY

Chemical	Estimated Cancer Risk			
	Adult Employee Risk Cancer Ing.	Adult Resident Risk Cancer		Adult Resident Risk Cancer Inh.
		Ingestion	Dermal	
1,1,1-Trichloroethane	0	0	0	0
Tetrachloroethene	8.4e-5	2.8e-4	4.43-7	2.575e-6
Trichloroethene	2.310e-6	7.5e-6	1.2e-7	3.340e-6
1,2-Dichloroethene, trans	0	0	0	0
Butyl benzyl phthalate	0	0	0	0
Acenaphthene	0	0	0	0
Anthracene	0	0	0	0
Benzo[a]anthracene	5.9e-6	2e-6	3.1e-9	1.135e-9
Chrysene	3.6e-8	1.2e-7	1.8e-10	7.23e-11
Fluoranthene	0	0	0	0
Fluorene	0	0	0	0
Naphthalene	0	0	0	0
Pyrene	0	0	0	0
Aroclor - 1248	8.8e-5	3e-4	4.6e-7	0
Phenanthrene	0	0	0	0
<b>Total</b>	<b>1.765e-4</b>	<b>5.9e-4</b>	<b>9.1e-7</b>	<b>5.916e-6</b>

TABLE 6-25

HAZARD INDICES - FUTURE SOIL EXPOSURE  
NWIRP, BETHPAGE, NY

Chemical	Hazard Indices			
	Adult Employee Site 1 Ing.	Adult Employee Site 1 Derm.	Adult Resident Site 1 Dust Inh.	Child Resident Site 1 Dust/Inh.
1,1,1-Trichloroethane	9.46e-10	8.092e-8	2.92e-10	1.035e-9
Tetrachloroethene	4.896e-7	4.189e-5	1.426e-7	5.053e-7
Trichloroethene	0	0	0	0
1,2-Dichloroethene, trans	9.10e-10	7.785e-8	2.65e-10	9.39e-10
Di-n-butyl phthalate	9.39e-10	4.018e-8	2.74e-10	9.69e-10
Butyl benzyl phthalate	2.862e-9	1.224e-7	8.34e-10	2.953e-9
Arsenic	7.303e-3	0	2.128e-3	7.536e-3
Cadmium	2.348e-5	0	6.841e-6	2.423e-5
Copper	1.159e-6	0	3.378e-7	1.197e-6
Cyanide	1.761e-6	0	5.131e-7	1.817e-6
<b>Total</b>	<b>7.330e-3</b>	<b>4.221e-5</b>	<b>2.135e-3</b>	<b>7.564e-3</b>

TABLE 6-25  
HAZARD INDICES - FUTURE SOIL EXPOSURE  
PAGE TWO

Chemical	Hazard Indices			
	Adult Employee Site 2 Ingest.	Adult Employee Site 2 Dermal	Adult Resident Site 2 Dust Inh.	Child Resident Site 2 Dust/Inhal.
Tetrachloroethene	2.231e-9	1.909e-7	3.47e-10	1.228e-9
Trichloroethene	0	0	0	0
bis(2-ethylhexyl)phthalate	1.820e-8	7.785e-7	2.828e-9	1.002e-8
Di-n-butyl phthalate	2.384e-9	1.005e-7	3.65e-10	1.292e-9
Acenaphthene	2.084e-8	8.915e-7	3.238e-9	1.147e-8
Anthracene	3.836e-9	1.641e-7	5.96e-10	2.111e-9
Benzo [a] anthracene	0	0	0	0
Benzo [b] fluoranthene	0	0	0	0
Benzo [k] fluoranthene	0	0	0	0
Benzo [g, h, i] perylene	0	0	0	0
Benzo [a] pyrene	0	0	0	0
Chrysene	0	0	0	0
Fluoranthene	1.182e-7	5.054e-6	1.836e-8	6.503e-8
Fluorene	2.642e-8	1.130e-6	4.105e-9	1.454e-8
Indeno [1, 2, 3, -cd] pyrene	0	0	0	0
Naphthalene	1.262e-7	5.399e-6	1.961e-8	6.947e-8
Pyrene	1.487e-7	6.362e-6	2.311e-8	8.185e-8
Arsenic	3.464e-5	0	5.382e-6	1.906e-5
Mercury	3.523e-6	0	9.122e-7	3.231e-6
Silver	2.544e-6	0	3.953e-7	1.400e-6
Aroclor-1248	0	0	0	0
Phenanthrene	1.142e-7	0	1.774e-8	6.284e-8
<b>Total</b>	<b>4.129</b>	<b>2.008e-5</b>	<b>6.780</b>	<b>2.401</b>

TABLE 6-25  
HAZARD INDICES - FUTURE SOIL EXPOSURE  
PAGE THREE

Chemical	Hazard Indices			
	Adult Employee Site 3 Ing.	Adult Resident Site 3 Derm.	Adult Resident Site 3 Dust Inhal.	Child Resident Site 3 Dust Inhal.
Toluene	2.94e-11	2.511e-9	1.89e-12	6.7e-12
Tetrachloroethene	8.150e-9	6.981e-7	4.93e-10	1.745e-9
Trichloroethene	0	0	0	0
1,2-Dichloroethene, trans	8.22e-10	7.032e-8	4.96e-11	1.76e-10
bis(2-ethylhexyl)phthalate	4.110e-8	1.758e-6	2.481e-9	8.789e-9
Butyl benzyl phthalate	1.204e-9	5.148e-8	7.27e-11	2.57e-10
Benzo[b]fluoranthene	0	0	0	0
Benzo[k]fluoranthene	0	0	0	0
Benzo[g,h,i]perylene	0	0	0	0
Benzo[a]pyrene	0	0	0	0
Chrysene	0	0	0	0
Fluoranthene	8.366e-9	3.579e-7	5.05e-10	1.789e-9
Pyrene	1.370e-8	5.860e-7	8.27e-10	2.930e-9
Copper	1.292e-6	0	7.798e-8	2.762e-7
Manganese	1.145e-5	0	1.389e-4	4.921e-4
<b>Total</b>	<b>1.281e-5</b>	<b>3.524e-6</b>	<b>1.39e-4</b>	<b>4.924e-4</b>

Ing. = Ingestion  
Derm. = Dermal  
Inh. = Inhalation

TABLE 6-26

CARCINOGENIC RISKS - FUTURE SOIL EXPOSURE  
 MWIRP, BETHPAGE, NY

Chemical,	Estimated Cancer Risks		
	Adult Employee Site 1 Ing.	Adult Employee Site 1 DERM.	Adult Resident Site 1 Dust Inh.
1,1,1-Trichloroethane	0	0	0
Tetrachloroethene	8.92e-11	7.630e-9	3.14e-11
Trichloroethene	8.42e-13	7.20e-11	3.85e-13
1,2-Dichloroethene, trans	0	0	0
Di-n-butyl phthalate	0	0	0
Butyl benzyl phthalate	0	0	0
Arsenic	0	0	9.18e-6
Cadmium	0	0	1.789e-9
Copper	0	0	0
Cyanide	0	0	0
<b>Total</b>	<b>9.00e-11</b>	<b>7.702e-9</b>	<b>9.120e-6</b>

Chemical	Estimated Cancer Risk		
	Adult Employee Site 2 Ing.	Adult Employee Site 2 DERM.	Adult Resident Site 2 Dust Inh.
Tetrachloroethene	4.06e-13	3.48e-11	7.63e-14
Trichloroethene	3.18e-13	2.72e-11	7.77e-14
bis(2-ethylhexyl)phthalate	1.82e-12	7.78e-11	3.39e-13
Di-n-butyl phthalate	0	0	0
Acenaphthene	0	0	0
Anthracene	0	0	0
Benzo[a]anthracene	1.325e-9	5.668e-8	2.73e-10
Benzo[b]fluoranthene	1.560e-9	6.671e-8	3.22e-10
Benzo[k]fluoranthene	5.87e-10	2.512e-8	1.21e-10
Benzo[g,h,i]perylene	0	0	0
Benzo[a]pyrene	9.573e-9	4.095e-7	1.974e-9
Chrysene	4.71e-11	2.015e-9	9.71e-12
Fluoranthene	0	0	0
Fluorene	0	0	0
Indeno[1,2,3,-cd]pyrene	3.47e-10	1.484e-8	7.15e-11
Naphthalene	0	0	0
Pyrene	0	0	0
Arsenic	0	0	2.306e-8
Mercury	0	0	0
Silver	0	0	0
Aroclor-1248	1.098e-7	2.818e-6	2.047e-8
Phenanthrene	0	0	0
<b>Total</b>	<b>1.232e-7</b>	<b>3.393e-6</b>	<b>4.631e-8</b>

TABLE 6-26  
 CARCINOGENIC RISKS - FUTURE SOIL EXPOSURE  
 PAGE TWO

Chemical	Estimated Cancer Risks		
	Adult Employee Site 3 Ing.	Adult Resident Site 3 Derm.	Adult Resident Site 3 Dust Inhal.
Toluene	0	0	0
Tetrachloroethene	1.49e-12	1.127E-10	1.08e-13
Trichloroethene	6.92e-14	5.92e-12	6.56e-15
1,2-Dichloroethene, trans	0	0	0
bis(2-ethylhexyl)phthalate	4.11e-12	1.76e-10	2.98e-13
Butyl benzyl phthalate	0	0	0
Benzo[b]fluoranthene	1.55e-10	6.642e-9	1.24e-11
Benzo[k]fluoranthene	6.84e-11	2.927e-9	5.48e-12
Benzo[g,h,i]perylene	0	0	0
Benzo[a]pyrene	1.206e-9	5.157e-8	9.66e-11
Chrysene	4.56e-12	1.95e-10	3.66e-13
Fluoranthene	0	0	0
Pyrene	0	0	0
Copper	0	0	0
Manganese	0	0	0
<b>Total</b>	<b>1.440e-9</b>	<b>6.165e-8</b>	<b>1.15e-10</b>

Ing. = Ingestion  
 Derm. = Dermal  
 Inh. = Inhalation



and benzo[a]pyrene in Site 3 were the major factors in these potential dermal cancer risks. Estimated total cancer risks for future soil exposure ranged from  $3E-11$  to  $9E-6$ , with the highest risks occurring for adult resident dust inhalation at Site 1 and employee dermal absorption at Site 2. Arsenic at Site 1 and Aroclor 1248 at Site 2 were primarily responsible for these projected cancer risks.

For potential exposure to current groundwater concentrations, Hazard Indices exceeded 1.0 for all three potential receptors (employee, adult resident, child resident). Individual Hazard Quotients for several chemicals exceeded 1.0, including both metals and VOCs. Estimated total cancer risks ranged from  $8E-4$  to  $3E-3$ , with TCE risks comprising a large portion of the total risk.

For potential exposure to future groundwater concentrations, Hazard Indices exceeded 1.0 for the resident ingestion/dermal pathways. This was due primarily to PCE, whose Hazard Quotient exceeded 1.0. Estimated total cancer risks ranged from  $6E-6$  to  $6E-4$ , with TCE, PCE, and Aroclor 1248 posing the greatest risks.

Based on current risk assessment modeling, groundwater concentrations of VOCs and inorganics are the most significant sources of noncarcinogenic and carcinogenic risk at NWIRP Bethpage. PCBs may pose the greatest cancer risk in surface and subsurface soil, as a result of their high CSF.

#### **6.5 Environmental Assessment**

NWIRP Bethpage is developed, with pavement and buildings covering a large part of the site. No natural aquatic habitats, no Federal or state endangered species, and no critical habitats are reported to exist on site. No discharge to wetlands has been identified.

The urban/suburban neighborhood is reported to have some grass and trees, which may support animals such as rabbits, squirrels, mice, robins, and pigeons. A small population of Canada geese is reported to nest and live near the recharge basins.

There are no applicable criteria for the environmental species that could be affected by onsite contamination. Therefore, this assessment will include a brief discussion of items found in the literature.

Lead poisoning of waterfowl has been reported in the environment, usually resulting from wild birds ingesting lead shot. Gastrointestinal, hepatic, cardiovascular, neurologic, and reproductive symptoms have been reported in pigeons, geese and ducks exposed to lead via this route (NLM, Jan. 23, 1992). The onsite soil does not contain lead in such a concentrated form. An LC50 (concentration lethal to 50 percent of an experimental population) of greater than 5000 parts per million (ppm) was

reported for lead in the diet of Japanese quail (NLM, Jan. 23, 1992). Such concentrations would be expected to be difficult for the onsite geese to attain even if they were ingesting large quantities of surface soil. Since surface soil lead results have been rejected, no conclusions can be made regarding lead exposure to geese via this route. Lead results in recharge sediment were fairly low (up to 23.3 mg/Kg).

Arsenic poisoning in fowl is reported to produce effects such as inflammation of the gizzard and degenerative changes in the liver (NLM, Jan. 23, 1992).

A study of metals effects on earthworms found that cadmium was the most toxic metal tested, followed by nickel, copper, zinc, and lead, in that order. The only metal consistently accumulated was cadmium (NLM, Jan. 23, 1992). At this site, cadmium was not considered to be a major contaminant of subsurface soil, although cadmium, nickel, and copper were selected as chemicals of concern in either surface or subsurface soil.

Aroclor 1248 has been reported to be toxic to several species of birds (quail, pheasant, mallard), with LC50s above 1000 ppm in the diet (NLM, Jan. 23, 1992). Reduced egg production was reported for hens fed 20 ppm Aroclor 1248 in the diet for several weeks (NLM, Jan. 23, 1991). Such concentrations would be extremely difficult for birds to ingest from onsite soil. Bioconcentration is a phenomenon that has been reported for PCBs in the environment, but animal tissue analysis is the best way to determine whether PCBs have become a significant factor in the food chain. Liver toxicity has been reported in many species of animals, including rodents, exposed to PCBs.

From the very limited information available, significant environmental problems are not necessarily indicated. Although some of the contaminants detected on site can affect environmental species under certain conditions, most studies to date have focused on high laboratory concentrations as opposed to lower environmental concentrations. No definitive conclusions can be drawn.

#### **6.6 Uncertainty Analysis**

There are uncertainties associated with exposure assumptions since not all people weigh 70 kg, not all people drink 2 L of water per day, not all people live at the same residence for 30 years, etc. The rationale for each assumption is provided in Tables 6-11 through 6-17. Receptor characteristics, such as age and body weight, were based on published values. Land use and activity patterns in the area were limited to the observations made during the field investigation and known land uses in the surrounding area. Every attempt was made to use conservative assumptions, except where average values were expected to better correspond to reality (e.g., approximately 1 shower per day).

The chemical-analytical data base has some limitations in such areas as sample number and location and the validity and representativeness of laboratory results. However, every effort was made to collect samples that reflect actual site conditions. The use of representative concentrations is a conservative estimate since it uses the upper 95% confidence limit on the arithmetic mean or the maximum concentration.

The use of current subsurface soil concentrations to represent future surface soil concentrations is a simplification that assumes that no outside pollution would be transported onto the site, and that soil would erode or be excavated evenly to the sampled depth.

Uncertainties associated with the groundwater modeling include the infiltration rate, which can vary from site to site, and the mixing zone.

The chemical-specific parameters such as Koc were either derived from other parameters or measured under conditions that may or may not be representative of on-site conditions. Parameters such as vapor pressure and solubility were not always obtainable at the desired temperature.

The use of unfiltered monitoring well data for the evaluation of groundwater inorganics provides in all probability a gross overestimation of exposure and risk. Comparison with the filtered data reveals how many of the metals may have been attributable to suspended sediment. However, because of the significant concentrations of organics, the inorganics were not the primary contributors to total risk.

There is uncertainty associated with the RfDs and CSFs. The uncertainty results from the extrapolation of animal data to humans, the extrapolation of carcinogenic effects from the laboratory high-dose to the environmental low-dose scenarios, and interspecies and intraspecies variations in toxicological endpoints caused by chemical exposure. The use of EPA CSF values is generally considered to be conservative since CSFs are based on the upper-bound increased lifetime cancer risk. The use of EPA RfD values is considered to be conservative because the doses are based on no-effects or lowest-observed-effects levels and then further reduced with uncertainty factors to increase the margin of safety. The RfDs and CSFs of some chemicals have not been established, and therefore toxicity could not be quantitatively assessed.

From a toxicologist's standpoint, it is not strictly correct to add Hazard Quotients for a total Hazard Index, since RfDs are based on effects to varying target organs. However, if the HI is less than 1.0, this demonstrates that even when this conservative calculation is performed, the noncarcinogenic risk does not indicate a hazard. At this site, for all HIs greater than 1.0, there were individual

HQs that exceeded 1.0. Therefore, the total HI was not artificially elevated above 1.0 by a combination of dissimilar toxicity mechanisms at this site.

These models also assumed that chemicals did not interact synergistically (a possible underestimate) or antagonistically (a possible overestimate). Degradation was not taken into account; this was a conservative approach.

0  
1  
2  
3  
4  
5  
6  
7  
8  
9  
10  
11  
12  
13  
14  
15  
16  
17  
18  
19  
20  
21  
22  
23  
24  
25  
26  
27  
28  
29  
30  
31  
32  
33  
34  
35  
36  
37  
38  
39  
40  
41  
42  
43  
44  
45  
46  
47  
48  
49  
50  
51  
52  
53  
54  
55  
56  
57  
58  
59  
60  
61  
62  
63  
64  
65  
66  
67  
68  
69  
70  
71  
72  
73  
74  
75  
76  
77  
78  
79  
80  
81  
82  
83  
84  
85  
86  
87  
88  
89  
90  
91  
92  
93  
94  
95  
96  
97  
98  
99  
100

## 7.0 SUMMARY AND CONCLUSIONS

This sections provides a summary of the field activities, the nature and extent of contamination, the risk assessment, and data limitations and recommendations for future work on a site specific basis.

### 7.1 Site 1 - Drum Marshaling Area

#### 7.1.1 Field Activities

The field investigation consisted of collecting 32 soil-gas samples at 16 locations, 7 surface soil samples, 18 subsurface soil samples at 10 locations, and 10 temporary monitoring well samples; installing 7 permanent monitoring wells at 3 locations; and sampling 8 permanent monitoring wells.

The soil-gas samples were collected 5 feet or 21 feet below the surface. The subsurface samples were collected at 3-5 feet and/or 19-21 feet below the surface. The temporary monitoring well samples were collected at the water table elevation. The monitoring well samples were collected near the water-table elevation (shallow - 50 to 60 feet deep), at a depth of 100 to 160 feet below the surface (intermediate), and at a depth of 200 to 230 feet below the surface (deep).

All of the samples were analyzed for volatile organic constituents. The surface soil samples, shallow subsurface soil samples (less than 5 feet deep), surface water, sediment, and groundwater samples were analyzed for inorganic and semivolatile organic constituents. The groundwater samples were also analyzed for soluble inorganic constituents (less than 0.45 microns) and hexavalent chromium. In addition, subsurface soils that were observed to be oil stained were analyzed for PCBs and pesticides. Select soil and groundwater samples were analyzed for engineering-type parameters.

#### 7.1.2 Geology/Hydrology

The NWIRP is underlain by approximately 1,100 feet of unconsolidated sediments that unconformably overlie crystalline bedrock. The unconsolidated sediments consist of four distinct geologic units that, in descending order, are the Upper Glacial Formation, the Magothy Formation, the Raritan Clay Member of the Raritan Formation, and the Lloyd Sand Member of the Raritan Formation. The crystalline bedrock consists primarily of schist, gneiss, and granite. The regional dip is to the south and southeast. All of the geologic units dip in these directions, although to varying degrees.

The Upper Glacial and the Magothy Formations were penetrated and sampled; the Raritan Formation lies below the total depth of this investigation. The Upper Glacial Formation, which is about 30 to

45 feet thick, consists chiefly of coarse sands and gravels. The upper Magothy Formation consists chiefly of coarse sands to a depth of about 100 feet, below which finer sands, silts, and clays predominate. The clay is fairly common but laterally discontinuous; no individual clay horizon of regional extent underlies the NWIRP.

The Upper Glacial Formation, the Magothy Formation, and the Lloyd Sand are regional aquifers. Because of their proximity to the land surface, the principal aquifers of concern in this investigation are the Upper Glacial and Magothy aquifers. Of these two aquifers, the Magothy aquifer is the major source of public water in Nassau County. Because of its depth the Lloyd Sand is not widely exploited. Furthermore, the Lloyd Sand is isolated from the shallower aquifers by the Raritan Clay confining unit.

The water table beneath the NWIRP occurred completely within the Magothy Formation in December 1991. The magnitude of the seasonal water-table fluctuation beneath the site is unknown, but it is unlikely that the water table rises to the Upper Glacial Formation. The high permeability of the glacial deposits, however, allows for the rapid recharge of precipitation to the underlying Magothy.

The geologic and hydrologic information obtained from this study indicates that the Upper Glacial and upper Magothy aquifers beneath the NWIRP are interconnected and may be considered a common aquifer. This confirms the theory that the site-specific geology is similar to the regional geology, as described in published reports. Groundwater in this aquifer occurs under water-table or unconfined conditions. The number and thickness of clay lenses increase with depth within the Magothy, but the horizontally discontinuous nature of these units prevents any one of them from singularly functioning as an aquitard or semiconfining unit.

The groundwater beneath the NWIRP dominantly flows to the southwest and, to a lesser extent, to the south. The flow is greatly influenced by the groundwater mounding that occurs at the recharge basins and by the groundwater withdrawal at the numerous facility wells. The wells have the potential to significantly change the local flow pattern. These wells operate on an irregular basis and in various combinations. Consequently, their influence on the local flow regime at any particular time difficult to predict.

The horizontal hydraulic gradient varies throughout the NWIRP due to the recharge basins and facility wells. The average gradient calculated across the activity is about 5.3 feet/mile, which is significantly lower than the published regional gradient of 10 feet/mile. The average linear velocity of the groundwater at the water table is estimated to range from 0.02 ft/day to 0.08 ft/day, which is significantly less than the previously estimated 50 to 70 ft/day.

The NWIRP occupies an area of recharge. Vertical hydraulic gradients are in a downward direction, but are very low. This agrees with previously published regional data.

#### **7.1.3 Nature and Extent of Contamination**

VOC contamination, especially by chlorinated ethanes and chlorinated ethenes, is evident in soil and groundwater. The highest concentrations at the NWIRP were reported in Site 1, especially near the drum marshaling areas. VOC contamination was greater in shallow wells than intermediate. VOC contamination was also greater in subsurface than in surface soil. PCBs were reported at various locations in soil.

Notable levels of certain inorganics, including chromium, arsenic, and cyanide, were detected in onsite media. Surface soil in Site 3 and subsurface soil in Site 2 exhibited the highest levels of inorganics. There is no clear pattern in the concentrations of inorganics in groundwater; notable levels of metals, including arsenic, vanadium, chromium, lead and cyanide, were reported in some wells.

#### **7.1.4 Baseline Risk Assessment**

To assess the risks to human health from the site contaminants, exposure scenarios were developed. For contaminated soil, the scenarios include direct contact with contaminants in surface soils through dermal contact, ingestion, and inhalation (current soil exposure); potential direct contact with subsurface soils following excavation of such soils; (future soil exposure); and indirect exposure through soil contaminants leaching to groundwater, and the contaminated groundwater being consumed (future groundwater exposure). The receptors include onsite adult workers and offsite adult and child residents. The receptors for direct contact were employees only. For the contaminated groundwater, the scenarios include residential and employee consumption of the contaminated groundwater (current groundwater exposure).

Hazard Indices calculated for current and future soil exposure are all below 1.0; adverse noncarcinogenic health effects for these pathways are not indicated. Total cancer risks for current soil exposure range from  $2E-7$  to  $4E-6$ , with the highest risk occurring for the adult employee dermal exposure scenario. Aroclor 1248 in Site 1 was the major factor in these potential dermal cancer risks. Estimated total cancer risks for future soil exposure ranged from  $9E-11$  to  $9E-6$ , with the highest risks occurring for the adult resident dust inhalation scenario at Site 1. Arsenic at Site 1 was primarily responsible for these projected cancer risks.

For potential exposure to current groundwater concentrations, Hazard Indices exceeded 1.0 for all three potential receptors



(employee, adult resident, child resident). Individual Hazard Quotients for several chemicals exceeded 1.0, including both metals and VOCs. Estimated total cancer risks ranged from 8E-4 to 3E-3, with TCE risks comprising a large portion of the total risk.

For potential exposure to future groundwater concentrations, Hazard Indices exceeded 1.0 for the resident ingestion/dermal pathways. This was due primarily to PCE, for which the Hazard Quotient exceeded 1.0. Estimated total cancer risks ranged from 6E-6 to 6E-4, with TCE, PCE, and Aroclor 1248 posing the greatest risks.

Based on current risk assessment modeling, it has been determined that groundwater concentrations of VOCs and inorganics are the most significant sources of noncarcinogenic and carcinogenic risk at the Bethpage site. In addition, many groundwater constituents exceeded Federal and state drinking water standards. PCBs in surface and subsurface soil at Bethpage may pose the greatest cancer risk, especially because of their high CSF.

#### 7.1.5 Conclusions

Based on volatile organic isoconcentration contour maps, Site 1 is a likely source of onsite and near-site (Grumman) groundwater contamination. It is anticipated that additional work will be required to define the overall extent of contamination.

The soils at Site 1 contain sufficient residual volatile organic contamination to confirm the source of groundwater contamination as being near or at the former drum marshaling areas. Based on observed groundwater contamination patterns, there are potentially other source areas at the NWIRP including sumps and tanks at Plant 3 and a former coal storage pile near Plant 3.

The contaminants in the soils at the NWIRP (under the current or in future scenarios) do not represent a significant, direct, non-carcinogenic risk to onsite workers or offsite residents (hazard index is less than 1.0). Likewise, incremental carcinogenic risks are not indicated for offsite residents under the current soil scenario (excess cancer risk less than  $1 \times 10^{-6}$ ). However, carcinogenic risks to onsite workers (under the current and future soil scenarios) and offsite residents (under future soil scenarios) exceed an excess cancer risk of  $1 \times 10^{-6}$ . The risks do not, however, exceed an excess cancer risk of  $1 \times 10^{-4}$ .

The groundwater at Bethpage, if used as a potable water source, would be expected to result in significant carcinogenic risks (excess cancer risk greater than  $1 \times 10^{-4}$ ) and noncarcinogenic risks (hazard index greater 1.0) to residents and employees under the current and future groundwater scenarios. The one exception to this is that the hazard index to employees under the future groundwater exposure would be about 0.5.

#### 7.1.6 Data Limitations and Recommendations

The significant data gaps identified for Site 1 are as follows.

- The extent of groundwater contamination in the areas east and southeast of Site 1 as well as groundwater contamination south and west of Plant 3.
- Based on elevated levels of TCE at HN-24I, other potential sources of contamination may be present in and/or around Plant 03. Specific locations include sumps, tanks (current or historic), and a former coal storage pile. Alternatively, this contamination may be a result of contamination at Site 1 with groundwater flow patterns affected by the Production Wells.
- PCBs were tentatively identified in several surface soils at Site 1. Confirmation testing for the PCB contamination is required.

To address these data gaps, a Phase 2 RI is recommended. The tasks under this Phase 2 RI should include the following.

- Conduct a visual inspection of sumps, tank areas, and other locations in and around Plant 03 to determine the potential for other source areas.
- Conduct confirmation PCB sampling and analysis at locations where PCBs were identified as TICs.
- Conduct computer modeling of the groundwater flow patterns at and near the NWIRP. This modeling can be used to help determine potential source areas for the contamination found at HN-24I and also to evaluate vertical groundwater flow patterns.
- Install monitoring wells in the offsite area east and southeast of Site 1. The groundwater in these wells and Production Wells 8, 9, and 14 should be sampled and analyzed. The presence and concentration of contaminants in the other Production Well south of Plant 3 should also be evaluated.
- A Feasibility Study can be initiated to address soil and groundwater contamination. However, the findings of the Phase 2 RI are required to complete this study.

## **7.2 Site 2 - Recharge Basin Area**

### **7.2.1 Field Activities**

The field investigation consisted of collecting 48 soil-gas samples at 24 locations, 13 surface soil samples, 14 subsurface soil samples at 13 locations, 11 temporary monitoring well samples, 2 surface water samples, and 4 sediment samples; installing 3 permanent monitoring wells at 2 locations; and sampling 3 permanent monitoring wells.

The soil-gas samples were collected 5 feet or 21 feet below the surface. The subsurface samples were collected at 3-5 feet and/or 19-21 feet below the surface. The temporary monitoring well samples were collected at the water table elevation. The surface water samples represent the influent to the two active recharge basins. The sediment samples were obtained from the two active recharge basins. The monitoring well samples were collected near the water-table elevation (shallow - 50 to 60 feet deep), at a depth of 100 to 160 feet below the surface (intermediate), and at a depth of 200 to 230 feet below the surface (deep).

All of the samples were analyzed for volatile organics constituents. The surface soil samples, shallow subsurface soil samples (less than 5 feet deep), surface water, sediment, and groundwater samples were analyzed for inorganic and semivolatile organic constituents. The groundwater and surface water samples were also analyzed for soluble inorganic constituents (less than 0.45 microns) and hexavalent chromium. In addition, surface and subsurface soils that were observed to be oil stained were analyzed for PCBs and pesticides. Select soil and groundwater samples were analyzed for engineering-type parameters.

### **7.2.2 Geology/Hydrology**

The NWIRP is underlain by approximately 1,100 feet of unconsolidated sediments that unconformably overlie crystalline bedrock. The unconsolidated sediments consist of four distinct geologic units that, in descending order, are the Upper Glacial Formation, the Magothy Formation, the Raritan Clay Member of the Raritan Formation, and the Lloyd Sand Member of the Raritan Formation. The crystalline bedrock consists primarily of schist, gneiss, and granite. The regional dip is to the south and southeast. All of the geologic units dip in these directions, although to varying degrees (Isbister, 1966).

The Upper Glacial and the Magothy Formations were penetrated and sampled; the Raritan Formation lies below the total depth of this investigation. The Upper Glacial Formation, which is about 30 to 45 feet thick, consists chiefly of coarse sands and gravels. The upper Magothy Formation consists chiefly of coarse sands to a depth

of about 100 feet, below which finer sands, silts, and clays predominate. The clay is fairly common but laterally discontinuous; no individual clay horizon of regional extent underlies the NWIRP.

The Upper Glacial Formation, the Magothy Formation, and the Lloyd Sand are regional aquifers. Because of their proximity to the land surface, the principal aquifers of concern in this investigation are the Upper Glacial and Magothy aquifers. Of these two aquifers, the Magothy aquifer is the major source of public water in Nassau County. Because of its depth the Lloyd Sand is not widely exploited. Furthermore, the Lloyd Sand is isolated from the shallower aquifers by the Raritan Clay confining unit (RGH, 1986; G&M, 1990).

The water table beneath the NWIRP occurred completely within the Magothy Formation in December 1991. The magnitude of the seasonal water-table fluctuation beneath the site is unknown, but it is unlikely that the water table rises to the Upper Glacial Formation. The high permeability of the glacial deposits, however, allows for the rapid recharge of precipitation to the underlying Magothy.

The geologic and hydrologic information obtained from this study indicates that the Upper Glacial and upper Magothy aquifers beneath the NWIRP are interconnected and may be considered a common aquifer. This confirms the theory that the site-specific geology is similar to the regional geology, as described in published reports. Groundwater in this aquifer occurs under water-table or unconfined conditions. The number and thickness of clay lenses increase with depth within the Magothy, but the horizontally discontinuous nature of these units prevents any one of them from singularly functioning as an aquitard or semiconfining unit.

The groundwater beneath the NWIRP dominantly flows to the southwest and, to a lesser extent, to the south. The flow is greatly influenced by the groundwater mounding that occurs at the recharge basins and by the groundwater withdrawal at the numerous facility wells. The wells have the potential to significantly change the local flow pattern. These wells operate on an irregular basis and in various combinations. Consequently, their influence on the local flow regime at any particular time difficult to predict.

The horizontal hydraulic gradient varies throughout the NWIRP due to the recharge basins and facility wells. The average gradient calculated across the activity is about 5.3 feet/mile, which is significantly lower than the published regional gradient of 10 feet/mile. The average linear velocity of the groundwater at the water table is estimated to range from 0.02 ft/day to 0.08 ft/day, which is significantly less than the previously estimated 50 to 70 ft/day.

The NWIRP occupies an area of recharge. Vertical hydraulic gradients are in a downward direction, but are very low. This agrees with previously published regional data.

### **7.2.3 Nature and Extent of Contamination**

VOC contamination, especially by chlorinated ethanes and chlorinated ethenes, is present in soil, surface water, and groundwater. However, the concentrations detected at Site are significantly lower than detected at Sites 1 and 3. Also, the upgradient monitoring wells at Site 2 were also observed to contain similar volatile organics. VOC contamination was also greater in subsurface than in surface soil. PCBs were reported at various locations in soil. Recharge basin surface water and sediment exhibited trace to low levels of VOCs.

Notable levels of certain inorganics, including chromium, arsenic, and cyanide, were detected in onsite media. Subsurface soil in Site 2 exhibited the highest levels of inorganics of the three sites. There is no clear pattern in the concentrations of inorganics in groundwater; notable levels of metals, including arsenic, vanadium, chromium, lead and cyanide, were reported in some wells.

### **7.2.4 Baseline Risk Assessment**

To assess the risks to human health from the site contaminants, exposure scenarios were developed. For contaminated soil, the scenarios include direct contact with contaminants in surface soils through dermal contact, ingestion, and inhalation (current soil exposure); potential direct contact with subsurface soils following excavation of such soils; (future soil exposure); and indirect exposure through soil contaminants leaching to groundwater, and the contaminated groundwater being consumed (future groundwater exposure). The receptors include onsite adult workers and offsite adult and child residents. For the contaminated groundwater, the scenarios include residential and employee consumption of the contaminated groundwater (current groundwater exposure).

Hazard Indices calculated for current and future soil exposure are all below 1.0; adverse noncarcinogenic health effects for these pathways are not indicated. Total cancer risks for current soil exposure range from 5E-8 to 2E-6, with the highest risk occurring for the adult employee dermal exposure scenario. Aroclor 1248 in Site 2 was the major factors in these potential dermal cancer risks. Estimated total cancer risks for future soil exposure ranged from 5E-8 to 3E-6, with the highest risks occurring for the employee dermal absorption at Site 2. Aroclor 1248 at Site 2 was primarily responsible for these projected cancer risks.

For potential exposure to current groundwater concentrations, Hazard Indices exceeded 1.0 for all three potential receptors

(employee, adult resident, child resident). Individual Hazard Quotients for several chemicals exceeded 1.0, including both metals and VOCs. Estimated total cancer risks ranged from 8E-4 to 3E-3, with TCE risks comprising a large portion of the total risk.

For potential exposure to future groundwater concentrations, Hazard Indices exceeded 1.0 for the resident ingestion/dermal pathways. This was due primarily to PCE, for which the Hazard Quotient exceeded 1.0. Estimated total cancer risks ranged from 6E-6 to 6E-4, with TCE, PCE, and Aroclor 1248 posing the greatest risks.

Based on current risk assessment modeling, it has been determined that groundwater concentrations of VOCs and inorganics are the most significant sources of noncarcinogenic and carcinogenic risk at the Bethpage site. In addition, many groundwater constituents exceeded Federal and state drinking water standards. PCBs in surface and subsurface soil at Bethpage may pose the greatest cancer risk, especially because of their high CSF.

#### 7.2.5 Conclusions

Based on volatile organic isoconcentration contour maps, Site 2 is not a likely source of onsite groundwater contamination.

Minimal volatile organic contamination of the soils or groundwater is present at Site 2. The surface water entering the recharge basins contains sufficient concentrations of volatile organics to result in groundwater contamination. However, the concentrations are not high enough to account for the volatile organic concentrations detected at Site 1. Based on the relative concentration of volatile organics found in the production wells, it is likely that the recharge basins are just redistributing the contaminated groundwater. Also, it should be noted that since the concentration of volatile organics in the surface water is lower than in the production wells, the systems likely to result in partial treatment of the groundwater by volatilization.

The contaminants in the soils at the NWIRP (under the current or in future scenarios) do not represent a significant, direct, non-carcinogenic risk to onsite workers or offsite residents (hazard index is less than 1.0). Likewise, incremental carcinogenic risks are not indicated for offsite residences under the current soil scenario (excess cancer risk less than  $1 \times 10^{-6}$ ). However, carcinogenic risks to onsite workers (under the current and future soil scenarios) and offsite residents (under future soil scenarios) exceed an excess cancer risk of  $1 \times 10^{-6}$ . The risks do not, however, exceed an excess cancer risk of  $1 \times 10^{-4}$ .

The groundwater at Bethpage, if used as a potable water source, would be expected to result in significant carcinogenic risks (excess cancer risk greater than  $1 \times 10^{-4}$ ) and noncarcinogenic risks (hazard index greater 1.0) to residents and employees under

the current and future groundwater scenarios. The one exception to this is that the hazard index to employees under the future groundwater exposure would be about 0.5.

#### **7.2.6 Data Limitations and Recommendations**

The significant data gaps identified for Site 2 are as follows.

- PCBs were tentatively identified in several surface soils at Site 2. Confirmation testing for the PCB contamination is required.
- The former sludge beds were not found during the field activities.

To address these data gaps, a Phase 2 RI is recommended. The tasks under this Phase 2 RI should include the following.

- Conduct a records search to determine how the former sludge drying beds were closed. If necessary, a test pit program may be considered in this area.
- Conduct confirmation PCB sampling and analysis at locations where PCBs were identified as TICs.
- A Feasibility Study can be initiated to address soil contamination. However, the findings of the Phase 2 RI are required to complete this study.

### **7.3 Site 3 - Salvage Storage Area**

#### **7.3.1 Field Activities**

The field investigation consisted of collecting 60 soil-gas samples at 30 locations, 8 surface soil samples, 14 subsurface soil samples at 9 locations, and 9 temporary monitoring well samples; installing 5 permanent monitoring wells at 2 locations; and sampling 5 permanent monitoring wells and four production wells.

The soil-gas samples were collected 5 feet or 21 feet below the surface. The subsurface samples were collected at 3-5 feet and/or 19-21 feet below the surface. The temporary monitoring well samples were collected at the water table elevation. The surface water samples represent the influent to the two active recharge basins. The sediment samples were obtained from the two active recharge basins. The monitoring well samples were collected near the water-table elevation (shallow - 50 to 60 feet deep), at a depth of 100 to 160 feet below the surface (intermediate), and at a depth of 200 to 230 feet below the surface (deep).

All of the samples were analyzed for volatile organic constituents. The surface soil samples, shallow subsurface soil samples (less

than 5 feet deep), surface water, sediment, and groundwater samples were analyzed for inorganic and semivolatile organic constituents. The groundwater and production well samples were also analyzed for soluble inorganic constituents (less 0.45 microns) and hexavalent chromium. In addition, surface and subsurface soils that were observed to be oil stained were analyzed for PCBs and pesticides. Select soil and groundwater samples were analyzed for engineering-type parameters.

### 7.3.2 Geology/Hydrology

The NWIRP is underlain by approximately 1,100 feet of unconsolidated sediments that unconformably overlie crystalline bedrock. The unconsolidated sediments consist of four distinct geologic units that, in descending order, are the Upper Glacial Formation, the Magothy Formation, the Raritan Clay Member of the Raritan Formation, and the Lloyd Sand Member of the Raritan Formation. The crystalline bedrock consists primarily of schist, gneiss, and granite. The regional dip is to the south and southeast. All of the geologic units dip in these directions, although to varying degrees.

The Upper Glacial and the Magothy Formations were penetrated and sampled; the Raritan Formation lies below the total depth of this investigation. The Upper Glacial Formation, which is about 30 to 45 feet thick, consists chiefly of coarse sands and gravels. The upper Magothy Formation consists chiefly of coarse sands to a depth of about 100 feet, below which finer sands, silts, and clays predominate. The clay is fairly common but laterally discontinuous; no individual clay horizon of regional extent underlies the NWIRP.

The Upper Glacial Formation, the Magothy Formation, and the Lloyd Sand are regional aquifers. Because of their proximity to the land surface, the principal aquifers of concern in this investigation are the Upper Glacial and Magothy aquifers. Of these two aquifers, the Magothy aquifer is the major source of public water in Nassau County. Because of its depth the Lloyd Sand is not widely exploited. Furthermore, the Lloyd Sand is isolated from the shallower aquifers by the Raritan Clay confining unit.

The water table beneath the NWIRP occurred completely within the Magothy Formation in December 1991. The magnitude of the seasonal water-table fluctuation beneath the site is unknown, but it is unlikely that the water table rises to the Upper Glacial Formation. The high permeability of the glacial deposits, however, allows for the rapid recharge of precipitation to the underlying Magothy.

The geologic and hydrologic information obtained from this study indicates that the Upper Glacial and upper Magothy aquifers beneath the NWIRP are interconnected and may be considered a common aquifer. This confirms the theory that the site-specific geology



is similar to the regional geology, as described in published reports. Groundwater in this aquifer occurs under water-table or unconfined conditions. The number and thickness of clay lenses increase with depth within the Magothy, but the horizontally discontinuous nature of these units prevents any one of them from singularly functioning as an aquitard or semiconfining unit.

The groundwater beneath the NWIRP dominantly flows to the southwest and, to a lesser extent, to the south. The flow is greatly influenced by the groundwater mounding that occurs at the recharge basins and by the groundwater withdrawal at the numerous facility wells. The wells have the potential to significantly change the local flow pattern. These wells operate on an irregular basis and in various combinations. Consequently, their influence on the local flow regime at any particular time difficult to predict.

The horizontal hydraulic gradient varies throughout the NWIRP due to the recharge basins and facility wells. The average gradient calculated across the activity is about 5.3 feet/mile, which is significantly lower than the published regional gradient of 10 feet/mile. The average linear velocity of the groundwater at the water table is estimated to range from 0.02 ft/day to 0.08 ft/day, which is significantly less than the previously estimated 50 to 70 ft/day.

The NWIRP occupies an area of recharge. Vertical hydraulic gradients are in a downward direction, but are very low. This agrees with previously published regional data.

### 7.3.3 Nature and Extent of Contamination

VOC contamination, especially by chlorinated ethanes and chlorinated ethenes, is evident in soil and groundwater. One well, HN24I, located southwest of Site 3, exhibited a significant concentration of TCE. VOCs were detected in groundwater at greater concentrations south of Site 3 than north. However, these contaminant concentrations were less than those at Site 1. With the exception of HN-24I, VOC contamination was greater in shallow wells than intermediate. VOC contamination was also greater in subsurface than in surface soil. PCBs were reported at various locations in soil.

Notable levels of certain inorganics, including lead, arsenic, and cyanide, were detected in onsite media. Surface soil in Site 3 exhibited the highest levels of inorganics for the three sites. There is no clear pattern in the concentrations of inorganics in groundwater; notable levels of metals, including arsenic, vanadium, chromium, lead and cyanide, were reported in some wells.

#### 7.3.4 Baseline Risk Assessment

To assess the risks to human health from the site contaminants, exposure scenarios were developed. For contaminated soil, the scenarios include direct contact with contaminants in surface soils through dermal contact, ingestion, and inhalation (current soil exposure); potential direct contact with subsurface soils following excavation of such soils; (future soil exposure); and indirect exposure through soil contaminants leaching to groundwater, and the contaminated groundwater being consumed (future groundwater exposure). The receptors include onsite adult workers and offsite adult and child residents. For the contaminated groundwater, the scenarios include residential and employee consumption of the contaminated groundwater (current groundwater exposure).

Hazard Indices calculated for current and future soil exposure are all below 1.0; adverse noncarcinogenic health effects for these pathways are not indicated. Total cancer risks for current soil exposure range from  $6E-8$  to  $2E-6$ , with the highest risk occurring for the adult employee dermal exposure scenario. Benzo[a]pyrene in Site 3 was the major factors in these potential dermal cancer risks.

For potential exposure to current groundwater concentrations, Hazard Indices exceeded 1.0 for all three potential receptors (employee, adult resident, child resident). Individual Hazard Quotients for several chemicals exceeded 1.0, including both metals and VOCs. Estimated total cancer risks ranged from  $8E-4$  to  $3E-3$ , with TCE risks comprising a large portion of the total risk.

For potential exposure to future groundwater concentrations, Hazard Indices exceeded 1.0 for the resident ingestion/dermal pathways. This was due primarily to PCE, for which the Hazard Quotient exceeded 1.0. Estimated total cancer risks ranged from  $6E-6$  to  $6E-4$ , with TCE, PCE, and Aroclor 1248 posing the greatest risks.

Based on current risk assessment modeling, it has been determined that groundwater concentrations of VOCs and inorganics are the most significant sources of noncarcinogenic and carcinogenic risk at the Bethpage site. In addition, many groundwater constituents exceeded Federal and state drinking water standards. PCBs in surface and subsurface soil at Bethpage may pose the greatest cancer risk, especially because of their high CSF.

#### 7.3.5 Conclusions

Based on volatile organic isoconcentration contour maps, Site 3 is a likely source of onsite groundwater contamination. It is anticipated that the work associated with Site 1-related ground will define the extent of this contamination.

Only low concentrations of volatile organics were detected in the soils at Site 3. Therefore, the source area of the volatile organic plume either is no longer present or was not found during the RI.

Based on the relative concentration of volatile organics found in the production wells, the recharge basins are likely to be redistributing the contaminated groundwater. Also, it should be noted that since the concentration of volatile organics in the surface water is lower than in the production wells, the system is likely to result in partial treatment of the groundwater by volatilization.

The contaminants in the soils at the NWIRP (under the current or in future scenarios) do not represent a significant, direct, non-carcinogenic risk to onsite workers or offsite residents (hazard index is less than 1.0). Likewise, incremental carcinogenic risks are not indicated for offsite residences under the current soil scenario (excess cancer risk less than  $1 \times 10^{-6}$ ). However, carcinogenic risks to onsite workers (under the current and future soil scenarios) and offsite residents (under future soil scenarios) exceed an excess cancer risk of  $1 \times 10^{-6}$ . The risks do not, however, exceed an excess cancer risk of  $1 \times 10^{-4}$ .

The groundwater at Bethpage, if used as a potable water source, would be expected to result in significant carcinogenic risks (excess cancer risk greater than  $1 \times 10^{-4}$ ) and noncarcinogenic risks (hazard index greater 1.0) to residents and employees under the current and future groundwater scenarios. The one exception to this is that the hazard index to employees under the future groundwater exposure would be about 0.5.

#### 7.3.6 Data Limitations

The significant data gaps identified for Site 3 are as follows.

- PCBs were tentatively identified in several surface soils at Site 2. Confirmation testing for the PCB contamination is required.
- Groundwater contamination was found to be originating at Site 3. However, this contamination appears to merge with a much more significant source of contamination from Site 1. Further evaluation of Site 3 groundwater contamination can be considered a part of Site 1 groundwater activities.

To address these data gaps, a Phase 2 RI is recommended. The tasks under this Phase 2 RI should include the following.

- Conduct confirmation PCB sampling and analysis at locations where PCBs were identified as TICs.

- A Feasibility Study can be initiated to address soil and groundwater contamination. However, the findings of the Phase 2 RI are required to complete this study.

REFERENCES

## REFERENCES

Clement Associates, Inc., April 1988. "Comparative Potency Approach for Estimating the Cancer Risk Associated with Exposure to Mixtures of Polycyclic Aromatic Hydrocarbons." Interim Final Report. Fairfax, Virginia.

Cline, P. V. and D. R. Viste, 1984. Migration and Degradation Patterns of Volatile Organic Compounds. Warzyn Engineering, Inc., Madison, Wisconsin.

Cowherd, C., G. E. Muleski, P. J. Englehart, and D. A. Gillette, Sept. 1984. Rapid Assessment of Exposure to Particulate Emissions from Surface Contamination Sites. Midwest Research Institute, Kansas City, Missouri.

Dragun, J., 1988. The Soil Chemistry of Hazardous Materials. Hazardous Materials Control Research Institute, Silver Springs, Maryland.

Feldman, M. D. and M. I. Maibach, 1970. "Absorption of Some Organic Compounds Through the Skin in Man." Journal of Investigative Dermatology, Williams and Wilkins Co., Baltimore, Maryland.

Fetter, C. W., 1988. Applied Hydrogeology. Merril Publishing Co., Columbus, Ohio.

Foster, S. A., and P. C. Chrostowski, 1987. "Inhalation Exposures to Volatile Organic Contaminants in the Shower." Presented at the 80th Annual Meeting of the Air Pollution Control Association, New York, June.

Fuller, M. L., 1914. The Geology of Long Island, New York. U. S. Geologic Survey (USGS).

G&M (Geraghty & Miller), 1990. Remedial Investigation/Feasibility Study Work Plan, Grumman Aerospace Corp., Bethpage, NY. Plainview, New York.

Isbister, John., 1966 Geology and Hydrogeology of Northeastern Nassau County, Long Island, New York. Washington, D.C.: USGS.

Javandel, I., C. Daughy, and C. Tsang, 1984. Groundwater Transport: Handbook of Mathematical Models. American Geophysical Union, Water Monograph Series 10, Washington, DC.

Lunsford, C. A., 1982. Proposed Guidelines--Handling Upland Areas Contaminated with PCB-Contaminated Sediments and Soils. Division of Ecological Studies, Bureau of Surveillance and Field Studies.

Lyman, Warren J., William F. Reehl, and David H. Rosenblatt, 1990. Handbook of Chemical Property Estimation Methods. American Chemical Society, Washington, DC.

McClymonds, N. E., and Franke, O. L., 1972. Water-Transmitting Properties of Aquifers on Long Island, New York. United States Geological Survey, Professional Paper 627-E.

NLM (National Library of Medicine), Jan. 13, 1992. Hazardous Substances Data Bank. Records for Koc of polychlorinated biphenyls, Aroclor 1248, Aroclor 1260, Aroclor 1016, Aroclor 1221, Aroclor 1254, and Aroclor 1232, obtained 1/13/92.

NLM (National Library of Medicine), Jan. 23, 1992. Hazardous Substances Data Bank. Records for environmental and nonhuman toxicity of Aroclor 1248, lead, cadmium, arsenic, trichloroethene, and tetrachloroethene, obtained 1/23/92.

RGH (Rogers, Golden, & Halpein), 1986. Initial Assessment Study of NWIRP Bethpage, NY and NWIRP Calverton, NY. Contract No. N62474-84-3386, Environmental Restoration Department, Naval Energy and Environmental Support Activity, December.

Sittig, Marshall, 1985. Handbook of Toxic and Hazardous Chemicals and Carcinogens. Noyes Publications, Park Ridge, NJ.

New York State Sanitary Code, July 3, 1991. Chapter 1, Subpart 5-1: Public Water Supplies (Statutory Authority: Public Health Law 225).

USEPA, 1979. Water-Related Environmental Fate of 129 Priority Pollutants. EPA 440/4-79-029, Versar, Inc., for USEPA, Monitoring and Data Support Division, Washington, DC. EPA 440/4-79-029.

USEPA, October 1980a. Ambient Water Quality Criteria for Beryllium. EPA 440/5-80-024, Office of Water Regulations and Standards, Criteria and Standards Division, Washington, DC.

USEPA, October 1980b. Ambient Water Quality Criteria for Thallium. EPA 440/5-80-074, Office of Water Regulations and Standards, Criteria and Standards Division, Washington, DC.

USEPA, October 1980c. Ambient Water Quality Criteria for Silver. EPA 440/5-80-071, Office of Water Regulations and Standards, Criteria and Standards Division, Washington, DC.

USEPA, October 1980d. Ambient Water Quality Criteria for Lead. EPA 440/5-80-071, Office of Water Regulations and Standards, Criteria and Standards Division, Washington, DC.

USEPA, December 1982. Aquatic Fate Process Data for Organic Priority Pollutants. EPA 440/4-81-014, Washington, D.C.

USEPA, August 19, 1983a. Ambient Water Quality Criteria for Chromium, Aquatic Toxicology (Section B), Revised. Draft. EPA 440/5-80-071, Office of Water Regulations and Standards, Criteria and Standards Division, Washington, DC.

USEPA, August 19, 1983b. Ambient Water Quality Criteria for Copper, Aquatic Toxicology (Section B), Revised. Draft. EPA 440/5-80-071, Office of Water Regulations and Standards, Criteria and Standards Division, Washington, DC.

USEPA, August 19, 1983c. Ambient Water Quality Criteria for Mercury, Aquatic Toxicology (Section B), Revised. Draft. EPA 440/5-80-071, Office of Water Regulations and Standards, Criteria and Standards Division, Washington, DC.

USEPA, August 19, 1983d. Ambient Water Quality Criteria for Cadmium, Aquatic Toxicology (Section B), Revised. Draft. EPA 440/5-80-071, Office of Water Regulations and Standards, Criteria and Standards Division, Washington, DC.

USEPA, August 19, 1983e. Ambient Water Quality Criteria for Arsenic, Aquatic Toxicology (Section B), Revised. Draft. EPA 440/5-80-071, Office of Water Regulations and Standards, Criteria and Standards Division, Washington, DC.

USEPA, February 15, 1984. "Water Quality Criteria; Availability of Document." 49 Federal Register 32, pp. 5831 et seq.

USEPA, November 13, 1985. "National Primary Drinking Water Regulations; Synthetic Organic Chemicals, Inorganic Chemicals, and Microorganisms; Proposed Rule." 50 Federal Register 219.

USEPA, February 18, 1986. Ambient Aquatic Life Water Quality Criteria for Nickel. Draft. Office of Research and Development, Environmental Research Laboratories, Duluth, MN, and Narragansett, Rhode Island.

USEPA, March 27, 1986. Ambient Aquatic Life Water Quality Criteria for Selenium. Draft. Office of Research and Development, Environmental Research Laboratories, Duluth, MN, and Narragansett, Rhode Island.

USEPA, April 10, 1986. Ambient Aquatic Life Water Quality Criteria for Zinc. Draft. Office of Research and Development, Environmental Research Laboratories, Duluth, MN, and Narragansett, Rhode Island.

USEPA, Sept. 24, 1986. "Guidelines for the Health Risk Assessment of Chemical Mixtures." 51 FR 185, 34014 et seq.



USEPA, 1987. "Update Number 2 to Quality Criteria for Water 1986." Office of Water Regulations and Standards, Criteria and Standards Division, Washington, DC.

USEPA, April 1988. Superfund Exposure Assessment Manual. Final Draft. EPA 540/1-88-001.

USEPA, May 1989. Exposure Factors Handbook. Office of Health and Environmental Assessment. EPA 600/8-89/043.

USEPA, December 1989. Risk Assessment Guidance for Superfund Sites. Volume I: Human Health Evaluation Manual (Part A). Interim Final. EPA 540/1-89/002. Office of Emergency and Remedial Response.

USEPA, July 25, 1990. 55 Federal Register 30,370-30,448.

USEPA, January 1991. Health Effects Assessment Summary Tables. OERR 9200.6-303(91-1). Office of Emergency and Remedial Response, Washington, DC.

USEPA, January 30, 1991. "National Primary Drinking Water Regulations." 40 CFR 141, Subparts B & G.

USEPA, March 25, 1991. "Human Health Evaluation Manual, Supplemental Guidance: Standard Default Exposure Factors." OSWER Directive 9285.6-03.

USEPA, April 1991. "Drinking Water Regulations and Health Advisories." Office of Water, Washington, DC.

USEPA, June 7, 1991. "Maximum Contaminant Level Goals and National Primary Drinking Water Regulations for Lead and Copper; Final Rule." 56 FR 26460-26564.

USEPA, July 17, 1991. "National Primary Drinking Water Regulations; Final Rule." 56 Federal Register 30265-30281.

USEPA RREL (Risk Reduction Engineering Laboratory). Treatability Database. Revision No. 3.0. Cincinnati, Ohio

Verschueren, K., 1983. Handbook of Environmental Data on Organic Chemicals. Second Edition. Van Nostrand Reinhold Co. Inc., NY.

Weast, Robert C., Ed., 1988. CRC Handbook of Chemistry and Physics. First Student Edition. CRC Press Inc., Boca Raton, FL.

Zar, Jerrold H., 1974. Biostatistical Analysis. Prentice-Hall, Inc., Englewood Cliffs, New Jersey.