



ARCADIS of New York, Inc.
Two Huntington Quadrangle
Suite 1S10
Melville
New York 11747
Tel 631.249.7600
Fax 631.249.7610
www.arcadis-us.com

Mr. Steven Scharf, P.E.
New York State Department of Environmental Conservation (NYSDEC)
Remedial Action, Bureau A
Division of Environmental Remediation
625 Broadway
Albany, New York 12233-7015

ENVIRONMENT

Subject:
Interim Data Report for On-Site Containment System Hydraulic Effectiveness Program, Operable Unit 2, Northrop Grumman Systems Corporation, Bethpage, New York (NYSDEC Site #1-30-003A).

Date:
September 4, 2012

Dear Mr. Scharf:

Contact:
David E. Stern

On behalf of Northrop Grumman Systems Corporation (Northrop Grumman), ARCADIS has prepared this interim data report summarizing drilling, well installation, and groundwater sampling activities performed at the Northrop Grumman facility in Bethpage, New York. This work was performed pursuant to the On-Site Containment System (ONCT) Hydraulic Effectiveness Work Plan, dated December 6, 2011. The work plan was approved by NYSDEC in a letter, dated January 12, 2012.

Phone:
631 391-5284

Email:
david.stern@arcadis-us.com

Background

Our ref:
NY001496.0212.ONCB6

Pursuant to the Operable Unit 2 (OU2) Record of Decision (ROD) issued by the New York State Department of Environmental Conservation (NYSDEC), Northrop Grumman designed, constructed, and operates the ONCT pump and treat system (ONCT system) that consists of five deep remedial wells (Wells 1, 3, 17, 18, and 19 - see **Figure 1**) that pump continuously at a combined rate of approximately 3,800 gallons per minute (gpm), equivalent to approximately 5.5 million gallons per day (MGD). Water from the wells is treated by two air strippers. Treated effluent is discharged to the Northrop Grumman south and west basins, with a portion consumed by the Calpine Energy generating facility. The remedial objective of the ONCT system is to prevent the off-site migration of volatile organic compound (VOC)-impacted groundwater and data collected during routine groundwater monitoring rounds indicate that the ONCT system is meeting this objective. The "Operable Unit 2 Groundwater Remedial System Hydraulic Effectiveness Evaluation" (2003) carried out jointly by Navy and Northrop Grumman pursuant to the OU 2 ROD provided additional data that supported the conclusion that the ONCT system is meeting its remedial objective. Northrop Grumman voluntarily collected the additional data included in this current report to supplement the 2003 report and ongoing monitoring of the ONCT system.

Imagine the result

Summary of Work

The field work was performed from December 6, 2011 through March 14, 2012 and consisted of drilling and sampling three vertical profile boring (VPBs) (VP-3-1, VP-33 and VP-73R) (**Figure 1**). VPBs were drilled into the Raritan Confining Unit (RCU), in accordance with the protocols described in the work plan, with VPB terminal depths as follows: VP-3-1 (766 ft bls) VP-33 (680 ft bls) and VP-73R (682 ft bls). Two monitoring wells (MW3-1 and GM-73D3) were installed in the boreholes of VP3-1 and VP73R, respectively, and developed (**Figure 1**). Groundwater samples were collected from Wells MW-3-1 and GM-73D3 following completion of well development.

Sample collection and laboratory analytical protocols for water samples followed procedures detailed in the NYSDEC-approved OU2 Groundwater Monitoring Plan (ARCADIS 2001; 2006). Groundwater samples collected from VPBs and monitoring wells were submitted for laboratory analysis for the Target Compound List VOCs. **Table 1** provides the validated analytical results for groundwater samples collected from VPBs VP-3-1, VP-33, and VP-73R. **Table 2** provides the validated analytical results for the groundwater samples collected from Wells MW3-1 and GM-73D3. **Appendix A** provides the construction logs for Wells MW3-1 and GM-73D3.

As always, if you have any questions or comments, please feel free to contact us.

Sincerely,

ARCADIS of New York, Inc.



David E. Stern
Senior Hydrogeologist

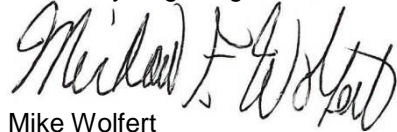

Mike Wolfert
Project Director

Enclosures

Copies:

John Cofman, Northrop Grumman
Ed Hannon, Northrop Grumman
Kent Smith, Northrop Grumman
Carol Henry, EMAGIN
Carlo San Giovanni, ARCADIS
File

Table 1. Concentrations of Volatile Organic Compounds in Groundwater Samples Collected from Vertical Profile Borings,
On-Site Containment System Hydraulic Effectiveness Program, Operable Unit 2, Northrop Grumman Systems Corporation, Bethpage, New York.

Location ID	VP-03-1	VP-03-1	VP-03-1	VP-03-1	VP-03-1	VP-03-1	VP-03-1	VP-03-1	VP-03-1	VP-03-1
Sample Date	1/20/2012	1/23/2012	1/23/2012	1/24/2012	1/25/2012	1/25/2012	1/25/2012	1/25/2012	1/25/2012	1/30/2012
Sampling Depth or Interval (ft bls):	100	150	200	258	300	320	340	360	389	429
Constituent Name (units in ug/L)										
1,1,1-Trichloroethane	< 5	< 5	< 5	< 5	< 5	< 5	< 5	< 5	< 5	0.36 J
1,1,2,2-Tetrachloroethane	< 5	< 5	< 5	< 5	< 5	< 5	< 5	< 5	< 5	< 5
1,1,2-Trichloroethane	< 5	< 5	< 5	< 5	< 5	< 5	< 5	< 5	< 5	< 5
1,1-Dichloroethane	< 5	< 5	< 5	< 5	< 5	0.3 J	0.46 J	0.58 J	< 5	0.78 J
1,1-Dichloroethene	< 5	< 5	< 5	< 5	< 5	0.28 J	0.33 J	0.32 J	0.21 J	0.9 J
1,2-Dichloroethane	< 5	< 5	< 5	< 5	< 5	< 5	< 5	< 5	< 5	< 5
1,2-Dichloropropane	< 5	< 5	< 5	< 5	< 5	< 5	< 5	< 5	< 5	< 5
2-Butanone	< 50	< 50	< 50	< 50	< 50	< 50	< 50	< 50	< 50	< 50
2-Hexanone	< 50	< 50	< 50	< 50	< 50	< 50	< 50	< 50	< 50	< 50
4-methyl-2-pentanone	< 50	< 50	< 50	< 50	< 50	< 50	< 50	< 50	< 50	< 50
Acetone	31 J	< 50 B	< 50 B	< 50 B	< 50 B	< 50	< 50 B	< 50 B	< 50 B	3.9 J
Benzene	< 0.7	< 0.7	< 0.7	< 0.7	< 0.7	< 0.7	< 0.7	< 0.7	< 0.7	< 0.7
Bromodichloromethane	< 5	< 5	< 5	< 5	< 5	< 5	< 5	< 5	< 5	< 5
Bromoform	1.4 J	< 5	0.72 J	< 5	0.34 J	< 5	< 5	< 5	< 5	< 5
Bromomethane	< 5	< 5	< 5	< 5	< 5	< 5	< 5	< 5	< 5	< 5
Carbon Disulfide	< 5	< 5	< 5	< 5	< 5	< 5	< 5	< 5	< 5	< 5
Carbon Tetrachloride	< 5	< 5	< 5	< 5	< 5	< 5	< 5	< 5	< 5	< 5
Chlorobenzene	< 5	< 5	< 5	< 5	< 5	< 5	< 5	< 5	< 5	< 5
Chlorodifluoromethane (Freon 22)	< 5	< 5	< 5	< 5	< 5	< 5	< 5	< 5	< 5	< 5
Chloroethane	< 5	< 5	< 5	< 5	< 5	< 5	< 5	< 5	< 5	< 5
Chloroform	< 5	< 5	< 5	< 5	< 5	< 5	< 5	< 5	< 5	0.22 J
Chloromethane	< 5	< 5	< 5	< 5	< 5	< 5	< 5	< 5	< 5	< 5
cis-1,2-dichloroethene	< 5	< 5	< 5	< 5	< 5	0.43 J	0.44 J	0.83 J	0.26 J	1.9 J
cis-1,3-dichloropropene	< 5	< 5	< 5	< 5	< 5	< 5	< 5	< 5	< 5	< 5
Dibromochloromethane	0.43 J	< 5	0.2 J	< 5	< 5	< 5	< 5	< 5	< 5	< 5
Dichlorodifluoromethane (Freon 12)	< 5	< 5	< 5	< 5	< 5	< 5	< 5	< 5	< 5	< 5
Ethylbenzene	< 5	< 5	< 5	< 5	< 5	< 5	< 5	< 5	< 5	< 5
Methyl tert-Butyl Ether	< 5	< 5	< 5	< 5	< 5	< 5	< 5	< 5	< 5	< 5
Methylene Chloride	< 5	< 5	< 5	< 5	< 5	< 5	< 5	< 5	< 5	< 5
Styrene	< 5	< 5	< 5	< 5	< 5	< 5	< 5	< 5	< 5	< 5
Tetrachloroethene	< 5	< 5	< 5	< 5	0.28 J	1.4 J	0.82 J	1.4 J	1.6 J	13
Toluene	< 5	< 5	< 5	< 5	< 5	< 5	< 5	< 5	< 5	< 5
trans-1,2-dichloroethene	< 5	< 5	< 5	< 5	< 5	< 5	< 5	< 5	< 5	< 5
trans-1,3-dichloropropene	< 5	< 5	< 5	< 5	< 5	< 5	< 5	< 5	< 5	< 5
Trichloroethylene	< 5	< 5	< 5	0.64 J	4.1 J	16	13	27	4.9 J	11
Trichlorofluoromethane (CFC-11)	< 5	< 5	< 5	< 5	< 5	< 5	< 5	< 5	< 5	< 5
Trichlorotrifluoroethane (Freon 113)	< 5	< 5	< 5	0.67 J	0.59 J	2.3 J	1 J	2.3 J	0.26 J	2.8 J
Vinyl Chloride	< 2	< 2	< 2	< 2	< 2	< 2	< 2	< 2	< 2	0.32 J
Xylene-o	< 5	< 5	< 5	< 5	< 5	< 5	< 5	< 5	< 5	< 5
Xylenes - m,p	< 5	< 5	< 5	< 5	< 5	< 5	< 5	< 5	< 5	< 5
TVOCs	33	0	0.92	1.3	5.3	21	16	32	7.2	35

Notes and abbreviations on last page.

Table 1. Concentrations of Volatile Organic Compounds in Groundwater Samples Collected from Vertical Profile Borings,
On-Site Containment System Hydraulic Effectiveness Report, Operable Unit 2, Northrop Grumman Systems Corporation, Bethpage, New York.

Location ID	VP-03-1	VP-03-1	VP-03-1	VP-03-1	VP-03-1	VP-03-1	VP-03-1	VP-03-1	VP-03-1	VP-03-1
Sample Date	1/30/2012	1/30/2012	1/31/2012	2/1/2012	2/2/2012	2/6/2012	2/7/2012	2/10/2012	2/13/2012	3/14/2012
Sampling Depth or Interval (ft bls):	439	449	464	489	509	531	548	559	581	609-619
Constituent Name (units in ug/L)										
1,1,1-Trichloroethane	1.2 J	< 5	0.4 J	0.81 J	0.37 J	< 5	< 5	< 5	< 5	< 5
1,1,2,2-Tetrachloroethane	< 5	< 5	< 5	< 5	< 5	< 5	< 5	< 5	< 5	< 5
1,1,2-Trichloroethane	< 5	< 5	< 5	< 5	< 5	< 5	< 5	< 5	< 5	< 5
1,1-Dichloroethane	2.2 J	< 5	0.42 J	1.5 J	1.1 J	< 5	< 5	< 5	< 5	< 5
1,1-Dichloroethene	6.9	< 5	1.1 J	1.7 J	1 J	< 5	< 5	< 5	< 5	< 5
1,2-Dichloroethane	< 5	< 5	< 5	< 5	< 5	< 5	< 5	< 5	< 5	< 5
1,2-Dichloropropane	< 5	< 5	< 5	< 5	< 5	< 5	< 5	< 5	< 5	< 5
2-Butanone	< 50	< 50	< 50	< 50	< 50	< 50	< 50	< 50	< 50	< 50
2-Hexanone	< 50	< 50	< 50	< 50	< 50	< 50	< 50	< 50	< 50	< 50
4-methyl-2-pentanone	< 50	< 50	< 50	< 50	< 50	< 50	< 50	< 50	< 50	< 50
Acetone	3.4 J	4.6 J	< 50 B	< 50 B	< 50 B	< 50 B	< 50 B	< 50 B	< 50 B	< 50
Benzene	0.61 J	< 0.7 J	< 0.7	< 0.7	< 0.7	< 0.7	< 0.7	< 0.7	< 0.7	< 0.7
Bromodichloromethane	< 5	< 5	< 5	< 5	< 5	< 5	< 5	< 5	< 5	< 5
Bromoform	< 5	< 5	< 5	< 5	< 5	< 5	< 5	< 5	< 5	< 5
Bromomethane	< 5	< 5	< 5	< 5	< 5	< 5	< 5	< 5	< 5	< 5
Carbon Disulfide	< 5	< 5	< 5	< 5	< 5	< 5	< 5	< 5	< 5	< 5
Carbon Tetrachloride	< 5	< 5	< 5	< 5	< 5	< 5	< 5	< 5	< 5	< 5
Chlorobenzene	0.66 J	< 5 J	< 5	< 5	< 5	< 5	< 5	< 5	< 5	< 5
Chlorodifluoromethane (Freon 22)	< 5	0.49 J	< 5	< 5	< 5	0.85 J	0.58 J	0.98 J	0.69 J	0.75 J
Chloroethane	4.5 J	< 5	< 5	< 5	< 5	< 5	< 5	< 5	< 5	< 5
Chloroform	< 5	< 5	< 5	0.24 J	< 5	< 5	< 5	< 5	< 5	< 5
Chloromethane	< 5	< 5	< 5	< 5	< 5	< 5	< 5	< 5	< 5	< 5
cis-1,2-dichloroethene	13	< 5	2 J	22	13	< 5	< 5	< 5	< 5	< 5
cis-1,3-dichloropropene	< 5	< 5	< 5	< 5	< 5	< 5	< 5	< 5	< 5	< 5
Dibromochloromethane	< 5	< 5	< 5	< 5	< 5	< 5	< 5	< 5	< 5	< 5
Dichlorodifluoromethane (Freon 12)	< 5	< 5	< 5	< 5	< 5	< 5	< 5	< 5	< 5	< 5
Ethylbenzene	< 5	< 5	< 5	< 5	< 5	< 5	< 5	< 5	< 5	< 5
Methyl tert-Butyl Ether	< 5	< 5	< 5	< 5	< 5	< 5	< 5	< 5	< 5	< 5
Methylene Chloride	< 5	< 5	< 5	< 5	< 5	< 5	< 5	< 5	< 5	< 5
Styrene	< 5	< 5	< 5	< 5	< 5	< 5	< 5	< 5	< 5	< 5
Tetrachloroethene	150	1.3 J	17	140	33	< 5	< 5	< 5	< 5	< 5
Toluene	< 5	< 5 J	< 5	< 5	< 5	< 5	< 5	< 5	< 5	< 5
trans-1,2-dichloroethene	< 5	< 5	< 5	< 5	< 5	< 5	< 5	< 5	< 5	< 5
trans-1,3-dichloropropene	< 5	< 5	< 5	< 5	< 5	< 5	< 5	< 5	< 5	< 5
Trichloroethylene	240 D	0.83 J	26	320 D	160	< 5	< 5	< 5	< 5	< 5
Trichlorofluoromethane (CFC-11)	< 5	< 5	< 5	< 5	< 5	< 5	< 5	< 5	< 5	< 5
Trichlorotrifluoroethane (Freon 113)	6.2	46	1.7 J	0.29 J	< 5	< 5	< 5	< 5	< 5	< 5
Vinyl Chloride	170	< 2	0.43 J	< 2	< 2	< 2	< 2	< 2	< 2	< 2
Xylene-o	0.6 J	< 5	< 5	< 5	< 5	< 5	< 5	< 5	< 5	< 5
Xylenes - m,p	< 5	< 5	< 5	< 5	< 5	< 5	< 5	< 5	< 5	< 5
TVOCs	600	53	49	490	210	0.85	0.58	0.98	0.69	0.75

Notes and abbreviations on last page.

Table 1. Concentrations of Volatile Organic Compounds in Groundwater Samples Collected from Vertical Profile Borings,
On-Site Containment System Hydraulic Effectiveness Report, Operable Unit 2, Northrop Grumman Systems Corporation, Bethpage, New York.

Location ID	VP-03-1	VP-03-1	VP-03-1	VP-03-1	VP-33	VP-33	VP-33	VP-33	VP-33	VP-33	VP-33	VP-33
Sample Date	3/12/2012	3/12/2012	3/9/2012	3/7/2012	2/16/2012	2/20/2012	2/21/2012	2/21/2012	2/22/2012	2/22/2012	2/23/2012	2/23/2012
Sampling Depth or Interval (ft bls):	644-649	650-660	689-699	729-739	260	320	360	400	425	440	460	485
Constituent Name (units in ug/L)												
1,1,1-Trichloroethane	< 5	< 5	< 5	< 5	< 5	< 5	< 5	< 5	< 5	< 5	< 5	< 5
1,1,2,2-Tetrachloroethane	< 5	< 5	< 5	< 5	< 5	< 5	< 5	< 5	< 5	< 5	< 5	< 5
1,1,2-Trichloroethane	< 5	< 5	< 5	< 5	< 5	< 5	< 5	< 5	< 5	< 5	< 5	< 5
1,1-Dichloroethane	< 5	< 5	< 5	< 5	< 5	< 5	< 5	0.32 J	< 5	0.35 J	< 5	< 5
1,1-Dichloroethene	< 5	< 5	< 5	< 5	< 5	< 5	< 5	< 5	< 5	< 5	< 5	< 5
1,2-Dichloroethane	< 5	< 5	< 5	< 5	< 5	< 5	< 5	< 5	< 5	< 5	< 5	< 5
1,2-Dichloropropane	< 5	< 5	< 5	< 5	< 5	< 5	< 5	< 5	< 5	< 5	< 5	< 5
2-Butanone	< 50	< 50	< 50	< 50	< 50	< 50	< 50	< 50	< 50	< 50	< 50	2.7 J
2-Hexanone	< 50	< 50	< 50	< 50	< 50	< 50	< 50	< 50	< 50	< 50	< 50	< 50
4-methyl-2-pentanone	< 50	< 50	< 50	< 50	< 50	< 50	< 50	< 50	< 50	< 50	< 50	< 50
Acetone	< 50	< 50	< 50	< 50	< 50 B	6.2 J	5.8 J	4.5 J	< 50 B	< 50 B	5.4 J	17 J
Benzene	< 0.7	< 0.7	< 0.7	< 0.7	< 0.7	< 0.7	< 0.7	< 0.7	< 0.7	< 0.7	< 0.7	< 0.7
Bromodichloromethane	< 5	< 5	< 5	< 5	< 5	< 5	< 5	< 5	< 5	< 5	< 5	< 5
Bromoform	< 5	< 5	< 5	< 5	< 5	< 5	< 5	< 5	< 5	< 5	< 5	< 5
Bromomethane	< 5	< 5	< 5	< 5	< 5	< 5	< 5	< 5	< 5	< 5	< 5	< 5
Carbon Disulfide	< 5	< 5	< 5	< 5	< 5	< 5	< 5	< 5	< 5	< 5	< 5	0.24 J
Carbon Tetrachloride	< 5	< 5	< 5	< 5	< 5	< 5	< 5	< 5	< 5	< 5	< 5	< 5
Chlorobenzene	< 5	< 5	< 5	< 5	< 5	< 5	< 5	< 5	< 5	< 5	< 5	< 5
Chlorodifluoromethane (Freon 22)	0.25 J	0.26 J	< 5	< 5	< 5	< 5	< 5	< 5	< 5	< 5	< 5	< 5
Chloroethane	< 5	< 5	< 5	< 5	< 5	< 5	< 5	< 5	< 5	< 5	< 5	< 5
Chloroform	< 5	< 5	< 5	< 5	< 5	< 5	< 5	0.23 J	< 5	< 5	3 J	< 5
Chloromethane	< 5	< 5	< 5	< 5	< 5	< 5	< 5	< 5	< 5	< 5	< 5	< 5
cis-1,2-dichloroethene	< 5	< 5	< 5	< 5	< 5	< 5	< 5	< 5	< 5	< 5	0.23 J	< 5
cis-1,3-dichloropropene	< 5	< 5	< 5	< 5	< 5	< 5	< 5	< 5	< 5	< 5	< 5	< 5
Dibromochloromethane	< 5	< 5	< 5	< 5	< 5	< 5	< 5	< 5	< 5	< 5	< 5	< 5
Dichlorodifluoromethane (Freon 12)	< 5	< 5	< 5	< 5	< 5	< 5	< 5	< 5	< 5	< 5	< 5	< 5
Ethylbenzene	< 5	< 5	< 5	< 5	< 5	< 5	< 5	< 5	< 5	< 5	< 5	< 5
Methyl tert-Butyl Ether	< 5	< 5	< 5	< 5	< 5	< 5	< 5	< 5	< 5	< 5	0.53 J	< 5
Methylene Chloride	< 5	< 5	< 5	< 5	< 5	< 5 B	< 5	< 5	< 5	< 5 B	< 5 B	< 5 B
Styrene	< 5	< 5	< 5	< 5	< 5	< 5	< 5	< 5	< 5	< 5	< 5	< 5
Tetrachloroethene	< 5	< 5	< 5	< 5	< 5	< 5	< 5	< 5	0.28 J	0.33 J	< 5	0.43 J
Toluene	< 5	< 5	< 5	< 5	< 5	< 5	< 5	< 5	< 5	< 5	< 5	< 5
trans-1,2-dichloroethene	< 5	< 5	< 5	< 5	< 5	< 5	< 5	< 5	< 5	< 5	< 5	< 5
trans-1,3-dichloropropene	< 5	< 5	< 5	< 5	< 5	< 5	< 5	< 5	< 5	< 5	< 5	< 5
Trichloroethylene	< 5	< 5	< 5	< 5	0.37 J	6.6	0.48 J	2.1 J	3.2 J	8.1	5.6	4 J
Trichlorofluoromethane (CFC-11)	< 5	< 5	< 5	< 5	< 5	< 5	< 5	< 5	< 5	< 5	< 5	< 5
Trichlorotrifluoroethane (Freon 113)	< 5	< 5	< 5	< 5	< 5	< 5	< 5	< 5	< 5	< 5	< 5	< 5
Vinyl Chloride	< 2	< 2	< 2	< 2	< 2	< 2	< 2	< 2	< 2	< 2	< 2	< 2
Xylene-o	< 5	< 5	< 5	< 5	< 5	< 5	< 5	< 5	< 5	< 5	< 5	< 5
Xylenes - m,p	< 5	< 5	< 5	< 5	< 5	< 5	< 5	< 5	< 5	< 5	< 5	< 5
TVOCs	0.25	0.26	0	0	0.37	13	6.3	7.2	3.5	8.8	15	24

Notes and abbreviations on last page.

Table 1. Concentrations of Volatile Organic Compounds in Groundwater Samples Collected from Vertical Profile Borings,
On-Site Containment System Hydraulic Effectiveness Report, Operable Unit 2, Northrop Grumman Systems Corporation, Bethpage, New York.

Location ID	VP-33	VP-33	VP-33	VP-33	VP-33	VP-33	VP-33	VP-33	VP-33	VP-33	VP-33
Sample Date	2/24/2012	2/24/2012	2/24/2012	2/27/2012	2/28/2012	3/28/2012	2/29/2012	3/2/2012	3/5/2012	3/26/2012	3/12/2012
Sampling Depth or Interval (ft bls):	490	500	505	515	535	560 - 570	565	608	628	643 - 653	648
Constituent Name (units in ug/L)											
1,1,1-Trichloroethane	< 5	< 5	< 5	< 5	< 5	< 5	< 5	< 5	< 5	< 5	< 5
1,1,2,2-Tetrachloroethane	< 5	< 5	< 5	< 5	< 5	< 5	< 5	< 5	< 5	< 5	< 5
1,1,2-Trichloroethane	< 5	< 5	< 5	< 5	< 5	< 5	< 5	< 5	< 5	< 5	< 5
1,1-Dichloroethane	< 5	< 5	< 5	< 5	0.32 J	0.23 J	< 5	< 5	< 5	< 5	< 5
1,1-Dichloroethene	< 5	< 5	< 5	< 5	0.58 J	0.46 J	< 5	< 5	< 5	< 5	< 5
1,2-Dichloroethane	< 5	< 5	< 5	< 5	< 5	< 5	< 5	< 5	< 5	< 5	< 5
1,2-Dichloropropane	< 5	< 5	< 5	< 5	< 5	< 5	< 5	< 5	< 5	< 5	< 5
2-Butanone	< 50	< 50	< 50	< 50	< 50	< 50	< 50	< 50	< 50	< 50	< 50
2-Hexanone	< 50	< 50	< 50	< 50	< 50	< 50	< 50	< 50	< 50	< 50	< 50
4-methyl-2-pentanone	< 50	< 50	< 50	< 50	< 50	< 50	< 50	< 50	< 50	< 50	< 50
Acetone	1.9 J	13 J	11 J	4.8 J	19 J	< 50	< 50 B	4.9 J	12 J	< 50	16 J
Benzene	< 0.7	< 0.7	< 0.7	< 0.7	< 0.7	< 0.7	< 0.7	< 0.7	< 0.7	< 0.7	< 0.7
Bromodichloromethane	< 5	< 5	< 5	< 5	< 5	< 5	< 5	< 5	< 5	< 5	< 5
Bromoform	< 5	< 5	< 5	< 5	< 5	< 5	< 5	< 5	< 5	< 5	< 5
Bromomethane	< 5	< 5	< 5	< 5	< 5	< 5	< 5	< 5	< 5	< 5	< 5
Carbon Disulfide	< 5	< 5	0.21 J	0.26 J	< 5	< 5	< 5	< 5	< 5	< 5	< 5
Carbon Tetrachloride	< 5	< 5	< 5	< 5	< 5	< 5	< 5	< 5	< 5	< 5	< 5
Chlorobenzene	< 5	< 5	< 5	< 5	< 5	< 5	< 5	< 5	< 5	< 5	< 5
Chlorodifluoromethane (Freon 22)	< 5	< 5	< 5	< 5	< 5	0.26 J	< 5	< 5	< 5	0.22 J	< 5
Chloroethane	< 5	< 5	< 5	< 5	< 5	< 5	< 5	< 5	< 5	< 5	< 5
Chloroform	< 5	< 5	< 5	< 5	0.33 J	< 5	< 5	< 5	< 5	< 5	< 5
Chloromethane	< 5	< 5	< 5	< 5	< 5	< 5	< 5	0.32 J	< 5	< 5	< 5
cis-1,2-dichloroethene	< 5	< 5	< 5	< 5	1.5 J	0.81 J	< 5	< 5	< 5	< 5	< 5
cis-1,3-dichloropropene	< 5	< 5	< 5	< 5	< 5	< 5	< 5	< 5	< 5	< 5	< 5
Dibromochloromethane	< 5	< 5	< 5	< 5	< 5	< 5	< 5	< 5	< 5	< 5	< 5
Dichlorodifluoromethane (Freon 12)	< 5	< 5	< 5	< 5	< 5	< 5	< 5	< 5	< 5	< 5	< 5
Ethylbenzene	< 5	< 5	< 5	< 5	< 5	< 5	< 5	< 5	< 5	< 5	< 5
Methyl tert-Butyl Ether	< 5	< 5	< 5	< 5	< 5	< 5	< 5	< 5	< 5	< 5	< 5
Methylene Chloride	1.3 J	< 5	< 5	< 5	< 5	< 5	< 5	< 5	< 5	< 5	0.27 J
Styrene	< 5	< 5	< 5	< 5	< 5	< 5	< 5	< 5	< 5	< 5	< 5
Tetrachloroethene	0.87 J	< 5	0.37 J	1.2 J	6.4	12	0.26 J	< 5	< 5	< 5	< 5
Toluene	< 5	< 5	< 5	< 5	< 5	< 5	< 5 B	< 5	< 5	< 5 B	< 5 B
trans-1,2-dichloroethene	< 5	< 5	< 5	< 5	< 5	< 5	< 5	< 5	< 5	< 5	< 5
trans-1,3-dichloropropene	< 5	< 5	< 5	< 5	< 5	< 5	< 5	< 5	< 5	< 5	< 5
Trichloroethylene	14	1.2 J	2.2 J	12	530 D	19	4.2 J	< 5	1.2 J	< 5	0.61 J
Trichlorofluoromethane (CFC-11)	< 5	< 5	< 5	< 5	< 5	< 5	< 5	< 5	< 5	< 5	< 5
Trichlorotrifluoroethane (Freon 113)	0.28 J	< 5	0.29 J	1.1 J	4.8 J	3.6 J	< 5	< 5	< 5	< 5	< 5
Vinyl Chloride	< 2	< 2	< 2	< 2	< 2	< 2	< 2	< 2	< 2	< 2	< 2
Xylene-o	< 5	< 5	< 5	< 5	< 5	< 5	< 5	< 5	< 5	< 5	< 5
Xylenes - m,p	< 5	< 5	< 5	< 5	< 5	< 5	< 5	< 5	< 5	< 5	< 5
TVOCs	18	14	14	19	560	36	4.5	4.9	14	0.22	17

Notes and abbreviations on last page.

Table 1. Concentrations of Volatile Organic Compounds in Groundwater Samples Collected from Vertical Profile Borings,
On-Site Containment System Hydraulic Effectiveness Report, Operable Unit 2, Northrop Grumman Systems Corporation, Bethpage, New York.

Location ID	VP-73R	VP-73R	VP-73R	VP-73R	VP-73R	VP-73R	VP-73R	VP-73R
Sample Date	12/29/2011	12/30/2011	12/30/2011	1/3/2012	1/4/2012	1/5/2012	1/5/2012	1/6/2012
Sampling Depth or Interval (ft bls):	406	426	446	466	481	501	526	541
Constituent Name (units in ug/L)								
1,1,1-Trichloroethane	< 5	< 5	< 10	< 5	< 5	< 5	0.28 J	0.32 J
1,1,2,2-Tetrachloroethane	< 5	< 5	< 10	< 5	< 5	< 5	< 5	< 5
1,1,2-Trichloroethane	< 5	< 5	< 10	< 5	< 5	< 5	< 5	< 5
1,1-Dichloroethane	< 5	< 5	0.5 J	0.26 J	< 5	< 5	0.83 J	0.47 J
1,1-Dichloroethene	< 5	< 5	0.5 J	< 5	< 5	< 5	0.43 J	1.3 J
1,2-Dichloroethane	< 5	< 5	< 10	< 5	< 5	< 5	< 5	< 5
1,2-Dichloropropane	< 5	< 5	< 10	< 5	< 5	< 5	< 5	< 5
2-Butanone	< 50	< 50	< 100	< 50	< 50	< 50	< 50	< 50
2-Hexanone	< 50	< 50	< 100	< 50	< 50	< 50	< 50	< 50
4-methyl-2-pentanone	< 50	< 50	< 100	< 50	< 50	< 50	< 50	< 50
Acetone	< 50 B	< 50 B	< 100 B	< 50 B	< 50 B	< 50 B	< 50 B	2.8 J
Benzene	< 0.7	< 0.7	< 1.4	< 0.7	< 0.7	< 0.7	< 0.7	< 0.7
Bromodichloromethane	< 5	< 5	< 10	< 5	< 5	< 5	< 5	< 5
Bromoform	< 5	< 5	< 10	< 5	< 5	< 5	< 5	< 5
Bromomethane	< 5	< 5	< 10	< 5	< 5	< 5	< 5	< 5
Carbon Disulfide	< 5	< 5	< 10	< 5	< 5	< 5	< 5	< 5
Carbon Tetrachloride	< 5	< 5	< 10	< 5	< 5	< 5	< 5	< 5
Chlorobenzene	< 5	< 5	< 10	< 5	< 5	< 5	< 5	< 5
Chlorodifluoromethane (Freon 22)	< 5	< 5	< 10	< 5	< 5	< 5	< 5	0.42 J
Chloroethane	< 5	< 5	< 10	< 5	< 5	< 5	< 5	< 5
Chloroform	< 5	< 5	< 10	< 5	< 5	< 5	< 5	0.23 J
Chloromethane	< 5	< 5	< 10	< 5	< 5	< 5	< 5	< 5
cis-1,2-dichloroethene	< 5	< 5	0.58 J	0.2 J	< 5	< 5	< 5	0.72 J
cis-1,3-dichloropropene	< 5	< 5	< 10	< 5	< 5	< 5	< 5	< 5
Dibromochloromethane	< 5	< 5	< 10	< 5	< 5	< 5	< 5	< 5
Dichlorodifluoromethane (Freon 12)	< 5	< 5	< 10	< 5	< 5	< 5	< 5	0.21 J
Ethylbenzene	< 5	< 5	< 10	< 5	< 5	< 5	< 5	< 5
Methyl tert-Butyl Ether	< 5	< 5	< 10	< 5	< 5	< 5	< 5	< 5
Methylene Chloride	< 5	< 5	< 10	< 5	< 5	< 5	< 5	< 5
Styrene	< 5	< 5	< 10	< 5	< 5	< 5	< 5	< 5
Tetrachloroethene	0.29 J	< 5	1.4 J	0.36 J	0.21 J	0.25 J	0.61 J	3.5 J
Toluene	< 5	< 5	< 10	< 5 B	< 5	< 5	< 5	< 5
trans-1,2-dichloroethene	< 5	< 5	< 10	< 5	< 5	< 5	< 5	< 5
trans-1,3-dichloropropene	< 5	< 5	< 10	< 5	< 5	< 5	< 5	< 5
Trichloroethylene	45	15	260	110 J	30	22	25	51
Trichlorofluoromethane (CFC-11)	< 5	< 5	< 10	< 5	< 5	< 5	< 5	0.45 J
Trichlorotrifluoroethane (Freon 113)	< 5	< 5	< 10	< 5	< 5	< 5	< 5	0.61 J
Vinyl Chloride	< 2	< 2	< 4	< 2	< 2	< 2	< 2	< 2
Xylene-o	< 5	< 5	< 10	< 5	< 5	< 5	< 5	< 5
Xylenes - m,p	< 5	< 5	< 10	< 5	< 5	< 5	< 5	< 5
TVOCs	45	15	260	110	30	22	27	62

Notes and abbreviations on last page.

Table 1. Concentrations of Volatile Organic Compounds in Groundwater Samples Collected from Vertical Profile Borings,
On-Site Containment System Hydraulic Effectiveness Report, Operable Unit 2, Northrop Grumman Systems Corporation, Bethpage, New York.

Location ID	VP-73R	VP-73R	VP-73R	VP-73R
Sample Date	1/9/2012	1/9/2012	1/10/2012	1/10/2012
Sampling Depth or Interval (ft bls):	571	581	601	621
Constituent Name (units in ug/L)				
1,1,1-Trichloroethane	< 5	0.23 J	< 5	< 5
1,1,2,2-Tetrachloroethane	< 5	< 5	< 5	< 5
1,1,2-Trichloroethane	< 5	< 5	< 5	< 5
1,1-Dichloroethane	< 5	< 5	< 5	< 5
1,1-Dichloroethene	0.25 J	0.81 J	0.61 J	< 5
1,2-Dichloroethane	< 5	< 5	< 5	< 5
1,2-Dichloropropane	< 5	< 5	< 5	< 5
2-Butanone	< 50	< 50	< 50	< 50
2-Hexanone	< 50	< 50	< 50	< 50
4-methyl-2-pentanone	< 50	< 50	< 50	< 50
Acetone	7.7 J	3.4 J	< 50 B	< 50 B
Benzene	< 0.7	< 0.7	< 0.7	< 0.7
Bromodichloromethane	< 5	< 5	< 5	< 5
Bromoform	< 5	< 5	< 5	< 5
Bromomethane	< 5	< 5	< 5	< 5
Carbon Disulfide	< 5	< 5	< 5	< 5
Carbon Tetrachloride	0.23 J	< 5	< 5	< 5
Chlorobenzene	< 5	< 5	< 5	< 5
Chlorodifluoromethane (Freon 22)	< 5	0.4 J	0.71 J	< 5
Chloroethane	< 5	< 5	< 5	< 5
Chloroform	< 5	< 5	< 5	< 5
Chloromethane	< 5	< 5	< 5	< 5
cis-1,2-dichloroethene	< 5	0.33 J	0.24 J	< 5
cis-1,3-dichloropropene	< 5	< 5	< 5	< 5
Dibromochloromethane	< 5	< 5	< 5	< 5
Dichlorodifluoromethane (Freon 12)	< 5	< 5	< 5	< 5
Ethylbenzene	< 5	< 5	< 5	< 5
Methyl tert-Butyl Ether	< 5	< 5	< 5	< 5
Methylene Chloride	< 5	< 5	< 5	< 5
Styrene	< 5	< 5	< 5	< 5
Tetrachloroethene	5.8	16	9.3	1.7 J
Toluene	< 5	< 5	< 5	< 5
trans-1,2-dichloroethene	< 5	< 5	< 5	< 5
trans-1,3-dichloropropene	< 5	< 5	< 5	< 5
Trichloroethylene	6.9	11	8.5	1.8 J
Trichlorofluoromethane (CFC-11)	< 5	0.24 J	0.3 J	< 5
Trichlorotrifluoroethane (Freon 113)	0.34 J	1.7 J	1.1 J	0.26 J
Vinyl Chloride	< 2	< 2	< 2	< 2
Xylene-o	< 5	< 5	< 5	< 5
Xylenes - m,p	< 5	< 5	< 5	< 5
TVOCs	21	34	21	3.8

Notes and abbreviations on last page.

Table 1. Concentrations of Volatile Organic Compounds in Groundwater Samples Collected from Vertical Profile Borings,
On-Site Containment System Hydraulic Effectiveness Program, Operable Unit 2, Northrop Grumman Systems Corporation, Bethpage, New York.

Notes and Abbreviations:

Results validated following protocols specified in OU2 Groundwater Monitoring Plan (ARCADIS 2001; 2006).

Samples analyzed for the TCL VOCs using NYSDEC ASP 2000 Method OLM4.3.

TVOCs are rounded to two significant figures.

Bold value indicates a detection.

NYSDEC New York State Department of Environmental Conservation

TCL Target compound list

VOC Volatile Organic Compound

TVOC Total Volatile Organic Compounds

ASP Analytical services protocol

ug/L Micrograms per liter

ft bls feet below land surface

J Value is estimated

B Compound detected in associated blank sample

D Secondary dilution



Table 2. Concentrations of Volatile Organic Compounds in Groundwater Samples Collected from Monitoring Wells, On-Site Containment System Hydraulic Effectiveness Program, Operable Unit 2, Northrop Grumman Systems Corporation, Bethpage, New York.

	Location ID: GM-73D3	MW-3-1
	Sample Date: 2/21/2012	3/28/2012
Constituent Name (units in ug/L)		
1,1,1-Trichloroethane	< 10	< 50
1,1,2,2-Tetrachloroethane	< 10	< 50
1,1,2-Trichloroethane	< 10	< 50
1,1-Dichloroethane	< 10	< 50
1,1-Dichloroethene	< 10	2.6 J
1,2-Dichloroethane	< 10	< 50
1,2-Dichloropropane	< 10	< 50
2-Butanone	< 10	< 500
2-Hexanone	< 10	< 500
4-methyl-2-pentanone	< 10	< 500
Acetone	< 10	< 500
Benzene	< 10	< 7
Bromodichloromethane	< 10	< 50
Bromoform	< 10	< 50
Bromomethane	< 10	< 50
Carbon Disulfide	< 10	< 50
Carbon Tetrachloride	< 10	< 50
Chlorobenzene	< 10	2.1 J
Chlorodifluoromethane (Freon 22)	< 10	< 50
Chloroethane	< 10	40 J
Chloroform	< 10	< 50
Chloromethane	< 10	< 50
cis-1,2-dichloroethene	< 10	31 J
cis-1,3-dichloropropene	< 10	< 50
Dibromochloromethane	< 10	< 50
Dichlorodifluoromethane (Freon 12)	< 10	< 50
Ethylbenzene	< 10	< 50
Methyl tert-Butyl Ether	< 10	< 50
Methylene Chloride	< 10	< 50
Styrene	< 10	< 50
Tetrachloroethene	< 10	56
Toluene	< 10	8.7 J
trans-1,2-dichloroethene	< 10	< 50
trans-1,3-dichloropropene	< 10	< 50
Trichloroethylene	< 10	220
Trichlorofluoromethane (CFC-11)	< 10	< 50
Trichlorotrifluoroethane (Freon 113)	< 10	< 50
Vinyl Chloride	< 10	1300
Xylene-o	< 10	< 50
Xylenes - m,p	< 10	< 50
TVOCs	0	1700

Notes and Abbreviations:

Results validated following protocols specified in OU2 Groundwater Monitoring Plan (ARCADIS 2001; 2006).

Samples analyzed for the TCL VOCs using NYSDEC ASP 2000 Method OLM4.3.

TVOCs are rounded to two significant figures.

Bold value indicates a detection.

NYSDEC New York State Department of Environmental Conservation

TCL Target compound list

VOC Volatile Organic Compound

TVOC Total Volatile Organic Compounds

ASP Analytical services protocol





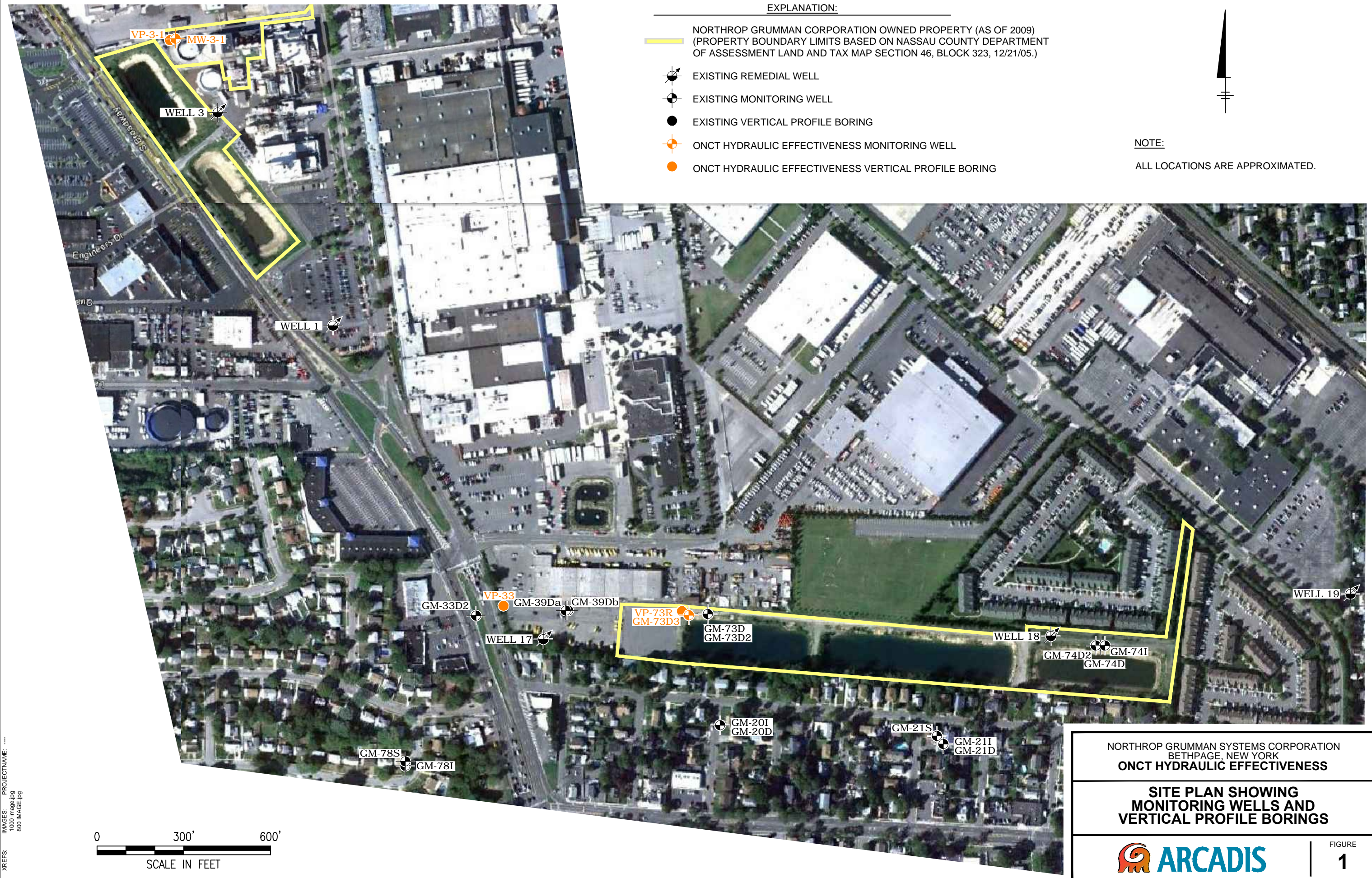

ug/L Micrograms per liter

J Value is estimated

CITY: MELVILLE, NY DIV: GROUP: ENV DBA: SANCHEZ LD/AS: PIC: J.PERSICO P/MC: SAN GIOVANNI TMM: REINDL L/R: (OPTION: OFF) REF: V:\NY1\FP1\Data\EN\CAD\Melville-NY\ACT\NY001496\021\ONC\B6\ONC-InterimReport.dwg LAYOUT: 1 SAVED: 5/18/2012 3:03 PM ACADVER: 18.1S (LMS TECH) PAGES: 18 PAGES SETUP: PLOTSTYLETABLE: PLOTTED: 5/23/2012 9:35 AM BY: SANCHEZ, ADRIAN



EXPLANATION:

-  NORTHROP GRUMMAN CORPORATION OWNED PROPERTY (AS OF 2009) (PROPERTY BOUNDARY LIMITS BASED ON NASSAU COUNTY DEPARTMENT OF ASSESSMENT LAND AND TAX MAP SECTION 46, BLOCK 323, 12/21/05.)
-  EXISTING REMEDIAL WELL
-  EXISTING MONITORING WELL
-  EXISTING VERTICAL PROFILE BORING
-  ONCT HYDRAULIC EFFECTIVENESS MONITORING WELL
-  ONCT HYDRAULIC EFFECTIVENESS VERTICAL PROFILE BORING

NOTE:
ALL LOCATIONS ARE APPROXIMATED.

NORTHROP GRUMMAN SYSTEMS CORPORATION
BETHPAGE, NEW YORK
ONCT HYDRAULIC EFFECTIVENESS

**SITE PLAN SHOWING
MONITORING WELLS AND
VERTICAL PROFILE BORINGS**



FIGURE
1

ATTACHMENT A

WELL CONSTRUCTION LOGS

MW3-1

GM73-D3

Well Construction Log
(Unconsolidated)

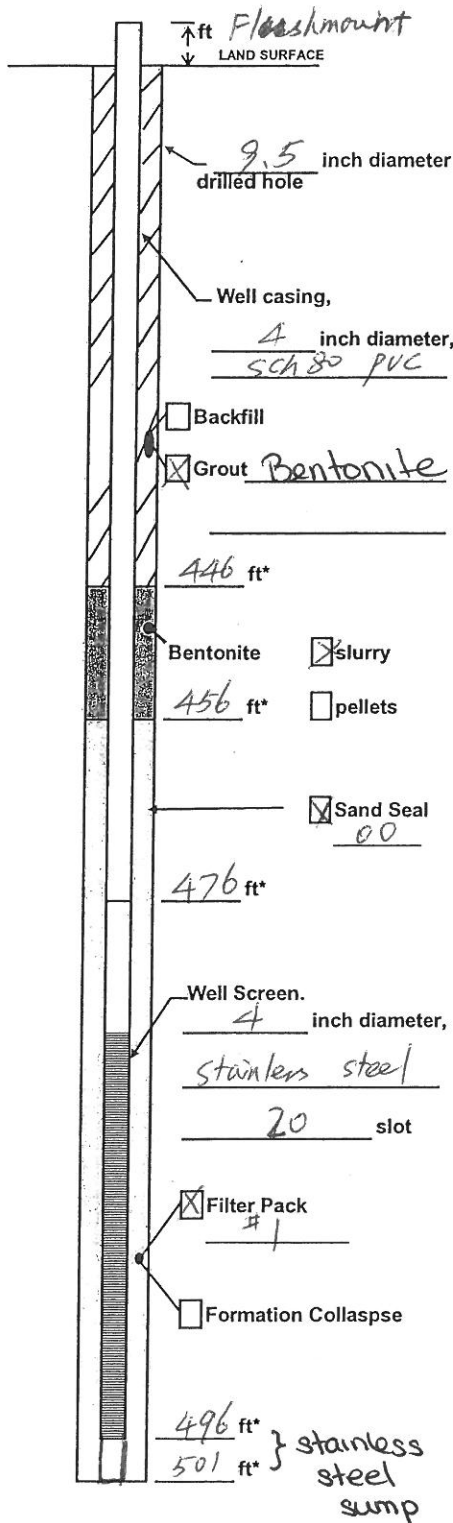

Project Name and No. ARC GP3R / NY001496.0312.OMM-14

Well MW3-1 Town/City Bethpage

County Nassau State NY

Permit No. N-14026

Land-Surface Elevation and Datum:
120 feet Surveyed Estimated

Installation Date(s) 3/20 - 3/22/12

Drilling Method mud-rotary

Drilling Contractor Delta Well & pump Co.

Drilling Fluid mud / Bentonite + water

Development Technique(s) and Date(s)
air-lifting / water jetting & pumping / pump & surge
3/26/12 - 3/27/12

Fluid Loss During Drilling _____ gallons

Water Removed During Development 15000 gallons

Static Depth to Water 55.75 feet below M.P.**

Pumping Depth to Water 57.34 feet below M.P.**

Pumping Duration 3/4 hours

Yield 10 gpm Date 3/27/12

Specific Capacity 7.3 gpm/ft

Well Purpose monitoring well

Remarks 5ft stainless steel sump

* Depth Below Land Surface

**Measuring Point is Top of Well Casing Unless Otherwise Noted.

Prepared by Sunny Xu

Well Construction Log
(Unconsolidated)

NY001496.0212.ONCB5

Project Name and No. Northrop Grumman ONCT Hydraulic Effective

Well GM-73D3 Town/City Bethpage

County Nassau State NY

Permit No. N-14025

Land-Surface Elevation and Datum:

120 feet Surveyed
 Estimated

Installation Date(s) 1/20/12

Drilling Method mud rotary

Drilling Contractor Delta Well and Pump

Drilling Fluid Bentonite and water

Development Technique(s) and Date(s)

air lift 2/3/12 - 2/8/12
water jetting 2/21/12

Fluid Loss During Drilling — gallons

Water Removed During Development 3,000 gallons

Static Depth to Water 40.43 feet below M.P.**

Pumping Depth to Water 44.08 feet below M.P.**

Pumping Duration — hours

Yield — gpm Date —

Specific Capacity — gpm/ft

Well Purpose mounting well

Remarks

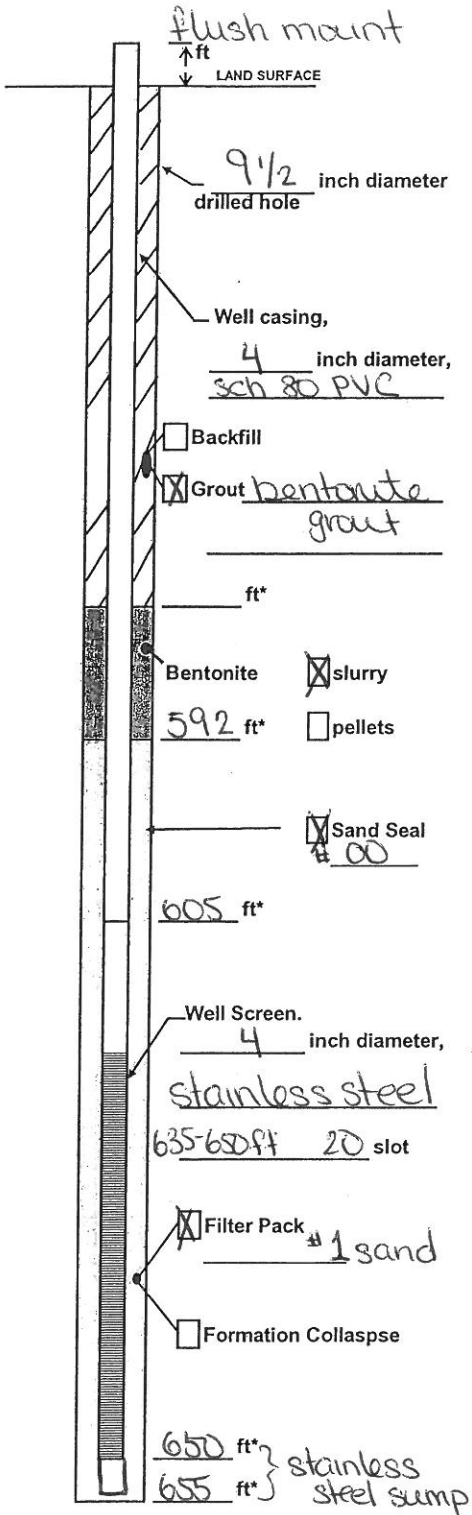

* Depth Below Land Surface

**Measuring Point is Top of Well Casing Unless Otherwise Noted.

Prepared by Andrea Caputo