



**Interim Remedial Measure No. 1
Scope of Work - Building Demolition
Former Admiral Cleaners Site (No. 401075)**

**City of Watervliet
Albany County, New York**

Prepared for

New York State Department of Environmental Conservation
Division of Environmental Remediation
Remedial Bureau E
625 Broadway
Albany, New York 12233-7017



Prepared by

EA Engineering, P.C and Its Affiliate
EA Science and Technology
269 W. Jefferson Street
Syracuse, New York 13020
(315) 431-4610

April 2019
Version: FINAL
EA Project No. 14907.38

This page intentionally left blank

**Interim Remedial Measure No. 1
Scope of Work - Building Demolition
Former Admiral Cleaners Site (No. 401075)**

**City of Watervliet
Albany County, New York**

Prepared for

New York State Department of Environmental Conservation
Division of Environmental Remediation
Remedial Bureau E
625 Broadway
Albany, New York 12233-7017



Prepared by

EA Engineering, P.C and Its Affiliate
EA Science and Technology
269 W. Jefferson Street
Syracuse, New York 13020
(315) 431-4610

A handwritten signature in black ink, appearing to read "Donald Conan".

12 April 2019

Donald Conan, P.E., P.G.
Vice President, EA Engineering, P.C.

A handwritten signature in black ink, appearing to read "Christopher Schroer".

12 April 2019

Christopher Schroer
Project Manager, EA Science and Technology

April 2019
Version: FINAL
EA Project No. 14907.38

This page intentionally left blank

TABLE OF CONTENTS

	<u>Page</u>
LIST OF FIGURES	ii
LIST OF TABLES	ii
LIST OF ACRONYMS AND ABBREVIATIONS	iii
1. INTRODUCTION	1
1.1 SITE DESCRIPTION	1
1.2 SITE HISTORY	1
2. PRE-INTERIM REMEDIAL MEASURE BUILDING CHARACTERIZATION.....	3
2.1 ASBESTOS SURVEY.....	3
2.2 BUILDING MEASUREMENT AND QUANTITY ESTIMATE.....	4
2.3 EMERGENCY STRUCTURAL CONDITION ASSESSMENT.....	4
2.4 SITE SURVEY	5
3. INTERIM REMEDIAL MEASURE DESIGN	7
3.1 INTERIM REMEDIAL MEASURE NO. 1 DESCRIPTION	7
3.1.1 Building Demolition	7
3.1.2 Construction Completion Report	7
3.2 DEMOLITION DESIGN ASSUMPTIONS	7
3.3 ROLES AND RESPONSIBILITIES	8
3.3.1 New York State Department of Environmental Conservation	8
3.3.2 EA Engineering, P.C. and its affiliate EA Science and Technology	8
3.3.3 Precision Environmental Services	9
3.4 THIRD PARTY ASBESTOS MONITORING	9
3.5 PERMITTING PLAN/PERMITS	10
3.6 SITE RESTORATION	10
4. PROJECT CONTACTS.....	11
5. REFERENCES	13
APPENDIX A: ASBESTOS SURVEY RESULTS	
APPENDIX B: DRAWING PACKAGE	
APPENDIX C: EMERGENCY STRUCTURAL CONDITION ASSESSMENT	
APPENDIX D: PROJECT RESPONSIBILITIES FOR ADMIRAL CLEANERS SITE	
INTERIM REMEDIAL MEASURE	

LIST OF FIGURES

<u>Number</u>	<u>Title</u>
1	Site Location
2	Site Layout

LIST OF TABLES

<u>Number</u>	<u>Title</u>
1	Summary of ACM in Admiral Cleaners Building
2	Summary of Material Quantities
3	Project Roles and Contact Information

LIST OF ACRONYMS AND ABBREVIATIONS

ACM	Asbestos containing material
CCR	Construction Completion Report
C&D	Construction and demolition
Chazen	Chazen Companies
CVOC	Chlorinated volatile organic compound
EA	EA Engineering, P.C. and its affiliate EA Science and Technology
FS	Feasibility study
ft	Foot (feet)
in.	Inch(es)
IRM	Interim remedial measure
No.	Number
NYSDEC	New York State Department of Environmental Protection
LF	Linear feet
PCE	Tetrachloroethene
P.E.	Professional Engineer
P.G.	Professional Geologist
PES	Precision Environmental Services
ppm	Parts per million
RI	Remedial investigation
SF	Square feet
SOW	Scope of work
UST	Underground storage tank
VOC	Volatile organic compound

This page left intentionally blank

1. INTRODUCTION

EA Engineering, P.C. and its affiliate EA Science and Technology (EA) was tasked by the New York State Department of Environmental Conservation (NYSDEC) under Work Assignment Number (No.) D007624-38 to plan and oversee two Interim Remedial Measures (IRM) at the Admiral Cleaners Site (No. 401075) in the City of Watervliet, Albany County, New York (**Figure 1**). The IRMs are being implemented to facilitate the remedial investigation (RI) and feasibility study (FS) process.

IRM No. 1 includes demolition of the onsite structure. The onsite structure has been determined to be a hazard to public safety, and demolition of the building is necessary to complete RI activities. IRM No. 2 includes delineation of a suspected subsurface source area, closure/removal of an underground storage tank (UST), and a removal action of impacted soil. A separate Scope of Work (SOW) will be prepared and submitted to NYSDEC for IRM No. 2.

This document provides a SOW, site drawings, and health and safety (including asbestos management and monitoring) requirements associated with IRM No. 1.

1.1 SITE DESCRIPTION

The site is a rectangular parcel totaling 0.11 acre located at 617 19th Street, Watervliet, Albany County, New York (**Figures 1 and 2**), between 6th Avenue and 7th Avenue. The parcel has approximately 50 feet (ft) of frontage on 19th Street and a depth of approximately 100 ft. The site consists of a vacant brick and concrete block commercial building with its slab on grade. The building comprises approximately 75 percent of the parcel, and a small grassy area is located behind the building, which is partially enclosed by wooden and chain-link fences. The site is in an urban area with mixed commercial and residential use. The site is bordered by an unoccupied residential building to the west, a mixed-use building containing a commercial day care and residences to the east, and residences to the north (**Figure 2**). A structural assessment conducted by a civil-structural engineer contracted by the City of Watervliet in February 2019 led the City to consider the building a hazard to public safety and recommend it for demolition. Further details of the building's structural condition can be found in Section 2.

1.2 SITE HISTORY

The building was constructed in 1950 and was used as a dry cleaning facility until 2013. During its operation, the facility used tetrachloroethene (PCE) as a cleaning solvent. In 2007, NYSDEC executed a Consent Order, requiring the facility to obtain required owner/manager and operator dry cleaning certifications. In November 2008, a third-party inspection indicated that the PCE concentration in the facility's dry-cleaning machine was 845 parts per million (ppm), approximately three times the limit of 300 ppm published in 6 New York Codes Rules and Regulations 232.6(a)(6). NYSDEC performed a follow-up inspection in February 2009, discovering that the facility had failed to comply with the 2007 Consent Order and had not performed the mandatory remedy within the required timeframe following the 2008 inspection. NYSDEC also found evidence of improper disposal of PCE-contaminated wastes (NYSDEC 2009). Another Consent Order was executed in April 2009 to address the violations noted in the

2009 inspection. Dry cleaning operations ceased in 2013 due to continued violations of environmental regulations. In addition, NYSDEC opened a Spill Record at the site in 2013 after observing improperly stored hazardous waste during an inspection. NYSDEC subsequently removed hazardous waste (e.g., drums containing spent chemicals) from the facility and the spill was closed not meeting standards in 2013.

The site was then operated as a dry-cleaning drop shop, where garments were brought in and sent to be dry cleaned at another local facility, until 2017. The Chazen Companies (Chazen) performed a limited subsurface investigation at the Site in April 2016 as part of a potential real estate transaction (Chazen 2016). The investigation identified petroleum-related volatile organic compounds (VOCs) and chlorinated VOCs (CVOCs) in soil, groundwater, and sub-slab soil vapor at the site. The non-chlorinated hydrocarbons may not be gasoline-related, but a result of petroleum-based solvent use, (e.g., Stoddard solvent). NYSDEC was provided the findings and the site was listed in the NYSDEC Registry of Inactive Hazardous Waste Disposal Sites as a Class 2 site in August 2017 (NYSDEC 2017).

2. PRE-INTERIM REMEDIAL MEASURE BUILDING CHARACTERIZATION

The following pre-IRM characterization design investigation activities were performed from September 2018 to March 2019 to evaluate existing onsite conditions and survey the building in support of the IRM design:

- Asbestos survey
- Building measurement and demolition debris quantity estimate
- Emergency structural condition assessment
- Site survey of adjacent structures, property boundaries and roadways.

A structural assessment of adjacent properties will be completed as part of, and prior to, the commencement of demolition activities.

2.1 ASBESTOS SURVEY

The Asbestos Survey was completed by Spectrum Environmental Associates under contract to Precision Environmental Services (PES). Suspected asbestos containing material (ACM) was sampled in September 2018 and submitted to Spectrum Analytical for analysis. The survey identified ACM including but not limited to 9-inch (in.) by 9-in. mastic floor tiles, boiler room ceiling panels, caulking, air cell pipe insulation, and roofing material/sealant. A summary of observed ACM and estimated quantities is presented as **Table 1**. The full inspection report is included as **Appendix A**.

Table 1 Summary of ACM in Admiral Cleaners Building

Material	Location/Area	Estimated Quantity ¹	Condition/Damaged
9x9 Mastic	Front of store under carpet	Approximately 400 SF	Poor
9x9 Gray			
9x9 Red			
Ceiling panels	Boiler room ceiling	Approximately 120 SF	Poor
Caulk	Exterior metal door frame	Approximately 30 LF	Poor
Air cell pipe insulation ²	Long pipe across store front and floor	60 LF	Poor
Pipe elbow insulation	Elbow on pipe with air cell	2 each	Poor
Parapet wall roofing material	Along east side parapet wall	3,150 SF	Poor
Parapet wall roofing sealer			
1. ACM quantities are estimates only and should be field verified by the remedial contractor 2. Due to disturbance of air cell pipe insulation exceeding 10 SF, a site-specific variance will be required for cleanup of the material. NOTES: LF = Linear feet SF = Square feet			

2.2 BUILDING MEASUREMENT AND QUANTITY ESTIMATE

Concurrent with the September 2018 asbestos survey, EA collected detailed building measurements for the purpose of identifying building material disposal quantities and preparing an engineering cost estimate. The Admiral Cleaners building is a single-story building constructed on grade primarily of four materials that will require offsite disposal. These include but are not limited to, concrete/brick masonry, concrete floor slab, structural steel I-beams, and wood.

The eastern half of the building was first constructed in 1950 and includes three smaller rooms divided by masonry walls. The boiler room, located along the north wall of the building, has a slab depressed approximately 15 in. below grade. The eastern portion of the building is approximately 28 ft wide, 72 ft long, and 12 ft tall (**Appendix B: Drawings**). The western portion of the building was constructed as an addition to the original structure and has the approximate dimensions of 20 ft wide, 72 ft long, and 13.75 ft tall. Total building footprint is approximately 48 ft by 72 ft with a slab averaging approximately 5 in. thick.

Exterior and interior walls are all constructed by concrete/brick masonry. Structural steel I-beams span steel and block columns from west to east. The roof is constructed of wooden beams and decking covered by rolled asphalt roofing, sealant, flashing, and terra cotta tiles. As described in Section 2.1, a portion of roofing material was identified as ACM.

Dry cleaning presses, washers, and various machinery still exist within the building. Overhead steel racks/conveyors are mounted to the ceiling and have begun to fall, posing an overhead hazard.

To accurately estimate material quantities, the thickness, length, and height of all exterior and interior walls were measured, as were the thickness and areal dimensions of the concrete floor slabs throughout the structure. It is estimated that there is approximately 354 tons of construction and demolition (C&D) material for disposal. Drawings showing building measurements and layout are provided as **Appendix B**. A summary of materials and estimated quantities is presented in **Table 2**.

Table 2 Summary of Material Quantities

Material		Quantity (tons)	Expected Waste Stream
ACM	9x9 tiles, ceiling panels, roofing materials, caulk, pipe insulation	9	C&D (Asbestos)
C&D	Lumber, sheetrock, plywood, glass	15	
Concrete/masonry	Brick and cinderblock	320	
Metal	Structural steel (I-beams), dry cleaning equipment/machinery, boiler	10	Metal recycling

2.3 EMERGENCY STRUCTURAL CONDITION ASSESSMENT

R. Russell Reeves, Professional Engineer (P.E.), a civil-structural engineer contracted by the City of Watervliet, met with Code Enforcement Officer Paul LaBoissiere and NYSDEC Project

Manager, Josh Haugh. to evaluate the Admiral Cleaners building structure as it relates to public safety. The full report of that evaluation is provided as **Appendix C**.

A deteriorating roof structure and damaged concrete block bearing walls along the northeastern and northwestern corners of the building indicate that a localized collapse of the roof and wall is imminent. The northwestern rear wall of the western addition to the original building is separating from the original block bearing wall and is in rotational failure. Equipment and piping mounted to the roof are no longer adequately secured due to the deterioration of the roof framing and are in pull-out mode of failure. The structural engineer concluded that there is a substantial hazard within the building for failure of the overhead devices. Additionally, roof framing members and the steel beam and column assembly along the center of the building were improperly installed and are structurally deficient.

The report concluded that a collapse of the roof or north bearing wall will cause the entire building to become destabilized, causing at least a partial collapse of the beam/column assembly located between the original building footprint and the addition. The structure is currently considered a hazard to public safety and was recommended for demolition as soon as practicable by the City of Watervliet.

The structural integrity of the existing building is a significant health and safety issue and prevents further intrusive RI work required to delineate the nature and extent of impacts to subsurface soil and groundwater.

2.4 SITE SURVEY

A site survey was completed by Popli Design Group on 12–13 March 2019 to survey the Admiral Cleaners site property boundary and boundaries of adjacent parcels. Survey data was incorporated into the drawing package provided in **Appendix B**.

This page left intentionally blank

3. INTERIM REMEDIAL MEASURE DESIGN

3.1 INTERIM REMEDIAL MEASURE NO. 1 DESCRIPTION

The following is a description of the tasks associated with IRM No. 1.

3.1.1 Building Demolition

Building demolition implementation will be completed by NYSDEC call-out contractor PES, and EA will provide dedicated onsite construction management. The demolition will consist of site preparation, disconnecting all utilities, and removing the site building to grade. Additionally, a utility pole located to the northeast of the property along the alley will be relocated by National Grid prior to site activities (**Figure 2**). Site preparation activities include, but are not limited to, clearing and grubbing; removing fencing around the northern end of the property; and establishing site logistics, truck routing, and safety zones. Demolition will be completed, while monitoring and protecting adjacent structures, roadways, and pedestrians.

Dry cleaning machinery left within the building will be drained and decontaminated of potentially hazardous materials prior to demolition. Non-hazardous building materials, including ACM will be disposed offsite as C&D debris. ACM abatement and debris shall be handled in a manner that prevents contamination of additional demolition debris and the co-mingling of waste. Metal including structural steel will be separated, decontaminated of asbestos, and recycled. The footprint of the boiler room will be backfilled with stone to match surrounding grade and the site will be graded in a manner to prevent stormwater runoff to adjacent properties. Additionally, all work will be completed in a manner to minimize or mitigate exposure to dust, nuisance odors, and potentially harmful vapors.

3.1.2 Construction Completion Report

EA will complete a Construction Completion Report (CCR) for IRM No. 1 in accordance with Section 5.8 of the NYSDEC Division of Environmental Remediation-10. A description of the activities completed in accordance with this SOW will be provided in the CCR. Additionally, the CCR will provide a summary of waste streams, quantity of material removed and disposal facilities, temporary restoration actions, analytical data, and any changes or deviations from this SOW.

3.2 DEMOLITION DESIGN ASSUMPTIONS

The Admiral Cleaners building was identified for demolition due to the structural condition of the building and to facilitate the RI/FS process. The remedial contractor, PES, is tasked with demolishing the structure to the slab and restoring the site as specified in this SOW and attached drawings (**Appendix B**).

Prior to demolishing the building, PES will cut and cap all utility entrances. Overhead electrical and communication lines shall be re-routed or relocated prior to commencing demolition work.

These lines originate from a pole located to the east of the site and run over the grassy area and over the north west portion of the building.

The structural assessment is described in Section 2.3 and included as **Appendix C** concluded that collapse of the northern wall and northern roof of the building is imminent. Additionally, a substantial hazard exists within the building interior from failure of overhead steel tracks. The report recommended that only authorized personnel enter the building and on a limited basis due to the structural condition/hazards. As such, the building will be demolished from the exterior and building material will be disposed of offsite as ACM impacted C&D debris and C&D debris. Metal and concrete will be separated and recycled off site. It is estimated that there is approximately 354 tons of material for disposal.

Work will also include backfill of the boiler room area, where the slab is depressed approximately 15 in. below grade. The room is approximately 12 ft x 9 ft and will be backfilled with approximately 6 tons of stone.

Site restoration will include rough grading and site security/fencing. An estimated 300 LF of 8-ft chain link fence and gate will be installed along the perimeter of the site to control access. The gate will be located along the alley bordering the east side of the property. Drawings prepared for IRM No.1 are provided in **Appendix B**

3.3 ROLES AND RESPONSIBILITIES

A description of the roles and responsibilities for the IRM to be completed at the Admiral Cleaners site were issued in a Memorandum dated 16 January 2019 by NYSDEC. The full memorandum is provided in **Appendix D** and a summary is included in the following sections.

3.3.1 New York State Department of Environmental Conservation

The NYSDEC is responsible for the administration of the IRM and coordination with EA. They will receive and review daily and monthly reports from EA's onsite Construction Inspector, coordinating review and changes to the design/SOW with all parties, and coordinate access to the remedial site and adjacent properties.

3.3.2 EA Engineering, P.C. and its affiliate EA Science and Technology

EA will provide dedicated full-time onsite construction management and engineering during the IRM, reporting to NYSDEC IRM Project Manager, David Chiusano. EA will develop a Community Air Monitoring Plan and monitor emissions and fugitive dust during demolition. EA will also provide full-time inspection services during the IRM construction. EA will review plans, specifications, and submittals from PES. EA will also host regular progress/pre-construction meetings and provide minutes to NYSDEC and PES for review and concurrence.

3.3.3 Precision Environmental Services

IRM implementation will be completed by PES, which is currently under contract to NYSDEC. The SOW for PES will include:

- Development of a Demolition Work Plan presenting Means and Methods, Transportation and Disposal Plan, Health and Safety Plan, and Traffic Control Plan.
- Permitting (Section 3.4.1 provides detail regarding permitting)
- Clearing and grubbing
- Securing site, site preparation including safety protection of personnel and general public (2018 - International Building Code Ch. 33) (International Code Council 2017)
- Protection for offsite existing structures/utilities including vibration monitoring
- Asbestos abatement/management and monitoring (Section 3.4 provides detail regarding third-party monitoring)
- Relocation of utility pole and overhead service lines
- Abandon underground utilities
- Decontamination, removal and offsite disposal of remaining dry-cleaning machinery, equipment and miscellaneous debris located inside the Admiral Cleaners building.
- Building demolition and offsite disposal of materials
- Temporary site restoration and perimeter fencing (Section 3.4.2)
- Decontamination of all equipment and vehicles prior to leaving site.

3.4 THIRD PARTY ASBESTOS MONITORING

Per requirements of New York State Industrial Code, Rule 56, a third party will be contracted by PES to provide continual air monitoring prior to and throughout the asbestos abatement and building demolition and inspect/observe asbestos removal areas and procedures to ensure all applicable regulations are followed. Monitoring performed by the third-party subcontractor will ensure that the work area is safe for re-entry following abatement, and that abatement activities do not create a health hazard in adjacent areas (residential and commercial structures surround the Admiral Cleaner's property). The third-party subcontractor shall notify NYSDEC, EA, and PES immediately should hazardous conditions exist due to elevated air sample results onsite or in adjacent areas and stop work.

3.5 PERMITTING PLAN/PERMITS

The remedial contractor, PES, will be required to obtain any work permits needed including building permits at the municipal level:

- General Building Permit including all relevant permits from City of Watervliet Building Department
- Sidewalk and road closure permits
- Asbestos abatement permit from New York State Department of Labor (work to be performed in accordance with 12 New York Codes, Rules and Regulations Part 56)
- Solid and hazardous waste management/transport permits
- National Grid easement to relocate utility pole

3.6 SITE RESTORATION

The remedial contractor, PES, shall complete temporary site restoration as detailed in Sheet 5 of **Appendix B**. The building slab will remain in place and shall act as cover. The site will be graded in a manner to prevent stormwater runoff to adjacent properties. An 8-ft permanent privacy fence will be installed along the property line to prevent unauthorized access. An access gate shall be installed along the 20 ft alley to the east of site.

4. PROJECT CONTACTS

The following personnel identified in **Table 3** have been identified for this project to fulfill requirements, roles, and responsibilities listed in Section 3.3.

Table 3 Project Roles and Contact Information

Name	Project Role	Company	Telephone	Email
David Chiusano	IRM Project Manager	NYSDEC-Central Office (Albany)	Office: (518) 402-9813 Cell: (518) 598-7753	david.chiusano@dec.ny.gov
Joshua Haugh	Site Project Manager	NYSDEC-Region 4 (Rotterdam)	Office: (518) 357-2008 Cell: (315) 569-8308	joshua.haugh@dec.ny.gov
Paul LaBoissiere	Building Department	City of Watervliet	Office: (518) 270-3800 Extension 126	plaboissiere@watervliet.com
Kristin Kulow	Environmental and Exposure Evaluation	New York State Department of Health	Office (607) 432-3911	bee@health.ny.gov
Lisa Ramundo	Commissioner, Department of Public Works	Albany County	Office: (518) 765-2055	dpw@albanycounty.com
Donald Conan, P.E.	EA Program Manager	EA Engineering, P.C.	Office: (315) 565-6551 Cell: (315) 877-7403	dconan@eaest.com
Christopher Schroer	EA Project Manager	EA Science and Technology	Office: (315) 565-6565 Cell: (315) 569-8308	cschroer@eaest.com
Emily Cummings, EIT	EA IRM Lead	EA Science and Technology	Office: (315) 565-6553 Cell: (860) 309-3837	ecummings@eaest.com
Steve Van Arnam	IRM EA Construction Inspector	EA Science and Technology	Cell: (315) 408-0934	svanarnam@eaest.com
Steve Phelps	IRM Construction Manager	PES	Office: (518) 885-4399 Cell: (518) 528-1427	sphelps@pesnyinc.com

This page left intentionally blank

5. REFERENCES

The Chazen Companies (Chazen). 2016. *Re: Limited Subsurface Sampling Report, Former Dry Cleaner Property, 617 19th Street, City of Watervliet, Albany County, New York*. April.

EA. 2018. *Summary of Phase I Remedial Investigation Results*. 04 September.

———. 2019. *Summary of Phase II Remedial Investigation Results*. 24 January.

International Code Council. 2017. *International Building Code*. August

New York State Department of Environmental Protection (NYSDEC). 2009. *Order on Consent File No. R4-2009-0219-25*. April.

———. 2017. *Inactive Hazardous Waste Disposal Site Classification Notice. Site Name: Admiral Cleaners. Site No. 401075*. August.

This page left intentionally blank

Figures

This page intentionally left blank

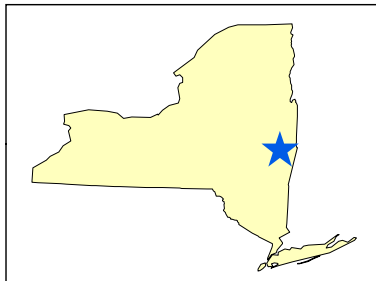
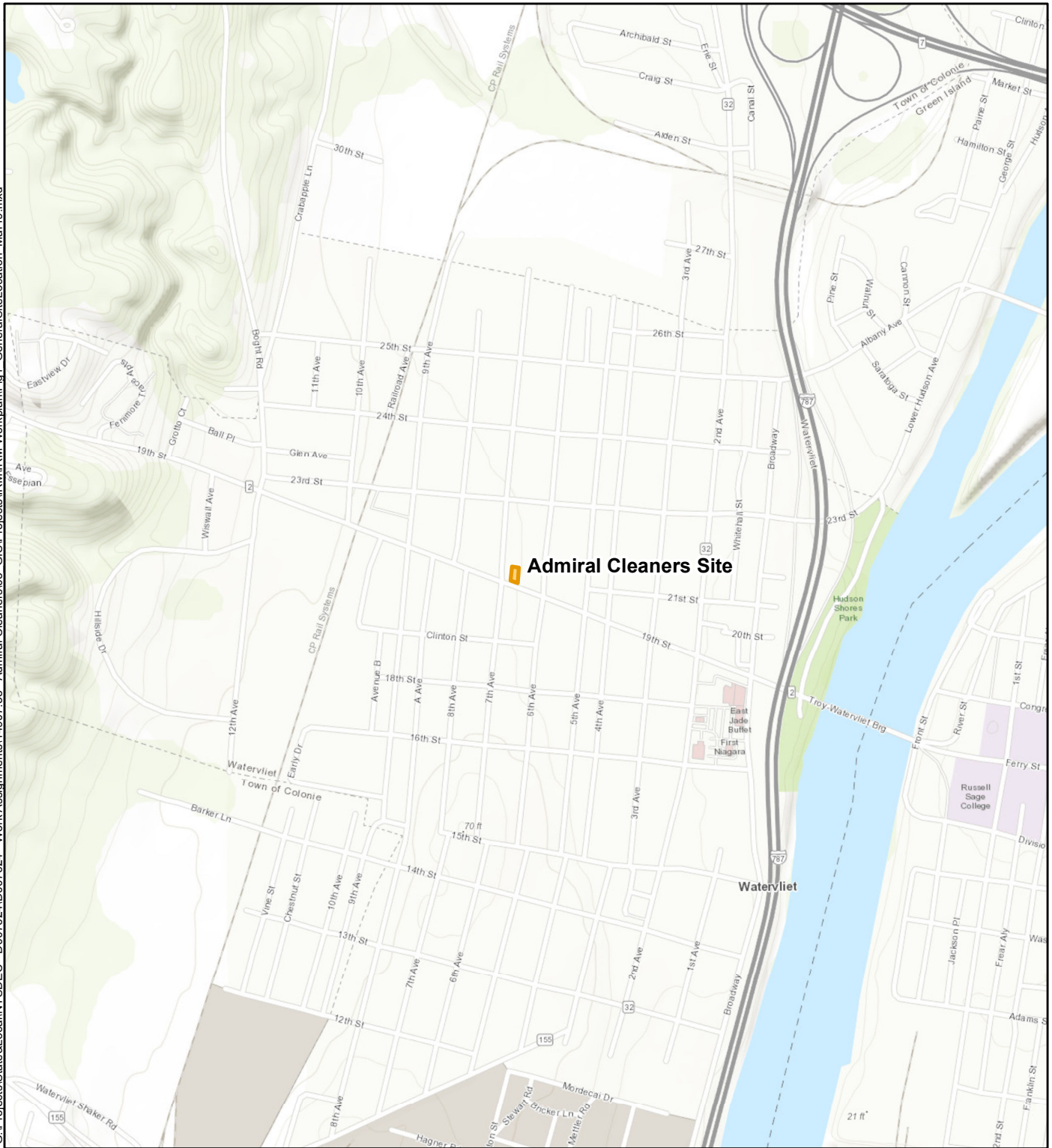

0 250 500 1,000
Feet

Legend



-  Site Location
-  Admiral Cleaners Site Boundary

Figure 1
SITE LOCATION
Admiral Cleaners
Watervliet, Albany County, NY

Map Date: 3/20/2019
Projection: NAD 1983 State Plane New York
East FIPS 3101 Feet

This page intentionally left blank



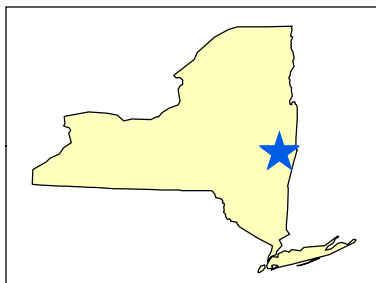

- Legend**
-  Admiral Cleaners Site Boundary
 -  Adjacent Properties & Parcels
 -  Site Location

Figure 2
Site Layout

Admiral Cleaners
Watervliet, Albany County, NY



Map Date: 4/12/2019
Projection: NAD 1983 State Plane New York
East FIPS 3101 Feet

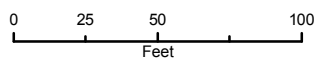

Department of
Environmental
Conservation



This page intentionally left blank

Appendix A

Asbestos Survey Results

This page intentionally left blank



*P. O. Box 1024
Schenectady, NY 12301
(518) 346-6374 (Phone)
(518) 346-4062 (Fax)
www.4spectrum.com*

ASBESTOS SURVEY/INSPECTION

FOR

**FORMER ADMIRAL DRYCLEANERS
617 19TH STREET
WATERVLIET, NY 12189**

SPECTRUM PROJECT No.: 18-516

SEPTEMBER 17, 2018

PREPARED FOR:

**MR. MARTIN BACHNER, GEOLOGIST
PRECISION ENVIRONMENTAL SERVICES
831 ROUTE 67
BALLSTON SPA, NY 12020**

TABLE OF CONTENTS

SECTION I	- INTRODUCTION
SECTION II	- LIMITATIONS
SECTION III	- ASBESTOS SAMPLING SUMMARY
ATTACHMENTS	- TABLE 1 – ASBESTOS SAMPLING RESULTS
	- TABLE 2 – ASBESTOS FINDINGS
	- PHOTO ALBUM
	- LOCATION MAPS
	- LABORATORY REPORTS
	- LICENSING AND CERTIFICATION

SECTION I - INTRODUCTION

On August 29, 2018, Spectrum Environmental Associates, Inc. (Spectrum) conducted a survey for the presence of asbestos containing materials at the Former Admiral Drycleaners located at 617 19th Street in Watervliet, NY. Mr. Bruce Campbell Jr (Asbestos Inspector #15-11979) conducted this inspection following procedures and guidelines commonly used and accepted by federal and state regulations. The objective of the survey was to identify the presence and approximate locations and quantities of suspect and/or confirmed asbestos containing materials.

An initial walkthrough of the designated areas was conducted by an experienced asbestos inspector to observe and record materials used in the construction of the building. The inspector proceeded by assessing floors, walls, ceilings, surfacing materials, thermal systems insulation, roofing materials and other miscellaneous materials with the potential to contain asbestos. From observations, the inspector prepared a listing of building materials that are suspected to contain asbestos. The inspector selected these materials for inclusion in the inspection through professional experience and an understanding of the historical uses of asbestos. Generally speaking, if a building material within a structure could contain asbestos, the material was included in the inspection.

Materials included in the survey were identified and recorded with respect to grouped homogeneous sampling areas. Representative bulk material samples were collected from locations within each homogeneous sampling area. Sampling information was recorded on chain of custody forms for documentation. Samples were individually preserved within a container and transported to an independent laboratory for asbestos analysis.

Laboratory analysis of asbestos samples via polarized light microscopy (PLM) and/or transmission electron microscopy (TEM) was conducted by AmeriSci of New York, New York (ELAP# 11480, NVLAP# 200546-0). Sample analysis was conducted as follows:

- “Friable” Asbestos Samples – PLM
- “Non-Friable” Organically Bound (NOB) Asbestos Samples – PLM and, if negative, TEM for confirmation as required under NYSDOH-ELAP regulations.

SECTION II - LIMITATIONS

The information provided in this report was compiled from field and laboratory data obtained during the site visit. Observations noted and recorded are intended to represent the conditions that existed at the subject site at the time and date that the observations were made.

Spectrum has not conducted its own analytical, but has utilized an independent NYS-DOH ELAP approved laboratory to provide the analytical results contained in this report. All discussions, findings, and conclusions are based on information that Spectrum received and understood to be factual.

Determinations of suspect asbestos containing materials within the building were subject to the accessibility of individual areas or spaces. Spectrum accepts no responsibility for the content of the building materials within areas or spaces that were unknown to us or not reasonably accessible. Spectrum assumes no liability for any buildings that were not identified by the client that may fall under state or federal regulations.

All quantities of ACM provided in this report are provided as required by law and are believed to be accurate. If this report is to be used for bidding purposes, field verification of quantities is recommended by the abatement contractor prior to bidding.

Conclusions and recommendations provided in this report are based on the assumption that materials identified are homogeneous throughout their application.

This report has been compiled for the exclusive use of Precision Environmental Services, its successors and/or assigns. This report and its contents represent confidential information and should not be duplicated without the expressed permission of Precision Environmental Services, its successors and/or assigns. This report should only be reproduced in its entirety to ensure all the appropriate information is provided.

The building owner is Precision Environmental Services and may be reached at 831 Route 67 in Ballston Spa, NY.

SECTION III – ASBESTOS SAMPLING SUMMARY

The results of the sampling are provided in Table 1 (Asbestos Sampling Results) and the asbestos findings are provided in Table 2 (Asbestos Findings) of the Attachments. The laboratory results and sample location map(s) are also provided in the Attachments.

ATTACHMENTS

TABLE 1 – ASBESTOS SAMPLING RESULTS

TABLE 2 – ASBESTOS FINDINGS

PHOTO ALBUM

LOCATION MAPS

LABORATORY REPORTS

LICENSING AND CERTIFICATION

This page intentionally left blank

TABLE 1 – ASBESTOS SAMPLING RESULTS

617 19th Street
Spectrum Project # 18-516

Date Sampled: August 29, 2018

Sample #	Description	Location/Area	PLM Results (% Type)	TEM Results (% Type)
01	9x9 Mastic	Front of Store Under Carpet – East	Chrysotile <0.25%	Chrysotile 1.5%
02	9x9 Mastic	Front of Store Under Carpet – West	Chrysotile <0.25%	NA/PS
03	9x9 Gray	Front of Store Under Carpet – East	Chrysotile 6.3%	NA/PS
04	9x9 Gray	Front of Store Under Carpet – West	NA/PS	NA/PS
05	9x9 Red	Front of Store Under Carpet – East	NA/PS	NA/PS
06	9x9 Red	Front of Store Under Carpet – West	NA/PS	NA/PS
07	Floor Leveler	Around Edge of Carpet	NAD	NA
08	Floor Leveler	Around Edge of Carpet	NAD	NA
09	Carpet Adhesive	Front of Store Under Carpet – East	NAD	NAD
10	Carpet Adhesive	Front of Store Under Carpet – West	NAD	NAD
11	Flu Pack	Boiler Room Around Boiler Vent	NAD	NA
12	Flu Pack	Boiler Room Around Boiler Vent	NAD	NA
13	Ceiling Panels	Boiler Room Ceiling	Chrysotile 20.0%	NA
14	Ceiling Panels	Boiler Room Ceiling	NA/PS	NA
15	Ceiling Tile	East	NAD	NAD
16	Ceiling Tile	West	NAD	NAD

Note: Asbestos containing materials are greater than 1% asbestos. Trace is considered less than 1% asbestos.

NAD - no asbestos detected, NA - not applicable, NA¹ Sample not submitted, NA/PS – Positive Stop, SF - square feet, LF – linear feet

TABLE 1 – ASBESTOS SAMPLING RESULTS

617 19th Street
Spectrum Project # 18-516

Date Sampled: August 29, 2018

Sample #	Description	Location/Area	PLM Results (% Type)	TEM Results (% Type)
17	Caulk	Metal Door Frame – Exterior	NAD	Anthophyllite 2.0%
18	Caulk	Metal Door Frame – Exterior	NAD	NA/PS
19	Caulk	Metal Window Frame – Exterior	NAD	NAD
20	Caulk	Metal Window Frame – Exterior	NAD	NAD
21	Window Glaze	Glass Panel on Sides of Front Door – Interior	NAD	Anthophyllite < 1.0%
22	Window Glaze	Glass Panel on Sides of Front Door – Interior	NAD	Anthophyllite < 1.0%
23	Window Glaze	Glass Panel on Sides of Front Door – Exterior	NA ¹	NA
24	Window Glaze	Glass Panel on Sides of Front Door – Exterior	NA ¹	NA
25	Window Glaze	Large Front Windows – Exterior	NAD	NAD
26	Window Glaze	Large Front Windows – Exterior	NAD	NAD
27	Window Glaze	Large Front Windows – Interior	NAD	NAD
28	Window Glaze	Large Front Windows – Interior	NAD	NAD
29	Window Glaze	Large Windows West Side	NAD	NAD
30	Window Glaze	Large Windows West Side	NAD	NAD
31	Air Cell Pipe Insulation	Long Pipe That Crosses The Store Front From East to West	Chrysotile 36.4%	NA
32	Air Cell Pipe Insulation	Found on Floor	NAD	NA

Note: Asbestos containing materials are greater than 1% asbestos. Trace is considered less than 1% asbestos.

NAD - no asbestos detected, NA - not applicable, NA¹ Sample not submitted, NA/PS – Positive Stop, SF - square feet, LF – linear feet

TABLE 1 – ASBESTOS SAMPLING RESULTS

617 19th Street
Spectrum Project # 18-516

Date Sampled: August 29, 2018

Sample #	Description	Location/Area	PLM Results (% Type)	TEM Results (% Type)
33	Air Cell Pipe Insulation	Long Pipe That Crosses The Structure	NA/PS	NA
34	Pipe Elbow Insulation	Elbow on Pipe with Air Cell	Chrysotile 30.8%	NA
35	Pipe Elbow Insulation	Elbow on Pipe with Air Cell	NA/PS	NA
36	Pipe Elbow Insulation	Elbow on Pipe with Air Cell	NA/PS	NA
37	Parapet Wall Roofing Material	Along Parapet Wall East Side	Chrysotile 4.2%	NA
38	Parapet Wall Roofing Material	Along Parapet Wall South Side	NA/PS	NA
39	Parapet Wall Roofing Sealer	Along Parapet Wall East Side	NA/PS	NA
40	Parapet Wall Roofing Sealer	Along Parapet Wall East Side	NA/PS	NA
41	Roofing Built Up	Bottom Layer of Roof	Chrysotile <0.25%	NA
42	Roofing Built Up	Bottom Layer of Roof	Chrysotile <0.25%	NA
43	Roofing Insulation	On Top of Built Up	NAD	NA
44	Roofing Insulation	On Top of Built Up	NAD	NA
45	Roofing Layer 4	On Top Of Insulation	NAD	NA
46	Roofing Layer 4	On Top of Insulation	NAD	NA
47	Roofing Layer 3	On top Of Layer 4	NAD	NA
48	Roofing Layer 3	On Top Of Layer 4	NAD	NA

Note: Asbestos containing materials are greater than 1% asbestos. Trace is considered less than 1% asbestos.

NAD - no asbestos detected, NA - not applicable, NA¹ Sample not submitted, NA/PS – Positive Stop, SF - square feet, LF – linear feet

TABLE 1 – ASBESTOS SAMPLING RESULTS

617 19th Street
Spectrum Project # 18-516

Date Sampled: August 29, 2018

Sample #	Description	Location/Area	PLM Results (% Type)	TEM Results (% Type)
49	Roofing Layer 2	On Top of Layer 3	NAD	NA
50	Roofing Layer 2	On Top of Layer 3	NAD	NA
51	Roof Vapor Barrier	Between Layer 2 and 1	NAD	NA
52	Roof Vapor Barrier	Between Layer 2 and 1	NAD	NA
53	Roofing Top Layer	Top Layer of Roof	NAD	NA
54	Roofing Top Layer	Top Layer of Roof	NAD	NA
55	Roof Seam Sealer	On Seams of Flat Roof and Flashing	Chrysotile 1.8%	NA
56	Roof Seam Sealer	On Seams of Flat Roof and Flashing	NA/PS	NA
57	Silver coat	West Side of Roof	NAD	NAD
58	Silver coat	East Side of Roof	NAD	NAD

Note: Asbestos containing materials are greater than 1% asbestos. Trace is considered less than 1% asbestos.

NAD - no asbestos detected, NA - not applicable, NA¹ Sample not submitted, NA/PS – Positive Stop, SF - square feet, LF – linear feet

TABLE 2 – ASBESTOS FINDINGS

617 19th Street
Spectrum Project # 18-516

Date Sampled: August 29, 2018

Limitations:

The following limitation/conditions were noted as part of the survey:

- OSHA requires that an employer not expose its workers above the PEL and therefore specific training, work practices and/or respiratory protection may need to be a consideration when handling materials that are less than one percent.
- The inspection was performed in accordance with New York State Industrial Code Rule 56 Section 5.1. It is the responsibility of the owner or its agent to forward a copy of this report to the local government entity charged with issuing a permit for such demolition, renovation, remodeling or repair work under applicable State or local laws as well as to the NYS Department of Labor Asbestos Control Bureau. Spectrum will not send this report to the NYSDOL without written permission from its client due to the sensitive nature of the information present in this report.
- A copy of 56-5.1 is available upon request.
- This report reflects the conditions found at the date and time of the inspection(s). Conditions of the area and materials may change due to external events, forces or influences. Re-inspection of the area may be required prior to the start of any work if an extended period of time has passed or if disturbances have occurred.
- All asbestos locations on drawings are approximate. All quantities are estimated and must be field verified prior to use as part of a bidding document. Materials may extend or be hidden behind or within other materials or structural members. Any contractor or other user of this report is required to physically confirm the quantities and verify measurements of materials to be removed, to be bid for removal, or for any other purpose. Contractors are responsible to physically visit the site and confirm all quantities for bidding purposes.
- This survey is for demolition of the structure.
- Spectrum did not inspect any exterior area below grade. Foundation sealers, buried piping and other items may exist below grade which may contain asbestos.

PHOTO ALBUM

TABLE 2 – ASBESTOS FINDINGS

617 19th Street
Spectrum Project # 18-516

Date Sampled: August 29, 2018

Material	Location/Area	Estimated Quantity*	Condition/Damaged
9x9 Mastic	Front of Store Under Carpet	~400 sf	Poor
9x9 Gray			
9x9 Red			
Ceiling Panels	Boiler Room Ceiling	~ 120 sf	Poor
Caulk	Metal Door Frame – Exterior	30	Poor
Air Cell Pipe Insulation ¹	Long Pipe That Crosses The Store Front & Floor	60 lf on piping & entire floor covered needs variance	Poor
Pipe Elbow Insulation	Elbow on Pipe with Air Cell	2 ea	Poor
Parapet Wall Roofing Material	Along Parapet Wall East Side	3,150 sf	Poor
Parapet Wall Roofing Sealer	Along Parapet Wall East Side		
Roof Seam Sealer	On Seams of Flat Roof and Flashing		

* Quantities of identified ACM are estimates only and should be field verified prior to bid by the contractor or confirmed as part of an RFP or design specification.

Air Cell Pipe Insulation¹ Due to the disturbance of the Air Cell Pipe insulation being greater than 10 sf a site specific variance will be required for the clean-up of the material.

Please see the limitation listed above.

SF–square feet, LF – linear feet, ea – each

This page intentionally left blank

Asbestos Inspection Photo Album of Admiral Cleaners

by

Spectrum Environmental Associates, Inc.

Spectrum Project # 18-516

Date of Inspection: August 29, 2018



20180829_100002



20180829_095956



20180829_100009



20180829_100027



20180829_100032



20180829_100037



20180829_100041



20180829_100209



20180829_100216



20180829_100937



20180829_100926



20180829_100930



20180829_100934



20180829_100958



20180829_100951



20180829_104303



20180829_104309

This page intentionally left blank

LOCATION MAP(S)

This page intentionally left blank

18-516
Admiral Cleaners Watervliet
Demo Survey
Pictorial Representation - NTS

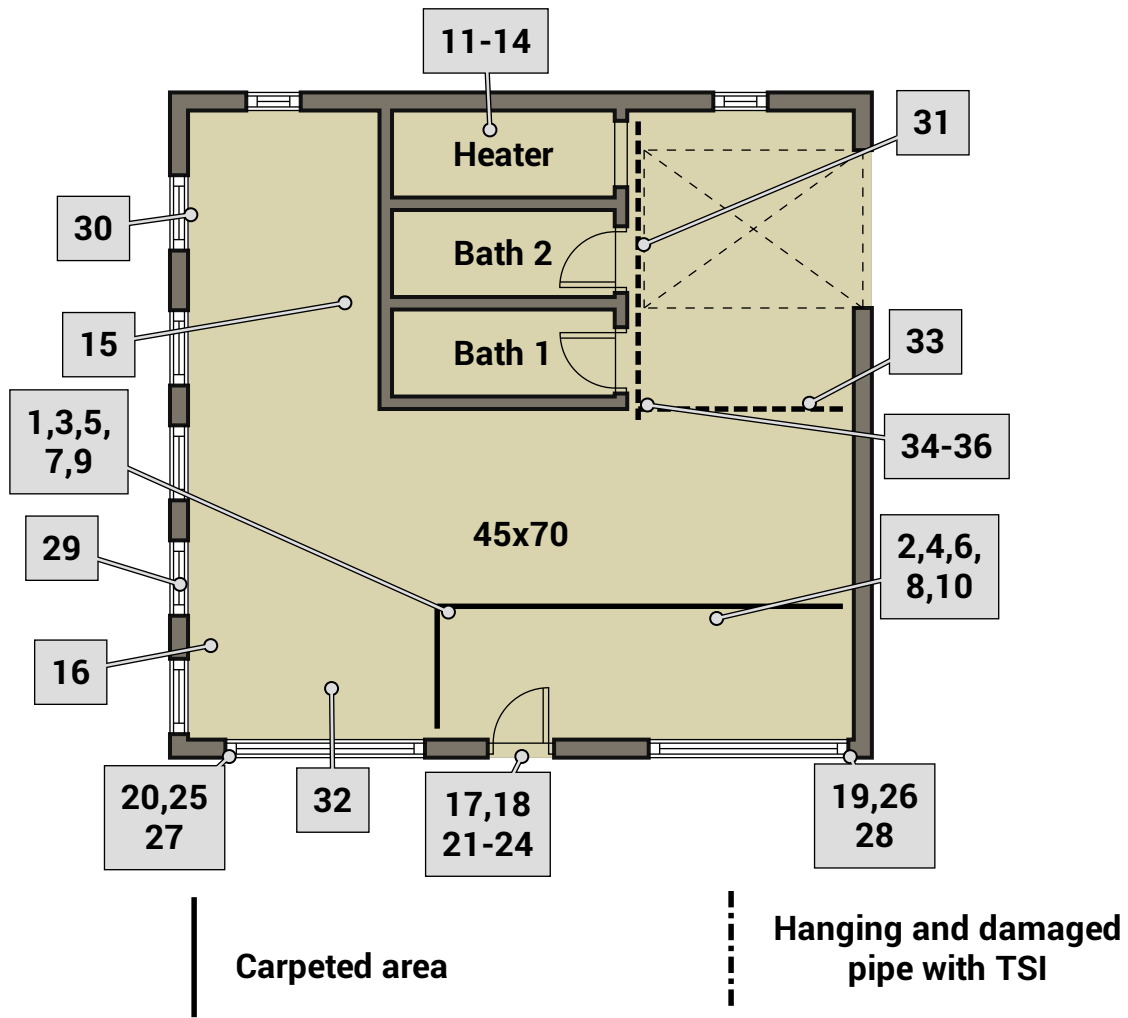

This page intentionally left blank

18-516
Admiral Cleaners Watervliet
Demo Survey (Roof)
Pictorial Representation - NTS

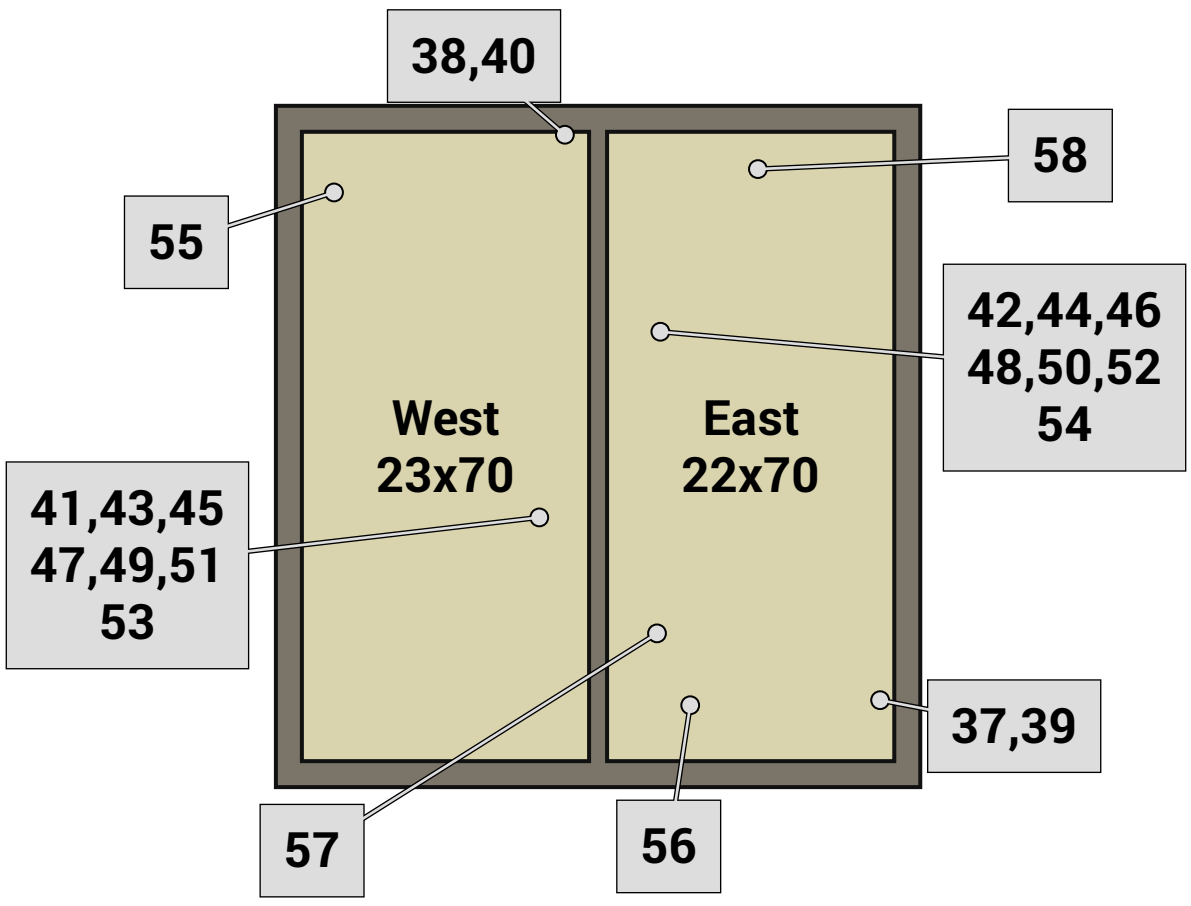

This page intentionally left blank

LABORATORY REPORTS

This page intentionally left blank



PLM Bulk Asbestos Report

Spectrum Environmental Associates, Inc **Date Received** 08/30/18 **AmeriSci Job #** 218085610
 Attn: Bill Massman **Date Examined** 09/05/18 **P.O. #**
 P.O.Box 1024 **ELAP #** 11480 **Page** 1 **of** 11
RE: 18-516; Admiral Cleaners; Throughout
 Schenectady, NY 12301

Client No. / HGA	Lab No.	Asbestos Present	Total % Asbestos
1 1 Location: Front Of Store Under Carpet East - 9 X 9 Mastic	218085610-01	Yes	Trace (<0.25 % pc) ^{1,2} (EPA 400 PC) by Kensen Caro on 09/05/18 Analyst Description: Black, Homogeneous, Non-Fibrous, Bulk Material Asbestos Types: Chrysotile <0.25 % pc Other Material: Non-fibrous 12.7 %
2 1 Location: Front Of Store Under Carpet West - 9 X 9 Mastic	218085610-02	Yes	Trace (<0.25 % pc) ¹ (EPA 400 PC) by Kensen Caro on 09/05/18 Analyst Description: Black, Homogeneous, Non-Fibrous, Bulk Material Asbestos Types: Chrysotile <0.25 % pc Other Material: Non-fibrous 10.7 %
3 1 Location: Front Of Store Under Carpet East - 9 X 9 Gray	218085610-03	Yes	6.3 % (by NYS ELAP 198.6) by Kensen Caro on 09/05/18 Analyst Description: Grey, Homogeneous, Non-Fibrous, Bulk Material Asbestos Types: Chrysotile 6.3 % Other Material: Non-fibrous 29.8 %
4 1 Location: Front Of Store Under Carpet West - 9 X 9 Gray	218085610-04		NA/PS Analyst Description: Bulk Material Asbestos Types: Other Material:
5 1 Location: Front Of Store Under Carpet East - 9 X 9 Red	218085610-05		NA/PS Analyst Description: Bulk Material Asbestos Types: Other Material:

See Reporting notes on last page

Client Name: Spectrum Environmental Associates, Inc.

PLM Bulk Asbestos Report

18-516; Admiral Cleaners; Throughout

Client No. / HGA	Lab No.	Asbestos Present	Total % Asbestos
6 1	218085610-06 Location: Front Of Store Under Carpet West - 9 X 9 Red		NA/PS
Analyst Description: Bulk Material Asbestos Types: Other Material:			
7 2	218085610-07 Location: Around Edge Of Carpet Area - Floor Leveler	No	NAD (by NYS ELAP 198.1) by Kensen Caro on 09/05/18
Analyst Description: Light Grey, Homogeneous, Non-Fibrous, Cementitious, Bulk Material Asbestos Types: Other Material: Non-fibrous 100 %			
8 2	218085610-08 Location: Around Edge Of Carpet Area - Floor Leveler	No	NAD (by NYS ELAP 198.1) by Kensen Caro on 09/05/18
Analyst Description: Light Grey, Homogeneous, Non-Fibrous, Bulk Material Asbestos Types: Other Material: Non-fibrous 100 %			
9 3	218085610-09 Location: Front Of Store Under Carpet East - Carpet Adhesive	No	NAD (by NYS ELAP 198.6) by Kensen Caro on 09/05/18
Analyst Description: Yellow, Homogeneous, Non-Fibrous, Bulk Material Asbestos Types: Other Material: Non-fibrous 27.8 %			
10 3	218085610-10 Location: Front Of Store Under Carpet West - Carpet Adhesive	No	NAD (by NYS ELAP 198.6) by Kensen Caro on 09/05/18
Analyst Description: Yellow, Homogeneous, Non-Fibrous, Bulk Material Asbestos Types: Other Material: Non-fibrous 22.8 %			
11 4	218085610-11 Location: Boiler Room Around Boiler Vent - Flu Pack	No	NAD (by NYS ELAP 198.1) by Kensen Caro on 09/05/18
Analyst Description: Brown, Homogeneous, Non-Fibrous, Cementitious, Bulk Material Asbestos Types: Other Material: Non-fibrous 100 %			

Client Name: Spectrum Environmental Associates, Inc.

PLM Bulk Asbestos Report

18-516; Admiral Cleaners; Throughout

Client No. / HGA	Lab No.	Asbestos Present	Total % Asbestos
12 4	218085610-12 Location: Boiler Room Around Boiler Vent - Flu Pack	No	NAD (by NYS ELAP 198.1) by Kensen Caro on 09/05/18
Analyst Description: Brown, Homogeneous, Non-Fibrous, Bulk Material			
Asbestos Types:			
Other Material: Non-fibrous 100 %			
13 5	218085610-13 Location: Boiler Room Ceiling - Ceiling Panels	Yes	20 % (by NYS ELAP 198.1) by Kensen Caro on 09/05/18
Analyst Description: Grey, Homogeneous, Fibrous, Cementitious, Bulk Material			
Asbestos Types: Chrysotile 20.0 %			
Other Material: Non-fibrous 80 %			
14 5	218085610-14 Location: Boiler Room Ceiling - Ceiling Panels		NA/PS
Analyst Description: Bulk Material			
Asbestos Types:			
Other Material:			
15 6	218085610-15 Location: East - Ceiling Tile	No	NAD (by NYS ELAP 198.6) by Kensen Caro on 09/05/18
Analyst Description: Brown, Homogeneous, Non-Fibrous, Bulk Material			
Asbestos Types:			
Other Material: Non-fibrous 76.2 %			
16 6	218085610-16 Location: West - Ceiling Tile	No	NAD (by NYS ELAP 198.6) by Kensen Caro on 09/05/18
Analyst Description: Brown, Homogeneous, Non-Fibrous, Bulk Material			
Asbestos Types:			
Other Material: Non-fibrous 75.6 %			
17 7	218085610-17 Location: Metal Door Frame - Exterior - Caulk	No	NAD (by NYS ELAP 198.6) by Kensen Caro on 09/05/18
Analyst Description: OffWhite, Homogeneous, Non-Fibrous, Bulk Material			
Asbestos Types:			
Other Material: Non-fibrous 20.3 %			

PLM Bulk Asbestos Report

18-516; Admiral Cleaners; Throughout

Client No. / HGA	Lab No.	Asbestos Present	Total % Asbestos
18 7	218085610-18 Location: Metal Door Frame - Exterior - Caulk	No	NAD (by NYS ELAP 198.6) by Kensen Caro on 09/05/18
Analyst Description: OffWhite, Homogeneous, Non-Fibrous, Bulk Material			
Asbestos Types:			
Other Material: Non-fibrous 15.6 %			
19 8	218085610-19 Location: Metal Window Frame - Exterior - Caulk	No	NAD (by NYS ELAP 198.6) by Kensen Caro on 09/05/18
Analyst Description: Grey, Homogeneous, Non-Fibrous, Bulk Material			
Asbestos Types:			
Other Material: Non-fibrous 15.4 %			
20 8	218085610-20 Location: Metal Window Frame - Exterior - Caulk	No	NAD (by NYS ELAP 198.6) by Kensen Caro on 09/05/18
Analyst Description: Grey, Homogeneous, Non-Fibrous, Bulk Material			
Asbestos Types:			
Other Material: Non-fibrous 17.2 %			
21 9	218085610-21 Location: Glass Panel On Sides Of Front Door - Interior - Window Glaze	No	NAD (by NYS ELAP 198.6) by Kensen Caro on 09/05/18
Analyst Description: OffWhite, Homogeneous, Non-Fibrous, Bulk Material			
Asbestos Types:			
Other Material: Non-fibrous 6.7 %			
22 9	218085610-22 Location: Glass Panel On Sides Of Front Door - Interior - Window Glaze	No	NAD (by NYS ELAP 198.6) by Kensen Caro on 09/05/18
Analyst Description: OffWhite, Homogeneous, Non-Fibrous, Bulk Material			
Asbestos Types:			
Other Material: Non-fibrous 6.3 %			
23 10	218085610-23 Location: Glass Panel On Sides Of Front Door - Exterior - Window Glaze "Sample Not Submitted"		NA
Analyst Description: Bulk Material			
Asbestos Types:			
Other Material:			

Client Name: Spectrum Environmental Associates, Inc.

PLM Bulk Asbestos Report

18-516; Admiral Cleaners; Throughout

Client No. / HGA	Lab No.	Asbestos Present	Total % Asbestos
24 10	218085610-24 Location: Glass Panel On Sides Of Front Door - Exterior - Window Glaze "Sample Not Submitted"		NA
Analyst Description: Bulk Material			
Asbestos Types:			
Other Material:			
25 11	218085610-25 Location: Large Front Windows - Exterior - Window Glaze	No	NAD (by NYS ELAP 198.6) by Kensen Caro on 09/05/18
Analyst Description: Grey, Homogeneous, Non-Fibrous, Bulk Material			
Asbestos Types:			
Other Material: Non-fibrous 18.2 %			
26 11	218085610-26 Location: Large Front Windows - Exterior - Window Glaze	No	NAD (by NYS ELAP 198.6) by Kensen Caro on 09/05/18
Analyst Description: Grey, Homogeneous, Non-Fibrous, Bulk Material			
Asbestos Types:			
Other Material: Non-fibrous 15.3 %			
27 12	218085610-27 Location: Large Front Windows - Interior - Window Glaze	No	NAD (by NYS ELAP 198.6) by Kensen Caro on 09/05/18
Analyst Description: Grey, Homogeneous, Non-Fibrous, Bulk Material			
Asbestos Types:			
Other Material: Non-fibrous 1.8 %			
28 12	218085610-28 Location: Large Front Windows - Interior - Window Glaze	No	NAD (by NYS ELAP 198.6) by Kensen Caro on 09/05/18
Analyst Description: Grey, Homogeneous, Non-Fibrous, Bulk Material			
Asbestos Types:			
Other Material: Non-fibrous 2 %			
29 13	218085610-29 Location: Large Windows West Side - Window Glaze	No	NAD (by NYS ELAP 198.6) by Kensen Caro on 09/05/18
Analyst Description: OffWhite, Homogeneous, Non-Fibrous, Bulk Material			
Asbestos Types:			
Other Material: Non-fibrous 3.5 %			

Client Name: Spectrum Environmental Associates, Inc.

PLM Bulk Asbestos Report

18-516; Admiral Cleaners; Throughout

Client No. / HGA	Lab No.	Asbestos Present	Total % Asbestos
30 13	218085610-30 Location: Large Windows West Side - Window Glaze	No	NAD (by NYS ELAP 198.6) by Kensen Caro on 09/05/18
Analyst Description: OffWhite, Homogeneous, Non-Fibrous, Bulk Material			
Asbestos Types:			
Other Material: Non-fibrous 4.7 %			
31 14	218085610-31 Location: Long Pipe That Crosses The Store From East To West - Air Cell Pipe Insulation	Yes	36.4 % (by NYS ELAP 198.1) by Kensen Caro on 09/05/18
Analyst Description: OffWhite, Homogeneous, Fibrous, Bulk Material			
Asbestos Types: Chrysotile 36.4 %			
Other Material: Cellulose 40 %, Non-fibrous 23.6 %			
32 14	218085610-32 Location: Found On Floor - Air Cell Pipe Insulation		NA/PS
Analyst Description: Bulk Material			
Asbestos Types:			
Other Material:			
33 14	218085610-33 Location: Long Pipe That Crosses Structure - Air Cell Pipe Insulation		NA/PS
Analyst Description: Bulk Material			
Asbestos Types:			
Other Material:			
34 15	218085610-34 Location: Elbow On Pipe With Air Cell - Pipe Elbow Insulation	Yes	30.8 % (by NYS ELAP 198.1) by Kensen Caro on 09/05/18
Analyst Description: OffWhite, Homogeneous, Fibrous, Bulk Material			
Asbestos Types: Chrysotile 30.8 %			
Other Material: Non-fibrous 69.2 %			
35 15	218085610-35 Location: Elbow On Pipe With Air Cell - Pipe Elbow Insulation		NA/PS
Analyst Description: Bulk Material			
Asbestos Types:			
Other Material:			

PLM Bulk Asbestos Report

18-516; Admiral Cleaners; Throughout

Client No. / HGA	Lab No.	Asbestos Present	Total % Asbestos
36 15	218085610-36 Location: Elbow On Pipe With Air Cell - Pipe Elbow Insulation		NA/PS
Analyst Description: Bulk Material Asbestos Types: Other Material:			
37 16	218085610-37 Location: Along Parapet Wall East Side - Parapet Wall Roofing Material	Yes	4.3 % (by NYS ELAP 198.6) by Kensen Caro on 09/05/18
Analyst Description: Black, Homogeneous, Non-Fibrous, Bulk Material Asbestos Types: Chrysotile 4.2 % Other Material: Non-fibrous 24.4 %			
38 16	218085610-38 Location: Along Parapet Wall South Side - Parapet Wall Roofing Material		NA/PS
Analyst Description: Bulk Material Asbestos Types: Other Material:			
39 16	218085610-39 Location: Along Parapet Wall East Side - Parapet Wall Roofing Sealer		NA/PS
Analyst Description: Bulk Material Asbestos Types: Other Material:			
40 16	218085610-40 Location: Along Parapet Wall East Side - Parapet Wall Roofing Sealer		NA/PS
Analyst Description: Bulk Material Asbestos Types: Other Material:			
41 17	218085610-41 Location: Bottom Layer Of Roof - Roofing Built Up	Yes	Trace (<0.25 % pc) ¹ (EPA 400 PC) by Kensen Caro on 09/05/18
Analyst Description: Black, Homogeneous, Non-Fibrous, Bulk Material Asbestos Types: Chrysotile <0.25 % pc Other Material: Non-fibrous 5.8 %			

PLM Bulk Asbestos Report

18-516; Admiral Cleaners; Throughout

Client No. / HGA	Lab No.	Asbestos Present	Total % Asbestos
42 17	218085610-42 Location: Bottom Layer Of Roof - Roofing Built Up	Yes	Trace (<0.25 % pc) ¹ (EPA 400 PC) by Kensen Caro on 09/05/18
Analyst Description: Black, Homogeneous, Non-Fibrous, Bulk Material Asbestos Types: Chrysotile <0.25 % pc Other Material: Non-fibrous 5.6 %			
43 17	218085610-43 Location: On Top Of Built Up - Roofing Insulation	No	NAD (by NYS ELAP 198.1) by Kensen Caro on 09/05/18
Analyst Description: Dark Brown, Homogeneous, Fibrous, Bulk Material Asbestos Types: Other Material: Cellulose 45 %, Non-fibrous 55 %			
44 17	218085610-44 Location: On Top Of Built Up - Roofing Insulation	No	NAD (by NYS ELAP 198.1) by Kensen Caro on 09/05/18
Analyst Description: Dark Brown, Homogeneous, Fibrous, Bulk Material Asbestos Types: Other Material: Cellulose 40 %, Non-fibrous 60 %			
45 17	218085610-45 Location: On Top Of Insulation - Roofing Layer 4	No	NAD (by NYS ELAP 198.6) by Kensen Caro on 09/05/18
Analyst Description: Black, Homogeneous, Non-Fibrous, Bulk Material Asbestos Types: Other Material: Non-fibrous 0.5 %			
46 17	218085610-46 Location: On Top Of Insulation - Roofing Layer 4	No	NAD (by NYS ELAP 198.6) by Kensen Caro on 09/05/18
Analyst Description: Black, Homogeneous, Non-Fibrous, Bulk Material Asbestos Types: Other Material: Non-fibrous 0.2 %			
47 17	218085610-47 Location: On Top Of Layer 4 - Roofing Layer 3	No	NAD (by NYS ELAP 198.6) by Kensen Caro on 09/05/18
Analyst Description: Black, Homogeneous, Non-Fibrous, Bulk Material Asbestos Types: Other Material: Non-fibrous 0.4 %			

See Reporting notes on last page

Client Name: Spectrum Environmental Associates, Inc.

PLM Bulk Asbestos Report

18-516; Admiral Cleaners; Throughout

Client No. / HGA	Lab No.	Asbestos Present	Total % Asbestos
48 17	218085610-48 Location: On Top Of Layer 4 - Roofing Layer 3	No	NAD (by NYS ELAP 198.6) by Kensen Caro on 09/05/18
Analyst Description: Black, Homogeneous, Non-Fibrous, Bulk Material			
Asbestos Types:			
Other Material: Non-fibrous 0.8 %			
49 17	218085610-49 Location: On Top Of Layer 3 - Roofing Layer 2	No	NAD (by NYS ELAP 198.6) by Kensen Caro on 09/05/18
Analyst Description: Black, Homogeneous, Non-Fibrous, Bulk Material			
Asbestos Types:			
Other Material: Non-fibrous 0.5 %			
50 17	218085610-50 Location: On Top Of Layer 3 - Roofing Layer 2	No	NAD (by NYS ELAP 198.6) by Kensen Caro on 09/05/18
Analyst Description: Black, Homogeneous, Non-Fibrous, Bulk Material			
Asbestos Types:			
Other Material: Non-fibrous 2.1 %			
51 17	218085610-51 Location: Between Layer 2 And 1 - Roof Vapor Barrier	No	NAD (by NYS ELAP 198.6) by Kensen Caro on 09/05/18
Analyst Description: Black, Homogeneous, Non-Fibrous, Bulk Material			
Asbestos Types:			
Other Material: Non-fibrous 14.1 %			
52 17	218085610-52 Location: Between Layer 2 And 1 - Roof Vapor Barrier	No	NAD (by NYS ELAP 198.6) by Kensen Caro on 09/05/18
Analyst Description: Black, Homogeneous, Non-Fibrous, Bulk Material			
Asbestos Types:			
Other Material: Non-fibrous 4 %			
53 17	218085610-53 Location: Top Layer Of Roof - Roofing Top Layer	No	NAD (by NYS ELAP 198.6) by Kensen Caro on 09/05/18
Analyst Description: Black, Homogeneous, Non-Fibrous, Bulk Material			
Asbestos Types:			
Other Material: Non-fibrous 12.8 %			

Client Name: Spectrum Environmental Associates, Inc.

PLM Bulk Asbestos Report

18-516; Admiral Cleaners; Throughout

Client No. / HGA	Lab No.	Asbestos Present	Total % Asbestos
54 17	218085610-54 Location: Top Layer Of Roof - Roofing Top Layer	No	NAD (by NYS ELAP 198.6) by Kensen Caro on 09/05/18
Analyst Description: Black, Homogeneous, Non-Fibrous, Bulk Material			
Asbestos Types:			
Other Material: Non-fibrous 12.7 %			
55 17	218085610-55 Location: On Seams Of Flat Roof And Flashing - Roof Seam Sealer	Yes	1.8 % (by NYS ELAP 198.6) by Kensen Caro on 09/05/18
Analyst Description: Black, Homogeneous, Non-Fibrous, Bulk Material			
Asbestos Types: Chrysotile 1.8 %			
Other Material: Non-fibrous 9.6 %			
56 17	218085610-56 Location: On Seams Of Flat Roof And Flashing - Roof Seam Sealer		NA/PS
Analyst Description: Bulk Material			
Asbestos Types:			
Other Material:			
57 18	218085610-57 Location: West Side Of Roof - Silvercoat	No	NAD (by NYS ELAP 198.6) by Kensen Caro on 09/05/18
Analyst Description: Silver, Homogeneous, Non-Fibrous, Bulk Material			
Asbestos Types:			
Other Material: Non-fibrous 57.5 %			
58 18	218085610-58 Location: East Side Of Roof - Silvercoat	No	NAD (by NYS ELAP 198.6) by Kensen Caro on 09/05/18
Analyst Description: Silver, Heterogeneous, Non-Fibrous, Bulk Material			
Asbestos Types:			
Other Material: Non-fibrous 54.9 %			

Client Name: Spectrum Environmental Associates, Inc.

PLM Bulk Asbestos Report

18-516; Admiral Cleaners; Throughout

Reporting Notes:

- (1) Sample prepared for analysis by ELAP 198.6 method
- (2) This job was - Analyzed using Motic BA400 Pol Scope S/N 1190000538

Analyzed by: Kensen Caro 

*NAD/NSD =no asbestos detected; NA =not analyzed; NA/PS=not analyzed/positive stop, (SOF-V) = Sprayed On Fireproofing containing Vermiculite; (SM-V) = Surfacing Material containing Vermiculite; PLM Bulk Asbestos Analysis by Appd E to Subpt E, 40 CFR 763 (NVLAP 200546-0), ELAP PLM Method 198.1 for NY friable samples, which includes the identification and quantitation of vermiculite or 198.6 for NOB samples or EPA 400 pt ct by Appd E to Subpt E, 40 CFR 763 (NY ELAP Lab 11480); Note:PLM is not consistently reliable in detecting asbestos in floor coverings and similar non-friable organically bound materials. NAD or Trace results by PLM are inconclusive, TEM is currently the only method that can be used to determine if this material can be considered or treated as non asbestos-containing in NY State (also see EPA Advisory for floor tile, FR 59,146,38970,8/1/94) National Institute of Standards and Technology Accreditation requirements mandate that this report must not be reproduced except in full without the approval of the lab. This PLM report relates ONLY to the items tested. AIHA-LAP, LLC Lab ID 102843, RI Cert AAL-094, CT Cert PH-0186, Mass Cert AA000054.

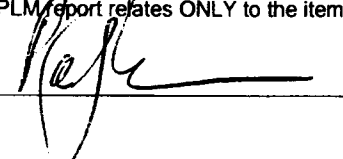
Reviewed By: 

END OF REPORT

Client Name: Spectrum Environmental Associates, Inc.

Table I
Summary of Bulk Asbestos Analysis Results
 18-516; Admiral Cleaners; Throughout (Report Amended 9/19/2018)

AmeriSci Sample #	Client Sample#	HG Area	Sample Weight (gram)	Heat Sensitive Organic %	Acid Soluble Inorganic %	Insoluble Non-Asbestos Inorganic %	** Asbestos % by PLM/DS	** Asbestos % by TEM
01	1	1	0.316	55.4	32.0	11.2	Chrysotile <0.25	Chrysotile 1.5
Location: Front Of Store Under Carpet East - 9 X 9 Mastic								
02	2	1	0.215	53.0	36.3	10.7	Chrysotile <0.25	NA/PS
Location: Front Of Store Under Carpet West - 9 X 9 Mastic								
03	3	1	0.249	25.7	38.2	29.8	Chrysotile 6.3	NA/PS
Location: Front Of Store Under Carpet East - 9 X 9 Gray								
04	4	1	0.282	24.1	39.7	36.2	NA/PS	NA/PS
Location: Front Of Store Under Carpet West - 9 X 9 Gray								
05	5	1	0.279	24.0	32.3	43.7	NA/PS	NA/PS
Location: Front Of Store Under Carpet East - 9 X 9 Red								
06	6	1	0.275	23.6	38.5	37.8	NA/PS	NA/PS
Location: Front Of Store Under Carpet West - 9 X 9 Red								
07	7	2	----	----	----	----	NAD	NA
Location: Around Edge Of Carpet Area - Floor Leveler								
08	8	2	----	----	----	----	NAD	NA
Location: Around Edge Of Carpet Area - Floor Leveler								
09	9	3	0.216	56.0	16.2	27.8	NAD	NAD
Location: Front Of Store Under Carpet East - Carpet Adhesive								
10	10	3	0.202	55.0	22.3	22.8	NAD	NAD
Location: Front Of Store Under Carpet West - Carpet Adhesive								
11	11	4	----	----	----	----	NAD	NA
Location: Boiler Room Around Boiler Vent - Flu Pack								
12	12	4	----	----	----	----	NAD	NA
Location: Boiler Room Around Boiler Vent - Flu Pack								
13	13	5	----	----	----	----	Chrysotile 20.0	NA
Location: Boiler Room Ceiling - Ceiling Panels								
14	14	5	----	----	----	----	NA/PS	NA
Location: Boiler Room Ceiling - Ceiling Panels								
15	15	6	0.282	23.4	0.4	76.2	NAD	NAD
Location: East - Ceiling Tile								
16	16	6	0.250	16.4	8.0	75.6	NAD	NAD
Location: West - Ceiling Tile								

Client Name: Spectrum Environmental Associates, Inc.

Table I
Summary of Bulk Asbestos Analysis Results
 18-516; Admiral Cleaners; Throughout (Report Amended 9/19/2018)

AmeriSci Sample #	Client Sample#	HG Area	Sample Weight (gram)	Heat Sensitive Organic %	Acid Soluble Inorganic %	Insoluble Non-Asbestos Inorganic %	** Asbestos % by PLM/DS	** Asbestos % by TEM
17	17	7	0.123	13.0	66.7	18.3	NAD	Anthophyllite 2.0
Location: Metal Door Frame - Exterior - Caulk								
18	18	7	0.288	18.1	66.3	15.6	NAD	NA/PS
Location: Metal Door Frame - Exterior - Caulk								
19	19	8	0.201	78.6	6.0	15.4	NAD	NAD
Location: Metal Window Frame - Exterior - Caulk								
20	20	8	0.186	72.6	10.2	17.2	NAD	NAD
Location: Metal Window Frame - Exterior - Caulk								
21	21	9	0.298	9.1	84.2	6.5	NAD	Anthophyllite <1.0
Location: Glass Panel On Sides Of Front Door - Interior - Window Glaze								
22	22	9	0.319	11.9	81.8	6.1	NAD	Anthophyllite <1.0
Location: Glass Panel On Sides Of Front Door - Interior - Window Glaze								
23	23	10	----	----	----	----	NA	NA
Location: Glass Panel On Sides Of Front Door - Exterior - Window Glaze "Sample Not Submitted"								
24	24	10	----	----	----	----	NA	NA
Location: Glass Panel On Sides Of Front Door - Exterior - Window Glaze "Sample Not Submitted"								
25	25	11	0.247	66.0	15.8	18.2	NAD	NAD
Location: Large Front Windows - Exterior - Window Glaze								
26	26	11	0.177	65.5	19.2	15.3	NAD	NAD
Location: Large Front Windows - Exterior - Window Glaze								
27	27	12	0.220	64.5	33.6	1.8	NAD	NAD
Location: Large Front Windows - Interior - Window Glaze								
28	28	12	0.202	63.4	34.7	2.0	NAD	NAD
Location: Large Front Windows - Interior - Window Glaze								
29	29	13	0.288	11.1	85.4	3.5	NAD	NAD
Location: Large Windows West Side - Window Glaze								
30	30	13	0.256	12.5	82.8	4.7	NAD	NAD
Location: Large Windows West Side - Window Glaze								
31	31	14	----	----	----	----	Chrysotile 36.4	NA
Location: Long Pipe That Crosses The Store From East To West - Air Cell Pipe Insulation								
32	32	14	----	----	----	----	NA/PS	NA
Location: Found On Floor - Air Cell Pipe Insulation								

Client Name: Spectrum Environmental Associates, Inc.

Table I
Summary of Bulk Asbestos Analysis Results
 18-516; Admiral Cleaners; Throughout (Report Amended 9/19/2018)

AmeriSci Sample #	Client Sample#	HG Area	Sample Weight (gram)	Heat Sensitive Organic %	Acid Soluble Inorganic %	Insoluble Non-Asbestos Inorganic %	** Asbestos % by PLM/DS	** Asbestos % by TEM
33	33	14	----	----	----	----	NA/PS	NA
Location: Long Pipe That Crosses Structure - Air Cell Pipe Insulation								
34	34	15	----	----	----	----	Chrysotile 30.8	NA
Location: Elbow On Pipe With Air Cell - Pipe Elbow Insulation								
35	35	15	----	----	----	----	NA/PS	NA
Location: Elbow On Pipe With Air Cell - Pipe Elbow Insulation								
36	36	15	----	----	----	----	NA/PS	NA
Location: Elbow On Pipe With Air Cell - Pipe Elbow Insulation								
37	37	16	0.268	53.7	17.5	24.4	Chrysotile 4.2	NA
Location: Along Parapet Wall East Side - Parapet Wall Roofing Material								
38	38	16	0.338	44.4	17.5	38.2	NA/PS	NA
Location: Along Parapet Wall South Side - Parapet Wall Roofing Material								
39	39	16	0.428	72.2	15.4	12.4	NA/PS	NA
Location: Along Parapet Wall East Side - Parapet Wall Roofing Sealer								
40	40	16	0.389	80.7	6.2	13.1	NA/PS	NA
Location: Along Parapet Wall East Side - Parapet Wall Roofing Sealer								
41	41	17	0.497	93.0	1.2	5.8	Chrysotile <0.25	NA
Location: Bottom Layer Of Roof - Roofing Built Up								
42	42	17	0.448	91.3	3.1	5.6	Chrysotile <0.25	NA
Location: Bottom Layer Of Roof - Roofing Built Up								
43	43	17	----	----	----	----	NAD	NA
Location: On Top Of Built Up - Roofing Insulation								
44	44	17	----	----	----	----	NAD	NA
Location: On Top Of Built Up - Roofing Insulation								
45	45	17	0.366	98.4	1.1	0.5	NAD	NA
Location: On Top Of Insulation - Roofing Layer 4								
46	46	17	0.423	98.8	0.9	0.2	NAD	NA
Location: On Top Of Insulation - Roofing Layer 4								
47	47	17	0.282	97.5	2.1	0.4	NAD	NA
Location: On Top Of Layer 4 - Roofing Layer 3								
48	48	17	0.480	96.9	2.3	0.8	NAD	NA
Location: On Top Of Layer 4 - Roofing Layer 3								

See Reporting notes on last page

Client Name: Spectrum Environmental Associates, Inc.

Table I
Summary of Bulk Asbestos Analysis Results
 18-516; Admiral Cleaners; Throughout (Report Amended 9/19/2018)

AmeriSci Sample #	Client Sample#	HG Area	Sample Weight (gram)	Heat Sensitive Organic %	Acid Soluble Inorganic %	Insoluble Non-Asbestos Inorganic %	** Asbestos % by PLM/DS	** Asbestos % by TEM
49	49	17	0.216	98.6	0.9	0.5	NAD	NA
Location: On Top Of Layer 3 - Roofing Layer 2								
50	50	17	0.425	95.3	2.6	2.1	NAD	NA
Location: On Top Of Layer 3 - Roofing Layer 2								
51	51	17	0.220	70.5	15.5	14.1	NAD	NA
Location: Between Layer 2 And 1 - Roof Vapor Barrier								
52	52	17	0.176	86.9	9.1	4.0	NAD	NA
Location: Between Layer 2 And 1 - Roof Vapor Barrier								
53	53	17	0.368	83.2	4.1	12.8	NAD	NA
Location: Top Layer Of Roof - Roofing Top Layer								
54	54	17	0.378	84.9	2.4	12.7	NAD	NA
Location: Top Layer Of Roof - Roofing Top Layer								
55	55	17	0.431	79.8	8.8	9.6	Chrysotile 1.8	NA
Location: On Seams Of Flat Roof And Flashing - Roof Seam Sealer								
56	56	17	0.371	85.7	7.0	7.3	NA/PS	NA
Location: On Seams Of Flat Roof And Flashing - Roof Seam Sealer								
57	57	18	0.160	33.1	9.4	57.5	NAD	NAD
Location: West Side Of Roof - Silvercoat								
58	58	18	0.164	35.4	9.8	54.9	NAD	NAD
Location: East Side Of Roof - Silvercoat								

Analyzed by: Marik Peysakhov ; Date Analyzed 9/19/2018

**Quantitative Analysis (Semi/Full); Bulk Asbestos Analysis - PLM by Appd E to Subpt E, 40 CFR 763 or ELAP 198.1 for New York friable samples or ELAP 198.6 for New York NOB samples; TEM (Semi/Full) by EPA 600/R-93/116 (or ELAP 198.4; for New York samples; NAD = no asbestos detected during a quantitative analysis; NA = not analyzed; Trace = <1%; (SOF-V) = Sprayed On Fireproofing containing Vermiculite; (SM-V) = Surfacing Material containing Vermiculite; Quantitation for beginning weights of <0.1 grams should be considered as qualitative only; Qualitative Analysis: Asbestos analysis results of "Present" or "NVA = No Visible Asbestos" represents results for Qualitative PLM or TEM Analysis only (no accreditation coverage available from any regulatory agency for qualitative analyses); NVLAP (PLM) 200546-0, NYSDOH ELAP Lab 11480, AIHA-LAP, LLC (PLM) Lab ID 102843.

Warning Note: PLM limitation, only TEM will resolve fibers <0.25 micrometers in diameter. TEM bulk analysis is representative of the fine grained matrix material and may not be representative of non-uniformly dispersed debris for which PLM evaluation is recommended (i.e. soils and other heterogenous materials).

Reviewed By: _____

BULK SAMPLING CHAIN OF CUSTODY (Rev. 03/07/2014)

PROJECT INFORMATION

Project #: 18-516	Building Name: Admiral Cleaners	Matrix		Analysis Requested		Turnaround	
Date Sampled: 8-29-18	Area/Location: Throughout	<input checked="" type="checkbox"/> Bulk	<input type="checkbox"/> Paint	<input checked="" type="checkbox"/> PLM - ELAP 198.1	<input checked="" type="checkbox"/> TEM - ELAP 198.4	<input type="checkbox"/> RUSH	<input type="checkbox"/> 24 Hour
Page # 1 of 4	Investigator: Bruce Campbell Jr.	<input type="checkbox"/> Soil	<input type="checkbox"/> Wipe	<input checked="" type="checkbox"/> PLM - ELAP 198.6		<input type="checkbox"/> 72 Hour	<input checked="" type="checkbox"/> 5 day

SAMPLE IDENTIFICATION

Sample ID #:	Group #: *	Material	Sample Location	Condition/Comment
1	1	9x9 Mastic	Front of store under carpet east	400 sq' Pgor
2	1	9x9 Mastic	Front of store under carpet west	
3	1	9x9 gray	Front of store under carpet east	
4	1	9x9 gray	Front of store under carpet west	
5	1	9x9 red	Front of store under carpet east	
6	1	9x9 red	Front of store under carpet west	400 sq'
7	2	Floor leveler	Around edge of carpeted area	
8	2	Floor leveler	Around edge of carpeted area	
9	3	Carpet adhesive	Front of store under carpet east	400 sq'
10	3	Carpet adhesive	Front of store under carpet west	400 sq'
11	4	Flu pack	Boiler room around boiler vent	2 sq'
12	4	Flu pack	Boiler room around boiler vent	2 sq'
13	5	Ceiling panels	Boiler room ceiling	120 sq'
14	5	Ceiling panels	Boiler room ceiling	120 sq'
15	6	Ceiling tile	East	
16	6	Ceiling tile	West	

* Unless otherwise stated please analyze each group to first (1st) positive result.

Comments:

CHAIN OF CUSTODY

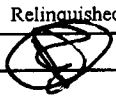
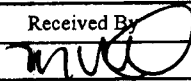
Relinquished By	Date	Time	Received By	Date	Time	Method of Submittal
	8-29-18	1600		8/30/18	1345	
I						
II						
III						

BULK SAMPLING CHAIN OF CUSTODY (Rev. 03/07/2014)

PROJECT INFORMATION

Project # 18-516	Building Name: Admiral Cleaners	Matrix		Analysis Requested		Turnaround	
Date Sampled: 8-29-18	Area/Location: Throughout	<input checked="" type="checkbox"/> Bulk	<input type="checkbox"/> Paint	<input checked="" type="checkbox"/> PLM - ELAP 198.1	<input checked="" type="checkbox"/> TEM - ELAP 198.4	<input type="checkbox"/> RUSH	<input type="checkbox"/> 24 Hour
Page # 2 of 4	Investigator: Bruce Campbell Jr.	<input type="checkbox"/> Soil	<input type="checkbox"/> Wipe	<input checked="" type="checkbox"/> PLM - ELAP 198.6		<input type="checkbox"/> 72 Hour	<input checked="" type="checkbox"/> 5 day

SAMPLE IDENTIFICATION

Sample ID #:	Group #: *	Material	Sample Location	Condition/Comment
17	7	Caulk	Metal door frame - exterior	30'
18	7		Metal door frame - exterior	30'
19	8		Metal window frame - exterior	42'
20	8	Caulk	Metal window frame - exterior	42'
21	9	Window glaze	Glass panel on sides of front door - interior	16'
22	9		Glass panel on sides of front door - interior	
23	10		Glass panel on sides of front door - exterior	
24	10		Glass panel on sides of front door - exterior	16'
25	11		Large front windows - exterior	85"x163"
26	11		Large front windows - exterior	
27	12		Large front windows - interior	
28	12		Large front windows - interior	85"x163"
29	13		Large windows west side	5 windows @ 5'x8'
30	13	Window glaze	Large windows west side	5 windows @ 5'x8'
31	14	Air cell pipe insulation	Long pipe that crosses the store from east to west	
32	14	Air cell pipe insulation	Found on floor	

* Unless otherwise stated please analyze each group to first (1st) positive result.

Comments:

CHAIN OF CUSTODY

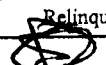
	Relinquished By	Date	Time	Received By	Date	Time	Method of Submittal
I		8/29/18	1600	M. V. [Signature]	8/30/18	1345	
II							
III							

#218085610

BULK SAMPLING CHAIN OF CUSTODY (Rev. 03/07/2014)

PROJECT INFORMATION

Project #: 18-516	Building Name: Admiral Cleaners	Matrix		Analysis Requested		Turnaround	
Date Sampled: 8-29-18	Area/Location: Throughout	<input checked="" type="checkbox"/> Bulk	<input type="checkbox"/> Paint	<input checked="" type="checkbox"/> PLM - ELAP 198.1	<input checked="" type="checkbox"/> TEM - ELAP 198.4	<input type="checkbox"/> RUSH	<input type="checkbox"/> 24 Hour
Page # 3 of 4	Investigator: Bruce Campbell Jr.	<input type="checkbox"/> Soil	<input type="checkbox"/> Wipe	<input checked="" type="checkbox"/> PLM - ELAP 198.6		<input type="checkbox"/> 72 Hour	<input checked="" type="checkbox"/> 5 day

SAMPLE IDENTIFICATION

Sample ID #:	Group #: *	Material	Sample Location	Condition/Comment
33	14	Air cell pipe insulation	Long pipe that crosses structure	Poor ↓
34	15	Pipe elbow insulation	Elbow on pipe with air cell	
35	15	Pipe elbow insulation	Elbow on pipe with air cell	
36	15	Pipe elbow insulation	Elbow on pipe with air cell	
37	16	Parapet wall roofing material	Along parapet wall east side	
38	16	Parapet wall roofing material	Along parapet wall south side	
39	16	Parapet wall roofing sealer	Along parapet wall east side	
40	16	Parapet wall roofing sealer	Along parapet wall south side	
41	17	Roofing built up	Bottom layer of roof	
42	17	Roofing built up	Bottom layer of roof	
43	17	Roofing insulation	On top of built up	
44	17	Roofing insulation	On top of built up	
45	17	Roofing layer 4	On top of insulation	
46	17	Roofing layer 4	On top of insulation	
47	17	Roofing layer 3	On top of layer 4	
48	17	Roofing layer 3	On top of layer 4	

* Unless otherwise stated please analyze each group to first (1st) positive result.

Comments:

CHAIN OF CUSTODY

Relinquished By	Date	Time	Received By	Date	Time	Method of Submittal
	8-29-18	1600	M. V. [Signature]	8/30/18	1345	
I						
II						
III						

BULK SAMPLING CHAIN OF CUSTODY (Rev. 03/07/2014)

PROJECT INFORMATION

Project #: 18-516	Building Name: Admiral Cleaners	Matrix		Analysis Requested		Turnaround	
Date Sampled: 8-29-18	Area/Location: Throughout	<input checked="" type="checkbox"/> Bulk	<input type="checkbox"/> Paint	<input checked="" type="checkbox"/> PLM - ELAP 198.1	<input checked="" type="checkbox"/> TEM - ELAP 198.4	<input type="checkbox"/> RUSH	<input type="checkbox"/> 24 Hour
Page # 4 of 4	Investigator: Bruce Campbell Jr.	<input type="checkbox"/> Soil	<input type="checkbox"/> Wipe	<input checked="" type="checkbox"/> PLM - ELAP 198.6		<input type="checkbox"/> 72 Hour	<input checked="" type="checkbox"/> 5 day

SAMPLE IDENTIFICATION

Sample ID #:	Group #: *	Material	Sample Location	Condition/Comment
49	17	Roofing layer 2	On top of layer 3	Poor
50	17	Roofing layer 2	On top of layer 3	
51	17	Roof vapor barrier	Between layers 2 and 1	
52	17	Roof vapor barrier	Between layers 2 and 1	
53	17	Roofing top layer	Top layer of roof	
54	17	Roofing top layer	Top layer of roof	
55	17	Roof seam sealer	On seams of flat roof and flashing	
56	17	Roof seam sealer	On seams of flat roof and flashing	
57	18	Silvercoat	West side of roof	Approx 50 sq' spread out in random areas
58	18	Silvercoat	East side of roof	Approx 50 sq' spread out in random areas
				Poor

* Unless otherwise stated please analyze each group to first (1st) positive result.

Comments:

CHAIN OF CUSTODY

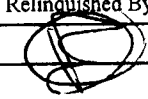
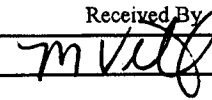
	Relinquished By	Date	Time	Received By	Date	Time	Method of Submittal
I		8-29-18	1600		8/30/18	13:45	
II							
III							

This page intentionally left blank

LICENSING AND CERTIFICATION

This page intentionally left blank

State of New York – Department of Labor

Asbestos Certification

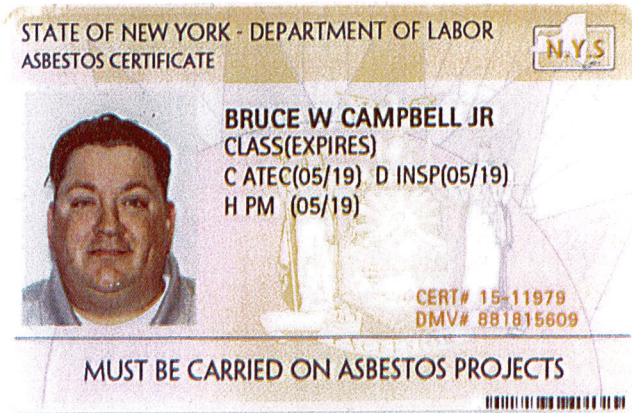

EYES GRN
 HAIR BRO
 HGT 6' 00"

IF FOUND RETURN TO:
 NYSDOL - L&C UNIT
 ROOM 161A BUILDING 12
 STATE OFFICE CAMPUS
 ALBANY NY 12240

State of New York – Department of Labor

Codes	Certification
A	Asbestos Handler
B	Restricted Handler - Allied Trades
C	Air Sampling Technician
D	Inspector
E	Management Planner
F	Operations and Maintenance
G	Supervisor
H	Project Monitor
I	Project Designer

New York State – Department of Labor

Division of Safety and Health
License and Certificate Unit
State Campus, Building 12
Albany, NY 12240

ASBESTOS HANDLING LICENSE

Spectrum Environmental Associates, Inc

P.O. Box 1024

Schenectady, NY 12301

FILE NUMBER: 99-0129

LICENSE NUMBER: 29081

LICENSE CLASS: RESTRICTED

DATE OF ISSUE: 02/08/2018

EXPIRATION DATE: 02/28/2019

Duly Authorized Representative – William L Massmann:

This license has been issued in accordance with applicable provisions of Article 30 of the Labor Law of New York State and of the New York State Codes, Rules and Regulations (12 NYCRR Part 56). It is subject to suspension or revocation for a (1) serious violation of state, federal or local laws with regard to the conduct of an asbestos project, or (2) demonstrated lack of responsibility in the conduct of any job involving asbestos or asbestos material.

This license is valid only for the contractor named above and this license or a photocopy must be prominently displayed at the asbestos project worksite. This license verifies that all persons employed by the licensee on an asbestos project in New York State have been issued an Asbestos Certificate, appropriate for the type of work they perform, by the New York State Department of Labor.



Eileen M. Franko, Director
For the Commissioner of Labor

NEW YORK STATE DEPARTMENT OF HEALTH
WADSWORTH CENTER



Expires 12:01 AM April 01, 2019
Issued April 01, 2018

CERTIFICATE OF APPROVAL FOR LABORATORY SERVICE

Issued in accordance with and pursuant to section 502 Public Health Law of New York State

MR. PAUL J. MUCHA
AMERICA SCIENCE TEAM NEW YORK, INC
117 EAST 30TH ST
NEW YORK, NY 10016

NY Lab Id No: 11480

*is hereby APPROVED as an Environmental Laboratory for the category
ENVIRONMENTAL ANALYSES SOLID AND HAZARDOUS WASTE
All approved subcategories and/or analytes are listed below:*

Miscellaneous

Asbestos in Friable Material	Item 198.1 of Manual EPA 600/M4/82/020
Asbestos in Non-Friable Material-PLM	Item 198.6 of Manual (NOB by PLM)
Asbestos in Non-Friable Material-TEM	Item 198.4 of Manual

Serial No.: 57809

Property of the New York State Department of Health. Certificates are valid only at the address shown, must be conspicuously posted, and are printed on secure paper. Continued accreditation depends on successful ongoing participation in the Program. Consumers are urged to call (518) 485-5570 to verify the laboratory's accreditation status.

This page intentionally left blank

Appendix B
Drawing Package

This page intentionally left blank

ADMIRAL CLEANERS SITE NYS REGISTRY NO. 401075

617 19th STREET
WATERVLIET, NEW YORK

PREPARED FOR
NEW YORK STATE DEPARTMENT OF ENVIRONMENTAL CONSERVATION
ALBANY, NY



NEW YORK STATE MAP
NTS



VICINITY MAP
NTS

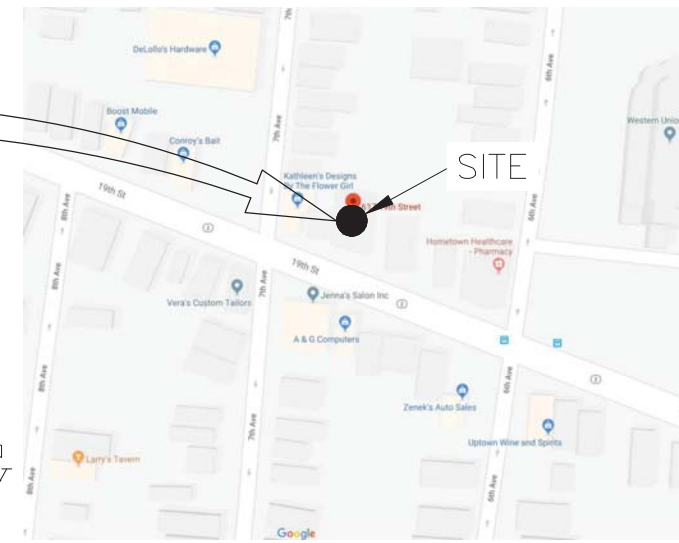

SITE MAP
NTS



NO.	DATE	DESCRIPTION

TITLE SHEET
ADMIRAL CLEANERS SITE
NYS REGISTRY NO. 401075
617 19TH STREET
WATERVILLE, NEW YORK

PREPARED BY:
EA ENGINEERING, P.C.
AND ITS AFFILIATE
EA SCIENCE AND
TECHNOLOGY



CARRS#	
EA #	1490738
DESIGN #	
FILE	1490738-PlanSet.dwg
DRAWN BY	DPA
DATE	APRIL 2019
SCALE	AS SHOWN
SS	

WARNING - IT IS A VIOLATION OF NEW YORK EDUCATION LAW, ARTICLE 145, SECTION 7209.2, FOR ANY PERSON, UNLESS HE OR SHE IS ACTING UNDER THE DIRECTION OF A LICENSED PROFESSIONAL ENGINEER OR LAND SURVEYOR, TO ALTER THIS DOCUMENT IN ANY WAY. IF ALTERED, THE ALTERING ENGINEER OR LAND SURVEYOR SHALL COMPLY WITH THE REQUIREMENTS OF NEW YORK EDUCATION LAW, ARTICLE 145, SECTION 7209.2.



7th Avenue

7th Avenue

NYS Rte 2 (19th Street)
NYS RTE 2 (NINETEENTH STREET)

6th Avenue

EXISTING CONDITIONS PLAN
GRAPHIC SCALE IN FEET

SHEET LIST TABLE	
SHEET NUMBER	SHEET TITLE
1	TITLE SHEET
2	EXISTING CONDITIONS PLAN, NOTES, & LEGEND
3	SITE PREPARATION PLAN
4	INTERIM CONDITIONS PLAN
5	BUILDING PLAN & ELEVATION
6	SITE RESTORATION DETAILS

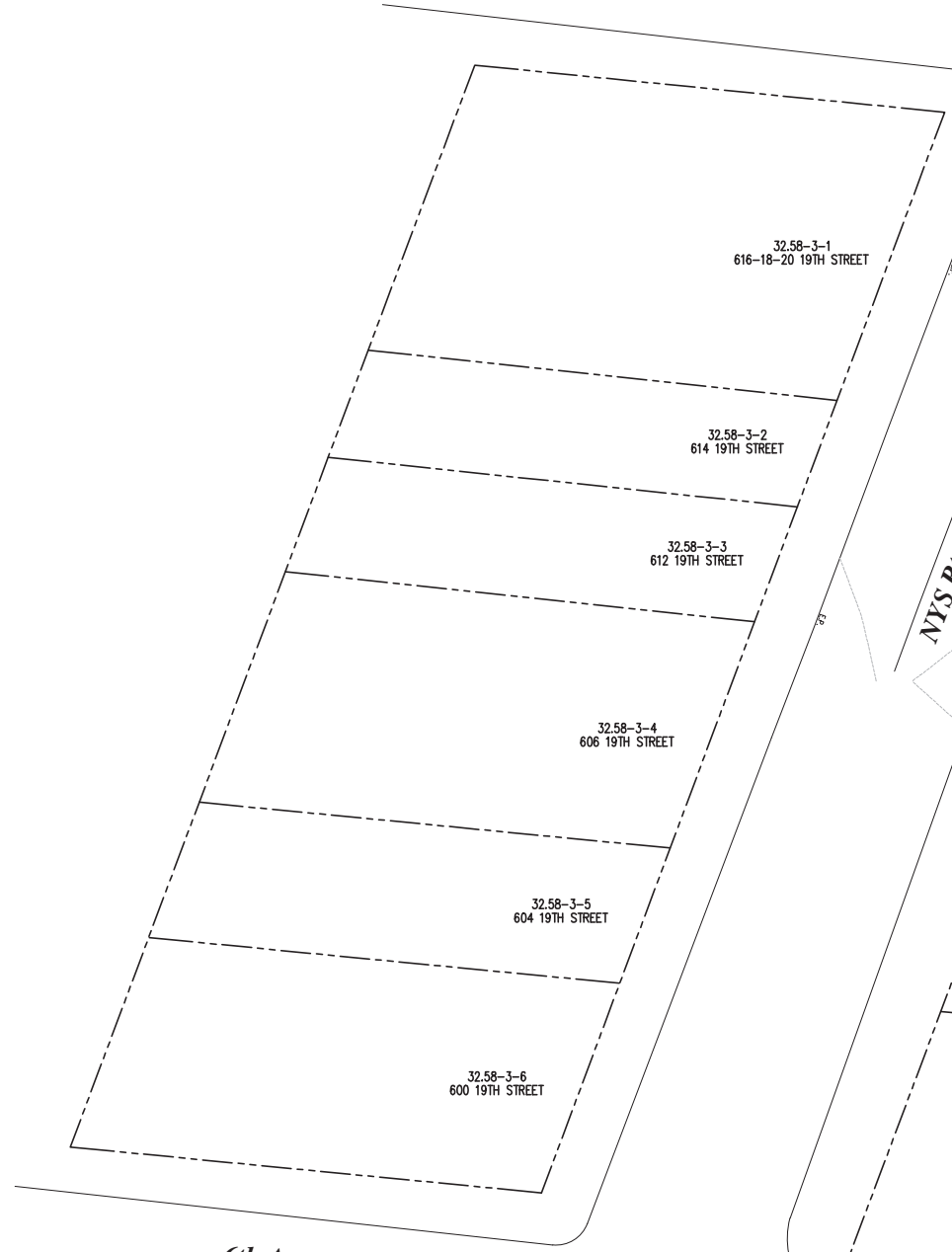

GENERAL CONSTRUCTION NOTES:

- THE FOLLOWING DRAWINGS OUTLINE THE SITE PLAN, EXISTING CONDITIONS, AND PROPOSED RESTORATION FOR THE DEMOLITION OF THE ONE-STORY BUILDING LOCATED AT 617 NINETEENTH STREET, WATERLIET, NEW YORK (ADMIRAL CLEANERS BUILDING). THIS BUILDING IS A ONE-STORY CONCRETE, MASONRY, WOOD AND STEEL BUILDING.
- CONSTRUCTION DRAWINGS ARE ISSUED WITH AND AS A COMPONENT OF THE INTERIM REMEDIAL MEASURE NO. 1 SCOPE OF WORK - BUILDING DEMOLITION WORK PLAN FOR THE ADMIRAL CLEANERS SITE (SITE NO. 401075)
- ALL WORK SHALL BE COMPLETED IN ACCORDANCE WITH THE LOCAL, STATE, AND FEDERAL REGULATIONS. WORK SHALL BE COMPLETED IN ACCORDANCE WITH NEW YORK STATE BUILDING CODES.
- CONTRACTOR IS RESPONSIBLE FOR OBTAINING ALL NECESSARY PERMITS TO PERFORM THE WORK AS SHOWN ON THE PLAN SET AND AS DESCRIBED IN THE SCOPE OF WORK.
- THE CONTRACTOR SHALL BE RESPONSIBLE MINIMIZING AND PREVENTING DUST, DEMOLITION DEBRIS, AND SOIL FROM IMPACTING ROADS DUE TO VEHICLES ARRIVING AND LEAVING THE JOB SITE AS PART OF THIS WORK.
- IT SHALL BE DISTINCTLY UNDERSTOOD THAT FAILURE TO MENTION SPECIFICALLY ANY WORK THAT WOULD NORMALLY BE REQUIRED TO COMPLETE THE PROJECT SHALL NOT RELIEVE THE CONTRACTOR OF HIS RESPONSIBILITY TO COMPLETE SUCH WORK.
- ALL UNDERGROUND AND OVERHEAD UTILITIES SHALL BE TERMINATED OR RE-ROUTED PRIOR TO DEMOLITION AS DESCRIBED ON SHEET #3 OF THIS PLANSET.
- AS PART OF THE COMMUNITY AIR MONITORING PLAN (CAMP) THE CONTRACTOR IS RESPONSIBLE TO ENSURE AND DOCUMENT THAT PROJECT EMISSIONS OF FUGITIVE DUST ARE NOT RECEIVED BY ADJACENT HOMEOWNERS AND PROPERTIES.
- BUILDING MEASUREMENTS PROVIDED HEREIN REPRESENT APPROXIMATE FIELD MEASUREMENTS.
- SITE LOGISTICS, TRUCK ROUTING, SAFETY ZONES, CONTAINER PLACEMENT, ETC. SHALL BE ESTABLISHED AND IMPLEMENTED PRIOR TO START OF DEMOLITION.
- CONTRACTOR IS EXPECTED TO RETAIN THE SERVICES OF A PROFESSIONAL ENGINEER LICENSED IN THE STATE OF NEW YORK TO DESIGN ANY EXCAVATION AND MONITORING PROTOCOLS REQUIRED TO BE PROTECTIVE OF ADJACENT STRUCTURES AND FACILITIES WHILE PERFORMING THE WORK.

SURVEY NOTES:

- HORIZONTAL DATUM IS REFERENCED TO NAD83(2011)-NYSPCS, EAST ZONE.
- VERTICAL DATUM IS REFERENCED TO NAVD88, ESTABLISHED BY STATIC GPS METHODS FROM NYS CORS NETWORK.
- PROJECT UNITS ARE U.S. SURVEY FEET.
- APPROXIMATELY 5" OF SNOW/ICE COVER WHEN THE FIELD WORK WAS CONDUCTED
- UTILITIES SHOWN HEREON ARE BASED ON VISIBLE EVIDENCE ONLY. ALL UNDERGROUND UTILITY LOCATIONS SHOULD BE CONSIDERED APPROXIMATE. THERE IS NO GUARANTEE THAT ALL EXISTING UTILITIES, WHETHER FUNCTIONAL OR ABANDONED WITHIN THE PROJECT AREA ARE SHOWN ON THIS DRAWING. THE CONTRACTOR SHALL DETERMINE THE EXACT LOCATION OF ALL UNDERGROUND UTILITIES BEFORE STARTING WORK AND SHALL BE RESPONSIBLE FOR ALL DAMAGE RESULTING FROM THIS WORK. BEFORE COMMENCING WORK, CONTACT "DIG SAFELY N.E.O.W. YORK" AT 1-800-962-7962 AND PROVIDE 72 HOURS NOTICE. ALL UTILITY INFORMATION SHOWN HEREON IS BASED UPON FILED MARKING AND VISIBLE FEATURES PRESENT AT THE TIME OF SURVEY. NO UTILITY RESEARCH WAS PERFORMED BY THE SURVEYOR.
- THIS SURVEY WAS PREPARED WITHOUT THE BENEFIT OF AN ABSTRACT OF TITLE, AND IS SUBJECT TO ANY EASEMENTS OR ENCUMBRANCES OF RECORD.
- DIMENSIONS ALONG BOUNDARY/PROPERTY LINES REPRESENTS FIELD MEASUREMENTS
- BEARINGS SHOWN AND UTILIZED HEREON ARE RELATIVE TO GRID NORTH AS REFERENCED TO THE NY STATE PLANE COORDINATE SYSTEM, EAST ZONE. TRUE NORTH AT THE 74° 30' 00" MERIDIAN OF WEST LONGITUDE.

GENERAL SAFETY & SECURITY STANDARDS FOR CONSTRUCTION:

- ALL CONSTRUCTION AND DEMOLITION MATERIALS SHALL BE STORED IN A SAFE AND SECURE MANNER.
- FENCES AROUND CONSTRUCTION SUPPLIES OR DEBRIS SHALL BE MAINTAINED.
- GATES SHALL ALWAYS BE LOCKED UNLESS A WORKER IS IN ATTENDANCE TO PREVENT UNAUTHORIZED ENTRY.
- CONTRACTOR SHALL ESTABLISH SAFE ZONES AND INSTALL SITE PROTECTION AS REQUIRED BY INTERNATIONAL BUILDING CODE; CHAPTER 33.
 - OVERHEAD PROTECTION SHALL BE PROVIDED FOR ANY SIDEWALKS OR AREAS IMMEDIATELY BENEATH THE WORK SITE OR SUCH AREAS SHALL BE FENCED OFF AND PROVIDED WITH WARNING SIGNS TO PREVENT ENTRY.
- PROPER OPERATIONS OF FIRE EXTINGUISHERS SHALL BE MAINTAINED THROUGHOUT THE PROJECT.

LEGEND

- 544.52 FIRST FLOOR ELEVATION
- EL. 524.52 SPOT ELEVATION
- VAULT
- MON. WELL
- LIGHT POLE
- UTILITY POLE
- SOWER CLEANOUT
- ⊕ WATER VALVE
- POST
- DEED LINE
- PROPERTY LINE
- X SLAB THICKNESS MEASUREMENT LOCATION

ABBREVIATIONS

- BM BENCH MARK
- CONC. CONCRETE
- (D) DEED
- E.P. EDGE OF PAVEMENT
- EL. ELEVATION
- (F) FIELD MEASUREMENT
- FEE FINISHED FLOOR ELEVATION
- FT FEET
- IN INCH
- L. LBER
- NG NATURAL GAS
- P. PAGE

WARNING - IT IS A VIOLATION OF NEW YORK EDUCATION LAW, ARTICLE 145, SECTION 7209.2, FOR ANY PERSON, UNLESS HE OR SHE IS ACTING UNDER THE DIRECTION OF A LICENSED PROFESSIONAL ENGINEER OR LAND SURVEYOR, TO ALTER THIS DOCUMENT IN ANY WAY. IF ALTERED, THE ALTERING ENGINEER OR LAND SURVEYOR SHALL COMPLY WITH THE REQUIREMENTS OF NEW YORK EDUCATION LAW, ARTICLE 145, SECTION 7209.2.



NO.	DATE	DESCRIPTION

EXISTING CONDITIONS PLAN,
NOTES, & LEGEND

PREPARED BY:
EA ENGINEERING, P.C.
AND ITS AFFILIATE
EA SCIENCE AND
TECHNOLOGY



CARRS#	
EA #	1490738
DESIGN #	
FILE	1490738-PlanSet.dwg
DRAWN BY	DPA
DATE	APRIL 2019
SCALE	AS SHOWN
SS	

SHEET #

2

SITE ACCESS AND PREPARATION NOTES

- CONTRACTOR IS EXPECTED TO REMOVE EXISTING PERIMETER FENCING/GATE POSTS ON THE PROPERTY TO CLEAR THE AREA FOR BUILDING DEMOLITION.
- CONTRACTOR TO INSTALL TEMPORARY CONSTRUCTION FENCING AND ACCESS GATES IN ACCORDANCE WITH NEW YORK STATE BUILDING CODES. EXACT LOCATION OF FENCING AND GATES TO BE DETERMINED BY CONTRACTOR AND SPECIFIED IN CONTRACTORS DEMOLITION WORK PLAN.

TREE REMOVAL NOTES

- CONTRACTOR IS EXPECTED TO CLEAR AND GRUB THE SITE. ALL TREES ON THE NORTHERN EDGE OF THE PROPERTY AND WITHIN THE 10-FT ALLEY TO THE NORTH OF THE PROPERTY WILL BE CUT TO ALLOW FOR OVERHEAD CLEARANCE. STUMPS AND ROOTS WILL BE GROUND TO A MINIMUM 6-IN BELOW GRADE.
- IT IS THE CONTRACTOR'S RESPONSIBILITY TO NOTIFY AND MAKE ARRANGEMENTS WITH THE UTILITY COMPANY FOR THE REMOVAL OF BRANCHES EXTENDING THROUGH POWER AND/OR TELEPHONE LINES SO REMOVAL OPERATIONS WILL NOT BE DELAYED.
- THE CONTRACTOR SHALL PROTECT SIDEWALKS, CURBS, STREETS, MANHOLE COVERS AND CATCH BASINS, HOUSING PROPERTY AND AUTOMOBILES FROM THE IMPACT OF FALLING WOOD BY THE USE OF LIMB GROUND SUPPORTS WHEN NEEDED.
- PUBLIC TREES REMOVED IN THE PUBLIC ROW WILL BE REPLACED IN KIND WITH THE SAME TREE SPECIES OR AS RECOMMENDED THE CITY OF WATERVLIET TREE COMMITTEE. BURLAP AND CAGE MUST BE REMOVED FROM ROOT BALL PRIOR TO PLANTING. THE CONTRACTOR SHALL OBTAIN A PERMIT FROM THE CITY OF WATERVLIET TO REMOVE PUBLIC TREES PRIOR TO COMMENCING TREE REMOVAL WORK.

UTILITIES TERMINATION AND RELOCATION NOTES

- EXISTING UTILITIES AND STRUCTURES, INCLUDING BUT NOT LIMITED TO UNDERGROUND, SURFACE OR OVERHEAD ARE INDICATED ONLY TO THE EXTENT THAT SUCH INFORMATION WAS MADE AVAILABLE TO OR DISCOVERED BY THE ENGINEER IN PREPARING THE DRAWINGS. UTILITIES SHOWN HEREON ARE BASED ON VISIBLE EVIDENCE AND ROUGH TRANSCRIPTION OF INTERIOR UTILITIES BASED ON UTILITY MARK OUT PERFORMED DURING THE FIRST PHASE OF THE REMEDIAL INVESTIGATION. ALL UNDERGROUND UTILITY LOCATIONS SHOULD BE CONSIDERED APPROXIMATE. POWER, TELEPHONE, FIBER OPTIC CABLE, WATER, GAS AND SEWER SERVICE LINES MAY NOT BE INDICATED ON THESE DRAWINGS. OTHER UTILITIES AND ASSOCIATED UTILITY INFRASTRUCTURE MAY BE PRESENT. UNDERGROUND AND OVERHEAD UTILITIES ARE NOT SHOWN IN PROFILE. THE CONTRACTOR IS SOLELY RESPONSIBLE FOR THE LOCATION AND TERMINATION OF UTILITIES TO THE ADMIRAL CLEANERS BUILDING, AND FOR THE PROTECTION OF UTILITIES SERVICING SURROUNDING PROPERTIES TO REMAIN IN SERVICE.
- THE CONTRACTOR IS TO DISCONNECT AND CAP ALL EXISTING UTILITIES AND SERVICE LINES AS SPECIFIED BY THE UTILITY COMPANIES OR CITY DEPARTMENTS HAVING JURISDICTION PRIOR TO DEMOLITION. THE CONTRACTOR SHALL PROVIDE CERTIFICATIONS TO THAT EFFECT BY THE UTILITY COMPANIES AND/OR CITY DEPARTMENT.
 - THE UTILITY POLE LOCATED TO THE EAST OF THE ADMIRAL CLEANERS BUILDING IN THE 20 FT. ALLEY SHALL BE REPLACED AND POWER LINES SHALL BE RE-ROUTED TO A NEW UTILITY POLE PLACED IN THE NORTH WEST CORNER OF THE SITE IN THE 10 FT ALLEY RUNNING WEST TO EAST NORTH OF THE PROPERTY LINE. RELOCATING PATH OF OVERHEAD UTILITIES WILL PROVIDE OVERHEAD CLEARANCE REQUISITE FOR DEMOLITION. THE CONTRACTOR IS RESPONSIBLE FOR ACQUIRING ALL REQUIRED PERMITS AND APPROVALS FOR RELOCATION AND REROUTING OF THE OVERHEAD UTILITIES. ACTUAL LOCATION OF UTILITY POLE/OVERHEAD LINE RELOCATIONS TO BE DETERMINED BY CONTRACTOR AND PROVIDED IN THE DEMOLITION WORK PLAN.
 - TEMPORARY WATER SERVICE WILL BE REQUIRED DURING DEMOLITION. CONTRACTOR IS RESPONSIBLE FOR ACQUIRING ALL REQUIRED PERMITS AND APPROVALS TO ESTABLISH TEMPORARY WATER SERVICE.
 - SANITARY FACILITIES SHALL BE PROVIDED DURING DEMOLITION ACTIVITIES.

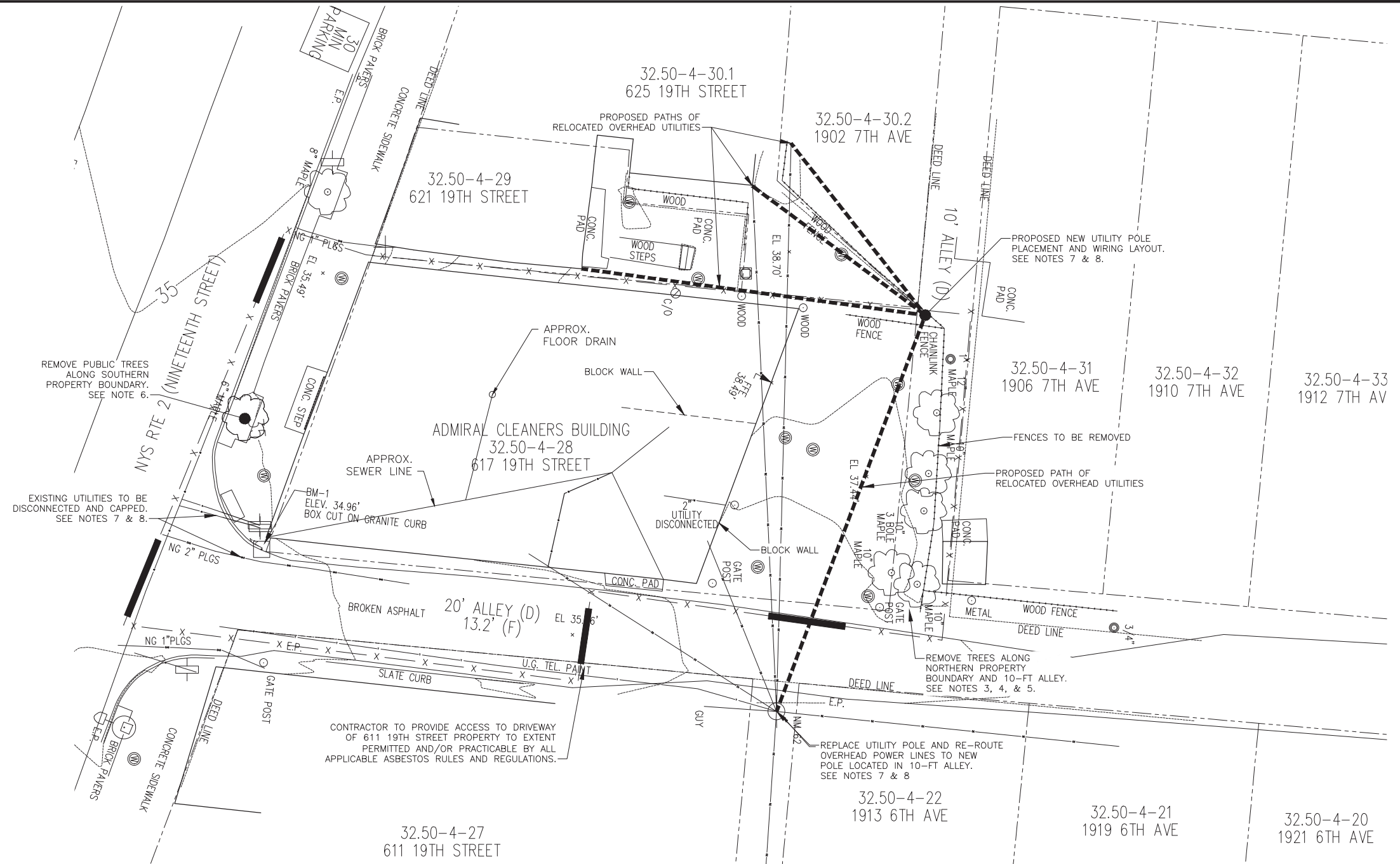

SITE PREPARATION PLAN



LEGEND

- PROPOSED PATHS OF RELOCATED OVERHEAD UTILITIES
- CONCEPTUAL CONSTRUCTION FENCING SEE NOTE 2.
- CONCEPTUAL CONSTRUCTION GATE ACCESS LOCATION

WARNING - IT IS A VIOLATION OF NEW YORK EDUCATION LAW, ARTICLE 145, SECTION 7209.2, FOR ANY PERSON, UNLESS HE OR SHE IS ACTING UNDER THE DIRECTION OF A LICENSED PROFESSIONAL ENGINEER OR LAND SURVEYOR, TO ALTER THIS DOCUMENT IN ANY WAY. IF ALTERED, THE ALTERING ENGINEER OR LAND SURVEYOR SHALL COMPLY WITH THE REQUIREMENTS OF NEW YORK EDUCATION LAW, ARTICLE 145, SECTION 7209.2.



NO.	DATE	DESCRIPTION	REVISIONS

SITE PREPARATION PLAN
 ADMIRAL CLEANERS SITE
 NYS REGISTRY NO. 401075
 617 19TH STREET
 WATERVLIET, NEW YORK

PREPARED BY:
 EA ENGINEERING, P.C.
 AND ITS AFFILIATE
 EA SCIENCE AND
 TECHNOLOGY



CARRS#	EA #
EA #	1490738
DESIGN #	
FILE	1490738PlanSet.dwg
DRAWN BY	DPA
DATE	APRIL 2019
SCALE	AS SHOWN
SS	

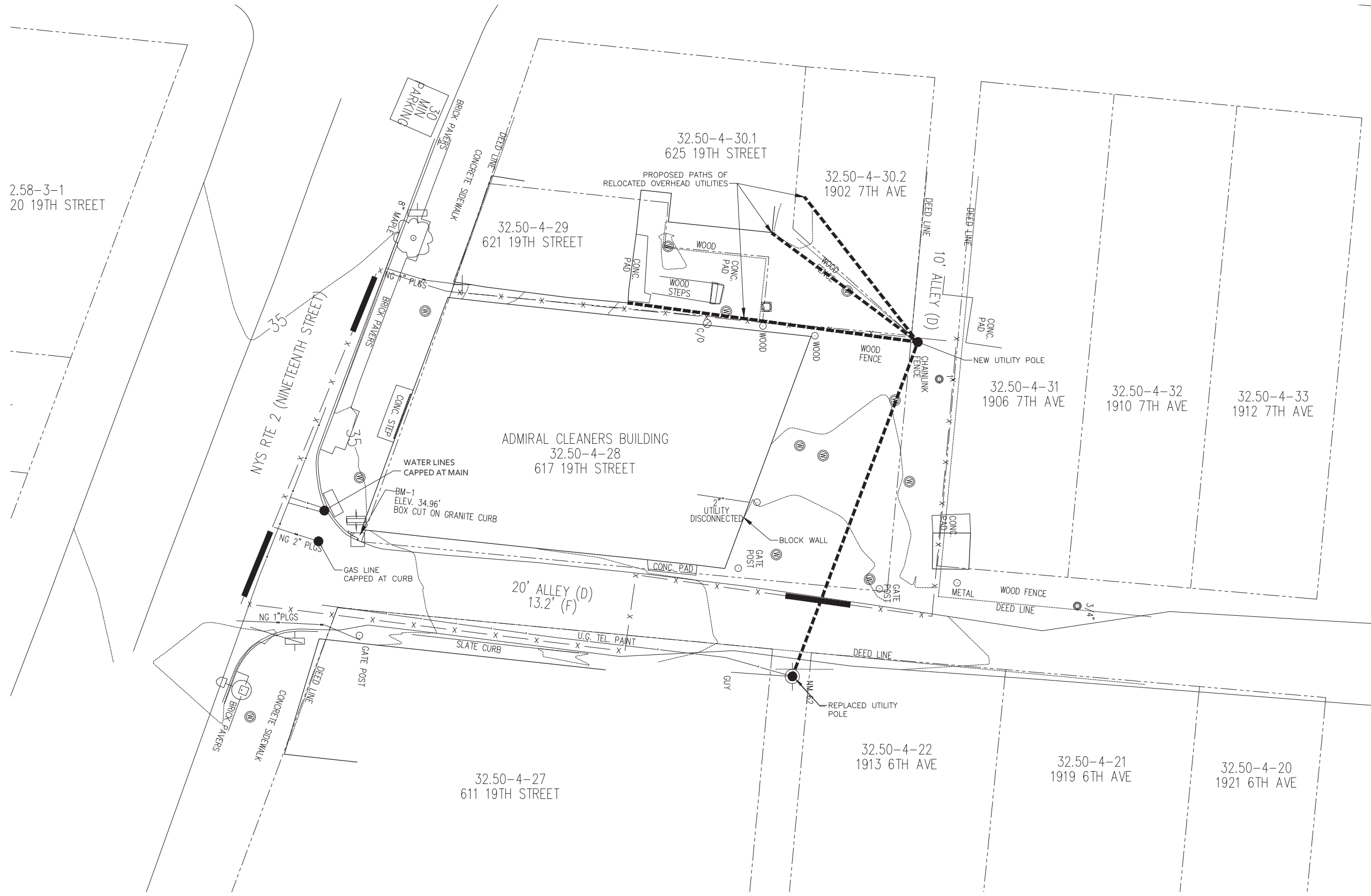

INTERIM CONDITIONS PLAN



LEGEND

- PROPOSED PATHS OF RELOCATED OVERHEAD UTILITIES
- CONCEPTUAL CONSTRUCTION FENCING SEE NOTE 2.
- CONCEPTUAL CONSTRUCTION GATE ACCESS LOCATION

WARNING - IT IS A VIOLATION OF NEW YORK EDUCATION LAW, ARTICLE 145, SECTION 7209.2, FOR ANY PERSON, UNLESS HE OR SHE IS ACTING UNDER THE DIRECTION OF A LICENSED PROFESSIONAL ENGINEER OR LAND SURVEYOR, TO ALTER THIS DOCUMENT IN ANY WAY. IF ALTERED, THE ALTERING ENGINEER OR LAND SURVEYOR SHALL COMPLY WITH THE REQUIREMENTS OF NEW YORK EDUCATION LAW, ARTICLE 145, SECTION 7209.2.

NO.	DATE	DESCRIPTION	REVISIONS

INTERIM CONDITIONS PLAN

ADMIRAL CLEANERS SITE
 NYS REGISTRY NO. 401075
 617 19TH STREET
 WATERVILLE, NEW YORK

PREPARED BY:
 EA ENGINEERING, P.C.
 AND ITS AFFILIATE
 EA SCIENCE AND
 TECHNOLOGY



CARRS#	
EA #	1490738
DESIGN #	
FILE	1490738PlanSet.dwg
DRAWN BY	DPA
DATE	APRIL 2019
SCALE	AS SHOWN
SS	

STRUCTURAL CONDITION NOTES

- SECTION VIEWS OF THE ADMIRAL CLEANERS BUILDING ARE APPROXIMATE.
- CONTRACTOR SHALL REVIEW THE STRUCTURAL CONDITION ASSESSMENT PREPARED BY RUSS REEVES, PE. THE ASSESSMENT IS PROVIDED IN APPENDIX C OF THE INTERIM REMEDIAL MEASURE NO. 1 SCOPE OF WORK - BUILDING DEMOLITION.
- ECCENTRIC COLUMN LOADING MAY BEHAVE UNPREDICTABLY.
- THE BOILER ROOM, LOCATED ALONG THE NORTH WALL OF THE BUILDING, HAS A SLAB DEPRESSED APPROXIMATELY 15-INCHES BELOW GRADE. THE FOOTPRINT OF THE BOILER ROOM WILL BE BACKFILLED WITH GRAVEL TO GRADE.

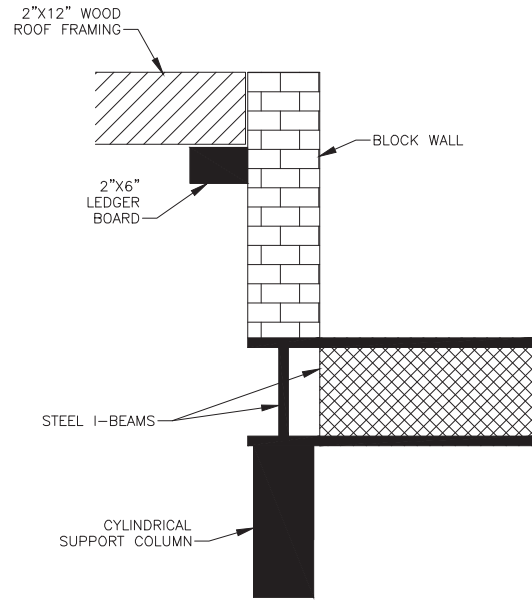

BUILDING CONSTRUCTION JOINT DETAIL
NOT TO SCALE

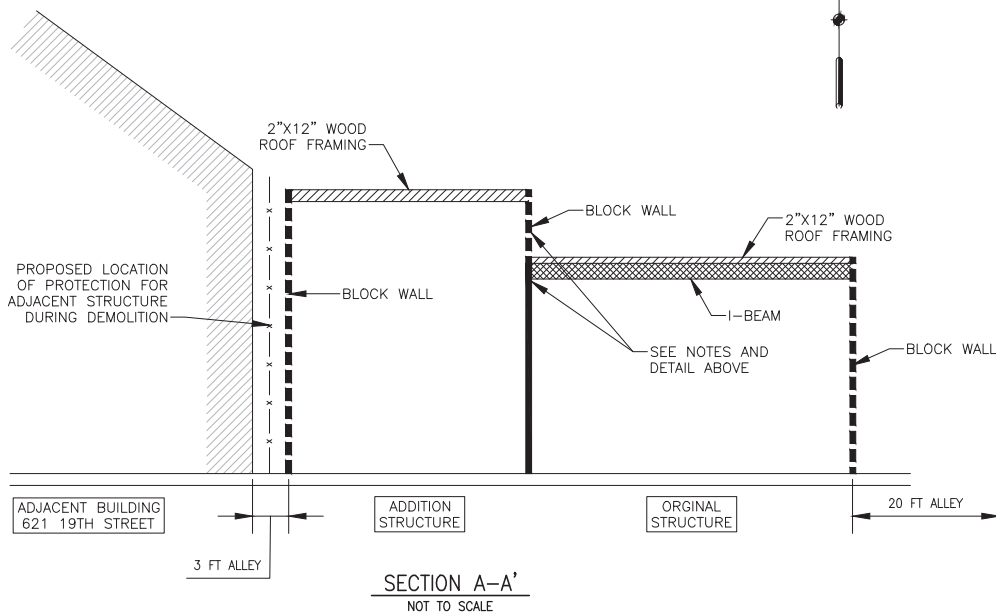

SECTION A-A'
NOT TO SCALE

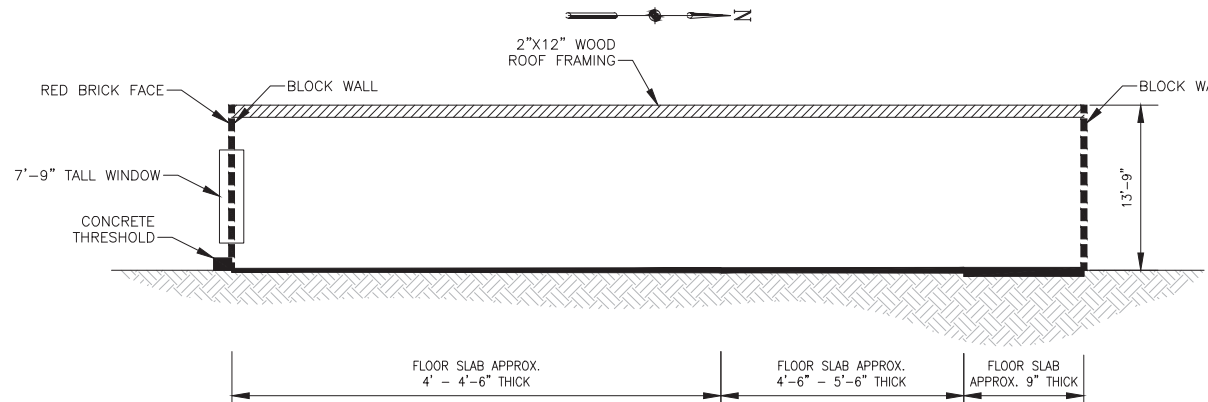

SECTION B-B'
NOT TO SCALE

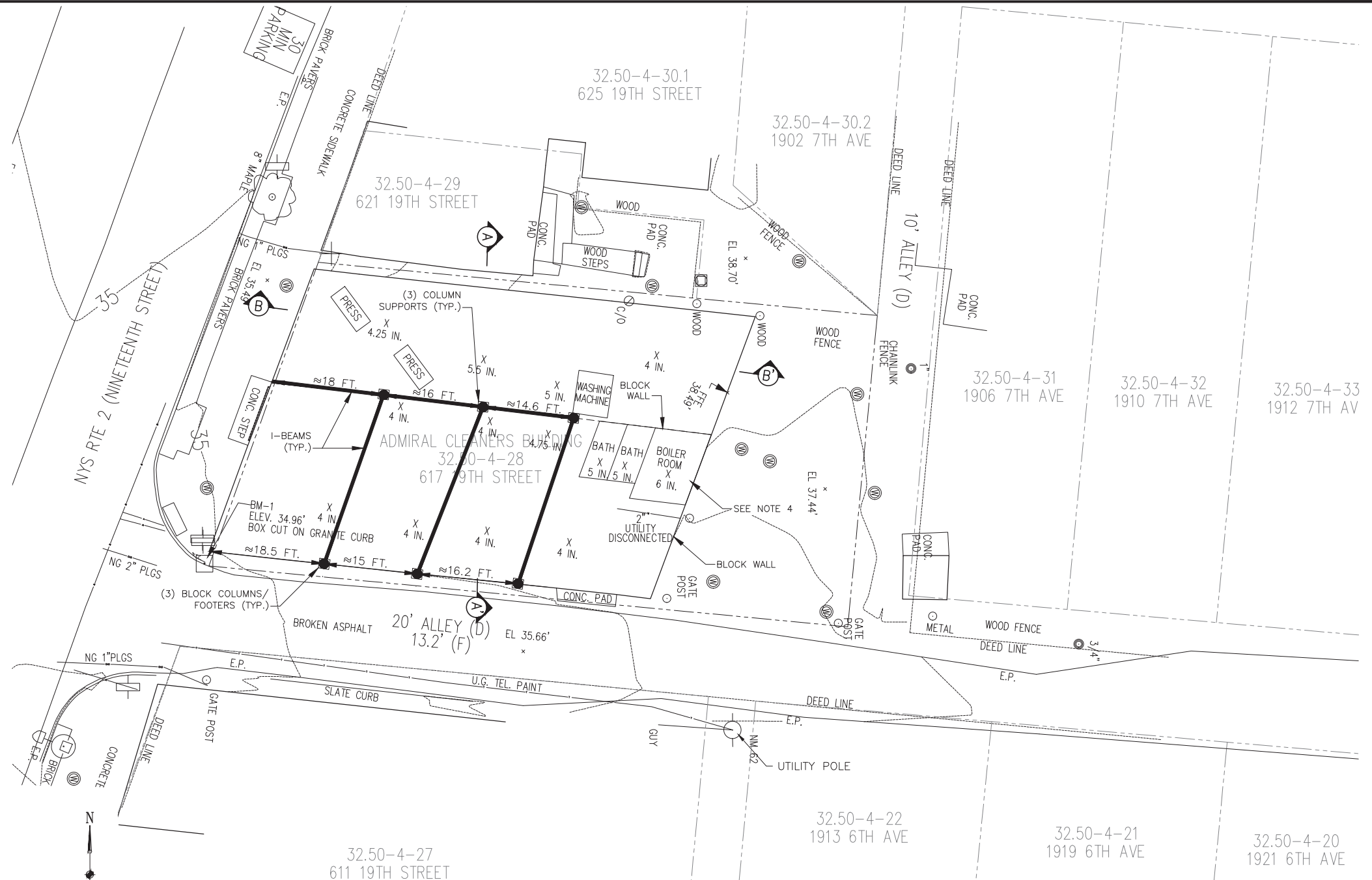

BUILDING PLAN



WARNING - IT IS A VIOLATION OF NEW YORK EDUCATION LAW, ARTICLE 145, SECTION 7209.2, FOR ANY PERSON, UNLESS HE OR SHE IS ACTING UNDER THE DIRECTION OF A LICENSED PROFESSIONAL ENGINEER OR LAND SURVEYOR, TO ALTER THIS DOCUMENT IN ANY WAY. IF ALTERED, THE ALTERING ENGINEER OR LAND SURVEYOR SHALL COMPLY WITH THE REQUIREMENTS OF NEW YORK EDUCATION LAW, ARTICLE 145, SECTION 7209.2.

Department of Environmental Conservation
NEW YORK OPPORTUNITY

NO.	DATE	DESCRIPTION	REVISIONS

BUILDING PLAN & SECTION VIEWS

ADMIRAL CLEANERS SITE
NYS REGISTRY NO. 401075
617 19TH STREET
WATERVILLE, NEW YORK

PREPARED BY:
EA ENGINEERING, P.C.
AND ITS AFFILIATE
EA SCIENCE AND
TECHNOLOGY

CARRS#	EA #
EA #	1490738
DESIGN #	
FILE	1490738PlanSet.dwg
DRAWN BY	DPA
DATE	APRIL 2019
SCALE	AS SHOWN
SS	

SHEET # 5

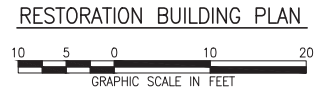
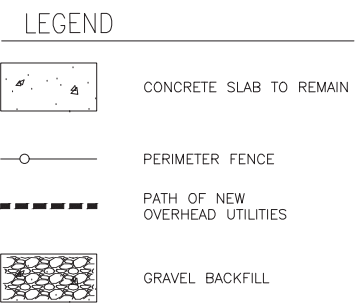
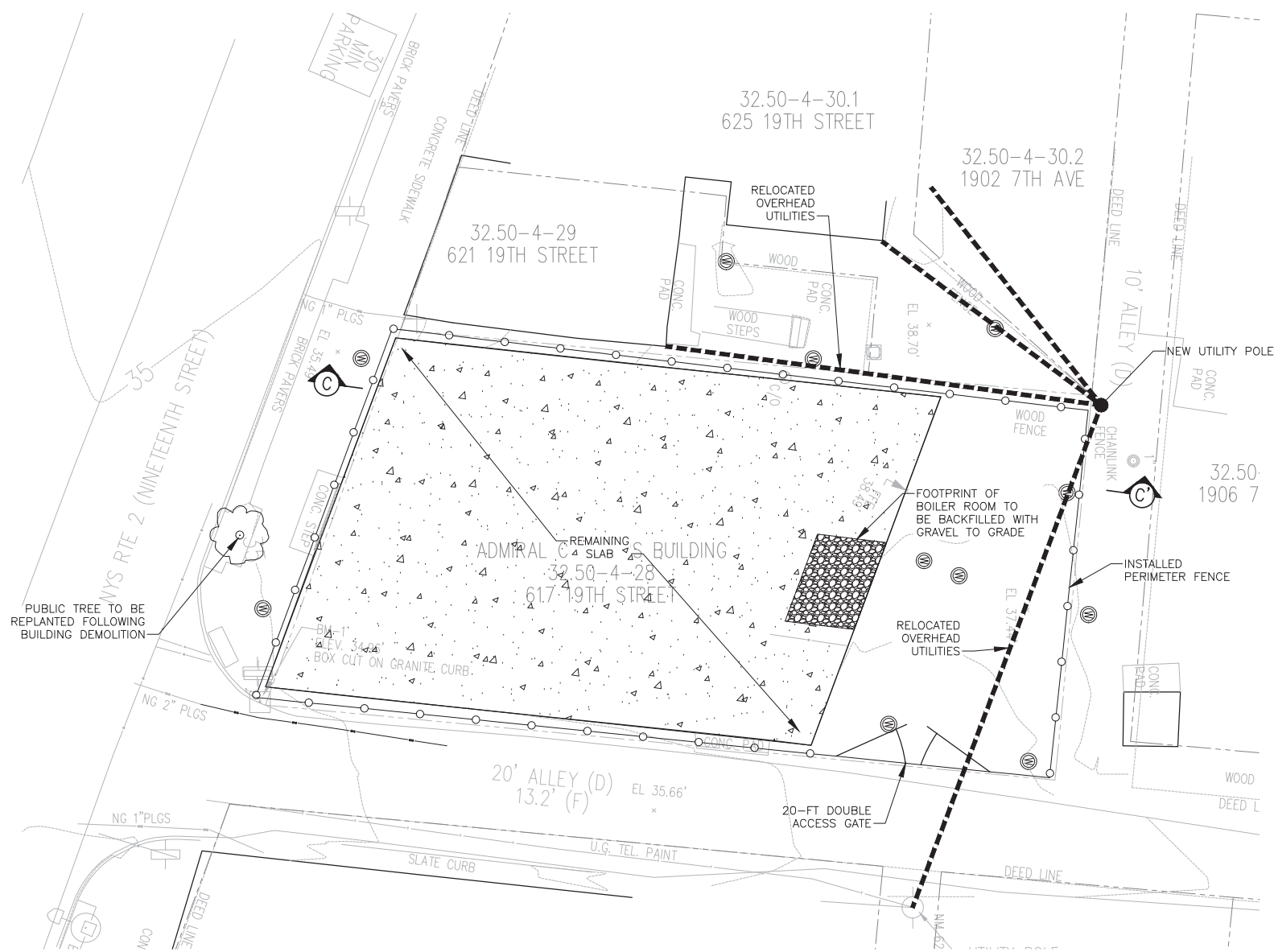
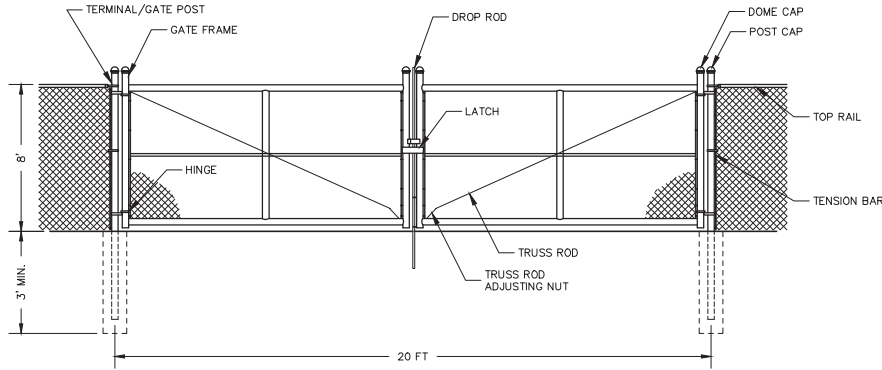
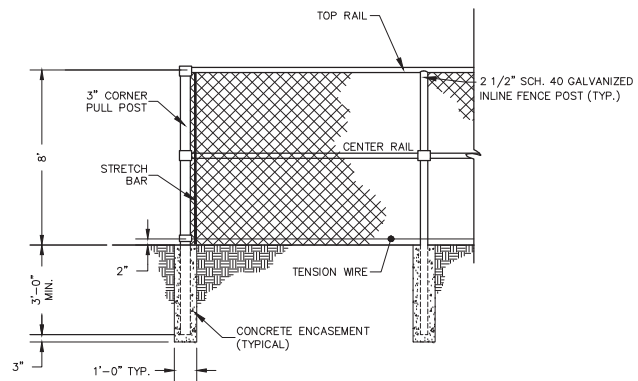
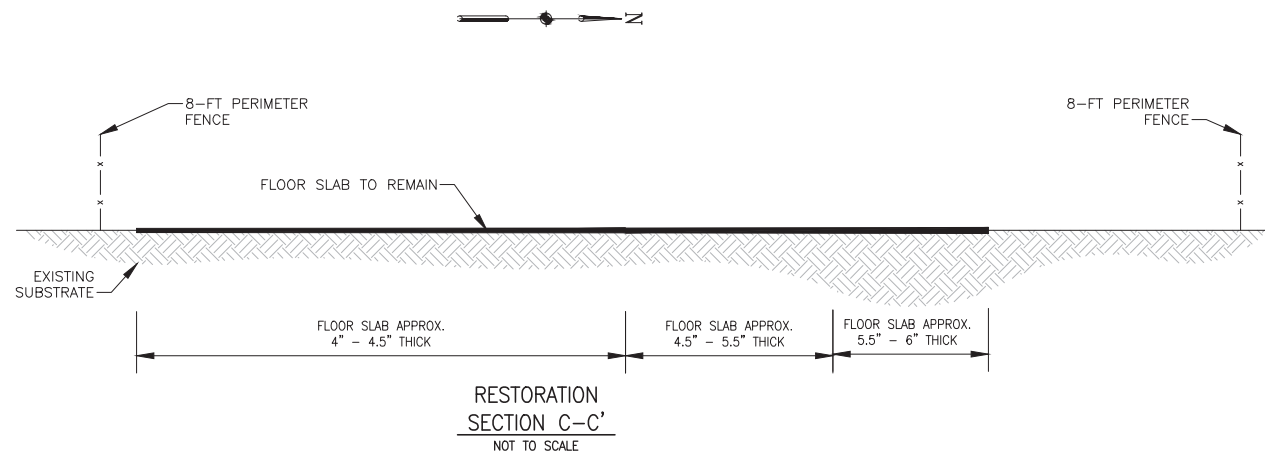

- SITE RESTORATION NOTES**
- BUILDING SLAB TO REMAIN IN PLACE FOLLOWING BUILDING DEMOLITION.
 - CONTRACTOR TO BACKFILL BOILER ROOM WITH GRAVEL TO GRADE.

WARNING - IT IS A VIOLATION OF NEW YORK EDUCATION LAW, ARTICLE 145, SECTION 7209.2, FOR ANY PERSON, UNLESS HE OR SHE IS ACTING UNDER THE DIRECTION OF A LICENSED PROFESSIONAL ENGINEER OR LAND SURVEYOR, TO ALTER THIS DOCUMENT IN ANY WAY. IF ALTERED, THE ALTERING ENGINEER OR LAND SURVEYOR SHALL COMPLY WITH THE REQUIREMENTS OF NEW YORK EDUCATION LAW, ARTICLE 145, SECTION 7209.2.

NO.	DATE	DESCRIPTION	REVISIONS

SITE RESTORATION DETAILS
ADMIRAL CLEANERS SITE
NYS REGISTRY NO. 401075
617 19TH STREET
WATERVILLE, NEW YORK

PREPARED BY:
EA ENGINEERING, P.C.
AND ITS AFFILIATE
EA SCIENCE AND
TECHNOLOGY



CARRS#	EA #
EA #	14907.38
DESIGN #	
FILE	1490738-PlanSet.dwg
DRAWN BY	DPA
DATE	APRIL 2019
SCALE	AS SHOWN
SS	

Appendix C

Emergency Structural Condition Assessment

This page intentionally left blank

RUSS REEVES, CEng., P.E.
CIVIL-STRUCTURAL ENGINEERS

P.O. Box 1433
Troy, New York 12181-1433

Tel: 518-273-0774
e-mail; rreeves2@nycap.rr.com

December 8th , 2018

Jeremy Smith
General City Manager
jsmith@watervliet.com
Watervliet City Hall
2 Fifteenth Street
Watervliet, New York 12185

Re: Emergency Structural Condition Assessment 617 Nineteenth Street (the former Admiral Cleaners), Watervliet, New York

Dear Jeremy:

On December 7th , 2018 at approximately 1:40 pm Engineering Technician Barbara Tozzi and I arrived at 617 19th Street where we met with you, Code Enforcement Officer Paul Laboissiere and NYS DEC representatives including DEC project manager Joshua Haugh. The purpose of this site visit was to evaluate the interior and exterior portions of the structure as it relates to public safety.



Photograph 1

Photograph 1 shows the front Southerly elevation view of the building as seen from 19th Street. The building consists of the original structure which includes the entrance door and large window section as seen in Photograph 1. A later addition was constructed on the West side of the original building so as to provide for additional clear span open space. The addition can be seen in Photograph 1 to the left of the sign.

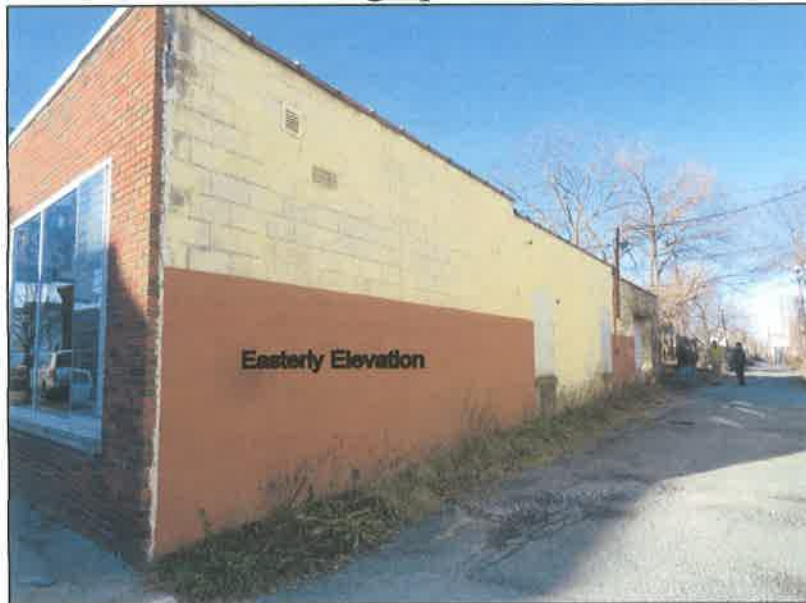

Photograph 2



Photograph 3

Photographs 2 and 3 show the Easterly and Northerly elevation views respectively. There are numerous roof penetrations where water damage

is present. The roof underlayment and roof joists exhibit significant deterioration and rotting specifically along the Northeasterly and Northwesterly quadrants of the building. There is a transverse fracture crack that extends nearly the entire length of the Northeasterly wall section of the original building. This is more specifically shown in Photographs 3 and 4. This is the direct result of failing roof joists exerting eccentric loads on the rear CMU bearing wall and causing a rotational mode of failure in this upper wall section. This has produced a condition of instability in the upper rear bearing wall.



Photograph4

It shall be noted that various portions of the building have been subjected to extensive water damage and deterioration for a number of years. Unbalanced snow loads result in a mal-distribution of loads which cause unstable eccentric loading to the roof system and main beam support systems in the skeletal framing of the roof. This creates significant structural deficiencies associated with this structure. A localized collapse of the upper portion of the Northeasterly bearing wall as depicted in Photographs 3 and 4 is considered imminent at this time.

The original building consists of a front, rear and Easterly exterior concrete block bearing walls (a three sided structure). Intermediate steel bearing beams span in an East / West direction. Roof joists span in a

North / South direction and are in varying states of deterioration due to the aforementioned water damage. Portions of the roof structure are highly unstable. This specifically occurs along the Northwesterly and Northeasterly quadrants of the building. Any manipulation of the structure in these areas will result in a partial collapse of the roof structure and rear wall. This structure is considered a hazard to public safety. A localized collapse of portions of the roof structure under the dead load of the roof framing are also considered imminent at this time.

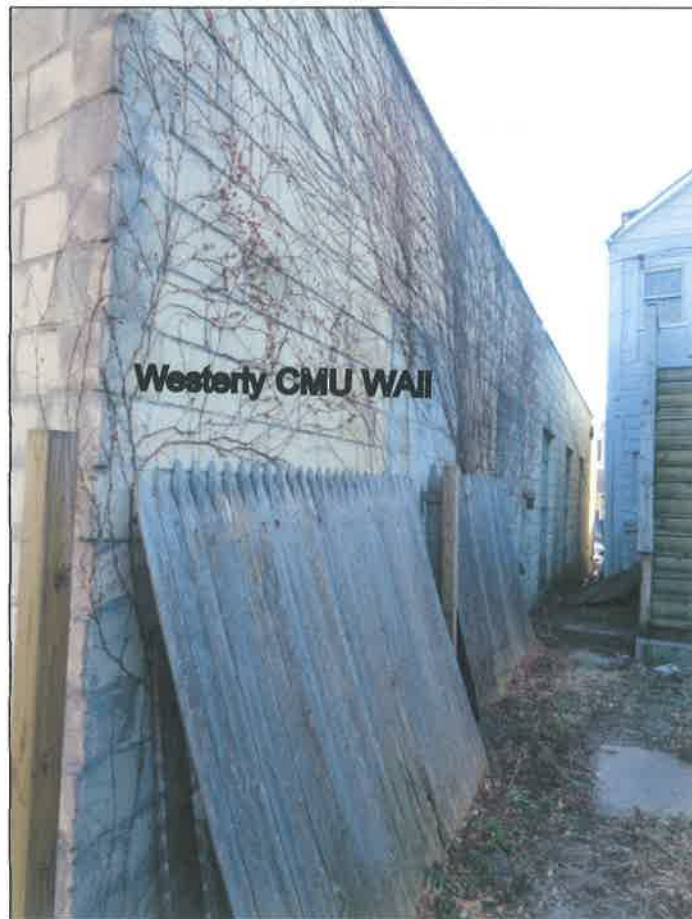

Photograph 5

Photograph 5 shows the Westerly elevation view of the exterior concrete block bearing wall. The Westerly addition contains timber roof framing members that span in an East / West direction, 90 degrees to that of the original structure roof framing. There are substantial roof leaks in the addition. Water is saturating portions of the Northwesterly rear CMU block wall and Northwesterly side wall as shown in Photograph 7. Over

the years successive freeze / thaw cycles are deteriorating the masonry block wall assembly.

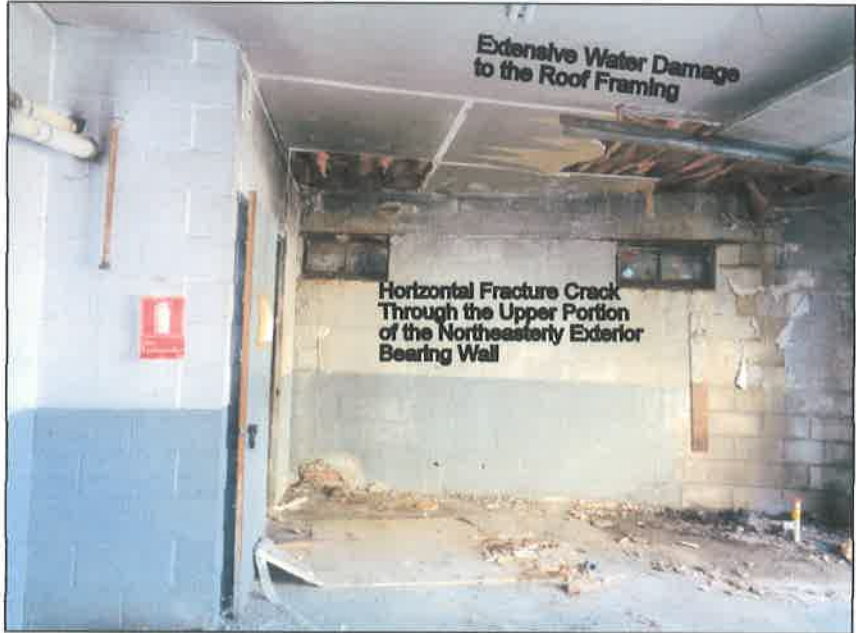

Photograph 6



Photograph 7

The entire Northwesterly rear wall is separating from the adjacent bearing wall of the original building. There is no mechanical attachment of the rear Northwesterly CMU wall into the adjacent block bearing wall thus making a highly unstable condition. Daylight can be seen on the

interior portion of the building at this joint interface. The Northwestern rear wall is highly unstable.



Photograph 8

Photograph 6 shows a typical view of the Northeasterly rear bearing wall. The upper portion of this rear wall is in rotational failure as we indicate earlier in this report. There is extensive water damage and deterioration to the roof framing members.

It shall be noted that there are lag screws connecting heavy mechanical equipment and assorted piping into water saturated and deteriorated roof joist members. Because of the deteriorated nature of the roof framing, some of the mechanical attachments are failing in a pull-out mode of failure thus creating an overhead hazard for falling mechanical framing and devices. Please refer to Photograph 8 for a typical view of the condition of some of the piping and mechanical tracks and devices that we found in these areas. It shall be further noted that any manipulation on the ceiling area could result in failure in the lag screw assembly of the supporting steel tracks, mechanical devices and clevis hangers that are screwed into the roof framing. Overall we find that there is a substantial hazard within the interior of the building for the failure of overhead devices that are secured into the deteriorated roof structure.

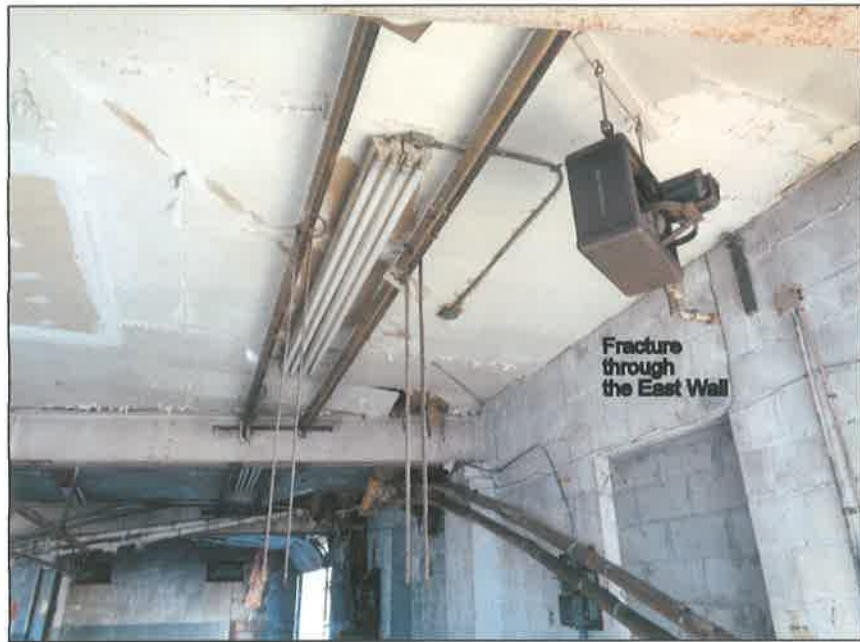

Photograph 9



Photograph 10

Photograph 9 was taken on the Easterly side of the original building. There is a vertical fracture crack through the East wall as can be seen in the photograph. This was due to improper reinforcing within this wall section and improper reinforcing of a lintel over a former opening which is also depicted in this photo. We are bringing this to your attention because the entire fracture lies over an unsupported edge of this former

window or door opening. Also shown in the photograph are improperly supported and failing piping and mechanical tracks that are pulling away from wall and roof framing members. Any personnel that are accessing the interior of the structure shall be mindful of these equipment fall hazards as well as the collapse hazards of the roof framing and rear wall assemblies.

Photograph 10 shows a typical view of the roof framing members along the Westerly side of the building. Roof joists are not framed into and bearing on the exterior Westerly concrete block wall. The roof framing members bear on a 2" x 6" leger with 1 1/2" end bearing only as depicted in Photograph 10. This is inadequate and structurally deficient for this application. All legers used for structural applications of this type require an epoxy bolted threaded rod either 1/2" or 5/8" in diameter or if the masonry is reinforced with concrete placed in the interior cores, where expansive concrete bolt anchors can be used for this application. Instead, we find that powder actuated concrete nails were used in this instance which are not appropriate or sufficient to safely support the live and dead loads associated with this roof structure. With the impending snow, this will be problematic for a localized joist bearing failure which will be compounded by the deteriorated roof joist system.



Photograph 11



Photograph 12

In order to obtain clear span openings between the original building and the addition, large wide flange steel beams were inserted to support the upper masonry wall sections of the original structure as shown in Photographs 11 and 12. These are heavy loads imposed on the beam sections, columns and connections. In addition to the weight of the upper concrete block bearing wall, roof framing members from the Westerly addition are supported by this steel beam and column assembly. During the course of our evaluation, we noted that some of the beam and column connections were improperly made and are highly structurally deficient. Eccentric loads have been placed on columns and improper beam shims have been installed as depicted in Photograph 12. These structural deficiencies that we have encountered are a concern because if a localized collapse of roof framing members occurred, this will induce lateral loads and a thrusting action against this masonry wall assembly which is shown in Photograph 11 and will result in a roll-over effect in the beams which are shown in Photograph 12 thus destabilizing the column support assembly. This collapse mechanism is a high hazard condition.

Only authorized personnel are permitted to enter the building and on a strictly limited basis only due to the aforementioned hazardous conditions that we have encountered.

It shall be noted that a partial collapse of the upper rear half of the Northeasterly CMU block bearing wall and the Northwesterly CMU bearing wall building is considered imminent at this time. The adjacent house to the West is occupied. A partial collapse of the Northerly portion of the roof is also considered imminent at this time. This collapse event will induce a destabilization and partial collapse of the beam and column supported block wall assembly that is located between the original building and the addition.

The present condition of the building is considered a hazard to public safety and shall be removed as soon as practicable under the City of Watervliet's Emergency Condemnation Procedures.

Only a qualified, fully insured contractor shall be selected for this purpose. The contractor is wholly responsible for workers' safety, DOL and OSHA compliance. Access of unauthorized personnel is prohibited due to the hazard classification. Prior to any demolition procedures, all utilities with confirmation shall be terminated at the curb line (water/ sewer), at the power pole (electrical service) and in the street (gas)

If you have any questions please do not hesitate to call.

Very truly yours,

Russ Reeves PE
R. Russell Reeves, CEng., P.E.

cc: Barb Tozzi, Engineering Technician
btozzi3@gmail.com
Reeves Engineering



Joshua Haugh
Engineering Geologist 2 Region 4
Joshua.haugh@dec.ny.gov

This page intentionally left blank

Appendix D

Project Responsibilities for Admiral Cleaners Site Interim Remedial Measure

This page intentionally left blank

NEW YORK STATE DEPARTMENT OF ENVIRONMENTAL CONSERVATION

Division of Environmental Remediation, Remedial Bureau E
625 Broadway, 12th Floor, Albany, NY 12233-7017
P: (518) 402-9813 | F: (518) 402-9819
www.dec.ny.gov

MEMORANDUM

TO: Richard Mustico, Regional Hazardous Waste Remediation Engineer, Region 4

FROM: David Harrington, Chief, Remedial Section A, Remedial Bureau E *David Harrington*

SUBJECT: Project Responsibilities for Admiral Cleaners Site Interim Remedial Measure, Site No. 401075

DATE: January 16, 2019

The New York State Department of Environmental Conservation (DEC) in consultation with the New York State Department of Health (DOH) will be conducting an interim remedial measure (IRM) involving the demolition and offsite disposal of the former Admiral Dry Cleaners building in the City of Watervliet, Albany County beginning in Spring 2019. The IRM for the Site consists of building demolition which has been identified by the Department's Division of Environmental Remediation (DER) as necessary for the protection of public health and the environment. Building demolition has been determined necessary to complete the remedial investigation and to eliminate a continued potential source of contaminant release, transport, and exposure to the public and environment in the vicinity of the Site. The protection of public health extends not only to the chemical contamination, but also to the potential physical hazards represented by the current condition of the former Admiral Cleaners building.

This memorandum outlines the general responsibilities for managing the upcoming subject project anticipated to commence in Spring 2019.

Designated Representative David Harrington - Acts as the DEC's designated representative during the IRM. Responsible for resolving all disputes involving remedial construction activities that may arise between the Engineer, Contractor and the Project Manager.

Project Manager David Chiusano - Responsible for administration of the IRM work required. Also, the Project Manager is responsible for the coordination with the Engineer and Inspector. Receives and reviews daily and monthly reports (verbal and written) from Inspector. Communicates and coordinates DEC and DOH concerns and reviews. Responsible for coordinating review of design changes with Region 4 staff. Is responsible for assuring project is proceeding

satisfactorily per the approved project plans. Responsible for resolving problems with input from appropriate reviewers and assistance from Designated Representative as appropriate. The Regional Hazardous Waste Engineer and DEC Field Representative will be advised of project schedule, all sensitive project issues and any public concerns. Responsible for coordination of Citizen Participation (CP) activities with input and assistance from DEC Field Representative and Regional CP Specialist.

Engineer EA Engineering, P.C. (EA) - Standby Engineering Consultant will be responsible for providing construction management and engineering services during the IRM. Reports directly to the Project Manager. The duties and responsibilities and limitations of authority of the Engineer during construction are set forth in their Standby Contract Work Assignment No. D007624-38.

Inspector EA - Responsible for providing full-time inspection services. The duties and responsibilities and limitations of authority of the Inspector during construction are set forth in the Standby Contract Work Assignment No. D007624-38.

DEC Field Rep. Joshua Haugh - At the Regional Hazardous Waste Engineer's direction, regional staff may assist EA with inspection of the remedial work, attend bi-weekly progress meetings along with Project Manager, Engineer, Inspector and Contractor.

Contractor Precision Environmental Services (PES) - Selected by the DEC and responsible to implement the IRM under the terms of their standby contract C100614.

Concept DEC is responsible for remediation at the Admiral Cleaners site utilizing State superfund monies. IRM construction activities will be performed by PES. The Project Manager, Engineer, and Inspector will verify that their activities comply with the approved plans and specifications. The Engineer is expected to identify any deviations from the approved plans and specifications, as well as, any deficiencies in the work or workmanship which could diminish the effectiveness of the IRM. As part of these responsibilities, the Engineer shall check that all materials and equipment incorporated into the work are as specified and that all test results are within the specified limits. The DEC Field Representative (PFR) may be requested by the Project Manager to be present during critical portions of construction and for any public interaction. Furthermore, the PFR should identify to the Project Manager any concerns regarding the Inspector's performance in providing construction inspection services.

A more detailed outline of duties and responsibilities has been attached. If you have any questions, please call me at (518) 402-9813 or David.Harrington@dec.ny.gov.

Attachment

ec: M. Cruden, Director, RBE, DER
G. Burke, Director, RBB, DER
K. Kulow, NYSDOH
D. Conan/C. Schroer, EA
D. Harrington, DER
K. Goertz/V. Schmitt/R. Mustico/J. Haugh, NYSDEC-Region 4
D. Chiusano, DER

ADMIRAL CLEANERS SITE 401075
BUILDING DEMOLITION IRM
DUTIES AND RESPONSIBILITIES

See Recommended Standards for the Responsibility, and Behavior of the Inspector (attached). The following are specific instructions for the Admiral Cleaners site remediation and supersede the Recommended Standards if there is a conflict.

1. Project Manager/Engineer is responsible for decisions on acceptability of the work based on information and recommendations provided by the Inspector.
2. The Project Manager shall review measurements for payment made by Engineer and Inspector. Inspector must complete review of Contractor's Application for Payment within five (5) days of receipt. The Project Manager will provide guidance and assistance, as necessary.
3. Daily Inspection Reports are to be completed by Engineer/Inspector. Inspector shall submit daily reports in electronic format at the end of each day to Project Manager, DEC Field Representative, and Regional Engineer. In addition, the following should be included:
 - a. Report on issues concerning Contractor's compliance with the Health and Safety Plan as they would impact DEC personnel and the community.
 - b. Details of all actions by and conversations with public, news media and representatives. Resolution/decisions on field problems. Department is responsible for public interaction. All public interaction is to be coordinated with the CP Specialist.
 - c. Report Contractor's performance.
4. Engineer will contact Project Manager as necessary to discuss progress and happenings on the contract. Final decisions on construction contract issues will be made by Project Manager.
5. Inspector will issue field orders only after approval by Engineer and Project Manager. Field orders can only be used on issues that do not involve cost or time.
6. Project Manager and Inspector shall coordinate health concerns raised by the public with the New York State Department of Health (DOH). Project Manager shall provide DOH representatives with project updates on a regular basis.
7. Project Manager/Engineer and Inspector shall attend job meetings. Project Engineer will chair job meetings and will prepare minutes for distribution to attendees (and to DOH representative).

9. Inspector will be providing full-time inspection of construction at the site. The Inspector shall conduct: (1) an inspection upon substantial completion; and (2) final inspection upon project completion. Substantial completion and final inspections shall be coordinated with the Project Manager and DEC Field Representative.
10. Inspector shall give particular attention to PES's performance with regards to:
 - a. Prevention of off-site migration of any solid wastes moved from point to point.
 - b. Continuous vibration monitoring, dust monitoring, odor suppression, dust suppression techniques and the generation of visible dust.
 - c. Visible tracking of soil or water on streets and the precautions taken to prevent such occurrence. Removal of spilled materials from transit roads.
 - d. Repair of visible oil or hydraulic fluid leaks on equipment and machinery used at the site.
 - e. Real time and documentation monitoring (health and safety).
11. In addition to the above, the Inspector shall give particular attention to the following aspects of the work:
 - a. Building demolition (building contains ACM). Contaminated building debris removal, on-site staging and off-site disposal of non-hazardous material.
 - b. Vibration monitoring, inspection, and protection of adjacent building structures.
 - c. Surface water handling, treatment, sampling, and disposal.
 - d. Contractor disruption of school bus traffic and local businesses.
12. Inspector will keep Project Manager and DEC Field Representative informed of present and upcoming operations on an as needed basis.
13. Project Manager will coordinate internal DEC reviews (e.g., Region 4 office).
14. Project Manager, Engineer, DEC Project Field Representative, and Inspector will attend preconstruction conference. Engineer will prepare and distribute meeting minutes.

15. The Project Manager, Engineer, DEC Project Field Representative, and Inspector shall review all Contractor submittals for compliance with project plans and design concept. This shall include review of shop drawings, materials, soil test, construction tests, progress payment requests, and any other documents generated by NV in connection with this project. Inspector shall provide comments to Project Manager/Engineer who will approve submittals. Shop drawing/submittal review must be completed within 14 days.
16. The Inspector will maintain complete and detailed records related to construction activities, including:
 - a. Work completed and important conversations.
 - b. Daily inspections reports.
 - c. Records documenting Contractor's deviation from work as specified in the Contract Documents with actions and resolutions.
 - d. Marked up drawings to be used to verify the accuracy and completeness of Contractor's record drawings.
 - e. Record progress in reference to approved schedule.
 - f. Construction photos.
 - g. Log of proposed and executed change orders, field orders, contractor application for payments and shop drawing submittals.
 - h. General files including correspondence, manifests, bills of lading, contractor's logs, submittals, field orders, change orders and job meeting minutes.
 - i. Maintain summary records (logs) of date, location, sample ID, type, result and action for sampling results and air monitoring results.
 - j. Maintain summary records (logs) of date, manifest number/bills of lading number, description, transporter, disposal facility and quantities for off-site disposal (as appropriate).
17. Inspector will prepare field orders for review and approval by Project Manager/Engineer prior to issuance. Proposed change orders and change orders will be prepared by Project Engineer/Manager.

18. Engineer will prepare a Construction Completion Report. The report will reflect all variations from the project plans, characterization sampling and results, as-builts and recommendations of future work at the site. The Engineer shall certify that the contract was completed in accordance with the Contract Documents. The report shall be drafted for review within 30 days of substantial completion.

CONSTRUCTION MANAGEMENT

1. Shop Drawing/Submittal Log

Information regarding shop drawings/submittals required by specifications, dates submitted, dates returned, status of review and number of reviews should be readily available.

Missing approvals are to be a major point of discussion at project meetings.

2. Schedule

Engineer should track dates submitted, dates returned and status of review. No payment without approved schedule.

Major point of discussion at every project meeting. After approval, discussion should center on Contractor's progress with respect to the approved schedule and corrective actions necessary or proposed to make up lost time. Agreements regarding time extensions should be incorporated into a revised schedule.

3. Overruns/Underruns

Spreadsheet should be utilized to keep up-to-date track of contract quantities, need for change orders, payments, estimates to completion and agreed to extras.

4. Subcontractors

Require Contractor to keep up-to-date list consisting of name, address, telephone, contact, type of work, dollar amount, M/WBE status and UCQ submission.

5. Reference Materials

Necessary documents such as Part 360, Part 371, Part 375, DER-10, 12 NYCRR Part 56, Contract Documents and others as applicable should be in the field office (or readily accessible via the Engineer's home office). A complete set of the Contract Documents (including modifications) must be maintained at the field office.

Industry accepted pricing guides such as Means Construction Cost Data and Blue Book Rental Rates should be readily available to the Engineer.

6. Health and Safety

Information regarding real time and documentation air monitoring consisting of date, time, analytical results, sample collection points, wind direction (and other pertinent meteorological data), applicable standards and engineering controls implemented should be readily available. A log of violations to the HASP and an appropriate credit should be maintained by the Engineer.

7. Confirmatory and Documentation Sampling

Information regarding date, location, depth, result, applicable cleanup goal, chain of custody and decisions regarding stop/continue excavation should be readily available.

8. Waste Streams

Information regarding date, quantities, type, facility, transporter, manifest and other pertinent data should be readily available.

9. Photo Log

Information regarding photo number, date, location and description should be readily available.

10. NYS Hazardous Waste Regulations

Ensure Contractor confirms in writing that designated TSDF has authority and capacity.

Ensure Contractor confirms in writing that transporter is authorized (permitted).

Contractor must comply with storage requirements of 372, including labeling of drums and maximum time limits.

Meeting Minutes

Engineer needs to ensure that the minutes adequately document the issues raised and any resolution agreed to by PES. Sufficient detail needs to be presented to hold NV to their word. As the preparer of the meeting minutes, the Engineer has substantial control over the content and tone. By taking a strong stance it places the responsibility on PES to object to the content of the minutes at the next meeting. In future disputes down the line the meeting minutes should form a record which benefits the Department and weakens NV's position.

Conclusion

The purpose of this document is only to emphasize areas which have not received enough attention on past projects. In general, the Engineer should ensure that their project management and field personnel are thoroughly familiar with the requirements of their standby engineering contract.

* END *

This page intentionally left blank