



**SAMPLING MANUAL
LOVE CANAL SITE
LONG-TERM GROUNDWATER
MONITORING PROGRAM**

**Occidental Chemical Corporation
Love Canal Site
Niagara Falls, New York**

RE-PRINTED ON:

FEBRUARY 19, 2001



**SAMPLING MANUAL
LOVE CANAL SITE
LONG-TERM GROUNDWATER
MONITORING PROGRAM**

**OCCIDENTAL CHEMICAL CORPORATION
LOVE CANAL SITE
NIAGARA FALLS, NEW YORK**

**JANUARY 1996
REF. NO. 4341 (13)**

**Prepared by:
Conestoga-Rovers
& Associates**

651 Colby Drive
Waterloo, Ontario
Canada N2V 1C2

Office: (519) 884-0510
Fax: (519) 884-0525

web: <http://www.CRAworld.com>

TABLE OF CONTENTS

	<u>Page</u>
1.0 DESCRIPTION OF SITE.....	1
1.1 SITE DESCRIPTION.....	1
1.2 REMEDIAL SYSTEMS	1
1.3 MONITORING NETWORK	2
1.4 SITE GEOLOGY	2
1.4.1 Overburden.....	2
1.4.2 Bedrock	3
1.5 LOVE CANAL HYDROGEOLOGY	4
1.5.1 Overburden.....	4
1.5.1.1 Overburden Properties.....	4
1.5.2 Bedrock	5
1.5.2.1 Lockport Dolomite	5
2.0 MONITORING REQUIREMENTS	6
3.0 INFORMATION ON WELLS	8
4.0 MONITORING SCHEDULE	9
5.0 PREPARATION FOR SAMPLING	10
5.1 AGENCY NOTIFICATIONS	10
5.2 EQUIPMENT INVENTORY.....	11
5.3 SAMPLING SUPPLIES INVENTORY	11
5.4 EQUIPMENT OPERATION	11
5.4.1 Peristaltic Pump	12
5.4.2 Geoguard Airlift and Bladder Pumps.....	13
5.4.2.1 Airlift Pump	13
5.4.2.2 Bladder Pump.....	15
5.5 METER CALIBRATION	16
5.5.1 General	16
5.5.2 pH Calibration.....	16
5.5.3 Specific Conductivity Meter Calibration	16
5.5.4 Temperature Calibration	17
5.5.5 Turbidimeter Calibration.....	17
5.5.6 Photoionization Detector Meter Calibration	17
5.6 CLEANING REQUIREMENTS.....	18
5.7 VENDORS DATA/INSTRUCTION OR USE MANUALS	18
5.8 PURCHASE ORDERS	18

TABLE OF CONTENTS

	<u>Page</u>
6.0 SAMPLING PROCEDURES.....	19
6.1 GENERAL PROCEDURES	19
6.2 GENERAL HEALTH AND SAFETY.....	20
6.3 WATER LEVEL MEASUREMENT.....	21
6.4 WELL PURGING.....	22
6.5 SAMPLE COLLECTION	23
6.6 SAMPLE HANDLING AND SAMPLING DOCUMENTATION	24
6.6.1 SAMPLING DOCUMENTATION.....	24
6.6.1.1 Field Notebook.....	25
6.6.1.2 Sample Collection Logs	26
6.6.1.3 Instrument Calibration and Use Logs.....	26
6.7 SAMPLE CONTAINERS.....	27
6.8 SAMPLE IDENTIFICATION.....	27
6.9 SAMPLE CUSTODY	28
6.9.1 Field Custody	29
6.9.2 Transfer of Custody and Shipment.....	30
6.9.3 Sample Shipment Procedures.....	31
6.10 DECONTAMINATION PROCEDURES.....	31
6.11 WASTE MATERIAL HANDLING.....	32
6.11.1 Decontamination Fluids Disposal	32
6.11.2 Groundwater Disposal.....	32
6.11.3 Solid Waste	32
7.0 ANALYTICAL REQUIREMENTS.....	33
7.1 LABORATORY METHODS AND LEVEL OF REPORTING.....	33
7.1.1 Analytical Methods	33
7.2 QUALITY ASSURANCE/QUALITY CONTROL.....	33
7.2.1 Field Duplicate Samples.....	33
7.2.2 Matrix Spike/Matrix Spike Duplicate Samples.....	34
7.2.3 Deionized Water Blank	34
7.2.4 Rinse Blanks.....	34
7.2.5 Trip Blanks.....	35
7.3 CONTRACT LABORATORY	35
7.4 BOTTLES, SAMPLE PRESERVATION AND HOLDING TIMES	35

TABLE OF CONTENTS

	<u>Page</u>
8.0 INTERPRETING RESULTS	37
9.0 REPORTING	38
10.0 REQUIRED DATES FOR SUBMISSION OF DATA.....	39
11.0 TROUBLESHOOTING	40
12.0 LTM PROGRAM TRAINING.....	41
13.0 AUDIT CHECKLIST.....	42

LIST OF FIGURES

Following
Report

- | | |
|------------|---|
| FIGURE 1.1 | SITE PLAN |
| FIGURE 1.2 | GENERALIZED CROSS-SECTION |
| FIGURE 1.3 | BARRIER DRAIN, WELL AND PIEZOMETER
LOCATIONS |
| FIGURE 1.4 | TYPICAL OVERBURDEN GROUNDWATER CONTOURS |
| FIGURE 5.1 | SAMPLE PURCHASE ORDER REQUISITION |
| FIGURE 6.1 | SAMPLE COLLECTION LOG FORM |
| FIGURE 6.2 | WELL INSPECTION SUMMARY |
| FIGURE 6.3 | SAMPLE CHAIN OF CUSTODY FORM |

LIST OF TABLES

Following
Report

TABLE 2.1	HYDRAULIC MONITORING REPORT PIEZOMETERS
TABLE 2.2	GROUNDWATER MONITORING NETWORK WELLS
TABLE 3.1	MONITORING WELL CONSTRUCTION DETAILS
TABLE 4.1	PROPOSED MONITORING SCHEDULE THROUGH 1997
TABLE 5.1	SUMMARY OF OFF-SITE WELL CONTACTS
TABLE 5.2	SAMPLING EQUIPMENT INVENTORY
TABLE 5.3	SAMPLING SUPPLIES INVENTORY
TABLE 7.1	LONG-TERM MONITORING PROGRAM ANALYTICAL PARAMETERS
TABLE 7.2	SAMPLE CONTAINERS, PRESERVATION, AND HOLDING TIMES

LIST OF APPENDICES

APPENDIX A	VENDORS INFORMATION
APPENDIX B	OXYCHEM P.O. PROCEDURES
APPENDIX C	HISTORICAL SAMPLING LOGS
APPENDIX D	FIELD PROCEDURESS
APPENDIX E	HISTORICAL ANALYTICAL DATA
APPENDIX F	TRAINING CERTIFICATION

1.0 DESCRIPTION OF SITE

1.1 SITE DESCRIPTION

The Love Canal Site (Site) is a 64 acre rectangular site bounded by Colvin Boulevard on the North, 99th and 100th Streets to the East, 95th and 97th Streets to the West and Frontier Avenue to the South. A Site Plan is provided as Figure 1.1.

1.2 REMEDIAL SYSTEMS

Remedial Action to prevent the off-site migration of chemical contaminants from the Site, began in October 1978 with the installation of a barrier drain along the east and west sides of the south section of the Canal. The barrier drain, intended to intercept shallow lateral groundwater flow, consists of a trench which is 15 to 25 feet deep and 4 feet wide. Installed within the trench is an 8-inch diameter perforated clay tile drain centered in 2 feet of uniformly sized gravel which is overlain to the surface with sand. Lateral trenches filled with sand were dug perpendicular to the barrier drain in the direction of the Canal. The tile drain is graded towards a series of manholes and deep wells where the leachate is collected. The leachate is pumped from these deep wells to underground holding tanks where it is held prior to being treated at an on-site treatment facility (Love Canal Leachate Treatment Facility or LCLTF) and discharged into the City sewer system.

A clay cap was installed over the entire Canal area following completion of the barrier drain collection system. The purpose of the cap was to reduce infiltration of precipitation and losses of volatile organics. The thickness of the clay cap varies from 3 feet at its apex tapering to 1 foot on either side.

Figure 1.1 shows the layout of the Site, including the location of the barrier drain, the collection sumps and the LCLTF. Figure 1.2 is a generalized cross-section of the Love Canal, with the location of the wastes, the cap and the trench system shown.

1.3 MONITORING NETWORK

In order to monitor the effectiveness of the barrier drain system in preventing the spread of contaminants off-site, a network of piezometers and groundwater monitoring wells have been installed on the Site, along the perimeter of the Site and in the surrounding community. The piezometers are used to measure the level of the overburden groundwater to demonstrate that the barrier drains are creating an inward hydraulic gradient toward the drains. There are six series of piezometers at which groundwater levels are measured on a quarterly basis.

In order to measure and monitor groundwater chemistry at the Site, approximately 47 monitoring wells are sampled on an annual basis as part of the Long Term Monitoring Program (LTM).

Figure 1.3 shows the location of the piezometers and long-term monitoring program wells in relation to the barrier drain.

1.4 SITE GEOLOGY

1.4.1 Overburden

The overburden materials in the Love Canal vicinity can be classified, from bottom to top, as:

- i) till unit;
- ii) clay unit; and
- ii) thin upper layer of fill and more permeable glacially-derived materials.

The total thickness of the overburden deposits is about 33 feet for the northern and central portions of the Love Canal property and 36 to 39 feet for the southern portion.

The glacial till in the vicinity of Love Canal varies from 0 to 23.8 feet in thickness. At the Canal itself, the till is roughly 14 feet thick in the north

decreasing to 4 or 5 feet around Read Avenue and then increasing to 18 feet for most of the area south of Wheatfield Avenue. The till generally consists of reddish brown, silty clay containing from 20 to 60 percent gravel and some cobbles.

The glaciolacustrine deposits overlying the till consist of 0 to 31 feet of silty clay. The upper 3 to 8 feet of the silty clay is mostly reddish-brown with dark greyish-brown, greyish-brown and yellowish-brown patches observed. Sandy clay zones were also encountered in the glaciolacustrine deposits.

Various layers of silty sand and clayey silt, as described in the previous section, overlie the silty clay and appear to be derived locally although construction debris and industrial wastes are also present. Industrial wastes encountered included coarse-grained carbon wastes. The thickness of the silty sand and clayey silt layer ranges from 0 to 20 feet but is generally about 5 feet. The variable composition at this upper most unit is due in part to the effect of the past activities of excavations and residential development in the Love Canal area.

1.4.2 Bedrock

Bedrock conditions beneath the Love Canal vicinity are typical of those found on a regional scale. The upper surface of the Lockport Formation is relatively smooth and slopes gently to the south. The bedrock surface elevation is about 540 feet above mean sea level beneath the northern and middle portions of the Canal property and 537 feet beneath the southern portion. The thickness of the Lockport in the Canal area is reported to range from 162 to 178 feet.

1.5 LOVE CANAL HYDROGEOLOGY

The hydrogeological regime at Love Canal has been subdivided into five different zones. From uppermost to lowermost, they are:

- i) Shallow System
 - fill, silty sand and clay loam
 - seasonally saturated/unsaturated
- ii) Confining Material
 - clay and till overlying the Lockport Dolomite

- iii) Upper Lockport Dolomite
 - main aquifer located in upper 10-15 feet of formation
 - horizontal bedding joints that are areally extensive
 - significant vertical fracturing present
- iv) Lower Lockport Dolomite
 - lower part of formation (maximum 165 feet thick)
 - bedding joints are the primary groundwater conveyance mechanism
- v) Rochester Shale
 - regional aquitard

1.5.1 Overburden

1.5.1.1 Overburden Properties

Hydraulic testing indicated that all zones of overburden materials have relatively low hydraulic conductivities ranging from 1×10^{-5} cm/s for the more permeable shallow system to on the order of 1×10^{-8} cm/s for the confining clay/till layer. The relatively impermeable deeper clay and till, in which fractures have not been noted, directly overlie the bedrock and serve to impede the vertical movement of groundwater between the overburden and Lockport Dolomite.

Overburden groundwater table elevations are generally in the range of 568 to 571 feet above mean sea level (AMSL). For comparison to the overburden groundwater levels, bedrock groundwater levels range from 560 to 565 feet AMSL. These groundwater levels suggest that a significant downward hydraulic gradient exists from the overburden to the bedrock. Figure 1.4 shows a typical overburden groundwater elevations at the Site.

1.5.2 Bedrock

1.5.2.1 Lockport Dolomite

The Lockport Dolomite is the only important aquifer within the Niagara Falls area with an average transmissivity on the order of $13.9 \text{ cm}^2/\text{s}$ and a storage

coefficient of 0.00015. Within the Lockport, groundwater is present in bedding joints, vertical joints and solution cavities. Of these, bedding joints are the dominant mechanisms of groundwater flow. The nearly horizontal bedding joints, which follow the dip of the formation, are usually less than 1/8 inch in size although some have been enlarged by gypsum dissolution. The bedding joints are of much higher permeability than the surrounding bedrock. The bedding joints are fairly continuous in areal extent so that groundwater may flow over long distances within a single bedding joint. Groundwater levels within these joints were found to decrease with depth. Groundwater movement through vertically oriented joints is relatively significant in the top 10 to 15 feet of the formation. In this zone, weathering and dissolution has widened the joints and created a relatively good aquifer at the top of the dolomite. This upper zone is generally considered much more permeable than the remainder of the underlying bedrock.

Recharge due to precipitation reaches the Lockport throughout the region by migrating through the glaciolacustrine sediments and glacial till. Somewhat higher recharge rates are believed to occur along the Niagara Escarpment where overburden is thin or absent.

In general, groundwater flow in the Upper Lockport Dolomite is to the north or northwest away from the River. The Niagara River is a source of bedrock recharge.

2.0 MONITORING REQUIREMENTS

In order to document that the barrier drain system is functioning as designed, a hydraulic and chemical monitoring program have been established to measure and record overburden groundwater levels quarterly and to collect groundwater samples from the Site for laboratory analysis on an annual basis.

The hydraulic monitoring program consists of the quarterly measurement of water levels in 94 piezometers and 10 wells located in six nested piezometer strings and around the Site as shown on Figure 1.3 and listed on Table 2.1. Water level monitoring procedures are described in Section 6.3. As each of these alignments includes piezometers both within and outside the barrier drain, it is possible to determine the hydraulic gradient in relation to the barrier drain system and to establish whether this gradient is inward (toward the barrier drain) indicating that the system is functioning properly to prevent the outward flow of contaminants from the Site.

The chemical monitoring program consists of the collection of groundwater samples from 19 wells on an annual basis and an additional 28 wells which are monitored on a bi-annual basis. The 28 bi-annual wells are divided into two groups, with each group being sampled in alternating years (i.e. one group in years 1, 3, 5; the second group in years 2, 4, 6, etc.). Table 2.2 lists the monitoring wells to be sampled annually and the two groups of additional wells which are sampled bi-annually. Group I wells were sampled in 1995 along with the annual wells, and will next be sampled in 1997. The group II wells will be sampled in 1996, along with the annual wells. In addition, specific wells from the column titled "additional wells" on Table 2.2 may be selected for sampling pursuant to discussions held with the NYSDEC during the pre-sampling conference.

This chemical monitoring schedule is meant to be flexible, and may be altered by adding, deleting or substituting certain wells in any given sampling event. Alteration of the monitoring network may occur following review of previous analytical results; upon request of the NYSDEC or other regulatory agencies; or for other reasons to adequately monitor performance of the containment system. A pre-sampling conference with the NYSDEC is required prior to conducting the annual chemical

monitoring program, to determine which, if any, changes will be made to the program for that year.

3.0 INFORMATION ON WELLS

Figure 1.3 shows the location of all the piezometers included in the Hydraulic Monitoring Program and the groundwater monitoring wells included in the chemical monitoring program.

Information on construction of the wells included in the long-term monitoring program are presented in Table 3.1.

4.0 MONITORING SCHEDULE

The projected Long Term Monitoring Program Schedule for hydraulic and chemical monitoring through the end of 1997 is presented as Table 4.1. Simply, this consists of a round of groundwater level measurements in all piezometers listed on Table 2.1 during the months of January, April, July, and October each year and chemical monitoring beginning in early May and extending into early June each year.

5.0 PREPARATION FOR SAMPLING

Preparation for the yearly LTM Sampling Program should include the tasks detailed in the following sections.

5.1 AGENCY NOTIFICATIONS

The following agencies should be notified prior to conducting the sampling field work.

- New York State Department of Environmental Conservation.
Mr. Benjamin Laredo
50 Wolf Road, Albany, New York 12233-7010
(518) 458-0927
 - Notify in writing at least 4 weeks prior to start date.
 - Arrange pre-sampling meeting to discuss proposed program.
 - Notification to be made by OxyChem on-Site personnel.

- Love Canal Area Revitalization Association (LCARA)
9501 Colvin Blvd.
Niagara Falls, New York
(716) 283-9501
 - Notify LCARA by phone and in writing 1 to 2 weeks prior to start date.
 - Notify homeowner (as may be necessary depending on which off-site wells are to be sampled - Table 5.1 gives contacts for off-Site wells).
 - Notification is to inform of upcoming sampling in case LCARA receive calls regarding our activities.
 - Notification to be made by OxyChem on-Site personnel.

- New York State Department of Transportation
Mr. Carl Kapperman
500 West Avenue
Lockport, New York
(716) 434-1480

- Notify in writing 4 weeks prior to sampling. Provide dates of sampling and identity of wells in LaSalle Expressway Right-of-Way (R.O.W.) to be sampled.

5.2 EQUIPMENT INVENTORY

Table 5.2 lists the equipment used for previous sampling events at this Site. Approximately 6 to 8 weeks prior to sampling, this equipment should be checked to assure availability and that the equipment is clean and operates properly. Any missing or broken equipment or accessories should be replaced or repaired.

5.3 SAMPLING SUPPLIES INVENTORY

Table 5.3 lists the sampling supplies which are expendable and/or disposable. Approximately 6 to 8 weeks prior to sampling, these supplies should be inventoried and adequate amounts ordered as necessary using the Passport System.

5.4 EQUIPMENT OPERATION

The basic operation of the sampling equipment at the Site is presented in the following subsections.

5.4.1 Peristaltic Pump

The peristaltic pump operates on the principle of suction to pump water from the well. The suction is produced using two rollers attached to arms

extending from a rotating shaft. These rollers squeeze a length of soft silicone tubing in a rotary motion which produces suction. This suction lifts the water out of the well through the food grade vinyl tubing and into the appropriate container (bucket, drum, or sample jar). The peristaltic pump at the Site operates on 110 volt AC power, necessitating use of a generator to power the pump. Advantages of the use of this pump are:

- removes high volume of water from shallow wells rather quickly
- easy to use
- portable

Limitations of use of this pump are:

- effective lift of 25± feet. If water levels are deeper than 25 feet below ground surface, the pump will not lift the water; and
- volatile organic compounds must not be sampled using a peristaltic pump because the agitation of the water by the pump during pumping causes the loss of volatile compounds.

Precautions to observe when using this equipment:

- danger of electrical shock from power source;
- drive belt and rollers in pump are pinch points. All power must be disconnected when changing silicone pump tubing; and
- pump discharges under moderate pressure. Contact with water from discharge should be avoided.

Required preparation activities prior to sampling or between wells should include the following:

- ensure generator has sufficient gas remaining to conduct purging/sampling. Have extra gas available;

- replace silicone tubing (length not to exceed 36-inches) within pump rotor. Ensure that an adequate total length of silicon tubing is available to complete all sampling (Note: Silicone tubing replacement not required if dedicated tubing is left in well);
- replace sample tubing. Ensure that an adequate total length of sample tubing is available to complete all purging sampling (Note: Sample tubing replacement not required if dedicated tubing is left in well).

The vendors information contained in Appendix A shows basic information on a similar type of pump.

5.4.2 Geoguard Airlift and Bladder Pumps

These pumps work on the principle of using high pressure air to displace water within the pump to remove the water from the well.

5.4.2.1 Airlift Pump

The Geoguard airlift pump is a stainless steel cylinder 1.5 inches in diameter and either 3 or 6 feet in length (two 3 foot segments can be joined together). The bottom end is a check (ball) valve which permits water to enter the pump and the top is a fitting to accept the well-dedicated coaxial tubing used on-Site (coaxial tubing has the air supply line contained inside the larger diameter water discharge line). The pump is lowered into the well on the end of the dedicated tubing and the air line is connected to a control box which controls the cycle time for the pump. The control box is then connected to a compressor. A solenoid in the control box opens a valve to permit air to flow to the pump, the pressure of the air closes the check valve at the bottom of the pump and displaces the water in the pump. A solenoid on the control box then activates a valve to block air from the pump thereby allowing the pump to re-fill with water. Air is then applied to the pump and the cycle is repeated. The length of the refill and discharge cycles can be manually varied to obtain the optimal pumping rates. The vendors data in Appendix A shows a schematic diagram of an airlift pump.

Advantages of an airlift pump are:

- pumps from a greater depth than a peristaltic pump; and
- can remove water at a moderate rate of flow.

Disadvantages/limitations of using the airlift are:

- pump is not dedicated, necessitating decontamination between wells, therefore increasing possibility of cross-contamination of samples;
- fairly difficult to set up, install and use;
- cannot sample for volatile organics using this pump due to air/water mixing; and
- requires 1 PSI of compressed air per 2 feet of lift.

Precautions to observe when using an airlift pump:

- pump use requires a high pressure air supply;
- moving parts on compressor;
- the compressor(s) are gasoline powered. Be careful when refueling hot engines. Gasoline is flammable;
- be sure compressor engine is located down-wind of the well being sampled to avoid contamination by the compressor exhaust;
- equipment is bulky/heavy. Use proper lifting techniques.

Required preparation activities prior to commencing sampling and/or between wells should include the following:

- decontaminate pump;
- replace sample tubing and air supply line. Ensure that an adequate total length is available to complete all purging/sampling (Note: replacement not required if dedicated tubing is left in well); and
- check to see if compressor is in good working condition. Have repairs made as required. Ensure compressor is full of gasoline prior to purging and that additional gasoline is available on Site.

5.4.2.2 Bladder Pump

The Geoguard bladder pump operates very much like the airlift pump except that an internal teflon bladder is used to provide a barrier between the air and the water, so that no mixing occurs within the pump. Because no air/water mixing occurs, volatile organic compounds can be sampled using this type of pump. The internal teflon bladder can be replaced in the field.

The pumping rate of a bladder pump is slightly less than from an airlift pump.

Required preparation activities prior to commencing sampling and/or between wells should include the following:

- decontaminate pump. Replace internal bladder or decontaminate existing bladder and associated clamps, o-rings, etc.;
- replace sample tubing and air supply line. Ensure that an adequate total length of both is available to complete all purging/sampling (Note: replacement not required if dedicated tubing is left in well); and
- check to see if compressor is in good working condition. Have repairs made as required. Ensure compressor is full of gasoline prior to purging and that additional gasoline is available on Site.

The vendors information in Appendix A shows a schematic diagram of the Geoguard bladder pump.

5.5 METER CALIBRATION

During field activities, several different meters are used to obtain measurements of the groundwater (pH, temperature, conductivity, turbidity) and the

headspace (air above groundwater in the well for presence of VOCs) of the well. This section provides information on the calibration of these meters to assure accurate and reliable readings are obtained.

5.5.1 General

Each meter to be used should be calibrated to the appropriate calibration reference standard(s) prior to use. Be sure reference standards are fresh and have not been contaminated.

5.5.2 pH Calibration

The pH meter takes a measurement of the available hydrogen ions of a solution. The meter reads on a scale of 0 to 14 with 0 being a very strong acid and 14 being a very strong base. A pH of 7 is neutral. The calibration of this meter is affected by the temperature and age of the reference solution(s). FP 3, contained in Appendix D, presents the procedures for calibration of the Orion pH meter used at the Site.

5.5.3 Specific Conductivity Meter Calibration

The specific conductivity meter measures the conductivity of a liquid, which gives an indication of the presence of dissolved ions in solution. The Myron L meter at the Site reads on four scales, 0 to 10 micromhos, 0 to 100 micromhos, 0 to 1000 micromhos and 0 to 10,000 micromhos. A one-point calibration is required for this meter with a 0 point check. FP 4, contained in Appendix D, describes the procedure to be used to calibrate this meter.

5.5.4 Temperature Calibration

A thermometer measures the temperature of a liquid and is used as an indicator of purging stability. Calibration of the thermometer may or may not be necessary. Manufacturer's information should be consulted (Appendix A) prior to use.

5.5.5 Turbidimeter Calibration

The turbidimeter measures the turbidity (cloudiness) of an aqueous solution. Measurement is made in nephelometric turbidity units (NTU), with a higher reading denoting a cloudier sample, which can affect certain volatile organic and metals analyses. A 0.02 NTU reference standard is supplied with the meter and frequent calibration of the meter is recommended. FP 5, contained in Appendix D, presents the procedure for calibration of the turbidimeter used at the Site.

5.5.6 Photoionization Detector Meter Calibration

The HNU photoionization detector measures the concentration of ionizable gases having an ionization potential equal to or less than the electron voltage of the ultraviolet light source in the detector. The concentration of these gases is an indication of the presence of volatile chemicals in the air. The meter at the Site uses a 10.2 eV probe.

FP 8, contained in Appendix D, presents the procedure used to calibrate an HNU photoionization detector.

5.6 CLEANING REQUIREMENTS

Any equipment which is not dedicated for use in a specific well must be cleaned before being used and between uses. The cleaning procedure at the Site consists of:

- a wash with a bio-degradable non-phosphate soap;
- a tap water rinse;
- a deionized water rinse; and
- allow equipment to air-dry; and wrap in aluminum foil or plastic to avoid contamination of the equipment.

FP 7 contained in Appendix D more fully describes the cleaning protocols for the Site.

5.7 VENDORS DATA/INSTRUCTION OR USE MANUALS

Vendors data for some of the equipment used at the Site is contained in Appendix A of this manual. Other vendors data and/or user manuals are also available on-site, for a majority of the newer equipment.

5.8 PURCHASE ORDERS

Occidental Chemical Corporation (OxyChem) utilizes an On-Line Purchase Order system (P.O.) in Passport. A PO must be obtained prior to purchasing equipment or supplies. The request for a PO must be initiated through the Passport System. The manuals for use of this system are available at the Site and thus, are not reproduced in this document. A copy of the computer screen print of the purchase order requisition is included as Figure 5.1.

6.0 SAMPLING PROCEDURES

The proper collection of water levels and groundwater samples requires that a consistent set of procedures be followed for every well every time water levels and/or groundwater samples are obtained. Following these procedures will result in the collection of good quality data which is representative of conditions at the Site.

6.1 GENERAL PROCEDURES

Certain activities can adversely affect sample quality, therefore, it is imperative that these activities not be done while sampling.

- i) Do not smoke.
- ii) Do not use bug repellents.
- iii) Do not use wasp/hornet spray near a well.
- iv) Do not use aftershaves, cologne or astringents (e.g. alum).
- v) Be aware of wind direction. Do not run vehicle or small engines upwind of a well being sampled.
- vi) Be cognizant of traffic fumes and nearby activities. Suspend sampling if fumes are strong. Make a notation of any such observations on the Groundwater Purge/Sample Record Log shown on Figure 6.1.
- vii) Be cognizant that the NYSDOT uses herbicides near the wells on the LaSalle Expressway. Suspend sampling if such activities are observed and make note of type of applications by NYSDOT in the Sampling Record Log.
- viii) Do not handle or pour gasoline or fuel oils near a well being sampled.

6.2 GENERAL HEALTH AND SAFETY

During collection of groundwater samples the following health and safety rules should be applied:

- i) Hardhat, safety glasses, long sleeve shirts, full length pants, industrial quality work boots are the minimum required personal safety equipment.
- ii) Do not eat, drink or smoke.
- iii) Be aware of potential slip, trip and fall hazards and uneven terrain.
- iv) Be aware of the hazards of working with portable machinery, electrically operated equipment, gasoline powered equipment and high pressure air.
- v) Some heavy lifting is required - use proper lifting techniques.
- vi) Some sampling takes place along a high speed expressway. Be aware of moving vehicles.
- vii) Groundwater removed during sampling activities should be considered contaminated and handled accordingly.
- viii) Use caution when opening protective covers on wells - wasps, hornets or bees may be present.
- ix) Headspace readings taken at the well with a photoionization detector may dictate the need for full-face respiratory protection. If elevated readings are noted (i.e., above background) the breathing zone is to be monitored. The required personal protective equipment for various levels of elevated readings (which are an indication of elevated volatile organic chemical presence) is as follows:

*HNu Reading Above
Background (ppm)*

*Required PPE **

0 - 1	No protection required
1 - 5	Don air purifying respirator (full or half face)
>5	Level B required (full air)

Note: * equipment required in addition to 1) above.

6.3 WATER LEVEL MEASUREMENT

Once each quarter, a set of water levels are measured in the six strings of nested piezometers at the Site.

Prior to the yearly sampling event, a single round of Site water levels should be taken in all wells included in the long-term monitoring program. Taking these water levels provides the following:

- i) more accurate data for area groundwater table maps;
- ii) an opportunity for the sampling team to become oriented to the Site;
- iii) supplies data about unusual circumstances such as wells that might be damaged, dry, inaccessible; and
- iv) an opportunity to inventory well condition and to perform minor maintenance such as lubricating locks and hinges, replacing lost or faded well tags, etc. A check-off list to be used during well inventory inspections is provided as Figure 6.2.

An electric water level tape will be used for water level measurements in the piezometers and/or wells on-site. FP 1 describes the water level measurement procedures in detail. Water level measurements shall be recorded in a bound field log book with date and time indicated.

6.4 WELL PURGING

Prior to sampling each well, the standing water in the well casing and the water surrounding the well screen will be purged so that representative formation water may be sampled. FP 2 describes the purging procedures in detail.

The volume of water in the well will be calculated by subtracting the depth to water from the total depth of the well. This value (the water column length) will then be multiplied by a coefficient which relates the diameter of the well to gallons per linear foot:

- multiply by 0.163 for a 2-inch diameter well;
- multiply by 0.367 for a 3-inch diameter well;
- multiply by 0.653 for a 4-inch diameter well; and
- multiply by 1.47 for a 6-inch diameter well.

Purging may be conducted by several methods including a peristaltic pump, an air lift pump, a bladder pump, or hand bailing. Non-dedicated equipment must be decontaminated between wells as described in FP 7.

Two criteria will be used to determine if a sufficient volume of groundwater has been purged from the well to yield a representative sample.

These criteria are:

- i) the removal of three to five standing well volumes; or
- ii) if a well goes dry, purge one time to dryness.

Unless a well goes dry during purging, a minimum of three well volumes will be removed from each well prior to sampling. During purging, field parameters (pH, specific conductance, temperature, and turbidity) will be measured and recorded. One set of readings will be taken at the start of purging and an additional set will be taken after removal of each standing well volume. If the field parameters

stabilize, (pH varies by less than 0.5 pH units; specific conductance varies by less than 10 percent; and temperature varies by less than 1° Celsius for two successive measurements) and remain stable, purging can stop when three well volumes are removed. If the field parameters do not stabilize - purging will continue until a maximum of five well volumes have been removed. Sampling will then take place, even if the field parameters have not stabilized. The meters for measuring the field parameters shall be calibrated each morning and the calibration checked at the end of the day using the procedures provided in FPs 3, 4, 5, and 8. Recalibration of the meters should be done whenever necessary.

If a well is pumped dry, the well will be allowed to recover a sufficient volume to collect the required samples. The water level measurement tape should be used to verify the well has gone dry, especially when using a peristaltic pump which has a limited pumping depth. If the well has not gone dry, troubleshoot the pump or switch purging methods.

6.5 SAMPLE COLLECTION

After completion of well purging, groundwater samples will be collected. Analytical requirements, sample containers, and laboratory arrangements are discussed in Section 7.0.

All samples should be collected using disposable bailers except at Well 10210A, where a dedicated bladder pump allows for sampling with the bladder pump.

Procedures detailing the collection of groundwater samples are presented in FP 6.

Where a well will not yield the volume of water necessary to immediately fill all required sample containers, as many of the containers as possible will be filled, with the remainder filled as water comes into the well. Samples for Volatile Organic Compounds are to be collected within two hours of completion of well purging.

Sampling of wells on the expressway during "rush hour" should be avoided due to possible effects of vehicle exhaust. Also, if possible sampling in the rain should be avoided due to potential for cross contamination from airborne contaminants picked up by the precipitation. Clean wells should be sampled first to prevent potential cross-contamination. Thus, previous analytical results need to be reviewed to determine the order in which wells will be sampled. Previous reports which contain prior analytical sample data should be kept on Site for reference.

6.6 SAMPLE HANDLING AND SAMPLING DOCUMENTATION

The information presented in the following sections describes the proper documentation of field activities, sample storage, sample handling and chain of custody procedures to be used during the annual groundwater monitoring program.

6.6.1 SAMPLING DOCUMENTATION

Documentation is a critical part of sampling. The validity of samples collected in the field can only be proven through the exhaustive use of field written activity records. Field conditions, collection and handling of samples, as well as information about each sample collected will be recorded and stored on a standardized form or in a designated project field notebook. Some information is recorded in the field directly on a standardized form (e.g., Groundwater Field Sample Purge Record form or chain of custody data), and some is recorded and remains in the field notebook (i.e. weather conditions, description of site activities). This type of documentation along with chain of custody documentation provides a permanent record of all significant activities during a field investigation. All notebooks and logs should be completed using waterproof pens to prevent smudging if the notes get wet in the field. Once complete, the notebooks, standardized forms, and logs should be signed and dated on the bottom of each page.

6.6.1.1 Field Notebook

Bound notebooks will be used by the field team for recording all daily logs, sampling events and field observations. Entries in the logbook shall be dated and signed on each page by the person making the entry. The logbook will be kept in a secure dry place. Entries must not be made in water-soluble ink. The type of information to be included in the log is:

- i) date;
- ii) time;
- iii) location;
- iv) weather;
- v) sample crew;
- vi) work progress;
- vii) control samples;
- viii) delays;
- ix) unusual situations;
- x) well damage;
- xi) departure from established QA/QC field procedures;
- xii) instrument problems; and
- xiii) accidents.

Additional data may be required in the field logbook, specifics of which are described in the in FPs. Any corrections made to the original entries will be initialed by the observer. Any incorrect entries will be crossed out with a single line using black, permanent ink, and initialed by the observer.

6.6.1.2 Sample Collection Logs

The sampling team shall maintain all sampling logs which record information about each sample collected. The logs will be completed at the time of sampling and will provide documentation to indicate that sampling requirements have been met. In addition to project information and well evacuation data, the following information is also included on the sampling log:

- i) physical appearance of samples;
- ii) field observations;
- iii) results of field analyses;
- iv) sampling methods and materials;
- v) constituents sampled;
- vi) split sample and QA/QC sample information; and
- vii) sampling personnel.

An example of the Groundwater Purge/Sample Record Log is shown on Figure 6.1.

6.6.1.3 Instrument Calibration and Use Logs

Standardized Instrument Calibration Logs for each field instrumentation will be maintained during all sampling activities to demonstrate properly functioning equipment. Included in the log should be documentation of time of instrument use, operator and any maintenance performed. Logs for the PID will also include daily calibration, type of calibration gas, warm-up time, and lamp type (10.2 eV UV). This information can be entered into the bound field log book rather than keeping a separate log book.

6.7 SAMPLE CONTAINERS

All samples sent to the laboratory for chemical analyses will be placed in new containers provided by the analytical laboratory. These bottles will be shipped by overnight courier in clean insulated coolers equipped with bottle custody forms. Packing materials will be used to prevent bottle breakage. The samples will be shipped using ice to maintain a temperature of 4 °C within the cooler. Questions regarding sample containers should be directed to Mr. Mike Kargatis (716-286-3448) of OxyChem's Corporate Analytical Staff.

6.8 SAMPLE IDENTIFICATION

Sample labels are necessary to identify and prevent misidentification of the samples. The labels shall be affixed to the sample container (not the caps) prior to the time of sampling. The labels shall be filled out in waterproof ink at the time of collection. The labels will include the following information:

- i) sample number/identification code;
- ii) name/initials of collector;
- iii) date and time of collection;
- iv) Site name;
- v) project number;
- vi) required analysis; and
- vii) type of preservation.

A unique sample numbering system will be used to identify each sample collected. An example of a sample identification number is:

A-4341-KPL-01/19/96-001 where;

- i) A is the series which designates a group of samples. This might include sample round, or might designate sample type [i.e., groundwater (GW) or soil (S)]. Series is optional;
- ii) 4341 is the job number which together with the series allows easier tracking of samples;
- iii) KPL is the sampler's initials which identify the sampler and thus allows project personnel to contact the correct person for information regarding that sample and its collection;
- iv) 01/19/96 is the sample date which allows monitoring of actual holding time of samples; and

- v) 001 is the sample identification designation which identifies the sample location and can be of any numerical or other designation.

It is imperative that a sample key which matches the sample identification designation with the sample location be maintained. This ensures that samples are submitted "blind" to the laboratory (i.e., laboratory does not know sample location) and thus prevents rigged sample results.

6.9 SAMPLE CUSTODY

Sample custody procedures are designed to provide documentation of preparation, handling, storage and shipping of collected samples. In order to maintain the integrity of samples, chain of custody procedures will be followed. The chain of custody procedures are designed to ensure that:

- i) the samples are not tampered with;
- ii) all persons handling the samples can be traced; and
- iii) all persons handling the samples are accountable.

An example of the Chain-of-Custody form, which will be used is shown in Figure 6.3. (**Need OxyChem Chain-of-Custody**)

Samples collected will be the responsibility of identified persons from the time they are collected until they, or their derived data, are incorporated into the final report. Stringent chain-of-custody procedures will be followed to maintain and document sample possession.

6.9.1 Field Custody

The Field Personnel are responsible for the care and custody of the samples collected until they are personally delivered to the analytical laboratory or entrusted to a carrier. Immediately upon collection, the sample will be placed in the laboratory-supplied insulated cooler and chilled with ice to maintain 4°C within the

cooler. Packing materials will be used to prevent bottle breakage. Samples which are not shipped to the laboratory on the same day they are collected will be transferred to the on-Site refrigerator at the end of the day's sampling. The interior of the refrigerator will be maintained at 4°C.

Chain-of-custody forms will be completed to the fullest extent possible prior to sample shipment. These forms will include the following information:

- i) sample number;
- ii) time collected;
- iii) date collected;
- iv) sample matrix;
- v) number of containers;
- vi) parameters to be tested;
- vii) preservative; and
- viii) name of sampler.

These forms will be filled out in a legible manner, using waterproof ink, and will be signed by the sampler. Similar information will be provided on the sample label, which is securely attached to the sample bottle. In addition, sampling forms will be used to document collection, filtration, and preparation procedures.

6.9.2 Transfer of Custody and Shipment

The following procedures will be used when transferring custody of samples:

- i) samples will always be accompanied by a chain of custody record. When transferring samples, the individuals relinquishing and receiving them will sign, date, and note the time on the record. This record documents sample custody transfer from the sampler, often through another person, to the laboratory. Upon arrival at the laboratory, internal custody procedures will be followed;

- ii) samples will be packaged properly for shipment and dispatched to the appropriate laboratory for analysis, with a separate custody record accompanying each shipment. Shipping containers will be sealed for shipment to the laboratory. At least one copy of the chain of custody should be sealed within the shipping container. One copy should be retained at the Site and a photocopy should be transmitted to the OxyChem Corporate Analytical Staff contact (Mr. Mike Kargatis, phone number 716-286-3448) by the next working day. The method of shipment, courier name, and other pertinent information will be entered in the remarks section of the custody record;
- iii) all shipments will be accompanied by the chain of custody record, which identifies the contents of the containers. The original record will accompany the shipment and a copy will be retained by the field sampler; and
- iv) proper documentation will be maintained for shipments by common carrier. (i.e. waybills or bills of lading). (Note: Most common carriers, i.e., Fedex or UPS) will not sign chain of custody records).

6.9.3 Sample Shipment Procedures

The following procedures will be followed when shipping samples for laboratory analysis:

- i) samples requiring refrigeration will be promptly chilled with ice or "Blue Ice" to a temperature of 4 °C ($\pm 2^{\circ}\text{C}$) and packaged (with bubble wrap to prevent bottle breakage) in an insulated cooler for transport to the analytical laboratory;
- ii) only shipping containers which meet all applicable State and Federal standards for safe shipment will be used;
- iii) the shipping containers will be sealed with tape and chain of custody seal. Tape is wrapped around the cooler in two locations (across hinges) and custody seal placed across cooler opening. This allows the receiver to quickly identify any tampering which may have taken place during transport to the laboratory;

- iv) a copy of the field chain of custody document will be placed inside the shipping container in a sealed plastic envelop; and
- v) shipment of all analytical samples will be by overnight courier. Samples are to be shipped to the laboratory within 48 hours of collection.

6.10 DECONTAMINATION PROCEDURES

Decontamination of non-dedicated sampling equipment at the Site is critical to avoid cross-contamination when this equipment is used at multiple locations at the same or different well locations. All equipment is to be cleaned prior to use in a well and after having been used in any other well.

FP 7 presents general decontamination procedures at the Site. As no solvents are used, decontamination fluids can be collected and disposed to the LCLTF system.

As described in Section 7.2.4, rinse blanks will be collected from cleaned sampling equipment to validate the effectiveness of the decontamination of that equipment.

6.11 WASTE MATERIAL HANDLING

6.11.1 Decontamination Fluids Disposal

The waste liquids generated from the cleaning of non-dedicated sampling equipment can be disposed to the LCLTF for treatment. Washwater should be collected into a 5-gallon pail while in the field or can be placed into the overpack drums used to contain groundwater from purging and sampling activities.

6.11.2 Groundwater Disposal

All groundwater generated from purging and sampling activities will be discharged to the LCLTF for treatment.

Discharge to the LCLTF will take place by pouring or pumping the water into the eastern diked area adjacent to the LCLTF. This diked area pumps to the underground storage tanks for storage prior to treatment. The location of the discharge point is shown on Figure 1.1.

6.11.3 Solid Waste

Solid waste generated during water level monitoring and groundwater sample collection activities will be placed in plastic garbage bags and stored in the Love Canal Drum Storage Facility pending final disposal.

7.0 ANALYTICAL REQUIREMENTS

Analytical requirements for the LTM program consist of analyses of Target Compound List (TCL) Volatile Organic Compounds (VOCs), TCL Base, Neutral and Acid extractable (BNA) semi-volatile compounds (SVOCs), TCL organochloride Pesticides, and Polychlorinated Biphenyls (PCBs).

Table 7.1 lists the individual analytes to be tested during the LTM program.

7.1 LABORATORY METHODS AND LEVEL OF REPORTING

7.1.1 Analytical Methods

TCL VOCs are to be analyzed by Gas Chromatography/Mass Spectrophotometry (GC/MS) using EPA Method 8240.

TCL BNAs are to be extracted and analyzed using EPA Method 8270.

TCL Organochlorine Pesticides and PCBs are to be extracted and analyzed using EPA Method 8080.

7.2 QUALITY ASSURANCE/QUALITY CONTROL

Quality Assurance/Quality Control (QA/QC) samples to be submitted during the LTM program include the following:

7.2.1 Field Duplicate Samples

A duplicate investigative sample will be collected in the field. This sample will be assigned a separate number. Field duplicate samples are to be

collected at a frequency of one for each ten investigative samples submitted for analyses. Field duplicates will be submitted "Blind" to the laboratory. Field duplicate samples are used to assess field sampling and laboratory analytical repeatability.

7.2.2 Matrix Spike/Matrix Spike Duplicate Samples

Matrix Spike/Matrix Spike Duplicate Samples (MS/MSD) require extra volume to be collected and submitted with an investigative sample to allow the laboratory to perform internal QA/QC testing of method precision and accuracy. MS/MSD samples are to be submitted at a frequency of 1 per 20 samples or one per week, whichever is more frequent.

7.2.3 Deionized Water Blank

One sample of the deionized water from the on-site deionizer will be submitted to test for the presence of trace contaminants in this water. This sample will be collected by filling a set of sample containers directly from the deionizer.

7.2.4 Rinse Blanks

Rinse blanks from an item of cleaned, non-dedicated sampling equipment will be collected to analyze for trace contaminants which may be attributable to these materials. These samples are to be collected by rinsing the equipment with deionized water from the on-site deionizer and collecting the rinse water into a set of sample containers. Rinse blanks will be analyzed for the same parameters as the investigative samples.

7.2.5 Trip Blanks

Trip blank samples consisting of analyte-free water will be submitted to the laboratory for VOC analyses at a frequency of one per each sample

shipment container containing aqueous VOC samples. Trip blanks will be provided by the analytical contractor.

Trip blank samples (analyzed for VOCs only) will be shipped by the laboratory to the Site and back to the laboratory without being opened in the field. Trip blank analyses will provide a measure of potential cross-contamination of samples during shipment, handling, and from ambient conditions at the Site.

7.3 CONTRACT LABORATORY

The analytical laboratory which will be providing contract analytical services for analysis of the LTM program samples shall be an independent commercial laboratory which has current New York State Department of Health Certification to perform environmental analyses for the parameters defined in Section 7.1 of this report.

Analytical arrangements will be made by the OxyChem Corporate Analytical Staff, (Mr. Mike Kargatis, phone number 716-286-3448).

7.4 BOTTLES, SAMPLE PRESERVATION AND HOLDING TIMES

Table 7.2 presents the required sample containers, preservation and holding times which will be required for the LTM program.

Samples should generally be collected and containerized in the order of the following volatilization sensitivity:

- Volatile Organic Compounds (VOCs);
- Semi-volatile Organic Compounds (SVOCs);
- Total organic carbon;
- Total organic halogens;
- Extractable organics;
- Total metals;

- Dissolved metals;
- Phenols;
- Cyanide;
- Sulfate and chloride;
- Nitrate and ammonia, and
- Radionuclides.

Note that not all of the parameters listed above are necessarily included in the sample sets for Love Canal. The complete list is provided for potential future use only.

8.0 INTERPRETING RESULTS

The analytical results obtained from the laboratory will be used as a determination of whether changes in groundwater chemistry over time are occurring. All analytical results will be subjected to quality assurance/quality control to assess the validity of the data. The validated analytical results, provided by Mike Kargatis, will be compared to historical analytical information for the evaluation.

As a majority of the LTM wells are placed outside the known limits of contamination, the organic chemistry from these wells should be non-detectable at the method detection limits. MW-10135 is located within a known contaminated area and serves as a "Worst Case" well.

9.0 REPORTING

An annual report covering the activities of the previous calendar year (January 1 to December 31) will be prepared for submittal to the NYSDEC in Albany, New York.

This report is to be submitted on February 28 of the following year.

The report should include the following information:

- i) a discussion of the major activities occurring at the Site during the reporting period;
- ii) a summary of the operation of the barrier drain and treatment system, including monthly average flows and any major problems, equipment repairs, and/or changes in the operation of the system;
- iii) a summary of the findings of the four rounds of water level measurements, including hydrographs demonstrating hydraulic gradients;
- iv) a summary of the groundwater sampling program, including a listing of the wells sampled, a discussion of the analytical results, and a comparison of the analytical results to historical site chemistry;
- v) tables listing the water level measurements, the analytical results by well, and the monthly treatment plant flows;
- vi) a conclusion regarding the overall effectiveness of the remedial systems at the Site; and
- vii) a certification by a representative of OxyChem.

10.0 REQUIRED DATES FOR SUBMISSION OF DATA

The annual report is to be submitted by February 28 following the reporting period.

The quarterly hydrographs and water level results are to be reported as part of the annual report or within one month of the date the readings were taken.

11.0 TROUBLESHOOTING

Troubleshooting is described in the Manufacturer's literature provided in Appendix A. Additional information may be found in specific equipment manuals at the Site or by contacting the equipment manufacturer's customer service department.

12.0 LTM PROGRAM TRAINING

OxyChem personnel involved with the Love Canal LTM Program will undergo the following training specific to the Site:

- i) review of this sampling manual and the FPs provided. (Annually before the sampling program);
- ii) six weeks (one sampling round) under the supervision of an experienced field technician. (One time);
- iii) one round of water levels in the on-Site piezometer strings under the supervision of an experienced field technician. (One time);
- iv) successfully pass the written exam supplied for this sampling manual (20 of 25 questions correct). (One time); and
- v) sign certification page (Appendix F) which states all trainees have read and understand manual and attended training sessions.

The written exam and exam answers are included in Appendix F.

Additional training for specific OxyChem procedures will be given as required. This may include:

- i) specific safety SOP training;
- ii) annual OSHA training;
- iii) OxyChem Passport System training; and
- iv) Site-Specific FP training.

13.0 AUDIT CHECKLIST

During some of the on-Site LTM activities, an unannounced field audit will be conducted to determine whether proper procedures are being followed during these activities.

Some items to be evaluated during the audit are:

- Have proper notifications been made?
- Is the sampling manual and the site health and safety plan available at the Site?
- Are workers familiar with program requirements, procedures, and goals?
- Are samples being handled in a proper manner (i.e., placed immediately on ice; VOC samples filled without air; correct number of containers being filled at each location)?
- Are samples are properly stored and packed for shipping)?
- Are Chain of Custodies being properly completed?
- Are custody seals being used during shipping?
- Is the bound field log book being kept up to date?
- Are instruments being calibrated property and are records being kept of calibration data?
- Is non-dedicated sampling equipment being used? If so, are proper cleaning procedures being followed? Are rinse blanks being taken?
- Is sampling progress being tracked to a sampling schedule made out or posted as available?

During Water Level Measurements

- What type of equipment is being used?
- If non-dedicated, is this equipment being cleaned between wells:
- Are measurements being made to the nearest 0.01 foot?
- Are location, measurement, time and date being noted on the field sheet?
- Are proper health and safety procedures being employed?
- Are vinyl latex gloves being worn for water levels? Are they being changed between wells?
- Are wells locked and/or otherwise secured?
- Are measurement points and identification marks affixed to wells?

FIGURES

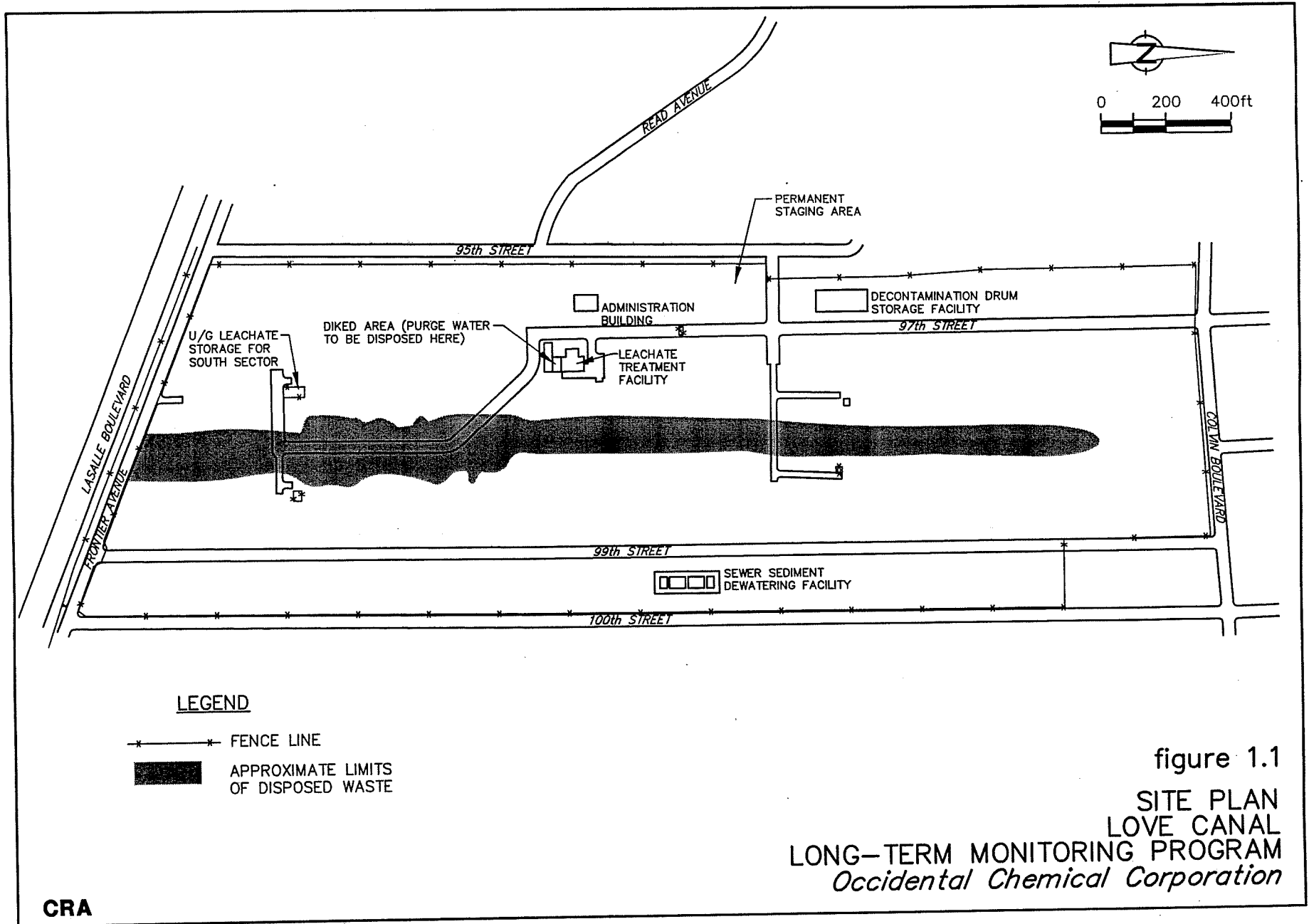

LEGEND

- *—*—*— FENCE LINE
- APPROXIMATE LIMITS OF DISPOSED WASTE

figure 1.1
 SITE PLAN
 LOVE CANAL
 LONG-TERM MONITORING PROGRAM
Occidental Chemical Corporation

CRA

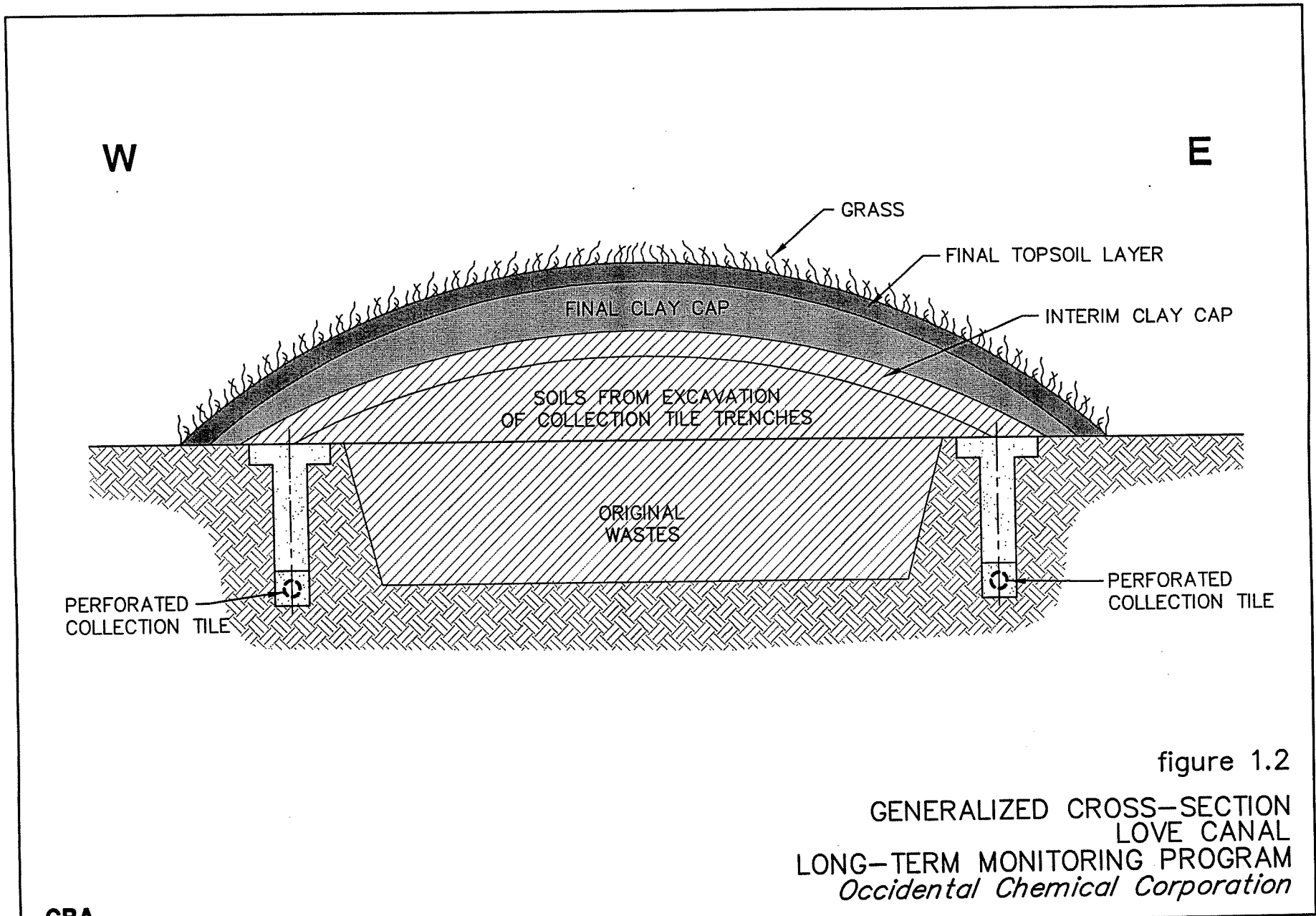

CRA

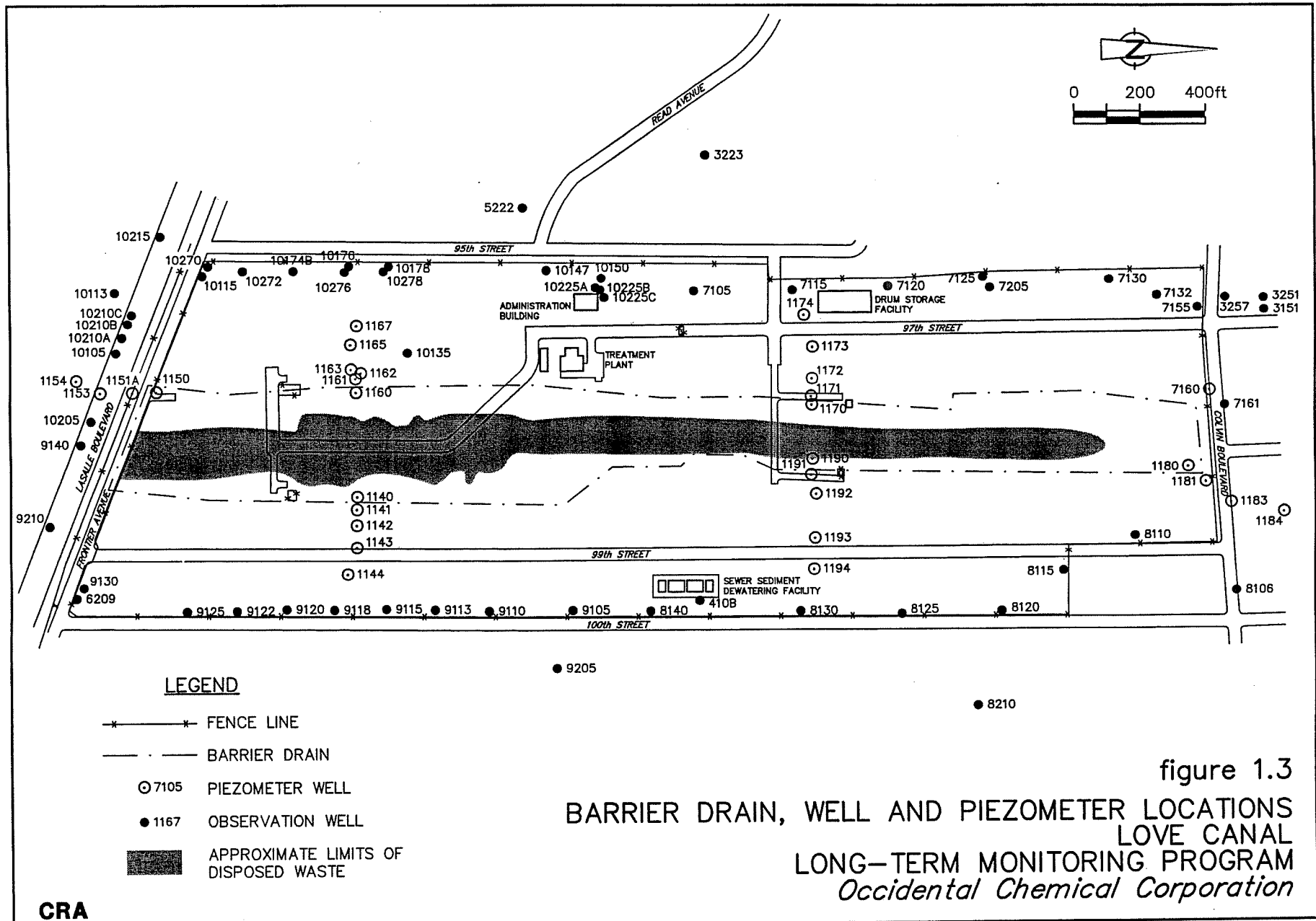

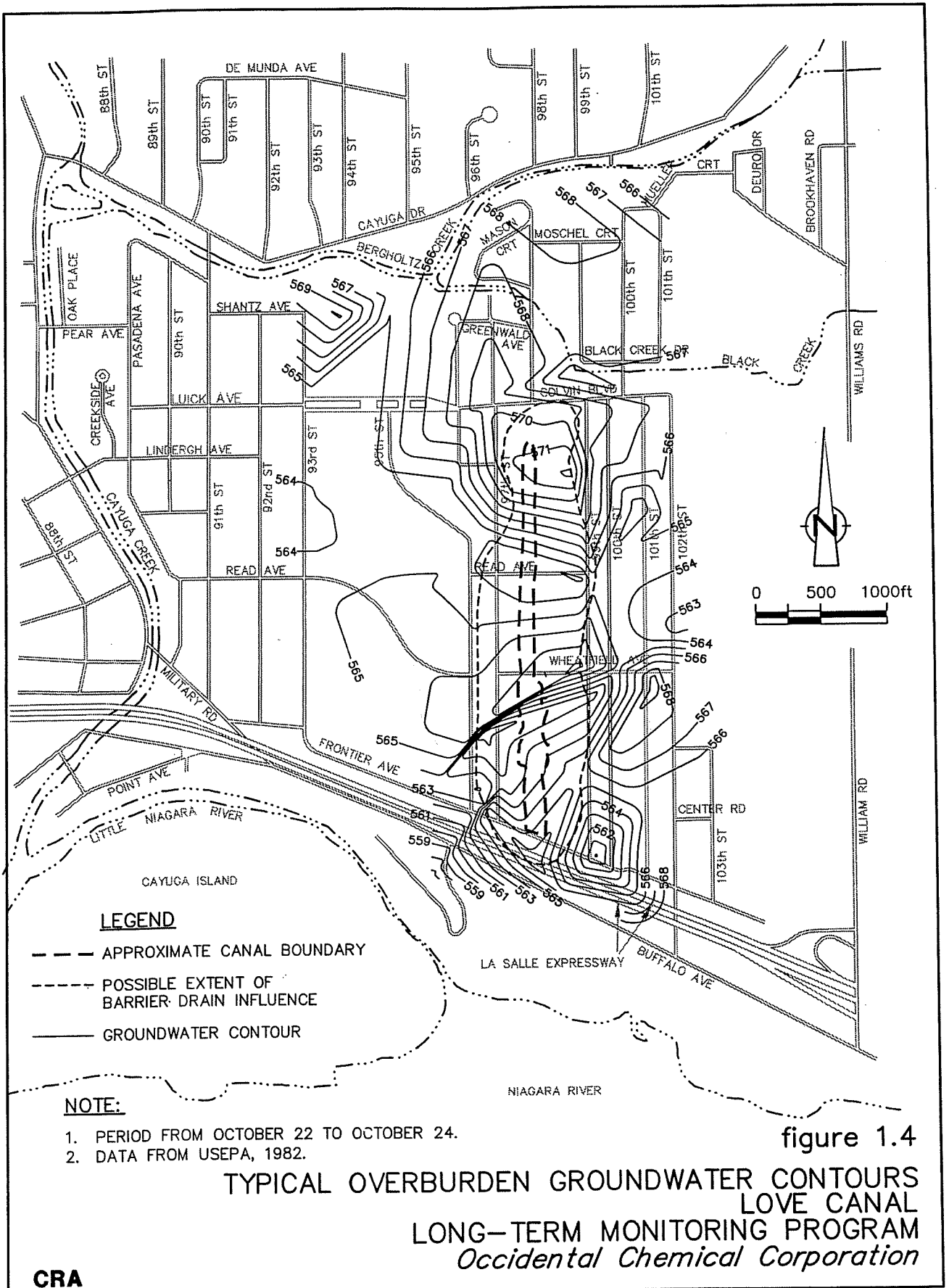

CRA

```

TIMM200                                MSR HEADER                                05/15/95 14.00
  Help  Data  Print  Roadmap  Exit  Options                                Facility= 11
MSR Number = 000004771                                Status = ACTIVE
Description : GAS STRING TRIMMERS /LOVE CANAL           As Of : 05/15/95
W/O Task = _____                                Gl. Distribution = 1000 28306000 11594 Holdr:
MSR Need Date - 05/22/95                                Originator = UANPSFP_
-----
Warehouse = 11_                                Cust. Initials : SFP                                Deliver To (STK): 010
Warehouse Note: _____                                UD Items Value : _____
-----
Buying Entity = 11_                                Requisition ID : SFP                                Buyer ID = 66_
Paying Entity = 1000                                Vendor Number : 092162217_                                Group = _____
Ship To : 11_                                Deliver to (NS): LOVE CANAL                                Use tax : TIN
Req. Copy: _____                                Req. Items Value: 538.00                                Comments : -
Requisition Approver: _____                                DXW                                Priority : -
Requisition Notes:
P-SHINDAIWA MODEL 230 GAS STRING TRIMMERS,SEMI AUTOMATIC FEED HEAD _____
$269.00 EA, PER TED PILKOS 433-4111 _____
-----
Error Messages : _____                                More: _____
-----
F9 TO VIEW/CREATE LINES ASSOCIATED WITH THE MSR, F10 TO VIEW MSR (TNES STATUS)
F1=Help F4=Prompt F5=Search F6=Refresh F10=Perform Mag F12=Cancel

```

figure 5.1
SAMPLE PURCHASE ORDER REQUISITION
LOVE CANAL
LONG-TERM MONITORING PROGRAM
Occidental Chemical Corporation

OCCIDENTAL CHEMICAL CORPORATION

GROUNDWATER FIELD SAMPLE/PURGE RECORD

STATION # _____ DATE: _____

WEATHER NOTES: _____

VOC LEVEL: AMBIENT _____ HEADSPACE _____

WELL DEPTH: _____ FT. WATER DEPTH: TOW _____ FT.

WELL VOLUME: _____ GAL. TOTAL VOLUME PURGED _____ GAL.

SAMPLE PURGE DATA:

⊙ INITIAL _____ GAL.
TEMP. _____ DEG.F.
SPCON _____ MOHS
TURBID. _____ NTU'S
pH _____
TIME _____
HR/MIN _____
PURGE _____
VOL. _____ GALS.

⊙ _____ GAL.
TEMP. _____ DEG.F.
SPCON _____ MOHS
TURBID. _____ NTU'S
pH _____
TIME _____
HR/MIN _____
PURGE _____
VOL. _____ GALS.

⊙ _____ GAL.
TEMP. _____ DEG.F.
SPCON _____ MOHS
TURBID. _____ NTU'S
pH _____
TIME _____
HR/MIN _____
PURGE _____
VOL. _____ GALS.

⊙ _____ GAL.
TEMP. _____ DEG.F.
SPCON _____ MOHS
TURBID. _____ NTU'S
pH _____
TIME _____
HR/MIN _____
PURGE _____
VOL. _____ GALS.

⊙ _____ GAL.
TEMP. _____ DEG.F.
SPCON _____ MOHS
TURBID. _____ NTU'S
pH _____
TIME _____
HR/MIN _____
PURGE _____
VOL. _____ GALS.

⊙ _____ GAL.
TEMP. _____ DEG.F.
SPCON _____ MOHS
TURBID. _____ NTU'S
pH _____
TIME _____
HR/MIN _____
PURGE _____
VOL. _____ GALS.

REMARKS/OBSERVATIONS _____

TIME SAMPLED: _____ DATE: _____

QA/QC Y/N MS? MSD? FIELD BLANK? _____

DEC SPLIT Y/N VOA'S. BNA'S, PESTICIDES/PCB'S _____

PURGING CREW _____

SAMPLING CREW _____

figure 6.1

SAMPLE COLLECTION LOG FORM
LOVE CANAL
LONG-TERM MONITORING PROGRAM
Occidental Chemical Corporation

CRA

INSPECTION CREW MEMBERS: _____ SUPERVISOR: _____

DATE OF INSPECTION

--	--	--	--	--	--

(MM DD YY)

<i>Well I.D. Number</i>	<i>Lock</i>	<i>Surface Seal</i>	<i>Protective Casing</i>	<i>Riser</i>	<i>Water Level (ft. BTOC)</i>	<i>Well Depth (ft. BTOC)</i>	<i>Other Comments</i>

Additional Comments: _____

figure 6.2
WELL INSPECTION SUMMARY
LOVE CANAL
LONG-TERM MONITORING PROGRAM
Occidental Chemical Corporation

CRA

 OXYCHEM® CHAIN OF CUSTODY RECORD EP8-01	PROJECT/PROGRAM	SHIP TO:					REQUESTED ANALYSIS * 					SAMPLE PRESERVATION				
	SAMPLER (SIGN AND PRINT NAME)															
FACILITY/LOCATION	SAMPLE SITE							SAMPLE REMARKS 								
SAMPLE IDENTIFICATION			DATE M/D/Y	TIME	MATRIX	COMP	GRAB						OTHER	CONTAINER TYPE *	NUMBER OF CONTAINERS	
TOTAL NUMBERS OF CONTAINERS										* SUGGESTED CODES LISTED ON FIGURE 6.3B						
RELINQUISHED BY:	DATE	TIME	RECEIVED BY:				EMPLOYER		CUSTODY REMARKS							
RELINQUISHED BY:	DATE	TIME	RECEIVED BY:				EMPLOYER									
RELINQUISHED BY:	DATE	TIME	RECEIVED BY:				EMPLOYER									
RELINQUISHED BY:	DATE	TIME	RECEIVED BY:				EMPLOYER									
RELINQUISHED BY:	DATE	TIME	RECEIVED BY:				EMPLOYER									
RELINQUISHED BY:	DATE	TIME	RECEIVED BY:				EMPLOYER		CONTACT (PRINT)		CONTACT PHONE					

figure 6.3A
 SAMPLE CHAIN OF CUSTODY FORM
 LOVE CANAL
 LONG-TERM MONITORING PROGRAM
Occidental Chemical Corporation

CRA

SUGGESTED CODES

SAMPLE MATRIX

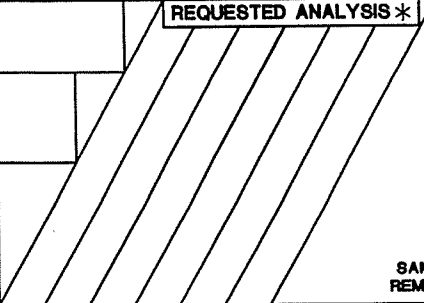
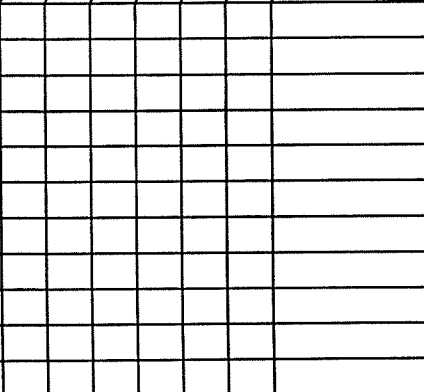
WW	WASTE WATER
GW	GROUNDWATER
DW	DRINKING WATER
SW	STORM WATER
PW	PROCESS WATER
RW	RIVER WATER
SANIT	SANITARY SEWER WATER
SOIL	SOIL
SLUDGE	SLUDGE
SED	SEDIMENT
ORG	ORGANIC LIQUID
NAPL	NONAQUEOUS PHASE LIQUID
APL	AQUEOUS PHASE LIQUID
OIL	OIL
UL	UNIDENTIFIED LIQUID
US	UNIDENTIFIED SOLID
CONST	CONSTRUCTION WASTE
ASH	ASH, FLYASH, BOTTOM ASH
RES	RESIDUE
SOL	SOLVENT

CONTAINER TYPE

G	GLASS
T	TEFLON
PP	POLYPROPYLENE
PE	POLYETHYLENE
P	PLASTIC
A	AMBER
C	CLEAR
WM	WIDE MOUTH
NM	NARROW MOUTH
40HV	40ML HYPO VIAL
L	LITER
PINT	PINT
Q	QUART
GALLON	GALLON
CUBIT	PLASTIC CUBITAINER

PRESERVATION

4° C	STORE AT 4± 2° C
THIO	0.008% SODIUM THIOSULFATE
H2S04	PH<2 WITH SULFURIC ACID
HN03	PH<2 WITH NITRIC ACID
HCL	PH<2 WITH HYDROCHLORIC ACID
ASCORBIC	0.6G ASCORBIC ACID
NAOH	PH>12 WITH SODIUM HYDROXIDE
ACETATE	ZINC ACETATE + SODIUM HYDROXIDE PH>9
DARK	STORE IN DARK
PH5-9	PH>5 AND <9
PH4-5	PH>4 AND <5
FILTERED	SAMPLE FILTERED

ANALYSIS METHOD

EPA	EPA NDPES METHODS
SM17	STANDARD METHODS VOLUME 17
SW846	EPA SOLID WASTE METHODS
ASTM	ASTM METHODS

figure 6.3B

SUGGESTED CODES
LOVE CANAL
LONG-TERM MONITORING PROGRAM
Occidental Chemical Corporation

CRA

TABLES

TABLE 2.1
LIST OF PIEZOMETERS TO BE MEASURED QUARTERLY
LOVE CANAL SITE
LONG TERM MONITORING PROGRAM
NIAGARA FALLS, NEW YORK

<i>Piezometer Identification</i>	<i>Zone Monitored</i>	<i>Top of Riser Elevation (feet AMSL)</i>
<i>North Sector Wells</i>		
1170A	A	584.68
1170B	B	584.56
1171A	A	583.37
1171B	B	583.63
1171C	C	583.26
1172A	A	581.73
1172B	B	581.78
1172C	C	581.77
1173A	A	578.14
1173B	B	578.36
1173C	C	578.45
1173D	D	578.60
1174A	A	577.77
1174B	B	577.73
1174C	C	578.14
1174D	D	577.78
1180A	A	582.59
1180B	B	582.47
1180C	C	583.27
1181A	A	576.81
1181B	B	577.15
1181C	C	577.07
1190A	A	586.53
1190B	B	586.22
1191A	A	584.91
1191B	B	584.90
1191C	B	585.18
1192A	A	583.43
1192B	B	583.46
1192C	C	583.85
1193A	A	579.97
1193B	B	579.45
1193C	C	579.60
1193D	D	579.60
1194A	A	578.40
1194B	B	578.03
1194C	B	578.56
1194D	C	578.54

TABLE 2.1

LIST OF PIEZOMETERS TO BE MEASURED QUARTERLY
 LOVE CANAL SITE
 LONG TERM MONITORING PROGRAM
 NIAGARA FALLS, NEW YORK

<i>Piezometer Identification</i>	<i>Zone Monitored</i>	<i>Top of Riser Elevation (feet AMSL)</i>
<i>South Sector Wells</i>		
1140A	B	583.50
1140B	A	583.50
1141A	B	581.70
1141B	A	581.90
1142A	C/D	579.70
1142B	B	579.50
1142C	A	579.60
1143A	C	577.70
1143B	C	577.20
1143C	B	576.70
1143D	A	576.80
1144A	D	579.70
1144B	B	576.90
1144C	C	577.30
1144D	A	577.20
1150A	A	579.80
1150B	B	578.08
1160A	A	584.20
1160C	C	583.50
1161A	A	582.30
1161B	B	582.61
1161C	C	582.50
1161D	D	582.20
1161E	B	583.81
1162A	-	581.35
1162C	-	581.60
1162D	-	582.14
1163A	A	581.40
1163B	B	581.20
1163C	C	581.30
1163D	D	581.20
1165A	A	589.40
1165B	B	592.20
1165C	C	592.40
1165D	D	589.90
10176A	A	573.60

*
*
*

TABLE 2.1
LIST OF PIEZOMETERS TO BE MEASURED QUARTERLY
LOVE CANAL SITE
LONG TERM MONITORING PROGRAM
NIAGARA FALLS, NEW YORK

<i>Piezometer Identification</i>	<i>Zone Monitored</i>	<i>Top of Riser Elevation (feet AMSL)</i>
<i>South Sector Wells Cont'd</i>		
10176B	B	573.60
10176C	C	573.60
10176D	D	573.60
10276	-	-
<i>Frontier Avenue and Lasalle Expressway</i>		
1151A	A	578.06
1151B	B	578.08
1151C	C	578.27
1151D	D	578.36
1153A	A	577.46
1153B	B	576.67
1153C	C	577.68
1153D	D	577.31
1153E	D	576.80
1154A	A	572.87
1154B	B	573.93
1154C	C	574.03
1154D	D	573.81
<i>Colvin Boulevard Area</i>		
1183A	A	576.62
1183B	B	576.54
1183C	C	577.33
1183D	D	576.91
1184A	A	575.08
1184B	B	575.54
1184C	C	575.08
1184D	D	574.95

TABLE 2.1
LIST OF PIEZOMETERS TO BE MEASURED QUARTERLY
LOVE CANAL SITE
LONG TERM MONITORING PROGRAM
NIAGARA FALLS, NEW YORK

<i>Piezometer Identification</i>	<i>Zone Monitored</i>	<i>Top of Riser Elevation (feet AMSL)</i>
<i>Other Wells</i>		
6290 (south East Canal)	-	-
5222 (Read Ave. Across Admin.)	-	-
3251 (At Church)	-	-
8210 (101 St.)	-	576.83
9205 (100th & Wheatfield)	-	577.66

Zone Monitored

- A = Glacial till
- B = Lower soft silty clay.
- C = Upper stiff silty clay (fractured clay)
- D = Upper fractured stiff clay or fill

- * *Top of riser elevations are not confirmed.*
- *Information not available.*

Within a series of piezometers - similarly suffixed wells were placed at the same elevation within a geologic stratum.

TABLE 2.2
SAMPLE SCHEDULE
LOVE CANAL FACILITY
LONG TERM MONITORING PROGRAM
NIAGARA FALLS, NEW YORK

<u>Annual Wells</u>	<u>Bi-Annual Wells</u>		<u>Additional Wells (1)</u>
<i>Bedrock Wells</i>	<i>Overburden Wells Group I (1995)</i>	<i>Overburden Wells Group II (1996)</i>	
3257	3151	7115	1150
5222	7120	7125	1151
7205	7155	8115	1205
8210	7161	8125	3257
9205	8110	9105	6209
9210	8120	9113	8106
10205	8130	9122	8120
10210A	8140	9130	8130
10210B	9110	10105	9140
10210C	9115	10115	10176A
10225A	9120	10150	10180A
10225B	9125	10178	10215
10225C	9140		10270
10272	10113		
10278	10147		
	10174A		
<i>Overburden Wells</i>			
7130			
7132			
9118			
10135			

Note:

- 1) Specific wells to be sampled selected in consultation with NYSDEC.

TABLE 3.1
WELL CONSTRUCTION DETAILS
LOVE CANAL SITE
LONG TERM MONITORING PROGRAM
NIAGARA FALLS, NEW YORK

<i>Well Number</i>	<i>Ground Elevation</i>	<i>Well Type</i>	<i>Zone Monitored</i>	<i>Depth of Well (feet)</i>	<i>Casing Diameter (inches)</i>	<i>Well Diameter (inches)</i>	<i>Well Material</i>
Annual Wells							
3257	-	Bedrock	BR	29.4	4	2	PVC
5222	-	Bedrock	BR	37.4	-	4	-
7205	574.1	Bedrock	BR	48.0	4	2	SS
8210	573.7	Bedrock	BR	43.8	4	2	SS
9205	574.5	Bedrock	BR	48.7	3	2	SS
9210	582.4	Bedrock	BR	82.3	4	2	SS
10205	578.4	Bedrock	BR	54.3	4	2	SS
10210A	577.2	Bedrock	BR	217.0	4	2	SS
10210B	577.1	Bedrock	BR	140.3	4	2	SS
10210C	577.1	Bedrock	BR	84.0	4	2	SS
10225A	574.5	Bedrock	BR	205.0	4	2	SS
10225B	574.4	Bedrock	BR	137.7	4	2	SS
10225C	574.7	Bedrock	BR	62.5	4	2	SS
10272	-	Bedrock	BR	47.7	-	2	-
10278	-	Bedrock	BR	47.0	-	2	-
7130	574.3	Overburden	A/B	27.0	4.25	2	SS
7132	574.6	Overburden	A	28.0	4.25	2	-
9118	574.1	Overburden	A	35.5	4.25	2	-
10135	577.1	Overburden	A/B	29.5	4.25	2	SS
Bi-Annual Wells							
GROUP I							
3151	-	Overburden	-	25.1	-	2	-
7120	575.0	Overburden	A/B	30.3	4.25	2	SS
7155	573.2	Overburden	A/B	25.6	4.25	2	SS
7161	573.0	Overburden	A/B	21.7	4.25	2	SS
8110	576.5	Overburden	A/B/C	24.0	4.25	2	SS
8120	573.6	Overburden	A/B	27.0	4.25	2	SS
8130	574.6	Overburden	A/B	29.1	4.25	2	SS
8140	574.7	Overburden	A/B	31.0	4.25	2	SS
9110	573.9	Overburden	A/B	24.0	4.25	2	SS
9115	574.0	Overburden	A/B/C	17.9	4.25	2	SS
9120	574.2	Overburden	A/B	20.5	4.25	2	SS
9125	573.5	Overburden	A/B	23.9	4.25	2	SS
9140	578.9	Overburden	A/B	29.0	4.25	2	SS
10113	573.4	Overburden	A/B	27.8	4.25	2	SS
10147	574.4	Overburden	A/B	28.0	2	-	-

TABLE 3.1
WELL CONSTRUCTION DETAILS
LOVE CANAL SITE
LONG TERM MONITORING PROGRAM
NIAGARA FALLS, NEW YORK

<i>Well Number</i>	<i>Ground Elevation</i>	<i>Well Type</i>	<i>Zone Monitored</i>	<i>Depth of Well (feet)</i>	<i>Casing Diameter (inches)</i>	<i>Well Diameter (inches)</i>	<i>Well Material</i>
GROUP II							
10174B	-	Overburden	-	22.9	-	2	-
7115	574.7	Overburden	A/B	31.0	4.25	2	-
7125	574.3	Overburden	A/B	24.5	4.25	2	-
8115	574.6	Overburden	A/B	28.5	4.25	2	-
8125	573.6	Overburden	A/B	27.5	4.25	2	-
9105	573.9	Overburden	A/B	29.4	4.25	2	-
9113	573.4	Overburden	A	34.0	4.25	2	-
9122	573.3	Overburden	A	33.5	4.25	2	-
9130	574.3	Overburden	A/B	30.5	4.25	2	-
10105	577.3	Overburden	A/B	29.5	4.25	2	-
10115	-	Overburden	-	33.7	-	2	-
10150	574.2	Overburden	A/B	31.0	4.25	2	SS
10178	-	Overburden	-	19.2	-	2	-
Additional Wells							
1150A	576.5	Overburden	A	27.0	4.25	2	SS
1151A	575.2	Overburden	A	27.5	4.25	2	SS
1205	-	-	-	-	-	-	-
3257	-	-	-	-	-	-	-
6209	-	Bedrock	BR	42.0	-	2	-
8106	573.1	Overburden	A/B	17.0	4.25	2	-
8120	573.6	Overburden	A/B	27.0	4.25	2	SS
8130	574.6	Overburden	A/B	29.1	4.25	2	SS
9140	578.9	Overburden	A/B	29.0	4.25	2	SS
10176B	-	Overburden	-	19.0	-	2	-
10180A	573.2	Overburden	A/B	18.0	-	-	-
10215	578.2	Bedrock	BR	59.4	4	2	SS
10270	574.5	Bedrock	BR	47.0	N/A	2	SS

Notes: - Information not available.

- A = Glacial till
- B = Lower soft silty clay.
- C = Upper stiff silty clay (fractured clay)
- D = Upper fractured stiff clay or fill
- BR = Bedrock

TABLE 4.1

PROPOSED MONITORING SCHEDULE THROUGH 1997
 LOVE CANAL SITE
 LONG-TERM MONITORING PROGRAM
 NIAGARA FALLS, NEW YORK

Activity	1995						1996												1997											
	July	August	September	October	November	December	January	February	March	April	May	June	July	August	September	October	November	December	January	February	March	April	May	June	July	August	September	October	November	December
Water Levels	X			X			X			X			X			X			X			X			X			X		
Groundwater Sampling																														
Quarterly Hydrograph Reports			○			○			○		○		○		○		○			○		○		○		○		○		○
Annual Sampling Report							○												○											

TABLE 5.1
SUMMARY OF OFF-SITE WELL CONTACTS
LOVE CANAL SITE
LONG TERM MONITORING PROGRAM
NIAGARA FALLS, NEW YORK

[TO COME]

TABLE 5.2
 SAMPLING EQUIPMENT INVENTORY
 LOVE CANAL SITE
 LONG TERM MONITORING PROGRAM
 NIAGARA FALLS, NEW YORK

<i>Equipment Item</i>	<i>Manufacturer/ Supplier</i>	<i>Calibration Required</i>	<i>Comments</i>
Geoguard Purge Pump	Geoguard Inc.	No	Disassemble and decontaminate
Geoguard Bladder Pump	Geoguard Inc.	No	Disassemble and decontaminate
Geoguard Compressor	Geoguard Inc.	No	Gasoline engine driven
Geoguard Controller	Geoguard Inc.	No	Requires 12V Battery
Geoguard Coaxial Tubing	Geoguard Inc.	No	Dedicated for each well where required and stored on spools. Check.
Honda Generator	Honda Motor Co.	No	Gasoline engine driven
Peristaltic Pump	Masterflex/ Homemade	No	Assure tubing is available - (Silicone and Vinyl)
Electronic Water Level Tape	Slope Indicator Co.	No	Decontaminate before use
pH Meter	Orion	Yes	Check and calibrate
Specific Conductivity Meter	Myron-L	Yes	Check and calibrate
Turbidimeter			(Instrument on order)
Organic Vapor Meter	H-Nu	Yes	Check and calibrate
Water Deionizer	Park	No	Check operating condition
Ice Machine		No	Check operating condition
Gasoline Cans (OSHA Approved)	Various	No	For generator/compressor
Plastic Drip Pans	Various	No	For catching spillage during purging/sampling
Nalgene Containers (5 gallon)	Nalgene	No	For deionized water
Well Keys	--	--	--

TABLE 5.2
SAMPLING EQUIPMENT INVENTORY
LOVE CANAL SITE
LONG TERM MONITORING PROGRAM
NIAGARA FALLS, NEW YORK

<i>Equipment Item</i>	<i>Manufacturer/ Supplier</i>	<i>Calibration Required</i>	<i>Comments</i>
Screwdriver, Wrenches, Pliers, Knife	--	--	--
Clipboard and Well Sampling Sheets	--	--	--
Bound Field Logbook	--	--	--
Airline for compressors	Various	No	Check fittings
Purge water containers (carboys or buckets)	Various	No	
Extension Cord	Various	No	
Ground Fault Interrupter Device	Various	No	Test for proper operation

TABLE 5.3

LOVE CANAL SITE
LONG-TERM MONITORING PROGRAM
EXPENDABLE SUPPLIES INVENTORY
NIAGARA FALLS, NEW YORK

<i>Item</i>	<i>Manufacturer/ Supplier</i>	<i>Suggested Quantity</i>	<i>Comments</i>
Custody Tape	Various	4 - 5 Rolls	Can use custody seal provided by lab
Clear Tape-2"	Various	3 - 4 Rolls	For labels, etc.
Duct Tape/Strapping Tape	Various	3 - 4 Rolls	Misc./sealing coolers
String (cotton)	Various	1,000 - 2,000 Feet	200 ft balls
Bottom-Loading Disposable Bailers (Polyethylene)	Voss	24 - 36 (Unweighted)	3 feet long
Bottom-Loading Disposable Bailers (Polyethylene)	Voss	24 - 36 (Weighted)	3 feet long
Vinyl Tubing - food grade	KD Supply -	1,000+ feet	3/8 inch ID x 1/2 inch OD
Conductivity Standards	Various	1 Pint	Check expiration date
pH Standards (4 - 7 - 10)	Various	1 Pint (each)	Check expiration date
Quart size Ziplock Bags	Various	100 Bags	For ice and chain of custodies
6 mil Poly Sheeting	Various	1 roll	To place around well during purging
Pens (Black indelible ink) and Markers	Various	3 - 4 each	
<i>Safety Equipment *</i>			
Non-coated (White) Tyvek	Various	2 - 3 Cases	Sized to sampling personnel
Latex Surgical Gloves	Various	2 - 3 Cases	Rinse blank required
Rubber Overboots	Various	1 Per Sampler	
Organic Vapor/Acid Gas HEPA Filters	Various	1 - 2 Boxes	Appropriate for respirators worn

Note:

- * - Each sampler to have own respirator, work boots, hard hat and safety glasses with side shields.

TABLE 7.1
LIST OF LONG TERM MONITORING PROGRAM PARAMETERS
LOVE CANAL SITE
NIAGARA FALLS, NEW YORK

Method 8240 - Target Compound List Volatile Organics

Compound
(Units of Measure = $\mu\text{g/L}$)

Acetone
Benzene
Bromodichloromethane
Bromoform
Bromomethane
2-Butanone
Carbon disulfide
Carbon tetrachloride
Chlorobenzene
Chloroethane
2-Chloroethylvinyl ether
Chloroform
Chloromethane
Dibromochloromethane
1,1-Dichloroethane
1,2-Dichloroethane
1,1-Dichloroethylene
trans-1,2-Dichloroethylene
1,2-Dichloropropane
cis-1,3-Dichloropropane
trans-1,3-Dichloropropene
Ethylbenzene
2-Hexanone
Methylene chloride
4-Methyl-2-pentanone
Styrene
1,1,2,2-Tetrachloroethane
Tetrachloroethylene
Toluene
1,1,1-Trichloroethane
1,1,2-Trichloroethane
Trichloroethylene
Vinyl acetate
Vinyl chloride
Total Xylenes

TABLE 7.1
LIST OF LONG TERM MONITORING PROGRAM PARAMETERS
LOVE CANAL SITE
NIAGARA FALLS, NEW YORK

Method 8270 - Target Compound List Base/Neutral/Acid Extractables

Compound
(Units of Measure = $\mu\text{g/L}$)

Acenaphthene
Acenaphthylene
Anthracene
Benzo(a)anthracene
Benzo(a)pyrene
Benzo(b)fluoranthene
Benzo(g,h,i)perylene
Benzo(k)fluoranthene
Benzoic acid
Benzyl alcohol
Bis(2-chloroethoxy)methane
Bis(2-chloroethyl)ether
Bis(2-chloroisopropyl)ether
Bis(2-ethylhexyl)phthalate
4-Bromophenylphenylether
Butylbenzylphthalate
4-Chloroaniline
2-Chloronaphthalene
4-Chlorophenylphenylether
Chrysene
Dibenzo(a,h)anthracene
Dibenzofuran
1,2-Dichlorobenzene
1,3-Dichlorobenzene
1,4-Dichlorobenzene
3,3'-Dichlorobenzidine
Diethylphthalate
Dimethylphthalate
Di-n-butylphthalate
2,6-Dinitrotoluene
2,4-Dinitrotoluene
Di-n-octylphthalate
Fluoranthene
Fluorene
Hexachlorobenzene
Hexachlorobutadiene
Hexachlorocyclopentadiene

TABLE 7.1
LIST OF LONG TERM MONITORING PROGRAM PARAMETERS
LOVE CANAL SITE
NIAGARA FALLS, NEW YORK

Method 91-2 - Target Compound List Base/Neutral/Acid Extractables (continued)

Compound
(Units of Measure = $\mu\text{g/L}$)

Hexachloroethane
Indeno(1,2,3-cd)pyrene
Isophorone
2-Methylnaphthalene
Naphthalene
2-Nitroaniline
3-Nitroaniline
4-Nitroaniline
Nitrobenzene
N-nitroso-di-n-propylamine
N-nitrosodiphenylamine
Phenanthrene
Pyrene
1,2,4-Trichlorobenzene
2-Chlorophenol
2,4-Dichlorophenol
2,4-Dimethylphenol
4,6-Dinitro-o-cresol
2,4-Dinitrophenol
2-Methylphenol
4-Methylphenol
2-Nitrophenol
4-Nitrophenol
p-Chloro-m-cresol
Pentachlorophenol
Phenol
2,4,5-Trichlorophenol
2,4,6-Trichlorophenol

TABLE 7.1
LIST OF LONG TERM MONITORING PROGRAM PARAMETERS
LOVE CANAL SITE
NIAGARA FALLS, NEW YORK

Method 91-3 - Target Compound List Organochlorine Pesticides/PCBs

Compound
(Units of Measure = µg/L)

Aldrin
Alpha-BHC
Beta-BHC
Delta-BHC
Gamma-BHC
Chlordane
Alpha Chlordane
Gamma Chlordane
4,4'-DDD
4,4'-DDE
4,4'-DDT
Dieldrin
Endosulfan I
Endosulfan II
Endosulfan sulfate
Endrin
Heptachlor
Heptachlor epoxide
Toxaphene
Aroclor 1016
Aroclor 1221
Aroclor 1232
Aroclor 1242
Aroclor 1248
Aroclor 1254
Aroclor 1260
Endrin ketone
Methoxychlor
Endrin Aldehyde

TABLE 7.2

CONTAINER, PRESERVATION, HOLDTIME, AND SHIPPING REQUIREMENTS
 LONG-TERM MONITORING PROGRAM
 LOVE CANAL SITE
 NIAGARA FALLS, NEW YORK

<i>Analysis</i>	<i>Sample Containers</i>	<i>Preservation</i>	<i>Maximum Holding Times</i>	<i>Volume of Sample</i>	<i>Shipping Means</i>
TCL Volatiles	2 x 40 mL glass teflon septum vials	pH<2 with HCl Cool to 4°C (±2°C)	10 days from collection to analysis	Fill completely	Overnight Courier
TCL BNA	2 x 1 L amber glass bottle	Cool to 4°C (±2°C)	7 days from collection to extraction 40 days from extraction to analysis	Fill completely	Overnight Courier
PCBs and TCL Organochlorine Pesticides	2 x 1 L amber glass bottle	Cool to 4°C (±2°C)	7 days from collection to extraction 40 days from extraction to analysis	Fill completely	Overnight Courier

APPENDIX A

VENDORS INFORMATION

MASTER-FLAD

Ground Water Sampling Systems

WELL PURGING/DEVELOPMENT PUMPS

To insure rapid recovery and representative ground-water sampling, the monitoring well must be developed by removing the mud cake from the well screen area. For this purpose GEOGUARD Well Purging/Development Pumps are fitted with flexible finned swabs, and surged up and down within the well to dissolve the mud cake and naturally occurring fine material in and around the well screen. The suspended material is then removed by the gas-drive purge pump.

Operated from standard pump cycle controllers and compressors, GEOGUARD Well Purging/Development Pumps are designed to provide high flow rates, with a minimum of compressed air. With only two moving parts, these pumps are designed to survive sand and dry pumping cycle after cycle, and year after year.

- Available in pump diameters for 2 inch and larger wells.
- Purge rates up to 7.5 gpm using the Model 55000 controller and 5401 compressor.
- Comprised of NSF-PW rated PVC, or Type 316 Stainless Steel & Teflon®, with polypropylene fittings and Viton® O-rings.
- Capable of lifting from 400 feet (120 meters) without modification.
- Teflon intake and discharge check balls for long, trouble-free pumping.
- Rugged, heavy gauge, threaded construction for rapid disassembly, without tools.*
- Threaded intake (1/2" or 3/4" female pipe thread) for use with well development swabs or drop tube probe.
- 1 Year Unconditional Warranty.

* Model 5952 features a welded design, with removable external check valve assemblies.

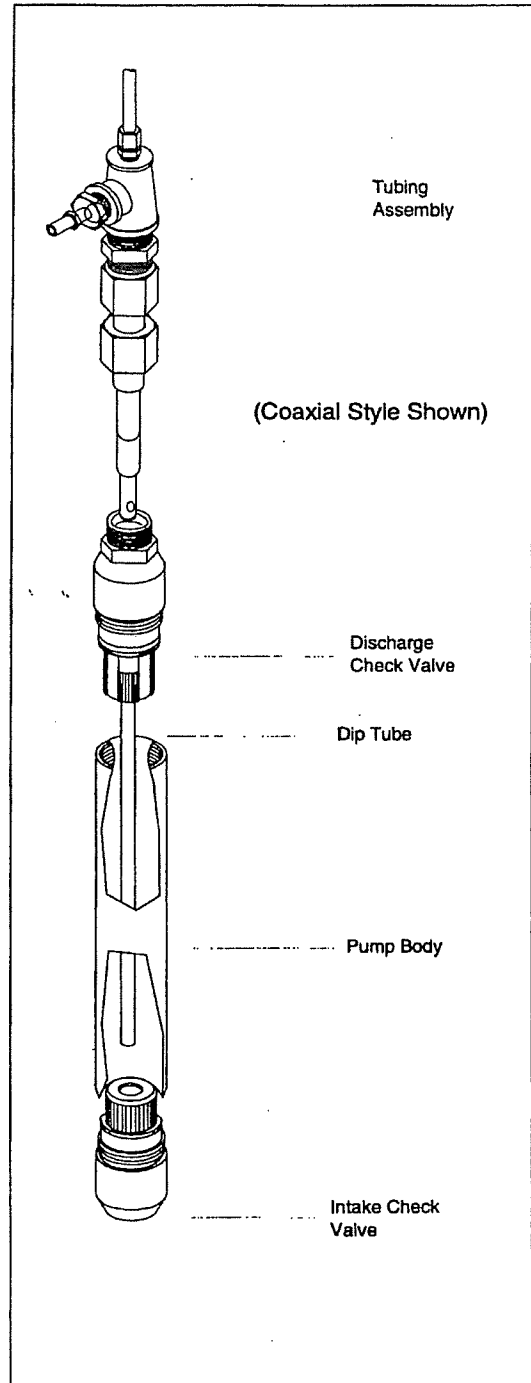

For applications assistance call 1-800-645-7654 .

MASTER-FLD

Ground Water Sampling Systems

5600 SERIES BLADDER PUMPS

Available in a wide range of sizes and capacities to meet virtually any pumping situation, GEOGUARD 5600 Series Bladder Pumps meet all EPA requirements for representative ground water monitoring in both portable and dedicated situations.

The smallest diameter pump will fit a 1.5 inch, or restricted, well casing. All models can be lengthened for improved flow rate and longer periods of low, continuous flow.

- Available in pump diameters for 1.5" (38.1 mm) and larger wells.
- Pumping rates up to 2.5 gpm (9.5 lpm) @ 25 ft. (7.62 m) in a 2" (51 mm) well...large air and water porting enables faster pump/fill cycles; larger bladder than conventional bladder pumps permits more volume pumped per cycle.
- EPA recommended materials including Type 316 Stainless Steel and Teflon®, PVC and Teflon®, or all Teflon®.
- Large water discharge porting (.375 inch) reduces pressure gradients between the bladder and discharge tubing, lessening the potential for orifice outgassing that can compromise dissolved gas and VOC samples.
- Factory sealed, field replaceable, Teflon® bladder cartridges slip into place, without tools or clamps. Lifetime guarantee on all dedicated components.
- Withstands dry pumping.
- Threaded pump intakes permit the use of intake drop tube extensions, booster pump applications, and other unique configurations.
- Type 316 Stainless Steel, .010 inch intake screens help protect bladders from sand.
- Contaminant-free certification - all pumps are cleaned, lab tested and individually sealed in polyethylene bags.

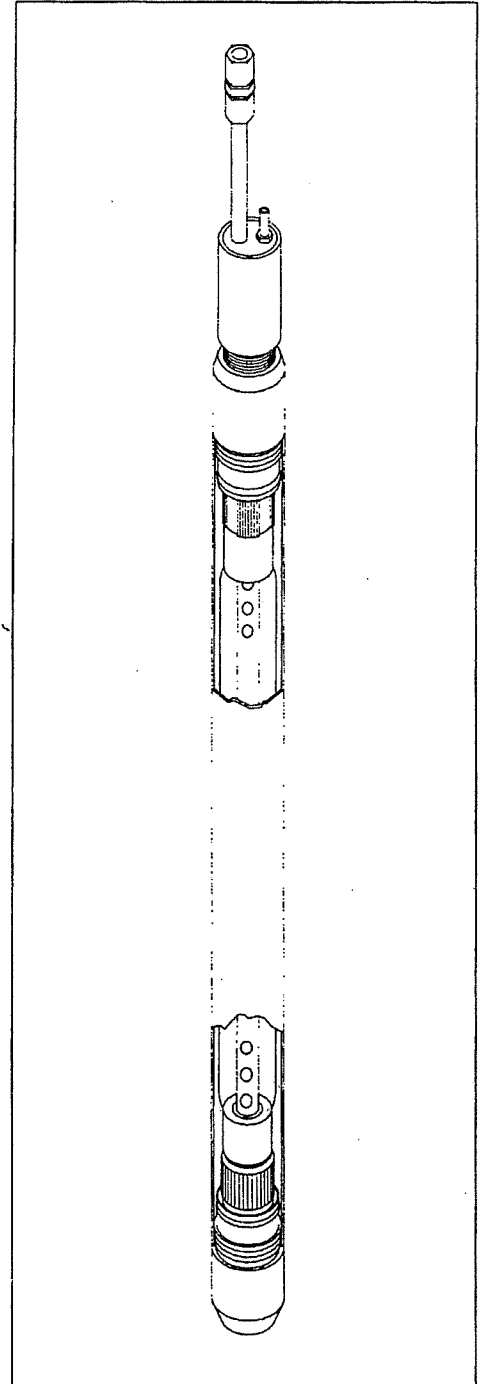

For applications assistance call 1-800-645-7654.

WELL PURGING/DEVELOPMENT PUMPS

DESIGN SPECIFICATIONS

MODEL	MATERIAL	DIAMETER (in./mm.)	LENGTH (in./cm.)	WEIGHT (lbs./kg.)	CAPACITY (gal./L)	TUBING STYLE
5612	S.S./Teflon	1.66/42	78/198	9.2/4.2	0.58/2.2	Coaxial
5612D	S.S./Teflon	1.66/42	78/198	9.2/4.2	0.58/2.2	Coaxial
5952	S.S./Teflon	2.88/73	56/142	12.5/5.7	1.05/4.0	Twin
5632	PVC/Teflon	1.90/48	78/198	3.8/1.7	0.66/2.5	Coaxial
5632D	PVC/Teflon	1.90/48	78/198	3.8/1.7	0.66/2.5	Coaxial
5662	PVC/Teflon	2.88/73	60/152	6.0/2.7	1.05/4.0	Twin

Note: "D" suffix denotes development pump which uses heavy walled coaxial tubing.

ENGINEERING SPECIFICATIONS

1. The pump shall have a major diameter to permit installation into (specify) 2 inch, or 3 inch and larger wells.
2. The pump shall utilize Teflon® intake and discharge check balls.
3. The pump shall be of a threaded design, such that it may be disassembled without tools for cleaning and/or servicing. The threaded connections shall include Viton® O-ring seals. (Model 5952 excepted.)
4. The pump shall be a positive displacement gas-drive pump, whereby a compressed air charge displaces the water contained within the interior of the pump, forcing it up through the discharge tubing to the top of the well casing.
5. The pump shall be capable of pumping dry without damage. It shall also be capable of pumping sand, silt, etc., without damage.
6. The pump shall be capable of lifting from 400 feet (120 m), with the application of 200 psi (14 bars) air pressure, without modification.
7. The pump shall have a threaded intake to permit use of well a development swab, or drop tube probe. Models 5612, 5612D, 5632, and 5632D shall be 3/4" female pipe thread. Model 5952 shall be 1/2" female pipe thread.
8. Pump Models 5632, 5632D, and 5662 shall be constructed of NSF-PW rated PVC and Teflon.
9. Models 5612, 5612D, and 5952 shall be constructed of Stainless Steel and Teflon.

Note: Teflon & Viton are registered trademarks of E.I. duPont.

GEUGUARD
Dedicated To Ground Water Technology

536 ORIENT STREET • P.O. BOX 149 • MEDINA, NEW YORK 14103 • 1-800-645-7654

ORION

LABORATORY PRODUCTS GROUP PORTABLE pH/ISE METERS INSTRUCTION MANUAL

Model 230A
Model 250A
Model 290A

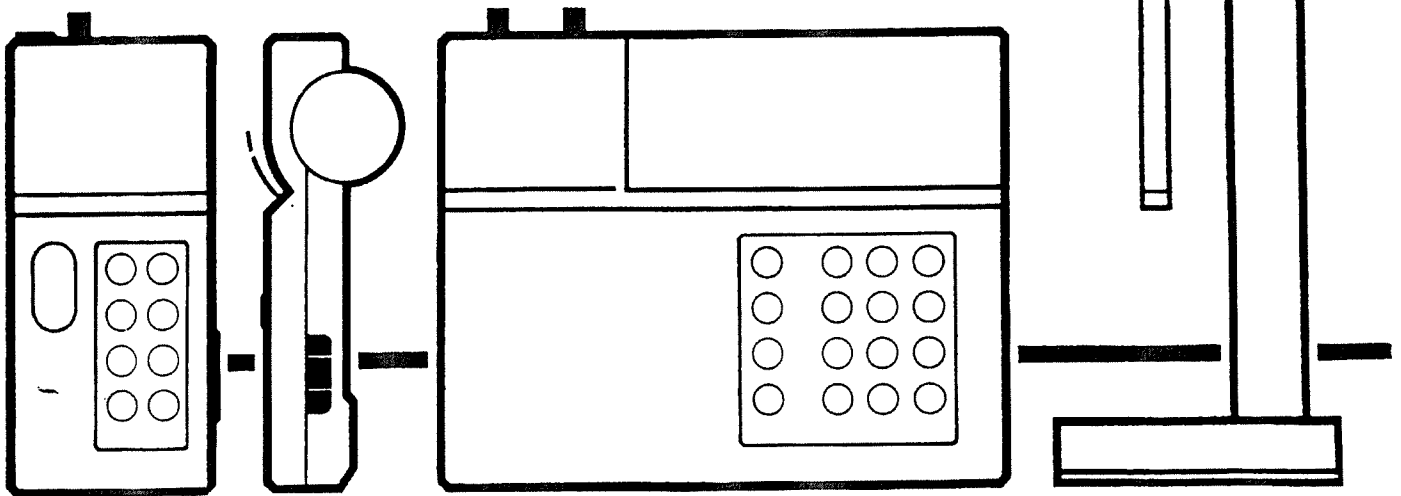

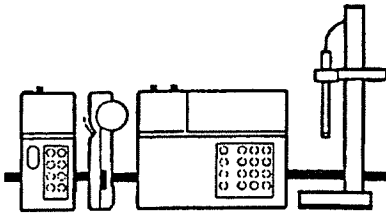

Display (Model 230A)

- | | | | |
|---|---|--|---|
| <p>1. Operating Mode</p> <p>SETUP</p> <p>CALIBRATE</p> <p>MEASURE</p> | <p>Indicates instrument operating mode.</p> <p><i>Indicates meter is in setup mode. Used to define operating parameters</i></p> <p><i>Indicates the meter is in calibration mode. Accessed by pressing the cal key.</i></p> <p><i>Indicates the meter is in measurement mode, accessed by pressing the measure key.</i></p> | <p>5. ATC</p> <p>6. 2nd</p> <p>7. READY</p> <p>8. HOLD</p> <p>9. TIMER</p> <p>10. BAT.</p> | <p>Displayed when a temperature probe is attached.</p> <p>Displayed when the 2nd key has been pressed, indicating the meter is ready to perform a second function.</p> <p>Displayed when the electrode signal has stabilized. The Ready function may be turned on or off in the setup menu.</p> <p>Displayed when the pH reading is frozen after reaching stability in measure mode. The HOLD feature may be turned on or off in the SETUP menu</p> <p>Displayed when the timer function has been activated.</p> <p>Displayed when the battery is low and needs to be replaced.</p> |
| <p>2. Main Field</p> | <p>Displays pH readings, electrode slope and other significant information.</p> | | |
| <p>3. ON/OFF</p> | <p>Indicates if a particular feature is active or not in the SETUP menu.</p> | | |
| <p>4. Lower Field</p> | <p>Displays temperature in degrees Celsius. The °C designation is displayed when temperature is displayed.</p> | | |

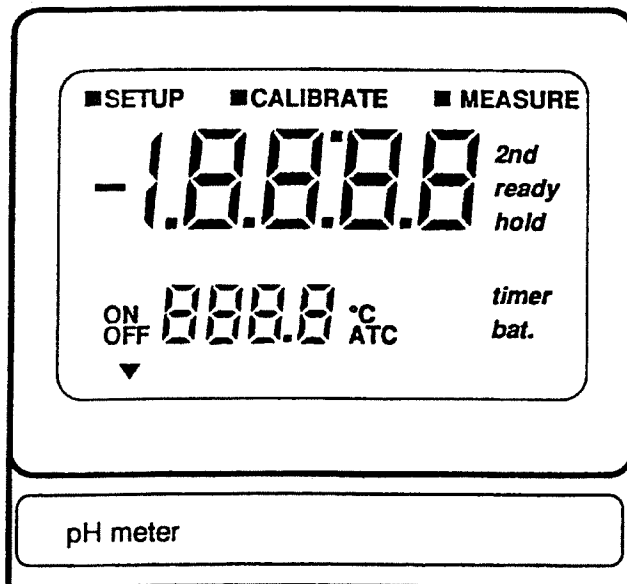

Figure 8

Keypad (Model 230A)

(See Figure 9)

Primary Functions

- yes** Press to enter a value during calibration or setup. May also be used to scroll through the setup menu without changing any parameters.
- no** Press to cancel a change to a parameter before entering.
- measure** Press for sample analysis. Instrument will remain in measure mode until another key is pressed. Press to unlock hold.
- cal** Press to start calibration. Meter automatically advances to measure after the calibration is complete.
- 2nd** Press to access second functions: timer or setup menu.
- ∧** Press to increase value.
- ∨** Press to decrease value
- power** Press to turn meter on or off.

Second Functions

All second functions are accessed by first pressing the 2nd key.

- timer** Press to start the timer. When the preset time has elapsed the instrument will beep for 1 minute (or until a key is pressed).
- setup** Press to access the setup menu. This is used for setting instrument operating parameters.

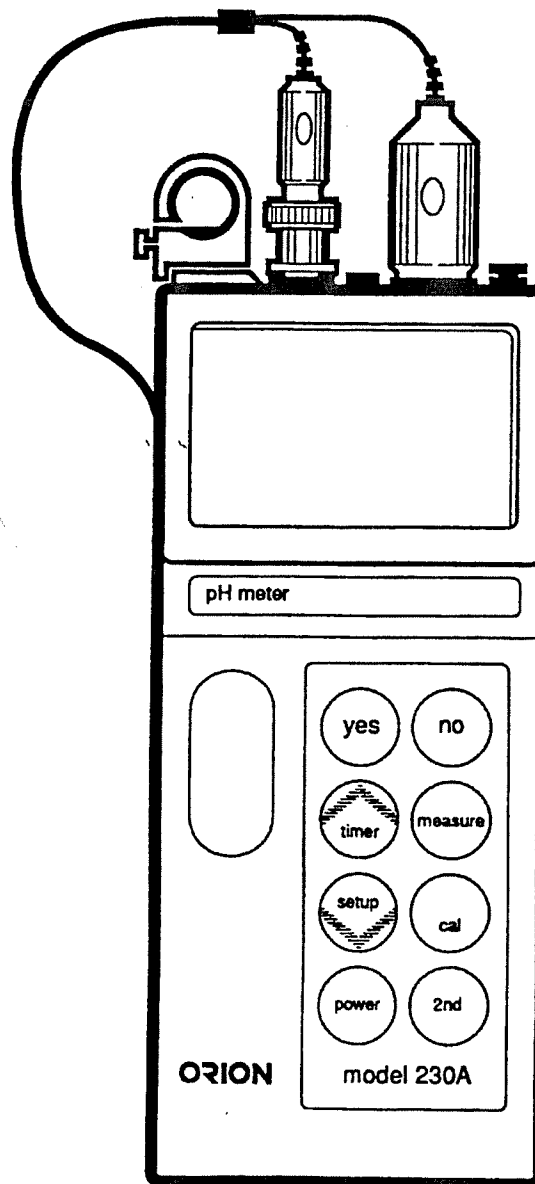

Figure 9

Checkout Procedure (Model 230A)

Note: To change a value press one of the ^ v keys. The first digit will flash, continue scrolling until the first digit equals the correct value then press YES. The second digit will flash. Scroll to the correct value then press YES and continue for each digit.

1. Perform the self-test as described on page 10. After the self check is complete, press the power key to turn meter on. Press measure. Main display should read a steady 7.00 ±0.02. If not follow steps 1a through 1c.
 - a. Press **cal**, when the display flashes 7.00 press **yes**.
 - b. Press **measure**. The main display should read 100.0 with the legend SLP in the lower display. If so, press **yes**.
 - c. If not, scroll until the display reads 100.0 then press **yes**. The meter advances to **measure** and the display should now read a steady 7.00.
2. The meter is now ready for use with a pH electrode. Remove the shorting plug.

SETUP Menu (Model 230A)

The SETUP menu is used to identify and change instrument operating parameters. While in SETUP the **yes** key is used to scroll through the menu without changing any parameters. To change a parameter press one of the scroll keys, ^ v, then **yes** to enter. Pressing **no** reverts the parameter to its former state (if done before entering the new setting).

To enter the SETUP menu press 2nd then **setup**. 1-1 and READY will be displayed. The on or off indicator will flash indicating the current status. Press **yes** to accept and continue through the menu. Press a scroll key, ^ v, to change. After changing a setting press **yes** to enter.

To change a numeric value press the ^ or v key. The first digit will start flashing, scroll until the first digit is the desired value then press **yes**. The second digit will flash, scroll until the desired value is displayed then Press **yes**. Continue in this manner until all digits have been changed to the desired value.

Scroll through the SETUP menu accepting or changing parameters as desired. To exit the SETUP menu press **cal** to begin the CALIBRATION sequence or **measure** to analyze samples.

The following parameters are accessed in the setup menu.

1-1 READY

Turning READY on will cause the ready indicator to be displayed when the electrode signal is stable. It is always on during calibration and when hold is turned on. The default setting is on.

1-2 HOLD

Turning HOLD on will cause the display to freeze during sample measurements when the electrode signal is stable. Press the measure key to unlock HOLD during analysis. The default setting is off.

1-3 BEEP

Turning BEEP on will cause an audible signal to sound when a key is pressed, when the electrode signal is stable (on ready), and when an operator assistance code is displayed. The default setting is on.

1-4 AUTOSHUTOFF

Turning AUTOSHUTOFF on will cause the meter to turn off if no keys have been pressed for 10 minutes. This feature will save battery life. The default setting is on.

2-1 SLOPE

Allows review of electrode slope in memory at any time. Value cannot be changed in the SETUP menu.

3-1 TIMER INTERVAL

Used to set the timer interval. The maximum interval that can be set is 23 hours, 59 minutes, and 59 seconds. The minimum interval is five (5) seconds. When the TIMER INTERVAL code, (3-1), is displayed the current interval hours setting is first displayed in the main field (H 00). Press **yes** to accept current setting or scroll to desired value then press **yes** to enter. Next the current interval minutes:seconds will be displayed. Press **yes** to accept or change to desired value then press **yes**. The default setting is five seconds.

3-2 TIME REMAINING

Allows review of the time remaining before the TIMER is set to go off. If the timer has not been activated 00:00 will be displayed.

Calibration and Measurement Procedures (Model 230A)

pH Measurements

A one or two buffer calibration should be performed before pH is measured. It is recommended that a two buffer calibration using buffers that bracket the expected sample range be performed at the beginning of each day to determine the slope of the electrode. This serves the dual purpose of determining if the electrode is working properly and storing the slope value in memory. Perform a one buffer calibration every two hours to compensate for electrode drift.

Prior to calibration, scroll through the setup menu and ensure all parameters are set correctly for the analysis you want to perform.

There are two ways of calibrating the 230A Meter; autocalibration or manual calibration. Following are descriptions and instructions for each method.

Autocalibration

Autocalibration is a feature of the Model 230A Meter that automatically recognizes the buffers 7.00, 4.01, and 10.01 within a range of ± 0.5 pH units. During calibration the user waits for a stable pH reading. Once the electrode is stable the meter automatically recognizes and displays the temperature corrected value for that buffer. Pressing YES enters the value into memory.

Note: Do not scroll when using autocalibration.

The 230A Meter compares actual values to theoretical values to determine if the buffer is within range. Results greater than ± 0.5 pH units from the theoretical value will trigger an operator assistance code. For best results, it is recommended that an ATC probe be used. If an ATC probe is not used, all samples and buffers should be at the same temperature or use manual temperature compensation. See page 43.

Autocalibration with Two Buffers

1. Connect electrode(s) to meter. Choose either 4.01 and 7.00, or 7.00 and 10.01 buffers, whichever will bracket your expected sample range.
2. Place electrode(s) into either 4.01, 7.00, or 10.01 buffer.
3. Press **cal**. CALIBRATION is displayed above the main readout and P1 is displayed in the lower field. P1 indicates that the meter is ready for the first buffer. When the electrode is stable the READY prompt will be displayed and the temperature-corrected value for the buffer is displayed. Press **yes**. The display will remain frozen for two seconds then P2 will be displayed in the lower field indicating the meter is ready for the second buffer.
4. Rinse electrode(s) and place in second buffer. Wait for a stable pH display and press **yes**. After the second buffer value has been entered the electrode slope will be displayed. SLP appears in the lower field while the actual electrode slope (in percent) appears in the main field.

The meter automatically advances to the measure mode. MEASURE is displayed above the main field.

5. Rinse electrodes, place into sample. Record pH and temperature directly from the meter display.

Autocalibration with One Buffer

1. Connect electrode(s) to meter. Select one buffer, either 4.01, 7.00, or 10.01 whichever most closely approximates the expected sample pH.
2. Place electrodes into the buffer and press **cal**. CALIBRATE will be displayed above the main field and P1 will be displayed in the lower field.
3. Wait for a stable reading (the display will flash) and press **yes**. The display will remain frozen for two seconds then P2 will be displayed in the lower field.
4. Press **measure**. SLP will be displayed in the lower field and the electrode slope in memory will be displayed in the main field. Press **yes** or if necessary enter the correct electrode slope determined by a two point calibration. Then press **yes**. If slope value is unknown enter 100.0 or perform a two buffer calibration.
5. Rinse electrodes and place into sample. Record pH and temperature directly from the meter display.

Manual Calibration

To calibrate with buffers other than 4.01, 7.00, or 10.01, use the manual calibration technique. The calibration sequence is the same as autocalibration except buffer values are scrolled in.

Note: For manual calibration you must use the scroll keys otherwise the meter assumes you are performing an autocalibration. Even if the buffer value displayed is correct you must press a scroll key to start the editing process. Then press yes to accept each digit.

For best results it is recommended that an ATC probe be used. If an ATC probe is not used, all samples and standards should be at the same temperature or use manual temperature compensation. See page 43.

Manual Calibration with Two Buffers

1. Connect electrode(s) to meter. Choose two buffers that will bracket your expected sample range.
2. Place electrode(s) into the first buffer.
3. Press **cal**. CALIBRATE will be displayed above the main readout and P1 will be displayed in the lower field.
4. Wait for a stable pH display then press the Λ or V key. The first digit will start flashing. Scroll until the correct value appears in the first digit, press **yes**. The second digit will start flashing. Scroll until the correct value appears, then press **yes**. Continue in this manner until all digits have been correctly entered.

The display will remain frozen for two seconds, then P2 will be displayed in the lower field indicating the meter is ready for the second buffer.

5. Rinse electrode(s) and place into second buffer. Wait for a stable pH display then enter the correct value as described above.
6. The electrode slope (in percent) is then displayed in the main field with SLP in the lower field. The meter automatically advances to MEASURE mode.
7. Rinse electrode(s) and place into sample. Record pH and temperature directly from the meter display.

Manual Calibration with One Buffer

1. Connect electrode(s) to meter. Choose a buffer which most closely approximates the expected sample pH. Place electrode(s) into buffer.
2. Press **cal**. CALIBRATE will be displayed above the main field and P1 will be displayed in the lower field.
3. Wait for a stable pH display then enter the correct buffer value. To enter a value press the Λ or V key. The first digit will flash, continue pressing the scroll key until the desired value is displayed. Press YES to accept. Continue for each digit. When the correct buffer value is displayed press YES to enter.
4. The P2 prompt will be displayed in the lower field. Press **measure**.
5. The slope prompt, SLP, will now be displayed in the lower field and the electrode slope (in percent) will be displayed in the main field. Press **yes** to enter the current electrode slope or scroll in a new value then press **yes**.

The meter automatically advances to MEASURE mode.

6. Rinse electrode(s) and place into sample. Read sample pH directly from the meter display. Sample temperature is displayed in the lower field.

Dissolved Oxygen Measurements (Model 230A)

Dissolved oxygen measurements are displayed in ppm when the ORION Model 97-08 Dissolved Oxygen Electrode is used with the ORION Model 230A Meter. Follow these instructions for preparing the meter and calibrating the electrode.

1. Connect the Model 97-08 to meter and leave electrode mode switch "OFF".
2. Disconnect ATC probe.

Note: ATC probe must not be connected to the meter.

3. Turn the HOLD feature (1-2) off.
4. Press **measure**. Using the scroll keys change the temperature value to 25.0°C.
5. Press the **cal** key. Enter the value 7.00 and press **yes**.
6. Press the **measure** key. The slope prompt, SLP, will be displayed in the lower field. Enter 100.0 and press **yes**.

The meter will automatically enter MEASURE mode.

7. Turn the mode switch on the electrode to BT CK. Good battery operation is indicated by a reading of 13.40 or greater on the meter.
8. Turn the mode switch on the electrode to ZERO. Use the zero calibration control to set the meter to read 0.00.
9. Insert the reservoir (funnel) into a BOD bottle containing enough water to just cover the bottom. Insert the electrode, making sure that the electrode tip is not immersed in the water and does not have water droplets clinging to the outside of the membrane. Let stand approximately 30 minutes to ensure water saturation of air in the BOD bottle. This bottle should be used for storage between measurements.

10. Turn the electrode mode switch to the AIR position. If measurements are being made at sea level use the AIR calibration control on the electrode to set the pH meter reading to the prevailing barometric pressure in mm Hg(divided by 100). If the barometric pressure is unknown, if the elevation is above sea level or if the sample has a salinity greater than 2 parts per thousand, consult **Table 1** found in the *Model 97-08 Instruction Manual* to obtain the correct AIR setting.

11. Turn the electrode mode switch to H₂O for sample analysis.

DESCRIPTION

This manual describes your Myron L EP series meter, tells you how to use it, and how to keep it working accurately for many years.

Myron L EP & EP10 Meters are compact, multi-range instruments which operate on the principle of electrical conductivity. They each contain a built-in cell cup and will quickly determine the conductivity of almost any solution. Both have dials calibrated in micromhos (μ mhos) equivalent to the metric microsiemens (μ S). Model EP features a second dial scale calibrated in megohms/resistivity for testing ultrapure water.

Both are 3.4" x 4.5" x 4.0" (85 x 129 x 126mm) and weigh less than one pound (0.45 kg). EP series meters are completely self-contained. The built-in cell is automatically temperature compensated. They are powered by two 9 volt transistor batteries good for at least 2000 tests, or one year shelf life.

MODEL RANGES

EP 0-0.5, 0-5, 0-50, 0-500, 0-5,000 micromhos (μ mhos)
2-30 Megohms

EP10 0-10, 0-100, 0-1,000, 0-10,000 micromhos (μ mhos)

ACCURACY: (Both Models) $\pm 2\%$ of full scale
REPEATABILITY: (Both Models) $\pm 1\%$

TEMPERATURE COMPENSATION:

EP 32-120°F (0-49°C)
EP-10 50-160°F (10-71°C)

By using an RE-10 Range Extender (see ACCESSORIES), the maximum range of each meter may be increased ten times.

The pictures in this manual show the major operating parts of your Myron L EP series meter. Handle your meter and identify these parts to become familiar with it.

Model EP10 shown

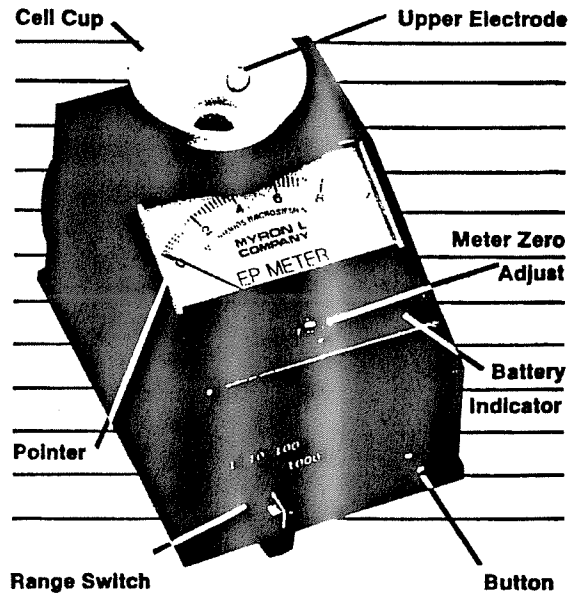

MYRON L
COMPANY

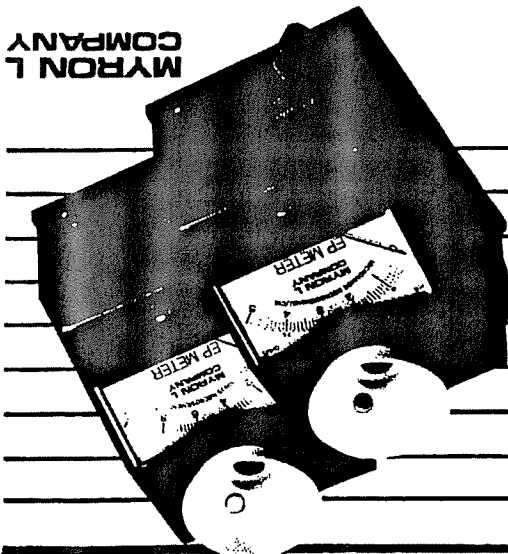

EP10

Users Manual for Models EP

USING YOUR METER

1. Turn the Range Switch to the desired range. If you don't know which range to use, set it to 1000.
2. Rinse the cell cup three times with the sample you want to test. (For very hot or very cold samples see TEMPERATURE COMPENSATION below.)

NEVER FILL THE CELL BY DIPPING THE METER INTO WATER!

3. Fill the cell with another sample to at least $\frac{1}{4}$ " (6mm) above the upper electrode.
4. Press the black button.
5. Read the dial's black scale value indicated by the pointer. If the pointer is very low on the left or goes off the scale to the right, try the next lower or higher range.
6. Multiply the dial's black scale value by the range setting to determine conductivity in micromhos (microsiemens).
7. If the pointer goes off the scale to the right on the x1000 range, use an RE-10 range extender (see ACCESSORIES).

NOTE:

When you are finished with the meter, RINSE THE CELL CUP with clean water, preferably distilled or deionized.

TEMPERATURE COMPENSATION: For very hot or very cold solutions, let the three rinse samples each remain in the cell for several seconds, then immediately fill the cell with the sample you want to test (step 3 above). This allows the automatic temperature compensation feature time to work properly.

RESISTIVITY MEASUREMENT: Model EP only. Accurate measurement of high purity water is difficult even under controlled conditions. Water temperature and even

carbon dioxide (CO_2) in the atmosphere will greatly influence resistivity. Use the following methods for best accuracy:

1. Turn the range switch to the x.1 range (with the " Ω " symbol around it).
2. Hold your meter close to the high purity water outlet. While pressing the button, allow the water to flow into the Cell Cup and out again, continuously purging the cell.
3. As the cell is washed clean of trace contamination, the reading will drop and eventually stabilize. Read the resistivity directly in megohms on the red scale. **DO NOT** multiply the dial reading by the range switch value.

NOTE:

The closer the tested water temperature is to 25°C (77°F), and the less it is exposed to air, the more accurate your reading will be.

CAUTION

ALWAYS rinse the cell cup with pure water immediately after use or cleaning. This will prevent the build-up of unwanted deposits and possible contamination of the next sample.

DO NOT use with samples hotter than specified. The readings WILL NOT be accurate.

DO NOT splash solvents such as lacquer thinner, acetone, benzene or chlorinated solvents on the plastic case.

DO NOT fix or modify the meter. That will void your warranty. See SERVICE for details or consult Myron L Company.

DO NOT DIP THE INSTRUMENT INTO WATER. If water does get inside the instrument, see MAINTENANCE for instructions on drying it.

MODEL EP

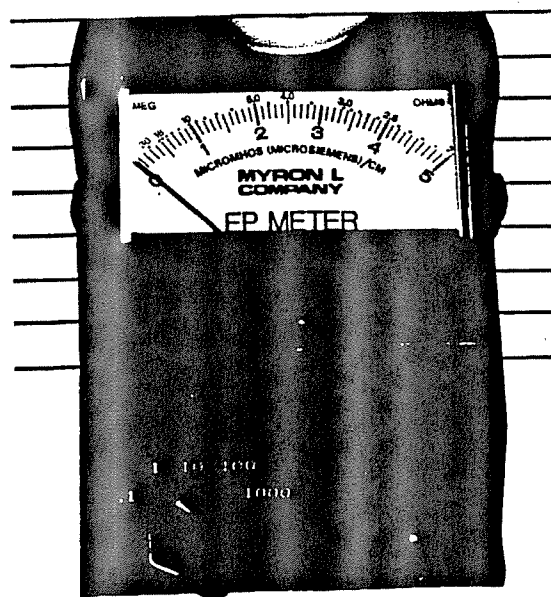

MODEL EP10

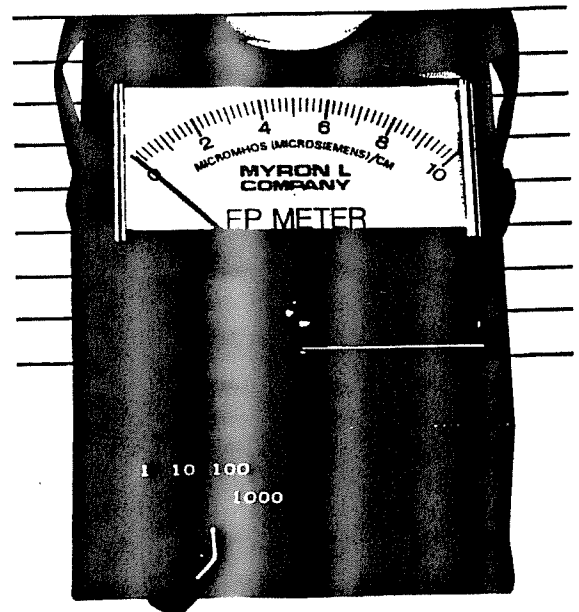

DESCRIPTION

This manual describes your Myron L EP series meter.

By using an RE-10 Range Extender (see ACCESSORIES), the maximum range of each meter may be increased ten times.

The pictures in this manual show the major operating

CALIBRATION/MAINTENANCE

STANDARD SOLUTIONS: A Standard Solution has a known conductivity and ppm. Your meter was calibrated at the factory using Standard Solutions. You can keep your meter accurate by using these same Standard Solutions. To pick the right Myron L Company Standard Solution for your meter see ACCESSORIES.

How often you calibrate your meter depends on how much you use it. For once a day use, recalibrate it every three months.

CHECKING CALIBRATION

1. Turn the Range Switch to the x1000 range.
2. Test a sample of appropriate Standard Solution.

CAUTION: Throw the Standard Solution away as you use it. Don't put the used samples back in the bottle.

3. If the meter does not indicate the same value as is on the Standard Solution bottle's label, first clean the cell. For directions on how to do this see CELL CUP. Rinse the cell thoroughly and test the Standard Solution again. If the meter still does not indicate the correct value, recalibrate it as described below.

TO RECALIBRATE YOUR METER

1. Remove the bottom cover using fingernails or a small screwdriver to loosen the front or rear edge. Identify the Calibration Control (see photo below) so you can find it by touch while calibrating.
2. Test another sample of the Standard Solution (be careful to not splash solution inside the meter).
3. Adjust the Calibration Control until the meter indicates the value that is on the Standard Solution label.

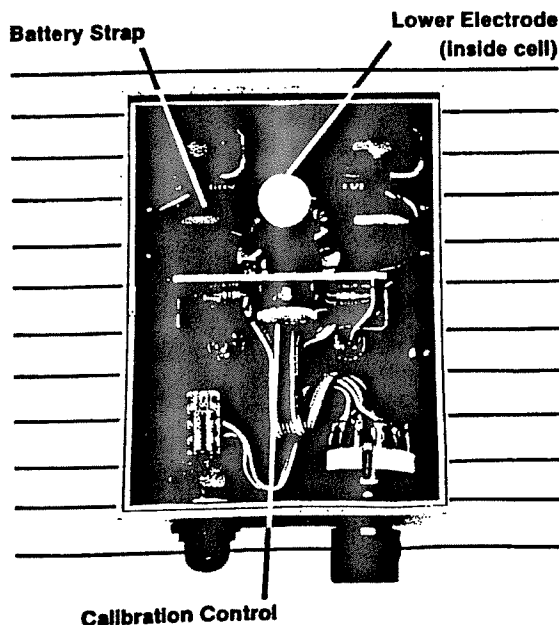

MAINTENANCE

BATTERY CHECK

Models EP and EP10 have a battery indicator glow light visible through the small hole on the lower right-hand corner of the meter face plate. If this light fails to glow when the black button is pressed, replace both batteries.

BATTERY REPLACEMENT

To replace the batteries detach the battery connectors. Pull on the vinyl straps to remove the batteries. Replace with fresh zinc carbon or alkaline 9 volt batteries. Reinsert the vinyl straps to secure batteries.

CELL CUP

Self-conditioning of the built-in electrodes occurs each time the button is pressed with a sample in the cell cup.

ACCESSORIES

STANDARD SOLUTIONS

Your EP Meter has been factory calibrated with the appropriate Standard Solutions. All Myron L Conductivity Standard Solutions are within 1.0% of Potassium Chloride reference solutions. The concentrations of the reference solutions are calculated from data in the International Critical Tables, Vol. 6.

RECOMMENDED STANDARD SOLUTIONS

MODEL/RANGE	SOLUTION NUMBER
EP	
x.1	None available
x 1	None available
x 10	442-30
x 100	442-300
x 1000	442-3000
with RE-10	442-30,000

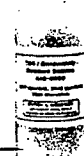

EP-10

x 1	None available
x 10	KCl-70
x 100	KCl-700
x 1000	KCl-7000
with RE-10	442-30,000

STANDARD SOLUTION EQUIVALENT VALUES

Solution Number	Micromhos Microsiemens	PPM/NaCl	PPM/442*
442-30	46.7	21.8	30
442-300	447	215	300
442-3000	3920	2040	3000
KCL-70	70	32.8	45
KCL-700	700	340	477
KCL-7000	7000	3736	5709
442-30,000	30,118	18,216	30,000

*Myron L Company proprietary Natural Water Standard

RANGE EXTENDER

The RE-10 Range Extender is a useful accessory for testing high conductivity solutions beyond the normal range of your EP meter. Inserting the RE-10 into a sample-filled cell cup increases the maximum range ten times. Use the Range Extender whenever the reading is off the scale.

USING THE RE-10

1. Fill the cell cup three times to rinse it, but each time insert the Range Extender to rinse it also.
2. Fill the cell cup with your sample. Push the Range Extender into the cell cup, seating the O-ring seal.
3. Use and read the meter in the normal manner. Multiply the reading by 10.
4. For best accuracy, repeat the complete test with a fresh sample.
5. When you're done testing, remove the Range Extender. Thoroughly rinse the cell cup and Extender with clean water (preferably distilled or deionized) to eliminate dried salts build-up. This is extremely important when the Instrument will be used to test high purity water.

RE-10 RANGE EXTENDER

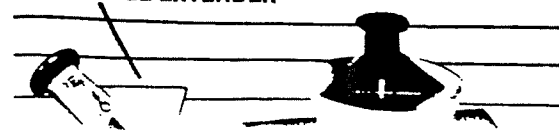

To replace the batteries detach the battery compartment. Pull on the vinyl straps to remove the batteries. Replace with fresh zinc carbon or alkaline 9 volt batteries. Reinsert the vinyl straps to secure batteries.

CELL CUP

Self-conditioning of the built-in electrodes occurs each time the button is pressed with a sample in the cell cup. This ensures consistent results each time. With some samples a small downward swing of the pointer is a result of this conditioning action. This action is powerful and removes normal films of oil and dirt. However, if very dirty samples - particularly scaling types - are allowed to dry in the cell cup, a film will build up. This film reduces accuracy. When there are visible films of oil, dirt, or scale in the cell cup or on the electrodes, scrub them lightly with a small brush and household cleanser. Rinse out the cleanser and the meter is ready for accurate measurements.

WATER INSIDE THE METER

Your Myron L EP meter is a rugged instrument and will withstand water exposure around its cell, meter movement, and switches. However, care should be taken to keep water from leaking in around the bottom cover. It is not sealed (to prevent condensation from forming).

If the water is relatively clean (i.e., tap water or better), and there are only a few drops inside the meter, dry it as described below. Large amounts of water, or corrosive or very dirty solutions will almost certainly damage the meter movement or electronics. Such meters should be returned to the Myron L Company for repair.

To dry your meter:

1. Shake excess water out of the inside of the meter.
2. Dab the exposed surfaces dry with an absorbent cloth or tissue. Avoid pushing any water into the Calibration Control or switches.
3. Air dry the meter in a warm area with the bottom cover off. Allow several hours for thorough drying.

If the water entered through a leak in the case or cell, or if the instrument shows erratic readings or other unusual behavior, return it to the Myron L Company for servicing.

WARRANTY/SERVICE

Myron L EP and EP10 Meters have a limited one year warranty. If your instrument fails to operate properly, check the batteries and calibration. If it still fails to function properly, return it prepaid to the Myron L Company.

Faulty instruments may be returned to us without prior permission.

METERS WITHIN ONE YEAR WARRANTY PERIOD:

Failures due to materials or workmanship will be repaired or replaced (our option) without charge if returned freight prepaid. If failure is deemed by the factory to have been caused by abuse or tampering, the following procedure will apply.

INSTRUMENTS/CONTROLS OUT OF WARRANTY:

Diagnosis will be made and repairs completed, providing the repair charges are \$85.00 or less.

NOTE: Actual repair charges may be less than this amount. We will diagnose (but not repair) a returned meter and mail an estimate of charges if ANY of the following apply:

1. Repair charges will be more than \$85.00.
2. You specifically request an estimate of required repairs and charges.
3. The cost of required repairs exceeds one-half the list price of a new instrument.
4. The instrument is over ten years old. Because of component changes and improvements, such instruments can no longer be repaired.

NOTE: Unrepaired meters are discarded unless you want them returned to you. If so, there is currently a \$20.00 charge per unrepaired instrument to cover diagnosis and handling.

This warranty is limited to the repair or replacement of the Myron L EP or EP10 Meter only. The Myron L Company assumes no other responsibility or liability.

**MYRON L
COMPANY**

*pH/Conductivity Instrumentation:
Accuracy — Reliability — Simplicity*

RE-10 RANGE EXTENDER

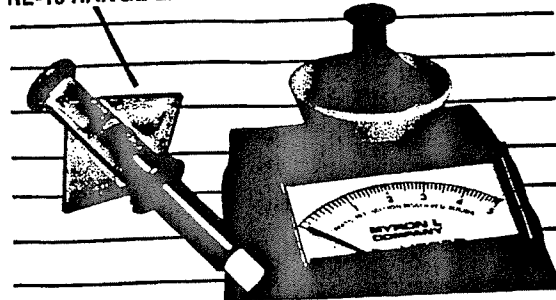

CALIBRATING THE RE-10

1. Calibrate your meter (without RE-10) using Standard Solution number 442-3000 (EP) or KCL-7000 (EP10).
2. Fill the cell cup with 442-30,000 high conductivity Standard Solution.
3. Insert RE-10 and press the button. Multiply the reading by 10 and compare it with the value on the Standard Solution label. If they are not the same the RE-10 must be recalibrated.

NOTE: DO NOT adjust the Calibration Control in your meter.

4. Adjust the white insert of the Extender as follows:
If the reading is too high — push or tap inward.
If the reading is too low — twist or pull outward with pliers.

NOTE: Each Range Extender is calibrated to a particular meter. It should be recalibrated if it is to be used with another Myron L meter.

PORTA PAK

Carrying Case for use with all Myron L portable meters is foamed and molded of sturdy ABS plastic.



ORDERING

To order accessories or instruments contact your nearest stocking distributor, or the Myron L Company.

IF YOU ALSO TEST pH

Our reliable Model EP11/pH pDS meter may be ideal for your application.

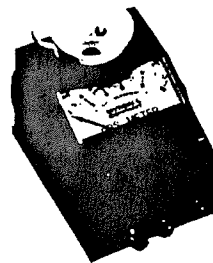

- Same four conductivity ranges as EP10 plus 2-12 pH
- pH sensor built-in for maximum protection, but is field replaceable
- Automatic temperature compensation

6115 Corte Del Cedro
Carlsbad, CA 92009-1516
TELEPHONE: (619) 418-2021
FAX 619-931-9189

HNU
FEATURES AND OPERATION

- CAN BE USED TO DETECT LEAKS OF VOLATILE SUBSTANCES IN DRUMS AND TANKS, DETERMINE THE PRESENCE OF VOLATILE COMPOUNDS IN SOIL AND WATER, MAKE AMBIENT-AIR SURVEYS AND COLLECT CONTINUOUS AIR MONITORING DATA.
- ONCE TRAINED IN ITS OPERATION INDIVIDUALS CAN HELP DECIDE WHICH LEVELS OF PROTECTION SHOULD BE WORN, AND TO DETERMINE SUBSEQUENT MONITORING LOCATIONS.
- AN HNU IS OFTEN REFERRED TO AS A PHOTO-IONIZATION DETECTOR (PID).
- PRINCIPLE OF OPERATION OR BASIS FOR DETECTION IS THE IONIZATION OF GASEOUS SPECIES WHICH IS DRAWN INTO A PROBE BY A FAN. THE INCOMING GAS MOLECULES ARE SUBJECTED TO ULTRAVIOLET (UV) RADIATION, WHICH IS ENERGETIC ENOUGH TO IONIZE MOLECULES. EACH MOLECULE IS TRANSFORMED INTO CHARGED-ION PAIRS, CREATING A CURRENT BETWEEN TWO ELECTRODES. EVERY MOLECULE HAS A CHARACTERISTIC IONIZATION POTENTIAL WHICH IS THE ENERGY REQUIRED TO REMOVE AN ELECTRON FROM THE MOLECULE, YIELDING A POSITIVELY CHARGED ION AND THE FREE ELECTRON. IT IS A CHARGED CURRENT THAT IS AMPLIFIED AND READ.
- FIVE PROBES, EACH CONTAINING A DIFFERENT UV LIGHT SOURCE ARE AVAILABLE: 8.3, 9.5, 10.2, 10.9, AND 11.7 EV.
- THE 10.2, 10.9 AND 11.7 EV PROBES ARE BETTER SUITED TO USE BECAUSE IN ADDITION TO DETECTING AROMATIC AND LARGE-MOLECULE HYDROCARBONS THEY WILL ALSO DETECT SMALLER ORGANIC MOLECULES AND SOME HALOGENATED HYDROCARBONS.

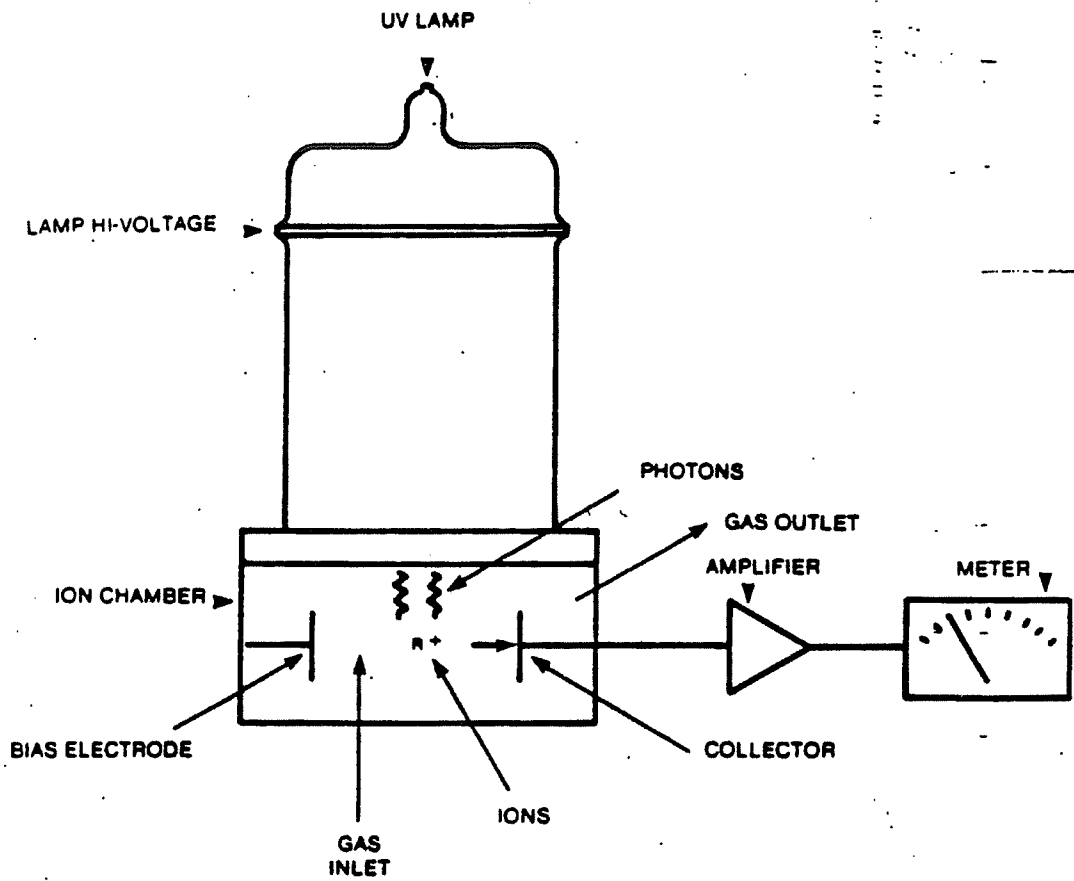

**FIGURE 4-1
DETECTION PROCESS**

- **THE 10.2 EV PROBE IS GENERALLY THE MOST USEFUL AND DURABLE PROBE FOR ENVIRONMENTAL WORK.**
- **A BACKGROUND OR ZERO READING DOES NOT NECESSARILY SIGNIFY THE ABSENCE OF AIR CONTAMINANTS.**
- **THE INSTRUMENT READINGS MAY BE HIGHER OR LOWER THAN THE TRUE CONCENTRATION. THIS IS BECAUSE THE RESPONSE OF THE INSTRUMENT TO DIFFERENT COMPOUNDS IS RELATIVE TO THE CALIBRATION GAS.**
- **ALL IDENTIFICATIONS SHOULD BE REPORTED AS TENTATIVE UNTIL THEY CAN BE CONFIRMED BY MORE PRECISE ANALYSIS.**
- **CONCENTRATIONS SHOULD BE REPORTED IN TERMS OF THE CALIBRATION GAS AND SPAN POTENTIOMETER KNOB.**
- **KEYS TO PROPER USE, MAKE SURE LAMP IS FUNCTIONING, TAKE CARE NOT TO DRAW LIQUIDS INTO PROBE.**
- **USE EXTREME CARE WHEN HANDLING GAS CYLINDERS.**
- **ALWAYS TURN THE FUNCTION SWITCH ON THE CONTROL PANEL TO THE OFF POSITION BEFORE DISASSEMBLY. OTHERWISE HIGH VOLTAGE OF 1200 V DC WILL BE PRESENT.**
- **CHARACTERISTICS INCLUDE A LINEAR RANGE OF 0.1 TO 400 PPM. THE USEFUL RANGE IS FROM 0.1 TO 2000 PPM. THE OPERATING TIME IS APPROXIMATELY 10 HOURS (REDUCED IN COLD TEMPERATURES). AMBIENT HUMIDITY UP TO 90%. RECHARGING TIME FROM A FULL DISCHARGE IS 12 TO 14 HOURS. RESPONSE TIME IS RAPID. (THE METER NEEDLE REACHES 90% OF THE INDICATED CONCENTRATION IN 3 SECONDS).**
- **WHEN RECHARGING, THE PROBE MUST BE ATTACHED.**

- **CLEAN THE 10.2 LAMP WITH A LINT FREE TISSUE DIPPED IN DETERGENT.**
- **CLEAN THE 11.7 LAMP WITH A LINT FREE TISSUE DIPPED IN FREON OR CHLORINATED SOLVENT RUBBING GENTLY.
NO WATER OR WATER MISCIBLE SOLVENTS.**
- **EASY TO USE AN INTERPRET WHEN DETECTING TOTAL CONCENTRATIONS OF KNOWN CONTAMINANTS IN AIR, BUT INTERPRETATION BECOMES MORE DIFFICULT WHEN TRYING TO IDENTIFY THE COMPONENTS OF A MIXTURE. THE METHODOLOGY USED FOR THIS INCLUDES NOTING INSTRUMENT RESPONSE TO A SOURCE WITH DIFFERENT PROBES. THIS WILL ALLOW YOU TO ELIMINATE SOME CONTAMINANTS FROM CONSIDERATION OR AT LEAST TO NARROW THE RANGE OF POSSIBILITIES.**

HNU
LIMITATIONS

- SINCE THE HNU IS A NONSPECIFIC TOTAL VAPOR DETECTOR, IT CANNOT BE USED TO IDENTIFY UNKNOWN CHEMICALS. IT CAN ONLY QUANTIATE THEM.
- IT MUST BE CALIBRATED TO A SPECIFIC COMPOUND.
- IT DOES NOT RESPOND TO ALL COMPOUNDS, SPECIFICALLY METHANE.
- FOR APPROPRIATE APPLICATION, IONIZATION POTENTIALS OF SUSPECTED CONTAMINANTS MUST BE KNOWN.
- RADIO FREQUENCY INTERFERENCE FROM PULSED DC/AC POWER LINES, TRANSFORMERS & HIGH VOLTAGE EQUIPMENT.
- LAMP WINDOW MUST BE CLEANED PERIODICALLY.
- MUST CHANGE LAMP IF LAMP IONIZATION POTENTIAL IS LESS THAN CONTAMINANT IONIZATION POTENTIAL.

SECTION 1
GENERAL INFORMATION

1.1 INTRODUCTION

This manual describes the operation, maintenance and parts list for the Trace Gas Analyzer, Model PI 101, HNU Systems Inc.

1.2 EQUIPMENT DESCRIPTION

The Trace Gas Analyzer (see Figure 1-1), is a portable instrument used to detect, measure, and provide a direct reading of the concentration of a variety of trace gases in many industrial or plant atmospheres. The analyzer employs the principle of photoionization. This process involves the absorption of ultra-violet light (a photon) by a gas molecule leading to ionization:



in which

RH = Trace gas

hv = Photon with an energy level equal to or greater than the ionization potential of RH.

The sensor consists of a sealed ultraviolet (UV) light source that emits photons with an energy level high enough to ionize many trace species, particularly organics, but not high enough to ionize the major components of air, O₂, N₂, CO, CO₂ or H₂O.

A chamber exposed to the light source contains a pair of electrodes, one a bias electrode and the second a collector electrode. When a positive potential is applied to the bias electrode a field is created in the chamber. Ions formed by the absorption of photons are driven to the collector electrode. The current produced is then measured and the corresponding concentration displayed on a meter directly in parts per million (ppm).

To minimize absorption or decomposition of sample gases, a rapid flow of sample gas is maintained thru the ion chamber, which is small, made of inert material and located at the sampling point.

The analyzer consists of a probe, a readout assembly, and a battery charger. The probe contains the sensing and amplifying circuitry; the readout assembly contains the meter, controls, power supply and rechargeable battery. The analyzer will operate from the battery for more than 10 hours or continuously when connected to the battery charger.

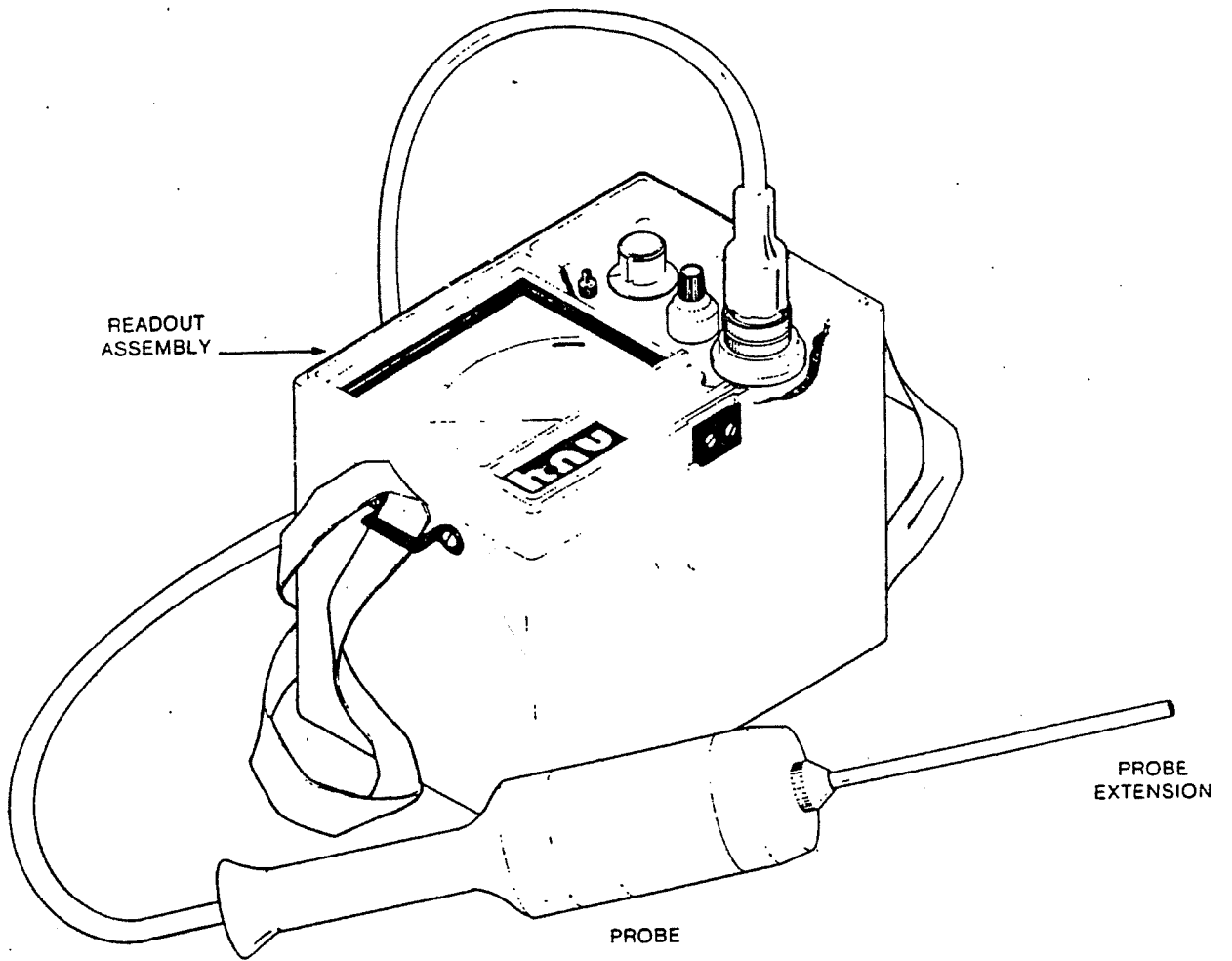

**FIGURE 1-1
TRACE GAS ANALYZER
OPERATING CONDITION**

SECTION 1.2, EQUIPMENT DESCRIPTION cont.

The PI 101 is designed for use with interchangeable probes with lamps of different energies. The analyzer is ready for use simply by connecting the probe to the readout assembly, setting the proper SPAN pot value, and then zeroing the unit. Specific data is given in the calibration memo accompanying each probe.

The standard probe uses a 10.2 eV lamp. Two optional probes use 9.5 and 11.7 eV lamps. Lamps of different eV ratings, ion chamber and amplifiers are not interchangeable between probes.

Many applications make use of the principle that some compounds respond to the more energetic lamps and not to others. Figure 1-2 shows the responses for the analyzer with each of the three lamps. Literature explaining several such applications is available from HNU Systems Inc.

An optional audible alarm is available giving an 85 decibel signal when a set concentration is exceeded. The alarm setting is variable and can be set from 0 to 100% of full scale of the meter reading. Power for the alarm is provided by the battery and does not significantly affect the rated use time of the analyzer. The alarm is non-latching and is set by a screw adjustment, preventing inadvertent changes.

When in the stored condition, the probe is contained in the instrument cover (see Figure 1-3) which attaches to the readout assembly to form a single unit (see Figure 1-4).

An optional recorder is available that can be directly attached to the readout assembly. It uses impact paper with a 2" wide chart and a speed of 2"/hour. The recorder is powered by the instrument battery and provides hard copy of the data. The analyzer will operate for approximately 4 hours with the recorder attached. Mounting information and illustration is given in Section 8.

Specification data on the analyzer is given in Table 1-1. Physical characteristics of the equipment are given in Table 1-2.

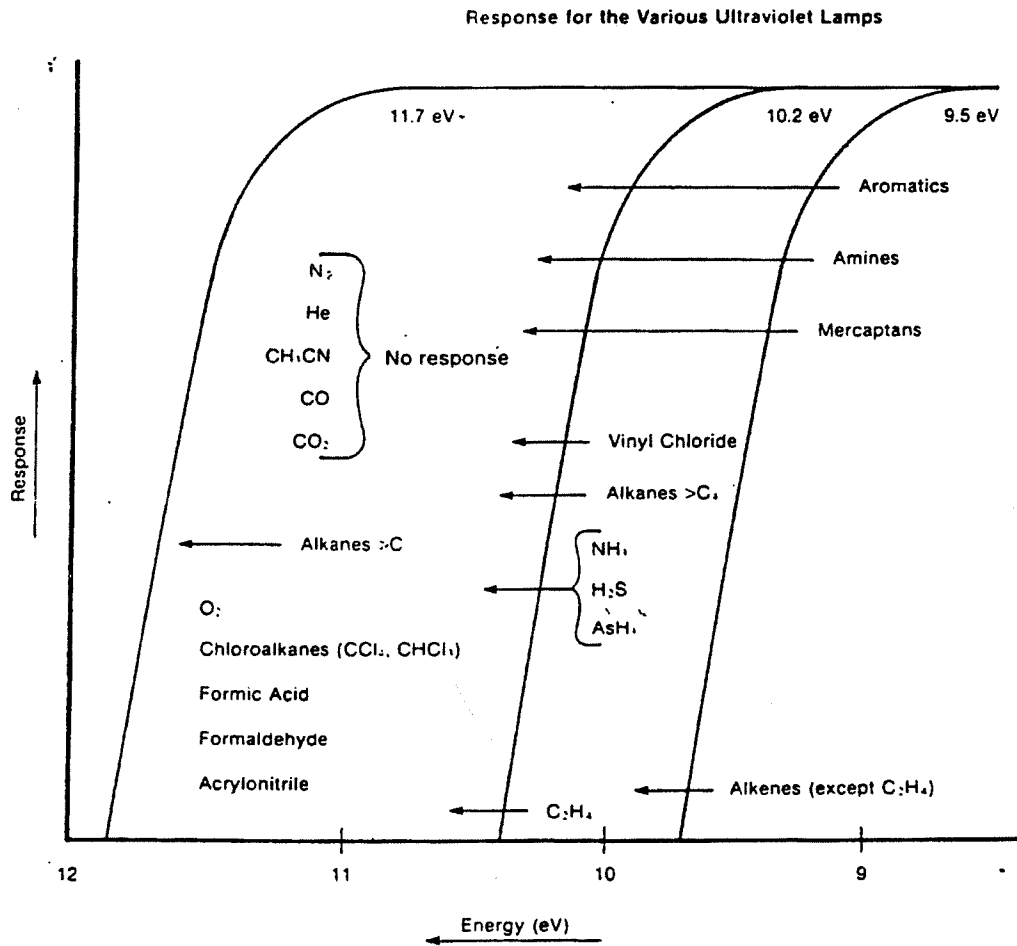

**FIGURE 1-2
RESPONSE TO VARIOUS COMPOUNDS
FOR EACH ULTRAVIOLET LAMP**

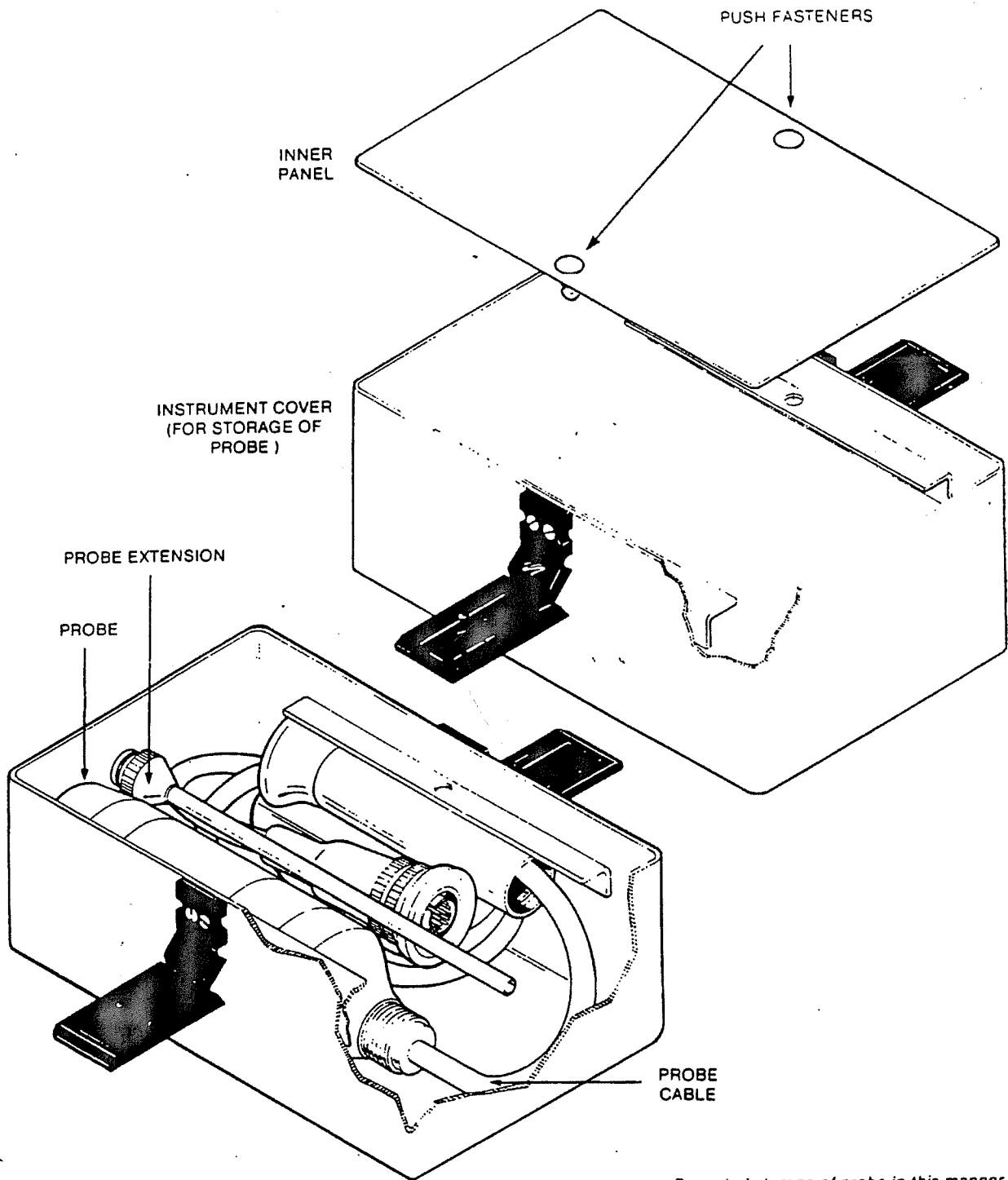

Repeated storage of probe in this manner is not recommended due to cable wear. Instrument cover may also be used for storing battery charger.

**FIGURE 1-3
PROBE STORAGE
INSTRUMENT COVER**

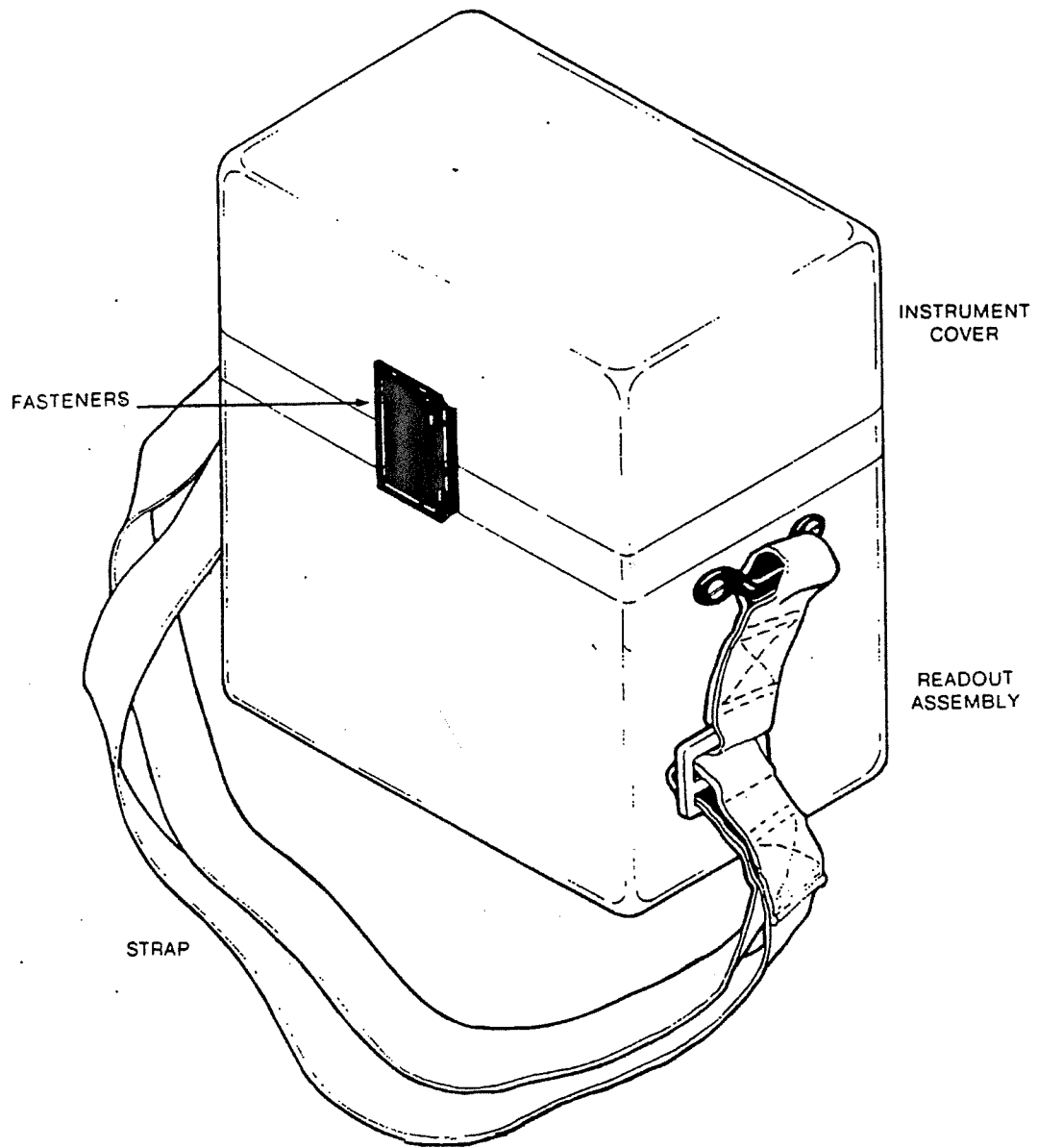

FIGURE 1-4
TRACE GAS ANALYZER
STORED CONDITION

TABLE 1-1
SPECIFICATION DATA

a. DESIGN FEATURES

Range settings	0 to 20, 200, 2000 ppm (other ranges available on request)
Lamp rating	10.2 eV standard, 9.5 or 11.7 eV optional
Audible alarm, low or high limit (optional)	85 db at 3'

b. CHARACTERISTICS (see NOTE)

Detection Range *	0.1 to 2000 ppm (parts per million by volume)
Minimum Detection Level *	0.1 ppm
Maximum Sensitivity *	0 to 20 ppm FSD at SPAN = 9.8 (full scale deflection) 0 to 2 ppm FSD at SPAN = 0.0
Repeatability *	+/- 1% of FSD
Linear Range *	0.1 to 400 ppm
Useful Range *	0.1 to 2000 ppm
Response Time	Less than 5 seconds to 90% of FSD
Ambient Humidity	up to 90% RH (relative humidity)
Operating Temperature, Ambient	-10 to 40 degrees C.
Operating Time on Battery, continuous use, without HNU recorder	Approximately 10 hours; at lower temperatures time is reduced due to effect of cold temperature on battery.
with HNU recorder (optional)	Approximately one half of normal time

TABLE 1-1 cont.

Recharge time from full discharge	Full recharge - 12 to 14 hours
Recharge current	Max 0.4 amps at 15 V DC
Battery Charger Power	120 V AC, single phase, 50-60 cycle, 1.5 Amps

NOTE: * When equipped with 10.2 eV Probe with SPAN set at 9.8 and measuring benzene. Values will vary for other compounds and conditions.

TABLE 1-2
EQUIPMENT SIZE & WEIGHT

Quantity	Name	Overall dimensions cm (inches)	Weight, kg (lbs.)	Volume, cm ³ (cu. ft.)
1	Trace Gas Analyzer (stored condition)	21W x 13D x 24H (8 1/4 x 5 3/16 x 9 1/2)	3.8 (8.2)	6552 (0.23)
	Probe Assembly	6.3 Diam x 28.5L (2 1/2 x 11 1/4)	0.55 (1.2)	564 (0.02)
	Readout Assembly	21W x 13D x 16.5H (8 1/4 x 5 3/16 x 6 1/2)	3.2 (7.0)	4504 (0.16)
1	Battery Charger with cord	10W x 12.7D x 9L (4 x 5 x 3 1/2)	0.4 (0.9)	1143 (0.04)

SECTION 2

OPERATION

2.1 INTRODUCTION/UNPACKING

Unpack the instrument carefully. The carton will contain the housing, straps, battery charger, additional probes, regulator and cylinder if ordered, spare parts, supplies and a manual. Be sure all items are removed before discarding the carton.

Attached to the instrument is a warranty card which should be filled out completely and returned to HNU Systems.

2.2 CONTROLS AND INDICATORS

The controls and indicators are located on the front panel of the readout assembly (see Figure 2-1) and are listed and described in Tables 2-1 and 2-2.

2.3 OPERATING PROCEDURES

The following procedures are to be used in operating the analyzer:

- a. Unclamp the cover from the main readout assembly.
- b. Remove the inner lid from the cover by pulling out the two fasteners.
- c. Remove the probe, handle and cable from the cover. Attach the handle to the front part of the probe.
- d. Connect the probe cable plug to the 12 pin keyed socket on the readout assembly panel. Carefully match the alignment slot in the plug to the key in the connector. Screw down the probe connector until a distinct snap and lock is felt.
- e. Screw the probe extension into the probe end cap. The probe may be used without the extension if desired.
- f. Set the SPAN control for the probe being used (10.2, 9.5, or 11.7 eV) as specified by the initial factory calibration or by subsequent calibrations.

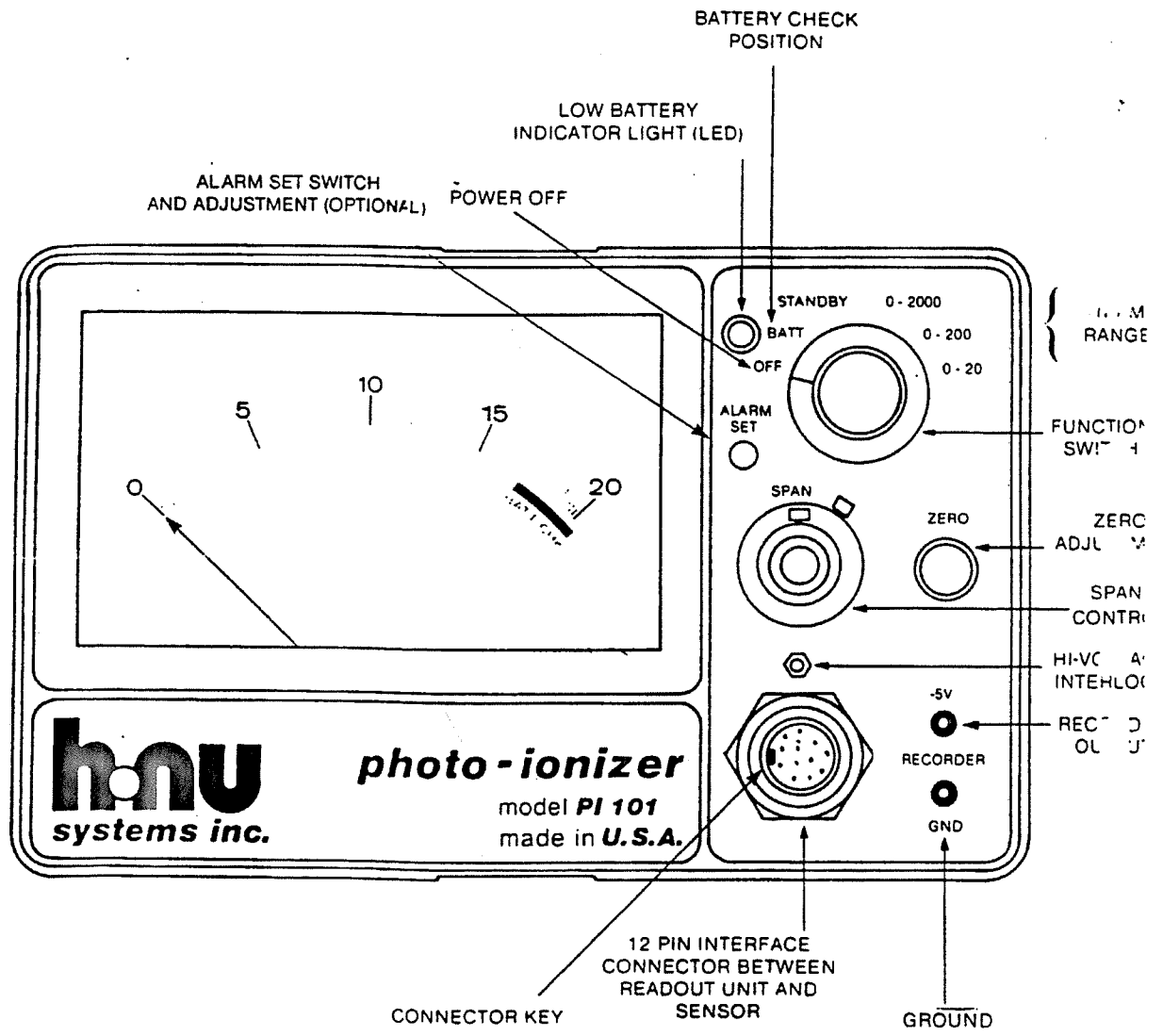

FIGURE 2-1
CONTROLS AND INDICATORS

TABLE 2-1

CONTROLS

Name	Position	Function
Function Switch	---	Controls the operation of the analyzer
	OFF	All operations OFF
	BATT (battery check)	Checks the condition of the battery. If the meter needle is in the green arc, the battery is charged. If not the battery should be recharged. Charging can be done in any position, best in OFF; see directions on charger.
	STANDBY	All electronics ON, ultraviolet (UV) light source OFF. This position conserves power and extends battery life. This position is used to set the analyzer zero position. (i.e. no UV light, no signal)
	0-2000	Sets range of meter at 0-2000 ppm.
	0-200	Sets range of meter at 0-200 ppm.
	0-20	Sets range of meter at 0-20 ppm.
ZERO	---	With the function switch in STANDBY position, this potentiometer is used to adjust the reading to zero.

NOTE: See Figure 2-1 for locations.

TABLE 2-1 cont.

SPAN	---	This vernier potentiometer is used to set the gain of the amplifier to give direct readings of the trace gas concentrations in ppm. The whole number of the setting appears in the window of the control, decimal appears on the dial. A lock secures it at a specific setting.
HI-VOLTAGE	---	This is a normally open microswitch.
	Open	Switch is open when cable not connected, disconnecting high voltage for the UV lamp from the 12 pin connector as a safety precaution.
	Closed	Switch is automatically closed when the cable is attached. This switch may also be closed manually during maintenance checks of the readout assembly without the probe cable attached.
ALARM SET (optional)	---	Potentiometer with screw-driver adjustment. Turns the audible alarm ON or OFF and sets the ppm level at which the alarm sounds. If alarm is low limit, it sounds when measured ppm falls below this value. If alarm is high limit it sounds when measured ppm exceeds this value.

NOTE: See Figure 2-1 for locations.

TABLE 2-2
INDICATORS AND DISPLAYS

Name	Function
Low Battery Indicator Light (red light) (see NOTE)	<p>Illuminates when battery is discharged, indicates need for recharge.</p> <p>Do not use unit when this light is ON.</p> <p>Readings may be taken while battery is being recharged.</p>
Meter (see NOTE)	Indicates concentration of measured gas.
Recorder (optional) (see Figures 2-1 And 8-3)	<p>Provides a record of readings while analyzer operates unattended.</p> <p>Recorder inputs 0 to -5 V DC.</p>

NOTE: See Figure 2-1 for locations.

SECTION 2.3, OPERATING PROCEDURES cont.

- g. Turn the function switch to the BATT (battery check) position. The needle on the meter will go to the green zone if the battery is fully charged. If the needle is below the green arc or if the Low Battery Indicator comes on, the battery must be recharged before the analyzer is used.
 - h. Set SPAN pot to the desired value based on the gas to be used.
 - i. Turn the function switch to the STANDBY position. Turn the zero adjustment until the meter needle is at zero.
 - j. Calibrate the instrument daily as described in Section 3. Calibration on the selected operating range is desirable.
 - k. If equipped with optional alarm, set or check the alarm setting at the level desired. Turn the function switch to the desired range, turn the zero adjustment control so the meter needle moves upscale thru the desired value. This simulates real conditions. Observe the reading when the alarm sounds. Adjust the ALARM SET, if required, with a screw driver. Turn the function switch to the STANDBY position and reset the zero position (para. h. above). If the range is to be changed, the alarm must be reset on that range.
 - l. To operate with optional recorder, add the recorder bracket (see Figure 8-3). Remove the plug in the analyzer case and insert power cord into the recorder. Then connect the signal leads to the appropriate jacks in the control module. The recorder is now operational.
- NOTE: Ranges must be marked on the chart as the recorder prints the meter display as % of Full Scale.
- m. Turn the function switch to the appropriate operating position. Start with the 0-2000 position and then switch to the more sensitive ranges. The UV light source should be on, confirmed by briefly looking into the probe to observe a purple glow from the lamp.

WARNING

Do not look at the light source closer than 6 inches with unprotected eyes. Observe only if necessary, then only briefly. Continued exposure to ultraviolet energy generated by the light source can be harmful to eyesight.

SECTION 2.3, OPERATING PROCEDURES cont.

- n. The analyzer is now operational.
- o. Hold the probe so that the extension is at the point where the measurement is to be made. The instrument measures the concentration by drawing the gas in at the end of the extension, through the ionization chamber, and out the handle end of the probe.

WARNING

The instrument measures gases in the vicinity of the operator and a high reading when measuring toxic or explosive gases should be cause for action for operator safety.

- p. Take the reading or readings as desired taking into account that air currents or drafts in the vicinity of the probe tip may cause fluctuations in readings. Change the ranges as required.
- q. Check battery condition as required. If the Low Battery Indicator comes on, turn analyzer off and recharge.

CAUTION

Use only in an emergency with a low battery when on battery charge.

SECTION 2.3, OPERATING PROCEDURES cont.

- r. After completion of use, check battery condition as described in para. g.
- s. Turn function switch to OFF position.
- t. When not operating, leave analyzer in assembled condition, and connected to battery charger.
- u. When transporting, disassemble probe and extension from readout assembly and return equipment to its stored condition.
- v. In case of emergency, turn function switch to OFF position.

2.4 BATTERY CHARGE

Check the battery charge as described in paragraph 2-3 g during each period of operation, at least once daily. If the battery is low as indicated by the meter reading or the warning indicator, it is necessary to recharge the battery.

To charge the battery, first insert the mini phone plug of the charger into the jack, J6, on the side of the bezel adjacent to the meter. Then insert the charger plug into a 120 or 230 V AC single phase, 50-60 cycle outlet. To ensure that the charger is functioning, turn the function switch, S1, to the battery check (BATT) position. The meter should deflect full scale if the charger is working and connections properly made. For normal battery charging, leave the function switch in the OFF position.

The analyzer can be operated, however, while recharging by turning the function switch to the desired position. Such usage will extend the time required to completely recharge the battery. The battery charger is not Div. II approved.

NOTE: On all Sira approved PI 101s it is necessary to connect the probe assembly before turning on the instrument and re-charging. Without following this procedure the instrument will not show battery check.

5600 SERIES BLADDER PUMPS

DESIGN SPECIFICATIONS

MODEL	MATERIAL	O.D. (in./mm.)	LENGTH (in./cm.)	WEIGHT (lbs./kg.)	CAPACITY (ml.)	LIFT (ft./m.)
5605	S.S./Teflon	1.38/35	43/109	5.0/2.3	400	400/121
5609	S.S./Teflon	1.38/35	30/76	3.5/1.6	225	400/121
5615	S.S./Teflon	1.66/42	43/109	6.8/3.1	550	400/121
5625	PVC/Teflon	1.66/42	43/109	3.2/1.5	400	400/121
5627	PVC/Teflon	1.66/42	78/198	6.0/2.7	800	400/121
5635	PVC/Teflon	1.90/48	43/109	3.7/1.7	550	400/121
5637	PVC/Teflon	1.90/48	78/198	7.0/3.2	1100	400/121
5645	Teflon	1.75/45	43/109	5.2/2.4	400	400/121

SUPPORT EQUIPMENT OPTIONS

- Models 5001 (electric), 5940 (pneumatic), or 55000 (electronic) Controllers.
- Models 5404 Oil-less Compressor, 5401 (compressor on 20" wheeled cart), or 5420 (compressor with 16" pneumatic wheels).

BONDED, TWIN TUBING OPTIONS

MODEL	MATERIAL	AIR TUBE I.D. x O.D.	WATER TUBE I.D. x O.D.
5916	Pure Teflon	.250 x .375	.375 x .500
5896	Polyethylene	.250 x .375	.375 x .500
5897	Teflon lined PE	.250 x .375	.375 x .500

ENGINEERING SPECIFICATIONS

- | | |
|---|---|
| <ol style="list-style-type: none"> 1. The pump shall be a positive displacement bladder squeeze pump, where drive air does not contact the sample. 2. The pump shall permit water to enter the interior of the bladder through a bottom check valve and permit air to enter the annulus between the pump body and bladder through an upper air inlet/outlet. 3. The pump shall not fill by suction assist, or place a negative pressure on the sample. 4. All internal pump components shall be virgin Teflon®. 5. The pump shall incorporate a field replaceable, factory sealed and tested, Teflon bladder cartridge. 6. The pump shall withstand continuous operation at | <p style="margin-left: 40px;">200 psi (14 bars) without modification.</p> <ol style="list-style-type: none"> 7. The pump shall be capable of dry pumping without damage. 8. The pump shall have minimum .375 water discharge porting, without restrictions, to eliminate dissolved gas loss due to orifice effects during sampling. 9. The pump shall have a threaded intake (3/4" female pipe thread) to permit use of a drop tube extension, booster pumps, and factory equipped, Type 316 Stainless Steel, .010" intake screen. 10. The pump shall be convertible to a bailer or gas drive pump. |
|---|---|

Note: Teflon is a registered trademark of E.I. duPont.

GEUGUARD
Dedicated To Ground Water Technology

536 ORIENT STREET ● P.O. BOX 149 ● MEDINA, NEW YORK 14103-0149 ● 1-800-645-7654

MASTER-FLAD

Ground Water Sampling Systems

SAMPLING CADDY

The GEOGUARD Sampling Caddy provides a completely portable ground water sampling system. The unit is easily handled by one person and disassembles for easy transport.

Oil-less Compressor Assembly

Lift, flow rate reliability of a ground water sampling system require a dependable, practically designed portable compressed air source. GEOGUARD compressors are capable of producing lifts of up to 250 feet and displace sufficient air provide the highest pumping rates in the industry, while providing instrument grade air that contains no hydrocarbon in the air stream.

GEOGUARD compressors have earned the reputation as rugged, low maintenance, high performing portable compressed air sources for pneumatic pumping systems.

- Choice of either Briggs & Stratton or Honda engines.
- Rugged, dual-piston compressor head with Teflon® piston rings and stainless steel valves providing years of dependable service.
- Oil-less compressor unit never requires lubrication and does not deliver oil mist in the air stream.
- Vibration dampened design
- OSHA approved belt guard.
- 125 psi continuous operation.

Cart Frame

The rugged tubular aluminum cart frame includes an equipment rack for carrying the controller, with enough room left for incidentals. It also includes a pump carrying container for storing the pump from well to well.

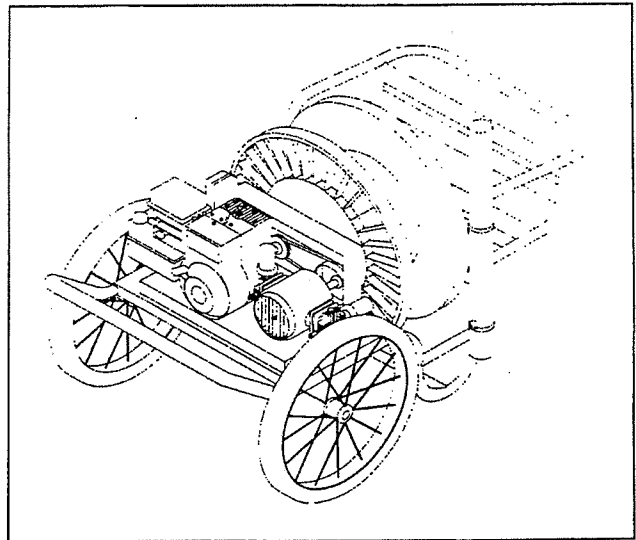

Tubing Reel

The tubing reel will hold up to 200 feet of coaxial or twin tubing. Its structural foam construction provides durability. Reel can be locked in place utilizing integral "spool lock".

20-inch Spoked Wheels

The wheels easily detach from the cart frame for easy vehicular transport. The 20-inch diameter is useful when traversing through rough terrain.

For applications assistance call 1-800-645-7654 .

SAMPLING CADDY

DESIGN SPECIFICATIONS

MODEL #	5401
WEIGHT :	100 lbs/4.45 kg
LENGTH:	48 in/122 cm
WIDTH:	24 in/61 cm
HEIGHT:	29 in/73.7 cm
MAXIMUM PRESSURE:	125 psi
DUTY:	CONTINUOUS
DISPLACEMENT:	4.3 SCFM
POWER SOURCE:	3.5 h.p. Briggs & Stratton I/C gasoline engine
TIRES:	20" Semi-Pneumatic

DESIGN SPECIFICATIONS

MODEL #	5401-H
WEIGHT :	100 lbs/4.45 kg
LENGTH:	48 in/122 cm
WIDTH:	24 in/61 cm
HEIGHT:	29 in/73.7 cm
MAXIMUM PRESSURE:	125 psi
DUTY:	CONTINUOUS
DISPLACEMENT:	4.3 SCFM
POWER SOURCE:	4 h.p. Honda I/C gasoline engine
TIRES:	20" Semi-Pneumatic

ENGINEERING SPECIFICATIONS

- 1) The compressor assembly shall be a completely self-contained portable package.
- 2) The compressor assembly shall be mounted on a tubular aluminum frame cart with detachable 20-inch wheels, tubing spool and equipment rack.
- 3) The compressor assembly shall incorporate an industrial oil-less 125 psi compressor (ie. instrument grade air.)
- 4) The compressor assembly shall be capable of operating continuously at 125 psi.
- 5) The compressor assembly shall be capable of delivering 4.3 SCFM at 125 psi.
- 6) The compressor assembly shall incorporate an OSHA approved belt guard.
- 7) Select one of the following:
 - a) The compressor assembly shall incorporate a Briggs & Stratton Industrial/Commercial, 3.5 h.p. gasoline engine (Model 5401).
 - b) The compressor assembly shall incorporate a Honda Industrial/Commercial, 4 h.p. gasoline engine (Model 5401-H).

Teflon is a registered trademark of E.I. duPont.

GEUGUARD
Dedicated To Ground Water Technology

536 ORIENT STREET • P.O. BOX 149 • MEDINA, NEW YORK 14103-0149 • 1-800-645-7654

MASTER-FLAD

Ground Water Sampling Systems

FULLY PNEUMATIC AUTOMATIC PUMP CYCLE CONTROLLER

GEOGUARD Pump Cycle Controllers manage the compressed air used to power pneumatic pumps. They are designed with large air paths so as not to restrict the air flow as it moves from the compressed air source to the pump.

- Fine tuning, single rotation timer adjustment provides optimum pump flow rate.
- Sensitive air flow control permits high purging rates and low (less than 100ml/min.) sample rates.
- 200 psi pressure capability allows lifts up to 450 feet (135 m).
- Quick exhaust valve "short circuits" exhausting air, permits the pump to fill faster for higher purging flow rates.
- Non-corroding, quick-connect hose attachments.
- Over pressure protection.
- Liquid dampened pressure gauge.
- Manual override bypasses the timers for manual operation (used for "cold weather blow outs", packer inflation, etc.).
- Moisture trap/air filter prevents water and particulate matter from entering controller, tubing and pump.
- Enclosed in a rugged, environmentally sealed, shock resistant case.
- Doubling acting feature permits operation of two pumps. (Note: Requires additional air hose from controller to pump. Part number 50090.)

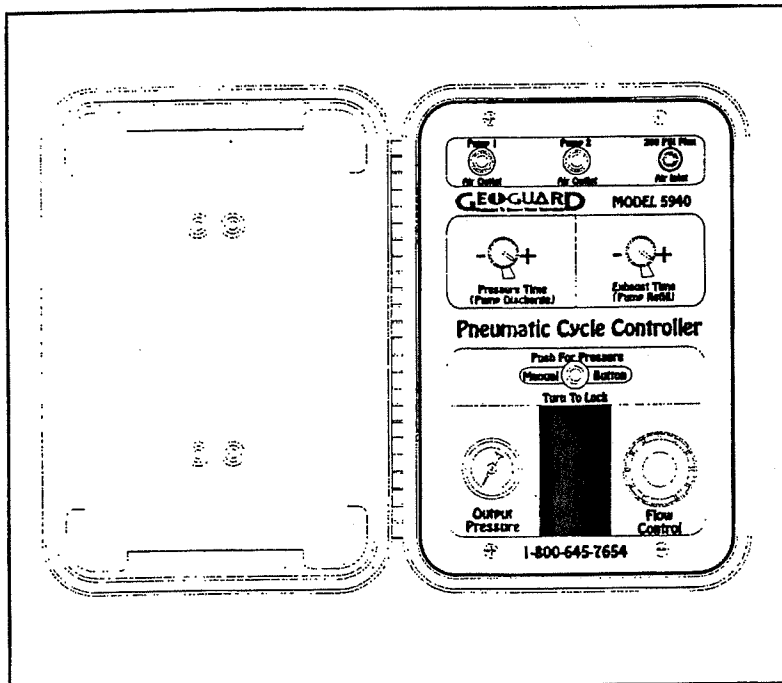

Design Specifications

Model#: 5940

Weight: 10 lbs.

Dimensions: 14.5" L x 10" D x 9" W

Timer Range: Fill = 1 to 180 seconds. Discharge = 1 to 60 seconds. Independently adjustable.

Pressure Capability: 200 psi.

Power Source: Compressed air.

Air Hose: .375" I.D. reinforced, industrial air hose. Compressed air source to controller hose length is 25 ft. and includes quick-connect fittings. Controller to pump hose length is 10 ft. and includes quick-exhaust valve and quick-connect fittings. (Optional lengths available upon request).

For applications assistance call 1-800-645-7654.

FULLY PNEUMATIC AUTOMATIC PUMP CYCLE CONTROLLER

ENGINEERING SPECIFICATIONS

1. The Model 5940 Controller shall be housed in a gasketed case with a continuous hinged top.
2. The controller shall be fully pneumatic, powered only by compressed air.
3. The controller shall be equipped with a flow rate control capable of reducing the pump flow to less than 100 ml/min. throughout the entire lift range.
4. The controller shall incorporate a panel mounted, liquid dampened pressure gauge.
5. The controller shall incorporate separate fill and discharge timers that are independently adjustable.
6. The controller shall be capable of operating either one or two pumps. Two pump operation shall be accomplished by alternately pressurizing and venting each pump independently, from the controller panel, without the use of a manifold.
7. The controller shall be supplied with: 25 feet of 3/8" I.D., reinforced, industrial air hose with quick-connect fittings for use between the compressed air source and controller; and 10 feet of identical air hose with quick exhaust valve and quick-connect fittings for use between controller and pump tubing.
8. The controller shall be capable of cycling up to 200 psi (14 bars) without modification.
9. The controller shall be equipped with a pressure relief valve to serve as over pressure protection.
10. The controller shall be equipped with a mechanical manual override that bypasses the timers and provides for manual cycling of the compressed air.
11. The controller shall be equipped with a detachable external water trap/air filter.

GEUGUARD
Dedicated To Ground Water Technology

536 ORIENT STREET • P.O. BOX 149 • MEDINA, NEW YORK 14103 • 1-800-645-7654

Water Level Indicator

For measuring water levels in standpipes and wells

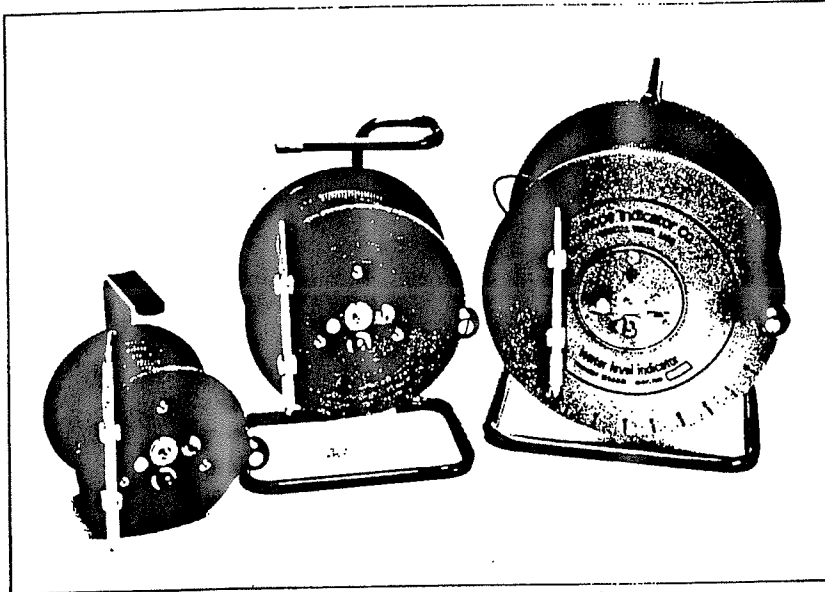

Water Level Indicators are available in three reel sizes to accommodate cable lengths from 50 to 1000 feet.

3/8" stainless steel probe fits easily in small diameter pipes. An eyelet in the tip of the probe allows easy attachment of weights. The probe clips to the cable reel for storage.

Light and buzzer make the water level indicator easy to use in low light or at noisy sites.

Sensitivity adjustment eliminates false triggering and guarantees consistent results, even in water with low conductivity.

Long battery life. The indicator uses power only when the probe is in contact with water. A battery test button is provided.

Applications

The water level indicator measures water levels in standpipes and wells.

Operation

The probe is lowered down the well until a light and buzzer indicate contact with water. Depth markings on the cable show the water level. The sensitivity of the indicator can be adjusted for water conductivity and well conditions.

Advantages

1/100 ft. cable markings provide convenience and accuracy. Feet are numbered in yellow, tenths are numbered in white, and hundredths are white bars. Cable markings in meters are also available.

Small diameter, round cable offers superior stretch resistance and minimizes friction on casing walls. The round cable also winds up neatly and does not twist or bind.

Heavy-duty reel is constructed of 1/8" aluminum plate for years of hard use. The compact six-inch reel is supplied with a handle, and the eight and eleven inch reels are mounted on stands. All reels are equipped with heavy-duty rotating knobs.

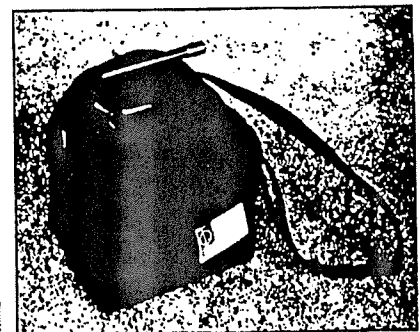

Convenient carrying case has shoulder strap.

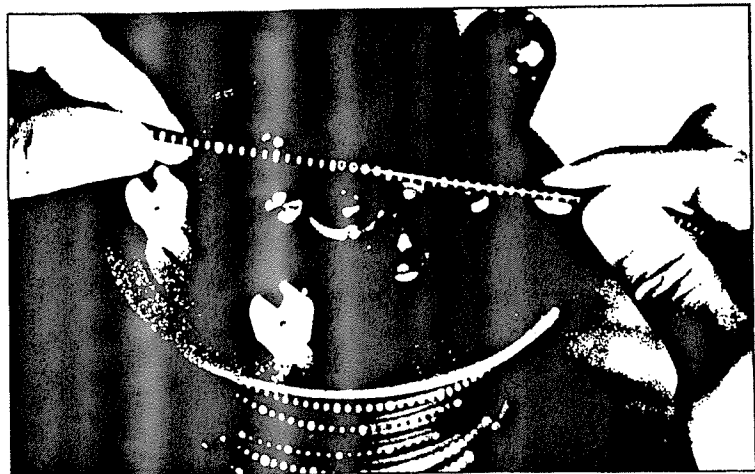

1/100 foot Cable Markings for Accurate Readings.

Piezometers and Ground Water

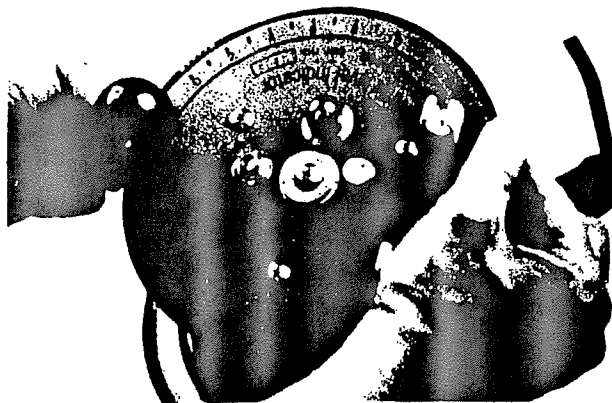

Centimeter Scale on Metric Models.

Specifications

Reels:

- Sizes:** 6", 8", or 11" diameter. (152, 203, or 279 mm).
- Reel walls:** 1/8" aluminum plate, protected by polyurethane paint.
- Core:** PVC.
- Handle:** (6" reel) Heavy gage aluminum, baked-on paint.
- Stand:** (8" and 11" reels) Steel tubing, baked-on paint.
- Rotating Knob:** Phenolic plastic.

Probe:

- Size:** 3/8" O.D. x 6.6" (9.5 x 168 mm).
- 1/4" probe is available on special order.
- Materials:** Stainless steel, polyethylene insulator.

Cable:

- Type:** 2 conductor, 1/8" polyurethane.
- English Markings:** 1/100 ft (white marks) and 1 ft (yellow marks).
- Metric Markings:** 1m only (white marks).
- Metric reel provides centimeter scale.
- Recommended Cleaner:** Laboratory grade detergent, such as Alconox or Liquinox.

Batteries:

- Three 1.5 volt alkaline AA cells.
- Battery life depends on usage.

SINCO Slope Indicator Co.

Head Office: 3648 Alhambra Pl., P.O. Box 100337, Seattle, WA 98103 9716 USA
tel: 206 633 3023 fax: 206 633 3815 us: 519 601 2939 (SINCO SEA)

Rocky Mountain Sales Office/GeoStore: 3990 Name Street, Unit L,
Denver, CO 80239 tel: 303 731 4745 fax: 303 731 3038

Northeast Sales Office/GeoStore: 25 New York Avenue, Framingham,
MA 01701 tel: 508 626 2343 fax: 508 626 1721 fax: 508 879 4674

Canada: #2401 Humberwood Road, Richmond, BC, Canada V6X 1Z5
tel: 604 276 2545, 800 663 3771 fax: 604 276 0190 **UK:** Southerham House,
Southerham, Lewes, East Sussex, UK BN8 5JF tel: 0273 474475,
fax: 0273 474479 **Australia:** 7 Bunting Street, Collesse, 6011, W.A.
tel: 61 9 385 1067 fax: 61 9 385 1179

Products and specifications are subject to change without notice. For warranty information, please request "General Information and Terms of Sale".

SINCO 70001436 1091 Printed in USA © 1991 SINCO SLOPE

Ordering Information

Water Level Indicators

Cable Length	Reel Diameter	Weight	Order #
50 ft	6"	6 lb	51670005
100 ft	6"	6 lb	51670010
100 ft	8"	6 lb	51670810
150 ft	8"	7 lb	51670815
200 ft	8"	8 lb	51670820
300 ft	8"	9 lb	51670830
500 ft	11"	13 lb	51670050
750 ft	11"	15 lb	51670075
1000 ft	11"	18 lb	51670100
30 m	152 mm	2.7 kg	51405316
60 m	203 mm	3.6 kg	51405317
90 m	203 mm	4.1 kg	51405312
150 m	279 mm	5.9 kg	51405313
225 m	279 mm	6.8 kg	51405314
300 m	279 mm	8.2 kg	51405315

Replacement Cable

50 ft	50670005
100 ft	50670010
150 ft	50670015
200 ft	50670020
300 ft	50670030
30 m	51480100
60 m	51480200
90 m	51480300

Replacement Probe 51405200

3/8" probe, cable not attached

Nylon Carrying Case for 8" Reel 51670802

Storage Box, 6" Reel 51405335

Steel, foam lined, 10 x 11.5 x 7.25"

Orion pH-mV-Temp-Concentration Meters

The **Model 230A pH/Temperature meter** is ideal for performing routine field pH measurements. Includes a built-in electrode storage sleeve and cable management. Calibration is easier and more accurate using two-step autocalibration with built-in buffer recognition, buffer/temperature tables, and automatically calculated and displayed electrode slope values.

The **Model 250A pH/mV/Temperature meter** has all the features of the Model 230A with the addition of millivolt, a selectable pH resolution and RS232 communication.

Orion's newest **Model 290A pH/Concentration Meter** is the ultimate meter for performing pH and ISE measurements. This unit performs up to 5 point pH autocalibration and choice of speed or accuracy with selectable resolution. Autoblank correction makes low level measurements easier. Record results in the field using the internal data logger, then transfer to printer or computer when you return to the lab.

The optional **0900A Printer** attaches directly to the Model 250A or 290A, creating a compact bench or easily carried configuration for a permanent record of your results. Comes with one roll of paper.

All meters come complete with 150 ml beaker, 4, 7, and 10 pH tablets (one each of solution), probe, holder and stand.

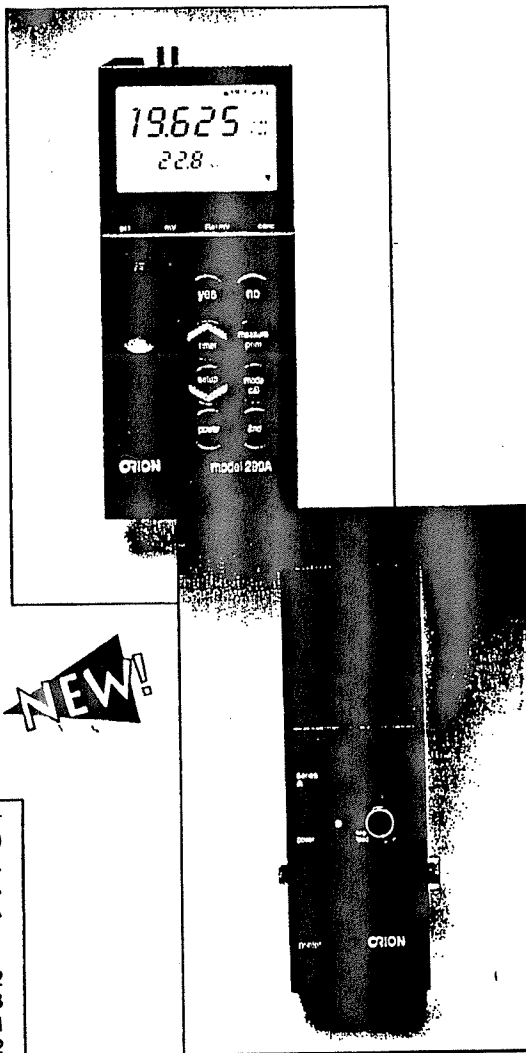

Description	Part Number
Model 230A	R-SA230
Model 250A	R-SA250A
Model 290A	R-290A
Model 0900A Printer	R-0900A

Purchased Support Accessories	
4 pH Capsules*	R-F1002
7 pH Capsules*	R-F1003
10 pH Capsules*	R-F1004
Printer Paper	R-ORI1002

* When added to distilled water (not included), each capsule makes 100 ml of solution

Specifications	Model 230A	Model 250A	Model 290A
pH Range:	-2.00 to 19.99	-2.00 to 19.99	-2.000 to 19.999
Resolution:	0.01 pH	0.01/0.1 pH	0.001, 0.01, 0.1 pH
Accuracy:	±0.02	±0.02	±0.005
Slope:	80 to 120%	80 to 120%	80 to 130%
Concentration Range:	-	-	0.000 to 19900
Resolution:	-	-	One least significant digit
Accuracy:	-	-	±0.5% of reading
Temperature:	-5.0 to 105°C	-5.0 to 105°C	5.0 to 105°C
Resolution/Accuracy:	0.1°C/±1°C	0.1°C/±1°C	0.1°C/±1°C
Millivolt Range:	-	-1600.0 to +1600.0	-1600.0 to +1600.0
Resolution/Accuracy:	-	0.1 mV/±0.2 mV	0.1 mV/±0.2 mV
Relative Millivolt Range:	-	-1999.99 to +1999.9	-1999.99 to +1999.9
Resolution/Accuracy:	-	0.1 mV/±0.2 mV	0.1 mV/±0.2 mV
Output:	-	RS232C	RS232C
Power Requirement:	One 9V battery	One 9V battery	One 9V battery



INSTRUCTION MANUAL

TURBIDIMETER

MODELS **8391-40 / 8391-45**
 8391-50 / 8391-55

Cole-Parmer Instrument Company
7425 North Oak Park Avenue, Chicago, Illinois 60648

TABLE OF CONTENTS

	PAGE
1.0 INTRODUCTION.....	1
2.0 ACCESSORIES.....	1
3.0 METER FAMILIARITY.....	2
4.0 METER SETUP.....	2
5.0 CUVETTE PREPARATION.....	3
6.0 PRIMARY AND SECONDARY STANDARDS.....	3
7.0 CALIBRATING WITH PRIMARY STANDARDS.....	3
8.0 CALIBRATING WITH SECONDARY STANDARDS.....	5
9.0 SAMPLE MEASUREMENT.....	6
10.0 MEASUREMENT GUIDELINES.....	7
11.0 LINEAR CALIBRATION CURVES.....	8
12.0 MAINTENANCE.....	8
13.0 TROUBLESHOOTING GUIDE.....	9
14.0 INSTALLING A NEW LAMP.....	10
15.0 ADJUSTING THE LAMP VOLTAGE.....	10
16.0 BATTERY INFORMATION FOR PORTABLES.....	11
17.0 THEORY OF OPERATION.....	12
18.0 SPECIFICATIONS.....	12
WARRANTY.....	BACK COVER

1.0 INTRODUCTION

This turbidimeter measures the turbidity or cloudiness, of water. Light scattering particles suspended in the water cause this cloudiness.

To measure the turbidity of a water sample, the meter is first calibrated to a known standard. Then the unknown sample is measured.

This turbidimeter detects light scattered at a 90 degree angle from the light beam, a process called nephelometry. The unit of measurement is the nephelometric turbidity unit (NTU).

2.0 ACCESSORIES

1. GLASS CUVETTE

One inch diameter glass vial for sample measurement. It is marked about one inch from the bottom of the cuvette for alignment in the test well and also for a sample level indication. Turbidity standard and samples are poured into the cuvette for measurement. The cuvette should be kept clean and free of scratches.

2. CUVETTE CAP

Placed into the top of the cuvette after a standard or sample is poured in. It prevents contamination and reduces internal reflections during sample measurements.

3. LIGHT SHIELD

Placed over the cuvette when taking measurements to prevent stray light from entering the cuvette or test well. When the turbidimeter is not in use, keep the light shield over the test well to prevent dust from accumulating at the bottom of the test well.

4. SECONDARY STANDARD

DO NOT ALLOW STANDARDS TO FREEZE!

.5 NTU and 10 NTU AEPA-1 polymer standards are sealed in glass cuvettes with silicone caps. The values marked on the cuvettes are approximate. The operator must calibrate them following the procedures in the "CALIBRATING SEALED STANDARDS" section.

5. PRIMARY STANDARD

DO NOT ALLOW STANDARDS TO FREEZE!

60ml each of .5 NTU and 10 NTU AEPA-1 polymer turbidimeter standards in plastic bottles are provided for use in calibrating the secondary standards.

6. WALL PLUG ADAPTOR

Converts 110 VAC from a wall plug outlet to 9 VDC, 500 mA for the lab or bench model turbidimeter. A 220 VAC adaptor is also available.

The portable or battery powered turbidimeter requires a 12 VDC, 500 mA adaptor.

7. CIGARETTE LIGHTER ADAPTOR

Allows operation from a standard automobile cigarette lighter outlet.

3.0 METER FAMILIARITY

1. TEST WELL

A one inch diameter well into which a sample cuvette or sealed standard is placed. A light beam shines up from the bottom of this well, and light scattered at a 90 degree angle from this beam is detected by three photodiodes placed symmetrically around the well, 1/4 inch from the bottom. The front of the test well has a notch for cuvette alignment.

2. NTU RANGE

Three position switch to select turbidity range. 0-2*, 0-20, and 0-200 NTU.

*LAB USE ONLY

3. LIQUID CRYSTAL DISPLAY (LCD)

Displays NTU readings. If there are no digits being displayed except for a one on the far left, the reading is higher than the selected NTU range.

5. SET/CAL

Used to calibrate the turbidimeter to a known standard. The 11150 is screened Set, the 11520 model is screened CAL.

6. ZERO NTU ADJUST

Used to correct for noise caused by irregularities in the glass cuvette.

7. POWER INPUT

The bench model turbidimeter requires a 9 VDC, 500mA, power supply (see accessories). The portable unit uses a 8 AA-cell rechargeable NiCd battery. This battery is recharged with a 12 VDC, 500 mA adaptor.

8. ON/OFF SWITCH

Applies power to the turbidimeter.

4.0 METER SETUP

1. Place the turbidimeter on a flat, stable surface away from vibrations and direct sunlight.

2. Push the wall plug adaptor plug into the jack on the turbidimeter and plug the wall plug adaptor into an AC outlet. When using battery power, skip this step.

3. Turn the turbidimeter on with the power switch. Allow the bench model at least five minutes warm-up time before doing any measurements. Portable turbidimeters require a one minute warm-up time.

5.0 CUVETTE PREPARATION

CLEANING

Pour at least 5 ml of sample (approx. 1/2 inch) into the cuvette. Cover with a cuvette cap. Tilt the cuvette to rinse the entire inside surface of the cuvette and cap. Pour the liquid out. Shake out remaining liquid. Repeat at least one more time.

Sample volume should be kept constant for accurate results. Fill the cuvette to the level of the alignment mark with your sample solution. Place the sample cap securely on the cuvette before cleaning the outside.

Cleaning the outside of the cuvette is critical. Use a lint free cloth and a cleaner such as alcohol that will evaporate. Avoid touching the area below the mark as fingerprints will distort the turbidity reading. Using a dry tissue alone is not adequate for removing fingerprints and oils and will cause inaccurate readings.

ALIGNMENT

All cuvettes are aligned and marked at the factory; this eliminates errors due to irregularities in the sample cuvette and standard cuvette glass. Establishing the correct alignment of each cuvette in the test well (the well has a notch to line the cuvette up with) insures consistent and accurate readings.

6.0 PRIMARY AND SECONDARY STANDARDS

DO NOT ALLOW STANDARDS TO FREEZE!

Standards are solutions with a known turbidity which are used for calibrating the turbidimeter.

Primary standards are standards which are acceptable to the Environmental Protection Agency (EPA) for calibrating turbidimeters. There are only two: 1. Formazin 2. Styrene divinylbenzene polymer beads. The same glass cuvette must be used when calibrating the turbidimeter with the primary standards and when measuring the unknown sample.

Secondary standards are defined by the EPA as Sealed Standards. Secondary Standards can be used for calibrating turbidimeters if the secondary standards are first calibrated with primary standards. The use of secondary standards can save time and money.

7.0 CALIBRATING WITH PRIMARY STANDARDS

You will need: .5 NTU and 10 NTU primary standards
.5 NTU and 10 NTU sealed standards
one sample cuvette with cap.

1. Turn on the turbidimeter. Allow the unit to warm-up (one minute for portable model and 5 minutes for the bench model).
2. Set the range switch to 0-20 NTU.

3. Prepare the cuvette with the 10 NTU primary standard.
- * Always rinse the inside with the standard being used, fill to mark, cap, and clean the outside.
4. Insert the cuvette into the test well, align the cuvette, and cover with the light shield.
5. Adjust the SET/CAL control until the display reads 10.0.
6. Remove the primary standard and replace it with the 10 NTU sealed standard. Align it and cover it with the light shield.
- * Always clean the secondary standards with alcohol before taking reading.
7. Record the NTU value of the sealed standard on the label. This value can now be used for calibration without primary standards.
8. Pour the standard out and shake remaining droplets out of the cuvette.
9. Change the range switch to 0-2 NTU.
10. Prepare the same cuvette using the 0.5 NTU primary standard. (Remember to rinse at least twice.)

IMPORTANT NOTE 1: The 0-2 NTU range is only used for calibration procedures and "LAB" testing. Under normal use remain in the 0-2 NTU range for all low level sample readings. The 0-20 NTU range gives acceptable readings well within EPA's and other regulatory agencies' 2% requirements.

11. Insert the cuvette into the test well. Align the cuvette and cover it with the light shield.
12. Adjust the ZERO NTU adjust screw so that the display reads 0.500. Make sure the reading has settled.
13. Remove the primary standard and replace it with the .5 NTU sealed standard. Align it and cover it with the light shield.

NOTE: When calibrating in the 0-2 NTU range, the 3rd digit (1/1000 place) may vary $\pm .002$ in a lab setting and $\pm .005$ outside the lab.

14. Record the NTU value of the sealed standard on the label. This value can now be used for calibration without primary standards.
15. Pour the 0.5 NTU standard out of the cuvette and shake out the remaining droplets.

NOTE: Due to a slight interaction between the 10 NTU and 0.5 NTU standard adjustments, the following steps should be taken.

16. Set the range switch to 0-20 NTU.
17. Insert the 10 NTU sealed standard, align and cover. The SET/CAL adjust may require a

slight adjustment. Set the meter to read the recorded calibrated value of the sealed standard from step 7.

18. Insert the 0.5 NTU sealed standard, align and cover. Adjust the ZERO ADJ screw as necessary to obtain the value recorded on the label.

19. Repeat steps 16-18 until no further adjustments are needed.

20. The turbidimeter is now calibrated and ready for sample measurements.

IMPORTANT NOTE 2: The above procedure should be performed every three months, every time a new sample cuvette is used or any time the sealed standard values are questionable. Repeated use of the sample cuvettes and sealed standard cuvettes will cause wear and scratches on the glass. This wear will result in a change in the assigned value of the standard. It is important to realize that a change in the assigned value does not necessarily indicate degradation or deterioration of the standard.

8.0 CALIBRATING WITH SECONDARY STANDARDS (DAILY CALIBRATION)

Once a sealed standard is calibrated to a primary standard in a sample cuvette, it becomes a secondary standard.

Before inserting the secondary (sealed) standards into the test well, clean the outside with a soft tissue or cloth and glass cleaner. Hold the cuvette by the cap and avoid touching the glass.

When not being used, the secondary standards should be stored where they will not be scratched or broken.

1. Turn on the turbidimeter and allow to warm-up, five minutes for bench model and one minute for portable units.
2. Set the range switch to 0-20 NTU. See 'IMPORTANT NOTE 1' in Section 7.0.
3. Insert the 10 NTU secondary standard into the test well and line up the alignment marks on the cuvette and test well. Note the calibrated NTU value obtained for the standard when it was calibrated to the primary standards.
 - * Always clean the cuvette with alcohol before taking a reading.
4. Cover the cuvette with the light shield and use the SET/CAL control to set the display to the calibrated NTU value of the 10 NTU secondary standard.
5. Remove the 10 NTU standard and change the range switch to 0-2 NTU.
6. Insert the 0.5 secondary standard into the test well. Line up the alignment marks on the cuvette with the test well mark.
7. Note the calibrated NTU value obtained for the .5 NTU secondary standard when it was calibrated to the primary standards.

8. Cover the cuvette with the light shield and turn the zero NTU adjust screw until the display reads the calibrated NTU value of the .5 NTU secondary standard.

9. Remove the .5 NTU standard.

10. Set the range switch to 0-20 NTU.

11. Insert the 10 NTU secondary standard, align and cover.

12. The SET/CAL adjust may require a slight adjustment. Set the meter to read the NTU value of the sealed standard.

NOTE: Due to a slight interaction between the 10 NTU and 0.5 NTU standard adjustments, the following steps should be taken.

13. Set the range switch to 0-20 NTU.

14. Insert the 10 NTU sealed standard, align and cover. The SET/CAL adjust may require a slight adjustment. Set the meter to read the calibrated value of the sealed standard recorded in step 7.

15. Insert the 0.5 NTU sealed standard, align and cover. Adjust the ZERO ADJ screw as necessary to obtain the value recorded on the label.

16. Repeat steps 13-15 until no further adjustments are needed.

The turbidimeter is now calibrated to the secondary standards, which are calibrated to the primary standards. You can now proceed to measure unknown samples.

9.0 SAMPLE MEASUREMENT

Note: Condensation on the cuvette will cause false readings. If the sample is colder than the area it is being measured in, allow the temperature to equalize.

1. Use a clean (inside and out) cuvette which has been aligned and which has no scratches.

2. Rinse the cuvette and cuvette cap as follows: Thoroughly shake the sample. Pour at least 5ml of sample into the cuvette. Cover with a cuvette cap. Tilt the cuvette to rinse the entire inside surface of the cuvette and cap. Pour the liquid out. Shake out remaining liquid.

3. Repeat step 2 at least one more time.

4. Thoroughly shake the sample. Allow the air bubbles to disappear and large sediment to settle prior to pouring the sample into the cuvette. Slowly pour the sample (unknown) liquid against the side of the cuvette to avoid forming air bubbles. Fill to the alignment mark.

5. Place the cap securely on top of the cuvette.

6. After pouring an unknown sample it is recommended, when possible, to immerse the cuvette in an ultrasonic bath for 1 to 2 seconds to cause complete air bubble release. Do not do this with standards.

7. Clean the outside of the cuvette with a lint free tissue or cloth and glass cleaner (alcohol). Avoid touching the area below the mark as finger prints can greatly distort the turbidity reading. Using a dry tissue alone is not adequate for removing finger prints and oils and will cause inaccurate readings.

8. Set the range switch to 0-200 NTU, insert the sample cuvette, align the cuvette in the test well and cover with the light shield. Switch to the lowest NTU range for which there is a displayable reading and read the NTU value of the sample. See Section 9.0 MEASUREMENT GUIDELINES for additional information.

10.0 MEASUREMENT GUIDELINES

1. The 0-2 NTU range should only be used for calibration procedures and "LAB" testing. Under normal use, the 0-20 NTU range should be used for all low level sample readings done in the field. The 0-20 NTU range gives acceptable readings well within EPA's and other regulatory agencies 2% requirements.

2. Always use the same cuvette for the standard and the sample when calibrating with primary standard as long as it remains scratch free. Remember... no two cuvettes have identical characteristics.

3. Keep cuvettes clean from dust and scratches. Handle the cuvettes so that no fingerprints can get on the area below the level mark.

4. Make sure the cuvette is indexed and it is aligned in the test well before taking any readings.

5. Insure that the turbidimeter has been turned on for at least a 5 minutes prior to use (1 (one) minute for portables).

6. Before adding a standard or sample into a cuvette, rinse the cuvette twice with 5ml of the current liquid to be tested. This removes the effects of the previous liquid and any dust or foreign matter that may have found its way into the cuvette while not in use.

7. Gently pour the liquid to be tested down the side of the tilted cuvette. This reduces air bubbles that distort readings. When using AEPA-1 standards, if air bubbles are present allow the cuvette to sit for 10 minutes and/or gently tap the side of the cuvette prior to use as it settles out quickly.

8. If the sample water to be tested is cold, you must allow it to warm up to room temperature before testing. Cool liquid in a warm turbidimeter chamber will cause the cuvette to fog up, which will distort the reading.

11.0 LINEAR CALIBRATION CURVES

Where high accuracy is required on a particular range, a linear calibration curve can be generated. This involves a graph with the known NTU values on the X axis and the measured NTU values on the Y axis on linear paper. It is obtained as follows:

1. A known primary standard is measured following the proper procedures and the point is plotted on the graph paper.
2. Several points within the selected NTU range are plotted.
3. A straight line is connected between them. It is recommended to use five or more points.

The unknown water sample is measured following the proper procedures. The NTU value is obtained by finding where the measured value intersects the linear calibrated curve. The X value is for the unknown water sample.

NOTE: The linear calibration curves are essential when using the 0-2 NTU range.

12.0 MAINTENANCE

CUVETTE AND SEALED STANDARDS

1. DO NOT FREEZE sealed standards or primary standards. Store at room temperature.
2. Always store sample cuvettes with cap on tight to keep inside clean.
3. Store the cuvette and secondary standards in a place where they will not be scratched or broken.
4. Examine cuvettes for scratches periodically and replace, if necessary.

TEST WELL

1. Always keep the test well covered with the light shield.
2. Use a soft tissue and glass cleaner to clean the inside of the test well.
3. If the IR filter (the blue glass at the bottom of the well) becomes dirty, clean it using the following procedure:
 - a. Remove the retaining clip with snap ring pliers.
 - b. Cup one hand over the test well and slowly turn the turbidimeter upside down to allow the collimator ring and IR filter to fall into your hand. Shake the turbidimeter lightly if necessary to dislodge the IR filter.
 - c. Turn the turbidimeter right side up.
 - d. Wipe the collimator clean and clean the IR filter with glass cleaner and a soft tissue. Touch the IR filter only around the edge.
 - e. Put the IR filter back at the bottom of the test well and cover with the collimator.
 - f. Replace the retaining clip.

13.0 TROUBLESHOOTING GUIDE

1. Blank Display.

Power switch on?

Batteries dead?...Plug in wall plug adaptor. Batteries will recharge while meter is in use, then recharge overnight to insure batteries are completely re-charged.

Wall plug adaptor plugged in?...Pull out and push in to verify the plug is in correctly.

Wall outlet has power?...Plug a lamp or radio into outlet to verify it has power.

2. Display reads 1.

Cuvette covered with light shield?

NTU range to low?...Switch to a higher range

3. Reading are way off and only change when the light shield is removed.

Lamp burnt out?...see Installing A New Lamp.

Batteries dead?...Try wall plug adapter and recharge.

4. Set control won't adjust high enough to standard.

Test well dirty?...see Maintenance

Lamp output not high enough?...see Installing A New Lamp

5. Readings inconsistent.

Make sure that:

-you are using the light shield.

-the cuvette is aligned.

-you are using the same cuvette for primary standards and samples.

-the cuvette sides and bottom aren't scratched (try another cuvette).

-the cuvette is clean (The cuvette must be cleaned with alcohol and a lint free cloth in order to remove fingerprints, dust grease, and other debris.)

-there are no air bubbles in the sample (see Measurement Guidelines).

-there is no condensation on cuvette (see Measurement Guidelines).

6. Bouncing readings are due to the 3rd digit (1/1000 place) sensitivity. In the best lab setting the 0-2 NTU range will vary $\pm .002$ max. For general use, the 0-2 NTU range may vary $\pm .005$, but will be well within regulatory requirements.

14.0 INSTALLING A NEW LAMP

Tools: phillips screwdriver
pliers
cyanoacrylate (super glue)
soldering iron
replacement lamp

1. Turn the unit off and unplug the power jack or disconnect the battery.
2. Remove the shroud (for lab models) or black case (for portable models).
3. Locate the two lamp wires coming out of the circuit board near the word "lamp".
4. Use a soldering iron to remove the lamp wires from the circuit board.
5. Grab the lamp body sticking out of the optical block with the pliers. Twist to break the glue seal and pull out. Scrape off excess glue from the optical block.
6. Clean the new lamp lens with alcohol and insert into the optical block. Push the lamp in gently until it stops against the IR filter.
7. Apply a small amount of glue into the gap surrounding the lamp and the optical block.
8. Solder the wires into the circuit board.
9. Proceed to ADJUSTING THE LAMP VOLTAGE.

15.0 ADJUSTING THE LAMP VOLTAGE

Tools: phillips screwdriver
tweaker (small standard screwdriver)
10 NTU secondary standard

1. Turn the turbidimeter off and unplug power jack or disconnect the battery.
2. Remove the shroud (for lab models) or black case (for portable models).

The circuit board is located underneath the display. Locate trim pot R3 near the top of the circuit board.

3. Set the turbidimeter down on a flat surface, plug the power jack into the unit (not necessary for portable units with batteries) and turn the unit on.
4. Set the NTU range switch to 0-20. Adjust the SET/CAL knob to its middle position. Allow the turbidimeter to warm up for at least 5 minutes.
5. Clean the 10 NTU sealed standard. Insert cuvette into the test well and align the cuvette with the test well. Note the calibrated NTU value of the standard. Cover with the light shield.

6. Adjust trim pot R3 with tweaker until the display reads the approximate calibrated NTU value of the 10 NTU sealed standard. If the maximum display reading is less than the calibrated NTU value, adjust trim pot R3 to get the highest display reading. Then turn the SET/CAL knob clockwise. If the display reading cannot be adjusted to the calibrated NTU value of the 10 NTU sealed standard, the lamp needs to be replaced. See INSTALLING A NEW LAMP.
7. After the lamp has been adjusted, turn the unit off and unplug the power jack or disconnect the battery. Put the turbidimeter back together.

16.0 BATTERY INFORMATION FOR PORTABLES

The portable turbidimeter uses an 8 AA-cell rechargeable NiCd battery. When the battery has become discharged below its useful level, the letters, BAT, will be displayed in the upper left-hand corner of the display. The battery should, at this point, be recharged.

*** CAUTION***

Failure to recharge the battery could result in premature aging of the battery unit.

Follow the Meter Setup instructions in Sections 4.0.1 thru 4.0.3 to activate the recharger. The power switch may be in either the on or off position. Use of the portable turbidimeter may continue while the battery is recharging.

The battery charger (wall plug adaptor) will recharge the battery in about 12 hours. It will not overcharge. No damage will result if the charger is connected indefinitely. The meter may be stored with the charger connected.

BATTERY LIFE

A fully charged battery will operate the portable turbidimeter for about 3 hours. As the battery ages, this operating time may decline. End of life usually occurs after 1000 discharge/recharge cycles, when recharging does not result in significant operating time. At this point, the battery should be replaced.

REPLACING THE BATTERY

1. Turn the power switch to the off position and disconnect the wall plug adaptor.
2. Remove the four screws on the front panel.
3. Hold the turbidimeter upside down and carefully lift the back case off. Carefully set the unit down.
4. At the bottom of the case is a bracket holding the battery. Disconnect the battery from the connectors.
5. Remove the bracket by loosening the wing nut.

6. Remove all the old batteries from both packs.
7. Note the polarity marks on the battery cells. Install eight AA-cell rechargeable NiCd batteries. Press the battery back into the connectors.
8. Verify operation by turning the power switch on.
9. Turn the power switch off.
10. Put the battery back under the bracket and tighten down the wing nut.
11. Carefully put unit back together.
12. Recharge battery overnight to obtain maximum use.

17.0 THEORY OF OPERATION

Turbidity refers to a lack of clarity in a liquid. It is described as haze, milkiness, or cloudiness. Turbidity in water can be caused by clay, silt, organic matter, bacterial colonies, and plankton.

When a liquid contains particulate matter, a beam of light passed through the sample will be scattered in all directions. The amount of light that is scattered can then be directly related to the concentration of the particulate matter. The amount of light transmitted or scattered is affected by size, shape and concentration of the impurities. If size and shape are relatively constant, then measuring the light scattered and/or transmitted can be related to the concentration of the impurities; however, measurement of turbidity is not an exact count of the mass of suspended impurities. It is a measurement of the amount of light that is scattered by the presence of impurities.

The units of turbidity measurement using Nephelometry are arbitrary. Therefore, it is essential to calibrate the measuring instrument (turbidimeter) to a known standard before sample testing.

18.0 SPECIFICATIONS

Ranges.....	0-2 NTU, 0-2 NTU, 0-200 NTU
Resolution.....	0.1% of Range
Accuracy.....	+ 1% of full scale
Light Source (Tungsten bulb).....	5,000 hours
Sample Well.....	25 mm diameter
Size (Bench).....	5"H, 8"W, 11"D
Size (Portable).....	6"H, 6"W, 3"D
Weight (Bench).....	6 lbs (2.72 Kg)
Weight (Portable).....	5 lbs (2.27 Kg)
Power (Bench).....	110 or 220 AC Line
Power (Portable).....	8 AA-cell rechargeable NiCd battery.

APPENDIX B

OXYCHEM P.O. PROCEDURES

NOTE:

The OxyChem Purchase Order System is part of Passport®. Manuals for the use of Passport® are available on-Site in the Love Canal Administration building and thus are not reproduced in this document.

APPENDIX C

HISTORICAL SAMPLING LOGS

ANNUAL WELLS

BEDROCK

OCcidental CHEMICAL CORPORATION

GROUNDWATER FIELD SAMPLE/PURGE RECORD

LOVE CANAL LONG TERM MONITORING PROGRAM

STATION# Well 3257 DATE: 5/3/95
WEATHER NOTES: Partly Cloudy, Clear, 55°
VOC LEVEL: AMBIENT .4 HEADSPACE .8
WELL DEPTH: 29.4 FT. WATER DEPTH: TOW 11.86 FT.
WELL VOLUME: 2.96 GAL. TOTAL VOLUME PURGED _____ GAL.
SAMPLE PURGE DATA:

11- @INITIAL 1 GAL.
TEMP. 12.8 DEG. F.
SPCON 2400 MOHS
TURBID. _____ NTU'S
pH 8.39
TIME 10:48A
HR/MIN _____
PURGE _____
VOL. 1 GALS.

@ 3 GAL.
TEMP. 12.3 DEG. F.
SPCON 2900 MOHS
TURBID. _____ NTU'S
pH 7.01
TIME 10:58A
HR/MIN 10:58A
PURGE _____
VOL. 3 GALS.

@ 6 GAL.
TEMP. 12.1 DEG. F.
SPCON 2900 MOHS
TURBID. _____ NTU'S
pH 7.00
TIME 11:02
HR/MIN 4
PURGE _____
VOL. 6 GALS.

@ 9 GAL.
TEMP. 12.2 DEG. F.
SPCON 2900 MOHS
TURBID. _____ NTU'S
pH 6.99
TIME 11:05
HR/MIN 5
PURGE _____
VOL. 9 GALS.

@ _____ GAL.
TEMP. _____ DEG. F.
SPCON _____ MOHS
TURBID. _____ NTU'S
pH _____
TIME _____
HR/MIN _____
PURGE _____
VOL. _____ GALS.

@ Sample GAL.
TEMP. 12.2 DEG. F.
SPCON 2850 MOHS
TURBID. _____ NTU'S
pH 6.97
TIME 11:15AM
HR/MIN _____
PURGE _____
VOL. _____ GALS.

REMARKS/OBSERVATIONS 2" PVC inside of 4" casing
int OTV cloudy looks like great new color

TIME SAMPLED: 11:15 DATE: 5/3/95
QA/QC? (Y/N) MS? (Y/N) MSD? (Y/N) FIELD BLANK? Field duplicate # 12010 Time 12:00
DEC SPLIT? (Y/N) VOA'S, BNA'S, PESTICIDES/PCB'S
PERSON/S PURGING D. CROCKETT, K. SULLIVAN

PERSON/S SAMPLING D. CROCKETT, K. SULLIVAN

OCCIDENTAL CHEMICAL CORPORATION

GROUNDWATER FIELD SAMPLE/PURGE RECORD

LOVE CANAL LONG TERM MONITORING PROGRAM

STATION # 5222 DATE: 5/4/95
WEATHER NOTES: clear
VOC LEVEL: AMBIENT .02 HEADSPACE φ
WELL DEPTH: 37.4 FT. WATER DEPTH: TOW 12.96 FT.
WELL VOLUME: ~~12.6~~ 15.88 GAL. TOTAL VOLUME PURGED 15.88 GAL.
SAMPLE PURGE DATA:

@INITIAL 0 GAL.
TEMP. 10.7 DEG. C
SPCON 3,600 MOHS
TURBID. 17 NTU'S
pH 8.7
TIME 8:39
HR/MIN —
PURGE
VOL. 0 GALS.

@ 16 GAL.
TEMP. 11.5 DEG. C
SPCON 4,200 MOHS
TURBID. 7200 NTU'S
pH 7.02
TIME 8:58
HR/MIN 20
PURGE
VOL. 16 GALS.

@ 32 GAL.
TEMP. 12.2 DEG. C
SPCON 4,400 MOHS
TURBID. 6 NTU'S
pH 6.90
TIME 9:20
HR/MIN 22 min
PURGE
VOL. 32 GALS.

@ 48 GAL.
TEMP. 12.0 DEG. C
SPCON 4,400 MOHS
TURBID. 5 NTU'S
pH 6.86
TIME 9:50
HR/MIN 30 min
PURGE
VOL. 48 GALS.

@ GAL.
TEMP. DEG. C
SPCON MOHS
TURBID. NTU'S
pH
TIME
HR/MIN
PURGE
VOL. GALS.

SAMPLING
@ GAL.
TEMP. 12.0° DEG. C
SPCON 4000 MOHS
TURBID. 6 +/- NTU'S
pH 6.90
TIME 10:10
HR/MIN —
PURGE
VOL. — GALS.

REMARKS/OBSERVATIONS
Casing is Carbon steel
not Qty Brown Color - water turned real dark - sediment at 15 GALS
with H2S odor

Final Water Quality: Dark color, clear, H2S odor, trace
dark settled sediments

TIME SAMPLED: 1000 DATE: 5/4/95
QA/QC? Y MS? MSD? FIELD BLANK?
DEC SPLIT? Y VOA'S, BNA'S, PESTICIDES/PCB'S
PERSON/S PURGING Parkhill Crockett, Lynch

PERSON/S SAMPLING Parkhill, Lynch

OCCIDENTAL CHEMICAL CORPORATION

16

GROUNDWATER FIELD SAMPLE/PURGE RECORD

LOVE CANAL LONG TERM MONITORING PROGRAM

STATION # 7205 DATE: 5/2/95
WEATHER NOTES: Overcast, 45°, NE WIND
VOC LEVEL: AMBIENT 04 HEADSPACE
WELL DEPTH: 49.6 FT. WATER DEPTH: TOW 13.09 FT.
WELL VOLUME: 5.5 GAL. TOTAL VOLUME PURGED 24 GAL.
SAMPLE PURGE DATA:

@INITIAL 0 GAL.
TEMP. 10 DEG. F.C.
SPCON 900 MOHS
TURBID. - NTU'S
pH 7.17
TIME 9:00 AM
HR/MIN 0
PURGE
VOL. 0 GALS.

@ 6 GAL.
TEMP. 11.1 DEG. F.C.
SPCON 200 MOHS
TURBID. - NTU'S
pH 7.05
TIME 9:10 AM
HR/MIN 10 min
PURGE
VOL. 6 GALS.

@ 12 GAL.
TEMP. 10.8 DEG. F.
SPCON 2400 MOHS
TURBID. - NTU'S
pH 7.01
TIME 9:20 AM
HR/MIN 10 min
PURGE
VOL. 12 GALS.

@ 18 GAL.
TEMP. 11.2 DEG. F.C.
SPCON 2500 MOHS
TURBID. - NTU'S
pH 6.55
TIME 9:30 AM
HR/MIN 10 min
PURGE
VOL. 18 GALS.

@ 24 GAL.
TEMP. 11.6 DEG. F.C.
SPCON 2600 MOHS
TURBID. - NTU'S
pH 6.90
TIME 9:39 AM
HR/MIN 9 min
PURGE
VOL. 24 GALS.

SAMPLING
@ - GAL.
TEMP. 10.6° DEG. F.C.
SPCON 2350 MOHS
TURBID. - NTU'S
pH 7.11
TIME 0950 start
HR/MIN
PURGE
VOL. GALS

REMARKS/OBSERVATIONS Purged w/ peristaltic pump
Initial w/c - clear, no odor

FINAL Clear, Colorless, Sulfide odor, no sheen

TIME SAMPLED: 9:50 AM DATE: 5/2/95
QA/QC? Y/N MS? MSD? FIELD BLANK?
DEC SPLIT? (Y)N VOA'S, BNA'S, PESTICIDES/PCB'S Duplicate
PERSON/S PURGING Crockett, Lynch, Parkhill, Moore

PERSON/S SAMPLING Crockett, Parkhill, Moore, Lynch

OCcidental CHEMICAL CORPORATION

16

GROUNDWATER FIELD SAMPLE/PURGE RECORD

LOVE CANAL LONG TERM MONITORING PROGRAM

STATION # 8210 DATE: 5/2/95
WEATHER NOTES: Sunny, 55° NE wind
VOC LEVEL: AMBIENT 0.04 HEADSPACE 0
WELL DEPTH: 44.1 FT. WATER DEPTH: TOW 12.35 FT.
WELL VOLUME: 5.08 GAL. TOTAL VOLUME PURGED 15 GAL.
SAMPLE PURGE DATA:

@INITIAL 0 GAL.
TEMP. 12.6 DEG. F.C
SPCON 1200 MOHS
TURBID. - NTU'S
pH 7.31
TIME 11:15 AM
HR/MIN 0
PURGE
VOL. 0 GALS.

@ 5 GAL.
TEMP. 11.8 DEG. F.C
SPCON 2400 MOHS
TURBID. - NTU'S
pH 6.95
TIME 11:22 AM
HR/MIN 8 min
PURGE
VOL. 5 GALS.

@ 10 GAL.
TEMP. 13.7 DEG. F.C
SPCON 2400 MOHS
TURBID. - NTU'S
pH 7.07
TIME 11:29 AM
HR/MIN 6 min
PURGE
VOL. 10 GALS.

@ 15 GAL.
TEMP. 13.1 DEG. F.C
SPCON 2450 MOHS
TURBID. - NTU'S
pH 6.97
TIME 11:36 AM
HR/MIN 7 min
PURGE
VOL. 15 GALS.

@ GAL.
TEMP. DEG. F.C
SPCON MOHS
TURBID. - NTU'S
pH
TIME
HR/MIN
PURGE
VOL. GALS

@ SAMPLING GAL.
TEMP. 11.7 DEG. F.C
SPCON 2400 MOHS
TURBID. - NTU'S
pH 7.10
TIME
HR/MIN
PURGE
VOL. GALS

REMARKS/OBSERVATIONS
Initial - Clear, no odor
Final Water Quality - clear, colorless, no sheen, sulfide Odor

TIME SAMPLED: 1350 DATE: 5/2/95
QA/QC? Y MS? MSD? FIELD BLANK?
DEC SPLIT? N VOA'S, BNA'S, PESTICIDES/PCB'S Duplicate
PERSON/S PURGING Moore, Crockett, Parkhill, Lynch

PERSON/S SAMPLING Moore, crockett, Parkhill, Lynch

unweighted
bar bar

OCcidental CHEMICAL CORPORATION

GROUNDWATER FIELD SAMPLE/PURGE RECORD

LOVE CANAL LONG TERM MONITORING PROGRAM

STATION # 9205 DATE: 5/2/95
 WEATHER NOTES: Sunny, 55°F NE wind
 VOC LEVEL: AMBIENT .03 HEADSPACE 0
 WELL DEPTH: 47.0 FT. WATER DEPTH: TOW 11.36 FT.
 WELL VOLUME: 5.1 GAL. TOTAL VOLUME PURGED 18 GAL.
SAMPLE PURGE DATA:

100 @ INITIAL 0 GAL.
 TEMP. 13.7 DEG. °C
 SPCON 680 MOHS
 TURBID. — NTU'S
 pH 8.49
 TIME 12:00 Noon
 HR/MIN 0
 PURGE
 VOL. 0 GALS.

@ 6 GAL.
 TEMP. 13.2 DEG. °C
 SPCON 3900 MOHS
 TURBID. — NTU'S
 pH 6.97
 TIME 12:09 PM
 HR/MIN 9 min
 PURGE
 VOL. 6 GALS.

@ 12 GAL.
 TEMP. 13.7 DEG. °C
 SPCON 3800 MOHS
 TURBID. — NTU'S
 pH 6.95
 TIME 12:14 PM
 HR/MIN 5 min
 PURGE
 VOL. 12 GALS.

@ 18 GAL.
 TEMP. 13.0 DEG. °C
 SPCON 4000 MOHS
 TURBID. — NTU'S
 pH 6.96
 TIME 12:21
 HR/MIN 7 min
 PURGE
 VOL. 18 GALS.

@ GAL.
 TEMP. DEG. °C
 SPCON MOHS
 TURBID. NTU'S
 pH
 TIME
 HR/MIN
 PURGE
 VOL. GALS.

~~SAMPLING~~
 @ GAL.
 TEMP. 11.6 DEG. °C
 SPCON 3600 MOHS
 TURBID. NTU'S
 pH 7.08
 TIME
 HR/MIN
 PURGE
 VOL. GALS.

REMARKS/OBSERVATIONS

Initial water - clear, no odor
FINAL WATER Clear, colorless, no sheen, sulfide odor

TIME SAMPLED: 1415 DATE: 5/2/95
 QA/QC? YES? MSD? FIELD BLANK?
 DEC SPLIT? YES VOA'S, BNA'S, PESTICIDES/PCB'S
 PERSON/S PURGING Crockett, Lynch, Parkhill
 PERSON/S SAMPLING Crockett, Parkhill, Moore, LYNCH

OCcidental CHEMICAL CORPORATION

GROUNDWATER FIELD SAMPLE/PURGE RECORD

LOVE CANAL LONG TERM MONITORING PROGRAM

STATION # 97.10 DATE: 5/16/95
WEATHER NOTES: Sunny 62°F EAST winds
VOC LEVEL: AMBIENT 0.2 HEADSPACE 0.2
WELL DEPTH: 82.3 FT. WATER DEPTH: TOW 17.60 FT.
WELL VOLUME: 10.33 GAL. TOTAL VOLUME PURGED 31.5 GAL.
SAMPLE PURGE DATA:

lk @INITIAL 0 GAL.
TEMP. 17.4 DEG. F.
SPCON 1800 MOHS
TURBID. 0.2 NTU'S
pH 7.36
TIME 9:35 AM
HR/MIN -
PURGE
VOL. 0 GALS.

@ 10.5 GAL.
TEMP. 14.7 DEG. F.
SPCON 5200 MOHS
TURBID. 0.3 NTU'S
pH 6.79
TIME 9:54
HR/MIN 19min
PURGE
VOL. 10.5 GALS.

@ 21 GAL.
TEMP. 17.4 DEG. F.
SPCON 5200 MOHS
TURBID. 0.3 NTU'S
pH 6.75
TIME 10:14
HR/MIN 20min
PURGE
VOL. 21 GALS.

@ 31.5 GAL.
TEMP. 14.1 DEG. F.
SPCON 5400 MOHS
TURBID. 0.20 NTU'S
pH 6.77
TIME 10:34
HR/MIN 20min
PURGE
VOL. 31.5 GALS.

@ _____ GAL.
TEMP. _____ DEG. F.
SPCON _____ MOHS
TURBID. _____ NTU'S
pH _____
TIME _____
HR/MIN _____
PURGE
VOL. _____ GALS.

SAMPLING
@ _____ GAL.
TEMP. 13.3 DEG. F.
SPCON 1800 MOHS
TURBID. 4.6 NTU'S
pH 7.47
TIME 11:50
HR/MIN _____
PURGE
VOL. _____ GALS.

REMARKS/OBSERVATIONS
Initial - water clear no odor, 2nd vol strong sulfide odor
DOT - Spraying weeds - orange paint in well
Final - clean, strong sulfide odor
Same, 1

TIME SAMPLED: _____ DATE: _____
QA/QC? Y/N MS? MSD? FIELD BLANK? _____
DEC SPLIT? VOA'S, BNA'S, PESTICIDES/PCB'S
PERSON/S PURGING Crockett, Parkhill, Lyck, Moore

PERSON/S SAMPLING _____

OCcidental CHEMICAL CORPORATION

GROUNDWATER FIELD SAMPLE/PURGE RECORD

39.92' Water

LOVE CANAL LONG TERM MONITORING PROGRAM

STATION # 102c5 DATE: 5/16/95
WEATHER NOTES: Sunny, 62°F, East winds
VOC LEVEL: AMBIENT 0.2 HEADSPACE 0.2
WELL DEPTH: 54 FT. WATER DEPTH: TOW 14.08 FT.
WELL VOLUME: 6.4 GAL. TOTAL VOLUME PURGED 20 GAL.
SAMPLE PURGE DATA:

@ INITIAL 0 GAL.
TEMP. 14.9 DEG. F.
SPCON 5300 MOHS
TURBID. 1.3 NTU'S
pH 6.51
TIME 10:05 AM
HR/MIN
PURGE
VOL. 0 GALS.

@ 6.4 GAL.
TEMP. 14.0 DEG. F.
SPCON 5400 MOHS
TURBID. .3 NTU'S
pH 6.77
TIME 10:15
HR/MIN 10 min
PURGE
VOL. 6.4 GALS.

@ 12.8 GAL.
TEMP. 14.5 DEG. F.
SPCON 5400 MOHS
TURBID. .07 NTU'S
pH 6.78
TIME 10:25
HR/MIN 10 min
PURGE
VOL. 12.8 GALS.

@ 19.2 GAL.
TEMP. 15.0 DEG. F.
SPCON 5300 MOHS
TURBID. .12 NTU'S
pH 6.7
TIME 10:40
HR/MIN 10 min
PURGE
VOL. 19.2 GALS.

@ GAL.
TEMP. DEG. F.
SPCON MOHS
TURBID. NTU'S
pH
TIME
HR/MIN
PURGE
VOL. GALS

SAMPLING
@ GAL.
TEMP. 14.7° DEG. F.
SPCON 4300 MOHS
TURBID. 2.3 NTU'S
pH 6.67
TIME 12:10
HR/MIN
PURGE
VOL. GALS

REMARKS/OBSERVATIONS Water turns dark after 1 gal purged -
Strong H2S Odor, black staining on glassware, Occasional
exhaust fumes from cars on eastbound Lasalle Expy.

SAMPLING - Clear, colorless, H2S Odor, no sheen

TIME SAMPLED: 1210 DATE: 5/16/95
QA/QC? Y (N) MS? MSD? FIELD BLANK?
DEC SPLIT? 0/N VOA'S, BNA'S, PESTICIDES/PCB'S
PERSON/S PURGING Crockett, Lynch, Parkhill

PERSON/S SAMPLING Crockett, Moore, Lynch

OCCIDENTAL CHEMICAL CORPORATION

GROUNDWATER FIELD SAMPLE/PURGE RECORD

LOVE CANAL LONG TERM MONITORING PROGRAM

STATION # 0210A DATE: 5/25/95
 WEATHER NOTES: Cloudy, overcast, 50"
 VOC LEVEL: AMBIENT 0.2 HEADSPACE 0.6
 WELL DEPTH: 216 FT. WATER DEPTH: TOW 9.30 FT.
 WELL VOLUME: _____ GAL. TOTAL VOLUME PURGED _____ GAL.
SAMPLE PURGE DATA:

@ INITIAL 2 GAL.
 TEMP. 15.8 DEG. F. C
 SPCON 10.00 MOHS
 TURBID. _____ NTU'S
 pH 6.40
 TIME 10:27 AM
 HR/MIN 1.5 min
 PURGE
 VOL. 2 GALS.

@ 33 GAL.
 TEMP. 16.0 DEG. F. C
 SPCON 10.00 MOHS
 TURBID. _____ NTU'S
 pH 6.65
 TIME 1407
 HR/MIN 3h 37min
 PURGE
 VOL. 33 GALS.

@ 48 GAL. DRY
 TEMP. _____ DEG. F. C
 SPCON _____ MOHS
 TURBID. _____ NTU'S
 pH _____
 TIME 1500
 HR/MIN _____
 PURGE
 VOL. _____ GALS.

@ SAMPLING GAL.
 TEMP. 14.5 DEG. F. C
 SPCON 100000 MOHS ^{1000 X 10}
 TURBID. NM NTU'S ^{with 210}
 pH 6.62
 TIME 1530
 HR/MIN _____
 PURGE
 VOL. _____ GALS.

@ _____ GAL.
 TEMP. _____ DEG. F. C
 SPCON _____ MOHS
 TURBID. _____ NTU'S
 pH _____
 TIME _____
 HR/MIN _____
 PURGE
 VOL. _____ GALS.

@ _____ GAL.
 TEMP. _____ DEG. F. C
 SPCON _____ MOHS
 TURBID. _____ NTU'S
 pH _____
 TIME _____
 HR/MIN _____
 PURGE
 VOL. _____ GALS.

REMARKS/OBSERVATIONS Dark, black Heavy H₂S odor, black particles
Ferrous - Dark, Strong H₂S + Nat. Gas, black particles

Dry after 48 gal Purged - Pump ~ 3-5' above bottom
of well. Sample using bladder pump

TIME SAMPLED: 1530 DATE: 5/25/95
 QA/QC? Y/N MS? MSD? FIELD BLANK? _____
 DEC SPLIT? Y/N VOA'S, BNA'S, PESTICIDES/PCB'S _____
 PERSON/S PURGING Parkhill, Lynch, Moore-Dice, Crockett
 PERSON/S SAMPLING Parkhill, Lynch

OCCIDENTAL CHEMICAL CORPORATION

GROUNDWATER FIELD SAMPLE/PURGE RECORD

LOVE CANAL LONG TERM MONITORING PROGRAM

STATION # 102100 DATE: 6/1/95
WEATHER NOTES: Sunny, Windy 70°
VOC LEVEL: AMBIENT 0 HEADSPACE 0
WELL DEPTH: 139 FT. WATER DEPTH: TOW 13.0 FT.
WELL VOLUME: 20.16 GAL. TOTAL VOLUME PURGED 60 GAL.
SAMPLE PURGE DATA:

@ INITIAL 0 GAL.
TEMP. 14.2 DEG. °C
SPCON 26000 MOHS
TURBID. — NTU'S
pH 7.90
TIME 9:00 AM
HR/MIN —
PURGE
VOL. 0 GALS.

@ 20 GAL.
TEMP. 17.3 DEG. °C
SPCON 9000 MOHS
TURBID. — NTU'S
pH 7.72
TIME 9:30
HR/MIN 20m
PURGE
VOL. 20 GALS.

@ 40 GAL.
TEMP. 14.6 DEG. °C
SPCON 8400 MOHS
TURBID. — NTU'S
pH 7.10
TIME 10:00
HR/MIN 20m
PURGE
VOL. 40 GALS.

@ 60 GAL.
TEMP. 14.3 DEG. °C
SPCON 9400 MOHS
TURBID. — NTU'S
pH 7.18
TIME 10:30
HR/MIN 20m
PURGE
VOL. — GALS.

@ — GAL.
TEMP. — DEG. °C
SPCON — MOHS
TURBID. — NTU'S
pH —
TIME —
HR/MIN —
PURGE
VOL. — GALS.

@ Sample GAL.
TEMP. 15.0 DEG. °C
SPCON 8700 MOHS
TURBID. — NTU'S
pH 9.24
TIME 10:48 AM
HR/MIN —
PURGE
VOL. — GALS.

REMARKS/OBSERVATIONS

Exit - clear - slight odor
Flow - yellowish no odor

TIME SAMPLED: _____ DATE: 6/1/95
QA/QC? Y/N MS? MSD? FIELD BLANK? _____
DEC SPLIT? Y/N VOA'S, BNA'S, PESTICIDES/PCB'S _____
PERSON/S PURGING Ponahill, Crockett
PERSON/S SAMPLING Ponahill, Crockett

OCCIDENTAL CHEMICAL CORPORATION

GROUNDWATER FIELD SAMPLE/PURGE RECORD

LOVE CANAL LONG TERM MONITORING PROGRAM

STATION # 10210C DATE: 6/1/95
WEATHER NOTES: Sunny, in sun, 70
VOC LEVEL: AMBIENT HEADSPACE
WELL DEPTH: 84 FT. WATER DEPTH: TOW 12.72 FT.
WELL VOLUME: 11.4 GAL. TOTAL VOLUME PURGED 33.5 GAL.
SAMPLE PURGE DATA:

@ INITIAL 0 GAL.
TEMP. 13.7 DEG. F.C
SPCON 5,900 MOHS
TURBID. — NTU'S
pH 7.05
TIME 9:00 AM
HR/MIN —
PURGE
VOL. — GALS.

@ 11.5 GAL.
TEMP. 14.4 DEG. F.C
SPCON 5,300 MOHS
TURBID. — NTU'S
pH 6.86
TIME 9:25 AM
HR/MIN 35
PURGE
VOL. 11.5 GALS.

@ 22 GAL.
TEMP. 14.9 DEG. F.C
SPCON 5,500 MOHS
TURBID. — NTU'S
pH 6.90
TIME 10:16 AM
HR/MIN 36
PURGE
VOL. 22 GALS.

@ 33.5 GAL.
TEMP. 14.4 DEG. F.C
SPCON 5,500 MOHS
TURBID. — NTU'S
pH 6.85
TIME 10:45
HR/MIN 35
PURGE
VOL. 33.5 GALS.

@ final GAL.
TEMP. 14.5 DEG. F.C
SPCON 5,500 MOHS
TURBID. — NTU'S
pH 6.84
TIME 11:10 AM
HR/MIN —
PURGE
VOL. — GALS.

@ GAL.
TEMP. DEG. F.C
SPCON MOHS
TURBID. NTU'S
pH
TIME
HR/MIN
PURGE
VOL. GALS

REMARKS/OBSERVATIONS

Int water QTY Black odor
[Blank lines for additional remarks]

TIME SAMPLED: DATE:
QA/QC? Y/N MS? MSD? FIELD BLANK?
DEC SPLIT? Y/N VOA'S, BNA'S, PESTICIDES/PCB'S
PERSON/S PURGING Parkhill, Crockett
PERSON/S SAMPLING Parkhill, Crockett

OCCIDENTAL CHEMICAL CORPORATION

GROUNDWATER FIELD SAMPLE/PURGE RECORD

LOVE CANAL LONG TERM MONITORING PROGRAM

STATION # 10225A DATE: 5/26/95
WEATHER NOTES: SUN 65°
VOC LEVEL: AMBIENT 0.2 HEADSPACE 0.6
WELL DEPTH: 213.0 FT. WATER DEPTH: TOW 12.82' FT.
WELL VOLUME: 32.02 GAL. TOTAL VOLUME PURGED _____ GAL.
SAMPLE PURGE DATA: Airlift

@INITIAL 0 GAL.
TEMP. 17.6 DEG. F.C
SPCON > 10,000 MOHS
TURBID. Nm NTU'S
pH 7.26
TIME 10:05 A.M.
HR/MIN _____
PURGE _____
VOL. φ GALS.

SAMPLING - Bailers
@ _____ GAL.
TEMP. _____ DEG. F.
SPCON _____ MOHS
TURBID. _____ NTU'S
pH _____
TIME _____
HR/MIN _____
PURGE _____
VOL. _____ GALS.

@ 32 GAL.
TEMP. 15.6 DEG. F.C
SPCON > 10,000 MOHS
TURBID. Nm NTU'S
pH 7.44
TIME 1:35 P.
HR/MIN 3:35
PURGE _____
VOL. 32.0 GALS.

@ _____ GAL.
TEMP. _____ DEG. F.
SPCON _____ MOHS
TURBID. _____ NTU'S
pH _____
TIME _____
HR/MIN _____
PURGE _____
VOL. _____ GALS.

@ 48 GAL. DRY
TEMP. 17.3 DEG. F.C
SPCON > 10,000 MOHS
TURBID. NM NTU'S
pH 6.50
TIME 1430
HR/MIN _____
PURGE _____
VOL. 48 GALS.

@ _____ GAL.
TEMP. _____ DEG. F.
SPCON _____ MOHS
TURBID. _____ NTU'S
pH _____
TIME _____
HR/MIN _____
PURGE _____
VOL. _____ GALS.

REMARKS/OBSERVATIONS

inst water (dry) - clear pinkish, changes to dark, black,
strong H₂S odor, Black floaters.
Final - black, cloudy, strong odor

TIME SAMPLED: 1500 DATE: 5/26/95
QA/QC? Y MS? _____ MSD? _____ FIELD BLANK? _____
DEC SPLIT? Y VOA'S, BNA'S, PESTICIDES/PCB'S _____
PERSON/S PURGING Crockett, Parkhill, Lynch
PERSON/S SAMPLING Crockett, Parkhill, Lynch

OCCIDENTAL CHEMICAL CORPORATION

GROUNDWATER FIELD SAMPLE/PURGE RECORD

LOYE CANAL LONG TERM MONITORING PROGRAM

STATION # 10225-B DATE: 5/26/95

WEATHER NOTES: Sun 70°

VOC LEVEL: AMBIENT 0.2 HEADSPACE 0.2

WELL DEPTH: 139.0 FT. WATER DEPTH: TOW 12.51' FT.

WELL VOLUME: 20.22 GAL. TOTAL VOLUME PURGED _____ GAL.

SAMPLE PURGE DATA: Start - Bladder pump
short Airlift - stops working right - go to bladder pump.

@ INITIAL 0 GAL.
TEMP. 14.6 DEG. F.
SPCON 2,900 MOHS
TURBID. NM NTU'S
pH 7.61
TIME 11.06 am
HR/MIN _____
PURGE _____
VOL. _____ GALS.

@ 20 GAL.
TEMP. 15.6 DEG. F.
SPCON >10,000 MOHS
TURBID. NM NTU'S
pH 6.61
TIME 1220
HR/MIN _____
PURGE _____
VOL. 20 GALS.

@ 40 GAL.
TEMP. 17.6 DEG. F.
SPCON >10,000 MOHS
TURBID. _____ NTU'S
pH 6.72
TIME 1345
HR/MIN _____
PURGE _____
VOL. 40 GALS.

@ 60 GAL.
TEMP. _____ DEG. F.
SPCON _____ MOHS
TURBID. _____ NTU'S
pH _____
TIME 1500
HR/MIN _____
PURGE _____
VOL. 60 GALS.

@ _____ GAL.
TEMP. _____ DEG. F.
SPCON _____ MOHS
TURBID. _____ NTU'S
pH _____
TIME _____
HR/MIN _____
PURGE _____
VOL. _____ GALS.

@ _____ GAL.
TEMP. _____ DEG. F.
SPCON _____ MOHS
TURBID. _____ NTU'S
pH _____
TIME _____
HR/MIN _____
PURGE _____
VOL. _____ GALS.

REMARKS/OBSERVATIONS INITIAL WATER QUALITY: Cloudy, H₂S odor,
Black sulfides

Final - Black, cloudy

TIME SAMPLED: 1530 DATE: 5/26/95

QA/QC? Y/N MS? MSD? FIELD BLANK? 12510

DEC SPLIT? Y/N VOA'S, BNA'S, PESTICIDES/PCB'S

PERSON/S PURGING Crockett, Parkhill, Lynch

PERSON/S SAMPLING Crockett, Parkhill, Lynch

OCcidental CHEMICAL CORPORATION

GROUNDWATER FIELD SAMPLE/PURGE RECORD

LOVE CANAL LONG TERM MONITORING PROGRAM

STATION # 10225c DATE: 6/1/85
WEATHER NOTES: Sun, 400m, 70°
VOC LEVEL: AMBIENT 0.2 HEADSPACE 0.2
WELL DEPTH: 66 FT. WATER DEPTH: TOW 13.48 FT.
WELL VOLUME: 8.4 GAL. TOTAL VOLUME PURGED 26gal GAL.
SAMPLE PURGE DATA:

@ INITIAL 0 GAL.
TEMP. 15.1 DEG. F.C
SPCON 3300 MOHS
TURBID. NTU'S
pH 7.04
TIME 11:35 AM
HR/MIN
PURGE
VOL. GALS.

@ 8.5 GAL.
TEMP. 15.7 DEG. F.C
SPCON 3,500 MOHS
TURBID. NTU'S
pH 7.07
TIME 12:05 P.M.
HR/MIN 30
PURGE
VOL. 8.5 GALS.

@ 17 GAL.
TEMP. 15.5 DEG. F.C
SPCON 3,100 MOHS
TURBID. NTU'S
pH 7.13
TIME 12:29 P
HR/MIN 24
PURGE
VOL. 17 GALS.

@ 20.5 GAL.
TEMP. 15.2 DEG. F.C
SPCON 3,100 MOHS
TURBID. NTU'S
pH 7.13
TIME 12:53
HR/MIN 24
PURGE
VOL. 25.5 GALS.

@ GAL.
TEMP. DEG. F.C
SPCON MOHS
TURBID. NTU'S
pH
TIME
HR/MIN
PURGE
VOL. GALS

@ SAMPLE GAL.
TEMP. 14.8 DEG. F.C
SPCON 2,100 MOHS
TURBID. NTU'S
pH 7.81
TIME 1:11 PM
HR/MIN
PURGE
VOL. GALS

REMARKS/OBSERVATIONS

TIME SAMPLED: 1:11 PM DATE: 6/1/85

QA/QC? Y/N MS? MSD? FIELD BLANK?
DEC SPLIT? Y/N VOA'S BNA'S PESTICIDES/PCB'S

PERSON/S PURGING Parshill, Crockett

PERSON/S SAMPLING Parshill, Crockett, Moore (DESC)

OCCIDENTAL CHEMICAL CORPORATION

GROUNDWATER FIELD SAMPLE/PURGE RECORD

LOVE CANAL LONG TERM MONITORING PROGRAM

STATION # 10272 DATE: 5/8/95
WEATHER NOTES: Clear, sunny, 50°, south wind
VOC LEVEL: AMBIENT 0.2 HEADSPACE 0.2
WELL DEPTH: 47.7 FT. WATER DEPTH: TOW 14.06 FT.
WELL VOLUME: 5.4 GAL. TOTAL VOLUME PURGED 16.2 GAL.
SAMPLE PURGE DATA:

lk

@INITIAL 0 GAL.
TEMP. 11.3 DEG. °C
SPCON 800 MOHS
TURBID. 18.6 NTU'S
pH 8.34
TIME 11:14n
HR/MIN _____
PURGE _____
VOL. 0 GALS.

@ 5.4 GAL.
TEMP. 11.1 DEG. °C
SPCON 4500 MOHS
TURBID. 2.6 NTU'S
pH 6.77
TIME 11:20
HR/MIN 9min
PURGE _____
VOL. 5.4 GALS.

@ 10.8 GAL.
TEMP. 11.2 DEG. °C
SPCON 4500 MOHS
TURBID. 2.8 NTU'S
pH 6.93
TIME 11:29An
HR/MIN 9
PURGE _____
VOL. 10.8 GALS.

@ 16.2 GAL.
TEMP. 11.4 DEG. °C
SPCON 4300 MOHS
TURBID. 1.75 NTU'S
pH 6.95
TIME 11:38
HR/MIN 9min
PURGE _____
VOL. 16.2 GALS.

@ _____ GAL.
TEMP. _____ DEG. °C
SPCON _____ MOHS
TURBID. _____ NTU'S
pH _____
TIME _____
HR/MIN _____
PURGE _____
VOL. _____ GALS

@ Sample GAL.
TEMP. 10.7 DEG. °C
SPCON 800 MOHS
TURBID. 13 NTU'S
pH 8.30
TIME 11:45
HR/MIN _____
PURGE _____
VOL. _____ GALS

REMARKS/OBSERVATIONS

Initial - cloudy, no odor, strong sulfide odor 2nd volume
Final - cloudy, strong odor

TIME SAMPLED: 11:45 DATE: 5/8/95
QA/QC? Y MS? _____ MSD? _____ FIELD BLANK? _____
DEC SPLIT? Y VOA'S, BNA'S, PESTICIDES/PCB'S
PERSON/S PURGING Parkhill, Crockett, Lynch
PERSON/S SAMPLING Parkhill, Crockett, Lynch

OCCIDENTAL CHEMICAL CORPORATION

GROUNDWATER FIELD SAMPLE/PURGE RECORD

LOVE CANAL LONG TERM MONITORING PROGRAM

STATION # 10278 DATE: 5/9/85
WEATHER NOTES: Overcast
VOC LEVEL: AMBIENT 0.2 HEADSPACE 0.2
WELL DEPTH: 47 FT. WATER DEPTH: TOW 12.32 FT.
WELL VOLUME: 5.5 GAL. TOTAL VOLUME PURGED _____ GAL.
SAMPLE PURGE DATA:

<u>1K</u> @INITIAL <u>0</u> GAL. TEMP. <u>12.58</u> DEG. F.C SPCON <u>6.200</u> MOHS TURBID. <u>5.42</u> NTU'S pH <u>13.1</u> TIME <u>11:00 a.m.</u> HR/MIN _____ PURGE VOL. _____ GALS.	@ <u>5.5</u> GAL. TEMP. <u>13.3</u> DEG. F.C SPCON <u>3.800</u> MOHS TURBID. <u>6.30</u> NTU'S pH <u>10.78</u> TIME <u>11:09 a.m.</u> HR/MIN <u>9</u> PURGE VOL. _____ GALS.	@ <u>11.0</u> GAL. TEMP. <u>13.3</u> DEG. F.C SPCON <u>4.500</u> MOHS TURBID. <u>3.4</u> NTU'S pH <u>7.49</u> TIME <u>11:17 a.m.</u> HR/MIN <u>8</u> PURGE VOL. _____ GALS.
@ <u>16.5</u> GAL. TEMP. <u>13.4</u> DEG. F.C SPCON <u>4.500</u> MOHS TURBID. <u>.22</u> NTU'S pH <u>7.20</u> TIME <u>11:26 a.m.</u> HR/MIN <u>9</u> PURGE VOL. _____ GALS.	@ <u>Final</u> GAL. TEMP. <u>12.7</u> DEG. F.C SPCON <u>4.500</u> MOHS TURBID. <u>5.3</u> NTU'S pH <u>7.35</u> TIME _____ HR/MIN _____ PURGE VOL. _____ GALS.	@ _____ GAL. TEMP. _____ DEG. F.C SPCON _____ MOHS TURBID. _____ NTU'S pH _____ TIME _____ HR/MIN _____ PURGE VOL. _____ GALS.

REMARKS/OBSERVATIONS

Init Water QTY clear odorless
Final Water QTY clear sulfide smell
SPLIT with DEC

TIME SAMPLED: 11:37 a.m. DATE: 5/9/85
QA/QC? Y/N MS? MSD? FIELD BLANK? _____
DEC SPLIT? (Y/N) VOA'S, BNA'S, PESTICIDES/PCB'S
PERSON/S PURGING Berkhill, Crockett, Lynch

PERSON/S SAMPLING _____

ANNUAL WELLS

OVERBURDEN

OCCIDENTAL CHEMICAL CORPORATION

GROUNDWATER FIELD SAMPLE/PURGE RECORD

LOVE CANAL LONG TERM MONITORING PROGRAM

STATION # 7130 DATE: 5/1/95
WEATHER NOTES: PTCY CLDY 55° LT NE WIND
VOC LEVEL: AMBIENT 0 HEADSPACE 0-0.1
WELL DEPTH: 28.0 FT. WATER DEPTH: TOW 13.6 FT.
WELL VOLUME: 2.30 GAL. TOTAL VOLUME PURGED 7.5 GAL.
SAMPLE PURGE DATA:

@INITIAL 0 GAL.
TEMP. 12.4° DEG. F. C
SPCON 1500 MOHS
TURBID. NTU'S
pH 7.35
TIME 10:33 AM
HR/MIN 0
PURGE
VOL. GALS.

@INITIAL 2.5 GAL.
TEMP. 11.8° DEG. F. C
SPCON 1100 MOHS
TURBID. NTU'S
pH 7.21
TIME 10:36 AM
HR/MIN 3
PURGE
VOL. GALS.

@INITIAL 5 GAL.
TEMP. 11.9° DEG. F. C
SPCON 1100 MOHS
TURBID. NTU'S
pH 7.28
TIME 11:39
HR/MIN 3
PURGE
VOL. GALS.

@INITIAL 7.5 GAL.
TEMP. 11.9 DEG. F.
SPCON 1100 MOHS
TURBID. NTU'S
pH 7.2
TIME 11:45
HR/MIN 6
PURGE
VOL. GALS.

@INITIAL GAL.
TEMP. DEG. F.
SPCON MOHS
TURBID. NTU'S
pH
TIME
HR/MIN
PURGE
VOL. GALS

SAMPLING
@INITIAL GAL.
TEMP. 12.6 DEG. F.
SPCON 1000 MOHS
TURBID. NTU'S
pH 7.36
TIME 13:55
HR/MIN
PURGE
VOL. GALS

REMARKS/OBSERVATIONS Initial water QTY cloudy, no odor, trace sediment.
Colorless FINAL Clear, colorless, no sheen, no odor

SAMPLING QUALITY: Clear, Colorless, no sheen, no sediment

TIME SAMPLED: 1355 DATE: 5/1/95
QA/QC? Y(N) MS? MSD? FIELD BLANK?
DEC SPLIT? Y/N VOA'S, BNA'S, PESTICIDES/PCB'S PERSON/S
PURGING SP, KPL, DC

PERSON/S SAMPLING SP, KL, DC, MM

Non weighted bailer

OCCIDENTAL CHEMICAL CORPORATION

GROUNDWATER FIELD SAMPLE/PURGE RECORD

LOVE CANAL LONG TERM MONITORING PROGRAM

STATION # 7132 DATE: 5/1/95
WEATHER NOTES: Mostly Cloudy N. Wind
VOC LEVEL: AMBIENT 0 HEADSPACE 0
WELL DEPTH: 28.0 FT. WATER DEPTH: TOW 13.32 FT.
WELL VOLUME: 2.35 GAL. TOTAL VOLUME PURGED 12.0 GAL.
SAMPLE PURGE DATA:

1 hand
@INITIAL 0 GAL.
TEMP. 11.8 DEG. F. C
SPCON 590 MOHS
TURBID. NTU'S
pH 11.27
TIME 2:10 p.m.
HR/MIN 0
PURGE
VOL. GALS.

@INITIAL 2.4 GAL.
TEMP. 11.7 DEG. F. C
SPCON 510 MOHS
TURBID. NTU'S
pH 10.85
TIME 2:13
HR/MIN 3
PURGE
VOL. GALS.

@INITIAL 4.8 GAL.
TEMP. 7.93/12.3 DEG. F.
SPCON 960 MOHS
TURBID. NTU'S
pH 7.93
TIME 2:15 p.m.
HR/MIN 2
PURGE
VOL. GALS.

@INITIAL 7.2 GAL.
TEMP. 12.6 DEG. F. C
SPCON 1050 MOHS
TURBID. NTU'S
pH 7.46
TIME 2:20 p.m.
HR/MIN 4
PURGE
VOL. GALS.

@INITIAL 9.6 GAL.
TEMP. 12.7 DEG. F. C
SPCON 1050 MOHS
TURBID. NTU'S
pH 7.37
TIME 2:26
HR/MIN 6
PURGE
VOL. GALS.

@INITIAL 12.0 GAL.
TEMP. 12.1 DEG. F.
SPCON 1100 MOHS
TURBID. NTU'S
pH 7.36
TIME 2:30 p.m.
HR/MIN 4
PURGE
VOL. GALS.

Final
11°
7
124 in
3:22 p.m.

REMARKS/OBSERVATIONS

Int water QTY Clear Colorless ~~and~~ sulfide odor
Final water QTY - same

TIME SAMPLED: 3:00 p.m. DATE: 5/1/95
QA/QC? Y/N MS? MSD? FIELD BLANK?
DEC SPLIT? Y/N VOA'S, BNA'S, PESTICIDES/PCB'S PERSON/S
PURGING SP min DL KPL

PERSON/S SAMPLING

OCCIDENTAL CHEMICAL CORPORATION

GROUNDWATER FIELD SAMPLE/PURGE RECORD

LOVE CANAL LONG TERM MONITORING PROGRAM

STATION # 9118 DATE: 5/8/95
WEATHER NOTES: Clear, sunny, 50° South Wind
VOC LEVEL: AMBIENT .02 HEADSPACE 0
WELL DEPTH: 35.5 FT. WATER DEPTH: TOW 12.4' FT.
WELL VOLUME: 3.70 GAL. TOTAL VOLUME PURGED 12 GAL.
SAMPLE PURGE DATA:

ck @INITIAL 0 GAL.
TEMP. 9.5 DEG. C
SPCON 1000 MOHS
TURBID. 11.4 NTU'S
pH 7.17
TIME 9:50 Am
HR/MIN _____
PURGE _____
VOL. 0 GALS.

@ 4 GAL.
TEMP. 10.2 DEG. C
SPCON 1000 MOHS
TURBID. 7.8 NTU'S
pH 7.00
TIME 9:57
HR/MIN 7mi
PURGE _____
VOL. 4 GALS.

@ 8 GAL.
TEMP. 10.8 DEG. C
SPCON 1025 MOHS
TURBID. 4.6 NTU'S
pH 7.05
TIME 10:02
HR/MIN 5min
PURGE _____
VOL. 8 GALS.

@ 12 GAL.
TEMP. 11.9 DEG. C
SPCON 1025 MOHS
TURBID. 4.3 NTU'S
pH 7.04
TIME 10:07
HR/MIN 5min
PURGE _____
VOL. 12 GALS.

@ _____ GAL.
TEMP. _____ DEG. C
SPCON _____ MOHS
TURBID. _____ NTU'S
pH _____
TIME _____
HR/MIN _____
PURGE _____
VOL. _____ GALS

@ _____ GAL.
TEMP. 10.83 DEG. C
SPCON 1025 MOHS
TURBID. 11 NTU'S
pH 7.03
TIME 1020
HR/MIN _____
PURGE _____
VOL. - GALS

REMARKS/OBSERVATIONS

Initial - slight cloudy, no odor

FINAL - Sl. Cloudy, no odor

TIME SAMPLED: 1020 DATE: 5/8/95

QA/QC? Y MS? MSD? FIELD BLANK? _____

DEC SPLIT? Y VOA'S, BNA'S, PESTICIDES/PCB'S
PERSON/S PURGING Parkhill, Crockett, Lynch

PERSON/S SAMPLING Parkhill, Crockett, Lynch

OCCIDENTAL CHEMICAL CORPORATION

GROUNDWATER FIELD SAMPLE/PURGE RECORD

LOVE CANAL LONG TERM MONITORING PROGRAM

STATION # 10135 DATE: 6/1/95

WEATHER NOTES: Sunny, Wind

VOC LEVEL: AMBIENT 0.2 HEADSPACE 10.0

WELL DEPTH: 40 FT. WATER DEPTH: TOW 15.55 FT.

WELL VOLUME: 3.91 GAL. TOTAL VOLUME PURGED _____ GAL.

SAMPLE PURGE DATA:

@INITIAL 0 GAL.
TEMP. 19.6 DEG. F.C.
SPCON 2,700 MOHS
TURBID. _____ NTU'S
pH 6.63
TIME 1:45 p.m.
HR/MIN _____
PURGE _____
VOL. 0 GALS.

@ 4 GAL.
TEMP. 18.2 DEG. F.C.
SPCON 2,800 MOHS
TURBID. _____ NTU'S
pH 6.81
TIME 2:10 p.m.
HR/MIN 25
PURGE _____
VOL. 4 GALS.

@ 8 GAL.
TEMP. _____ DEG. F.C.
SPCON _____ MOHS
TURBID. _____ NTU'S
pH _____
TIME _____
HR/MIN _____
PURGE _____
VOL. _____ GALS.

@ _____ GAL.
TEMP. _____ DEG. F.C.
SPCON _____ MOHS
TURBID. _____ NTU'S
pH _____
TIME _____
HR/MIN _____
PURGE _____
VOL. _____ GALS.

@ _____ GAL.
TEMP. _____ DEG. F.C.
SPCON _____ MOHS
TURBID. _____ NTU'S
pH _____
TIME _____
HR/MIN _____
PURGE _____
VOL. _____ GALS.

@ Sample GAL.
TEMP. _____ DEG. F.C.
SPCON _____ MOHS
TURBID. _____ NTU'S
pH _____
TIME _____
HR/MIN _____
PURGE _____
VOL. _____ GALS.

REMARKS/OBSERVATIONS

Jet Water QTY Dark grey nap odor

TIME SAMPLED: _____ DATE: _____

QA/QC? MS? MSD? FIELD BLANK? _____

DEC SPLIT? VOA'S, BNA'S, PESTICIDES/PCB'S _____

PERSON/S PURGING Parkhill, Coxlett

PERSON/S SAMPLING Parkhill, Coxlett

BIANNUAL WELLS

(GROUP I)

1995

OCcidental CHEMICAL CORPORATION

GROUNDWATER FIELD SAMPLE/PURGE RECORD

LOVE CANAL LONG TERM MONITORING PROGRAM

STATION # Well 3151 DATE: 4/13/95
WEATHER NOTES: Partly Cloudy - Clear, 55°
VOC LEVEL: AMBIENT 0.4 HEADSPACE 0
WELL DEPTH: 25.1 FT. WATER DEPTH: TOW 6.6 FT.
WELL VOLUME: 2.9 GAL. TOTAL VOLUME PURGED 5.5 GAL.
SAMPLE PURGE DATA:

@INITIAL 0 GAL.
TEMP. 11.5 DEG. F.
SPCON 1,200 MOHS
TURBID. NTU'S
pH 8.10
TIME 9:00 AM
HR/MIN 0
PURGE
VOL. 3 GALS.

@ 3 GAL.
TEMP. 12.1 DEG. F.
SPCON 1,300 MOHS
TURBID. NTU'S
pH 8.00
TIME 9:08
HR/MIN 8
PURGE
VOL. 3 GALS.

@ 5.5 GAL.
TEMP. 8.32 DEG. F.
SPCON 1,400 MOHS
TURBID. NTU'S
pH 8.05
TIME 9:16
HR/MIN 8
PURGE
VOL. 5.5 GALS.

@ 9 GAL.
TEMP. DEG. F.
SPCON MOHS
TURBID. NTU'S
pH
TIME
HR/MIN
PURGE
VOL. GALS.

@ GAL.
TEMP. DEG. F.
SPCON MOHS
TURBID. NTU'S
pH
TIME
HR/MIN
PURGE
VOL. GALS.

@ Sample GAL.
TEMP. 12.7 DEG. F.
SPCON 650 MOHS
TURBID. NTU'S
pH 7.82
TIME
HR/MIN
PURGE
VOL. GALS.

REMARKS/OBSERVATIONS

Init Sample cloudy brown no color
well went dry at 5.5 GALS
final Qty cloudy no color

TIME SAMPLED: 2:15pm DATE: 5/2/95
QA/QC? Y MS? MSD? FIELD BLANK?
DEC SPLIT? Y/N VOA'S, BNA'S, PESTICIDES/PCB'S
PERSON/S PURGING Crockett, Sullivan
PERSON/S SAMPLING Crockett, Sullivan

OCCIDENTAL CHEMICAL CORPORATION

GROUNDWATER FIELD SAMPLE/PURGE RECORD

25.30 FT
0.16 gal/ft

LOVE CANAL LONG TERM MONITORING PROGRAM

STATION # 7120 DATE: 5/1/95
WEATHER NOTES: PTLY CLDY 50°
VOC LEVEL: AMBIENT 0 HEADSPACE 0
WELL DEPTH: 31.20 FT. WATER DEPTH: TOW 5.90' FT.
WELL VOLUME: 3.75 GAL. TOTAL VOLUME PURGED 12 GAL.
SAMPLE PURGE DATA:

1K →
5.04

@INITIAL 3.75 GAL.
TEMP. 7.48 11.3 DEG. F. C
SPCON 2000 MOHS
TURBID. NA NTU'S
pH 7.48
TIME 10:40am
HR/MIN 0
PURGE
VOL. GALS.

@INITIAL 4 GAL.
TEMP. 11.8 DEG. F. C
SPCON 2000 MOHS
TURBID. NTU'S
pH 7.23
TIME 10:48am
HR/MIN 08
PURGE
VOL. GALS.

@INITIAL 8 GAL.
TEMP. 11.8 DEG. F. C
SPCON 2000 MOHS
TURBID. NTU'S
pH 7.19
TIME 10:55am
HR/MIN 07
PURGE
VOL. GALS.

@INITIAL 12 GAL.
TEMP. 12.6 DEG. F. C
SPCON 2000 MOHS
TURBID. NTU'S
pH 7.84
TIME 11:2am
HR/MIN 17
PURGE
VOL. GALS.

@INITIAL GAL.
TEMP. DEG. F.
SPCON MOHS
TURBID. NTU'S
pH
TIME
HR/MIN
PURGE
VOL. GALS

SAMPLING
@INITIAL GAL.
TEMP. 12.4 DEG. F.
SPCON 1900 MOHS
TURBID. NTU'S
pH 7.34
TIME 1337
HR/MIN
PURGE
VOL. GALS

REMARKS/OBSERVATIONS 'N15 W/L QUALITY CLEAR
DRY AT 3 WELL VOLUMES (12 GALS)
Final water PTY clear, no odor, no solids
Sampling Quality Clear, colorless, no sheen, no odor

TIME SAMPLED: 1330 DATE: 5/1/95
QA/QC? Y MS? MSD? FIELD BLANK?
DEC SPLIT? Y VOA'S, BNA'S, PESTICIDES/PCB'S/PERSON/S
PURGING SP, KPL, DC, MM

PERSON/S SAMPLING KPL, SP, DC, MM

Non weighted bailer

OCCIDENTAL CHEMICAL CORPORATION

GROUNDWATER FIELD SAMPLE/PURGE RECORD

LOVE CANAL LONG TERM MONITORING PROGRAM

STATION # 7155 DATE: 5/1/95
WEATHER NOTES: Cloudy North wind
VOC LEVEL: AMBIENT HEADSPACE
WELL DEPTH: 26.9 FT. WATER DEPTH: TOW 12.42 FT.
WELL VOLUME: 2.3 GAL. TOTAL VOLUME PURGED 6.9 GAL.
SAMPLE PURGE DATA:

@INITIAL 0 GAL.
TEMP. 12.6 DEG. F.C
SPCON 1150 MOHS
TURBID. NTU'S
pH 7.20
TIME 2:44 P.M.
HR/MIN 0
PURGE
VOL. GALS.

@INITIAL 2.3 GAL.
TEMP. 12.6 DEG. F.C
SPCON 1150 MOHS
TURBID. NTU'S
pH 7.15
TIME 2:49
HR/MIN 5
PURGE
VOL. GALS.

@INITIAL 4.6 GAL.
TEMP. 13.0 DEG. F.C
SPCON 1200 MOHS
TURBID. NTU'S
pH 7.18
TIME 2:53 P.M.
HR/MIN 4
PURGE
VOL. GALS.

@INITIAL 6.9 GAL.
TEMP. 12.8 DEG. F.C
SPCON 1250 MOHS
TURBID. NTU'S
pH 7.15
TIME 2:59 P.M.
HR/MIN 6
PURGE
VOL. GALS.

Final
@INITIAL GAL.
TEMP. 12.9 DEG. F.C
SPCON 1800 MOHS
TURBID. NTU'S
pH 7.24
TIME
HR/MIN
PURGE
VOL. GALS

@INITIAL GAL.
TEMP. DEG. F.
SPCON MOHS
TURBID. NTU'S
pH
TIME
HR/MIN
PURGE
VOL. GALS

REMARKS/OBSERVATIONS

Int water QTY cloudy, silt, odorless
Final water QTY clearer, no silt, odorless slight sulfur smell
Final cloudy, sulfide odor

TIME SAMPLED: 15:30 DATE: 5/1/95
QA/QC? Y/N MS? MSD? FIELD BLANK?
DEC SPLIT? Y/N VOA'S, BNA'S, PESTICIDES/PCB'S PERSON/S
PURGING SP, mm, KPL, DC

PERSON/S SAMPLING

OCCIDENTAL CHEMICAL CORPORATION

GROUNDWATER FIELD SAMPLE/PURGE RECORD

LOVE CANAL LONG TERM MONITORING PROGRAM

STATION # 7161 DATE: 5/3/95
WEATHER NOTES: overcast, 60°, North wind
VOC LEVEL: AMBIENT 0.2 HEADSPACE 0.2
WELL DEPTH: 21.5 FT. WATER DEPTH: TOW 14.6 FT.
WELL VOLUME: 1.1 GAL. TOTAL VOLUME PURGED GAL.
SAMPLE PURGE DATA:

1K @INITIAL 0 GAL.
TEMP. 14.2 DEG. C
SPCON 2800 MOHS
TURBID. - NTU'S
pH 6.97
TIME 1:38 pm
HR/MIN -
PURGE
VOL. 0 GALS.

@ 1 GAL.
TEMP. 12.1 DEG. C
SPCON 2750 MOHS
TURBID. - NTU'S
pH 7.02
TIME 1:40
HR/MIN 2
PURGE
VOL. 1 GALS.

@ 2 GAL.
TEMP. 12.1 DEG. C
SPCON 2750 MOHS
TURBID. - NTU'S
pH 7.04
TIME 1:42
HR/MIN 2
PURGE
VOL. 2 GALS.

@ 3 GAL.
TEMP. 13.4 DEG. C
SPCON 2650 MOHS
TURBID. - NTU'S
pH 7.03
TIME 1:45
HR/MIN 3
PURGE
VOL. 3 GALS.

@ GAL.
TEMP. DEG. F.
SPCON MOHS
TURBID. NTU'S
pH
TIME
HR/MIN
PURGE
VOL. GALS

@ Sample GAL.
TEMP. 13.0 DEG. F.
SPCON 2300 MOHS
TURBID. - NTU'S
pH 6.79
TIME 2:00
HR/MIN -
PURGE
VOL. - GALS

REMARKS/OBSERVATIONS

Initial w/c - Brown color, no odor
Final w/c - Brown, no odor

TIME SAMPLED: 1400 DATE: 5/3/95
QA/QC? Y MS? MSD? FIELD BLANK?
DEC SPLIT? Y/N VOA'S, BNA'S, PESTICIDES/PCB'S
PERSON/S PURGING Crockett, Sullivan, Parkhill
PERSON/S SAMPLING Crockett, Sullivan, Parkhill

OCCIDENTAL CHEMICAL CORPORATION

GROUNDWATER FIELD SAMPLE/PURGE RECORD

LOVE CANAL LONG TERM MONITORING PROGRAM

STATION # 8110 DATE: 5/4/95
WEATHER NOTES: Clear, NE wind
VOC LEVEL: AMBIENT 0.02 HEADSPACE 0
WELL DEPTH: 29.0 FT. WATER DEPTH: TOW 10.11 FT.
WELL VOLUME: 2.7 GAL. TOTAL VOLUME PURGED 9 GAL.

SAMPLE PURGE DATA:

@INITIAL 0 GAL.
TEMP. 13.4 DEG. C
SPCON 910 MOHS
TURBID. 1.5 NTU'S
pH 7.08
TIME 11:25
HR/MIN 0
PURGE
VOL. 0 GALS.

@ 3 GAL.
TEMP. 12.0 DEG. C
SPCON 990 MOHS
TURBID. 1.5 NTU'S
pH 6.96
TIME 11:21
HR/MIN 6min
PURGE
VOL. 3 GALS.

@ 6 GAL.
TEMP. 12.7 DEG. C
SPCON 990 MOHS
TURBID. 1.3 NTU'S
pH 6.99
TIME 11:27
HR/MIN 6min
PURGE
VOL. 6 GALS.

@ 9 GAL.
TEMP. 14.2 DEG. C
SPCON 990 MOHS
TURBID. 2.9 NTU'S
pH 7.14
TIME 11:39
HR/MIN 12min
PURGE
VOL. 9 GALS.

@ GAL.
TEMP. DEG. C
SPCON MOHS
TURBID. NTU'S
pH
TIME
HR/MIN
PURGE
VOL. GALS

@ Sample GAL.
TEMP. 13.6 DEG. C
SPCON 990 MOHS
TURBID. 7.5 NTU'S
pH 7.27
TIME 11:50
HR/MIN
PURGE
VOL. GALS

REMARKS/OBSERVATIONS

Initial - clear - no odor
Final - level dropped - brown, cloudy

TIME SAMPLED: 11:50 AM DATE: 5/4/95
QA/QC? Y MS? MSD? FIELD BLANK?
DEC SPLIT? Y VOA'S, BNA'S, PESTICIDES/PCB'S
PERSON/S PURGING Parkhill, Crockett, Lynch
PERSON/S SAMPLING Parkhill, Lynch

OCCIDENTAL CHEMICAL CORPORATION

GROUNDWATER FIELD SAMPLE/PURGE RECORD

LOVE CANAL LONG TERM MONITORING PROGRAM

STATION # 8120 DATE: 5/4/95
WEATHER NOTES: clear, 60, NE wind
VOC LEVEL: AMBIENT .02 HEADSPACE -
WELL DEPTH: 29.2 FT. WATER DEPTH: TOW 8.37 FT.
WELL VOLUME: 7.3 GAL. TOTAL VOLUME PURGED 10.5 GAL.
SAMPLE PURGE DATA:

1K @INITIAL 0 GAL.
TEMP. 12.9 DEG. C
SPCON 2200 MOHS
TURBID. 3.0 NTU'S
pH 7.20
TIME 12:05
HR/MIN 0
PURGE
VOL. 0 GALS.

@ 3.5 GAL.
TEMP. 13.8 DEG. C
SPCON 2100 MOHS
TURBID. .65 NTU'S
pH 7.14
TIME 12:40 p.m.
HR/MIN 9
PURGE
VOL. 3.5 GALS.

@ 7.0 GAL.
TEMP. 15.5 DEG. C
SPCON 2000 MOHS
TURBID. 6.0 NTU'S
pH 7.29
TIME 12:23 p
HR/MIN 9
PURGE
VOL. 7.0 GALS.

@ 10.5 GAL.
TEMP. 19.1 DEG. C
SPCON 2150 MOHS
TURBID. 5 NTU'S
pH 7.15
TIME 12:34 p
HR/MIN 9
PURGE
VOL. 10.5 GALS.

@ final GAL.
TEMP. 15.7 DEG. C
SPCON 2200 MOHS
TURBID. 2.7 NTU'S
pH 7.31
TIME 2:00 p.m.
HR/MIN
PURGE
VOL. GALS

@ GAL.
TEMP. DEG. C
SPCON MOHS
TURBID. NTU'S
pH
TIME
HR/MIN
PURGE
VOL. GALS

REMARKS/OBSERVATIONS INITIAL W/O. Clear, colorless, no sheen, no odor
Final P/B from the brown trace sediments

TIME SAMPLED: DATE:
QA/QC? YES MS? MSD? FIELD BLANK?
DEC SPLIT? YES VOA'S, BNA'S, PESTICIDES/PCB'S
PERSON/S PURGING Parkhill, Crockett, Lynch

PERSON/S SAMPLING

OCCIDENTAL CHEMICAL CORPORATION

GROUNDWATER FIELD SAMPLE/PURGE RECORD

LOVE CANAL LONG TERM MONITORING PROGRAM

STATION # 8130 DATE: 5/5/95
WEATHER NOTES: clear, 50°, Wind Southeast
VOC LEVEL: AMBIENT .02 HEADSPACE Ø
WELL DEPTH: 20.2 FT. WATER DEPTH: TOW 14.35 FT.
WELL VOLUME: 2.5 GAL. TOTAL VOLUME PURGED 7.5 GAL.
SAMPLE PURGE DATA:

1K
@INITIAL Ø GAL.
TEMP. 12.7 DEG. °C
SPCON 1600 MOHS
TURBID. 60 NTU'S
pH 7.00
TIME 9:05 Am
HR/MIN —
PURGE
VOL. Ø GALS.

@ 2.5 GAL.
TEMP. 12.3 DEG. °C
SPCON 1800 MOHS
TURBID. 14.00 NTU'S
pH 6.94
TIME 9:10
HR/MIN 5 min
PURGE
VOL. 2.5 GALS.

@ 5.0 GAL.
TEMP. 12.1 DEG. °C
SPCON 1900 MOHS
TURBID. 3.5 NTU'S
pH 6.98
TIME 9:15
HR/MIN 5 min
PURGE
VOL. 5.0 GALS.

@ 7.5 GAL.
TEMP. 11.7 DEG. °C
SPCON 2000 MOHS
TURBID. 3.0 NTU'S
pH 7.03
TIME 9:19
HR/MIN 4 min
PURGE
VOL. 7.5 GALS.

@ GAL.
TEMP. DEG. °C
SPCON MOHS
TURBID. NTU'S
pH
TIME
HR/MIN
PURGE
VOL. GALS

@ Sample GAL.
TEMP. 10.9 DEG. °C
SPCON 1650 MOHS
TURBID. 5.6 NTU'S
pH 6.86
TIME 9:20 Am
HR/MIN
PURGE
VOL. GALS

REMARKS/OBSERVATIONS

Initial - brown, no odor, silty
Final - clear, no odor

TIME SAMPLED: 9:30 Am DATE: 5/5/95
QA/QC? Y MS? MSD? FIELD BLANK?
DEC SPLIT? Y VOA'S, BNA'S, PESTICIDES/PCB'S
PERSON/S PURGING Parkhill, Crackett, Foulke

PERSON/S SAMPLING Parkhill, Crackett, Foulke

OCCIDENTAL CHEMICAL CORPORATION

GROUNDWATER FIELD SAMPLE/PURGE RECORD

LOVE CANAL LONG TERM MONITORING PROGRAM

STATION # 8140 DATE: 5/5/91
WEATHER NOTES: clear, 55, wind southerly
VOC LEVEL: AMBIENT .02 HEADSPACE 0
WELL DEPTH: 32.0 FT. WATER DEPTH: TOW: 10.9 FT.
WELL VOLUME: 3.4 GAL. TOTAL VOLUME PURGED GAL.
SAMPLE PURGE DATA:

@INITIAL 0 GAL.
TEMP. 12.9 DEG. C
SPCON 900 MOHS
TURBID. .9 NTU'S
pH 7.85
TIME 9:47
HR/MIN -
PURGE
VOL. 0 GALS.

@ 3.4 GAL.
TEMP. 12.6 DEG. C
SPCON 900 MOHS
TURBID. .2 NTU'S
pH 7.63
TIME 9:50
HR/MIN 7min
PURGE
VOL. 3.4 GALS.

@ 6.8 GAL.
TEMP. 13.1 DEG. C
SPCON 900 MOHS
TURBID. 4.6 NTU'S
pH 7.59
TIME 10:50 AM
HR/MIN 11
PURGE
VOL. 6.8 GALS.

@ 10.2 GAL.
TEMP. 12.8 DEG. C
SPCON 850 MOHS
TURBID. 24 NTU'S
pH 7.56
TIME 11:09
HR/MIN -
PURGE
VOL. 10.2 GALS.

@ GAL.
TEMP. DEG. C
SPCON MOHS
TURBID. NTU'S
pH
TIME
HR/MIN
PURGE
VOL. GALS

@ Sample GAL.
TEMP. 12.9 DEG. C
SPCON 900 MOHS
TURBID. 23 NTU'S
pH 7.59
TIME 11:15 AM
HR/MIN
PURGE
VOL. GALS

REMARKS/OBSERVATIONS

Initial - clear, no odor
Final - slight brown cloudy
Stopped @ 1/2 volume to let well recharge
Hand Packed final volumes
TIME SAMPLED: 11:15 DATE: 5/5/91
QA/QC? Y MS? MSD? FIELD BLANK?
DEC SPLIT? Y VOA'S, BNA'S, PESTICIDES/PCB'S
PERSON/S PURGING Parkhill, Crockett, Foulke
PERSON/S SAMPLING Parkhill, Crockett, Foulke

OCCIDENTAL CHEMICAL CORPORATION

GROUNDWATER FIELD SAMPLE/PURGE RECORD

LOVE CANAL LONG TERM MONITORING PROGRAM

STATION # 9110 DATE: 5/5/95
WEATHER NOTES: Clear, 55°, wind southeast
VOC LEVEL: AMBIENT .02 HEADSPACE .02
WELL DEPTH: 24.5 FT. WATER DEPTH: TOW 12.65 FT.
WELL VOLUME: 1.9 GAL. TOTAL VOLUME PURGED 6 GAL.
SAMPLE PURGE DATA:

@ INITIAL 0 GAL.
TEMP. 12.9 DEG. C
SPCON 950 MOHS
TURBID. 88 NTU'S
pH 7.3
TIME 10:12
HR/MIN
PURGE
VOL. 0 GALS.

@ 2 GAL.
TEMP. 12.1 DEG. C
SPCON 950 MOHS
TURBID. 3.7 NTU'S
pH 7.3
TIME 10:15
HR/MIN 3 min
PURGE
VOL. 2 GALS.

@ 4 GAL.
TEMP. 11.3 DEG. C
SPCON 950 MOHS
TURBID. 24 NTU'S
pH 7.36
TIME 10:18
HR/MIN 3 min
PURGE
VOL. 4 GALS.

@ 6 GAL.
TEMP. 11.5 DEG. C
SPCON 950 MOHS
TURBID. 77 NTU'S
pH 7.48
TIME 10:21
HR/MIN 3 min
PURGE
VOL. 6 GALS.

@ GAL.
TEMP. DEG. C
SPCON MOHS
TURBID. NTU'S
pH
TIME
HR/MIN
PURGE
VOL. GALS

@ 5 min GAL.
TEMP. 12.0 DEG. C
SPCON 950 MOHS
TURBID. 119 NTU'S
pH 7.35
TIME 10:30 AM
HR/MIN
PURGE
VOL. GALS

REMARKS/OBSERVATIONS

Initial - brown cloudy, no odor
Final - brown, cloudy no odor

TIME SAMPLED: 10:30 am DATE: 5/5/95
QA/QC? Y MS? MSD FIELD BLANK?
DEC SPLIT? Y VOA'S, BNA'S, PESTICIDES/PCB'S
PERSON/S PURGING Partida, Crockett, Foulke
PERSON/S SAMPLING Partida, Crockett, Foulke

OCCIDENTAL CHEMICAL CORPORATION

GROUNDWATER FIELD SAMPLE/PURGE RECORD

LOVE CANAL LONG TERM MONITORING PROGRAM

STATION # 9115 DATE: 5/8/95
WEATHER NOTES: clear, sunny, 50°, South Wind
VOC LEVEL: AMBIENT .02 HEADSPACE .0
WELL DEPTH: 19.5 FT. WATER DEPTH: TOW 7.94 FT.
WELL VOLUME: 1.85 GAL. TOTAL VOLUME PURGED 6 GAL.
SAMPLE PURGE DATA:

lk @INITIAL 0 GAL.
TEMP. 7.4 DEG. C
SPCON 1050 MOHS
TURBID. — NTU'S
pH 6.98
TIME 9:00
HR/MIN —
PURGE
VOL. 0 GALS.

@ 2 GAL.
TEMP. 7.9 DEG. C
SPCON 1050 MOHS
TURBID. 16 NTU'S
pH 7.05
TIME 9:05
HR/MIN 2
PURGE
VOL. 2 GALS.

@ 4 GAL.
TEMP. 7.8 DEG. C
SPCON 1050 MOHS
TURBID. 2.5 NTU'S
pH 7.05
TIME 9:07
HR/MIN 2
PURGE
VOL. 4 GALS.

@ 6 GAL.
TEMP. 8.2 DEG. C
SPCON 1050 MOHS
TURBID. 2.8 NTU'S
pH 7.05
TIME 9:09
HR/MIN 2
PURGE
VOL. 6 GALS.

@ — GAL.
TEMP. — DEG. C
SPCON — MOHS
TURBID. — NTU'S
pH —
TIME —
HR/MIN —
PURGE
VOL. — GALS

@ Sample GAL.
TEMP. 8.9 DEG. C
SPCON 1050 MOHS
TURBID. 2.5 NTU'S
pH 7.06
TIME —9:20AM
HR/MIN —
PURGE
VOL. — GALS

REMARKS/OBSERVATIONS
Fine - black, low odor
Fine - grey, no odor

TIME SAMPLED: 9:20 AM DATE: 5/8/95
QA/QC? Y/N MS? MSD? (FIELD BLANK) 12015
DEC SPLIT? Y VOA'S, BNA'S, PESTICIDES/PCB'S
PERSON/S PURGING Parthill, Crockett, Lynch
PERSON/S SAMPLING Parthill, Crockett, Lynch

OCcidental CHEMICAL CORPORATION

GROUNDWATER FIELD SAMPLE/PURGE RECORD

LOVE CANAL LONG TERM MONITORING PROGRAM

STATION # 9120 DATE: 5/12/95
WEATHER NOTES: cl. dy. w/ wind
VOC LEVEL: AMBIENT .2 HEADSPACE .2
WELL DEPTH: 6.66 FT. WATER DEPTH: TOW 6.66 FT.
WELL VOLUME: 2.3 GAL. TOTAL VOLUME PURGED 2.3 GAL.
SAMPLE PURGE DATA: 8.0

IK @INITIAL — GAL.
TEMP. 10.7 DEG. F. C
SPCON 1,200 MOHS
TURBID. 4.5 NTU'S
pH 7.5
TIME 9:50
HR/MIN —
PURGE
VOL. — GALS.

@ 2.5 GAL.
TEMP. 9.5 DEG. F. C
SPCON 1,200 MOHS
TURBID. 3.7 NTU'S
pH 7.45
TIME 9:53
HR/MIN 5
PURGE
VOL. 2.5 GALS.

@ 5 GAL.
TEMP. 7.9 DEG. F. C
SPCON 1,200 MOHS
TURBID. 7.0 NTU'S
pH 7.48
TIME 10:06A
HR/MIN 7
PURGE
VOL. 2.5 GALS.

@ 7.5 GAL.
TEMP. 10.1 DEG. F. C
SPCON 1,200 MOHS
TURBID. 18.9 NTU'S
pH 7.38
TIME 10:07A
HR/MIN 3
PURGE
VOL. 8.0 GALS.

@ final GAL.
TEMP. 10.1 DEG. F.
SPCON 1,200 MOHS
TURBID. 18.9 NTU'S
pH 7.39
TIME 10:10A
HR/MIN —
PURGE
VOL. — GALS.

SAMPLING
@ — GAL.
TEMP. 10.7 DEG. F. C
SPCON 1100 MOHS
TURBID. 46 NTU'S
pH 7.41
TIME 1020
HR/MIN —
PURGE
VOL. — GALS.

REMARKS/OBSERVATIONS
Init water @ 9:50 odorless, clear
final water @ 10:10 odorless, clear
SAMPLING @ 10:20 cloudy & brown, no odor, no sludge

TIME SAMPLED: 1020 DATE: 5/12/95
QA/QC? Y/N (MS?) (MSD?) FIELD BLANK?
DEC SPLIT? Y/N (N) VOA'S, BNA'S, PESTICIDES/PCB'S
PERSON/S PURGING Sullivan, Crockett
PERSON/S SAMPLING Sullivan, Crockett, Lynch

OCCIDENTAL CHEMICAL CORPORATION

GROUNDWATER FIELD SAMPLE/PURGE RECORD

LOVE CANAL LONG TERM MONITORING PROGRAM

17.75'

STATION # 9125 DATE: 5/12/95
WEATHER NOTES: Overcast, 50°
VOC LEVEL: AMBIENT 0.3 HEADSPACE 0.3
WELL DEPTH: 26.0 FT. WATER DEPTH: TOW 8.26 FT.
WELL VOLUME: 2.8 GAL. TOTAL VOLUME PURGED GAL.
SAMPLE PURGE DATA:

1x @INITIAL 0 GAL.
TEMP. 9.9 DEG. F.
SPCON 1,800 MOHS
TURBID. 0.8 NTU'S
pH 7.06
TIME 10:40
HR/MIN 1
PURGE
VOL. 3 GALS.

@ 3 GAL.
TEMP. 9.8 DEG. F.
SPCON 1,700 MOHS
TURBID. .85 NTU'S
pH 7.18
TIME 10:49 A
HR/MIN 9
PURGE
VOL. 3 GALS.

@ 6 GAL.
TEMP. 9.6 DEG. F.
SPCON 1,700 MOHS
TURBID. 14.1 NTU'S
pH 7.33
TIME 10:55
HR/MIN 6
PURGE
VOL. 3 GALS.

@ 9 GAL.
TEMP. 10.2 DEG. F.
SPCON 1,700 MOHS
TURBID. 17.5 NTU'S
pH 7.3
TIME 10:59
HR/MIN 4
PURGE
VOL. 3 GALS.

@ Final GAL.
TEMP. DEG. F.
SPCON MOHS
TURBID. NTU'S
pH
TIME
HR/MIN
PURGE
VOL. GALS

SAMPLING
@ - GAL.
TEMP. 10.3 DEG. F.
SPCON 1,600 MOHS
TURBID. NM * 55 NTU'S
pH 7.18
TIME 11:15
HR/MIN
PURGE
VOL. - GALS

* Turbidity meter inoper.

REMARKS/OBSERVATIONS
Initial water @ top clear & odorless,
starting to cloud up during purge ~ 6 gal
Sample - cloudy - brown, no sheen, no odor

TIME SAMPLED: 1115 DATE: 5/12/95
QA/QC? Y/N MS? MSD? FIELD BLANK?
DEC SPLIT? Y/N VOA'S, BNA'S, PESTICIDES/PCB'S
PERSON/S PURGING Crockett, Lynch
PERSON/S SAMPLING Crockett, Lynch

OCCIDENTAL CHEMICAL CORPORATION

GROUNDWATER FIELD SAMPLE/PURGE RECORD

LOVE CANAL LONG TERM MONITORING PROGRAM

STATION # 9140 DATE: 5/12/95
WEATHER NOTES: Overcast 55°
VOC LEVEL: AMBIENT 0.3 HEADSPACE 0.3
WELL DEPTH: 29.4 FT. WATER DEPTH: TOW 8.44 FT.
WELL VOLUME: 3.35 GAL. TOTAL VOLUME PURGED _____ GAL.
SAMPLE PURGE DATA:

<u>0</u> GAL. TEMP. <u>20.5</u> DEG. <u>X</u> C SPCON <u>2,100</u> MOHS TURBID. <u>32.3</u> NTU'S pH <u>6.82</u> TIME <u>1:20 P</u> HR/MIN <u>—</u> PURGE VOL. <u>3.5</u> GALS.	<u>3.5</u> GAL. TEMP. <u>12.5</u> DEG. <u>K</u> C SPCON <u>2,000</u> MOHS TURBID. <u>4.0</u> NTU'S pH <u>6.87</u> TIME <u>1:27 P</u> HR/MIN <u>7</u> PURGE VOL. <u>3.5</u> GALS.	<u>7.0</u> GAL. TEMP. <u>13.4</u> DEG. <u>K</u> C SPCON <u>2,000</u> MOHS TURBID. <u>1.7</u> NTU'S pH <u>6.87</u> TIME <u>1:39 P</u> HR/MIN <u>12</u> PURGE VOL. <u>3.5</u> GALS.
<u>10.5</u> GAL. TEMP. <u>13.4</u> DEG. <u>X</u> C SPCON <u>2,000</u> MOHS TURBID. <u>7.2</u> NTU'S pH <u>6.91</u> TIME <u>1:56 P</u> HR/MIN <u>17</u> PURGE VOL. <u>3.5</u> GALS.	<u>final</u> GAL. TEMP. <u>13.2</u> DEG. <u>F</u> SPCON <u>2,000</u> MOHS TURBID. <u>NM</u> NTU'S pH <u>6.94</u> TIME <u>2:08 P</u> HR/MIN <u>12</u> PURGE VOL. <u>—</u> GALS	<u>—</u> GAL. TEMP. _____ DEG. <u>X</u> C SPCON _____ MOHS TURBID. _____ NTU'S pH _____ TIME _____ HR/MIN _____ PURGE VOL. _____ GALS

REMARKS/OBSERVATIONS

Int Water (pt) Cloudy, muddy, no odor
final " " muddy, no odor

Rinse Blanked Boiler used to sample this well
* Battery failure on Turbidimeter

TIME SAMPLED: 1400 DATE: 5/12/95

QA/QC? Y/N MS? MSD? FIELD BLANK? _____

DEC SPLIT? Y/N VOA'S, BNA'S, PESTICIDES/PCB'S _____

PERSON/S PURGING PARKHILL, CROCKETT, LYNCH

PERSON/S SAMPLING PARKHILL, CROCKETT, LYNCH

OCCIDENTAL CHEMICAL CORPORATION

GROUNDWATER FIELD SAMPLE/PURGE RECORD

LOVE CANAL LONG TERM MONITORING PROGRAM

STATION # 10113 DATE: 5/12/95
WEATHER NOTES: Overcast 55°F
VOC LEVEL: AMBIENT 0.2 HEADSPACE 0.2
WELL DEPTH: 5.57 FT. WATER DEPTH: TOW 5.57 FT.
WELL VOLUME: 3.57 GAL. TOTAL VOLUME PURGED GAL.
SAMPLE PURGE DATA:

@INITIAL 0 GAL.
TEMP. 12.6 DEG. C
SPCON 2,000 MOHS
TURBID. 15.0 NTU'S
pH 7.16
TIME 2:24p
HR/MIN -
PURGE
VOL. 3.6 GALS.

@ 3.6 GAL.
TEMP. 11.7 DEG. C
SPCON 2,100 MOHS
TURBID. 3.5 NTU'S
pH 7.00
TIME 2:30p.m.
HR/MIN 6
PURGE
VOL. 3.6 GALS.

@ 7.2 GAL.
TEMP. 10.4 DEG. C
SPCON 2,100 MOHS
TURBID. 3.5 NTU'S
pH 6.99
TIME 1436
HR/MIN 6
PURGE
VOL. 3.6 GALS.

@ 10.4 GAL.
TEMP. 13.8 DEG. C
SPCON 1,200 MOHS
TURBID. 8.0 NTU'S
pH 7.01
TIME 2:46p.m.
HR/MIN 10
PURGE
VOL. 3.6 GALS.

@ Final GAL.
TEMP. 13.9 DEG. C
SPCON 2,100 MOHS
TURBID. NTU'S
pH 7.13
TIME 14:58
HR/MIN
PURGE
VOL. GALS.

@ GAL.
TEMP. DEG. F.
SPCON MOHS
TURBID. NTU'S
pH
TIME
HR/MIN
PURGE
VOL. GALS

REMARKS/OBSERVATIONS Possible bright orange rust of Fluorim-pant
Well was sawed
Int well water. Slight brown color odorless
Final W/Q - Sampling - 5.1. Cldy, Lt. brown, no odor, no stain

TIME SAMPLED: 1455 DATE: 5/12/95
QA/QC? Y/N MS? MSD? FIELD BLANK?
DEC SPLIT? Y/N VOA'S, BNA'S, PESTICIDES/PCB'S
PERSON/S PURGING
PERSON/S SAMPLING Packhill, Coakett, Lynch

OCCIDENTAL CHEMICAL CORPORATION

GROUNDWATER FIELD SAMPLE/PURGE RECORD

LOVE CANAL LONG TERM MONITORING PROGRAM

STATION # 10147 DATE: 5/17/95
WEATHER NOTES: Overcast/Lt. Rain SW Wind
VOC LEVEL: AMBIENT 0.1 HEADSPACE 0.1
WELL DEPTH: 30.9 FT. WATER DEPTH: TOW 6.40' FT.
WELL VOLUME: 3.92 GAL. TOTAL VOLUME PURGED 12 GAL.
SAMPLE PURGE DATA:

@INITIAL 0 GAL.
TEMP. 12.3 DEG. F.
SPCON 1400 MOHS
TURBID. No particle NTU'S
pH 7.06
TIME 1356
HR/MIN —
PURGE
VOL. 0 GALS.

@ 4 GAL.
TEMP. 12.5 DEG. F.
SPCON 1200 MOHS
TURBID. NM NTU'S
pH 7.20
TIME 1406
HR/MIN 10
PURGE
VOL. 4 GALS.

@ 8 GAL.
TEMP. 13.2 DEG. F.
SPCON 1200 MOHS
TURBID. NM NTU'S
pH 7.28
TIME 1429
HR/MIN 23
PURGE
VOL. 8 GALS.

@ 12 GAL.
TEMP. 14.8 DEG. F. K
SPCON 1300 MOHS
TURBID. NM NTU'S
pH 7.59
TIME 1457
HR/MIN 28
PURGE
VOL. 12 GALS.

@ — GAL.
TEMP. — DEG. F.
SPCON — MOHS
TURBID. — NTU'S
pH —
TIME —
HR/MIN —
PURGE
VOL. — GALS.

@ sample GAL.
TEMP. 14.7 DEG. F.
SPCON 1150 MOHS
TURBID. — NTU'S
pH 7.56
TIME —
HR/MIN —
PURGE
VOL. — GALS.

REMARKS/OBSERVATIONS Little fine quartz sand from bottom of well -
Pumping rate drops off sharply after first volume removed.
Fine brown red silt, no odor

TIME SAMPLED: 7:00 pm DATE: 5/17/95
QA/QC? Y/N MS? MSD? FIELD BLANK? —
DEC SPLIT? Y/N VOA'S, BNA'S, PESTICIDES/PCB'S —
PERSON/S PURGING Pro White, Lynch, Condit
PERSON/S SAMPLING Pro White, Lynch, Condit

OCCIDENTAL CHEMICAL CORPORATION

GROUNDWATER FIELD SAMPLE/PURGE RECORD

LOVE CANAL LONG TERM MONITORING PROGRAM

STATION # 10174B DATE: 5/7/95
WEATHER NOTES: Overcast, 50 West...
VOC LEVEL: AMBIENT HEADSPACE
WELL DEPTH: 2.5 FT. WATER DEPTH: TOW 8.1 FT.
WELL VOLUME: 24 GAL. TOTAL VOLUME PURGED GAL.
SAMPLE PURGE DATA:

@ INITIAL 0 GAL.
TEMP. 12.4 DEG. C
SPCON: 10 MOHS
TURBID. 1.5 NTU'S
pH 7.53
TIME 10:43A
HR/MIN
PURGE
VOL. 0 GALS.

@ 2.5 GAL.
TEMP. 11.8 DEG. C
SPCON 100 MOHS
TURBID. NTU'S
pH 7.54
TIME 10:46A
HR/MIN 3
PURGE
VOL. 2.5 GALS.

@ 5.0 GAL.
TEMP. DEG. F.
SPCON MOHS
TURBID. NTU'S
pH
TIME
HR/MIN
PURGE
VOL. 5.0 GALS.

@ 7.5 GAL.
TEMP. DEG. C
SPCON MOHS
TURBID. NTU'S
pH
TIME
HR/MIN
PURGE
VOL. 7.5 GALS.

@ GAL.
TEMP. DEG. C
SPCON MOHS
TURBID. NTU'S
pH
TIME
HR/MIN
PURGE
VOL. GALS

@ GAL.
TEMP. DEG. F.
SPCON MOHS
TURBID. NTU'S
pH
TIME
HR/MIN
PURGE
VOL. GALS

REMARKS/OBSERVATIONS
Int water qty (clear) no odor
well vent okay
F... - C

TIME SAMPLED: 12:00 DATE:
QA/QC? Y(N) MS? MSD? FIELD BLANK?
DEC SPLIT? Y/N VOA'S, BNA'S, PESTICIDES/PCB'S
PERSON/S PURGING Person: C...

PERSON/S SAMPLING

BIANNUAL WELLS

(GROUP II)

1994

NEW YORK STATE DEPARTMENT OF ENVIRONMENTAL CONSERVATION

GROUNDWATER FIELD SAMPLE/PURGE RECORD

LOVE CANAL LONG TERM MONITORING PROGRAM

STATION # / LOCATION MW 8115 DATE 5/10/94

FIELD DATA TIME: START 12:55 END 1:50

WEATHER NOTES: 80% Overcast sprinkles eclipse

VOA LEVEL: ambient 0 headspace 0

WELL DEPTH: 28.5 ft. WATER DEPTH: Top of well 6.55 ft.

WELL VOLUME: 3.6 gal. TOTAL VOLUME PURGED 15.0 gal.

SAMPLE PURGE DATA:

@ <u>1</u> well volume(s)	@ <u>2</u> well volumes
TEMP. <u>50.8</u> deg. F.	TEMP. <u>50.0</u> deg. F.
SP. COND. <u>1525</u> mohms	SP. COND. <u>1525</u> mohms
pH <u>7.1</u>	pH <u>7.2</u>
TIME <u>1:02</u>	TIME <u>1:13</u>
HR/MIN <u>2</u>	HR/MIN <u>8</u>
PURGE VOL. <u>-</u> gal.	PURGE VOL. <u>7.2</u> gal.

@ <u>3</u> well volumes	@ <u> </u> well volumes	@ <u> </u> well volumes
TEMP. <u>50.2</u> deg. F.	TEMP. <u> </u> deg. F.	TEMP. <u> </u> deg. F.
SP. COND. <u>1500</u> mohms	SP. COND. <u> </u> mohms	SP. COND. <u> </u> mohms
pH <u>8.0</u>	pH <u> </u>	pH <u> </u>
TIME <u>1:25</u>	TIME <u> </u>	TIME <u> </u>
HR/MIN <u>12</u>	HR/MIN <u> </u>	HR/MIN <u> </u>
PURGE VOL. <u>10.6</u> gal.	PURGE VOL. <u> </u> gal.	PURGE VOL. <u> </u> gal.

REMARKS/OBSERVATIONS water - fast 1st purge and muddy
up. - Put New MC Inflex hose to final purge.
Best time to do this well - now did not
so dry even after purging.

TIME SAMPLED: 1205 DATE: 5/11/94

QA/QC? Y N MS? MSD? FIELD BLANK? *
DOH SPLIT? N: - VOA? LCIC'S? OTHER? **

*WHAT TYPE OF BLANK? glove rinse, pump rinse, tubing rinse, D.I. H2O, bailer, rinse.

**DESCRIBE SPLIT: whole sample to DOH

PERSON/S PURGING Marius Mor

PERSON/S SAMPLING Marius Mor (OVER)

NEW YORK STATE DEPARTMENT OF ENVIRONMENTAL CONSERVATION

GROUNDWATER FIELD SAMPLE/PURGE RECORD

LOVE CANAL LONG TERM MONITORING PROGRAM

STATION # / LOCATION MW 8125 DATE 5/16/94

FIELD DATA TIME: START 2:00 END 2:30

WEATHER NOTES: cold 46° windy 15-20; low clouds

VOA LEVEL: ambient 0 headspace ()

WELL DEPTH: 27.5 ft. WATER DEPTH: Top of well 12.74 ft.

WELL VOLUME: 2.4 gal. TOTAL VOLUME PURGED 9.2 gal.

SAMPLE PURGE DATA:

@initial <u> </u> gal.	@ <u>1</u> well volume(s)	@ <u>2</u> well volumes
TEMP. <u>48.4</u> deg. F.	TEMP. <u>49.6</u> deg. F.	TEMP. <u>50.8</u> deg. F.
SP. COND. <u>1675</u> mohms	SP. COND. <u>1900</u> mohms	SP. COND. <u>2000</u> mohms
pH <u>7.7</u>	pH <u>7.7</u>	pH <u>7.6</u>
TIME <u>2:00</u>	TIME <u>2:05</u>	TIME <u>2:12</u>
HR/MIN <u> </u>	HR/MIN <u> </u>	HR/MIN <u>7</u>
PURGE VOL. <u> </u> gal.	PURGE VOL. <u>2.4</u> gal.	PURGE VOL. <u>4.8</u> gal.

@ <u>3</u> well volumes	@ <u> </u> well volumes	@ <u> </u> well volumes
TEMP. <u>51.1</u> deg. F.	TEMP. <u> </u> deg. F.	TEMP. <u> </u> deg. F.
SP. COND. <u>2050</u> mohms	SP. COND. <u> </u> mohms	SP. COND. <u> </u> mohms
pH <u>7.6</u>	pH <u> </u>	pH <u> </u>
TIME <u>2:25</u>	TIME <u> </u>	TIME <u> </u>
HR/MIN <u>12</u>	HR/MIN <u> </u>	HR/MIN <u> </u>
PURGE VOL. <u>7.2</u> gal.	PURGE VOL. <u> </u> gal.	PURGE VOL. <u> </u> gal.

REMARKS/OBSERVATIONS RISER IS too high to sample well its A PAIN.

TIME SAMPLED: 1210 DATE: 5/14/94

QA/QC? Y/ N? MS? MSD? FIELD BLANK? *
DOH SPLIT? N? VOA? LCIC'S? OTHER? **

*WHAT TYPE OF BLANK? glove rinse, pump rinse, tubing rinse, D.I. H2O, bailer rinse.

**DESCRIBE SPLIT: whole sample to DOH

PERSON/S PURGING None

PERSON/S SAMPLING None (OVER)

NEW YORK STATE DEPARTMENT OF ENVIRONMENTAL CONSERVATION

GROUNDWATER FIELD SAMPLE/PURGE RECORD

LOVE CANAL LONG TERM MONITORING PROGRAM

STATION # / LOCATION MW 9105 DATE 5/18/94

FIELD DATA TIME: START 12:45 END 1:31

WEATHER NOTES: cold 46° overcast 100% Windy 15-25

VOA LEVEL: ambient 0 headspace 0

WELL DEPTH: 29.4 ft. WATER DEPTH: Top of well 8.95 ft.

WELL VOLUME: 3.3 gal. TOTAL VOLUME PURGED 10.5 gal.

SAMPLE PURGE DATA:

@ <u>1</u> well volume(s)	@ <u>2</u> well volumes
TEMP. <u>47.4</u> deg. F.	TEMP. <u>49.9</u> deg. F.
SP. COND. <u>1125</u> mohms	SP. COND. <u>1125</u> mohms
pH <u>7.9</u>	pH <u>7.8</u>
TIME <u>12:47</u>	TIME <u>1:12</u>
HR/MIN <u>5</u>	HR/MIN <u>20</u>
PURGE VOL. <u>3.3</u> gal.	PURGE VOL. <u>6.6</u> gal.

@ <u>3</u> well volumes	@ <u> </u> well volumes	@ <u> </u> well volumes
TEMP. <u>49.5</u> deg. F.	TEMP. <u> </u> deg. F.	TEMP. <u> </u> deg. F.
SP. COND. <u>1100</u> mohms	SP. COND. <u> </u> mohms	SP. COND. <u> </u> mohms
pH <u>7.7</u>	pH <u> </u>	pH <u> </u>
TIME <u>1:27</u>	TIME <u> </u>	TIME <u> </u>
HR/MIN <u> </u>	HR/MIN <u> </u>	HR/MIN <u> </u>
PURGE VOL. <u>9.9</u> gal.	PURGE VOL. <u> </u> gal.	PURGE VOL. <u> </u> gal.

REMARKS/OBSERVATIONS tubing to bottom very much
some chunks cleared rapidly - had trouble re setting
tube @ every joint - The third joint - Poked Above
screen is bad & takes time to get through
decent to talk MS/MSD

TIME SAMPLED: 1125 DATE: 5/18/94

QA/QC? N: MS? MSD? FIELD BLANK? *
 DOH SPLIT? N: VOA? LCIC'S? OTHER? **

*WHAT TYPE OF BLANK? glove rinse, pump rinse, tubing rinse, D.I. H2O, bailer rinse.

**DESCRIBE SPLIT: whole sample to DOH

PERSON/S PURGING None

PERSON/S SAMPLING None (OVER)

NEW YORK STATE DEPARTMENT OF ENVIRONMENTAL CONSERVATION

GROUNDWATER FIELD SAMPLE/PURGE RECORD

LOVE CANAL LONG TERM MONITORING PROGRAM

STATION # / LOCATION MW 9113 DATE 5/16/94

FIELD DATA TIME: START 11:20 END 12:31

WEATHER NOTES: 100% overcast windy 5-6.

VOA LEVEL: ambient (0) headspace (1)

WELL DEPTH: 36 ft. WATER DEPTH: Top of well 11.25 ft.

WELL VOLUME: 4.03 gal. TOTAL VOLUME PURGED 16.5 gal.

SAMPLE PURGE DATA:

@ <u>initial</u> gal.	@ <u>1</u> well volume(s)	@ <u>2</u> well volumes
TEMP. <u>48.9</u> deg. F.	TEMP. <u>48.9</u> deg. F.	TEMP. <u>50.6</u> deg. F.
SP. COND. <u>3400</u> mohms	SP. COND. <u>1875</u> mohms	SP. COND. <u>3000</u> mohms
PH <u>12.5</u>	PH <u>12.3</u>	PH <u>12.6</u>
TIME <u>11:20</u>	TIME <u>11:29</u>	TIME <u>11:48</u>
HR/MIN _____	HR/MIN <u>9</u>	HR/MIN <u>19</u>
PURGE VOL. _____ gal.	PURGE VOL. <u>4.0</u> gal.	PURGE VOL. <u>8.1</u> gal.

@ <u>3</u> well volumes	@ <u>4</u> well volumes	@ _____ well volumes
TEMP. <u>50.6</u> deg. F.	TEMP. <u>49.8</u> deg. F.	TEMP. _____ deg. F.
SP. COND. <u>605</u> mohms	SP. COND. <u>700</u> mohms	SP. COND. _____ mohms
PH <u>11.9</u>	PH <u>11.7</u>	PH _____
TIME <u>12:08</u>	TIME <u>12:29</u>	TIME _____
HR/MIN <u>20</u>	HR/MIN <u>21</u>	HR/MIN _____
PURGE VOL. <u>12.1</u> gal.	PURGE VOL. <u>16.1</u> gal.	PURGE VOL. _____ gal.

REMARKS/OBSERVATIONS EXTENDED TUBING BETWEEN 1 & 2
Noted some white precipitate in light tan discoloration
1/2 cleaning - jumps in spec can over 2000
checked calibration - OK - may be cold affecting
it will do 4 volumes for good cleaning PH also
yield must be record

TIME SAMPLED: 1105 DATE: 5/18/94

QA/QC? (N) MS? MSD? FIELD BLANK? *

DOH SPLIT? (N) VOA? LCIC'S? OTHER? **

*WHAT TYPE OF BLANK? glove rinse, pump rinse, tubing rinse, D.I. H2O, bailer rinse.

**DESCRIBE SPLIT: whole sample to Doh

PERSON/S PURGING Mauro

PERSON/S SAMPLING Mauro (OVER)

NEW YORK STATE DEPARTMENT OF ENVIRONMENTAL CONSERVATION

GROUNDWATER FIELD SAMPLE/PURGE RECORD

LOVE CANAL LONG TERM MONITORING PROGRAM

STATION # / LOCATION MW 9122 DATE 5/16/94

FIELD DATA TIME: START 0945 END 10:30

WEATHER NOTES: 100% overcast 52°

VOA LEVEL: ambient 0 headspace 0

WELL DEPTH: 34 ft. WATER DEPTH: Top of well 10.65 ft.

WELL VOLUME: 3.8 gal. TOTAL VOLUME PURGED 6.3 gal.

SAMPLE PURGE DATA:

@ initial <u>—</u> gal.	@ <u>1</u> well volume(s)	@ <u>2</u> well volumes
TEMP. <u>79.1</u> deg. F.	TEMP. <u>50.6</u> deg. F.	TEMP. <u>—</u> deg. F.
SP. COND. <u>350</u> mohms	SP. COND. <u>350</u> mohms	SP. COND. <u>—</u> mohms
pH <u>9.1</u>	pH <u>9.0</u>	pH <u>—</u>
TIME <u>10:52</u>	TIME <u>10:02</u>	TIME <u>10:15</u>
HR/MIN <u>—</u>	HR/MIN <u>10'</u>	HR/MIN <u>—</u>
PURGE VOL. <u>—</u> gal.	PURGE VOL. <u>3.8</u> gal.	PURGE VOL. <u>7.6</u> gal.

@ <u>3</u> well volumes	@ <u>—</u> well volumes	@ <u>—</u> well volumes
TEMP. <u>—</u> deg. F.	TEMP. <u>—</u> deg. F.	TEMP. <u>—</u> deg. F.
SP. COND. <u>—</u> mohms	SP. COND. <u>—</u> mohms	SP. COND. <u>—</u> mohms
pH <u>—</u>	pH <u>—</u>	pH <u>—</u>
TIME <u>—</u>	TIME <u>—</u>	TIME <u>—</u>
HR/MIN <u>—</u>	HR/MIN <u>—</u>	HR/MIN <u>—</u>
PURGE VOL. <u>11.4</u> gal.	PURGE VOL. <u>—</u> gal.	PURGE VOL. <u>—</u> gal.

REMARKS/OBSERVATIONS 1st fast level dropping fast & purge
slowing after 1st. water clear. 1st clearing
rapidly - well went dry after 6.3 gallons

TIME SAMPLED: 1000 DATE: 5/18/94

QA/QC? Y/N MS? MSD? FIELD BLANK? *
DOH SPLIT? Y/N VOA? LCIC'S? OTHER? **

*WHAT TYPE OF BLANK? glove rinse, pump rinse, tubing rinse, D.I. H2O, bailer rinse.

**DESCRIBE SPLIT: whole sample to DWH

PERSON/S PURGING Moore

PERSON/S SAMPLING Moore (OVER)

NEW YORK STATE DEPARTMENT OF ENVIRONMENTAL CONSERVATION

FIELD SAMPLE/PURGE RECORD

LONG TERM MONITORING PROGRAM

LOCATION MW 9130 DATE 5/23/94

TIME: START 0930 END 1015

WEATHER Partly cloudy 68°

ambient 70 headspace 70

WATER DEPTH: Top of well 6.10 ft.

PURGE VOL. 3.9 gal. TOTAL VOLUME PURGED 14.0 gal.

TABLE OF DATA

1	gal.	@ 1 well volume(s)	TEMP. 52.7 deg. F.	@ 2 well volumes	TEMP. 53.6 deg. F.
			SP. COND. 1050 mohms		SP. COND. 10.50 mohms
			PH 8.4		PH 7.8
			TIME 9:40		TIME 9:53
			HR/MIN 6:00		HR/MIN 13
			PURGE VOL. 3.9 gal.		PURGE VOL. 7.8 gal.

2	3 well volumes	TEMP. 54.1 deg. F.	SP. COND. 11.00 mohms	PH 7.6	TIME 10:04	HR/MIN	PURGE VOL. 11.7 gal.
3	well volumes	TEMP. deg. F.	SP. COND. mohms	PH	TIME	HR/MIN	PURGE VOL. gal.
4	well volumes	TEMP. deg. F.	SP. COND. mohms	PH	TIME	HR/MIN	PURGE VOL. gal.

REMARKS/OBSERVATIONS Blackish/grey silt
 Particulates slight turbidity
 TINT 1st part 2nd 2nd
 Mosquitoes during sampling

TIME SAMPLED: 0905 DATE: 5/25/94

QA/QC? Y/N MS? MSD? FIELD BLANK? *

DOH SPLIT? Y/N: VOA? LCIC'S? OTHER? **

*WHAT TYPE OF BLANK? glove rinse, pump rinse, tubing rinse, D.I. H2O, bailer rinse.

**DESCRIBE SPLIT: Whole sample to DOH

PERSON/S PURGING None

PERSON/S SAMPLING None (OVER)

NEW YORK STATE DEPARTMENT OF ENVIRONMENTAL CONSERVATION
 GROUNDWATER FIELD SAMPLE/PURGE RECORD
 EGOVE CANAL LONG TERM MONITORING PROGRAM

STATION / LOCATION MW 10105 DATE 5/23/94
 TIME: START 2:10 END 2:52
 TEMPERATURE 74°
 AMBIENT 0 HEADSPACE 0
 WATER DEPTH: Top of well 7.99 ft.
 TOTAL VOLUME PURGED 12.0 gal.

WELL	VOLUME	TEMP.	SP. COND.	pH	TIME	HR/MIN	PURGE VOL.
1	gal.	deg. F.	mohms				gal.
2	gal.	deg. F.	mohms				gal.
1	3.6	55.1	1375	6.7	2:17	5	3.6
2	7.2	54.9	1400	6.7	2:29	12	7.2

FIELD BLANK? *
 LCIC? * OTHER? **
 PLANK? glove rinse, pump rinse, tubing rinse, D.I. H2O,

DATE: 5/25/94
 FIELD BLANK? *
 LCIC? * OTHER? **
 PLANK? glove rinse, pump rinse, tubing rinse, D.I. H2O,
 whole sample to DOH
 More
 More (OVER)

NEW YORK STATE DEPARTMENT OF ENVIRONMENTAL CONSERVATION

GROUNDWATER FIELD SAMPLE/PURGE RECORD

LOVE CANAL LONG TERM MONITORING PROGRAM

STATION / LOCATION MW 10115 DATE 5/23/94

FIELD DATA TIME: START 10:25 END 11:48

TEMPERATURE: 73° Breezy

WIND: ambient 10 headspace 0

WELL DEPTH: 33.7 ft. WATER DEPTH: Top of well 11.26 ft.

WELL VOLUME: 3.7 gal. TOTAL VOLUME PURGED gal.

SAMPLE PURGE DATA:

Initial	gal.	@ 1 well volume(s)	@ 2 well volumes
TEMP.	71 deg. F.	TEMP. 55.7 deg. F.	TEMP. 58.0 deg. F.
SP. COND.	293 mohms	SP. COND. 875 mohms	SP. COND. 850 mohms
pH	7.6	pH 6.9	pH 6.8
TIME	10:37	TIME 10:47	TIME 11:12
HR/MIN		HR/MIN 10	HR/MIN 25
PURGE VOL.	gal.	PURGE VOL. 3.7 gal.	PURGE VOL. 7.4 gal.

@ 3 well volumes	@ well volumes	@ well volumes
TEMP. 67.3 deg. F.	TEMP. deg. F.	TEMP. deg. F.
SP. COND. 125 mohms	SP. COND. mohms	SP. COND. mohms
pH	pH	pH
TIME	TIME	TIME
HR/MIN	HR/MIN	HR/MIN
PURGE VOL. 11.7 gal.	PURGE VOL. gal.	PURGE VOL. gal.

REMARKS/OBSERVATIONS: Brown silt initially - cleared
 slow steady purge thru one mo
 slow purging

TIME SAMPLED: 0920 DATE: 5/25/94

ANALYST: (NI) MS? MSD? FIELD BLANK? *

RECIPIENT: (NI) VOA? LCIC'S? OTHER? **

TYPE OF BLANK? glove rinse, pump rinse, tubing rinse, D.I. H2O,

DESCRIBE SPLIT: whole sample to DOH

PERSON/PURGING: Moore

PERSON/SAMPLING: Moore (OVER)

NEW YORK STATE DEPARTMENT OF ENVIRONMENTAL CONSERVATION

GROUNDWATER FIELD SAMPLE/PURGE RECORD

LOVE CANAL LONG TERM MONITORING PROGRAM

STATION # / LOCATION MW 10150 DATE 6/6/94

FIELD DATA TIME: START 8:15 END 8:40

WEATHER/NOTES: overcast 78-80

VOA LEVEL: ambient 0 headspace 0

WELL DEPTH: 32.1 ft. WATER DEPTH: Top of well 12.1 ft.

WELL VOLUME: 3.26 gal. TOTAL VOLUME PURGED 14.0 gal.

SAMPLE PURGE DATA:

Initial _____ gal.	@ <u>1</u> well volume(s)	@ <u>2</u> well volumes
TEMP. <u>54.4</u> deg. F.	TEMP. <u>53.8</u> deg. F.	TEMP. <u>53.3</u> deg. F.
SP. COND. <u>1150</u> mohms	SP. COND. <u>1175</u> mohms	SP. COND. <u>1100</u> mohms
pH <u>7.5</u>	pH <u>7.5</u>	pH <u>7.4</u>
TIME <u>8:20</u>	TIME <u>8:24</u>	TIME <u>8:30</u>
HR/MIN _____	HR/MIN <u>4</u>	HR/MIN _____
PURGE VOL. _____ gal.	PURGE VOL. <u>3.3</u> gal.	PURGE VOL. <u>6.6</u> gal.

@ <u>3</u> well volumes	@ _____ well volumes	@ _____ well volumes
TEMP. <u>53.3</u> deg. F.	TEMP. _____ deg. F.	TEMP. _____ deg. F.
SP. COND. <u>1125</u> mohms	SP. COND. _____ mohms	SP. COND. _____ mohms
pH <u>7.4</u>	pH _____	pH _____
TIME <u>8:37</u>	TIME _____	TIME _____
HR/MIN _____	HR/MIN _____	HR/MIN _____
PURGE VOL. <u>9.9</u> gal.	PURGE VOL. _____ gal.	PURGE VOL. _____ gal.

REMARKS/OBSERVATIONS Red floc - A lot of it

TIME SAMPLED: 0905 DATE: 6/8/94

QA/QC: MS? MSD? FIELD BLANK? *

DOH SPLIT? VOA? LCIC'S? OTHER? **

*WHAT TYPE OF BLANK? glove rinse, pump rinse, tubing rinse, D.I. H2O, bailer rinse.

**DESCRIBE SPLIT: whole sample to DOH

PERSON/S PURGING C. Johnson M. Doyle N. Moore

PERSON/S SAMPLING Same (OVER)

NEW YORK STATE DEPARTMENT OF ENVIRONMENTAL CONSERVATION

GROUNDWATER FIELD SAMPLE/PURGE RECORD

STATEWIDE LONG TERM MONITORING PROGRAM

LOCATION MW 10178 A E2 DATE 5/23/94

TIME: START 12:35 END 12:52

TEMP 73° Sky Breeze

ambient 0 headspace 0

WATER DEPTH: Top of well 6.25 ft.

gal. TOTAL VOLUME PURGED 6.0 gal.

ANALYSIS DATA

gal. 2.1	1 well volume(s)	TEMP. 53.1 deg. F.	2 well volumes	TEMP. 53.7 deg. F.
deg. F.	SP. COND. 1100 mohms	SP. COND. 1450 mohms	PH 7.2	PH 7.2
inches	PH 8.4	TIME 10:35	TIME 11:41	
	HR/MIN 10.3	PURGE VOL. 2.1 gal.	PURGE VOL. 4.2 gal.	

1 well volumes	TEMP. deg. F.	TEMP. deg. F.	2 well volumes	TEMP. deg. F.
deg. F.	SP. COND. mohms	SP. COND. mohms	PH	PH
inches	PH	TIME	TIME	
	HR/MIN	PURGE VOL. gal.	PURGE VOL. gal.	

White water 1st - 2nd cleared
before 3rd.

SAMPLED: 0945 DATE: 5/25/94

FIELD BLANK? *

QA? LCIC'S? OTHER? **

OF BLANK? glove rinse, pump rinse, tubing rinse, D.I. H2O,

SPLIT: whole sample to D&H

PURGING: None

SAMPLING: None (OVER)

ADDITIONAL WELLS

1995

(ADDED TO LTM)

INCOMPLETE

TO BE COMPLETED

MISSING

1150

1205

10180A

OCCIDENTAL CHEMICAL CORPORATION

GROUNDWATER FIELD SAMPLE/PURGE RECORD

LOVE CANAL LONG TERM MONITORING PROGRAM

STATION # 1151 A. DATE: 5/16
WEATHER NOTES: 5" 25"
VOC LEVEL: AMBIENT 0. HEADSPACE 0
WELL DEPTH: 27.7 FT. WATER DEPTH: TOW 0.5 FT.
WELL VOLUME: 3.0 GAL. TOTAL VOLUME PURGED 4.5 GAL.
SAMPLE PURGE DATA:

1K @INITIAL 0 GAL.
TEMP. 14.8 DEG. F. C
SPCON 1100 MOHS
TURBID. 1.6 NTU'S
pH 7.43
TIME 0
HR/MIN 1409
PURGE
VOL. 0 GALS.

@ 3 GAL.
TEMP. 14.8 DEG. F. C
SPCON 1200 MOHS
TURBID. 1.22 NTU'S
pH 7.41
TIME 7
HR/MIN 1416
PURGE
VOL. 3 GALS.

@ 4.5 GAL.
TEMP. Inoperative DEG. F.
SPCON 1200 MOHS
TURBID. 14.6 NTU'S
pH Inoperative
TIME 9
HR/MIN 1425
PURGE
VOL. 4.5 GALS.

SAMPLING
@ 5/17 GAL.
TEMP. _____ DEG. F.
SPCON _____ MOHS
TURBID. _____ NTU'S
pH _____
TIME _____
HR/MIN _____
PURGE
VOL. _____ GALS.

@ _____ GAL.
TEMP. _____ DEG. F.
SPCON _____ MOHS
TURBID. _____ NTU'S
pH _____
TIME _____
HR/MIN _____
PURGE
VOL. _____ GALS.

@ _____ GAL.
TEMP. _____ DEG. F.
SPCON _____ MOHS
TURBID. _____ NTU'S
pH _____
TIME _____
HR/MIN _____
PURGE
VOL. _____ GALS.

REMARKS/OBSERVATIONS Dry after 1.5 volumes, sl. cldy,
lt brown at end of purge.
Sealing went dry will have to come back
2x40ml VOA } @ 0915
2x12 BNA }

TIME SAMPLED: 9:15 A DATE: 5/17/95
QA/QC? Y/N MS? MSD? FIELD BLANK? _____
DEC SPLIT? Y/N VOA'S, BNA'S, PESTICIDES/PCB'S _____
PERSON/S PURGING Perk

PERSON/S SAMPLING _____

OCCIDENTAL CHEMICAL CORPORATION

.6

GROUNDWATER FIELD SAMPLE/PURGE RECORD

LOVE CANAL LONG TERM MONITORING PROGRAM

STATION # WMD 6209 DATE: 5/17/95
 WEATHER NOTES: overcast - 5:00 PM (wind)
 VOC LEVEL: AMBIENT 0.2 HEADSPACE 0.2
 WELL DEPTH: 42.0 FT. WATER DEPTH: TOW 14.0 FT.
 WELL VOLUME: 19.5 GAL. TOTAL VOLUME PURGED _____ GAL.
 SAMPLE PURGE DATA:

@INITIAL _____ GAL.
 TEMP. 12.9 DEG. °C
 SPCON 5.700 MOHS
 TURBID. 1.2 NTU'S
 pH 7.30
 TIME 9:45 AM
 HR/MIN _____
 PURGE
 VOL. _____ GALS.

@ 18.5 GAL.
 TEMP. 12.8 DEG. °C
 SPCON 6000 MOHS
 TURBID. .15 NTU'S
 pH 6.68
 TIME 10:26
 HR/MIN 400
 PURGE
 VOL. 19.5 GALS.

@ 37 GAL.
 TEMP. 12.7 DEG. F.
 SPCON 5800 MOHS
 TURBID. NR NTU'S
 pH 6.67
 TIME 11:09 AM
 HR/MIN 43
 PURGE
 VOL. 30.5 GALS.

@ 55.5 GAL.
 TEMP. 13.0 DEG. °C
 SPCON 5.900 MOHS
 TURBID. .06 NTU'S
 pH 6.63
 TIME 2:05 PM
 HR/MIN 64
 PURGE
 VOL. 48.5 GALS.

@ _____ GAL.
 TEMP. _____ DEG. °C
 SPCON _____ MOHS
 TURBID. _____ NTU'S
 pH _____
 TIME _____
 HR/MIN _____
 PURGE
 VOL. _____ GALS.

@ _____ GAL.
 TEMP. 12.7 DEG. F.
 SPCON _____ MOHS
 TURBID. _____ NTU'S
 pH 6
 TIME _____
 HR/MIN _____
 PURGE
 VOL. _____ GALS.

REMARKS/OBSERVATIONS

MS / MSD

TIME SAMPLED: 12 DATE: _____
 QA/QC? YN MS MSD? FIELD BLANK? Yes 12020
 DEC SPLIT? YN VOA'S, BNA'S, PESTICIDES/PCB'S
 PERSON/S PURGING rocket, 12020
 PERSON/S SAMPLING C

OCCIDENTAL CHEMICAL CORPORATION

GROUNDWATER FIELD SAMPLE/PURGE RECORD

LOVE CANAL LONG TERM MONITORING PROGRAM

STATION # 10215 DATE: 5/16/95
WEATHER NOTES: Sunny 70° w S wind
VOC LEVEL: AMBIENT 0.2 HEADSPACE 0.2
WELL DEPTH: 60.0 FT. WATER DEPTH: TOW 13.65 FT.
WELL VOLUME: 7.42 GAL. TOTAL VOLUME PURGED 2 GAL.
SAMPLE PURGE DATA:

111 @ INITIAL 0 GAL.
TEMP. 16.4 DEG. F. ✓
SPCON 2100 MOHS
TURBID. 2.4 NTU'S
pH 7.97
TIME 11:08
HR/MIN 0
PURGE
VOL. 0 GALS.

@ 7.5 GAL.
TEMP. 14.0 DEG. F. ✓
SPCON 4900 MOHS
TURBID. 2.0 NTU'S
pH 6.74
TIME 11:22 A
HR/MIN 12
PURGE
VOL. 7.5 GALS.

@ 15 GAL.
TEMP. 15.6 DEG. F. ✓
SPCON 4700 MOHS
TURBID. 1.6 NTU'S
pH 6.76
TIME 11:40
HR/MIN 18.2
PURGE
VOL. 15 GALS.

@ 22.5 GAL.
TEMP. 16.0 DEG. F. ✓
SPCON 4600 MOHS
TURBID. 1.1 NTU'S
pH 6.76
TIME 11:57 AM
HR/MIN 17.2
PURGE
VOL. 22.5 GALS.

@ _____ GAL.
TEMP. _____ DEG. F.
SPCON _____ MOHS
TURBID. _____ NTU'S
pH _____
TIME _____
HR/MIN _____
PURGE
VOL. _____ GALS.

11K @ _____ GAL.
TEMP. 13.2° DEG. F.
SPCON 2100 MOHS
TURBID. 4.2 NTU'S
pH 8.01
TIME 12:25
HR/MIN _____
PURGE
VOL. _____ GALS.

REMARKS/OBSERVATIONS _____
_____ Clear, trace rusty flakes, vis. H2S odor _____

TIME SAMPLED: _____ DATE: _____
QA/QC? Y MS? MSD? FIELD BLANK? _____
DEC SPLIT? Y VOA'S, BNA'S, PESTICIDES/PCB'S _____
PERSON/S PURGING Parkhill, Crockett, Moore
PERSON/S SAMPLING Parkhill, Moore, Crockett, Lynel

NEW YORK STATE DEPARTMENT OF ENVIRONMENTAL CONSERVATION

GROUNDWATER FIELD SAMPLE/PURGE RECORD

LOVE CANAL LONG TERM MONITORING PROGRAM

STATION # / LOCATION MW 8106 DATE 5/10/94

FIELD DATA TIME: START 9:35 END 9:51

WEATHER NOTES: Sunny 80% clear 76°

VOA LEVEL: ambient 0 headspace 0

WELL DEPTH: 17 ft. WATER DEPTH: Top of well 9.65 ft.

WELL VOLUME: 1.2 gal. TOTAL VOLUME PURGED 6.0 gal.

SAMPLE PURGE DATA:

@ initial 21 gal.
TEMP. 51.4 deg. F.
SP. COND. 1250 mohms
PH 7.4
TIME 9:35
HR/MIN 2
PURGE VOL. 41 gal.

@ 1 well volume(s)
TEMP. 48.4 deg. F.
SP. COND. 1250 mohms
PH 7.3
TIME 9:39
HR/MIN 3
PURGE VOL. 1.2 gal.

@ 2 well volumes
TEMP. 48.6 deg. F.
SP. COND. 1250 mohms
PH 7.3
TIME 9:41
HR/MIN 3
PURGE VOL. 2.4 gal.

@ 3 well volumes
TEMP. 48.7 deg. F.
SP. COND. 1250 mohms
PH _____
TIME 9:44
HR/MIN 3
PURGE VOL. 3.6 gal.

@ _____ well volumes
TEMP. _____ deg. F.
SP. COND. _____ mohms
PH _____
TIME _____
HR/MIN _____
PURGE VOL. _____ gal.

@ _____ well volumes
TEMP. _____ deg. F.
SP. COND. _____ mohms
PH _____
TIME _____
HR/MIN _____
PURGE VOL. _____ gal.

REMARKS/OBSERVATIONS Went very well

TIME SAMPLED: 1100 DATE: 5/11/94

QA/QC? MS? MSD? FIELD BLANK?

DOH SPLIT? VOA? LCIC'S? OTHER?

*WHAT TYPE OF BLANK? glove rinse, pump rinse, tubing rinse, D.I. H2O, bailer rinse.

**DESCRIBE SPLIT: Whole sample to DOH

PERSON/S PURGING Moore

PERSON/S SAMPLING Moore (OVER)

NEW YORK STATE DEPARTMENT OF ENVIRONMENTAL CONSERVATION

GROUNDWATER FIELD SAMPLE/PURGE RECORD

ADRIAN CANAL LONG TERM MONITORING PROGRAM

STATION LOCATION MW 10176 B-D3 DATE 5/23/94

TIME: START 13:20 END 13:41

TEMP 74°

ambient 0 headspace 0

WATER DEPTH: Top of well 18.62 ft.

TOTAL VOLUME PURGED 6 gal.

ANALYSIS DATA:

gal.	@	well volume(s)	@	2	well volumes
TEMP. 53.8 deg. F.		TEMP. 53.8 deg. F.		TEMP. 54.0 deg. F.	
SP. COND. 600 mohms		SP. COND. 600 mohms		SP. COND. 600 mohms	
PH 7.6		PH 7.6		PH 7.4	
TIME 13:26		TIME 13:26		TIME 13:30	
HR/MIN 4		HR/MIN 4		HR/MIN 4	
PURGE VOL. 1.7 gal.		PURGE VOL. 1.7 gal.		PURGE VOL. 3.4 gal.	

gal.	@	well volumes	@	well volumes
TEMP. deg. F.		TEMP. deg. F.		TEMP. deg. F.
SP. COND. mohms		SP. COND. mohms		SP. COND. mohms
PH		PH		PH
TIME		TIME		TIME
HR/MIN		HR/MIN		HR/MIN
PURGE VOL. gal.		PURGE VOL. gal.		PURGE VOL. gal.

Well D3 chosen due to depth of 10178A both @

DATE: 5/25/94

FIELD BLANK? *
OTHER? **

BLANK? glove rinse, pump rinse, tubing rinse, D.I. H2O,

whole sample to DOH

PURGING None
SAMPLING None

(OVER)

OCCIDENTAL CHEMICAL CORPORATION

GROUNDWATER FIELD SAMPLE/PURGE RECORD

LOVE CANAL LONG TERM MONITORING PROGRAM

STATION # 10215 DATE: 5/14/95
WEATHER NOTES: Sunny 70° lt S wind
VOC LEVEL: AMBIENT 0.2 HEADSPACE 0.2
WELL DEPTH: 60.0 FT. WATER DEPTH: TOW 13.65 FT.
WELL VOLUME: 7.42 GAL. TOTAL VOLUME PURGED 2 GAL.
SAMPLE PURGE DATA:

111 @INITIAL 0 GAL.
TEMP. 16.4 DEG. F. ✓
SPCON 2100 MOHS
TURBID. 2.4 NTU'S
pH 7.97
TIME 11:08
HR/MIN 0
PURGE
VOL. 0 GALS.

@ 7.5 GAL.
TEMP. 14.0 DEG. F. ✓
SPCON 4900 MOHS
TURBID. 2.8 NTU'S
pH 6.74
TIME 11:22 A
HR/MIN 12
PURGE
VOL. 7.5 GALS.

@ 15 GAL.
TEMP. 15.6 DEG. F. ✓
SPCON 4700 MOHS
TURBID. 1.6 NTU'S
pH 6.76
TIME 11:40
HR/MIN 18.2
PURGE
VOL. 15 GALS.

@ 22.5 GAL.
TEMP. 16.0 DEG. F. ✓
SPCON 4600 MOHS
TURBID. 1.1 NTU'S
pH 6.76
TIME 11:57 A
HR/MIN 17.2
PURGE
VOL. 22.5 GALS.

@ _____ GAL.
TEMP. _____ DEG. F.
SPCON _____ MOHS
TURBID. _____ NTU'S
pH _____
TIME _____
HR/MIN _____
PURGE
VOL. _____ GALS

IK @ _____ GAL.
TEMP. 13.2 DEG. F.
SPCON 2100 MOHS
TURBID. 4.2 NTU'S
pH 8.01
TIME 12:25
HR/MIN _____
PURGE
VOL. _____ GALS

REMARKS/OBSERVATIONS

Clear, trace rusty flakes, vis. H₂S odor

TIME SAMPLED: _____ DATE: _____

QA/QC? Y MS? MSD? FIELD BLANK? _____

DEC SPLIT? Y VOA'S, BNA'S, PESTICIDES/PCB'S
PERSON/S PURGING Parkhill, Crockett, Lynel

PERSON/S SAMPLING Parkhill, Moore, Crockett, Lynel

NEW YORK STATE DEPARTMENT OF ENVIRONMENTAL CONSERVATION

GROUNDWATER FIELD SAMPLE/PURGE RECORD

LOVE CANAL LONG TERM MONITORING PROGRAM

STATION # / LOCATION MW 10270 DATE 5/17/94

FIELD DATA TIME: START 9:40 END 10:15

WEATHER NOTES: 100% overcast 44°

VOA LEVEL: ambient 0 headspace 0

WELL DEPTH: 47.3 ft. WATER DEPTH: Top of well 11.85 ft.

WELL VOLUME: 5.8 gal. TOTAL VOLUME PURGED 10.0 gal.

SAMPLE PURGE DATA:

@initial 1 gal.
TEMP. 49.5 deg. F.
SP. COND. 2300 mohms
PH 8.5
TIME 9:45
HR/MIN -
PURGE VOL. - gal.

@ 1 well volume(s)
TEMP. 51.0 deg. F.
SP. COND. 2400 mohms
PH 7.4
TIME 9:52
HR/MIN -
PURGE VOL. 5.8 gal.

@ 2 well volumes
TEMP. 49.7 deg. F.
SP. COND. 2550 mohms
PH 7.3
TIME 10:00
HR/MIN -
PURGE VOL. 11.6 gal.

@ 3 well volumes
TEMP. 51.0 deg. F.
SP. COND. 2450 mohms
PH 7.3
TIME 10:08
HR/MIN -
PURGE VOL. 17.4 gal.

@ - well volumes
TEMP. - deg. F.
SP. COND. - mohms
PH -
TIME -
HR/MIN -
PURGE VOL. - gal.

@ - well volumes
TEMP. - deg. F.
SP. COND. - mohms
PH -
TIME -
HR/MIN -
PURGE VOL. - gal.

REMARKS/OBSERVATIONS Black specks all 1st
strong H₂S odor - soon purge

TIME SAMPLED: 1250 DATE: 5/17/94

QA/QC? Y/N: MS? MSD? FIELD BLANK? *
DOH SPLIT? Y/N: VOA? LCIC'S? OTHER? **

*WHAT TYPE OF BLANK? glove rinse, pump rinse, tubing rinse, D.I. H₂O, bailer rinse.

**DESCRIBE SPLIT: whole sample 1 Day

PERSON/S PURGING Marc

PERSON/S SAMPLING Marc (OVER)

APPENDIX D

FIELD PROCEDURES

- FP 1 WATER LEVEL MEASUREMENT PROCEDURES
- FP 2 WELL PURGING PROCEDURES
- FP 3 pH METER CALIBRATION PROCEDURES
- FP 4 SPECIFIC-CONDUCTANCE METER CALIBRATION
PROCEDURES
- FP 5 TURBIDIMETER CALIBRATION PROCEDURES
- FP 6 GROUNDWATER SAMPLE COLLECTION PROCEDURES FROM
MONITORING WELLS
- FP 7 DECONTAMINATION PROCEDURES
- FP 8 HNu CALIBRATION PROCEDURES

FP 1

WATER LEVEL MEASUREMENT PROCEDURES

- Scope: This operating procedure outlines the method used to measure water levels with an electronic water level indicator.
- Purpose: The purpose of this procedure is to assure good quality control in field operations and uniformity among different field personnel taking water level measurements.
- Equipment Needed: Personal protective equipment, water level indicator, low phosphate soap, distilled water, paper towels, buckets, water level measurement forms or water levels logbook, Site map showing wells.
- Procedures:
1. Check that the indicator battery is functional.
 2. Decontaminate the probe and tape with a low phosphate soap solution followed by a distilled water rinse. Dry with a clean cloth/paper towel (see FP 7).
 3. Remove cap from well, check for the measuring point mark on the well riser and for any sharp edges which may damage the indicator tape.
 4. Lower the probe into the center of the well until a contact with the water surface is indicated, either by audible alarm, light or meter deflection.
 5. Mark and hold the tape at the measuring point and repeat the measurement.
 6. Read off the measurement and record with date and time of measurement noted. Measurement should be made to ± 0.01 feet.
 7. Retract the tape by winding onto the spool. Wipe tape with a clean cloth as it comes out of the well. Decon tape as described in Number 2 above.

8. If there is any uncertainty that the correct well is being monitored, measure the total depth of the well using a separate tape with a solid weight. Compare the measured depth to the known recorded depth.

Note: some wells may have dedicated measuring tapes with a plover attached. A plover is a small weight attached to the end of a tape. The water level is measured by dropping the weight into the well until audible contact with the water surface is made. The depth to the contact surface is then read off of the dedicated tape. Dedicated tapes do not require decontamination.

FP 2 WELL PURGING PROCEDURES

- Scope: This operating procedure describes acceptable methodologies for purging standing water in monitoring wells so that representative groundwater samples can be collected.
- Purpose: The purpose of describing this procedure is to create uniform purging procedures between field personnel, provide groundwater representative of the aquifer from which it came, and maintain proper quality control practices.
- Equipment Needed: Personal protective equipment, disposable gloves, water level tape, Photoionization Detection (PID), compressors, generator, field forms and field logbook, plastic garbage bags, cotton string, appropriate purge pump or bailer, discharge tubing, pH meter, conductivity meter, temperature meter, turbidity meter, clear glass sample jars, and well keys.
- Procedures:
1. Locate and identify the monitoring well to be purged.
 2. Unlock protective casing and remove well cap.
 3. Place plastic sheeting around well or use masonry trays or tubs to collect spillage. Don clean disposable gloves.
 4. Position PID at well head to detect organic vapors for selection of appropriate level of personnel protection equipment. Record PID readings of well riser headspace and background.
 5. Measure depth to water and total depth of well. Do not use the water level indicator to sound the bottom of the wells to prevent damage to the water level indicator. A separate tape with a solid weight should be used. Record information on appropriate field logs. Compare the total depth of the well to the previously recorded depth shown to ensure that the correct well is being monitored. This measurement also provides an indication regarding "silting up" of the well (i.e. sand and/or silt from the formation has migrated into the well. If the well has significantly silted up (i.e. 50% or more of the screened interval) then the well will be need to be redeveloped prior to sample collection).
 6. Calculate the volume of water initially in the well by subtracting the water level from the total depth and multiplying by:
 - 0.163 gallons/foot for a 2-inch diameter well,

WELL PURGING PROCEDURES

- 0.367 gallons/foot for a 3-inch diameter well,
 - 0.653 gallons/foot for a 4-inch diameter well.
7. Prepare the appropriate purge pump for well purging by attaching the appropriate type of discharge tubing to the pump.
 8. Lower the pump or discharge tubing into the well to the depth where water is encountered. As the discharge tubing is lowered, wipe it with paper towels dampened with deionized water to remove any debris which may be adhering to its surface.
 9. Connect the pump to the appropriate power source (generator or compressor) and turn pump on. Be sure that the discharge from the pump is directed into a proper storage container.
 10. Lower the pump or discharge tubing, while it is pumping, to the midpoint region of the saturated level of an open borehole or to the mid-screen point in cased monitoring wells.
 11. Mark time when pumping began in field book and on sampling log.
 12. Take pH, specific conductance, temperature and turbidity readings during the evacuation process and record the readings obtained on appropriate sampling logs. The meters used to measure the field parameters should be calibrated each morning or as required during purging and sampling. Field parameter readings are to be taken at the start of purging and after each calculated well volume has been removed.
 13. Continue to take indicator measurements for each well volume removed for the duration of time required to evacuate a minimum of three well volumes.
 14. Once three well volumes of groundwater have been removed from the well and pH, specific conductance, and temperature have stabilized, slowly remove the pump from the saturated zone. The well will be considered stabilized when two successive measures of pH are within 0.5 units, temperature within 1.0°C, and specific conductance is

WELL PURGING PROCEDURES

within 10 percent. If stability is not obtained, pump a maximum of five calculated well volumes.

15. If the pump is not to be used for sample collection, then, when the standing water has been purged from the well, remove the pump from the well while still running. Turn off the pump.
16. Disconnect discharge tubing from the pump and properly dispose of or store the tubing. Tubing not being stored for reuse should be disposed of in conjunction with used personal protective equipment. Tubing that requires disposal is tubing that cannot be stored within the well between monitoring events. If tubing must be removed from the well to facilitate sampling, either new tubing must be utilized for the next event or the removed tubing must be thoroughly cleaned (FP 8) prior to placement back into the well. If tubing is going to be stored within the well it should be tied off to the well itself.
17. If the pump is to be used to collect samples at completion of purging proceed right into collection of groundwater samples.

FP 3

pH METER CALIBRATION PROCEDURE

- Scope:** This procedure describes the calibration of a standard pH meter and the determination of pH in an aqueous media.
- Purpose:** The purpose of this procedure is to provide a uniform basis for calibration of field pH meters and ensure continuity between field personnel. Additionally, the method provides quality control steps necessary for obtaining reliable and representative pH readings.
- Equipment Needed:** pH meter, buffers, polypropylene beakers, paper towels, calibration logs, field logs, distilled water, thermometer, and extra batteries.

Calibration

- Procedures:**
1. Check to make sure batteries are fully charged.
 2. Turn meter on and allow it to stabilize for three to five minutes.
 3. Select pH buffers, 7, 4, and 10 and check temperatures of each. Record pertinent information on field calibration logs.
 4. Place 10 mL of each buffer in a prelabeled container.
 5. Clean pH probe with stream of distilled water.
 6. Place probe in pH buffer and stir gently.
 7. Adjust temperature knob to read measured temperature and then adjust the calibration knob until 7.00 is displayed in the readout window.
 8. Remove probe and clean with distilled water.
 9. Place probe in second calibration buffer and repeat calibration process.
 10. Remove probe, rinse with distilled water and check reading in the pH 7.00 buffer. If reading is off by more than 0.05 pH units recalibrate as described above.
 11. Remove probe, rinse and check the pH of the third buffer.
 12. Rinse probe and insert in groundwater sample. Record result on field logs.

pH METER CALIBRATION PROCEDURE

13. This calibration procedure should be performed:
 - i) approximately every two hours of steady use;
 - ii) following significant ambient temperature changes;
 - iii) when meter reads erratically; and
 - iv) at beginning and end of sampling day use.

14. When the meter is moved to a new sampling location, a single-point calibration should be performed with pH Buffer 7.

Note: The Orion 230A meter also has an Autocalibration Mode. See specific calibration information for this meter in the Vendors Data in Appendix A.

FP 4 SPECIFIC-CONDUCTANCE METER CALIBRATION PROCEDURES

Scope: This procedure describes the calibration of a portable field specific conductance meter for obtaining measurements in aqueous media.

Purpose: The purpose of this procedure is to provide a uniform means for calibration and operation of portable field specific conductance meters between field personnel. Additionally, the method provides quality control steps necessary for obtaining reliable and representative readings.

Equipment Needed: Conductivity meter, reference solutions, distilled water.

Calibration

- Procedures:
1. Check to make sure batteries are fully charged.
 2. Turn range switch to desired range.
 3. Fill and rinse cell cup 3 times with sample to be measured.
 4. Fill cell cup again to 1/4" or more above upper electrode.
 5. Press black button and read scale value indicated by pointer.
 6. If reading does not match reference standard value, open bottom of meter and adjust calibration control.
 7. Recheck reference standard reading until correct calibration is read on meter.

Meter Usage

1. With instrument calibrated, set range to highest range.
2. Pour aqueous sample into cell cup to 1/4" above upper electrode. Press black button - record reading.
3. Clean cell cup with a stream of deionized or distilled water.
4. Record sample number, date, time, project, and resulting conductivity value on appropriate field logs.
5. This calibration procedure should be performed:
 - i) approximately every two hours of continual use;

SPECIFIC-CONDUCTANCE METER CALIBRATION PROCEDURES

- ii) following significant ambient temperature changes;
- iii) when meter reads erratically; and
- iv) at beginning and end of sampling day use.

Note: Specific calibration for the Myron L Meter is contained in the Vendors Data in Appendix A.

TURBIDIMETER PROCEDURES

Scope: This procedure describes the calibration of a portable field turbidity meter for obtaining measurements in aqueous media.

Purpose: The purpose of this procedure is to provide a uniform means for calibration and operation of portable turbidity meter between field personnel. Additionally, the method provides quality control steps necessary for obtaining reliable and representative readings.

Equipment Needed: Turbidity meter, reference solutions, distilled water

Calibration Procedures: A. Primary and Secondary Standards

Standards are solutions with a known turbidity which are used for calibrating the turbidimeter.
(Do not allow standards to freeze)

Primary standards are standards which are acceptable to the Environmental Protection Agency (EPA) for calibrating turbidimeters.

There are only two:

1. Formazin; and
2. Styrene divinylbenzene polymer beads.

The same glass cuvette must be used when calibrating the turbidimeter with the primary standards and when measuring the unknown sample.

Secondary standards are defined by the EPA as Sealed Standards. Secondary Standards can be used for calibrating turbidimeters if the secondary standards are first calibrated with primary standards. The use of secondary standards can save time and money.

B. Calibrating with Primary Standards

You will need:

- .5 NTU and 10 NTU primary standards;
- .5 NTU and 10 NTU sealed standards; and
- one sample cuvette with cap.

TURBIDIMETER PROCEDURES

1. Turn on the turbidimeter. Allow the unit to warmup (one minute for portable model and 5 minutes for the bench model).
2. Set the range switch to 0-20 NTU.
3. Prepare the cuvette with the 10 NTU primary standard.
- * **Always rinse the inside with the standard being used, fill to mark, cap, and clean the outside.**
4. Insert the cuvette into the test well, align the cuvette, and cover with the light shield.
5. Adjust the SET/CAL control until the display reads 10.0.
6. Remove the primary standard and replace it with the 10 NTU sealed standard. Align it and cover it with the light shield.
- * **Always clean the secondary standards with alcohol before taking reading.**
7. Record the NTU value of the sealed standard on the label. This value can now be used for calibration without primary standards.
8. Pour the standard out and shake remaining droplets out of the cuvette.
9. Change the range switch to 0-2 NTU.
10. Prepare the same cuvette using the 0.5 NTU primary standard. (Remember to rinse at least twice).

IMPORTANT NOTE 1: The 0-2 NTU range is only used for calibration procedures and "LAB" testing. Under normal use remain in the 0-20 NTU range for all low level sample readings. The 0-20 NTU range gives acceptable readings well within EPA's and other regulatory agencies' 2% requirements.

11. Insert the cuvette into the test well. Align the cuvette and cover it with the light shield.

TURBIDIMETER PROCEDURES

12. Adjust the ZERO NTU adjust screw so that the display reads 0.500. Make sure the reading has settled.
13. Remove the primary standard and replace it with the .5 NTU sealed standard. Align it and cover it with the light shield.

NOTE: When calibrating in the 0-2 NTU range, the 3rd digit (1/1000 place) may vary $\pm.002$ in a lab setting and $\pm.005$ outside the lab.

14. Record the NTU value of the sealed standard on the label. This value can now be used for calibration without primary standards.
15. Pour the 0.5 NTU standard out of the cuvette and shake out the remaining droplets.

NOTE: Due to the slight interaction between the 10 NTU and 0.5 NTU standard adjustments, the following steps should be taken.

16. Set the range switch to 0-20 NTU.
17. Insert the 10 NTU sealed standard, align and cover. The SET/CAL adjust may require a slight adjustment. Set the meter to read the recorded calibrated value of the sealed standard from Step 7.
18. Insert the 0.5 NTU sealed standard, align and cover. Adjust the ZERO ADJ screw as necessary to obtain the value recorded on the label.
19. Repeat steps 16-18 until no further adjustments are needed.
20. The turbidimeter is now calibrated and ready for sample measurements.

IMPORTANT NOTE 2: The above procedures should be performed every three months, every time a new sample cuvette is used or any time the sealed standard values are questionable. Repeated use of the sample cuvettes and sealed standard cuvettes will cause wear and scratches on

TURBIDIMETER PROCEDURES

the glass. This wear will result in a change in the assigned value of the standard. It is important to realize that a change in the assigned value does not necessarily indicate degradation or deterioration of the standard.

C. Calibrating with Secondary Standards (Daily Calibration)

Once a sealed standard is calibrated to a primary standard in a sample cuvette, it becomes a secondary standard.

Before inserting the secondary (sealed) standards into the test well, clean the outside with a soft tissue or cloth and glass cleaner. Hold the cuvette by the cap and avoid touching the glass.

When not being used, the secondary standards should be stored where they will not be scratched or broken.

1. Turn on the turbidimeter and allow to warm-up, five minutes for bench model and one minute for portable units.
2. Set the range switch to 0-20 NTU. See "IMPORTANT NOTE 1" in Item B.
3. Insert the 10 NTU secondary standard into the test well and line up the alignment marks on the cuvette and test well. Note the calibrated NTU value obtained for the standard when it was calibrated to the primary standards.

*** Always clean the cuvette with alcohol before taking a reading.**

4. Cover the cuvette with the light shield and use the SET/CAL control to set the display to the calibrated NTU value of the 10 NTU secondary standard.
5. Remove the 10 NTU standard and change the range switch to 0-2 NTU.
6. Insert the 0.5 secondary standard into the test well. Line up the alignment marks on the cuvette with the test well mark.

TURBIDIMETER PROCEDURES

7. Note the calibrated NTU value obtained for the .5 NTU secondary standard when it was calibrated to the primary standards.
8. Cover the cuvette with the light shield and turn the zero NTU adjust screw until the display reads the calibrated NTU value of the .5 NTU secondary standard.
9. Remove the .5 NTU standard.
10. Set the range switch to 0-20 NTU.
11. Insert the 10 NTU secondary standard, align and cover.
12. The SET/CAL adjust may require a slight adjustment. Set the meter to read the NTU value of the sealed standard.

NOTE: Due to a slight interaction between the 10 NTU and 0.5 NTU standard adjustments, the following steps should be taken.

13. Set the range switch to 0-20 NTU.
14. Insert the 10 NTU sealed standard, align and cover. The SET/CAL adjust may require a slight adjustment. Set the meter to read the calibrated value of the sealed standard recorded in Step 7.
15. Insert the 0.5 NTU sealed standard, align and cover. Adjust the ZERO ADJ screw as necessary to obtain the value recorded on the label.
16. Repeat steps 13-15 until no further adjustments are needed.

The turbidimeter is now calibrated to the secondary standards, which are calibrated to the primary standards. You can now proceed to measure unknown samples.

FP 6

GROUNDWATER SAMPLE COLLECTION PROCEDURES FROM MONITORING WELLS

- Scope:** This procedure describes the methodology for collecting representative groundwater samples for laboratory analyses from both bedrock and overburden wells.
- Purpose:** The purpose of describing this procedure is to provide a uniform methodology for collection of good quality and representative groundwater samples.
- Equipment Needed:** Personal protective equipment, field sampling forms, pH, temperature, turbidity, and specific conductivity meters, PID, disposable or dedicated bailer, cotton string for bailer, plastic trash bags, properly preserved and labeled sample containers, clear glass jars, masonry trough, buckets, and decontamination equipment.
- Procedures:**
1. Locate and identify the well to be sampled. Record pertinent information on appropriate sampling logs, including date, well identification number, weather, time, and sampler's initials. Indicate whether split samples or QA/QC samples are to be collected.
 2. Unlock protective casing and remove well cap. Position the PID at well head upon opening well cap to detect emitted organic vapors. Select appropriate level of personal protection based on IDLHs and TLVs of pertinent chemicals.
 3. Purge well prior to sampling (see FP 2).
 4. Once well is purged, don clean pair of disposable gloves. Tie a new piece of string on the end of a clean disposable or dedicated bailer or, if appropriate, use sampling pump to collect samples.

GROUNDWATER SAMPLE COLLECTION PROCEDURES FROM
MONITORING WELLS

5. Gently lower bailer to depth from which well evacuation was performed. Do not drop the bailer into the well as this causes a water shock effect in the well which could potentially cause sediment to be resuspended or migrate into the well which could affect sample results. Remove at least one bailer volume of water and discard, unless there is not enough water available, in which case a small volume of well water can be used to rinse out the bailer.
6. Collect an aliquot of water to perform field tests such as pH, specific conductance, turbidity, and temperature. Record all readings on appropriate field forms.
7. Proceed to fill sample containers. Samples should generally be collected and containerized in the order of the following volatilization sensitivity:
 - Volatile Organic Compounds (VOCs);
 - Semi-Volatile Organic Compounds (SVOCs);
 - Total organic carbon;
 - Total organic halogens;
 - Extractable organics;
 - Total metals;
 - Dissolved metals;
 - Phenols;
 - Cyanide;
 - Sulfate and chloride;
 - Nitrate and ammonia; and
 - Radionuclides.

When filling VOC sample containers, fill slowly with a continuous stream of water to prevent aeration of the sample. Close sample container and invert to ensure no air bubbles are entrained. Fill remaining sample containers by portioning aliquots of water into each container to ensure homogeneity. Sample containers should be filled over plastic sheeting, a bucket, or a masonry trough, to collect spills or drips.

8. Complete remaining information on field forms.
9. Store samples in coolers with ice at 4°C.

FP 6

GROUNDWATER SAMPLE COLLECTION PROCEDURES FROM
MONITORING WELLS

10. Discard tubing, bailers (if not dedicated), bailer rope, towels, gloves, and other disposable equipment in a plastic garbage bag.
11. Replace well cap and lock protective casing.
12. Store equipment in vehicle .
13. Decontaminate re-usable non-dedicated sampling equipment (see FP 7).

FP 7 DECONTAMINATION PROCEDURES

Scope: This procedure describes the methodology for cleaning of non-dedicated field and sampling equipment.

Purpose: The purpose of describing this procedure is to avoid or limit potential for cross-contamination due to re-use of dirty equipment.

Equipment Needed: Personal protective equipment, non-phosphate soap, deionized water, tap water, scrub brush, abrasive pads (sponge-type pads), paper towels, aluminum foil, plastic bags, equipment to be cleaned, squirt bottles.

Procedures: The general cleaning procedure for cleaning all groundwater sampling equipment is:

1. Mix up soap/water wash.
2. Disassemble all equipment if appropriate.
3. Removal all visible sediment/soil by scrubbing by hand.
4. Wet equipment with tap water.
5. Wash equipment with soapy water using scrub brush, or abrasive pad/sponge to remove all sediment/soil and discoloration.
6. Rinse equipment with tap water.
7. Rinse equipment with deionized water two times.
8. Allow equipment to air dry.
9. When dry - reassemble equipment and wrap in aluminum foil or place in plastic bag to avoid re-contaminating equipment.
10. A rinse blank is required as part of the LTM as a check on the adequacy of the cleaning process. This rinse blank is collected by pouring deionized water over the item of cleaned equipment and catching the water in an appropriate set of sample containers.
11. Decontamination wash water should be collected for proper disposal at the Love Canal Leachate Treatment Facility.

FP 8 HNu CALIBRATION PROCEDURES

Scope: This procedure describes the calibration and use of an H-Nu Model PI 101 Photoionization Detector (PID) for measuring the concentration of trace gases in the atmosphere.

Purpose: The purpose of this procedure is to provide a uniform means for the calibration and operation of the H-Nu PID by field personnel. This is necessary to obtain reliable, accurate and representative readings.

Equipment Needed: H-Nu PID, calibration standard gas cylinder and regulator, short length of 1/4" ID tubing, calibration notebook.

- Procedures:
- Calibration
1. Turn function switch to BATT - check that needle registers in green region of scale indicating battery is charged.
 2. Turn function switch to STANDBY - set zero point with the zero set control.
 3. Turn meter on by turning function switch to one of the three ranges (0-20, 0-200 or 0-2000). Allow meter to warm up for 3-5 minutes.
 4. Determine concentration of calibration standard gas - select proper range on function switch. Attach calibration gas cylinder to probe of H-Nu using tubing attached to regulation on cylinder. Note reading on H-Nu.
 5. Adjust the SPAN control setting to read the ppm concentration of the standard.
 6. Re-check the zero setting (see step #2). If re-adjustment is needed, repeat the calibration in step #5.
 7. Rapid checking of the calibration can be made in the field by attaching the calibration gas cylinder and checking the reading of this gas on the meter.

Meter Usage

1. After calibration, place instrument on STANDBY to prolong battery life and keep meter calibration current.
2. To use meter, turn function switch to desired range. Place meter box level or hold steady. Extend probe tip to location of substance to be measured. Observe and record readings

HNu CALIBRATION PROCEDURES

obtained. Note that air currents and drafts may cause fluctuation in readings.

Note: Moisture and humidity can cause erratic or false H-Nu readings.

Note: More complete instructions and information regarding calibration and use of an H-Nu PID are contained in the Vendors Data in Appendix A.

APPENDIX E

HISTORICAL ANALYTICAL DATA

HISTORICAL ANALYTICAL RESULTS SUMMARY
LOVE CANAL SITE
LONG TERM MONITORING PROGRAM
NIAGARA FALLS, NEW YORK

Sample ID:	7120	7130	7132	7155	7205	8210	9205	3257	12010	3151	7161	52
Collection Date:	05/01/95	05/01/95	05/01/95	05/01/95	05/02/95	05/02/95	05/02/95	05/03/95	Dup. of 3257 05/03/95	05/03/95	05/03/95	05/03/95
Volatiles (µg/L)												
Chloromethane	ND 10	ND 10	ND 10	ND 10	ND 10	ND 10	ND 10	ND 10	ND 10	ND 10	ND 10	ND
Bromomethane	ND 10	ND 10	ND 10	ND 10	ND 10	ND 10	ND 10	ND 10	ND 10	ND 10	ND 10	ND
Vinyl Chloride	ND 10	ND 10	ND 10	ND 10	ND 10	ND 10	ND 10	ND 10	ND 10	ND 10	ND 10	ND
Chloroethane	ND 10	ND 10	ND 10	ND 10	ND 10	ND 10	ND 10	ND 10	ND 10	ND 10	ND 10	ND
Methylene Chloride	ND 10	ND 10	ND 10	ND 10	ND 10	ND 10	ND 10	ND 10	ND 10	ND 10	ND 10	ND
Acetone	ND 10	ND 10	ND 10	ND 10	ND 10	ND 10	ND 10	ND 10	ND 10	ND 10	ND 10	ND
Carbon Disulfide	ND 10	ND 10	ND 10	ND 10	ND 10	ND 10	ND 10	ND 10	ND 10	ND 10	ND 10	ND
1,1-Dichloroethene	ND 10	ND 10	ND 10	ND 10	ND 10	ND 10	ND 10	ND 10	ND 10	ND 10	ND 10	ND
1,1-Dichloroethane	ND 10	ND 10	ND 10	ND 10	ND 10	ND 10	ND 10	ND 10	ND 10	ND 10	ND 10	ND
1,2-Dichloroethene (total)	ND 10	ND 10	ND 10	ND 10	ND 10	ND 10	ND 10	ND 10	ND 10	ND 10	ND 10	ND
Chloroform	ND 10	ND 10	ND 10	ND 10	ND 10	ND 10	ND 10	ND 10	ND 10	ND 10	ND 10	ND
1,2-Dichloroethane	ND 10	ND 10	ND 10	ND 10	ND 10	ND 10	ND 10	ND 10	ND 10	ND 10	ND 10	ND
2-Butanone	ND 10	ND 10	ND 10	ND 10	ND 10	ND 10	ND 10	ND 10	ND 10	ND 10	ND 10	ND
1,1,1-Trichloroethane	ND 10	ND 10	ND 10	ND 10	ND 10	ND 10	ND 10	ND 10	ND 10	ND 10	ND 10	ND
Carbon Tetrachloride	ND 10	ND 10	ND 10	ND 10	ND 10	ND 10	ND 10	ND 10	ND 10	ND 10	ND 10	ND
Bromodichloromethane	ND 10	ND 10	ND 10	ND 10	ND 10	ND 10	ND 10	ND 10	ND 10	ND 10	ND 10	ND
1,2-Dichloropropane	ND 10	ND 10	ND 10	ND 10	ND 10	ND 10	ND 10	ND 10	ND 10	ND 10	ND 10	ND
cis-1,3-Dichloropropene	ND 10	ND 10	ND 10	ND 10	ND 10	ND 10	ND 10	ND 10	ND 10	ND 10	ND 10	ND
Trichloroethene	ND 10	ND 10	ND 10	ND 10	ND 10	ND 10	ND 10	ND 10	ND 10	ND 10	ND 10	ND
Dibromochloromethane	ND 10	ND 10	ND 10	ND 10	ND 10	ND 10	ND 10	ND 10	ND 10	ND 10	ND 10	ND
1,1,2-Trichloroethane	ND 10	ND 10	ND 10	ND 10	ND 10	ND 10	ND 10	ND 10	ND 10	ND 10	ND 10	ND
Benzene	ND 10	ND 10	ND 10	ND 10	ND 10	ND 10	ND 10	ND 10	ND 10	ND 10	ND 10	ND
Trans-1,3-Dichloropropene	ND 10	ND 10	ND 10	ND 10	ND 10	ND 10	ND 10	ND 10	ND 10	ND 10	ND 10	ND
Bromoform	ND 10	ND 10	ND 10	ND 10	ND 10	ND 10	ND 10	ND 10	ND 10	ND 10	ND 10	ND
4-Methyl-2-pentanone	ND 10	ND 10	ND 10	ND 10	ND 10	ND 10	ND 10	ND 10	ND 10	ND 10	ND 10	ND
2-Hexanone	ND 10	ND 10	ND 10	ND 10	ND 10	ND 10	ND 10	ND 10	ND 10	ND 10	ND 10	ND
Tetrachloroethene	ND 10	ND 10	ND 10	ND 10	ND 10	ND 10	ND 10	ND 10	ND 10	ND 10	ND 10	ND
1,1,2,2-Tetrachloroethane	ND 10	ND 10	ND 10	ND 10	ND 10	ND 10	ND 10	ND 10	ND 10	ND 10	ND 10	ND
Toluene	ND 10	ND 10	ND 10	ND 10	ND 10	ND 10	ND 10	ND 10	ND 10	ND 10	ND 10	ND
Chlorobenzene	ND 10	ND 10	ND 10	ND 10	ND 10	ND 10	ND 10	ND 10	ND 10	ND 10	ND 10	ND
Ethylbenzene	ND 10	ND 10	ND 10	ND 10	ND 10	ND 10	ND 10	ND 10	ND 10	ND 10	ND 10	ND
Styrene	ND 10	ND 10	ND 10	ND 10	ND 10	ND 10	ND 10	ND 10	ND 10	ND 10	ND 10	ND
Xylene (total)	ND 10	ND 10	ND 10	ND 10	ND 10	ND 10	ND 10	ND 10	ND 10	ND 10	ND 10	ND
Vinyl Acetate	ND 10	ND 10	ND 10	ND 10	ND 10	ND 10	ND 10	ND 10	ND 10	ND 10	ND 10	ND
2-Chloroethylvinylether	ND 10	ND 10	ND 10	ND 10	ND 10	ND 10	ND 10	ND 10	ND 10	ND 10	ND 10	ND

HISTORICAL ANALYTICAL RESULTS SUMMARY
LOVE CANAL SITE
LONG TERM MONITORING PROGRAM
NIAGARA FALLS, NEW YORK

<i>Sample ID:</i>	7120	7130	7132	7155	7205	8210	9205	3257	12010	3151	7161	52
<i>Collection Date:</i>	05/01/95	05/01/95	05/01/95	05/01/95	05/02/95	05/02/95	05/02/95	05/03/95	Dup. of 3257 05/03/95	05/03/95	05/03/95	05/03/95
<i>Semi-Volatiles (µg/L)</i>												
Phenol	ND 10	ND 10	ND 10	ND 10	ND 10	ND 10	ND 10	ND 11	ND 10	ND 10	ND 10	ND
bis(2-Chloroethyl)ether	ND 10	ND 10	ND 10	ND 10	ND 10	ND 10	ND 10	ND 11	ND 10	ND 10	ND 10	ND
2-Chlorophenol	ND 10	ND 10	ND 10	ND 10	ND 10	ND 10	ND 10	ND 11	ND 10	ND 10	ND 10	ND
1,3-Dichlorobenzene	ND 10	ND 10	ND 10	ND 10	ND 10	ND 10	ND 10	ND 11	ND 10	ND 10	ND 10	ND
1,4-Dichlorobenzene	ND 10	ND 10	ND 10	ND 10	ND 10	ND 10	ND 10	ND 11	ND 10	ND 10	ND 10	ND
1,2-Dichlorobenzene	ND 10	ND 10	ND 10	ND 10	ND 10	ND 10	ND 10	ND 11	ND 10	ND 10	ND 10	ND
2-Methylphenol	ND 10	ND 10	ND 10	ND 10	ND 10	ND 10	ND 10	ND 11	ND 10	ND 10	ND 10	ND
2,2'-oxybis(1-Chloropropane)	ND 10	ND 10	ND 10	ND 10	ND 10	ND 10	ND 10	ND 11	ND 10	ND 10	ND 10	ND
4-Methylphenol	ND 10	ND 10	ND 10	ND 10	ND 10	ND 10	ND 10	ND 11	ND 10	ND 10	ND 10	ND
N-Nitroso-di-n-propylamine	ND 10	ND 10	ND 10	ND 10	ND 10	ND 10	ND 10	ND 11	ND 10	ND 10	ND 10	ND
Hexachloroethane	ND 10	ND 10	ND 10	ND 10	ND 10	ND 10	ND 10	ND 11	ND 10	ND 10	ND 10	ND
Nitrobenzene	ND 10	ND 10	ND 10	ND 10	ND 10	ND 10	ND 10	ND 11	ND 10	ND 10	ND 10	ND
Isophorone	ND 10	ND 10	ND 10	ND 10	ND 10	ND 10	ND 10	ND 11	ND 10	ND 10	ND 10	ND
2-Nitrophenol	ND 10	ND 10	ND 10	ND 10	ND 10	ND 10	ND 10	ND 11	ND 10	ND 10	ND 10	ND
2,4-Dimethylphenol	ND 10	ND 10	ND 10	ND 10	ND 10	ND 10	ND 10	ND 11	ND 10	ND 10	ND 10	ND
bis(2-Chloroethoxy)methane	ND 10	ND 10	ND 10	ND 10	ND 10	ND 10	ND 10	ND 11	ND 10	ND 10	ND 10	ND
2,4-Dichlorophenol	ND 10	ND 10	ND 10	ND 10	ND 10	ND 10	ND 10	ND 11	ND 10	ND 10	ND 10	ND
1,2,4-Trichlorobenzene	ND 10	ND 10	ND 10	ND 10	ND 10	ND 10	ND 10	ND 11	ND 10	ND 10	ND 10	ND
Naphthalene	ND 10	ND 10	ND 10	ND 10	ND 10	ND 10	ND 10	ND 11	ND 10	ND 10	ND 10	ND
4-Chloroaniline	ND 10	ND 10	ND 10	ND 10	ND 10	ND 10	ND 10	ND 11	ND 10	ND 10	ND 10	ND
Hexachlorobutadiene	ND 10	ND 10	ND 10	ND 10	ND 10	ND 10	ND 10	ND 11	ND 10	ND 10	ND 10	ND
4-Chloro-3-methylphenol	ND 10	ND 10	ND 10	ND 10	ND 10	ND 10	ND 10	ND 11	ND 10	ND 10	ND 10	ND
2-Methylnaphthalene	ND 10	ND 10	ND 10	ND 10	ND 10	ND 10	ND 10	ND 11	ND 10	ND 10	ND 10	ND
Hexachlorocyclopentadiene	ND 10	ND 10	ND 10	ND 10	ND 10	ND 10	ND 10	ND 11	ND 10	ND 10	ND 10	ND
2,4,6-Trichlorophenol	ND 10	ND 10	ND 10	ND 10	ND 10	ND 10	ND 10	ND 11	ND 10	ND 10	ND 10	ND
2,4,5-Trichlorophenol	ND 26	ND 26	ND 26	ND 26	ND 26	ND 26	ND 26	ND 26	ND 26	ND 26	ND 26	ND
2-Chloronaphthalene	ND 10	ND 10	ND 10	ND 10	ND 10	ND 10	ND 10	ND 11	ND 10	ND 10	ND 10	ND
2-Nitroaniline	ND 26	ND 26	ND 26	ND 26	ND 26	ND 26	ND 26	ND 26	ND 26	ND 26	ND 26	ND
Dimethylphthalate	ND 10	ND 10	ND 10	ND 10	ND 10	ND 10	ND 10	ND 11	ND 10	ND 10	ND 10	ND
Acenaphthylene	ND 10	ND 10	ND 10	ND 10	ND 10	ND 10	ND 10	ND 11	ND 10	ND 10	ND 10	ND
2,6-Dinitrotoluene	ND 10	ND 10	ND 10	ND 10	ND 10	ND 10	ND 10	ND 11	ND 10	ND 10	ND 10	ND
3-Nitroaniline	ND 26	ND 26	ND 26	ND 26	ND 26	ND 26	ND 26	ND 26	ND 26	ND 26	ND 26	ND
Acenaphthene	ND 10	ND 10	ND 10	ND 10	ND 10	ND 10	ND 10	ND 11	ND 10	ND 10	ND 10	ND
2,4-Dinitrophenol	ND 26	ND 26	ND 26	ND 26	ND 26	ND 26	ND 26	ND 26	ND 26	ND 26	ND 26	ND
4-Nitrophenol	ND 26	ND 26	ND 26	ND 26	ND 26	ND 26	ND 26	ND 26	ND 26	ND 26	ND 26	ND
Dibenzofuran	ND 10	ND 10	ND 10	ND 10	ND 10	ND 10	ND 10	ND 11	ND 10	ND 10	ND 10	ND
2,4-Dinitrotoluene	ND 10	ND 10	ND 10	ND 10	ND 10	ND 10	ND 10	ND 11	ND 10	ND 10	ND 10	ND
Diethylphthalate	ND 10	ND 10	ND 10	ND 10	ND 10	ND 10	ND 10	ND 11	ND 10	ND 10	ND 10	ND
4-Chlorophenyl-phenylether	ND 10	ND 10	ND 10	ND 10	ND 10	ND 10	ND 10	ND 11	ND 10	ND 10	ND 10	ND

**HISTORICAL ANALYTICAL RESULTS SUMMARY
LOVE CANAL SITE
LONG TERM MONITORING PROGRAM
NIAGARA FALLS, NEW YORK**

<i>Sample ID:</i>	7120	7130	7132	7155	7205	8210	9205	3257	12010	3151	7161	52
<i>Collection Date:</i>	05/01/95	05/01/95	05/01/95	05/01/95	05/02/95	05/02/95	05/02/95	05/03/95	Dup. of 3257 05/03/95	05/03/95	05/03/95	05/6
<i>Semi-Volatiles (µg/L)</i>												
Fluorene	ND 10	ND 10	ND 10	ND 10	ND 10	ND 10	ND 10	ND 11	ND 10	ND 10	ND 10	ND
4-Nitroaniline	ND 26	ND 26	ND 26	ND 26	ND 26	ND 26	ND 26	ND 26	ND 26	ND 26	ND 26	ND
4,6-Dinitro-2-methylphenol	ND 26	ND 26	ND 26	ND 26	ND 26	ND 26	ND 26	ND 26	ND 26	ND 26	ND 26	ND
N-Nitrosodiphenylamine (1)	ND 10	ND 10	ND 10	ND 10	ND 10	ND 10	ND 10	ND 11	ND 10	ND 10	ND 10	ND
4-Bromophenyl-phenylether	ND 10	ND 10	ND 10	ND 10	ND 10	ND 10	ND 10	ND 11	ND 10	ND 10	ND 10	ND
Hexachlorobenzene	ND 10	ND 10	ND 10	ND 10	ND 10	ND 10	ND 10	ND 11	ND 10	ND 10	ND 10	ND
Pentachlorophenol	ND 26	ND 26	ND 26	ND 26	ND 26	ND 26	ND 26	ND 26	ND 26	ND 26	ND 26	ND
Phenanthrene	ND 10	ND 10	ND 10	ND 10	ND 10	ND 10	ND 10	ND 11	ND 10	ND 10	ND 10	ND
Anthracene	ND 10	ND 10	ND 10	ND 10	ND 10	ND 10	ND 10	ND 11	ND 10	ND 10	ND 10	ND
Di-n-butylphthalate	ND 10	ND 10	ND 10	ND 10	ND 10	ND 10	ND 10	ND 11	ND 10	ND 10	ND 10	ND
Fluoranthene	ND 10	ND 10	ND 10	ND 10	ND 10	ND 10	ND 10	ND 11	ND 10	ND 10	ND 10	ND
Pyrene	ND 10	ND 10	ND 10	ND 10	ND 10	ND 10	ND 10	ND 11	ND 10	ND 10	ND 10	ND
Butylbenzylphthalate	ND 10	ND 10	ND 10	ND 10	ND 10	ND 10	ND 10	ND 11	ND 10	ND 10	ND 10	ND
3,3'-Dichlorobenzidine	ND 10	ND 10	ND 10	ND 10	ND 10	ND 10	ND 10	ND 11	ND 10	ND 10	ND 10	ND
Benzo(a)anthracene	ND 10	ND 10	ND 10	ND 10	ND 10	ND 10	ND 10	ND 11	ND 10	ND 10	ND 10	ND
Chrysene	ND 10	ND 10	ND 10	ND 10	ND 10	ND 10	ND 10	ND 11	ND 10	ND 10	ND 10	ND
bis(2-Ethylhexyl)phthalate	ND 10	51	ND 10	46	40	ND 10	20	11	13	44	ND 10	ND
Di-n-octyl phthalate	ND 10	ND 10	ND 10	ND 10	ND 10	ND 10	ND 10	ND 11	ND 10	ND 10	ND 10	ND
Benzo(b)fluoranthene	ND 10	ND 10	ND 10	ND 10	ND 10	ND 10	ND 10	ND 11	ND 10	ND 10	ND 10	ND
Benzo(k)fluoranthene	ND 10	ND 10	ND 10	ND 10	ND 10	ND 10	ND 10	ND 11	ND 10	ND 10	ND 10	ND
Benzo(a)pyrene	ND 10	ND 10	ND 10	ND 10	ND 10	ND 10	ND 10	ND 11	ND 10	ND 10	ND 10	ND
Indeno(1,2,3-cd)pyrene	ND 10	ND 10	ND 10	ND 10	ND 10	ND 10	ND 10	ND 11	ND 10	ND 10	ND 10	ND
Dibenz(a,h)anthracene	ND 10	ND 10	ND 10	ND 10	ND 10	ND 10	ND 10	ND 11	ND 10	ND 10	ND 10	ND
Benzo(g,h,i)perylene	ND 10	ND 10	ND 10	ND 10	ND 10	ND 10	ND 10	ND 11	ND 10	ND 10	ND 10	ND
Benzyl alcohol	ND 10	ND 10	ND 10	ND 10	ND 10	ND 10	ND 10	ND 11	ND 10	ND 10	ND 10	ND
Benzoic acid	ND 51	ND 52	ND 52	ND 52	ND 51	ND 52	ND 52	ND 53	ND 51	ND 51	ND 51	ND

**HISTORICAL ANALYTICAL RESULTS SUMMARY
LOVE CANAL SITE
LONG TERM MONITORING PROGRAM
NIAGARA FALLS, NEW YORK**

<i>Sample ID:</i>	7120	7130	7132	7155	7205	8210	9205	3257	12010 <i>Dup. of 3257</i>	3151	7161	52
<i>Collection Date:</i>	05/01/95	05/01/95	05/01/95	05/01/95	05/02/95	05/02/95	05/02/95	05/03/95	05/03/95	05/03/95	05/03/95	05/03/95
<i>Pesticides/PCBs (µg/L)</i>												
Alpha-BHC	ND 0.050	ND 0.052	ND 0.052	ND 0.050	ND 0.050	ND 0.051	ND 0.052	ND 0.050	ND 0.050	ND 0.050	ND 0.050	
Beta-BHC	ND 0.050	ND 0.052	ND 0.052	ND 0.050	ND 0.050	ND 0.051	ND 0.052	ND 0.050	ND 0.050	ND 0.050	ND 0.050	ND
Delta-BHC	ND 0.050	ND 0.052	ND 0.052	ND 0.050	ND 0.050	ND 0.051	ND 0.052	ND 0.050	ND 0.050	ND 0.050	ND 0.050	ND
gamma-BHC (Lindane)	ND 0.050	ND 0.052	ND 0.052	ND 0.050	ND 0.050	ND 0.051	ND 0.052	ND 0.050	ND 0.050	ND 0.050	ND 0.050	ND
Heptachlor	ND 0.050	ND 0.052	ND 0.052	ND 0.050	ND 0.050	ND 0.051	ND 0.052	ND 0.050	ND 0.050	ND 0.050	ND 0.050	ND
Aldrin	ND 0.050	ND 0.052	ND 0.052	ND 0.050	ND 0.050	ND 0.051	ND 0.052	ND 0.050	ND 0.050	ND 0.050	ND 0.050	ND
Heptachlor epoxide	ND 0.050	ND 0.052	ND 0.052	ND 0.050	ND 0.050	ND 0.051	ND 0.052	ND 0.050	ND 0.050	ND 0.050	ND 0.050	ND
Endosulfan I	ND 0.050	ND 0.052	ND 0.052	ND 0.050	ND 0.050	ND 0.051	ND 0.052	ND 0.050	ND 0.050	ND 0.050	ND 0.050	ND
Dieldrin	ND 0.10	ND 0.10	ND 0.10	ND 0.10	ND 0.10	ND 0.10	ND 0.10	ND 0.10	ND 0.10	ND 0.10	ND 0.10	ND
4,4'-DDE	ND 0.10	ND 0.10	ND 0.10	ND 0.10	ND 0.10	ND 0.10	ND 0.10	ND 0.10	ND 0.10	ND 0.10	ND 0.10	ND
Endrin	ND 0.10	ND 0.10	ND 0.10	ND 0.10	ND 0.10	ND 0.10	ND 0.10	ND 0.10	ND 0.10	ND 0.10	ND 0.10	ND
Endosulfan II	ND 0.10	ND 0.10	ND 0.10	ND 0.10	ND 0.10	ND 0.10	ND 0.10	ND 0.10	ND 0.10	ND 0.10	ND 0.10	ND
4,4'-DDD	ND 0.10	ND 0.10	ND 0.10	ND 0.10	ND 0.10	ND 0.10	ND 0.10	ND 0.10	ND 0.10	ND 0.10	ND 0.10	ND
Endosulfan sulfate	ND 0.10	ND 0.10	ND 0.10	ND 0.10	ND 0.10	ND 0.10	ND 0.10	ND 0.10	ND 0.10	ND 0.10	ND 0.10	ND
4,4'-DDT	ND 0.10	ND 0.10	ND 0.10	ND 0.10	ND 0.10	ND 0.10	ND 0.10	ND 0.10	ND 0.10	ND 0.10	ND 0.10	ND
Methoxychlor	ND 0.50	ND 0.52	ND 0.52	ND 0.50	ND 0.50	ND 0.51	ND 0.52	ND 0.50	ND 0.50	ND 0.50	ND 0.50	ND
Endrin ketone	ND 0.10	ND 0.10	ND 0.10	ND 0.10	ND 0.10	ND 0.10	ND 0.10	ND 0.10	ND 0.10	ND 0.10	ND 0.10	ND
alpha-Chlordane	ND 0.050	ND 0.052	ND 0.052	ND 0.050	ND 0.050	ND 0.051	ND 0.052	ND 0.050	ND 0.050	ND 0.050	ND 0.050	ND
gamma-Chlordane	ND 0.050	ND 0.052	ND 0.052	ND 0.050	ND 0.050	ND 0.051	ND 0.052	ND 0.050	ND 0.050	ND 0.050	ND 0.050	ND
Toxaphene	ND 5.0	ND 5.2	ND 5.2	ND 5.0	ND 5.0	ND 5.1	ND 5.2	ND 5.0	ND 5.0	ND 5.0	ND 5.0	ND
Aroclor-1016	ND 1.0	ND 1.0	ND 1.0	ND 1.0	ND 1.0	ND 1.0	ND 1.0	ND 1.0	ND 1.0	ND 1.0	ND 1.0	ND
Aroclor-1221	ND 2.0	ND 2.1	ND 2.1	ND 2.0	ND 2.0	ND 2.0	ND 2.1	ND 2.0	ND 2.0	ND 2.0	ND 2.0	ND
Aroclor-1232	ND 1.0	ND 1.0	ND 1.0	ND 1.0	ND 1.0	ND 1.0	ND 1.0	ND 1.0	ND 1.0	ND 1.0	ND 1.0	ND
Aroclor-1242	ND 1.0	ND 1.0	ND 1.0	ND 1.0	ND 1.0	ND 1.0	ND 1.0	ND 1.0	ND 1.0	ND 1.0	ND 1.0	ND
Aroclor-1248	ND 1.0	ND 1.0	ND 1.0	ND 1.0	ND 1.0	ND 1.0	ND 1.0	ND 1.0	ND 1.0	ND 1.0	ND 1.0	ND
Aroclor-1254	ND 1.0	ND 1.0	ND 1.0	ND 1.0	ND 1.0	ND 1.0	ND 1.0	ND 1.0	ND 1.0	ND 1.0	ND 1.0	ND
Aroclor-1260	ND 1.0	ND 1.0	ND 1.0	ND 1.0	ND 1.0	ND 1.0	ND 1.0	ND 1.0	ND 1.0	ND 1.0	ND 1.0	ND

Notes:
 ND Non-detect at or above the associated value.
 J Associated value is estimated.
 D Associated value is from a dilution.

HISTORICAL ANALYTICAL RESULTS SUMMARY
LOVE CANAL SITE
LONG TERM MONITORING PROGRAM
NIAGARA FALLS, NEW YORK

<i>Sample ID:</i>	222	8110	8120	8130	8140	9110	9115	9118	10272	12015 <i>Dup. of 9115</i>	10278	9120
<i>Collection Date:</i>	74/95	05/04/95	05/04/95	05/05/95	05/05/95	05/05/95	05/08/95	05/08/95	05/08/95	05/08/95	05/09/95	05/12/95
Volatiles (µg/L)												
Chloromethane	10	ND 10	ND 10	ND 10	ND 10	ND 10	ND 10	ND 10	ND 10	ND 10	ND 10	ND 10
Bromomethane	10	ND 10	ND 10	ND 10	ND 10	ND 10	ND 10	ND 10	ND 10	ND 10	ND 10	ND 10
Vinyl Chloride	10	ND 10	ND 10	ND 10	ND 10	ND 10	ND 10	ND 10	ND 10	ND 10	ND 10	ND 10
Chloroethane	10	ND 10	ND 10	ND 10	ND 10	ND 10	ND 10	ND 10	ND 10	ND 10	ND 10	ND 10
Methylene Chloride	10	ND 10	ND 10	ND 10	ND 10	ND 10	ND 10	ND 10	ND 10	ND 10	ND 10	ND 10
Acetone	10	ND 10	ND 10	ND 10	ND 10	ND 10	ND 10	ND 10	ND 10	ND 10	ND 31	ND 10
Carbon Disulfide	10	ND 10	ND 10	ND 10	ND 10	ND 10	ND 10	ND 10	ND 10	ND 10	ND 10	ND 10
1,1-Dichloroethene	10	ND 10	ND 10	ND 10	ND 10	ND 10	ND 10	ND 10	ND 10	ND 10	ND 10	ND 10
1,1-Dichloroethane	10	ND 10	ND 10	ND 10	ND 10	ND 10	ND 10	ND 10	ND 10	ND 10	ND 10	ND 10
1,2-Dichloroethene (total)	10	ND 10	ND 10	ND 10	ND 10	ND 10	ND 10	ND 10	ND 10	ND 10	ND 10	ND 10
Chloroform	10	ND 10	ND 10	ND 10	ND 10	ND 10	ND 10	ND 10	ND 10	ND 10	ND 10	ND 10
1,2-Dichloroethane	10	ND 10	ND 10	ND 10	ND 10	ND 10	ND 10	ND 10	ND 10	ND 10	ND 10	ND 10
2-Butanone	10	ND 10	ND 10	ND 10	ND 10	ND 10	ND 10	ND 10	ND 10	ND 10	ND 10	ND 10
1,1,1-Trichloroethane	10	ND 10	ND 10	ND 10	ND 10	ND 10	ND 10	ND 10	ND 10	ND 10	ND 10	ND 10
Carbon Tetrachloride	10	ND 10	ND 10	ND 10	ND 10	ND 10	ND 10	ND 10	ND 10	ND 10	ND 10	ND 10
Bromodichloromethane	10	ND 10	ND 10	ND 10	ND 10	ND 10	ND 10	ND 10	ND 10	ND 10	ND 10	ND 10
1,2-Dichloropropane	10	ND 10	ND 10	ND 10	ND 10	ND 10	ND 10	ND 10	ND 10	ND 10	ND 10	ND 10
cis-1,3-Dichloropropene	10	ND 10	ND 10	ND 10	ND 10	ND 10	ND 10	ND 10	ND 10	ND 10	ND 10	ND 10
Trichloroethene	10	ND 10	ND 10	ND 10	ND 10	ND 10	ND 10	ND 10	ND 10	ND 10	ND 10	ND 10
Dibromochloromethane	10	ND 10	ND 10	ND 10	ND 10	ND 10	ND 10	ND 10	ND 10	ND 10	ND 10	ND 10
1,1,2-Trichloroethane	10	ND 10	ND 10	ND 10	ND 10	ND 10	ND 10	ND 10	ND 10	ND 10	ND 10	ND 10
Benzene	10	ND 10	ND 10	ND 10	ND 10	ND 10	ND 10	ND 10	ND 10	ND 10	ND 10	ND 10
Trans-1,3-Dichloropropene	10	ND 10	ND 10	ND 10	ND 10	ND 10	ND 10	ND 10	ND 10	ND 10	ND 10	ND 10
Bromoform	10	ND 10	ND 10	ND 10	ND 10	ND 10	ND 10	ND 10	ND 10	ND 10	ND 10	ND 10
4-Methyl-2-pentanone	10	ND 10	ND 10	ND 10	ND 10	ND 10	ND 10	ND 10	ND 10	ND 10	ND 10	ND 10
2-Hexanone	10	ND 10	ND 10	ND 10	ND 10	ND 10	ND 10	ND 10	ND 10	ND 10	ND 10	ND 10
Tetrachloroethene	10	ND 10	ND 10	ND 10	ND 10	ND 10	ND 10	ND 10	ND 10	ND 10	ND 10	ND 10
1,1,2,2-Tetrachloroethane	10	ND 10	ND 10	ND 10	ND 10	ND 10	ND 10	ND 10	ND 10	ND 10	ND 10	ND 10
Toluene	10	ND 10	ND 10	ND 10	ND 10	ND 10	ND 10	ND 10	ND 10	ND 10	ND 10	ND 10
Chlorobenzene	10	ND 10	ND 10	ND 10	ND 10	ND 10	ND 10	ND 10	ND 10	ND 10	ND 10	ND 10
Ethylbenzene	10	ND 10	ND 10	ND 10	ND 10	ND 10	ND 10	ND 10	ND 10	ND 10	ND 10	ND 10
Styrene	10	ND 10	ND 10	ND 10	ND 10	ND 10	ND 10	ND 10	ND 10	ND 10	ND 10	ND 10
Xylene (total)	10	ND 10	ND 10	ND 10	ND 10	ND 10	ND 10	ND 10	ND 10	ND 10	ND 10	ND 10
Vinyl Acetate	10	ND 10	ND 10	ND 10	ND 10	ND 10	ND 10	ND 10	ND 10	ND 10	ND 10	ND 10
2-Chloroethylvinylether	10	ND 10	ND 10	ND 10	ND 10	ND 10	ND 10	ND 10	ND 10	ND 10	ND 10	ND 10

HISTORICAL ANALYTICAL RESULTS SUMMARY
LOVE CANAL SITE
LONG TERM MONITORING PROGRAM
NIAGARA FALLS, NEW YORK

<i>Sample ID:</i>	222	8110	8120	8130	8140	9110	9115	9118	10272	12015	10278	9120
<i>Collection Date:</i>	74/95	05/04/95	05/04/95	05/05/95	05/05/95	05/05/95	05/08/95	05/08/95	05/08/95	Dup. of 9115 05/08/95	05/09/95	05/12/95
Semi-Volatiles (µg/L)												
Phenol	10	ND 10	ND 10	ND 10	ND 10	ND 10	ND 10	ND 10	ND 10	ND 10	ND 10	ND 10
bis(2-Chloroethyl)ether	10	ND 10	ND 10	ND 10	ND 10	ND 10	ND 10	ND 10	ND 10	ND 10	ND 10	ND 10
2-Chlorophenol	10	ND 10	ND 10	ND 10	ND 10	ND 10	ND 10	ND 10	ND 10	ND 10	ND 10	ND 10
1,3-Dichlorobenzene	10	ND 10	ND 10	ND 10	ND 10	ND 10	ND 10	ND 10	ND 10	ND 10	ND 10	ND 10
1,4-Dichlorobenzene	10	ND 10	ND 10	ND 10	ND 10	ND 10	ND 10	ND 10	ND 10	ND 10	ND 10	ND 10
1,2-Dichlorobenzene	10	ND 10	ND 10	ND 10	ND 10	ND 10	ND 10	ND 10	ND 10	ND 10	ND 10	ND 10
2-Methylphenol	10	ND 10	ND 10	ND 10	ND 10	ND 10	ND 10	ND 10	ND 10	ND 10	ND 10	ND 10
2,2'-oxybis(1-Chloropropane)	10	ND 10	ND 10	ND 10	ND 10	ND 10	ND 10	ND 10	ND 10	ND 10	ND 10	ND 10
4-Methylphenol	10	ND 10	ND 10	ND 10	ND 10	ND 10	ND 10	ND 10	ND 10	ND 10	ND 10	ND 10
N-Nitroso-di-n-propylamine	10	ND 10	ND 10	ND 10	ND 10	ND 10	ND 10	ND 10	ND 10	ND 10	ND 10	ND 10
Hexachloroethane	10	ND 10	ND 10	ND 10	ND 10	ND 10	ND 10	ND 10	ND 10	ND 10	ND 10	ND 10
Nitrobenzene	10	ND 10	ND 10	ND 10	ND 10	ND 10	ND 10	ND 10	ND 10	ND 10	ND 10	ND 10
Isophorone	10	ND 10	ND 10	ND 10	ND 10	ND 10	ND 10	ND 10	ND 10	ND 10	ND 10	ND 10
2-Nitrophenol	10	ND 10	ND 10	ND 10	ND 10	ND 10	ND 10	ND 10	ND 10	ND 10	ND 10	ND 10
2,4-Dimethylphenol	10	ND 10	ND 10	ND 10	ND 10	ND 10	ND 10	ND 10	ND 10	ND 10	ND 10	ND 10
bis(2-Chloroethoxy)methane	10	ND 10	ND 10	ND 10	ND 10	ND 10	ND 10	ND 10	ND 10	ND 10	ND 10	ND 10
2,4-Dichlorophenol	10	ND 10	ND 10	ND 10	ND 10	ND 10	ND 10	ND 10	ND 10	ND 10	ND 10	ND 10
1,2,4-Trichlorobenzene	10	ND 10	ND 10	ND 10	ND 10	ND 10	ND 10	ND 10	ND 10	ND 10	ND 10	ND 10
Naphthalene	10	ND 10	ND 10	ND 10	ND 10	ND 10	ND 10	ND 10	ND 10	ND 10	ND 10	ND 10
4-Chloroaniline	10	ND 10	ND 10	ND 10	ND 10	ND 10	ND 10	ND 10	ND 10	ND 10	ND 10	ND 10
Hexachlorobutadiene	10	ND 10	ND 10	ND 10	ND 10	ND 10	ND 10	ND 10	ND 10	ND 10	ND 10	ND 10
4-Chloro-3-methylphenol	10	ND 10	ND 10	ND 10	ND 10	ND 10	ND 10	ND 10	ND 10	ND 10	ND 10	ND 10
2-Methylnaphthalene	10	ND 10	ND 10	ND 10	ND 10	ND 10	ND 10	ND 10	ND 10	ND 10	ND 10	ND 10
Hexachlorocyclopentadiene	10	ND 10	ND 10	ND 10	ND 10	ND 10	ND 10	ND 10	ND 10	ND 10	ND 10	ND 10
2,4,6-Trichlorophenol	10	ND 10	ND 10	ND 10	ND 10	ND 10	ND 10	ND 10	ND 10	ND 10	ND 10	ND 10
2,4,5-Trichlorophenol	26	ND 26	ND 26	ND 26	ND 26	ND 26	ND 25	ND 26	ND 26	ND 25	ND 25	ND 26
2-Chloronaphthalene	10	ND 10	ND 10	ND 10	ND 10	ND 10	ND 10	ND 10	ND 10	ND 10	ND 10	ND 10
2-Nitroaniline	26	ND 26	ND 26	ND 26	ND 26	ND 26	ND 25	ND 26	ND 26	ND 25	ND 25	ND 26
Dimethylphthalate	10	ND 10	ND 10	ND 10	ND 10	ND 10	ND 10	ND 10	ND 10	ND 10	ND 10	ND 10
Acenaphthylene	10	ND 10	ND 10	ND 10	ND 10	ND 10	ND 10	ND 10	ND 10	ND 10	ND 10	ND 10
2,6-Dinitrotoluene	10	ND 10	ND 10	ND 10	ND 10	ND 10	ND 10	ND 10	ND 10	ND 10	ND 10	ND 10
3-Nitroaniline	26	ND 26	ND 26	ND 26	ND 26	ND 26	ND 25	ND 26	ND 26	ND 25	ND 25	ND 26
Acenaphthene	10	ND 10	ND 10	ND 10	ND 10	ND 10	ND 10	ND 10	ND 10	ND 10	ND 10	ND 10
2,4-Dinitrophenol	26	ND 26	ND 26	ND 26	ND 26	ND 26	ND 25	ND 26	ND 26	ND 25	ND 25	ND 26
4-Nitrophenol	26	ND 26	ND 26	ND 26	ND 26	ND 26	ND 25	ND 26	ND 26	ND 25	ND 25	ND 26
Dibenzofuran	10	ND 10	ND 10	ND 10	ND 10	ND 10	ND 10	ND 10	ND 10	ND 10	ND 10	ND 10
2,4-Dinitrotoluene	10	ND 10	ND 10	ND 10	ND 10	ND 10	ND 10	ND 10	ND 10	ND 10	ND 10	ND 10
Diethylphthalate	10	ND 10	ND 10	ND 10	ND 10	ND 10	ND 10	ND 10	ND 10	ND 10	ND 10	ND 10
4-Chlorophenyl-phenylether	10	ND 10	ND 10	ND 10	ND 10	ND 10	ND 10	ND 10	ND 10	ND 10	ND 10	ND 10

HISTORICAL ANALYTICAL RESULTS SUMMARY
LOVE CANAL SITE
LONG TERM MONITORING PROGRAM
NIAGARA FALLS, NEW YORK

Sample ID:	222	8110	8120	8130	8140	9110	9115	9118	10272	12015	10278	9120
Collection Date:	7/4/95	05/04/95	05/04/95	05/05/95	05/05/95	05/05/95	05/08/95	05/08/95	05/08/95	Dup. of 9115 05/08/95	05/09/95	05/12/95
<i>Semi-Volatiles (µg/L)</i>												
Fluorene	10	ND 10	ND 10	ND 10	ND 10	ND 10	ND 10	ND 10	ND 10	ND 10	ND 10	ND 10
4-Nitroaniline	26	ND 26	ND 26	ND 26	ND 26	ND 26	ND 25	ND 26	ND 26	ND 25	ND 25	ND 26
4,6-Dinitro-2-methylphenol	26	ND 26	ND 26	ND 26	ND 26	ND 26	ND 25	ND 26	ND 26	ND 25	ND 25	ND 26
N-Nitrosodiphenylamine (1)	10	ND 10	ND 10	ND 10	ND 10	ND 10	ND 10	ND 10	ND 10	ND 10	ND 10	ND 10
4-Bromophenyl-phenylether	10	ND 10	ND 10	ND 10	ND 10	ND 10	ND 10	ND 10	ND 10	ND 10	ND 10	ND 10
Hexachlorobenzene	10	ND 10	ND 10	ND 10	ND 10	ND 10	ND 10	ND 10	ND 10	ND 10	ND 10	ND 10
Pentachlorophenol	26	ND 26	ND 26	ND 26	ND 26	ND 26	ND 25	ND 26	ND 26	ND 25	ND 25	ND 26
Phenanthrene	10	ND 10	ND 10	ND 10	ND 10	ND 10	ND 10	ND 10	ND 10	ND 10	ND 10	ND 10
Anthracene	10	ND 10	ND 10	ND 10	ND 10	ND 10	ND 10	ND 10	ND 10	ND 10	ND 10	ND 10
Di-n-butylphthalate	10	ND 10	ND 10	ND 10	ND 10	ND 10	ND 10	ND 10	ND 10	ND 10	ND 10	ND 10
Fluoranthene	10	ND 10	ND 10	ND 10	ND 10	ND 10	ND 10	ND 10	ND 10	ND 10	ND 10	ND 10
Pyrene	10	ND 10	ND 10	ND 10	ND 10	ND 10	ND 10	ND 10	ND 10	ND 10	ND 10	ND 10
Butylbenzylphthalate	10	ND 10	ND 10	ND 10	ND 10	ND 10	ND 10	ND 10	ND 10	ND 10	ND 10	ND 10
3,3'-Dichlorobenzidine	10	ND 10	ND 10	ND 10	ND 10	ND 10	ND 10	ND 10	ND 10	ND 10	ND 10	ND 10
Benzo(a)anthracene	10	ND 10	ND 10	ND 10	ND 10	ND 10	ND 10	ND 10	ND 10	ND 10	ND 10	ND 10
Chrysene	10	ND 10	ND 10	ND 10	ND 10	ND 10	ND 10	ND 10	ND 10	ND 10	ND 10	ND 10
bis(2-Ethylhexyl)phthalate	59	ND 10	ND 10	24	32	ND 10	12	150D	200D	ND 10	ND 10	ND 36
Di-n-octyl phthalate	10	ND 10	ND 10	ND 10	ND 10	ND 10	ND 10	ND 10	ND 10	ND 10	ND 10	ND 10
Benzo(b)fluoranthene	10	ND 10	ND 10	ND 10	ND 10	ND 10	ND 10	ND 10	ND 10	ND 10	ND 10	ND 10
Benzo(k)fluoranthene	10	ND 10	ND 10	ND 10	ND 10	ND 10	ND 10	ND 10	ND 10	ND 10	ND 10	ND 10
Benzo(a)pyrene	10	ND 10	ND 10	ND 10	ND 10	ND 10	ND 10	ND 10	ND 10	ND 10	ND 10	ND 10
Indeno(1,2,3-cd)pyrene	10	ND 10	ND 10	ND 10	ND 10	ND 10	ND 10	ND 10	ND 10	ND 10	ND 10	ND 10
Dibenz(a,h)anthracene	10	ND 10	ND 10	ND 10	ND 10	ND 10	ND 10	ND 10	ND 10	ND 10	ND 10	ND 10
Benzo(g,h,i)perylene	10	ND 10	ND 10	ND 10	ND 10	ND 10	ND 10	ND 10	ND 10	ND 10	ND 10	ND 10
Benzyl alcohol	10	ND 10	ND 10	ND 10	ND 10	ND 10	ND 10	ND 10	ND 10	ND 10	ND 10	ND 10
Benzoic acid	51	ND 51	ND 51	ND 52	ND 52	ND 51	ND 50	ND 51	ND 51	ND 50	ND 50	ND 51

HISTORICAL ANALYTICAL RESULTS SUMMARY
 LOVE CANAL SITE
 LONG TERM MONITORING PROGRAM
 NIAGARA FALLS, NEW YORK

Sample ID:	122	8110	8120	8130	8140	9110	9115	9118	10272	12015 Dup. of 9115	10278	9120
Collection Date:	14/95	05/04/95	05/04/95	05/05/95	05/05/95	05/05/95	05/08/95	05/08/95	05/08/95	05/08/95	05/09/95	05/12/95
Pesticides/PCBs (µg/L)												
Alpha-BHC	0.061	ND 0.050	ND 0.050	ND 0.050	ND 0.050	ND 0.050	ND 0.50	ND 0.050	ND 0.05	ND 0.50	ND 0.051	ND 0.050
Beta-BHC	0.050	ND 0.050	ND 0.050	ND 0.050	ND 0.050	ND 0.050	ND 0.50	ND 0.050	ND 0.05	ND 0.50	ND 0.051	ND 0.050
Delta-BHC	0.050	ND 0.050	ND 0.050	ND 0.050	ND 0.050	ND 0.050	ND 0.50	ND 0.050	ND 0.05	ND 0.50	ND 0.051	ND 0.050
gamma-BHC (Lindane)	0.050	ND 0.050	ND 0.050	ND 0.050	ND 0.050	ND 0.050	ND 0.50	ND 0.050	ND 0.05	ND 0.50	ND 0.051	ND 0.050
Heptachlor	0.050	ND 0.050	ND 0.050	ND 0.050	ND 0.050	ND 0.050	ND 0.50	ND 0.050	ND 0.05	ND 0.50	ND 0.051	ND 0.050
Aldrin	0.050	ND 0.050	ND 0.050	ND 0.050	ND 0.050	ND 0.050	ND 0.50	ND 0.050	ND 0.05	ND 0.50	ND 0.051	ND 0.050
Heptachlor epoxide	0.050	ND 0.050	ND 0.050	ND 0.050	ND 0.050	ND 0.050	ND 0.50	ND 0.050	ND 0.05	ND 0.50	ND 0.051	ND 0.050
Endosulfan I	0.050	ND 0.050	ND 0.050	ND 0.050	ND 0.050	ND 0.050	ND 0.050	ND 0.050	ND 0.05	ND 0.50	ND 0.051	ND 0.050
Dieldrin	0.10	ND 0.10	ND 0.10	ND 0.10	ND 0.10	ND 0.10	ND 0.10	ND 0.10	ND 0.10	ND 1.0	ND 0.10	ND 0.10
4,4'-DDE	0.10	ND 0.10	ND 0.10	ND 0.10	ND 0.10	ND 0.10	ND 0.10	ND 0.10	ND 0.10	ND 1.0	ND 0.10	ND 0.10
Endrin	0.10	ND 0.10	ND 0.10	ND 0.10	ND 0.10	ND 0.10	ND 0.10	ND 0.10	ND 0.10	ND 1.0	ND 0.10	ND 0.10
Endosulfan II	0.10	ND 0.10	ND 0.10	ND 0.10	ND 0.10	ND 0.10	ND 0.10	ND 0.10	ND 0.10	ND 0.10	ND 0.10	ND 0.10
4,4'-DDD	0.10	ND 0.10	ND 0.10	ND 0.10	ND 0.10	ND 0.10	ND 0.10	ND 0.10	ND 0.10	ND 1.0	ND 0.10	ND 0.10
Endosulfan sulfate	0.10	ND 0.10	ND 0.10	ND 0.10	ND 0.10	ND 0.10	ND 0.10	ND 0.10	ND 0.10	ND 0.10	ND 0.10	ND 0.10
4,4'-DDT	0.10	ND 0.10	ND 0.10	ND 0.10	ND 0.10	ND 0.10	ND 0.10	ND 0.10	ND 0.10	ND 0.10	ND 0.10	ND 0.10
Methoxychlor	0.50	ND 0.50	ND 0.50	ND 0.50	ND 0.50	ND 0.50	ND 0.50	ND 0.50	ND 0.51	ND 0.50	ND 0.51	ND 0.50
Endrin ketone	0.10	ND 0.10	ND 0.10	ND 0.10	ND 0.10	ND 0.10	ND 0.10	ND 0.10	ND 0.10	ND 0.10	ND 0.10	ND 0.10
alpha-Chlordane	0.050	ND 0.050	ND 0.050	ND 0.050	ND 0.050	ND 0.050	ND 0.050	ND 0.050	ND 0.05	ND 0.50	ND 0.051	ND 0.050
gamma-Chlordane	0.050	ND 0.050	ND 0.050	ND 0.050	ND 0.050	ND 0.050	ND 0.050	ND 0.050	ND 0.05	ND 0.50	ND 0.051	ND 0.050
Toxaphene	5.0	ND 5.0	ND 5.0	ND 5.0	ND 5.0	ND 5.0	ND 5.0	ND 5.0	ND 5.0	ND 5.1	ND 5.1	ND 5.0
Aroclor-1016	1.0	ND 1.0	ND 1.0	ND 1.0	ND 1.0	ND 1.0	ND 10	ND 1.0	ND 1.0	ND 10	ND 1.0	ND 1.0
Aroclor-1221	2.0	ND 2.0	ND 2.0	ND 2.0	ND 2.0	ND 2.0	ND 20	ND 2.0	ND 2.0	ND 20	ND 2.0	ND 2.0
Aroclor-1232	1.0	ND 1.0	ND 1.0	ND 1.0	ND 1.0	ND 1.0	ND 10	ND 1.0	ND 1.0	ND 10	ND 1.0	ND 1.0
Aroclor-1242	1.0	ND 1.0	ND 1.0	ND 1.0	ND 1.0	ND 1.0	ND 10	ND 1.0	ND 1.0	ND 10	ND 1.0	ND 1.0
Aroclor-1248	1.0	ND 1.0	ND 1.0	ND 1.0	ND 1.0	ND 1.0	ND 10	ND 1.0	ND 1.0	ND 10	ND 1.0	ND 1.0
Aroclor-1254	1.0	ND 1.0	ND 1.0	ND 1.0	ND 1.0	ND 1.0	ND 1.0	ND 1.0	ND 1.0	ND 1.0	ND 1.0	ND 1.0
Aroclor-1260	1.0	ND 1.0	ND 1.0	ND 1.0	ND 1.0	ND 1.0	ND 1.0	ND 1.0	ND 1.0	ND 1.0	ND 1.0	ND 1.0

Notes:

- ND Non-detect at or above the associated value.
- J Associated value is estimated.
- D Associated value is from a dilution.

HISTORICAL ANALYTICAL RESULTS SUMMARY
LOVE CANAL SITE
LONG TERM MONITORING PROGRAM
NIAGARA FALLS, NEW YORK

<i>Sample ID:</i>	9125	9140	10113	9210	10205	10215	6209	1151A	10174B	10147	12020	102
<i>Collection Date:</i>	05/12/95	05/12/95	05/12/95	05/16/95	05/16/95	05/16/95	05/17/95	05/17/95	05/17/95	05/17/95	Dup. of 6209 05/17/95	05/17/95
<i>Volatiles (µg/L)</i>												
Chloromethane	ND 10	ND 10	ND 10	ND 10	ND 10	ND 10	ND 10	ND 10	ND 10	ND 10	ND 10	ND
Bromomethane	ND 10	ND 10	ND 10	ND 10	ND 10	ND 10	ND 10	ND 10	ND 10	ND 10	ND 10	ND
Vinyl Chloride	ND 10	ND 10	ND 10	ND 10	ND 10	ND 10	ND 10	ND 10	ND 10	ND 10	ND 10	ND
Chloroethane	ND 10	ND 10	ND 10	ND 10	ND 10	ND 10	ND 10	ND 10	ND 10	ND 10	ND 10	ND
Methylene Chloride	ND 10	ND 10	ND 10	ND 10	ND 10	ND 10	ND 10	ND 10	ND 10	ND 10	ND 10	ND
Acetone	ND 10	ND 10	ND 10	ND 10	ND 10	ND 10	ND 10	ND 10	ND 10	ND 10	ND 10	ND
Carbon Disulfide	ND 10	ND 10	ND 10	ND 10	ND 10	ND 10	ND 10	ND 10	ND 10	ND 10	ND 10	
1,1-Dichloroethene	ND 10	ND 10	ND 10	ND 10	ND 10	ND 10	ND 10	ND 10	ND 10	ND 10	ND 10	ND
1,1-Dichloroethane	ND 10	ND 10	ND 10	ND 10	ND 10	ND 10	ND 10	ND 10	ND 10	ND 10	ND 10	ND
1,2-Dichloroethene (total)	ND 10	ND 10	ND 10	ND 10	ND 10	ND 10	ND 10	ND 10	ND 10	ND 10	ND 10	ND
Chloroform	ND 10	ND 10	ND 10	ND 10	ND 10	ND 10	ND 10	ND 10	ND 10	ND 10	ND 10	ND
1,2-Dichloroethane	ND 10	ND 10	ND 10	ND 10	ND 10	ND 10	ND 10	ND 10	ND 10	ND 10	ND 10	ND
2-Butanone	ND 10	ND 10	ND 10	ND 10	ND 10	ND 10	ND 10	ND 10	ND 10	ND 10	ND 10	ND
1,1,1-Trichloroethane	ND 10	ND 10	ND 10	ND 10	ND 10	ND 10	ND 10	ND 10	ND 10	ND 10	ND 10	ND
Carbon Tetrachloride	ND 10	ND 10	ND 10	ND 10	ND 10	ND 10	ND 10	ND 10	ND 10	ND 10	ND 10	ND
Bromodichloromethane	ND 10	ND 10	ND 10	ND 10	ND 10	ND 10	ND 10	ND 10	ND 10	ND 10	ND 10	ND
1,2-Dichloropropane	ND 10	ND 10	ND 10	ND 10	ND 10	ND 10	ND 10	ND 10	ND 10	ND 10	ND 10	ND
cis-1,3-Dichloropropene	ND 10	ND 10	ND 10	ND 10	ND 10	ND 10	ND 10	ND 10	ND 10	ND 10	ND 10	ND
Trichloroethene	ND 10	ND 10	ND 10	ND 10	ND 10	ND 10	ND 10	ND 10	ND 10	ND 10	ND 10	ND
Dibromochloromethane	ND 10	ND 10	ND 10	ND 10	ND 10	ND 10	ND 10	ND 10	ND 10	ND 10	ND 10	ND
1,1,2-Trichloroethane	ND 10	ND 10	ND 10	ND 10	ND 10	ND 10	ND 10	ND 10	ND 10	ND 10	ND 10	ND
Benzene	ND 10	ND 10	ND 10	ND 10	ND 10	ND 10	ND 10	ND 10	ND 10	ND 10	ND 10	ND
Trans-1,3-Dichloropropene	ND 10	ND 10	ND 10	ND 10	ND 10	ND 10	ND 10	ND 10	ND 10	ND 10	ND 10	ND
Bromoform	ND 10	ND 10	ND 10	ND 10	ND 10	ND 10	ND 10	ND 10	ND 10	ND 10	ND 10	ND
4-Methyl-2-pentanone	ND 10	ND 10	ND 10	ND 10	ND 10	ND 10	ND 10	ND 10	ND 10	ND 10	ND 10	ND
2-Hexanone	ND 10	ND 10	ND 10	ND 10	ND 10	ND 10	ND 10	ND 10	ND 10	ND 10	ND 10	ND
Tetrachloroethene	ND 10	ND 10	ND 10	ND 10	ND 10	ND 10	ND 10	ND 10	ND 10	ND 10	ND 10	ND
1,1,2,2-Tetrachloroethane	ND 10	ND 10	ND 10	ND 10	ND 10	ND 10	ND 10	ND 10	ND 10	ND 10	ND 10	ND
Toluene	ND 10	ND 10	ND 10	ND 10	ND 10	ND 10	ND 10	ND 10	ND 10	ND 10	ND 10	ND
Chlorobenzene	ND 10	ND 10	ND 10	ND 10	ND 10	ND 10	ND 10	ND 10	ND 10	ND 10	ND 10	ND
Ethylbenzene	ND 10	ND 10	ND 10	ND 10	ND 10	ND 10	ND 10	ND 10	ND 10	ND 10	ND 10	ND
Styrene	ND 10	ND 10	ND 10	ND 10	ND 10	ND 10	ND 10	ND 10	ND 10	ND 10	ND 10	ND
Xylene (total)	ND 10	ND 10	ND 10	ND 10	ND 10	ND 10	ND 10	ND 10	ND 10	ND 10	ND 10	ND
Vinyl Acetate	ND 10	ND 10	ND 10	ND 10	ND 10	ND 10	ND 10	ND 10	ND 10	ND 10	ND 10	ND
2-Chloroethylvinylether	ND 10	ND 10	ND 10	ND 10	ND 10	ND 10	ND 10	ND 10	ND 10	ND 10	ND 10	ND

HISTORICAL ANALYTICAL RESULTS SUMMARY
 LOVE CANAL SITE
 LONG TERM MONITORING PROGRAM
 NIAGARA FALLS, NEW YORK

Sample ID:	9125	9140	10113	9210	10205	10215	6209	1151A	10174B	10147	12020 Dup. of 6209	102
Collection Date:	05/12/95	05/12/95	05/12/95	05/16/95	05/16/95	05/16/95	05/17/95	05/17/95	05/17/95	05/17/95	05/17/95	05/17/95
Semi-Volatiles (µg/L)												
Phenol	ND 10	ND 10	ND 10	ND 10	ND 10	ND 10	ND 10	ND 10	ND 10	ND 10	ND 10	ND
bis(2-Chloroethyl)ether	ND 10	ND 10	ND 10	ND 10	ND 10	ND 10	ND 10	ND 10	ND 10	ND 10	ND 10	ND
2-Chlorophenol	ND 10	ND 10	ND 10	ND 10	ND 10	ND 10	ND 10	ND 10	ND 10	ND 10	ND 10	ND
1,3-Dichlorobenzene	ND 10	ND 10	ND 10	ND 10	ND 10	ND 10	ND 10	ND 10	ND 10	ND 10	ND 10	ND
1,4-Dichlorobenzene	ND 10	ND 10	ND 10	ND 10	ND 10	ND 10	ND 10	ND 10	ND 10	ND 10	ND 10	ND
1,2-Dichlorobenzene	ND 10	ND 10	ND 10	ND 10	ND 10	ND 10	ND 10	ND 10	ND 10	ND 10	ND 10	ND
2-Methylphenol	ND 10	ND 10	ND 10	ND 10	ND 10	ND 10	ND 10	ND 10	ND 10	ND 10	ND 10	ND
2,2'-oxybis(1-Chloropropane)	ND 10	ND 10	ND 10	ND 10	ND 10	ND 10	ND 10	ND 10	ND 10	ND 10	ND 10	ND
4-Methylphenol	ND 10	ND 10	ND 10	ND 10	ND 10	ND 10	ND 10	ND 10	ND 10	ND 10	ND 10	ND
N-Nitroso-di-n-propylamine	ND 10	ND 10	ND 10	ND 10	ND 10	ND 10	ND 10	ND 10	ND 10	ND 10	ND 10	ND
Hexachloroethane	ND 10	ND 10	ND 10	ND 10	ND 10	ND 10	ND 10	ND 10	ND 10	ND 10	ND 10	ND
Nitrobenzene	ND 10	ND 10	ND 10	ND 10	ND 10	ND 10	ND 10	ND 10	ND 10	ND 10	ND 10	ND
Isophorone	ND 10	ND 10	ND 10	ND 10	ND 10	ND 10	ND 10	ND 10	ND 10	ND 10	ND 10	ND
2-Nitrophenol	ND 10	ND 10	ND 10	ND 10	ND 10	ND 10	ND 10	ND 10	ND 10	ND 10	ND 10	ND
2,4-Dimethylphenol	ND 10	ND 10	ND 10	ND 10	ND 10	ND 10	ND 10	ND 10	ND 10	ND 10	ND 10	ND
bis(2-Chloroethoxy)methane	ND 10	ND 10	ND 10	ND 10	ND 10	ND 10	ND 10	ND 10	ND 10	ND 10	ND 10	ND
2,4-Dichlorophenol	ND 10	ND 10	ND 10	ND 10	ND 10	ND 10	ND 10	ND 10	ND 10	ND 10	ND 10	ND
1,2,4-Trichlorobenzene	ND 10	ND 10	ND 10	ND 10	ND 10	ND 10	ND 10	ND 10	ND 10	ND 10	ND 10	ND
Naphthalene	ND 10	ND 10	ND 10	ND 10	ND 10	ND 10	ND 10	ND 10	ND 10	ND 10	ND 10	ND
4-Chloroaniline	ND 10	ND 10	ND 10	ND 10	ND 10	ND 10	ND 10	ND 10	ND 10	ND 10	ND 10	ND
Hexachlorobutadiene	ND 10	ND 10	ND 10	ND 10	ND 10	ND 10	ND 10	ND 10	ND 10	ND 10	ND 10	ND
4-Chloro-3-methylphenol	ND 10	ND 10	ND 10	ND 10	ND 10	ND 10	ND 10	ND 10	ND 10	ND 10	ND 10	ND
2-Methylnaphthalene	ND 10	ND 10	ND 10	ND 10	ND 10	ND 10	ND 10	ND 10	ND 10	ND 10	ND 10	ND
Hexachlorocyclopentadiene	ND 10	ND 10	ND 10	ND 10	ND 10	ND 10	ND 10	ND 10	ND 10	ND 10	ND 10	ND
2,4,6-Trichlorophenol	ND 10	ND 10	ND 10	ND 10	ND 10	ND 10	ND 10	ND 10	ND 10	ND 10	ND 10	ND
2,4,5-Trichlorophenol	ND 26	ND 26	ND 26	ND 26	ND 26	ND 26	ND 26	ND 26	ND 26	ND 26	ND 26	ND
2-Chloronaphthalene	ND 10	ND 10	ND 10	ND 10	ND 10	ND 10	ND 10	ND 10	ND 10	ND 10	ND 10	ND
2-Nitroaniline	ND 26	ND 26	ND 26	ND 26	ND 26	ND 26	ND 26	ND 26	ND 26	ND 26	ND 26	ND
Dimethylphthalate	ND 10	ND 10	ND 10	ND 10	ND 10	ND 10	ND 10	ND 10	ND 10	ND 10	ND 10	ND
Acenaphthylene	ND 10	ND 10	ND 10	ND 10	ND 10	ND 10	ND 10	ND 10	ND 10	ND 10	ND 10	ND
2,6-Dinitrotoluene	ND 10	ND 10	ND 10	ND 10	ND 10	ND 10	ND 10	ND 10	ND 10	ND 10	ND 10	ND
3-Nitroaniline	ND 26	ND 26	ND 26	ND 26	ND 26	ND 26	ND 26	ND 26	ND 26	ND 26	ND 26	ND
Acenaphthene	ND 10	ND 10	ND 10	ND 10	ND 10	ND 10	ND 10	ND 10	ND 10	ND 10	ND 10	ND
2,4-Dinitrophenol	ND 26	ND 26	ND 26	ND 26	ND 26	ND 26	ND 26	ND 26	ND 26	ND 26	ND 26	ND
4-Nitrophenol	ND 26	ND 26	ND 26	ND 26	ND 26	ND 26	ND 26	ND 26	ND 26	ND 26	ND 26	ND
Dibenzofuran	ND 10	ND 10	ND 10	ND 10	ND 10	ND 10	ND 10	ND 10	ND 10	ND 10	ND 10	ND
2,4-Dinitrotoluene	ND 10	ND 10	ND 10	ND 10	ND 10	ND 10	ND 10	ND 10	ND 10	ND 10	ND 10	ND
Diethylphthalate	ND 10	ND 10	ND 10	ND 10	ND 10	ND 10	ND 10	ND 10	ND 10	ND 10	ND 10	ND
4-Chlorophenyl-phenylether	ND 10	ND 10	ND 10	ND 10	ND 10	ND 10	ND 10	ND 10	ND 10	ND 10	ND 10	ND

HISTORICAL ANALYTICAL RESULTS SUMMARY
LOVE CANAL SITE
LONG TERM MONITORING PROGRAM
NIAGARA FALLS, NEW YORK

<i>Sample ID:</i>	9125	9140	10113	9210	10205	10215	6209	1151A	10174B	10147	12020 <i>Dup. of 6209</i>	102
<i>Collection Date:</i>	05/12/95	05/12/95	05/12/95	05/16/95	05/16/95	05/16/95	05/17/95	05/17/95	05/17/95	05/17/95	05/17/95	05/17/95
Semi-Volatiles (µg/L)												
Fluorene	ND 10	ND 10	ND 10	ND 10	ND 10	ND 10	ND 10	ND 10	ND 10	ND 10	ND 10	ND
4-Nitroaniline	ND 26	ND 26	ND 26	ND 26	ND 26	ND 26	ND 26	ND 26	ND 26	ND 26	ND 26	ND
4,6-Dinitro-2-methylphenol	ND 26	ND 26	ND 26	ND 26	ND 26	ND 26	ND 26	ND 26	ND 26	ND 26	ND 26	ND
N-Nitrosodiphenylamine (1)	ND 10	ND 10	ND 10	ND 10	ND 10	ND 10	ND 10	ND 10	ND 10	ND 10	ND 10	ND
4-Bromophenyl-phenylether	ND 10	ND 10	ND 10	ND 10	ND 10	ND 10	ND 10	ND 10	ND 10	ND 10	ND 10	ND
Hexachlorobenzene	ND 10	ND 10	ND 10	ND 10	ND 10	ND 10	ND 10	ND 10	ND 10	ND 10	ND 10	ND
Pentachlorophenol	ND 26	ND 26	ND 26	ND 26	ND 26	ND 26	ND 26	ND 26	ND 26	ND 26	ND 26	ND
Phenanthrene	ND 10	ND 10	ND 10	ND 10	ND 10	ND 10	ND 10	ND 10	ND 10	ND 10	ND 10	ND
Anthracene	ND 10	ND 10	ND 10	ND 10	ND 10	ND 10	ND 10	ND 10	ND 10	ND 10	ND 10	ND
Di-n-butylphthalate	ND 10	ND 10	ND 10	ND 10	ND 10	ND 10	ND 10	ND 10	ND 10	ND 10	ND 10	ND
Fluoranthene	ND 10	ND 10	ND 10	ND 10	ND 10	ND 10	ND 10	ND 10	ND 10	ND 10	ND 10	ND
Pyrene	ND 10	ND 10	ND 10	ND 10	ND 10	ND 10	ND 10	ND 10	ND 10	ND 10	ND 10	ND
Butylbenzylphthalate	ND 10	ND 10	ND 10	ND 10	ND 10	ND 10	ND 10	ND 10	ND 10	ND 10	ND 10	ND
3,3'-Dichlorobenzidine	ND 10	ND 10	ND 10	ND 10	ND 10	ND 10	ND 10	ND 10	ND 10	ND 10	ND 10	ND
Benzo(a)anthracene	ND 10	ND 10	ND 10	ND 10	ND 10	ND 10	ND 10	ND 10	ND 10	ND 10	ND 10	ND
Chrysene	ND 10	ND 10	ND 10	ND 10	ND 10	ND 10	ND 10	ND 10	ND 10	ND 10	ND 10	ND
bis(2-Ethylhexyl)phthalate	ND 10	ND 10	ND 10	ND 10	19J	11J	15J	47J	ND 10	ND 10	23J	ND
Di-n-octyl phthalate	ND 10	ND 10	ND 10	ND 10	ND 10	ND 10	ND 10	ND 10	ND 10	ND 10	ND 10	ND
Benzo(b)fluoranthene	ND 10	ND 10	ND 10	ND 10	ND 10	ND 10	ND 10	ND 10	ND 10	ND 10	ND 10	ND
Benzo(k)fluoranthene	ND 10	ND 10	ND 10	ND 10	ND 10	ND 10	ND 10	ND 10	ND 10	ND 10	ND 10	ND
Benzo(a)pyrene	ND 10	ND 10	ND 10	ND 10	ND 10	ND 10	ND 10	ND 10	ND 10	ND 10	ND 10	ND
Indeno(1,2,3-cd)pyrene	ND 10	ND 10	ND 10	ND 10	ND 10	ND 10	ND 10	ND 10	ND 10	ND 10	ND 10	ND
Dibenz(a,h)anthracene	ND 10	ND 10	ND 10	ND 10	ND 10	ND 10	ND 10	ND 10	ND 10	ND 10	ND 10	ND
Benzo(g,h,i)perylene	ND 10	ND 10	ND 10	ND 10	ND 10	ND 10	ND 10	ND 10	ND 10	ND 10	ND 10	ND
Benzyl alcohol	ND 10	ND 10	ND 10	ND 10	ND 10	ND 10	ND 10	ND 10	ND 10	ND 10	ND 10	ND
Benzoic acid	ND 51	ND 51	ND 51	ND 51	ND 51	ND 51	ND 51	ND 51	ND 51	ND 51	ND 51	ND

HISTORICAL ANALYTICAL RESULTS SUMMARY
LOVE CANAL SITE
LONG TERM MONITORING PROGRAM
NIAGARA FALLS, NEW YORK

<i>Sample ID:</i>	9125	9140	10113	9210	10205	10215	6209	1151A	10174B	10147	12020 Dup. of 6209	102
<i>Collection Date:</i>	05/12/95	05/12/95	05/12/95	05/16/95	05/16/95	05/16/95	05/17/95	05/17/95	05/17/95	05/17/95	05/17/95	05/
<i>Pesticides/PCBs (µg/L)</i>												
Alpha-BHC	ND 0.050	ND 0.050	ND 0.050	ND 0.050	ND 0.050	ND 0.050	ND 0.051	ND 0.051	ND 0.052	ND 0.050	ND 0.051	ND
Beta-BHC	ND 0.050	ND 0.050	ND 0.050	ND 0.050	ND 0.050	ND 0.050	ND 0.051	0.071J	ND 0.052	ND 0.050	ND 0.051	ND
Delta-BHC	ND 0.050	ND 0.050	ND 0.050	ND 0.050	ND 0.050	ND 0.050	ND 0.051	ND 0.051	ND 0.052	ND 0.050	ND 0.051	ND
gamma-BHC (Lindane)	ND 0.050	ND 0.050	ND 0.050	ND 0.050	ND 0.050	ND 0.050	ND 0.051	ND 0.051	ND 0.052	ND 0.050	ND 0.051	ND
Heptachlor	ND 0.050	ND 0.050	ND 0.050	ND 0.050	ND 0.050	ND 0.050	ND 0.051	ND 0.051	ND 0.052	ND 0.050	ND 0.051	ND
Aldrin	ND 0.050	ND 0.050	ND 0.050	ND 0.050	ND 0.050	ND 0.050	ND 0.051	ND 0.051	ND 0.052	ND 0.050	ND 0.051	ND
Heptachlor epoxide	ND 0.050	ND 0.050	ND 0.050	ND 0.050	ND 0.050	ND 0.050	ND 0.051	ND 0.051	ND 0.052	ND 0.050	ND 0.051	ND
Endosulfan I	ND 0.050	ND 0.050	ND 0.050	ND 0.050	ND 0.050	ND 0.050	ND 0.051	ND 0.051	ND 0.052	ND 0.050	ND 0.051	ND
Dieldrin	ND 0.10	ND 0.10	ND 0.10	ND 0.10	ND 0.10	ND 0.10	ND 0.10	ND 0.10	ND 0.10	ND 0.10	ND 0.10	ND
4,4'-DDE	ND 0.10	ND 0.10	ND 0.10	ND 0.10	ND 0.10	ND 0.10	ND 0.10	ND 0.10	ND 0.10	ND 0.10	ND 0.10	ND
Endrin	ND 0.10	ND 0.10	ND 0.10	ND 0.10	ND 0.10	ND 0.10	ND 0.10	ND 0.10	ND 0.10	ND 0.10	ND 0.10	ND
Endosulfan II	ND 0.10	ND 0.10	ND 0.10	ND 0.10	ND 0.10	ND 0.10	ND 0.10	ND 0.10	ND 0.10	ND 0.10	ND 0.10	ND
4,4'-DDD	ND 0.10	ND 0.10	ND 0.10	ND 0.10	ND 0.10	ND 0.10	ND 0.10	ND 0.10	ND 0.10	ND 0.10	ND 0.10	ND
Endosulfan sulfate	ND 0.10	ND 0.10	ND 0.10	ND 0.10	ND 0.10	ND 0.10	ND 0.10	ND 0.10	ND 0.10	ND 0.10	ND 0.10	ND
4,4'-DDT	ND 0.10	ND 0.10	ND 0.10	ND 0.10	ND 0.10	ND 0.10	ND 0.10	ND 0.10	ND 0.10	ND 0.10	ND 0.10	ND
Methoxychlor	ND 0.50	ND 0.50	ND 0.50	ND 0.50	ND 0.50	ND 0.50	ND 0.51	ND 0.51	ND 0.52	ND 0.50	ND 0.51	ND
Endrin ketone	ND 0.10	ND 0.10	ND 0.10	ND 0.10	ND 0.10	ND 0.10	ND 0.10	ND 0.10	ND 0.10	ND 0.10	ND 0.10	ND
alpha-Chlordane	ND 0.050	ND 0.050	ND 0.050	ND 0.050	ND 0.050	ND 0.050	ND 0.051	ND 0.051	ND 0.052	ND 0.050	ND 0.051	ND
gamma-Chlordane	ND 0.050	ND 0.050	ND 0.050	ND 0.050	ND 0.050	ND 0.050	ND 0.051	ND 0.051	ND 0.052	ND 0.050	ND 0.051	ND
Toxaphene	ND 5.0	ND 5.0	ND 5.0	ND 5.0	ND 5.0	ND 5.0	ND 5.1	ND 5.1	ND 5.2	ND 5.0	ND 5.1	ND
Aroclor-1016	ND 1.0	ND 1.0	ND 1.0	ND 1.0	ND 1.0	ND 1.0	ND 1.0	ND 1.0	ND 1.0	ND 1.0	ND 1.0	ND
Aroclor-1221	ND 2.0	ND 2.0	ND 2.0	ND 2.0	ND 2.0	ND 2.0	ND 2.0	ND 2.0	ND 2.1	ND 2.0	ND 2.0	ND
Aroclor-1232	ND 1.0	ND 1.0	ND 1.0	ND 1.0	ND 1.0	ND 1.0	ND 1.0	ND 1.0	ND 1.0	ND 1.0	ND 1.0	ND
Aroclor-1242	ND 1.0	ND 1.0	ND 1.0	ND 1.0	ND 1.0	ND 1.0	ND 1.0	ND 1.0	ND 1.0	ND 1.0	ND 1.0	ND
Aroclor-1248	ND 1.0	ND 1.0	ND 1.0	ND 1.0	ND 1.0	ND 1.0	ND 1.0	ND 1.0	ND 1.0	ND 1.0	ND 1.0	ND
Aroclor-1254	ND 1.0	ND 1.0	ND 1.0	ND 1.0	ND 1.0	ND 1.0	ND 1.0	ND 1.0	ND 1.0	ND 1.0	ND 1.0	ND
Aroclor-1260	ND 1.0	ND 1.0	ND 1.0	ND 1.0	ND 1.0	ND 1.0	ND 1.0	ND 1.0	ND 1.0	ND 1.0	ND 1.0	ND

Notes:

- ND Non-detect at or above the associated value.
J Associated value is estimated.
D Associated value is from a dilution.

HISTORICAL ANALYTICAL RESULTS SUMMARY
 LOVE CANAL SITE
 LONG TERM MONITORING PROGRAM
 NIAGARA FALLS, NEW YORK

Sample ID:	10A	10225A	10225B	12510	10210B	10210C	10225C	10135
Collection Date:	3/5/95	05/26/95	05/26/95	Dup. of 10225B 05/26/95	06/01/95	06/01/95	06/01/95	06/01/95
Volatiles (µg/L)								
Chloromethane	10	ND 10	ND 10	ND 10	ND 10	ND 10	ND 10	ND 10
Bromomethane	10	ND 10	ND 10	ND 10	ND 10	ND 10	ND 10	ND 10
Vinyl Chloride	10	ND 10	ND 10	ND 10	ND 10	ND 10	ND 10	44J
Chloroethane	10	ND 10	ND 10	ND 10	ND 10	ND 10	ND 10	ND 10
Methylene Chloride	10	ND 10	ND 10	ND 10	ND 10	ND 10	ND 10	ND 12
Acetone	16	ND 28	ND 54	ND 52	23	ND 10	ND 10	100J
Carbon Disulfide	20	43	ND 10	ND 10	ND 10	ND 10	ND 10	ND 10
1,1-Dichloroethene	10	ND 10	ND 10	ND 10	ND 10	ND 10	ND 10	ND 10
1,1-Dichloroethane	10	ND 10	ND 10	ND 10	ND 10	ND 10	ND 10	ND 10
1,2-Dichloroethene (total)	10	ND 10	ND 10	ND 10	ND 10	ND 10	ND 10	670JD
Chloroform	10	ND 10	ND 10	ND 10	ND 10	ND 10	ND 10	86J
1,2-Dichloroethane	10	ND 10	ND 10	ND 10	ND 10	ND 10	ND 10	ND 10
2-Butanone	10	ND 10	ND 10	ND 10	ND 10	ND 10	ND 10	ND 10
1,1,1-Trichloroethane	10	ND 10	ND 10	ND 10	ND 10	ND 10	ND 10	ND 10
Carbon Tetrachloride	10	ND 10	ND 10	ND 10	ND 10	ND 10	ND 10	ND 10
Bromodichloromethane	10	ND 10	ND 10	ND 10	ND 10	ND 10	ND 10	ND 10
1,2-Dichloropropane	10	ND 10	ND 10	ND 10	ND 10	ND 10	ND 10	ND 10
cis-1,3-Dichloropropene	10	ND 10	ND 10	ND 10	ND 10	ND 10	ND 10	ND 10
Trichloroethene	10	ND 10	ND 10	ND 10	ND 10	ND 10	ND 10	18J
Dibromochloromethane	10	ND 10	ND 10	ND 10	ND 10	ND 10	ND 10	ND 10
1,1,2-Trichloroethane	10	ND 10	ND 10	ND 10	ND 10	ND 10	ND 10	ND 10
Benzene	10	ND 10	ND 10	ND 10	ND 10	ND 10	ND 10	4900D
Trans-1,3-Dichloropropene	10	ND 10	ND 10	ND 10	ND 10	ND 10	ND 10	ND 10
Bromoform	10	ND 10	ND 10	ND 10	ND 10	ND 10	ND 10	ND 10
4-Methyl-2-pentanone	10	ND 10	ND 10	ND 10	ND 10	ND 10	ND 10	ND 10
2-Hexanone	10	ND 10	ND 10	ND 10	ND 10	ND 10	ND 10	ND 10
Tetrachloroethene	10	ND 10	ND 10	ND 10	ND 10	ND 10	ND 10	ND 10
1,1,2,2-Tetrachloroethane	10	ND 10	ND 10	ND 10	ND 10	ND 10	ND 10	ND 10
Toluene	10	ND 10	ND 10	ND 10	ND 10	ND 10	ND 10	18000D
Chlorobenzene	10	ND 10	ND 10	ND 10	ND 10	ND 10	ND 10	2000D
Ethylbenzene	10	ND 10	ND 10	ND 10	ND 10	ND 10	ND 10	ND 10
Styrene	10	ND 10	ND 10	ND 10	ND 10	ND 10	ND 10	ND 10
Xylene (total)	10	ND 10	ND 10	ND 10	ND 10	ND 10	ND 10	37J
Vinyl Acetate	10	ND 10	ND 10	ND 10	ND 10	ND 10	ND 10	ND 10
2-Chloroethylvinylether	10	ND 10	ND 10	ND 10	ND 10	ND 10	ND 10	ND 10

HISTORICAL ANALYTICAL RESULTS SUMMARY
LOVE CANAL SITE
LONG TERM MONITORING PROGRAM
NIAGARA FALLS, NEW YORK

<i>Sample ID:</i>	10A	10225A	10225B	12510	10210B	10210C	10225C	10135
<i>Collection Date:</i>	25/95	05/26/95	05/26/95	Dup. of 10225B 05/26/95	06/01/95	06/01/95	06/01/95	06/01/95
<i>Semi-Volatiles (µg/L)</i>								
Phenol	10	ND 20	ND 10	ND 10	ND 10	22	ND 10	140
bis(2-Chloroethyl)ether	10	ND 20	ND 10	ND 10	ND 10	ND 10	ND 10	ND 100
2-Chlorophenol	10	ND 20	ND 10	ND 10	ND 10	ND 10	ND 10	ND 100
1,3-Dichlorobenzene	10	ND 20	ND 10	ND 10	ND 10	ND 10	ND 10	ND 100
1,4-Dichlorobenzene	10	ND 20	ND 10	ND 10	ND 10	ND 10	ND 10	ND 100
1,2-Dichlorobenzene	10	ND 20	ND 10	ND 10	ND 10	ND 10	ND 10	ND 100
2-Methylphenol	10	ND 20	ND 10	ND 10	ND 10	ND 10	ND 10	ND 100
2,2'-oxybis(1-Chloropropane)	10	ND 20	ND 10	ND 10	ND 10	ND 10	ND 10	ND 100
4-Methylphenol	10	ND 20	ND 10	ND 10	ND 10	29	ND 10	ND 100
N-Nitroso-di-n-propylamine	10	ND 20	ND 10	ND 10	ND 10	ND 10	ND 10	ND 100
Hexachloroethane	10	ND 20	ND 10	ND 10	ND 10	ND 10	ND 10	ND 100
Nitrobenzene	10	ND 20	ND 10	ND 10	ND 10	ND 10	ND 10	ND 100
Isophorone	10	ND 20	ND 10	ND 10	ND 10	ND 10	ND 10	ND 100
2-Nitrophenol	10	ND 20	ND 10	ND 10	ND 10	ND 10	ND 10	ND 100
2,4-Dimethylphenol	10	ND 20	ND 10	ND 10	ND 10	ND 10	ND 10	ND 100
bis(2-Chloroethoxy)methane	10	ND 20	ND 10	ND 10	ND 10	ND 10	ND 10	ND 100
2,4-Dichlorophenol	10	ND 20	ND 10	ND 10	ND 10	ND 10	ND 10	150
1,2,4-Trichlorobenzene	10	ND 20	ND 10	ND 10	ND 10	ND 10	ND 10	ND 100
Naphthalene	10	ND 20	ND 10	ND 10	ND 10	ND 10	ND 10	ND 100
4-Chloroaniline	10	ND 20	ND 10	ND 10	ND 10	ND 10	ND 10	ND 100
Hexachlorobutadiene	10	ND 20	ND 10	ND 10	ND 10	ND 10	ND 10	ND 100
4-Chloro-3-methylphenol	10	ND 20	ND 10	ND 10	ND 10	ND 10	ND 10	ND 100
2-Methylnaphthalene	10	ND 20	ND 10	ND 10	ND 10	ND 10	ND 10	ND 100
Hexachlorocyclopentadiene	10	ND 20	ND 10	ND 10	ND 10	ND 10	ND 10	ND 100
2,4,6-Trichlorophenol	10	ND 20	ND 10	ND 10	ND 10	ND 10	ND 10	ND 100
2,4,5-Trichlorophenol	25	ND 50	ND 25	ND 25	ND 26	ND 26	ND 26	ND 260
2-Chloronaphthalene	10	ND 20	ND 10	ND 10	ND 10	ND 10	ND 10	150
2-Nitroaniline	25	ND 50	ND 25	ND 25	ND 26	ND 26	ND 26	ND 260
Dimethylphthalate	10	ND 20	ND 10	ND 10	ND 10	ND 10	ND 10	ND 100
Acenaphthylene	10	ND 20	ND 10	ND 10	ND 10	ND 10	ND 10	ND 100
2,6-Dinitrotoluene	10	ND 20	ND 10	ND 10	ND 10	ND 10	ND 10	ND 100
3-Nitroaniline	25	ND 50	ND 25	ND 25	ND 26	ND 26	ND 26	ND 260
Acenaphthene	10	ND 20	ND 10	ND 10	ND 10	ND 10	ND 10	ND 100
2,4-Dinitrophenol	25	ND 50	ND 25	ND 25	ND 26	ND 26	ND 26	ND 260
4-Nitrophenol	25	ND 50	ND 25	ND 25	ND 26	ND 26	ND 26	ND 260
Dibenzofuran	10	ND 20	ND 10	ND 10	ND 10	ND 10	ND 10	ND 100
2,4-Dinitrotoluene	10	ND 20	ND 10	ND 10	ND 10	ND 10	ND 10	ND 100
Diethylphthalate	10	ND 10	ND 10.0	ND 10	ND 10	ND 10	ND 10	ND 100
4-Chlorophenyl-phenylether	10	ND 20	ND 10	ND 10	ND 10	ND 10	ND 10	ND 100

HISTORICAL ANALYTICAL RESULTS SUMMARY
LOVE CANAL SITE
LONG TERM MONITORING PROGRAM
NIAGARA FALLS, NEW YORK

<i>Sample ID:</i>	10A	10225A	10225B	12510	10210B	10210C	10225C	10135
<i>Collection Date:</i>	05/95	05/26/95	05/26/95	Dup. of 10225B 05/26/95	06/01/95	06/01/95	06/01/95	06/01/95
<i>Semi-Volatiles (µg/L)</i>								
Fluorene	10	ND 20	ND 10	ND 10	ND 10	ND 10	ND 10	ND 100
4-Nitroaniline	25	ND 50	ND 25	ND 25	ND 26	ND 26	ND 26	ND 260
4,6-Dinitro-2-methylphenol	25	ND 50	ND 25	ND 25	ND 26	ND 26	ND 26	ND 260
N-Nitrosodiphenylamine (1)	10	ND 20	ND 10	ND 10	ND 10	ND 10	ND 10	ND 100
4-Bromophenyl-phenylether	10	ND 20	ND 10	ND 10	ND 10	ND 10	ND 10	ND 100
Hexachlorobenzene	10	ND 20	ND 10	ND 10	ND 10	ND 10	ND 10	ND 100
Pentachlorophenol	25	ND 50	ND 25	ND 25	ND 26	ND 26	ND 26	ND 260
Phenanthrene	10	ND 20	ND 10	ND 10	ND 10	ND 10	ND 10	ND 100
Anthracene	10	ND 20	ND 10	ND 10	ND 10	ND 10	ND 10	ND 100
Di-n-butylphthalate	10	ND 20	ND 10	ND 10	ND 10	ND 10	ND 10	ND 100
Fluoranthene	10	ND 20	ND 10	ND 10	ND 10	ND 10	ND 10	ND 100
Pyrene	10	ND 20	ND 10	ND 10	ND 10	ND 10	ND 10	ND 100
Butylbenzylphthalate	10	ND 20	ND 10	ND 10	ND 10	ND 10	ND 10	ND 100
3,3'-Dichlorobenzidine	10	ND 20	ND 10	ND 10	ND 10	ND 10	ND 10	ND 100
Benzo(a)anthracene	10	ND 20	ND 10	ND 10	ND 10	ND 10	ND 10	ND 100
Chrysene	10	ND 20	ND 10	ND 10	ND 10	ND 10	ND 10	ND 100
bis(2-Ethylhexyl)phthalate	51	ND 20	ND 10	ND 10	ND 10	ND 20	ND 10	ND 100
Di-n-octyl phthalate	10	ND 20	ND 10	ND 10	ND 10	ND 10	ND 10	ND 100
Benzo(b)fluoranthene	10	ND 20	ND 10	ND 10	ND 10	ND 10	ND 10	ND 100
Benzo(k)fluoranthene	10	ND 20	ND 10	ND 10	ND 10	ND 10	ND 10	ND 100
Benzo(a)pyrene	10	ND 20	ND 10	ND 10	ND 10	ND 10	ND 10	ND 100
Indeno(1,2,3-cd)pyrene	10	ND 20	ND 10	ND 10	ND 10	ND 10	ND 10	ND 100
Dibenz(a,h)anthracene	10	ND 20	ND 10	ND 10	ND 10	ND 10	ND 10	ND 100
Benzo(g,h,i)perylene	10	ND 20	ND 10	ND 10	ND 10	ND 10	ND 10	ND 100
Benzyl alcohol	10	ND 20	ND 10	ND 10	ND 10	ND 10	ND 10	380
Benzoic acid	50	ND 100	ND 50	ND 50	ND 52	ND 52	ND 10	6400D

**HISTORICAL ANALYTICAL RESULTS SUMMARY
LOVE CANAL SITE
LONG TERM MONITORING PROGRAM
NIAGARA FALLS, NEW YORK**

<i>Sample ID:</i>	<i>10A</i>	<i>10225A</i>	<i>10225B</i>	<i>12510</i>	<i>10210B</i>	<i>10210C</i>	<i>10225C</i>	<i>10135</i>
<i>Collection Date:</i>	<i>15/95</i>	<i>05/26/95</i>	<i>05/26/95</i>	<i>Dup. of 10225B 05/26/95</i>	<i>06/01/95</i>	<i>06/01/95</i>	<i>06/01/95</i>	<i>06/01/95</i>
<i>Pesticides/PCBs (µg/L)</i>								
Alpha-BHC	0.050	ND 0.10	ND 0.25	ND 0.50	ND 0.50	ND 0.050	ND 0.052	28D
Beta-BHC	0.050	ND 0.10	ND 0.25	ND 0.50	ND 0.50	ND 0.050	ND 0.052	10D
Delta-BHC	0.050	ND 0.10	ND 0.25	ND 0.50	ND 0.50	ND 0.050	ND 0.052	4.7
gamma-BHC (Lindane)	0.050	ND 0.10	ND 0.25	ND 0.50	ND 0.50	ND 0.050	ND 0.052	ND 0.51
Heptachlor	0.050	ND 0.10	ND 0.25	ND 0.50	ND 0.50	ND 0.050	ND 0.052	ND 0.51
Aldrin	0.050	ND 0.10	ND 0.25	ND 0.50	ND 0.50	ND 0.050	ND 0.052	ND 0.51
Heptachlor epoxide	0.050	ND 0.10	ND 0.25	ND 0.50	ND 0.50	ND 0.050	ND 0.052	ND 0.51
Endosulfan I	0.050	ND 0.10	ND 0.25	ND 0.50	ND 0.50	ND 0.050	ND 0.052	ND 0.51
Dieldrin	0.10	ND 0.20	ND 0.50	ND 1.0	ND 1.0	ND 0.10	ND 0.10	ND 1.0
4,4'-DDE	0.10	ND 0.20	ND 0.50	ND 1.0	ND 1.0	ND 0.10	ND 0.10	ND 1.0
Endrin	0.10	ND 0.20	ND 0.50	ND 1.0	ND 1.0	ND 0.010	ND 0.10	ND 1.0
Endosulfan II	0.10	ND 0.20	ND 0.50	ND 1.0	ND 1.0	ND 0.10	ND 0.10	ND 1.0
4,4'-DDD	0.10	ND 0.20	ND 0.50	ND 1.0	ND 1.0	ND 0.10	ND 0.10	ND 1.0
Endosulfan sulfate	0.10	ND 0.20	ND 0.50	ND 1.0	ND 1.0	ND 0.10	ND 0.10	ND 1.0
4,4'-DDT	0.10	ND 0.20	ND 0.50	ND 1.0	ND 1.0	ND 0.10	ND 0.10	ND 1.0
Methoxychlor	0.50	ND 1.0	ND 2.50	ND 5.0	ND 5.0	ND 0.50	ND 0.52	ND 5.1
Endrin ketone	0.10	ND 0.20	ND 0.50	ND 1.0	ND 1.0	ND 0.10	ND 0.10	ND 1.0
alpha-Chlordane	0.050	ND 0.10	ND 0.25	ND 0.50	ND 0.50	ND 0.050	ND 0.052	ND 0.51
gamma-Chlordane	0.050	ND 0.10	ND 0.25	ND 0.50	ND 0.50	ND 0.050	ND 0.052	ND 0.51
Toxaphene	5.0	ND 10	ND 25	ND 50	ND 50	ND 5.0	ND 5.2	ND 51
Aroclor-1016	1.0	ND 2.0	ND 5.0	ND 10	ND 10	ND 1.0	ND 1.0	ND 10
Aroclor-1221	2.0	ND 4.0	ND 10	ND 20	ND 20	ND 2.0	ND 2.1	ND 20
Aroclor-1232	1.0	ND 2.0	ND 5.0	ND 10	ND 10	ND 1.0	ND 1.0	ND 10
Aroclor-1242	1.0	ND 2.0	ND 5.0	ND 10	ND 10	ND 1.0	ND 1.0	ND 10
Aroclor-1248	1.0	ND 2.0	ND 5.0	ND 10	ND 10	ND 1.0	ND 1.0	ND 10
Aroclor-1254	1.0	ND 2.0	ND 5.0	ND 10	ND 10	ND 1.0	ND 1.0	ND 10
Aroclor-1260	1.0	ND 2.0	ND 5.0	ND 10	ND 10	ND 1.0	ND 1.0	ND 10

Notes:
 ND Non-detect at or above the associated value.
 J Associated value is estimated.
 D Associated value is from a dilution.

APPENDIX F

TRAINING CERTIFICATION

**LOVE CANAL TERM MONITORING PROGRAM
SAMPLING MANUAL LIST**

True or False

1. T or F Samples do not have to be cooled to 4°C if shipped the same day they are collected?
2. T or F A hardhat is a required item of safety equipment during groundwater sampling?
3. T or F Trip blank samples are only required when shipping volatile organic compound samples?
4. T or F Chain of custody forms are to accompany every sample shipment?
5. T or F The vinyl tubing used with the peristaltic pump can be cleaned and reused?
6. T or F Purge water can be pumped onto the ground. Containment is not necessary?
7. T or F Decontamination of non-dedicated sampling or water level measuring equipment between wells is not required?
8. T or F The pH meter reads on a scale of 0 to 100?
9. T or F The LTM Sampling Program takes place only one time per year?
10. T or F Different purging criteria exist for wells which go dry and do not recover quickly as opposed to wells which yield sufficient quantities of water?

Multiple Choice (Circle all choices which apply)

11. Samples for Volatile Organic Compounds can be collected using:
- a. Bladder pumps
 - b. Airlift pump
 - c. Peristaltic pump
 - d. Bailer
 - e. None of the above
 - f. All of the above
12. Safety equipment required for sampling includes:
- a. Safety glasses
 - b. Hardhat
 - c. Work shoes
 - d. Vinyl gloves
 - e. White tyvek or cotton overalls
 - f. None of the above
 - g. All of the above
13. The following samples are collected for the LTM Program:
- a. Target Compound List (TCL) Volatile Organic Compounds
 - b. TCL Semi-Volatile Organic Compounds
 - c. TCL Organochlorine Pesticides/PCBs
 - d. Metals; dissolved and total
 - e. Urine and blood
 - f. None of the above
14. Sampling Quality Assurance Quality Control sample types collected include:
- a. Rinse blank samples
 - b. Matrix spike/matrix spike duplicate samples
 - c. Blind (field) duplicate samples
 - d. None of the above
 - e. All of the above

15. Which of the following item(s) would typically not appear on a chain of custody form:
- Sample collection data and time
 - Sample signature
 - Weather information
 - Sample identification
 - Analytical parameters to be tested
 - Sample preservative
 - None of the above

Short Answer Questions

16. Name three activities which can affect sample quality in the field:

- _____
- _____
- _____

17. State the purging criteria for a well which goes dry and does not recover quickly:

- _____
- _____
- _____

18. Name the five field parameters measured during purging:

- | | |
|----------|----------|
| 1. _____ | 4. _____ |
| 2. _____ | 5. _____ |
| 3. _____ | |

19. Name two observations to be made of the groundwater during purging:

- | | |
|----------|----------|
| 1. _____ | 3. _____ |
|----------|----------|

20. Identify the number series of the piezometer strings at the Site:

- | | |
|----------|----------|
| 1. _____ | 4. _____ |
| 2. _____ | 5. _____ |
| 3. _____ | 6. _____ |

21. Identify the four overburden groundwater zones monitored by the piezometers:

- | | |
|----------|----------|
| 1. _____ | 3. _____ |
| 2. _____ | 4. _____ |

22. Decontamination of non-dedicated equipment is: a _____ wash

followed by a _____ rinse followed by a _____ rinse.
Then _____ and wrap in _____.

23. The turbidity meter measures the _____ of a liquid.
24. a pH of 2 would be _____; a pH of 7 would be _____;
a pH of 11 would be _____.
25. Water level measurements in the piezometers are typically taken in
_____, _____ and _____ of each year.

**LOVE CANAL LONG TERM MONITORING PROGRAM
SAMPLING MANUAL TEST ANSWER KEY**

1. False
2. True
3. True
4. True
5. False
6. False
7. False
8. False
9. True
10. True
11. a and d
12. g
13. a, b and c
14. d
15. c
16.
 - Smoking
 - Use of cologne, aftershave, bug spray, sunscreen
 - Using wasp/hornet killer near the well
 - Vehicle exhaust
 - Airbourne contaminants in rainwater
 - Lock lubricant
 - Improper or inadequate cleaning
 - Gasoline fumes
 - Failure to preserve or cool sample
 - Other answers may also be correct
17. After purging dry one time, allow well to recover enough to collect samples.
18. pH
Specific conductance
Temperature
Turbidity
Water levels
19. Color
Cloudiness (turbidity)
Amount of sediment
Sheens
Odors
NAPL presence
20. 1140
1150

1160
1170
1180
1190

21. A
B
C
D
22. Soapy water, tap water, deionized water, air dry, foil or plastic
23. Cloudiness
24. Acidic, neutral, alkaline (basic)
25. January, April, July, October

**TRAINING CERTIFICATION
LOVE CANAL SITE
LONG-TERM GROUNDWATER MONITORING PROGRAM**

Name	Signature	Date
_____	_____	_____
_____	_____	_____
_____	_____	_____
_____	_____	_____
_____	_____	_____
_____	_____	_____
_____	_____	_____
_____	_____	_____
_____	_____	_____
_____	_____	_____
_____	_____	_____
_____	_____	_____
_____	_____	_____
_____	_____	_____
_____	_____	_____
_____	_____	_____
_____	_____	_____
_____	_____	_____
_____	_____	_____
_____	_____	_____
_____	_____	_____
_____	_____	_____

1994 - Currently on 3" computer disk

Prior - still at NYSDEC. Historical data not available at L.C.