



Mr. Christopher Allan
New York State Department of Environmental Conservation
Division of Environmental Remediation
47-40 21st Street
Long Island City, New York, 11101

05.27.2026

**Re: Quarterly Monitoring Report – 2026 1st Quarter
975 Nostrand Avenue, Brooklyn, NY
NYSDEC Site No: C224335**

Dear Mr. Allan:

This Quarterly Monitoring Report has been prepared by AKRF, Inc. (AKRF) to summarize routine sampling and monitoring activities performed at the 975 Nostrand Avenue site located in Brooklyn, New York (the “Site”), also identified as Block 1309, Lot 6 on the New York City Tax Map. The Site is situated on an approximately 1.369-acre parcel bounded to the north by a vacant lot (under construction); to the east by Clove Road, followed by multi-family residential buildings; to the south by mixed residential and commercial uses; and to the west by Nostrand Avenue followed by mixed residential and commercial uses and Sullivan Place. A Site location map is provided as Figure 1. A Site plan is provided as Figure 2.

On December 21, 2021, Nostrand Green LLC entered into a Brownfield Cleanup Agreement (BCA) (Index No. C224335-12-21) with NYSDEC as a Volunteer to remediate the Site. The Site was remediated to a Track 2 Restricted Residential Use Cleanup and will be used for residential and commercial uses. A Certificate of Completion (CoC) was issued by NYSDEC in December 2023.

Soil vapor beneath the Site remains contaminated with the chlorinated volatile organic compound (CVOC), tetrachloroethylene (PCE). Remedial activities were completed between July 2022 and September 2023 and included soil removal, underground storage tank (UST) removal, installation of below ground components of an active sub-slab depressurization system (SSDS), and a soil vapor extraction system (SVES). The SVES has been operating continuously at the Site since November 2023 and the SSDS was activated in July 2025 following installation of the aboveground components.

Site management activities have been ongoing since the issuance of the CoC. This report summarizes the inspection and monitoring activities performed at the Site during the first quarter of 2026 between January 1 and March 31, which included a quarterly inspection of the SVES. In accordance with the SMP, further assessment (and recommendations, if necessary) will be provided in the next annual Periodic Review Report (PRR) for the 2025-2026 period.

SVES Operation and Maintenance

SVES Monitoring

Initial startup of the SVES occurred in November 2023. A quarterly inspection was performed in February 2026 to monitor and evaluate the system performance. The quarterly SVES inspection comprised the following activities:

- Confirming that the blower is operating, and air is discharging through the exhaust piping;
- Checking the moisture separator tank;
- Recording SVES blower operation and variable-frequency drive (VFD) readings;
- Recording pre- and post-filter vacuum readings;
- Recording post-blower pressure levels;
- Field-screening for relative concentrations of volatile organic compounds (VOCs) at the granular activated carbon (GAC) vessel influent, intermediate, and effluent ports; and
- Recording vacuum readings at each SVES manifold leg and the monitoring points.

The SVES blower was noted to be operational during the reporting period; however, the system had to be shut down for short periods of time on multiple occasions to perform regular maintenance, troubleshooting, and repairs, as needed. No other issues were noted during the reporting period.

Field screening using a calibrated photoionization detector (PID) did not detect any VOCs at the GAC vessel intermediate or effluent ports, and as such, a GAC vessel changeout was not warranted. No other significant changes were observed. The SVES layout is shown on Figure 3. The inspection log is provided in Attachment A.

Granulated Activated Carbon (GAC) Drum Changeout

Based on the findings of the annual extracted vapor sampling completed in Q4 2025, a GAC drum changeout was required for continuous operation of the SVES and removal of soil vapor contaminants. The GAC vessel changeout was completed on January 8, 2026, and the SVE system was restarted.

Further data analysis and discussion of the data, including comparison to the NYSDEC Division of Air Resources (DAR-1) guidelines, and PCE mass removal calculations will be included in the PRR, to be submitted to NYSDEC in May 2026.

SSDS Operation and Maintenance

SSDS Inspection and Startup

In accordance with the SMP, inspections of the SSDS are to be conducted on an annual basis after the first year following issuance of the CoC. The annual SSDS inspection for 2026 is scheduled for Q2.

The active SSDS (3 separate systems) is being operated at the Site to mitigate the potential for soil vapor intrusion into the new building. The SSDS systems continue to induce a negative pressure (i.e., vacuum) beneath the newly constructed building slab. The underground elements of the SSDS were installed beneath the building slab following remedial excavation and prior to receipt of the CoC; and the aboveground components were installed concurrently with construction of the new building interior (completed in September 2025). During the February 2026 Site visit, the SSDS was also inspected and it was noted that all SSDS components were in good condition and no issues were identified. The SSDS layout is shown on Figure 4.

Indoor Air Sampling

On February 2 and 3, and 16 and 17, 2026, AKRF conducted a vapor intrusion evaluation to assess the effectiveness of the vapor barrier membrane and the active SSDS installed below the new building slab at preventing contaminated vapors from entering the Site building. The work included: a pre-sampling inspection; chemical inventory; and collection and laboratory analysis of seven indoor air samples from the building cellar and one ambient (outdoor) air sample. The sampling was conducted in accordance with the September 2025 (revised October 2025) NYSDEC-approved Indoor Air Sampling Work Plan (IASWP). Copies of the IASWP and NYSDEC's approval letter are provided in Attachment B.

The results of the sampling will be documented in an Indoor Air Sampling Report (IASR), which will evaluate Site-specific data in accordance with the New York State Department of Health (NYSDOH) Soil Vapor Intrusion (SVI) Guidance and Decision Matrices to determine whether actions are necessary to address

potential exposure to soil vapor intrusion into the new building. The IASR will be submitted to NYSDEC and NYSDOH for review, and a copy will also be included in the next PRR.

Scheduled Activities

AKRF will continue to conduct quarterly SVES inspections; the next inspection is scheduled for April 2026. As stated in the revised NYSDEC-approved January 2024 SMP, SSDS inspection frequency will be reduced to annually after the first year; therefore, the following SSDS inspection will be conducted in Q2 2026. The next round of extracted vapor sampling from the SVES is expected in December 2026 (or sooner if required).

If you have any questions regarding the information presented herein, please contact Ashutosh Sharma at (646) 388-9865 or asharma@akrf.com.

Sincerely,
AKRF, Inc.



Ashutosh Sharma
Vice President



Axel Schwendt
Vice President

Attachments:

- Figure 1 Site Location
- Figure 2 BCP Site Plan and Sample Location Plan
- Figure 3 SVES Layout Plan
- Figure 4 SSDS Layout Plan

- Attachment A SVES Inspection Log
- Attachment B IASWP and NYSDEC Approval Letter

cc (electronic copy only):

- Cris-Sandra Maycock – NYSDEC
- Sally Rushford – NYSDOH
- Berke Kalemoglu – Nostrand Green LLC
- Rebecca Kinal – AKRF

FIGURES

© 2023 AKRF. W:\Projects\210225 - 975 Nostrand Avenue\Technical\GIS and Graphics\SAR\210225 Figure 1 Site Location map.mxd 11/2/2022 10:32:53 AM iszalus

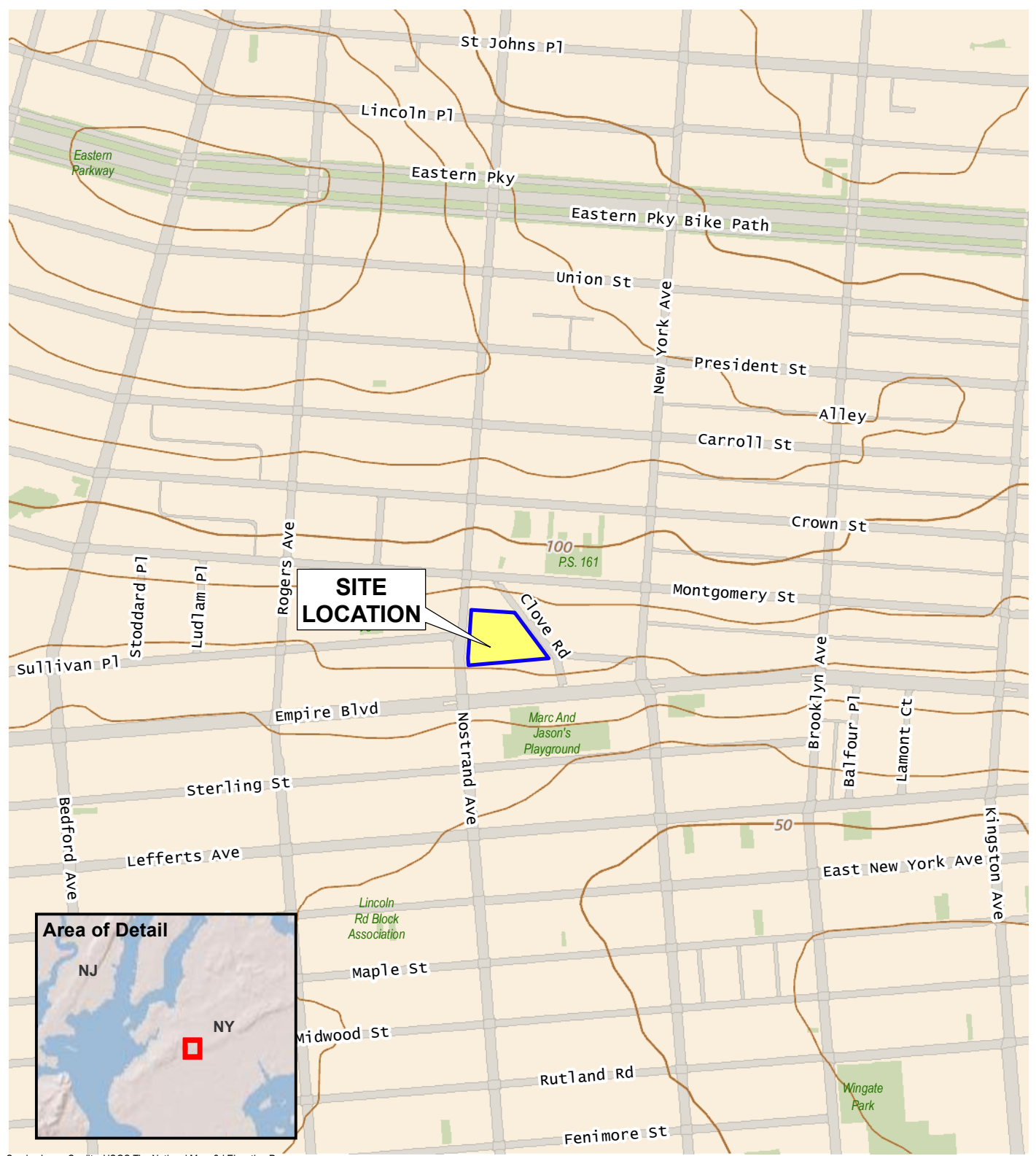

Service Layer Credits: USGS The National Map: 3d Elevation Program, Data Refreshed July, 2021

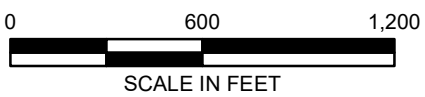

AKRF
 440 Park Avenue South, New York, NY 10016

975 Nostrand Avenue
 Brooklyn, New York

SITE LOCATION

DATE	8/23/2023
PROJECT NO.	210225
FIGURE	1

©2023 AKRF W:\Projects\190247 - LAMBERT HOUSES PARCEL 5\Technical\GIS and Graphics\Hazmat\MP2\10225 Figure 2 BCP Site Plan and Sample Location Plan.mxd 11/22/2023 5:55:09 PM iszelus

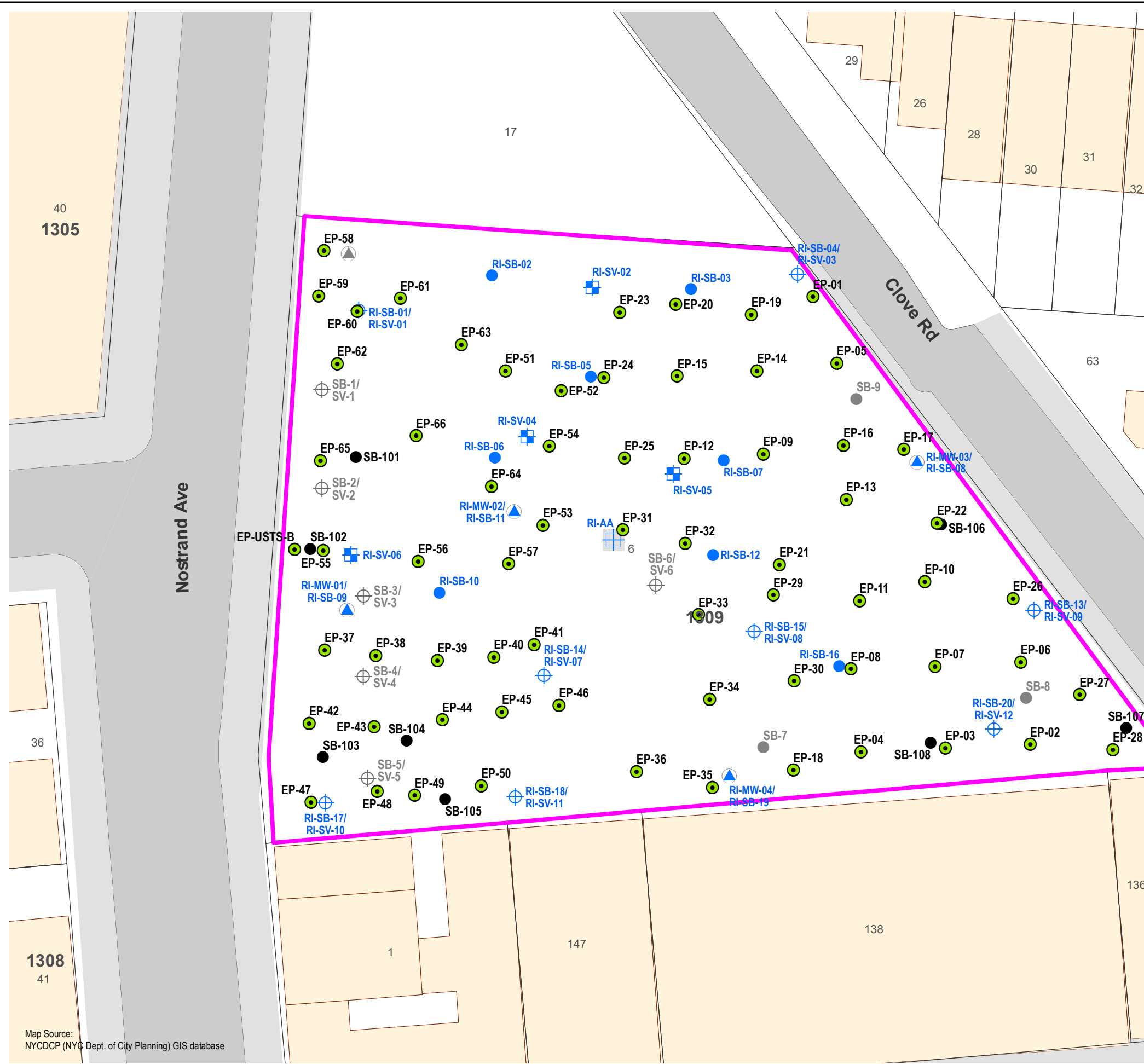

Map Source:
NYC DCP (NYC Dept. of City Planning) GIS database

LEGEND

- BCP SITE BOUNDARY
- LOT BOUNDARY
- 1309** BLOCK NUMBER
- BUILDING
- EXISTING MONITORING WELL
- PREVIOUS SOIL BORING (EBI CONSULTING, 2020)
- PREVIOUS SOIL BORING/SOIL VAPOR POINT (EBI CONSULTING, 2020)
- SOIL BORING LOCATION (AKRF, 2021)
- RI SOIL BORINGS
- RI SOIL BORING/MONITORING WELL
- RI SOIL BORING/SOIL VAPOR POINT
- RI SOIL VAPOR POINT
- RI AMBIENT AIR SAMPLING LOCATION
- ENDPOINT SAMPLE LOCATION

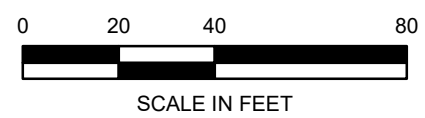

DATE	11/22/2023
PROJECT NO.	210225
FIGURE	2

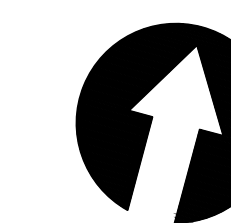

1 SOIL VAPOR EXTRACTION SYSTEM AS-BUILT LAYOUT
FIG 3

SCALE IN FEET
0 10 20 30 40 50 60 70 80 90 100

NOTE: PIPE SPACING NOT TO SCALE

SVE VAPOR MONITORING POINT LOCATIONS		
ID	COLUMN LOCATION	ROOM
SVMP-01	144	GARAGE (SOUTH)
SVMP-02	143	RETAIL STORAGE
SVMP-03	153	GAS ROOM

LEGEND

- ABOVEGROUND SOLID 4" Ø SCHEDULE 40 PVC PIPE FROM SVE WELLS
- SVE-01
- △ SVMP-1

2 SVE EQUIPMENT AREA
FIG 3

SCALE IN FEET
0 10 20 30 40 50 60 70 80 90 100

NOTE: PIPE SIZE AND SPACING NOT TO SCALE

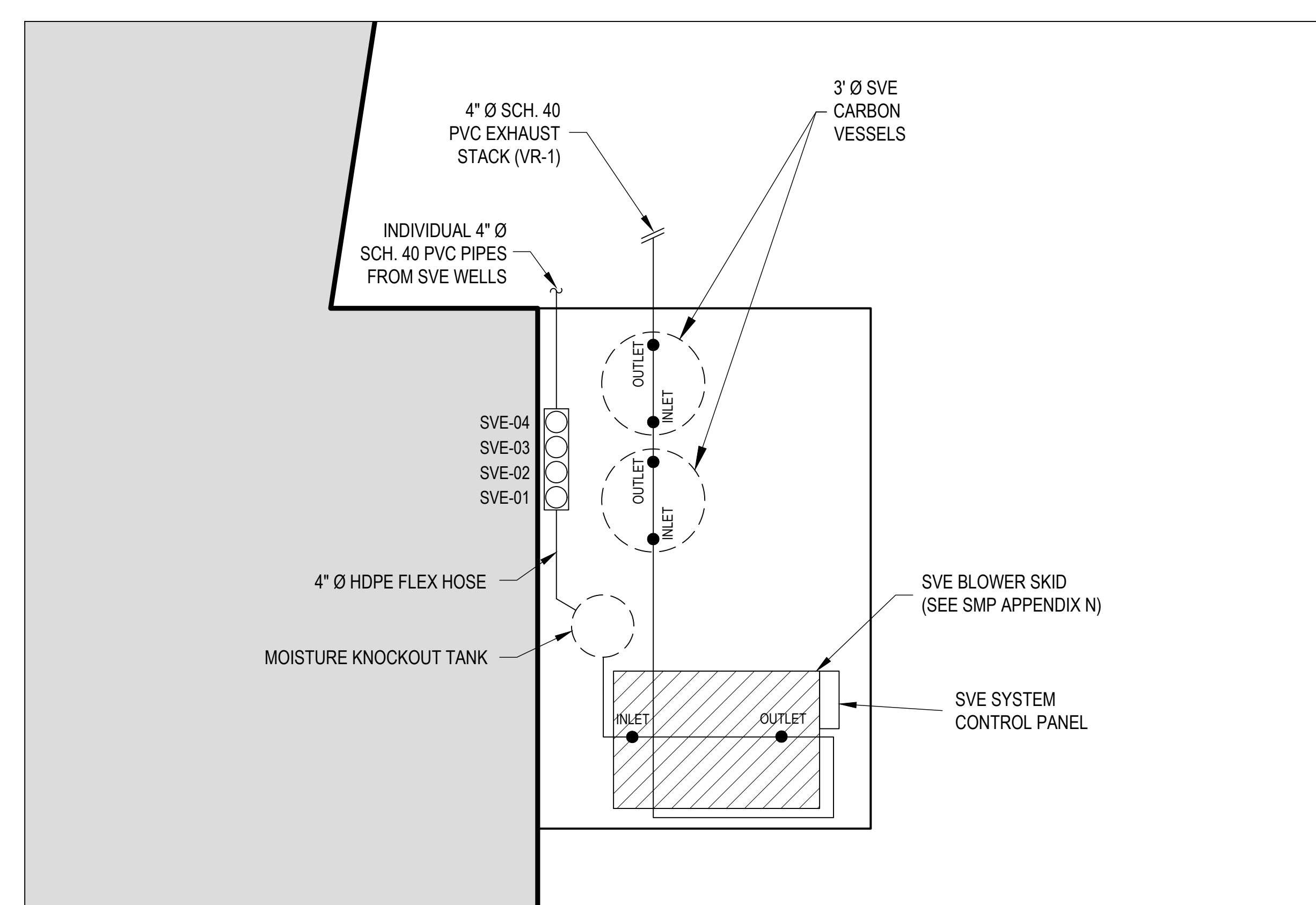

- LEGEND:**
- EXTENT OF GCP PREPRUFE AND GAS-PERMEABLE AGGREGATE UNDER 5" CONCRETE SLAB. TOP OF 5" CONCRETE SLAB = [65.25']
 - EXTENT OF GCP PREPRUFE AND GAS-PERMEABLE AGGREGATE UNDER 42" THICK FDN MAT. TOP OF 42" THICK CONCRETE FOUNDATION MAT = [65.25']
 - RISER SLAB PENETRATION
 - SOLID 4" DIA. SCHEDULE 40 PVC - MIN. 1% UNIFORM SLOPE TOWARDS SSDS SLOTTED PIPE OR CONDENSATE DRAIN
 - SLOTTED 4" DIA. SCHEDULE 40 PVC WITH PVC END CAP - NO SLOPE REQUIRED
 - SSDS MONITORING POINT
 - SOIL VAPOR EXTRACTION (SVE) WELL - BY OTHERS
 - SVE VAPOR MONITORING POINT - BY OTHERS
 - SSDS CONDENSATE DRAIN

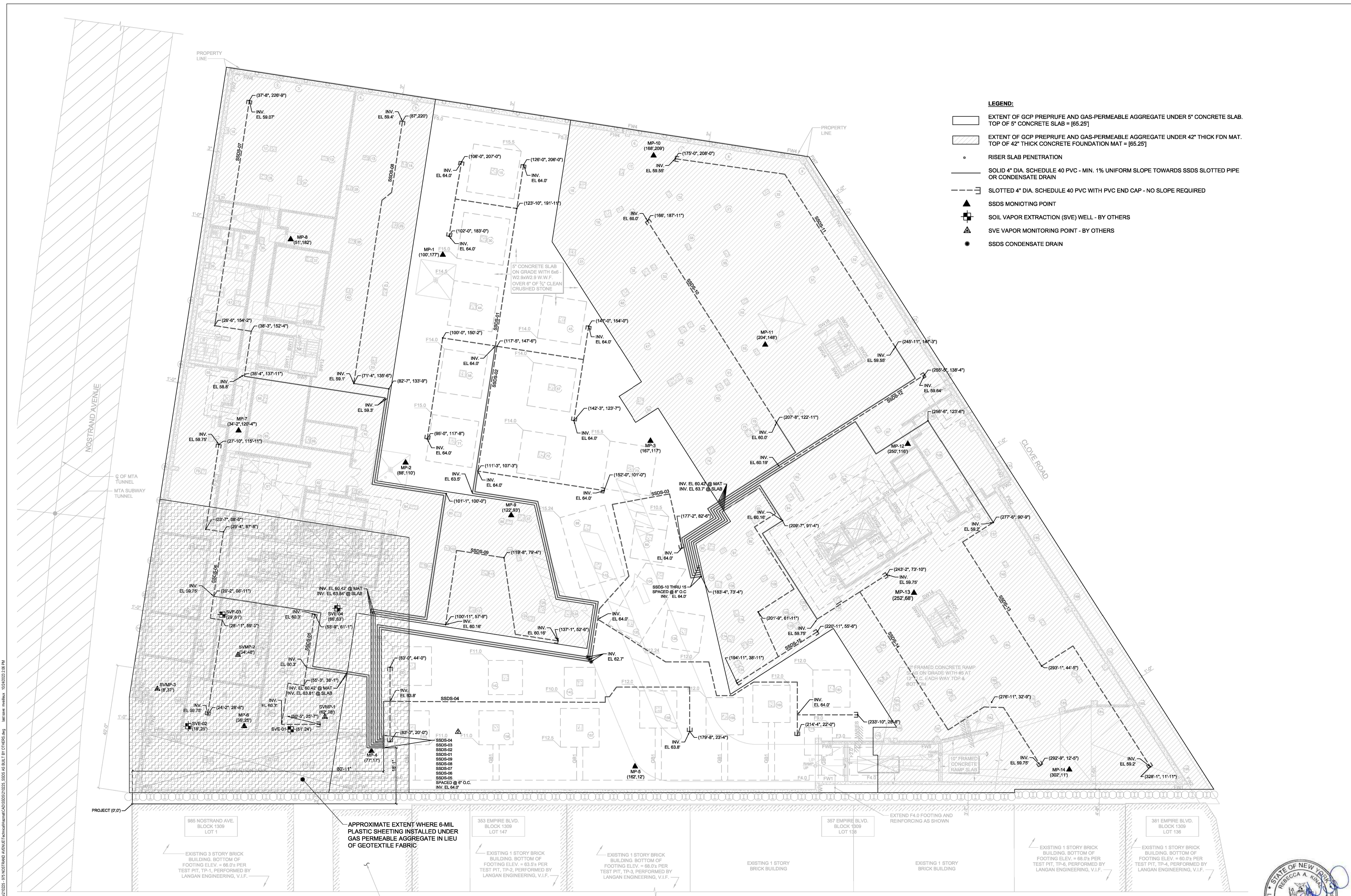

SOURCE: Oliviero Construction Corp., "SSDS & SVE AS-BUILT", Drawing No. VE-01, Dated September 06, 2023.



DATE	4/24/2024
PROJECT NO.	210225
FIGURE	4

ATTACHMENT A
SVES INSPECTION LOG

SVE INSPECTION LOG
MONTHLY SOIL VAPOR EXTRACTION SYSTEM INSPECTION
 975 Nostrand Avenue, Brooklyn, NY

Inspector Name: B. Hess	Date: 02/10/2026
Time IN: 09:00	Time OUT: 15:00

GENERAL

Weather: Partly Cloudy	Temperature: 27-34 F	Barometric Pressure: 30.12	Equipment Room Temperature: 55-60 F
------------------------	----------------------	----------------------------	-------------------------------------

When was the last rain event? 2/8/2026

Is the SVE blower currently operating? **Yes** / No (circle one)
 If no, ALERT PROJECT MANAGER and please list reason/alarm condition:

What is the VFD setting? 45 Hz
 If under 30 Hz, ALERT PROJECT MANAGER:

Is condensate in the knockout tank gauge below the low-high float sensor? **Yes** / No (circle one)
 If no, ALERT PROJECT MANAGER and manually drain knockout tank

Is transfer pump working? **Yes** / No (circle one)
 If no, ALERT PROJECT MANAGER.

Is 50-gallon drum full? Yes / **No** (circle one)
 If yes, acknowledge alarm on panel and ALERT PROJECT MANAGER.

Any evidence of system tampering, vandalism or damage? Yes / **No** (circle one)
 If yes, ALERT PROJECT MANAGER and please note findings:

Any evidence of system tampering, vandalism or damage to the exhaust stack? Yes / **No** (circle one)
 If yes, ALERT PROJECT MANAGER and please note findings:

Notes: This SVE Inspection Log should be completed along with the sampling log for each sampling event
 PID - Photoionization Detector; ppm - parts per million; NA - Not applicable; GAC - Granular Activated Carbon

Comments:

Emergency Contact Information			
Name	Title	Contact Number	
Ashutosh Sharma	AKRF Project Manager	646-388-9865 (office)	
Joseph Kohl Riggs	Owner's Representative	718-473-9663 (office)	

SVE INSPECTION LOG
MONTHLY SOIL VAPOR EXTRACTION SYSTEM INSPECTION
 975 Nostrand Avenue, Brooklyn, NY

SVE Operation
CALL PROJECT MANAGER IF READING OUTSIDE ACCEPTABLE/TYPICAL RANGE (IN GRAY)

Pre-Blower Inlet Temperature (°F): 40-80°F		Post-Blower Outlet Temperature (°F): 70-110°F		Knockout Tank Vacuum (Inches of water column): 0-90 inH2O
55		105		12.5
Pre-filter Vacuum (Inches of water column): 0-90 inH2O		Post-filter Vacuum (Inches of water column): 0-90 inH2O		Post-Blower Pressure (Inches of water column): 0-90 inH2O
19		17		58
GAC Influent PID (ppm):		GAC Intermediate PID (ppm): Less than GAC Influent PID		GAC Effluent PID (ppm): 0 ppm
2.7		0.0		0.0
<i>Monitoring Location</i>	<i>Vacuum Reading "H2O</i> <small>Between 0 and 90 "H2O</small>	<i>Air Flow Reading "H2O</i> <small>Between 0.000 and 0.050 "H2O</small>	<i>Air Flow Reading CFM</i>	<i>Notes</i>
SVE-01	12	0.02		
SVE-02	12.5	0.043		Gauge reading zero - Used monometer to get reading.
SVE-03	11.5	0.08		
SVE-04	12	0.06		
SVMP-01	-0.375			
SVMP-02	-0.447			
SVMP-03	-0.525			

ATTACHMENT B

Indoor Air Sampling Work Plan and Approval Letter



October 30, 2025

Joseph Riggs
Nostrand Green LLC
826 Broadway, 11th Floor
New York, NY 10003

Re: **975 Nostrand Avenue
Brownfield Cleanup Program Site No. C224335
Indoor Air Sampling Work Plan**

Dear Joseph Riggs:

The New York State Department of Environmental Conservation (the NYSDEC), in consultation with the New York State Department of Health (NYSDOH), has reviewed the Indoor Air Sampling Work Plan (IASWP) dated October 2025 for the above referenced site, which was prepared by AKRF, Inc. on behalf of Nostrand Green LLC (the Volunteer). The IASWP was submitted to NYSDEC under the Brownfield Cleanup Program for project number C224335. The IASWP has been revised to adequately address comments provided by the NYSDEC and NYSDOH on previous drafts of the document and is hereby approved.

In accordance with the terms of the Brownfield Cleanup Agreement (BCA), please notify the Department at least 7 days in advance of commencing fieldwork related to the IASWP. If you have any questions, please feel free to contact me at (718) 482-4065 or christopher.allan@dec.ny.gov.

Sincerely,

Christopher Allan
Project Manager

ec: J. O'Connell, C. Maycock – NYSDEC
S. McLaughlin, R. Minzloff – NYSDOH
A. Sharma, A. Schwendt, T. Larigan – AKRF

**975 NOSTRAND AVENUE
BROOKLYN, NEW YORK**

Indoor Air Sampling Work Plan

**NYSDEC BCP Site No: C224335
AKRF Project Number: 210225**

Prepared for:

New York State Department of Environmental Conservation
Division of Environmental Remediation, Remedial Bureau B
625 Broadway, 12th Floor
Albany, New York 12233

On Behalf of:

Nostrand Green LLC
826 Broadway, 11th Floor
New York, NY 10003

Prepared by:

akrf

AKRF, Inc.
440 Park Avenue South, 7th Floor
New York, New York 10016
(212) 696-0670

OCTOBER 2025

TABLE OF CONTENTS

1.0	INTRODUCTION.....	1
2.0	SITE DESCRIPTION AND HISTORY	2
2.1	Site Description and Surrounding Land Use	2
2.2	Site Geology, Hydrogeology, and Subsurface Characteristics	2
2.3	Site History	2
3.0	FIELD PROGRAM.....	3
3.1	Pre-Sampling Survey	3
3.2	Indoor Air Sampling	3
3.3	Ambient Air Sampling	3
3.4	Laboratory Analysis.....	4
4.0	REPORTING REQUIREMENTS	5
4.1	Daily Reporting	
4.2	Indoor Air Sampling Report (IASR).....	5
4.2.1	Description of Field Activities.....	5
4.2.2	Indoor Air and Ambient Air Assessment.....	5
5.0	CERTIFICATION.....	6

FIGURES

Figure 1 – Site Location

Figure 2 – Soil Vapor Sample Concentrations Identified During the Remedial Investigation and Pre-Design Investigation

Figure 3 – Proposed Indoor Air Sampling Locations

APPENDICES

Appendix A – Quality Assurance Project Plan (QAPP)

Appendix B – NYSDOH Indoor Air Quality Questionnaire and Building Inventory Form

1.0 INTRODUCTION

This Indoor Air Sampling (IAS) Work Plan (IASWP) describes the procedures to be used during the IAS, which will be performed to evaluate the effectiveness of the active sub-slab depressurization system (SSDS) installed at the 975 Nostrand Avenue project site, located in Brooklyn, New York (hereinafter referred to as the “Site”). The Site is identified on the New York City Tax Map as Queens Borough Block 1309, Lot 6. The Site was remediated under the New York State Department of Environmental Conservation (NYSDEC) Brownfield Cleanup Program (BCP) (Site No. C224335) to a Track 2 Restricted Residential Soil Cleanup Objectives (RRSCOs). Site location is shown on Figure 1.

Soil vapor samples collected during the remedial investigation (RI) and pre-design investigation (PDI) detected several petroleum-related volatile organic compounds (VOCs), including benzene, toluene, ethylbenzene, xylene (collectively referred to as “BTEX”) and chlorinated VOCs (CVOCs) 1,1,1-trichloroethane, tetrachloroethene (PCE), and trichloroethene (TCE). Based on the findings, a vapor mitigation system, consisting of a vapor barrier membrane and an active SSDS was installed below the entire new building footprint to prevent vapor intrusion. In addition, and to address bulk CVOC contamination identified in the southwestern portion of the Site, a soil vapor extraction system (SVES) was installed on a smaller (approximately 4,000 square feet) area to treat on-Site soil vapor. The soil vapor concentrations across the Site are shown on Figure 2.

This IASWP describes the procedures to be used during the IAS, which will include collection of indoor air (IA) samples from the new building cellar to evaluate effectiveness of the active SSDS. The results of the IAS will be documented in an IAS Report, which will evaluate Site-specific data in accordance with the New York State Department of Health (NYSDOH) Soil Vapor Intrusion (SVI) Guidance and Decision Matrices to determine whether actions are necessary to address potential exposure to soil vapor intrusion into the new building. The IA samples will be collected following completion of the building envelope and during the heating season and while the heating, ventilation, and air conditioning (HVAC) is operational and SSDS is running (for a minimum of 30 days prior to sample collection) to confirm the effectiveness of the system in addressing any potential indoor air concerns in the new building. All work will be completed in accordance with this IASWP, the Quality Assurance Project Plan (QAPP) included as Appendix A, and the Health and Safety Plan (HASP) included as Appendix H in the NYSDEC-approved Site Management Plan (SMP).

2.0 SITE DESCRIPTION AND HISTORY

2.1 Site Description and Surrounding Land Use

The Site is located in Brooklyn, Kings County, New York, and is identified as Block 1309 and Lot 6 on the New York City Tax Map. The Site location is shown on Figure 1. The Site is an approximately 1.369-acre parcel bounded to the north by a construction site; to the east by Clove Road, followed by multi-family residential buildings; to the south by mixed residential and commercial uses; and to the west by Nostrand Avenue, followed by mixed residential and commercial uses and Sullivan Place.

The Site is currently being redeveloped with a new mixed-use residential and commercial use building with a cellar. The Site is zoned as R7-1 (residential) and C2-3 (commercial), and the new building occupies the entire Site.

2.2 Site Geology, Hydrogeology, and Subsurface Characteristics

The surface topography at the Site generally slopes down toward the south. Soil encountered during the Remedial Investigation (RI) and Subsurface Investigation (SI) consisted of fill materials comprising sand, gravel, and silt with varying amounts of concrete, brick, wood, ash, glass, and asphalt from surface grade to 15 feet below ground surface (bgs). The fill was underlain by sand, silt, and clay with gravel.

Based on the U.S. Geological Survey, Brooklyn, New York quadrangle map, the Site lies at approximately 85 feet above the North American Vertical Datum of 1988 (NAVD88).

Based on the site-specific groundwater measurements, groundwater beneath the Site ranges from 10.71 to 10.78 feet NAVD88 (65.51 to 71.85 feet bgs). The groundwater flow direction could not be confirmed based on the Site-specific groundwater depths and elevation survey; however, based on the topography of the area, groundwater beneath the Site is expected to flow in a southwesterly direction towards Prospect Lake (the nearest surface water body). Groundwater in Brooklyn is not used as a source of potable water.

2.3 Site History

Based on a review of historical Sanborn maps and City Directories, the Site was developed with a trucking company as early as 1908. At the time, a portion of an unspecified road intersected the eastern portion of the Site in a north-south direction. By 1932, the Site was developed with stores, a parking garage, a printing facility, upholstery facility, and a carpenter. By 1963, the parking garage was replaced by a textiles warehouse. An auto repair shop was shown in the southern portion of the Property between 1963 and 1965, and by 1978, the Site comprised a commercial use building (demolished Spring 2022, prior to remediation) and an asphalt paved parking lot.

3.0 FIELD PROGRAM

The field program will focus on collecting IA samples from the building cellar following installation and startup of the active SSDS. The IA samples will be collected during the heating season (while HVAC is running) following completion of the building envelope, and once the SSDS has been turned on and has been running for at least 30 days. If HVAC installation is completed outside of the heating season, then the samples will be collected during the next heating season. The IAS will include the collection of seven IA samples from the building cellar and one ambient air sample from the exterior area. The proposed sample locations are shown on Figure 3. Samples will be collected during a normal business day and unnecessary building ventilation will be avoided within 24 hours prior to sampling. All work will be implemented in accordance with the Quality Assurance Project Plan (QAPP), provided as Appendix A.

3.1 Pre-Sampling Survey

Prior to conducting the sampling, AKRF will perform a pre-sampling survey to gather information on: the Site building characteristics; air flow patterns; HVAC; utilities; building operations; chemical and maintenance product inventory; and other known factors that may affect indoor air quality in the building. A photoionization detector (PID) with a parts per billion (ppb) detection range (e.g., ppbRAE 3000 or equivalent) will be used during the survey to screen for VOCs near windows, air supply vents, stored chemicals, and other potential sources. An NYSDOH Indoor Air Quality Questionnaire and Building Inventory form will be used to document the results of the survey. The NYSDOH form is included as Appendix B.

3.2 Indoor Air Sampling

Indoor air samples (IA-01 through IA-07) will be collected in the building cellar and from locations shown on Figure 3. The samples will be collected using batch-certified, 6-Liter, SUMMA[®] canisters equipped with vacuum gauges and flow controllers calibrated to collect the sample over an approximately 24-hour period. The SUMMA[®] canisters will be placed at typical breathing zone height (approximately five feet above the floor) during sample collection. Immediately after opening the flow control valve, the initial SUMMA[®] canister vacuum (in. Hg) will be noted. Conditions will be noted throughout the sampling period, including vacuum of the samples and potential sources of VOCs in the vicinity of the sampling locations. Once the vacuum reading on the flow controller reads between approximately -8 in. Hg and -2 in. Hg (after approximately 24 hours), the flow controller valve will be closed, the final vacuum will be noted, and the SUMMA[®] canister will be placed in a shipping carton for delivery to the laboratory.

3.3 Ambient Air Sampling

One ambient (outdoor) air sample will be collected from an exterior location at the proposed location shown on Figure 3. The actual ambient air sample location will be determined during the pre-sampling survey (Section 3.1) based on weather conditions and any work or other activities nearby. The ambient air sample will be collected concurrently with the indoor air samples in a batch-certified 6-Liter SUMMA[®] canister equipped with a vacuum gauge and flow controller calibrated to collect the sample over an approximately 24-hour period. The SUMMA[®] canister will be placed at typical breathing zone height (approximately five feet above the ground) during collection. Immediately after opening the flow control valve, the initial SUMMA[®] canister vacuum (in. Hg) will be noted. Conditions will be noted throughout the sampling period, including vacuum of the samples and potential sources of VOCs in the vicinity of the sampling locations. Once the vacuum reading on the flow controller reads between approximately -8 in. Hg and -2 in. Hg (after approximately 24 hours), the flow controller valve will be closed, the final vacuum will be noted, and the SUMMA[®] canister will be placed in a shipping carton for delivery to the laboratory.

3.4 Laboratory Analysis

Samples will be shipped to the laboratory with a chain of custody (COC). The indoor air and ambient air samples will be analyzed for VOCs by Environmental Protection Agency (EPA) Method TO-15 by a NYSDOH Environmental Laboratory Accreditation Program (ELAP)-certified laboratory with Category B deliverables and will be validated by a third-party prior to electronic data deliverable (EDD) submission to NYSDEC via EQUIS™. The laboratory reports will be reviewed by a third-part data validator and Data Usability Summary Reports (DUSRs) will be prepared and included in the report.

4.0 REPORTING REQUIREMENTS

4.1 Daily Reporting

During the sampling, daily reports will be submitted to NYSDEC and NYSDOH by noon the next business day for each day of work on-site. The daily reports will include an update of progress made during the reporting day, including the number samples collected and their respective locations on-site; and a summary of any, and all, complaints with relevant details (names, phone numbers).

Daily reports are not intended to be the mode of communication for notification to NYSDEC and NYSDOH of emergencies (e.g., accident, spill, etc.), requests for changes to this IASWP, or other sensitive or time critical information.

4.2 Indoor Air Sampling Report (IASR)

Upon completion of field work and receipt of laboratory analytical results, an IASR will be prepared in compliance with Section 3.14 of DER-10. The IASR will include: a description of investigation and sampling methods; a presentation of the field and laboratory analytical results; field data sheets, the pre-sampling inspection form, and laboratory analytical reports as attachments; DUSRs; and an interpretation of the findings and recommendations. The results of the sampling will be presented relative to the NYSDOH Soil Vapor Intrusion Guidance matrices. The results will be compared to the indoor air matrices values only since no sub-slab soil vapor samples will be collected during the evaluation. The lowest values of acceptable concentrations of compounds in the matrices will be used to compare to the decision matrices.

4.2.1 Description of Field Activities

The field activities section of the IASR will describe the field methods used, including sampling techniques and field screening equipment.

4.2.2 Indoor Air and Ambient Air Assessment

The IASR will include a section that presents field and laboratory data. Figures will be provided that illustrate the sampling locations. Field and laboratory analytical results will be presented in the body of the report, summarized in tables and figures, and the detected concentrations will be compared to regulatory standards and/or guidance values/matrices. Sampling logs and laboratory analytical reports will be provided as attachments.

5.0 CERTIFICATION

I, Rebecca Kinal, P.E., certify that I am currently a New York State registered Progressional Engineer as defined in 6 NYCRR Part 375 and that this Indoor Air Sampling Work Plan was prepared in accordance with all applicable statutes and regulations and in substantial conformance with the DER Technical Guidance for Site Investigation and Remediation (DER-10).

Rebecca Kinal
NYS Professional Engineer # 082046-1
Name



Signature

10/17/2025
Date

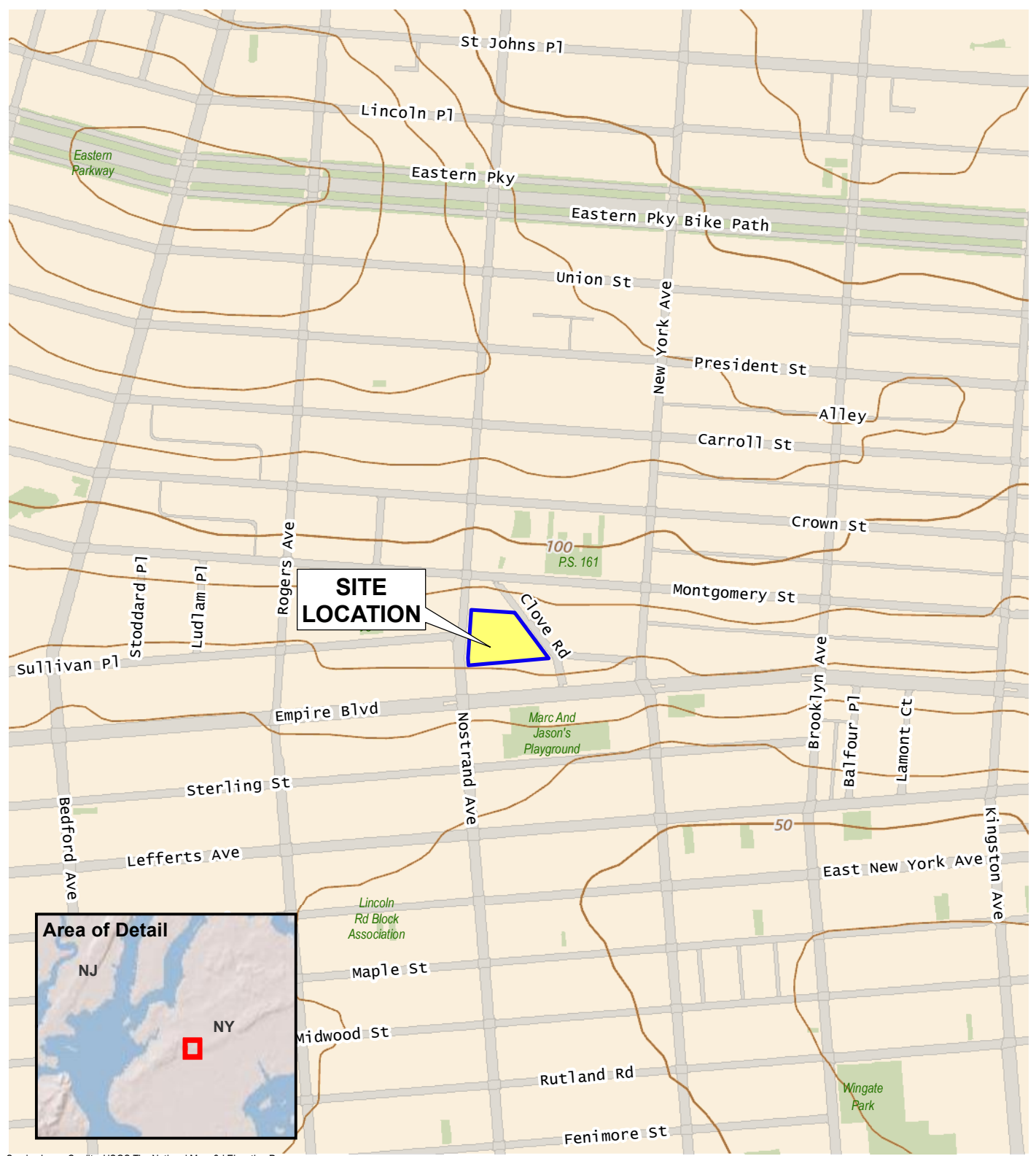

FIGURES

© 2023 AKRF. W:\Projects\210225 - 975 Nostrand Avenue\Technical\GIS and Graphics\SAR\210225 Figure 1 Site Location map.mxd 11/2/2022 10:32:53 AM iszalus



Service Layer Credits: USGS The National Map: 3d Elevation Program, Data Refreshed July, 2021

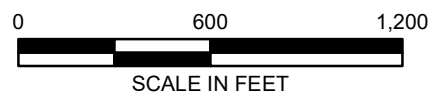

AKRF
 440 Park Avenue South, New York, NY 10016

975 Nostrand Avenue
 Brooklyn, New York

SITE LOCATION

DATE	8/23/2023
PROJECT NO.	210225
FIGURE	1

975 Nostrand Avenue Brooklyn, New York Soil Vapor Concentrations Identified During the Remedial Investigation and Pre-Design Investigation

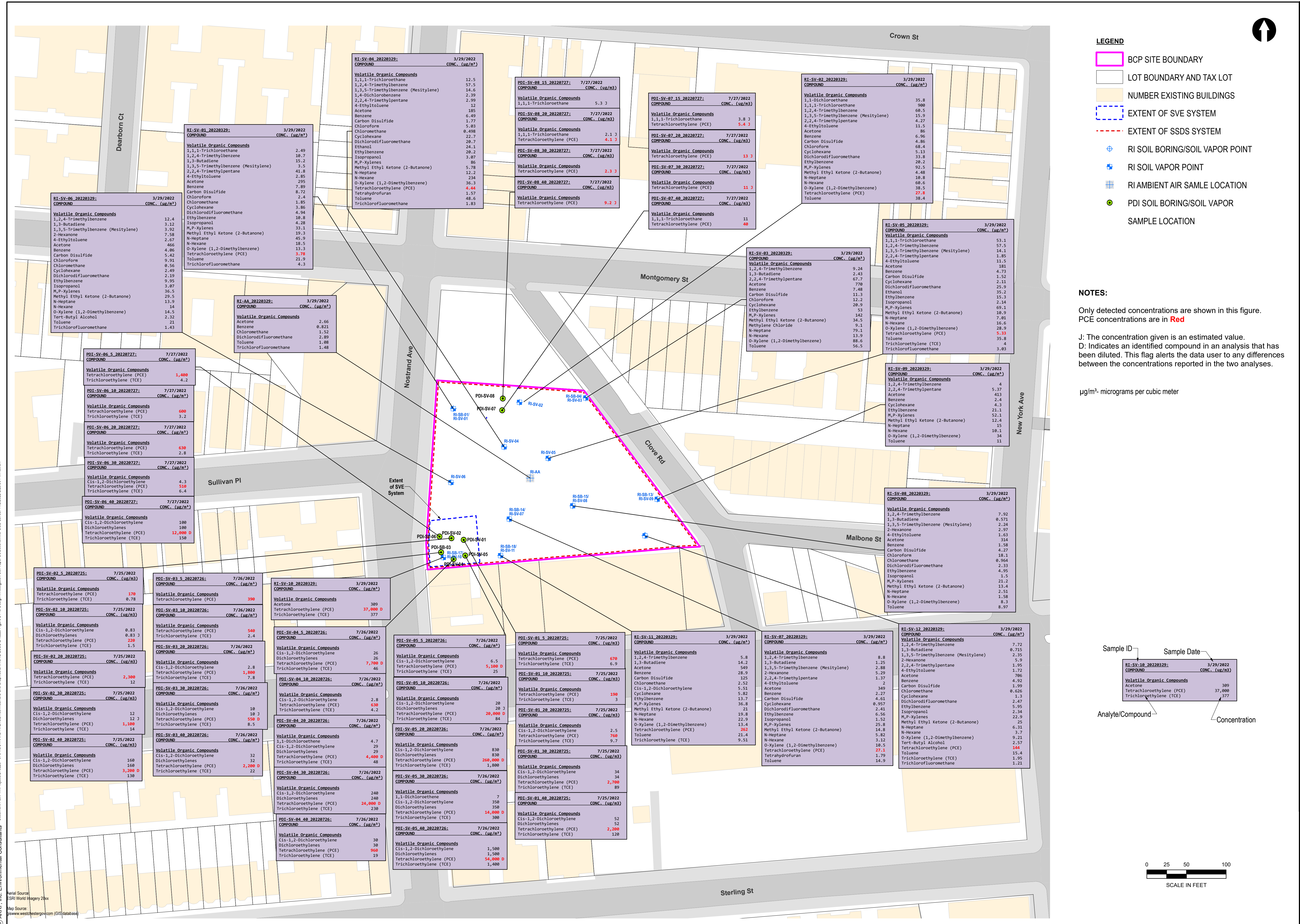

LEGEND

- BCP SITE BOUNDARY
LOT BOUNDARY AND TAX LOT
NUMBER EXISTING BUILDINGS
EXTENT OF SVE SYSTEM
EXTENT OF SSDS SYSTEM
RI SOIL BORING/SOIL VAPOR POINT
RI SOIL VAPOR POINT
RI AMBIENT AIR SAMLE LOCATION
PDI SOIL BORING/SOIL VAPOR SAMPLE LOCATION

NOTES:

Only detected concentrations are shown in this figure. PCE concentrations are in Red

J: The concentration given is an estimated value. D: Indicates an identified compound in an analysis that has been diluted. This flag alerts the data user to any differences between the concentrations reported in the two analyses.

ug/m³- micrograms per cubic meter

Table with columns: Sample ID, Sample Date, Analyte/Compound, Concentration. It shows data for sample RI-SV-10-20220726.



AKRF, Inc. Environmental Consultants
Document Path: W:\Projects\210225 - 975 Nostrand Avenue\Technical\GIS and Graphics\ASVS\ASVS_ECD0110225_Figure 2 Pre-Design Investigation Soil Vapor Data and Date Sheet_11/2/2022 2:23:50 PM.Ambur

©2025 AKRF, Inc. Q:\Projects\210225 - 975 NOSTRAND AVENUE\Technical\Hazmat\CAD\IASWP\210225 Figure 3 - Proposed Indoor Air Sample Locations.dwg last save: mveilleux 10/10/2025 4:30 PM



LEGEND

- PROPOSED INDOOR AIR SAMPLE LOCATION
- ⊕ PROPOSED AMBIENT AIR SAMPLE LOCATION

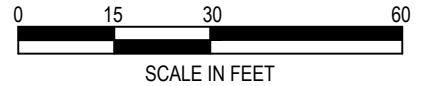

Source:
 ODA New York Architects "975 Norstrand Avenue - Cellar Floor Plan-Key Plan",
 DWG No: A-100, Revised 02/25/2022.

akrf
 440 Park Avenue South
 7th Floor
 New York, NY 10016
 (212) 696-0670 | www.akrf.com

975 Nostrand Avenue
 Brooklyn, New York

PROPOSED INDOOR AIR SAMPLE LOCATIONS

DATE	10/10/2025
PROJECT NO.	210225
FIGURE	3

APPENDIX A
QUALITY ASSURANCE PROJECT PLAN (QAPP)

**975 NOSTRAND AVENUE
BROOKLYN, NEW YORK**

Quality Assurance Project Plan

**NYSDEC BCP Site No: C224335
AKRF Project Number: 210225**

Prepared for:

New York State Department of Environmental Conservation
Division of Environmental Remediation, Remedial Bureau B
625 Broadway, 12th Floor
Albany, New York 12233

On Behalf Of:

Nostrand Green LLC
826 Broadway, 11th Floor
New York, NY 10003

Prepared by:

akrf

AKRF, Inc.
440 Park Avenue South
New York, New York 10016
(212) 696-0670

SEPTEMBER 2025

TABLE OF CONTENTS

1.0	INTRODUCTION	1
2.0	PROJECT TEAM	2
2.1	Quality Assurance/Quality Control Officer.....	2
2.2	Remedial Engineer	2
2.3	Project Manager.....	2
2.4	Field Team Leader, Field Technician, Site Safety Officer, and Alternates.....	2
2.5	Laboratory Quality Assurance/Quality Control (QA/QC) Officer	2
2.6	Laboratory Data Validator.....	3
3.0	STANDARD OPERATING PROCEDURES (SOPs).....	4
3.1	Decontamination of Sampling Equipment.....	4
3.2	Management of Investigation Derived Waste (IDW).....	4
4.0	SAMPLING AND LABORATORY PROCEDURES	5
4.1	Indoor Air Sampling.....	5
4.1.1	Sample Set-up	5
4.1.2	Sample Collection	5
4.2	Laboratory Methods	5
4.3	Quality Control (QC) Sampling	5
4.4	Sample Handling	6
4.4.1	Sample Identification	6
4.5	Field Instrumentation.....	7
4.6	Quality Assurance (QA)	7
4.7	Data Quality Objectives (DQOs) and Process.....	7
4.8	Reporting of Data	8

FIGURES

Figure 1 - Site Location

TABLES

Table 1 – Laboratory Analytical Methods
Table 2 – Field Sample and QC Sample Quantities
Table 3 – Sample Nomenclature

ATTACHMENTS

Attachment A – Resumes for Project Director, Quality Assurance Officer, Project Manager, Project Manager Alternates, and Field Team Leaders

1.0 INTRODUCTION

This Quality Assurance Project Plan (QAPP) describes the protocols and procedures that will be followed during implementation of the Indoor Air Sampling (IAS) Work Plan (IASWP) at the 975 Nostrand Avenue project site, located in Brooklyn, New York, hereafter referred to as “the Site.” The legal definition of the Site is NYC Tax Block 1309, Lot 6. The Site is an approximately 1.369-acre parcel bounded to the north by a construction site; to the east by Clove Road, followed by multi-family residential buildings; to the south by mixed residential and commercial uses; and to the west by Nostrand Avenue, followed by mixed residential and commercial uses and Sullivan Place. A Site Location Plan is provided as Figure 1.

The objective of this QAPP is to provide for Quality Assurance (QA) and maintain Quality Control (QC) during sampling performed under the IASWP for BCP Site No. C224335. Adherence to the QAPP will ensure that defensible data will be obtained to confirm the successful operation and maintenance of remedial systems or other engineering controls.

2.0 PROJECT TEAM

The project team will be drawn from AKRF professional and technical personnel, and AKRF's subcontractors. All field personnel and subcontractors will have completed a 40-hour training course and updated 8-hour refresher course that meet the Occupational Safety and Health Administration (OSHA) requirements of 29 CFR Part 1910. The following sections describe the key project personnel and their responsibilities.

2.1 Quality Assurance/Quality Control Officer

The QA/QC Officer will be responsible for adherence to this QAPP and will review the procedures with all personnel prior to commencing any fieldwork and conduct periodic Site inspections to assess implementation of the procedures. Axel Schwendt will serve as the QA/QC officer for the SMP. Mr. Schwendt's resume is included in Attachment A.

2.2 Remedial Engineer

The Remedial Engineer is a registered professional engineer licensed by the State of New York. The Remedial Engineer will have primary direct responsibility for implementation of the IASWP, and will certify the IAS Report (IASR) summarizing the findings of the sampling. The Remedial Engineer will also certify that the IAS activities were conducted by qualified environmental professionals under her supervision and that the requirements set forth in the IASWP and any other relevant provisions of ECL 27-1419 have been achieved in full conformance with that Plan. The Remedial Engineer for this project will be Rebecca Kinal, P.E. Ms. Kinal's resume is included in Attachment A.

2.3 Project Manager

The project manager will be responsible for directing and coordinating all elements of the IAS. The project manager will prepare reports and participate in meetings with the Site owner/BCP Requestor, and/or the NYSDEC, as needed. Ashutosh Sharma will serve as the project manager for the SMP. Mr. Sharma's resume is included in Attachment A.

2.4 Field Team Leader, Field Technician, Site Safety Officer, and Alternates

The field team leader will be responsible for conducting sampling activities in the field and will ensure adherence to the IASWP and Health and Safety Plan (HASP), included in Appendix H of the December 2023 (revised January 2024) Site Management Plan (SMP). The field team leader will also act as the field technician and Site safety officer (SSO) and will report to the project manager or project manager alternate on a regular basis regarding daily progress and any deviations from the work plan. The field team leader will be a qualified and responsible person able to act professionally and promptly during environmental work at the Site. Stephen Schmid will act as the field team leader. The field team leader alternate is Brian Quinn. Resumes for Mr. Schmid and Mr. Quinn are included in Attachment A.

2.5 Laboratory Quality Assurance/Quality Control (QA/QC) Officer

The laboratory QA/QC officer will be responsible for quality control procedures and checks in the laboratory and ensuring adherence to laboratory protocols. The QA/QC officer will track the movement of samples from the time they are checked in at the laboratory to the time that analytical results are issued, and will conduct a final check on the analytical calculations and sign off on the laboratory reports. The laboratory QA/QC officer will be Carl Armbruster of Eurofins Environmental Testing – Edison, of Edison, New Jersey, a New York State Department of Health (NYSDOH) Environmental Laboratory Accreditation Program (ELAP)-certified laboratory being employed for all environmental sampling at the Site.

2.6 Laboratory Data Validator

The laboratory data validator will be responsible for third party data validation and preparation of Data Usability Summary Reports (DUSRs). The third-party laboratory data validator will be Lori Beyer of L.A.B. Validation Corp.

3.0 STANDARD OPERATING PROCEDURES (SOPS)

The following sections describe the SOPs for the monitoring activities included in the IASWP. During these operations, safety monitoring will be performed as described in the HASP, included as Appendix H of the SMP.

3.1 Decontamination of Sampling Equipment

No drilling work is expected or planned during the sampling. However, all sampling equipment will be either dedicated or decontaminated between sampling locations. Decontamination will be conducted on plastic sheeting (or equivalent) that is bermed to prevent discharge to the ground. The decontamination procedure will be as follows:

1. Scrub using tap water/Alconox[®] mixture and bristle brush.
2. Rinse with tap water.
3. Scrub again with tap water/Alconox[®] mixture and bristle brush.
4. Rinse with tap water.
5. Rinse with distilled water.
6. Air-dry the equipment, if possible.

3.2 Management of Investigation Derived Waste (IDW)

No IDW is expected to be generated. If any IDW is generated, it will be containerized in New York State Department of Transportation (NYSDOT)-approved 55-gallon drums during the site management activities. The drums will be sealed at the end of each workday and labeled with the date, the boring location(s), the type of waste e.g., drill cuttings, excavated trenching material), and the name and phone number of an AKRF point-of-contact. All IDW collected into drums will be sampled and disposed of or treated according to applicable local, state, and federal regulations.

4.0 SAMPLING AND LABORATORY PROCEDURES

4.1 Indoor Air Sampling

Indoor air sampling will be conducted using Summa canisters with 24-hour flow regulators. Samples will be collected using the following procedures:

4.1.1 Sample Set-up

1. Conduct a pre-sampling inspection and record chemical inventory of the Site building.
2. Verify proposed sampling locations based on Site conditions. Proposed sample locations may need to be adjusted based on field conditions.

4.1.2 Sample Collection

1. After Summa canisters are set up at all of the sampling locations, record the vacuum reading from the vacuum gauge on each canister at the beginning of the 24-hour sampling period. Open the valve of the canister and record the time in the field book. Place labeled Summa canisters at the breathing zone level (minimum of 3 to 5 feet above the floor) for collection of indoor air (IA) samples from the cellar level over a 24-hour period.
2. At the end of the 24-hour sampling period, close the valve, remove the flow-rate controllers and vacuum gauges, install caps on canisters, and record the time at the end of the sampling period.
3. Place the IA samples in shipping containers for transportation to the laboratory.
4. Repeat the procedure for all sampling locations.

4.2 Laboratory Methods

Table 1 summarizes the laboratory methods that will be used to analyze field samples and the sample container type, preservation, and applicable holding times. Eurofins Environmental Testing America - Edison of Edison, New Jersey, a NYSDOH ELAP-certified laboratory subcontracted to AKRF, will be used for all chemical analyses in accordance with the Division of Environmental Remediation (DER)-10 2.1(b) and 2.1(f) with Category B Deliverables.

Table 1
Laboratory Analytical Methods

Matrix	Analysis	EPA Method	Bottle Type	Preservative	Hold Time
Indoor Air	VOCs	TO-15	6L Summa Canisters (24-hr flow controllers)	None	30 days

Notes:

EPA - Environmental Protection Agency

4.3 Quality Control (QC) Sampling

An ambient air sample will be included for QC measures.

Table 2
Field Sample and QC Sample Quantities

Sample Type	Parameters	EPA Method ¹	Field Samples
Indoor Air	VOCs	TO-15	7
Ambient Air	VOCs	TO-15	1

Notes:

1 - NYSDEC July 2005 ASP Category B deliverables

4.4 Sample Handling

4.4.1 Sample Identification

All samples will be consistently identified in all field documentation, chain-of-custody (COC) documents, and laboratory reports. All samples will be amended with a collection date at the end of the sample name in a year, month, day (YYYYMMDD) format. Special characters, including primes/apostrophes (’), will not be used for sample nomenclature.

Sample Identification

All samples will be consistently identified in all field documentation, chain-of-custody documents and laboratory reports using an alpha-numeric code. Table 3 provides examples of the sampling identification scheme for samples collected during the IAS activities.

Table 3
Sample Nomenclature

Sample Description	Sample Designation
Indoor air sample collected from the cellar of the building on September 15, 2025	IA-01_20250915

Sample Labeling and Shipping

All sample containers will be provided with labels containing the following information:

- Project identification, including Site name, BCP Site number, Site address
- Sample identification
- Date and time of collection
- Analysis(es) to be performed
- Sampler’s initials

The samples will be collected using laboratory-supplied SUMMA[®] canisters. The COC form will be properly completed by the sampler in ink, and all sample shipment transactions will be documented with signatures, and the date and time of custody transfer. Samples will be shipped overnight (e.g., Federal Express) or transported by a laboratory courier. All containers shipped to the laboratory will be sealed with mailing tape and a COC seal to ensure that the samples remain under strict COC protocol.

Sample Custody

Field personnel will be responsible for maintaining the sample containers in a secured location until they are picked up and/or sent to the laboratory. The record of possession

of samples from the time they are obtained in the field to the time they are delivered to the laboratory or shipped off-site will be documented on COC forms. The COC forms will contain the following information: project name; names of sampling personnel; sample number; date and time of collection and matrix; and signatures of individuals involved in sample transfer, and the dates and times of transfers. Laboratory personnel will note the condition of the custody seal and sample containers at sample check-in.

4.5 Field Instrumentation

Field personnel will be trained in the proper operation of all field instruments at the start of the field program. Instruction manuals for the equipment will be on file at the Site for referencing proper operation, maintenance, and calibration procedures. The equipment will be calibrated according to manufacturer specifications at the start of each day of fieldwork. If an instrument fails calibration, the project manager or QA/QC officer will be contacted immediately to obtain a replacement instrument. A calibration log will be maintained to record the date of each calibration, any failure to calibrate and corrective actions taken. The PID will be equipped with a 10.6 electron volt (eV) lamp and will be calibrated each day using 100 parts per million (ppm) isobutylene standard gas in accordance with the manufacturer's standards.

4.6 Quality Assurance (QA)

All laboratory analytical data will be reviewed by a third-party validator and a Data Usability Summary Report (DUSR) will be prepared to document the usability and validity of the data. The objective of the third-party validator is to provide an unbiased review to confirm that the laboratory followed all method and reporting requirements, and to provide a basis for making decisions about the minimum quality of environmental data that is sufficient to support risk assessment remedial performance decisions.

4.7 Data Quality Objectives (DQOs) and Process

Data Quality Objectives (DQOs) are qualitative and quantitative statements to help ensure that data of known and appropriate quality are obtained during the project. DQOs for sampling activities are determined by evaluating the following five factors:

- Data Needs and Uses: The type of data required and how that data will be used after it is obtained.
- Parameters of Interest: The type of chemical or physical parameters required for the intended use.
- Level of Concern: Levels of constituents that may require remedial actions or further investigations.
- Required Analytical Level: The level of data quality, data precision, and QA/QC documentation required for the chemical analysis.
- Required Detection Limits: The detection limits necessary based on the above information. The quality assurance and quality control objectives for all data measurements include:
 - Precision – an expression of the reproducibility of measurements of the same parameter under a given set of conditions. Field sampling precision will be determined by analyzing duplicate samples and analytical precision will be determined by analyzing internal QC duplicates and/or matrix spike duplicates.
 - Accuracy – a measure of the degree of agreement of a measured value with the true or expected value of the quantity of concern. Analytical accuracy will be assessed by examining the percent recoveries of surrogate compounds that are added to each sample

(organic analyses only), internal standards, laboratory method blanks, instrument calibration, and the percent recoveries of matrix spike compounds added to selected samples and laboratory blanks.

- Representativeness – expresses the degree to which sample data accurately and precisely represent a characteristic of a population, parameter variations at a sampling point, or an environmental condition. Representativeness is dependent upon the adequate design of the sampling program and will be satisfied by ensuring that the scope of work is followed and that specified sampling and analysis techniques are used. Representativeness in the laboratory is ensured by compliance to nationally-recognized analytical methods, meeting sample holding times, and maintaining sample integrity while the samples are in the laboratory's possession. This is accomplished by following all applicable methods, laboratory-issued SOPs, the laboratory's Quality Assurance Manual, and this QAPP. The laboratory is required to be properly certified and accredited.
- Completeness – the percentage of measurements made which are judged to be valid. Completeness will be assessed through data validation. The QC objective for completeness is generation of valid data for at least 90 percent of the analyses requested.
- Comparability – expresses the degree of confidence with which one data set can be compared to another. The comparability of all data collected for this project will be ensured using several procedures, including standard methods for sampling and analysis as documented in the QAPP, using standard reporting units and reporting formats, and data validation.
- Sensitivity – the ability of the instrument or method to detect target analytes at the levels of interest. The project manager will select, with input from the laboratory and QA personnel, sampling and analytical procedures that achieve the required levels of detection

4.8 Reporting of Data

All data generated during the monitoring activities will be submitted in the appropriate EQUIS™ EDD format.

FIGURES

© 2023 AKRF. W:\Projects\210225 - 975 Nostrand Avenue\Technical\GIS and Graphics\SAR\210225 Figure 1 Site Location map.mxd 11/2/2022 10:32:53 AM iszalus

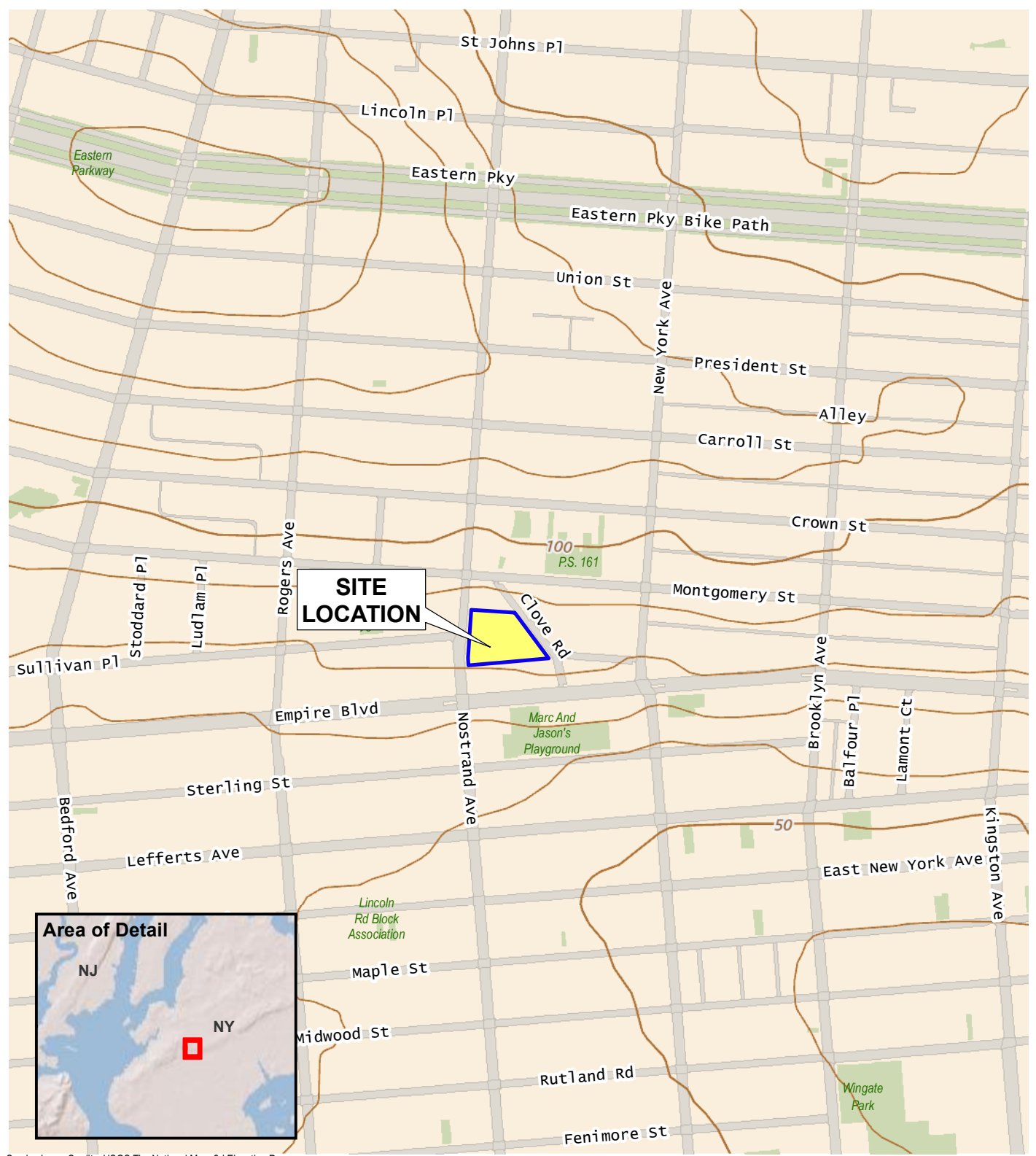

Service Layer Credits: USGS The National Map: 3d Elevation Program, Data Refreshed July, 2021

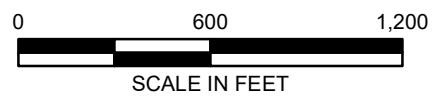

440 Park Avenue South, New York, NY 10016

975 Nostrand Avenue
Brooklyn, New York

SITE LOCATION

DATE	8/23/2023
PROJECT NO.	210225
FIGURE	1

ATTACHMENT A
RESUMES OF PROJECT DIRECTOR, PROJECT MANAGER, PROJECT MANAGER ALTERNATE, AND
FIELD TEAM LEADER

AXEL E. SCHWENDT

VICE PRESIDENT

Mr. Schwendt is a Vice President for AKRF with over 20 years of experience in the environmental consulting field. Mr. Schwendt has extensive experience in Phase II studies involving subsurface soil and groundwater investigations, and has been involved in all aspects of soil and groundwater remediation, including those related to manufactured gas plants (MGP). He has designed, managed and implemented large-scale site investigations and remedial measures for various properties, including those under different regulatory programs such as the New York State Department of Environmental Conservation's (NYSDEC) Voluntary Cleanup Program and Brownfield Cleanup Program, New York State's Spill Response Program, the Mayor's Office of Environmental Remediation (OER) E-Designation Program, New Jersey's Industrial Site Recovery Act (ISRA), and Pennsylvania's Land Recycling program. Mr. Schwendt manages the hazardous materials tasks for the company's Environmental Impact Statements (EISs) and also conducts and manages Phase I Environmental Site Assessments (ESAs) for various individual clients and industries as well as for area-wide rezoning projects.

Mr. Schwendt has extensive experience in underground and aboveground storage tank (UST and AST) management, including tank removals, installations, and upgrades. He has designed and implemented remedial investigations surrounding UST and AST releases and overseen the installation and maintenance of pump-and-treat and other remedial systems. He has performed storage tank compliance audits and maintenance inspections all across the country and prepared Spill Prevention, Control, and Countermeasures Plans (SPCC Plans) for over 100 individual facilities, including designing and conducting the personnel training programs.

Mr. Schwendt worked with several other firms prior to joining AKRF, which provided him with a variety of skills. He has expertise with Chemical Bulk Storage Spill Prevention Reports, Environmental Emergency Response Plans, Integrated Contingency Plans, and multi-phase compliance audits, including some international projects. He has also performed various types of hydrogeologic testing, including pilot tests, slug tests, pump tests and groundwater modeling, and has been responsible for data review and management.

BACKGROUND

Education

B.A., Earth Science and Environmental Studies, Tulane University, 1991

M.S., Geology, University of Delaware, 2002

Years of Experience

Year started in company: 2002

Year started in industry: 1995

RELEVANT EXPERIENCE

New York City Department of Design and Construction (NYCDDC) Feasibility and Pre-Scoping Services for East Side Coastal Resiliency, New York, NY

Mr. Schwendt assisted with the subsurface exploration program for a multidisciplinary design team selected by the New York City agency partnership of NYCDDC, New York City Department of Parks and Recreation (NYCDPR), and Office of Recovery and Resiliency (ORR) for the Feasibility Study and Pre-Scoping Services for East Side Coastal Resiliency (ESCR) project. The AKRF Team provided technical analysis and pre-scoping



AXEL E. SCHWENDT

VICE PRESIDENT

| p. 2

services, including complex conceptual design services, for 100+ year storm protection with anticipated sea level rise along the east side of Lower Manhattan. The ESCR subsurface exploration program involved a review of available utility plans and environmental reports involving manufactured gas plant (MGP) and petroleum-related contamination along a 2.5 mile study area from Montgomery Street to East 23rd Street to develop a Subsurface Investigation Work Plan for approval by the New York City Department of Environmental Protection (NYCDEP). The program included both public and private utility mark-out services across vast areas of the project containing critical infrastructure to enable the installation of 81 deep borings, 515 shallow borings, and 10 temporary groundwater wells.

New York City Health and Hospitals Corporation (NYCHHC)'s Post-Sandy mitigation program at Bellevue, Coler-Goldwater, Coney Island, and Metropolitan Hospitals

AKRF is assisting the NYCHHC in the recovery, reconstruction and hazard mitigation of Bellevue Hospital, Coler Hospital, and Coney Island Hospital and other NYCHHC facilities, which were damaged as a result of the Hurricane Sandy disaster. The majority of the funding for these projects will be reimbursed from the Federal Emergency Management Agency (FEMA). AKRF is collecting baseline information and develop study plan and approach, including assessing for critical path approvals, preparing FEMA NEPA Environmental Assessments (EAs), conducting additional studies required by Federal Regulations for FEMA, permitting, and providing design/bid support. Mr. Schwendt is responsible for the hazardous materials tasks associated with the program, including conducting Phase I ESAs and subsurface (Phase II) investigations, and preparing necessary work plans and Remedial Action Plans (RAPs)/Construction Health and Safety Plans (CHASPs) for federal, state and city agency review and approval.

NYCDEP Task Order Contracts (TOCs) for Design and Construction Management Services Professional Engineering Design Services and Construction Management (PEDS)

AKRF is currently serving as environmental review and permitting subcontractor under all four NYCDEP TOCs contracts and both PEDS contracts that were recently awarded. In addition to the preparation of environmental review/ULURP documentation and permit applications, AKRF's responsibilities include site selection support, site/civil design, and the preparation of various permit management plans and regulatory compliance tracking in accordance with DEP's Project Delivery Manual. Mr. Schwendt is providing Hazardous Materials consulting services for the TOCs and PEDS contracts, including:

- Prospect Expressway Pump Station Upgrade;
- Clearview Pump Station Reconstruction;
- Rockaway Wastewater Treatment Plant Level 1 Biological Nutrient Removal (BNR) Upgrade; and
- Oakwood Beach Wastewater Treatment Plant Headworks Improvements.

Verdopolis JFK Airport Facility, Queens, NY

On behalf of Verdopolis JFK, AKRF prepared documentation for a New York State Department of Environmental Conservation (NYSDEC) Part 360 Solid Waste Management Facility Permit application. The facility, which would be constructed at the abandoned Hangar 16 site of the John F. Kennedy International Airport (JFK Airport), would process 180,000 tons per year of source separated, pre-consumer organic waste generated largely by food preparation facilities at JFK Airport. Using an anaerobic digestion process, the proposed facility would convert the food waste, which would otherwise be discarded in a landfill or incinerated, into three usable products. Mr. Schwendt assisted in preparing the application package, including preparation of the Engineering Report, Operations and Maintenance Plan, Contingency Plan, Facility Closure Plan, Hiring and Training Plan,



AXEL E. SCHWENDT

VICE PRESIDENT

| p. 3

Chemical Bulk Storage Spill Prevention Report, and the Spill Control Prevention and Countermeasure Plan (SPCC Plan). Mr. Schwendt also prepared a Phase I Environmental Site Assessment (ESA) of the property to ascertain potential environmental conditions that may be exposed during site development activities.

2477 Third Avenue, Bronx, NY

Mr. Schwendt prepared the application to enter the former 2477 Third Avenue gasoline station property into the New York State Department of Environmental Conservation's (NYSDEC) Brownfield Cleanup Program (BCP). Since its acceptance into the program, Mr. Schwendt has been managing and coordinating the remedial investigation of the site, including shallow and deep aquifer groundwater testing, delineation of known areas of soil contamination, soil vapor analyses, and investigation for potential non-aqueous phase liquid (DNAPL) from past industrial activities in the surrounding area. Mr. Schwendt was responsible for developing work plans for approval by the NYSDEC and New York State Department of Health (NYSDOH), and for preparing summary reports for public comment. As part of the project, Mr. Schwendt coordinated with the client, lawyers, and architects of the planned development, tenants of neighboring properties, NYSDEC, NYSDOH, and the New York City Department of Environmental Protection (NYCDEP). Mr. Schwendt is also conducting the work necessary to address a hazardous materials E-Designation assigned to the property.

E-Designation Properties/Voluntary Cleanup Program, New York City, NY

Mr. Schwendt has assisted various public and private clients with addressing E-Designations assigned by the New York City Department of Environmental Protection (NYCDEP) to properties throughout New York City. He has prepared the required Phase I Environmental Site Assessments (Phase I ESAs) and implemented Phase II testing to the satisfaction of the New York Office of Environmental Remediation (OER). Based on the results of the testing, he has prepared Remedial Action Plans (RAPs) and Construction Health and Safety Plans (CHASPs) for approval by the NYCOER, which included strategies for mitigating on-site environmental conditions and plans for incorporating environmental engineering controls into proposed construction projects. Mr. Schwendt's clients promptly receive the Notice of Satisfaction necessary to acquire building permits from the New York City Department of Buildings (DOB). Mr. Schwendt has also managed several projects enrolled in the New York City Voluntary Cleanup Program.

St. George Ferry Terminal, Staten Island, NY

Mr. Schwendt prepared a Spill Prevention, Control, and Countermeasures Plan (SPCC Plan) for the Department of Transportation's (DOT) St. George Ferry Terminal facility in Staten Island. The facility's bulk containers store over 600,000-gallons of petroleum used to fuel boilers and emergency generators, provide oil for maintenance and repair of equipment and vessels, and to fuel the ferry vessels. Mr. Schwendt also consulted the DOT on how to upgrade the facility's fueling systems to comply with the SPCC and New York State Department of Environmental Conservation (NYSDEC) regulations.

Mount Sinai Medical Center, Manhattan, NY

Mr. Schwendt managed the Hazardous Materials task for the environmental assessment of the Mount Sinai Medical Center, which is constructing a 700,000 sf, mixed-use residential and bio-medical research facility building. His work included managing the Phase I Environmental Site Assessment (ESA), Phase II investigation, and preparing the Remedial Action Plan (RAP) and Construction Health and Safety Plan (CHASP) approved by the New York City Department of Environmental Protection (NYCDEP).

Lincoln Center Development Project, New York, NY

On behalf of the Lincoln Center Development Project, Inc., Mr. Schwendt conducted a Subsurface (Phase II) Investigation in the area of an underground storage tank (UST) farm located beneath the lower garage level of the West 62nd Street parking garage at Lincoln Center. The Phase II study was prompted by a request from the New York State Department of Environmental Conservation (NYSDEC) to properly close out the tanks. The tank farm includes seventeen (17) 550-gallon gasoline USTs and one (1) 550-gallon waste oil UST. The purpose of this Phase



AXEL E. SCHWENDT

VICE PRESIDENT

| p. 4

II investigation was to determine whether historic leaks from the tanks had affected the subsurface and to assist with future tank closure activities. The Phase II report was submitted to the NYSDEC for review and included a request to close the tanks in-place instead of removing them due to the structural constraints of the tank farm location. Mr. Schwendt also managed the closure of the 18 UST's to the satisfaction of the NYSDEC.

512-522 Vanderbilt Avenue, Brooklyn, NY

On behalf of the Empire State Development Corporation (ESDC), AKRF was retained to provide hazardous material consulting services in connection with the former gasoline station property located at 512-522 Vanderbilt Avenue. Mr. Schwendt performed a Phase I Environmental Site Assessment (ESA), a geophysical survey of the site, and a soil and groundwater subsurface investigation. Data from the investigation would be used to assess remedial strategies during development of the site.

Whitney Museum of American Art, Gansevoort Facility, New York, NY

AKRF has provided various consulting services in support of the Whitney Museum of American Art's long-term planning requirements. Tasks have included transportation surveys, traffic counts, attendance projections, visual impact and shadow studies, economic benefit studies, and two Environmental Assessment Statements (EASs) for proposed new facilities for the Museum. Mr. Schwendt was responsible for the hazardous materials elements of the assessment, including preparing a Phase I ESA and conducting several Subsurface (Phase II) Investigations for review by the New York City department of Environmental Protection (NYCDEP) and Mayor's Office of Environmental Remediation (OER). Mr. Schwendt prepared and managed the implementation of the OER-approved Remedial Action Plan (RAP) for the construction project and is responsible for satisfying all of the associated regulatory reporting requirements. Environmental work at the site also included mitigating a petroleum spill discovered during site excavation activities and coordinating all remedial efforts with the New York State Department of Environmental Conservation's (NYSDEC) Department of Environmental Remediation (DER).

New York Botanical Garden, Bronx, NY

The New York Botanical Garden (NYBG) proposed to construct an accessory parking garage of approximately 825 spaces at Bedford Park Boulevard and Webster Avenue in the Bronx to provide a parking garage for staff and visitors who cannot be accommodated within NYBG's on-site facilities. Mr. Schwendt was the Project Manager for the environmental assessment's hazardous materials work, which included a Phase I Environmental Site Assessment (ESA), Phase II Investigation and the preparation of a Remedial Action Plan (RAP) and a Construction Health and Safety Plan (CHASP) to the satisfaction of the New York City Department of Environmental Protection (NYCDEP). As construction proceeds, Mr. Schwendt will be responsible for managing the environmental monitoring during all subsurface work and preparing the post-construction Closure Report required by the NYCDEP in order to receive the Notice of Satisfaction necessary to obtain occupancy permits from the New York City Department of Buildings (DOB).

Roberto Clemente State Park, Bronx, NY

AKRF participated in the rehabilitation of an existing ballfield, redevelopment of the existing picnic areas, and shoreline restoration along the Harlem River at Roberto Clemente State Park. AKRF is charged with preparing the Joint Permit Application which is necessary to procure the federal, state and local permits and approvals for the shoreline redevelopment. Mr. Schwendt worked with the firm's engineering group to conduct testing to pre-characterize soil to assist with the management of soil during construction. The testing included pre-characterization of soil for on-site reuse in accordance with the New York State Department of Environmental Conservation (NYSDEC) tidal wetland permit requirements and testing for physical parameters required for landscape planning.

Long Island Power Authority (LIPA), Long Island, NY



AXEL E. SCHWENDT

VICE PRESIDENT

| p. 5

Mr. Schwendt managed the preparation of Phase I Environmental Site Assessments and Phase II Investigations, along with the Hazardous Materials chapters for Environmental Impact Statements, for properties owned or to be acquired by LIPA to identify potential sources of environmental contaminants prior to power station and power line installation.

Rose Plaza on the River, Brooklyn, NY

Mr. Schwendt conducted a Subsurface (Phase II) Investigation at the 470 Kent Avenue property located in Brooklyn, New York. The objective of the subsurface investigation was to characterize the subsurface soil and groundwater conditions and determine whether past or present on-site and/or off-site potential sources of contamination have adversely affected the site. Results of the Phase II study were also used to evaluate any potential environmental risks and/or the need for remedial action at the site prior to future development. The proposed development of the site includes the construction of approximately 665 market rate dwelling units and approximately 33,750 square feet of commercial uses. The scope of the Phase II study was based on a Phase I Environmental Site Assessment (January 2004) performed by AKRF, which identified recognized environmental conditions for the site, including the potential for soil and groundwater contamination from a historical on-site manufactured gas plant, and potential underground storage tanks. Phase II activities were conducted in accordance with AKRF's Sampling Protocol and site-specific Health and Safety Plan (HASP), which was reviewed and approved by the New York City Department of Environmental Protection (NYCDEP).

Albert Einstein College of Medicine Environmental Investigation, Bronx, NY

Mr. Schwendt managed a Subsurface (Phase II) Investigation at an approximately eight-acre portion of the Jacobi Medical Center fronting on Eastchester Road in the Bronx, New York. The site, owned by New York City, contained an old boiler house, a storage warehouse, a laundry facility, and several paved parking areas. The objective of the subsurface investigation was to characterize the subsurface conditions on the property and determine whether past or present on-site and/or off-site potential sources of contamination have adversely affected the site.

Storage Deluxe, Various Locations, NY

Mr. Schwendt is currently the project manager for assisting Storage Deluxe with the ongoing expansion of their self-storage facilities primarily in the five boroughs of New York City and Westchester County. He conducts and manages environmental due diligence needs related to their property transactions, including Phase I Environmental Site Assessments (ESAs), Phase II investigations, and geophysical surveys, as well as consulting on petroleum bulk storage tank management. He assists Storage Deluxe in making decisions with respect to environmental risk issues.

South Bronx Overall Economic Development Corporation (SoBRO) Port Morris Brownfield Opportunity Areas (BOA), Bronx, NY

Mr. Schwendt is assisting SoBRO with the in-depth and thorough analysis of existing conditions, opportunities, and reuse potential for properties located in the proposed Port Morris Brownfield Opportunity Area with an emphasis on the identification and reuse potential of strategic brownfield sites that may be catalysts for revitalization. His work so far has included the preparation of Phase I Environmental Site Assessments (ESAs) and conducting Phase II investigations for the catalyst sites and advising on the suitability of enacting zoning changes to permit various property uses. Mr. Schwendt also assisted SoBRO with the BOA application process.

Kings Plaza, LLC Total Energy Plant, Brooklyn, NY

Mr. Schwendt has conducted regular environmental compliance reviews of the Kings Plaza Total Energy Plant (TEP) in Brooklyn, New York. The reviews were conducted to observe operations and to review environmental permits, agency correspondence, operating records, recordkeeping and monitoring procedures, and regulatory reporting requirements. As a result of the review, Mr. Schwendt provided the TEP with recommendations for the



AXEL E. SCHWENDT

VICE PRESIDENT

| p. 6

management of various waste streams and petroleum/chemical bulk storage associated with facility operations and prepared a Spill Control Prevention and Countermeasure Plan (SPCC Plan) for the facility.

270 Greenwich Street, New York NY

Mr. Schwendt conducted a subsurface (Phase II) investigation that included the advancement of soil borings and the collection of soil and groundwater samples from the 270 Greenwich Street property in the Tribeca neighborhood of New York City. The site will be developed with approximately 402 dwelling units (172 rental units and 230 for sale condominiums), approximately 224,084 gross square feet of destination and local retail space, and below-grade public parking. The purpose of this Phase II subsurface investigation was to ascertain subsurface soil and groundwater quality beneath the site and determine whether past on- or off-site operations have affected the property. The subsurface investigation was also intended to determine whether there are any special handling or disposal requirements for pumped groundwater, should dewatering be necessary during site development. The Phase II study included soil and groundwater sampling as well as a geophysical investigation to determine whether unknown underground storage tanks were present at the site. Field activities were performed in accordance with Mr. Schwendt's Sampling Protocol and Health and Safety Plan (HASp), which were approved by the New York City Department of Environmental Protection (NYCDEP).

Columbia University Manhattanville Rezoning and Academic Mixed-Use Development, New York, NY

Mr. Schwendt managed the hazardous materials task on the Environmental Impact Statement (EIS) for approximately 4 million square feet of new academic, research and neighborhood uses to be constructed north of Columbia University's existing Morningside Heights campus. The work included more than 25 Phase I Environmental Site Assessments (ESAs) for the properties within the rezoning area and estimates for upcoming investigation and remediation. In addition, a Preliminary Environmental Site Assessment (PESA) was completed for the whole project area. Recognized environmental concerns in the area included: current and historical underground storage tanks; current and historical auto-related use such as repair shops and gasoline stations; two historical manufactured gas holders; and a Consolidated Edison cooling plant located on West 132nd Street. Mr. Schwendt conducted a subsurface investigation at the site to characterize the subsurface conditions on the property and determine whether past or present on-site and/or off-site potential sources of contamination have adversely affected the study site, and to use the analytical data to evaluate any potential environmental risks and/or the need for remedial action at the site prior to future development. Based on the results of the investigation, Mr. Schwendt prepared a Remedial Action Plan (RAP) and Construction Health and Safety Plan (CHASP) for the project, which was approved by the New York City Department of Environmental Protection (NYCDEP).

Hudson River Park, New York, NY

Mr. Schwendt serves as the on-call environmental consultant for the ongoing development of the Hudson River Park, the approximately 5 to 6 mile section of waterfront property from Battery Place to 59th Street along the western edge of Manhattan. He conducts subsurface investigations, coordinates tank removals, implements soil and groundwater remediations, provides guidance on construction and environmental health and safety issues, interfaces with regulatory agencies as necessary, and manages the mitigation of environmental conditions encountered during site development activities.

Brooklyn Bridge Park, Brooklyn, NY

AKRF is providing environmental planning and review services for the development of a new 70-acre park that will revitalize 1.5 miles of the East River waterfront between Jay Street and Atlantic Avenue. When completed, the park will provide open space, recreational facilities, a hotel, restaurants, and retail, historic, and educational venues. Mr. Schwendt was involved with the completion of the Environmental Impact Statement (EIS) and conducted a Phase I Environmental Site Assessment (ESA) and Phase II Subsurface Investigation for the proposed Brooklyn



AXEL E. SCHWENDT

VICE PRESIDENT

| p. 7

Bridge Park area. He serves as the park's on-call consultant for addressing environmental conditions as development progresses and has conducted several tank removals and contaminated soil delineation and remediation projects for various sections of the park.

Titan Property Management, Rego Park, NY

Mr. Schwendt was involved with an extensive site investigation for a property involved in the New York State Voluntary Cleanup Program. The property was resting on a plume of PCE contamination. The goal of the investigation was to determine whether the property is the source of the contamination and to collect data to provide information for the design and implementation of a site remedial system. The investigation involved extensive soil, soil gas, and groundwater investigation, and included the investigation of surrounding properties.

ABCO Refrigeration Company, Long Island, NY

Mr. Schwendt managed a tank closure and dry well assessment and remediation project for the ABCO Refrigeration Company. Historic contamination was found seeping from the ground in the location of an old underground storage tank, which is believed to be a source of adverse impact. An adjacent drywell was impacted by the tank as well as from past dumping activities of a former typewriter ribbon ink manufacturing company. A site-wide investigation of the ten drywells was also implemented at the request of the Nassau County Department of Health. Mr. Schwendt undertook soil remedial activities that led to the property receiving closure with respect to the underground storage tank. Drywell remedial activities were successful and the site received approval from the United States Environmental Protection Agency (USEPA) to continue use of on-site drywells.

Levin Management Corporation Property—Site Investigation, Pelham Manor, NY

Mr. Schwendt was involved in the site investigation of a former manufactured gas plant (MGP) that handled petroleum off-loading and storage until the late 1950s. Soils have also been observed to have been affected by non-aqueous phase liquid (NAPL) consisting of oil- and tar-like material. Floating or light NAPL (LNAPL) has also been detected in on-site groundwater. The objectives of the site investigation were to collect additional data to further determine the extent of NAPL-affected soil both above and below the water table throughout the site and to further delineate groundwater contamination throughout the site. The site investigation also sought to confirm the on-site groundwater flow direction and that NAPL had not migrated to the downgradient perimeter of the site, including Eastchester Creek. Mr. Schwendt was brought on board for this project for his expertise in soil and groundwater MGP contaminant delineation.

NYCDEP Bureau of Environmental Engineering 26th Ward Wastewater Treatment Plant—Site Investigation, Brooklyn, New York

Mr. Schwendt managed and conducted environmental sampling and testing at the 26th Ward Wastewater Treatment Plant property located in Brooklyn, New York. This investigation was performed to determine the presence or absence of contamination in the soil and groundwater that would affect the proposed construction of a new raw sewage pump station. Mr. Schwendt provided the 26th Ward with the protocol necessary for the special handling and disposal of the excavated soil as well as for the groundwater that would be pumped during dewatering operations.

Olnick Organization, New York, NY

AKRF was retained by the Olnick Organization to prepare and implement an Spill Prevention, Control, and Countermeasures Plan (SPCC Plan) for their aboveground storage tank system for an office building in Manhattan. Mr. Schwendt performed the site inspections and provided the Olnick Organization with a list of recommendations for upgrades to their fuel transfer piping system that would bring the facility into compliance with SPCC regulations. He also provided Olnick with a plan for implementing the required SPCC training program for their facility personnel.



AXEL E. SCHWENDT

VICE PRESIDENT

| p. 8

Site investigations of former MGP Facilities/Properties for Consolidated Edison, New York City, NY & Westchester County, NY

While with another firm, Mr. Schwendt worked on this project, which included a service station in New York City and an electrical substation in Westchester County, New York. Mr. Schwendt performed the site characterizations, including subsurface soil and groundwater impact delineation and aquifer testing. The findings from these characterizations are being used by Consolidated Edison to make appropriate changes to the design specifications and to plan for appropriate handling of impacted materials and health and safety protocols during future construction activities.

UST Site Investigation and Remediation for Consolidated Edison Service Center, Queens, NY

While with another firm, Mr. Schwendt worked on this project, which included due diligence site reviews, soil boring installation, monitoring well installation, hydrogeologic testing, and water quality sampling. Risk-based closures incorporating natural attenuation and groundwater monitoring activities have been proposed. Remedial work plans are under development for other facilities where more aggressive remedial actions are required. Mr. Schwendt also performed subsurface investigations and site characterizations for several other Consolidated Edison facilities including soil-gas surveys and a radiological scoping survey.

Petroleum Bulk Storage Management Program for Bell Atlantic-New York (now Verizon), Manhattan, Brooklyn, Queens, Bronx, Staten Island, and Long Island, NY

While with another firm, Mr. Schwendt personally designed and conducted subsurface investigations for underground storage tank (UST) remediations including characterization of releases, soil and ground water investigations, pilot tests, slug tests, pump tests, groundwater modeling, horizontal and vertical impact delineation, and preparation of compliance documentation for regulatory agencies. He performed oversight of the installation of 'pump and treat' remedial systems and performed maintenance activities. He also supervised UST installations, upgrades and closures; implemented tank tightness testing programs; addressed on-site health and safety issues and other regulatory requirements; prepared closure reports; and managed soil disposal.

Hertz Rent-A-Car Corporate Headquarters, Park Ridge, NJ

While with another firm, Mr. Schwendt served as an in-house consultant/project manager for the environmental department at Hertz's corporate office in Park Ridge, New Jersey. He managed Phase I and Phase II investigations for real estate purchases, leases and acquisitions throughout the United States and Canada. He coordinated Hertz's subcontractors and environmental consulting firms, reviewed reports, and made recommendations to the legal and real estate departments with respect to environmental risk issues.

Temple University, Philadelphia, PA

Mr. Schwendt was a lead auditor for a multi-phase compliance audit of the five campuses of Temple University. The audit included an assessment of all of the Temple University Hospitals, the School of Medicine, the College of Science and Technology, the Tyler School of Art, the College of Engineering, Ambler College (Community and Regional Planning, Horticulture, and Landscape Architecture), the Physical Plant Department, and all university facilities and maintenance departments. Regulatory programs targeted as part of the audit included, but were not limited to, federal and state air and water programs, hazardous waste management, hazardous chemicals and substances, Federal Insecticide, Fungicide, and Rodenticide Act (FIFRA) for pesticides, emergency response, Community Right-to-Know, Toxic Substance Control Act (TSCA), and petroleum bulk storage regulations. Following completion of the audit, Mr. Schwendt prepared and implemented an environmental management system that conformed to the needs and culture of the Temple University organization.

University of Pennsylvania, Philadelphia, PA



AXEL E. SCHWENDT

VICE PRESIDENT

| p. 9

Mr. Schwendt was the lead auditor for an environmental compliance audit of the University of Pennsylvania's Department of Environmental Health and Radiation Safety. The audit included an assessment for the preparation and implementation of the university's Spill Prevention, Control, and Countermeasures Plans (SPCC Plans). Mr. Schwendt prepared and implemented the university's environmental management program and provided training for the facility personnel.

Wistar Institute, Philadelphia, PA

Mr. Schwendt was the lead auditor for an environmental compliance audit of the Wistar Institute, an independent non-profit biomedical research institute in West Philadelphia, Pennsylvania. The multi-phase audit comprised an assessment of the entire facility for compliance with federal, state and local environmental regulations and included the development of an environmental management system.

Seton Hall University, South Orange, NJ

Mr. Schwendt was a lead auditor for a multi-phase compliance audit of the Seton Hall University campus. The audit comprised an assessment of the entire facility for compliance with federal and state air and water programs, hazardous waste management programs, hazardous chemicals and substances programs, the Federal Insecticide, Fungicide, and Rodenticide Act (FIFRA) for pesticides, emergency response and Community Right-to-Know regulations, the Toxic Substance Control Act (TSCA), and petroleum bulk storage regulations. The audit included the development and implementation of an environmental management system for the Seton Hall University faculty and staff.

New York City College of Technology (City Tech) Academic Building, Brooklyn, New York

Mr. Schwendt is assisting the City University of New York (CUNY) and the Dormitory Authority of the State of New York (DASNY) in addressing the E-Designation assigned to the New York City College of Technology (City Tech) redevelopment project site in Brooklyn, New York. CUNY is proposing to construct an eight-story academic building with classrooms, laboratories, administrative space, and underground parking. Mr. Schwendt conducted the required Phase I Environmental Site Assessment (ESA) and Phase II testing to the satisfaction of the Mayor's Office of Environmental Remediation (OER) and will assist CUNY with entering the project site in the City's Voluntary Cleanup Program (VCP). The work will include preparing the required Remedial Action Plan (RAP) and Construction Health and Safety Plan (CHASP) and conducting the necessary environmental monitoring during construction. Mr. Schwendt will also prepare the closure documentation required for CUNY to receive the Notice of Satisfaction necessary to obtain occupancy permits from the New York City Department of Buildings (DOB).

New York University Langone Medical Center, New York, NY

Mr. Schwendt managed the hazardous materials task on the EAS for the NYU Langone Medical Center (NYULMC) development project in Manhattan, New York. NYULMC is in the process of developing the Kimmel Program, which consists of two new buildings on its main campus: the Kimmel Pavilion to house hospital functions and an Energy Building to house a combined heat and power (CHP) plant, primary electric service and emergency generators to support the campus, as well as space for patient care (specifically, radiation oncology). The work included conducting Phase I Environmental Site Assessments and Phase II subsurface investigations at each site to characterize the subsurface environmental conditions at the project site. Based on the results of the investigations, a Remedial Action Plan (RAP) and Construction Health and Safety Plan (CHASP) were prepared for each project phase for submission to the New York City Department of Environmental Protection (NYCDEP) and Mayor's Office of Environmental Remediation (OER). Mr. Schwendt will assist NYULMC by conducting the environmental monitoring required by the agency-approved RAPs/CHASPs as construction progresses, and will prepare the closure documentation required by the agencies to obtain Certificates of Occupancy from the New York City Department of Buildings (DOB).

DASNY Term Environmental Consultant 2006-2012 and 2012-2016, Various Locations, NY



AXEL E. SCHWENDT

VICE PRESIDENT

| p. 10

Mr. Schwendt serves as a hazardous materials task leader under the firm's on-call contract with DASNY, through which AKRF is providing State Environmental Quality Review Act (SEQRA) and City Environmental Quality Review (CEQR) environmental review services for a wide range of educational, healthcare and other institutional projects, as well as specialized technical services in historic and archaeological resources, hazardous materials, traffic, air quality, noise, and natural resources. Mr. Schwendt has also assisted DASNY with addressing E-Designations and by conducting various types of environmental investigations, including Phase I and Phase II assessments.

NYCDEP Permit Resource Division On-Call Contract, New York, NY

Under subcontract to a national engineering firm, and as part of two successive Program Management contracts, AKRF is providing support in a wide range of technical areas related to environmental and engineering permits for NYCDEP capital projects. These services fall into two major categories: preparing detailed guidance documents that will be used by project designers and construction managers on future projects, in order to expedite permit approvals and prevent delays; and providing expert review and guidance regarding permits for current projects, in order to ensure completeness of permit applications and effective coordination with regulatory agencies. The technical areas covered by AKRF include: wetlands, groundwater, surface water, and other natural resources; hazardous materials; traffic and transportation; air quality; noise and vibration; historic and archaeological resources; stormwater management; open space and parkland; and a broad range of permits and approvals from the New York City Fire Department (FDNY), the New York City Police Department (NYPD), the New York City Department of Buildings (NYCDOB), and other municipal agencies. AKRF is also helping NYCDEP improve the overall process for tracking environmental and engineering permits and approvals, from the planning and design phases of a project to construction and long-term operation. Mr. Schwendt provides consulting services related to the hazardous materials issues.



REBECCA KINAL, P.E.

VICE PRESIDENT

Rebecca Kinal has over 20 years of experience in the assessment and remediation of soil and groundwater contamination and other hazardous/non-hazardous waste problems. Ms. Kinal's experience includes environmental due diligence, soil and groundwater investigations, leaking underground storage tank studies, soil gas/vapor intrusion surveys, and oversight of small- and large-scale remediation programs, including design of groundwater remediation systems and vapor mitigation systems. She has directed numerous Phase I and Phase II investigations and remediation programs, many of them in conjunction with commercial/residential developers, law firms, lending institutions, and public agencies. She is experienced in the cleanup of contaminated properties under New York State Brownfield Cleanup Program (BCP) regulations and the New York City "E-designation" program. As a part of this work, her duties have included technical and report review, proposal writing, scheduling, budgeting, and acting as liaison between clients and regulatory agencies, and project coordination with federal, state, and local authorities.

BACKGROUND

Education

M.S., Hydrogeology, Rensselaer Polytechnic Institute, 1995

B.S., Civil Engineering, Lafayette College, 1992

Licenses/Certifications

State of New York, P.E. Registration No. 082046, 2004

Years of Experience

Year started in company: 2000

Year started in industry: 1996

RELEVANT EXPERIENCE

White Plains Mall/Hamilton Green

Ms. Kinal managed environmental due diligence and remediation planning for the project, which included Phase I and II environmental assessments, a petroleum Spill investigation, preparation of remediation cost estimates, and application to the NYSDEC BCP.

New York City School Construction Authority On-Call Contracts for Environmental Consulting Services, Various Sites, NY

Ms. Kinal serves as the project manager for AKRF's on-call hazardous materials consulting contract with the New York City School Construction Authority for over 8 years. For potential new school sites, assignments include initial due diligence, Phase I environmental site assessments, (ESAs) and subsurface investigation of soil, groundwater, and soil vapor to determine the suitability of a site for development as a school, likely remediation requirements, and associated costs. For sites undergoing design and development, assignments include preparation of remediation plan, contract specifications, and design drawings. The work has also included conducting indoor air quality testing, vapor intrusion assessments, preparation of specifications, supervision of storage tank removals, and investigation and remediation of spills for existing schools. Due to the sensitivity of school sites, work under this contract is often conducted on short notice and during non-school hours.



REBECCA KINAL, P.E.

**VICE PRESIDENT-ENVIRONMENTAL
ENGINEER** | p. 2

USTA National Tennis Center, Queens, NY

AKRF prepared an EIS for the New York City Departments of City Planning (DCP) and Environmental Protection (DEP) as co-lead agencies to analyze the expansion of the National Tennis Center, which includes multiple improvements and construction projects at the USTA campus over several years. As part of the EIS requirements, AKRF prepared a Remedial Action Plan for implementation during the proposed project's construction. In accordance with the RAP, vapor mitigation systems were incorporated into the design for several of the proposed structures at the facility, including two new stadiums, a new transportation center, and several practice court facilities. Ms. Kinal prepared the specifications and design drawings for the vapor mitigation and is providing on-going construction support to review contractor submittals and inspect the vapor barrier and sub-slab depressurization system installations.

Montefiore Medical Center, Various Locations, NY

Ms. Kinal provides due diligence assistance to Montefiore Medical Center (MMC) for the ongoing expansion of their facilities, primarily in the Bronx and Westchester County. She conducts and manages environmental due diligence tasks related to their property transactions, including Phase I Environmental Site Assessments (ESAs), Phase II investigations, and geophysical surveys. She also assists MMC in making decisions with respect to environmental risk issues.

Queens West Development Project, Long Island City, NY

For over 20 years, AKRF has played a key role in advancing the Queens West development, which promises to transform an underused industrial waterfront property into one of largest and most vibrant mixed-use communities just across the East River from the United Nations. AKRF has prepared an Environmental Impact Statement that examines issues pertaining to air quality, land use and community character, economic impacts, historic and archaeological resources, and infrastructure. As part of the project, AKRF also undertook the largest remediation ventures completed to date under the NYSDEC Brownfields Cleanup Program (BCP). Ms. Kinal helped prepare the Remedial Work Plan (RWP) and oversaw the remediation of Parcel 9, a 1.8-acre former industrial site. Remediation includes installation of a sheet pile containment wall, excavation of coal tar- and petroleum-contaminated soil under a temporary structure to control odors during remediation, vapor mitigation for the future buildings, and institutional controls. Upon completion of the remediation activities, Ms. Kinal managed the preparation of a Final Engineering Report (FER) to document the clean-up activities. The NYSDEC issued a Certificate of Completion (COC) for the Parcel 9 site in December 2006. Ms. Kinal continues to oversee post-remediation monitoring and site management activities to ensure that the remedy remains in-place and effective.

Roosevelt Union Free School District, Roosevelt, NY

Ms. Kinal managed environmental investigation and remediation activities for the sites of three new elementary schools and a new middle school in Roosevelt, New York. Remediation activities include removal/closure of contaminated dry wells and underground petroleum storage tanks, and excavation and off-site disposal of petroleum- and pesticide-contaminated soil. Remediation of the new middle school site, which also included a sub-slab depressurization system, was conducted through coordination with the NYSDEC, NYSDOH, New York State Education Department (NYSED), and the local school district. Upon completion of the remediation and school construction, Ms. Kinal managed confirmatory indoor air testing and preparation of a Final Engineering Report to document the site clean-up. The NYSDEC issued a Certificate of Completion and the school was open for the Fall 2008 semester as planned.

Proposed NYC Public School Campus, Bronx, NY

Ms. Kinal provided environmental consulting services to the selected environmental remediation contractor for this former manufactured gas plant in the Mott Haven neighborhood of the Bronx, which was remediated under the NYSDEC BCP. These services included: preparation of an in situ sampling plan and excavation plan for waste



REBECCA KINAL, P.E.

**VICE PRESIDENT-ENVIRONMENTAL
ENGINEER** | p. 3

characterization and disposal; supervision of waste characterization sampling activities; development and implementation of a community air monitoring program during all remediation activities; and daily reporting to the NYC School Construction Authority.

National Grid – Halesite Manufactured Gas Plant Site, Town of Huntington, NY

Ms. Kinal served as the project manager for the remedial design and engineering work associated with remediation of National Grid's former manufactured gas plant (MGP) located in the Town of Huntington. The site is situated in a sensitive location along the waterfront, surround by commercial and residential properties, and half the property where the remediation was conducted is a steep slope. The remedy consisted of soil removal, oxygen injection, and non-aqueous phase liquid recovery. Ms. Kinal developed the remedial work plans, design/construction documents, and managed environmental oversight of the remedial work, including waste characterization and tracking, confirmatory endpoint sampling, air monitoring, and reporting to the NYSDEC. After the remediation work was completed, Ms. Kinal prepared appropriate close-out documentation in accordance with NYSDEC requirements.

Shell Service Station, Millwood, NY

Ms. Kinal planned and oversaw a Phase I Environmental Site Assessment and Phase II Subsurface Investigation of this active gasoline station in northern Westchester County. The Phase I/Phase II investigations were performed for the potential buyer of the property who wished to redevelop it with a more modern service station and convenience store. Ms. Kinal also prepared a conceptual remediation plan to address several areas of petroleum contamination identified during the Phase II. The plan, which was approved by NYSDEC, will be implemented in conjunction with the site redevelopment activities to achieve closure for several spills reported at the site.

Pelham Plaza Shopping Center Site Investigation & Remediation, Pelham Manor, NY

Ms. Kinal managed a Site Investigation at Pelham Plaza, an approximately ten-acre site that formerly contained a manufactured gas plant. The site was investigated under a voluntary clean-up agreement entered into with the NYSDEC by the site owner. The site investigation included advancing over 100 soil borings with continuous soil sampling to bedrock, installing monitoring and recovery wells, and conducting test pitting both indoor and outdoor locations to collect soil and groundwater samples and determine the extent of Non-Aqueous Phase Liquid (NAPL). The investigation also included: soil gas sampling to determine contaminant concentrations in the vapors beneath the foundation of an on-site retail store; sediment sampling in an adjacent creek to identify off-site impacts; and a tidal survey to determine tidal influence on groundwater levels at the site. Ms. Kinal also oversaw interim remedial measures, which include biweekly pumping of recovery wells to remove dense NAPL (DNAPL) from the site subsurface.

Shaws Supermarket Redevelopment Project, New Fairfield, CT

Ms. Kinal managed the Remedial Investigation (RI) for an approximately nine-acre shopping center site that was contaminated by releases from former dry cleaning operations. The site was being redeveloped with a new supermarket and separate retail stores. The investigation included the installation of monitoring wells in the intermediate overburden aquifer and bedrock aquifer, sampling of existing and newly installed wells, geophysical logging in bedrock wells, and pump testing in intermediate and bedrock wells. Ms. Kinal prepared a Remedial Action Work Plan (RAWP) based on results from the RI, which included a groundwater pump and treat system to contain a plume of perchlorethylene (PCE)-contaminated groundwater, and excavation and disposal of contaminated soil in the presumed source area. Following CTDEP approval of the RAWP, Ms. Kinal prepared bid specifications for soil excavation and remediation system installation, and oversaw their implementation. Ms. Kinal also prepared NPDES permit applications for discharges from construction dewatering and the groundwater remediation system, and conducted associated discharge monitoring.



REBECCA KINAL, P.E.

**VICE PRESIDENT-ENVIRONMENTAL
ENGINEER** | p. 4

Yankee Stadium, Bronx, NY

Ms. Kinal performed the hazardous materials analysis for the Draft Environmental Impact Statement for the proposed new Yankee Stadium. The analysis included a Phase I Environmental Site Assessment of the entire project area and Subsurface (Phase II) Investigation in areas where environmental conditions were identified. The Phase II investigation included geophysical surveys to search for potential underground storage tanks; and soil, soil gas, and groundwater sampling at over 40 locations to determine potential environmental impacts during and after the proposed construction. Ms. Kinal also developed an extensive community air monitoring plan and oversaw its implementation during deconstruction of the old Yankee Stadium.

Avalon on the Sound, New Rochelle, NY

Ms. Kinal oversaw environmental investigation and soil remediation during the construction of two luxury high-rise apartment buildings and an associated parking garage. Investigation activities included an electromagnetic survey to search for possible underground storage tanks, and subsurface sampling to characterize soil and groundwater. Remediation activities included removing underground storage tanks, excavating and disposing of soil contaminated with volatile and semi-volatile organic compounds, and collecting end-of-excavation confirmation samples.

Dauids Island Environmental Audit, New Rochelle, NY

Ms. Kinal managed the hazardous materials portion of the audit of this undeveloped island site, including a Phase I Environmental Site Assessment (ESA) and Subsurface (Phase II) Investigation in areas where environmental conditions were identified. The Phase II investigation included collecting soil samples from more than 100 locations and analyzing them for targeted compounds, including volatile organic compounds, semi-volatile compounds, metals, pesticides, and polychlorinated biphenyls (PCBs). Ms. Kinal also oversaw an electromagnetic (EM) survey conducted to identify the location of suspected underground storage tanks on the island. Based on soil sample results, Ms. Kinal estimated the volume of contaminated soil requiring remediation and prepared cost estimates for soil excavation and for transportation and disposal of contaminated soil and hazardous materials.

Outlet City Site Investigation, Queens, NY

Ms. Kinal prepared a work plan for remedial investigation of the Outlet City site, a property in Long Island City that was formerly occupied by a manufacturer of industrial cleaners and pharmaceuticals. The site is being investigated and remediated under the NYSDEC voluntary clean-up program. In preparing the work plan, Ms. Kinal evaluated results from several previous investigations and conducted a limited groundwater sampling program to determine future data needs for designing remediation of creosote-contaminated soil and groundwater. The work plan included additional soil and groundwater sampling, a tidal survey to determine tidal influence on groundwater levels, and pilot free product recovery testing. Ms. Kinal also helped design a venting system for an on-site basement and performed exposure calculations for the vented vapors.

Yonkers Waterfront Redevelopment Project, Yonkers, NY

For this redevelopment along Yonkers' Hudson River waterfront, Ms. Kinal supervised the remediation of Parcels H and I that were contaminated with hazardous soil. During the remediation process, she reviewed the subcontractor health and safety plans, delineated the areas of excavation, and oversaw field activities to ensure compliance with the specifications and appropriate regulations. This property was remediated under the NYSDEC Environmental Restoration Program (ERP).



Ashutosh Sharma

Vice President

Ashutosh Sharma is a Vice President with over 15 years of experience in the environmental consulting field. He has managed and implemented investigations and remedial measures for various properties, including those under different regulatory programs such as the New York State Department of Environmental Conservation's (NYSDEC) Voluntary Cleanup Program and Brownfield Cleanup Program, New York State's Spill Response Program, the Mayor's Office of Environmental Remediation (OER) E-Designation Program. Mr. Sharma has extensive experience in Phase I and Phase II (subsurface) site assessment and remedial investigation, remediation and cleanup of contaminated sites, and construction oversight. He has experience with subsurface soil, groundwater and sub-slab air/vapor sampling procedures, coordinating and running Community Air Monitoring Plans (CAMP) and is familiar with relevant United States Environmental Protection Agency (USEPA), New York State Department of Environmental Conservation (NYSDEC), and New York City Department of Environmental Protection (NYCDEP) environmental laws and regulations.

Background

Education

M.S., Environmental Science, New Jersey Institute of Technology, 2007

B.Tech, Dr. B.R. Ambedkar National Institute of Technology, India, 2005

Years of Experience

Year started in industry: 2007

Year started in company: 2007

Relevant Experience

New York City School Construction Authority: On Call Environmental Consulting

Under an on-call contract, AKRF provides the New York City School Construction Authority (NYCSCA) with hazardous materials consulting services. Mr. Sharma has provided assistance with various environmental assessment tasks including Phase II (Subsurface) Environmental Site Investigations (soil, groundwater and soil gas investigations); Indoor Air Quality (IAQ) and Vapor Intrusion (VI) Assessments; and Underground Storage Tank (UST) investigations. He evaluates the results of the investigations in the context of applicable environmental regulations to assist the project manager and/or project engineer in developing recommendations for remedial actions. Mr. Sharma also provided assistance with the lead in drinking water and plumbing disinfection tasks under the current on-call contract. AKRF also oversees plumbing disinfection work, which is required prior to new plumbing being placed into service. The assignments involve reviewing and commenting on disinfection plans, supervision of the disinfection and confirmation testing, and preparation of reports documenting the work was conducted in accordance with the specifications and applicable requirements. Due to the sensitivity of school sites, work under this contract is often conducted on short notice and during non-school hours.

RXR Realty, NY: Multiple Projects

AKRF has worked with RXR Realty on multiple projects and provided services for completion of Phase I Environmental Site Assessments (ESAs), implemented Phase II Environmental Site Investigations (ESI) and soil waste characterization sampling. Mr. Sharma acted as project manager, overseeing field personnel

implementing the Phase I ESA site reconnaissance the subsurface investigations, as well as completing reports for delivery to the client.

Larkin Plaza, Yonkers, NY

RXR SoYo Exalta LLC enrolled in the New York State Brownfield Cleanup Program (NYS BCP) to investigate and remediate the property located at 25 Warburton Avenue in Yonkers, NY. Mr. Sharma assisted the client in preparing the application to enroll the site in the NYS BCP program.. Mr. Sharma acted as the project manager for the project and prepared the Remedial Investigation Work Plan (RIWP), the Remedial Investigation Report (RIR), the Interim Remedial Measure Work Plan (IRMWP), the Remedial Action Work Plan (RAWP), the Interim Remedial Measures Construction Completion Report and the Site Management Plan (SMP) for the BCP site. Mr. Sharma also managed the field implementation of the remedial investigation and site cleanup activities during the development. Mr. Sharma maintained constant communication with the NYS Department of Environmental Conservation (NYSDEC) project manager and the client during the site redevelopment.

810 Fulton Street, Brooklyn, NY

RXR 810 Fulton Owner LLC developed the property located at 810 Fulton Street in Brooklyn. Mr. Sharma acted as project manager, overseeing field personnel implementing the requirements of the NYC Office of Environmental Remediation (OER)-approved Remedial Action Plan (RAP). Mr. Sharma also coordinated with the OER on behalf of the client on the day to day activities during the remedial action. Mr. Sharma also completed reports for delivery to the client and OER.

Lambert Houses, Bronx, NY

988 East 180th Street Housing Development Fund Corporation enrolled in the New York City Voluntary Cleanup Program (NYC VCP) to investigate and remediate the property located at 988 East 180th Street in the Bronx. Mr. Sharma acted as the deputy project manager overseeing field personnel implementing the construction oversight during site redevelopment, and coordinated with the client and their subcontractors. Mr. Sharma prepared the spill investigation work plan, coordinated spill cleanup and prepared the spill closure report to address the petroleum spill encountered during site redevelopment.

Melrose Commons Site C, Bronx, NY

The Bridge Inc. enrolled in the New York City Voluntary Cleanup Program (NYC VCP) to investigate and remediate the property located at 988 East 18th Street in the Bronx. Mr. Sharma acted as the deputy project manager overseeing field personnel implementing the construction oversight during site redevelopment, and coordinated with the client and their subcontractors. Mr. Sharma prepared the remedial closure report for delivery to the client.

Essex Crossing Sites 1, 2, 3, 4, 5, 6, and 8, Manhattan, NY

AKRF provided various services during the redevelopment of the Essex Crossing sites in the lower east of Manhattan. Mr. Sharma acted as the deputy project manager overseeing field personnel implementing the construction oversight during site redevelopment, and coordinated with the client and their subcontractors. Mr. Sharma also coordinated spill cleanups and prepared the spill closure reports to address the multiple petroleum spills encountered during redevelopment. Mr. Sharma also coordinated with the client and the New York City Department of Housing & Preservation (HPD) during the implementation of the NYC Department of Environmental Protection (DEP)-approved Remedial Action Plan (RAP). Mr. Sharma also completed reports for delivery to the client.

NYU Langone Medical Center (NYULMC) – Kimmel Pavilion, New York, NY

New York University Langone Medical Center enrolled in the New York City Voluntary Cleanup Program (NYC VCP) to investigate and remediate the property located at 424 East 34th Street in Manhattan. The proposed development consisted of a new medical facility. Mr. Sharma acted as the deputy project manager overseeing field personnel implementing the construction oversight during site redevelopment, and coordinated with the client and their subcontractors.

551 Tenth Avenue, New York, NY

Extell 4110 LLC enrolled in the New York City Voluntary Cleanup Program (NYC VCP) to investigate and remediate the property located at 547-551 Tenth Avenue in Manhattan. The property was developed with a 52-story residential building with one sub-grade level. Mr. Sharma provided construction oversight during site excavation, spill remediation, coordination and management of soil removal and fill material imports, oversight of the on-site air monitoring program, identification and proper management of contamination encountered during excavation work, and maintenance of critical paperwork and preparation of the final closure report.

Zerega Avenue – Phase I, Phase II and Wetland Survey, Bronx, NY

AKRF was contracted by EDC to conduct perform environmental services at an approximately 255,000-square foot project area located at 530 to 590 Zerega Avenue, Bronx, New York. The work included a Phase I Environmental Site Assessment (ESA), and Phase II Environmental Site Investigation which included preparation of a site-specific health and safety plan, a geophysical survey and utility mark-outs, and the collection and analysis of soil, groundwater, soil vapor, indoor air and ambient air samples. Mr. Sharma provided assistance with subsurface soil, groundwater and soil gas investigation as part of the Phase II investigation of the project site.

Rego Park Home Depot, Queens, NY

Solvent contamination was encountered during retail development of a former industrial property in Rego Park, Queens, New York. The site work included an extensive investigation and a multi-phase remediation performed under the NYSDEC Voluntary Cleanup Program (BCP). Remediation included removal of aboveground and underground storage tanks (ASTs and USTs) and hotspot soil removal. An Air Sparging/Soil Vapor Extraction (AS/SVE) groundwater remediation system designed by AKRF was installed as part of the building construction. Continued remediation work included upgrading and expanding the AS/SVE system after the store was opened. AKRF prepared the Final Engineering Report and obtained closure with a Release and Covenant Not to Sue issued by NYSDEC in 2013. AKRF continues operations, maintenance, and monitoring under the NYSDEC-approved Site Management Plan. Mr. Sharma assisted with ongoing operation, maintenance and monitoring of the AS/SVE system.

TF Cornerstone – 606 West 57th Street, New York, NY

AKRF has been retained by TF Cornerstone to provide environmental services for the proposed redevelopment of a portion of the block bounded by Eleventh and Twelfth Avenues and West 56th and 57th Streets. The proposed actions include a zoning map amendment, zoning text amendments, a special permit, and an authorization to facilitate development of approximately 1.2 million square feet of residential and retail space. AKRF is currently preparing an Environmental Impact Statement (EIS) for the New York City Department of City Planning (DCP) to analyze the effects of the proposed actions and development of the proposed building. The EIS will address the full range of environmental impacts associated with the proposed development. As part of the project's review, AKRF also prepared documents and graphics submitted to DCP under its Blue Print program, a pre-application process that presents basic project information to DCP and clarifies major issues prior to the filing of a land use- or zoning-related application. The process is intended to standardize the pre-application process and expedite DCP's overall project review. Mr. Sharma also provided contractor oversight for the spill remediation activities as requested by the NYSDEC.

Whitney Museum of American Art, NY

Mr. Sharma provided assistance with subsurface soil and groundwater investigation, construction oversight and soil disposal management during the remediation phase of the project. The project included the construction of an approximately 230,000-square foot museum building with one sub-grade level with exhibition galleries, administrative offices, accessory use (café and bookstore), storage space, and an approximately 4,000-square foot restaurant.

Yankee Stadium Demolition, Bronx, NY

The New York City Economic Development Corporation (NYCEDC) project included demolition of the old Yankee Stadium and construction of a ball field known as Heritage Field. Mr. Sharma provided air monitoring and remedial action plan (RAP) oversight during the demolition and soil disturbance work.

East River Science Park, New York, NY

The New York City Economic Development Corporation (NYCEDC) proposed to construct two seventeen-story buildings to serve as a biomedical research center. The space between the two towers included an elevated atrium and an outdoor plaza on top of a parking garage. Mr. Sharma provided construction oversight during site excavation, coordination and management of soil removal and fill material imports, oversight of the on-site air monitoring program, identification and proper management of contamination encountered during excavation work, and maintenance of critical paperwork and preparation of the final closure report.

W 61st Street Site, NY

Mr. Sharma provided assistance with construction oversight during site excavation activities and helped prepare the final closure report for the site which, as part of the Brownfield Cleanup Program (BCP), was slated for redevelopment as two residential buildings with a courtyard and a tennis court.

164 Kent Avenue, Brooklyn, NY

The project was a multi-phase development consisting of a large waterfront block in the Williamsburg Rezoning Area. The project site has been developed with a mixed-use residential-commercial high rise towers with an esplanade and a pier along the East River. AKRF provided acquisition and development support, including performing Phase I and II environmental site assessments, and preparation of Remedial Action Plans (RAPs) and Construction Health and Safety Plan (CHASPs) for approval by DEP and OER. AKRF provided assistance with construction oversight during soil handling activities and managing the Community Air Monitoring Plan (CAMP) activities. To date, closure reports have been prepared and occupancy achieved for three of the four buildings. Mr. Sharma provided construction oversight during soil handling activities and running the Community Air Monitoring Plan (CAMP).

285 Jay Street, Brooklyn, NY

Under contract with the Dormitory Authority of the State New York (DASNY), AKRF completed a Phase II Subsurface investigation at the site of a proposed CUNY educational building to satisfy New York City E-designation requirements. As part of the work AKRF performed at the site, Mr. Sharma conducted sub-surface soil and groundwater investigation work and coordinated with the driller and the property owner for successful completion of the work. Mr. Sharma prepared the remedial closure report for delivery to the client.

MTA Long Island Railroad, East Side Access Project, New York, NY

The Metropolitan Transportation Authority (MTA) sponsored the East Side Access project to connect the Long Island Railroad to the Grand Central Terminal, thereby allowing Long Island commuters direct access to the East Side of Manhattan. Mr. Sharma provided assistance with the execution of the Community Air Monitoring Plan (CAMP) at various locations during the construction phase.

Adam Clayton Powell Jr. Boulevard, New York, NY

AKRF performed a Phase II study to meet the requirements of the New York City Department of Environmental Protection (NYCDEP) and to determine whether subsurface conditions had been affected by the on-site and/or off-site petroleum storage tanks and to ascertain whether current or former on- or off-site activities had adversely affected the subject property. Mr. Sharma conducted sub-surface soil and groundwater investigation at the abandoned site slated for future development. He was responsible for coordinating with the driller and the property owner for successful completion of the work.

STEPHEN SCHMID

ENVIRONMENTAL SCIENTIST

Stephen Schmid is an Environmental Scientist in AKRF's Hazardous Materials Department with five years of experience. He has experience in Phase I and II site assessments, asbestos surveying and monitoring, and construction/remediation. Mr. Schmid is a 2011 graduate from the University of New Hampshire, where he studied marine and freshwater biology, and environmental conservation. Prior to joining AKRF Mr. Schmid conducted fieldwork, water sampling and analysis in addition to assisting in a study of lakes in the North Eastern United States.

BACKGROUND

Education

BS Marine & Freshwater Biology, University of New Hampshire, Durham, NH

Licenses/Certifications

40 Hour OSHA HAZWOPER

10 Hour OSHA Construction Health and Safety

NYS DEC Erosion and Sediment Control Certificate

Asbestos Project Monitor, Air Sampling Technician, Inspector and Investigator

Years of Experience

Year started in company: 2012

Year started in industry: 2011

RELEVANT EXPERIENCE

Willets Point, Queens, NY

AKRF supported the New York City Economic Development Corporation (EDC) with Phase 1 of the Willets Point Redevelopment Plan, which includes the demolition of existing structures. Mr. Schmid performed pre-demolition asbestos-containing materials and universal waste surveys of approximately 70 structures throughout the 23-acre area site in Queens along with an AKRF licensed NYC asbestos investigator.

Adelaar, Monticello, NY

The project is a multi-phase development consisting of approximately 1,700 acres. The project site has been developed with a mixed-use residential-commercial hotel, casino, water park and entertainment village. AKRF provided acquisition and development support, including performing Phase I and II environmental site assessments. Mr. Schmid provided assistance with Phase I assessments, oversight during remedial soil handling activities and conducted inspections in accordance with the Stormwater Pollution and Prevention Plans.

NYCHA Randolph Houses, W 114th Street, Harlem, NY

AKRF was directed to survey 14 five story affordable housing apartment buildings for potential asbestos containing materials prior to the renovation of the buildings. Mr. Schmid along with AKRF licensed NYC asbestos investigators performed the collection of bulk samples throughout the building's main floors, basements and roofs to confirm the presence of asbestos in some of the building materials.



STEPHEN SCHMID

ENVIRONMENTAL SCIENTIST | p. 2

25 Broad Street, Manhattan, NY

AKRF was contracted by LCOR during the demolition of a residential building on a property which will eventually be redeveloped. AKRF was responsible for creating and implementing a community air monitoring program during demolition activities. As the environmental scientist Mr. Schmid was the on-site monitor responsible for calibrating equipment and monitoring levels of volatile organic compounds and particulate matter for the surrounding area and construction personnel. Reports of the daily activity including data collected throughout the day were prepared for submittal to the client.

Kent Avenue, Brooklyn, NY (AKA Northside Piers and 1 North 4th Place)

The project was a multi-phase development consisting of a waterfront block in the Williamsburg Rezoning Area. The project site has been developed with a mixed-use residential-commercial high rise towers with an esplanade and a pier along the East River. AKRF provided acquisition and development support, including performing Phase I and II environmental site assessments, and preparation of Remedial Action Plans (RAPs) and Construction Health and Safety Plan (CHASPs) for approval by DEP and OER. As the environmental scientist Mr. Schmid provided assistance with construction oversight during soil handling activities and managing the Community Air Monitoring Plan (CAMP) activities.

250 North 10th Street, LLC., Residential Redevelopment Site, Brooklyn, NY

AKRF was retained to investigate and remediate this former industrial property in the Williamsburg section of Brooklyn, New York in connection with site redevelopment. The site is approximately 50,000 square feet, and redevelopment included a six story residential building and parking garage. The work was completed to satisfy the requirements of the NYC E-designation Program and NYC Voluntary Cleanup Program (NYC VCP). AKRF completed a Remedial Investigation (RI) to evaluate the nature and extent of site contamination, and developed a Remedial Action Work Plan (RAWP) to properly address site contamination during redevelopment. Remediation included removal of underground storage tanks, more than 7,500 tons of contaminated soil, and installation of a vapor barrier and site cap across the entire property. The remediation was completed under oversight of the NYC Office of Environmental Remediation (OER), and in a manner that has rendered the Site protective of public health and the environment consistent with residential use of the property. As the environmental scientist Mr. Schmid conducted construction oversight and community air monitoring during the removal of contaminated soil.

Pier 40, 353 West Street, New York, NY

AKRF was directed to survey the property for potential asbestos containing materials prior to renovations and upgrades to multiple rooms. As the environmental scientist Mr. Schmid collected bulk samples to test for asbestos along with an AKRF licensed NYC asbestos investigator. Results confirmed the presence of asbestos in some of the rooms and Mr. Schmid subsequently provided project monitoring and the collection of air samples during the abatement.

137-44 94th Avenue, Queens, NY

AKRF was contracted to survey the building for potential asbestos containing materials prior to demolition. As the environmental scientist Mr. Schmid collected bulk samples to test for asbestos along with an AKRF licensed NYC asbestos investigator. Results confirmed the presence of asbestos in an office, trailer and the roof. During abatement Mr. Schmid served as the project monitor and collected daily air samples.

The Home Depot, Rego Park, NY

AKRF has designed, installed and performed upgrades to an air sparging and soil vapor extraction system being used to remediate tetrachloroethene contamination at this site under the NYSDEC Voluntary Cleanup Program. As the environmental scientist Mr. Schmid has performed low flow, indoor air and effluent sampling as part of ongoing monitoring activities to assess the progress of the cleanup.



STEPHEN SCHMID

ENVIRONMENTAL SCIENTIST | p. 3

AP-Williamsburg, LLC, 50 North 5th Street Development, Brooklyn, NY

AKRF directed the remedial program at a 55,000-square foot site located in the Williamsburg section of Brooklyn, New York. The site had an industrial and manufacturing history for over 100 years that included a barrel making factory, use of kilns, and a carpet and flooring materials warehouse. AKRF completed a Remedial Investigation (RI) to evaluate the nature and extent of site contamination, and developed a Remedial Action Work Plan (RAWP) to properly address site contamination during redevelopment. Remediation included removal of more than 5,000 tons of contaminated soil, and installation of a vapor barrier and sub-slab depressurization system (SSDS) beneath the site building. The remediation was completed in a manner that has rendered the Site protective of public health and the environment consistent with commercial and residential use of the property, and in accordance with the requirements of the NYC OER E-designation program. The site includes a seven story residential apartment building with street level retail space and a parking garage. As the environmental scientist Mr. Schmid provided oversight and community air monitoring during construction activities.

Gedney Way Leaf and Yard Waste Composting Facility, White Plains, NY

AKRF directed the remediation and landfill closure project at the existing composting facility. The project included investigation to document disposal history, extent of landfill materials and a solvent plume, preparation of a landfill closure plan, and management of landfill closure and cap construction. The landfill investigation and closure activities were completed to satisfy the requirements of a New York State Department of Environmental Conservation's (NYSDEC) consent order, and were completed in compliance with NYSDEC DER-10 and 6NYCRR Part 360. As the environmental scientist Mr. Schmid performed construction oversight and low-flow groundwater sampling during construction activities.

443 Greenwich Street, New York, NY

AKRF was retained to investigate and remediate this property in the Tribeca section of Manhattan, New York in connection with site redevelopment for a multi-story residential building. AKRF completed a Remedial Investigation (RI) to evaluate the nature and extent of site contamination, and developed a Remedial Action Work Plan (RAWP) to properly address site contamination during redevelopment. Remediation included removal of contaminated soil and installation of a vapor barrier. The remediation was completed under oversight of the NYC Office of Environmental Remediation (OER), and in a manner that has rendered the Site protective of public health and the environment consistent with residential use of the property. As the environmental scientist Mr. Schmid conducted construction oversight and community air monitoring during the removal of contaminated soil.

606 W 57th Street, New York, NY

AKRF was retained to investigate and remediate this property in Manhattan, New York in connection with site redevelopment for a multi-story residential structure. The work is being completed to satisfy the requirements of the NYC E-designation Program. AKRF completed a Remedial Investigation (RI) to evaluate the nature and extent of site contamination, and developed a Remedial Action Work Plan (RAWP) to properly address site contamination during redevelopment. Remediation includes removal of underground storage tanks and contaminated soil. The remediation is being completed under oversight of the NYC Office of Environmental Remediation (OER), and in a manner that has rendered the Site protective of public health and the environment consistent with residential use of the property. As the environmental scientist Mr. Schmid conducted construction oversight and community air monitoring during the removal of contaminated soil.

NYCEDC Office of Environmental Remediation (OER) On-Call Environmental Consulting Services

Second Farms, Bronx, NY

AKRF, Inc. was contracted by OER to conduct a subsurface investigation of a 1.12-acre parcel in the Bronx, New York under the United States Environmental Protection Agency (USEPA) Brownfield Assessment Grant program.



STEPHEN SCHMID

ENVIRONMENTAL SCIENTIST | p. 4

As the environmental scientist Mr. Schmid assisted in the investigation which included a geophysical survey and utility mark-outs, and the collection and analysis of soil, groundwater, soil vapor, indoor air and ambient air samples.

Former Nelson Foundry, Long Island City, NY

AKRF, Inc. was contracted by OER to conduct a subsurface investigation around the perimeter of a former foundry property in Long Island City, New York under the USEPA Brownfield Assessment Grant program. The work included preparation of a rigorous investigation work plan, Quality Assurance Project Plan, and Health and Safety Plan. The investigation will include a geophysical survey and utility mark-outs and the collection and analysis of soil, groundwater, soil vapor, and ambient air samples. The project also requires careful coordination of investigation-derived waste due to lack of on-site storage and daily drum pick-ups. As the environmental scientist Mr. Schmid conducted low flow sampling for the analysis of groundwater.

BRIAN QUINN

ENVIRONMENTAL PROFESSIONAL I – SITE ASSESSMENT AND REMEDIATION

Brian Quinn is an Environmental Professional I in AKRF's Site Assessment and Remediation group, with experience in environmental sampling and monitoring during site remediation, subsurface and vapor intrusion investigations, and groundwater remediation system operation and maintenance.

BACKGROUND

Role in Project

Field Technician

EDUCATION

B.A. Environmental Studies, Bucknell University, May 2020

CERTIFICATIONS

OSHA 40-hour Hazardous Waste Operations and Emergency Response Training

OSHA 30-hour Construction Safety Training

YEARS OF EXPERIENCE

Date started at AKRF: March 2022

Prior industry experience: Greenstar Environmental Solutions: February 2021- February 2022 (1 year)

RELEVANT EXPERIENCE - AKRF

Construction Oversight and Community Air Monitoring – American Museum of Natural History, Manhattan, New York

AKRF prepared and is implementing a NYCDEP-approved RAP during construction of the new Gilder Center for Science, Education, and Innovation at the AMNH. Mr. Quinn serves as an on-site environmental monitor during construction to ensure compliance with the RAP. His duties include community and work zone air monitoring, overseeing excavation and export of contaminated soil, and documenting the import of environmentally clean backfill.

RELEVANT EXPERIENCE – GREENSTAR ENVIRONMENTAL SOLUTIONS, SOMERSET, NJ

As an Environmental Scientist at Greenstar, Mr. Quinn conducted Phase II subsurface investigations, low-flow groundwater sampling and soil vapor intrusion assessments, and prepared associated technical reports. He also conducted routine O&M of a large groundwater treatment system, and oversaw installation of new extraction wells for system upgrades

Carl Armbruster
QA Manager

Qualifications Summary

Mr. Armbruster has over 30 years of experience in the environmental laboratory and engineering industry that includes extensive technical, management/leadership experience in all aspects of the laboratory business. He is an action-oriented manager dedicated to ensuring the laboratory maintains a quality program that holds the highest credentials in PT scores, accreditations and customer satisfaction. His unique experience lends itself to working successfully with employees, managers and clients at all levels.

Professional Experience

Quality Assurance Manager – TestAmerica Edison - 2005 to Present

Mr. Armbruster is responsible for establishing and implementing the quality assurance program at the Edison facility; and for interfacing with the corporate Quality Assurance Director to ensure adherence with the overall Quality Management Plan. He is also responsible for monitoring implementation and compliance with NELAC and TestAmerica's QMP, conducting annual management system audits and data audits, as well as providing regulatory updates and technical support to the Laboratory Director, Operations Manager, Client Services and Sales department.

Project Manager/Assistant Technical Director – STL Edison --2000 to 2005

Laboratory Director – STL Whippany – 1998 to 2000

Account Manager – Clean Harbors Environmental Services – 1997 to 1998

Laboratory Manager – Waste Management Inc., and Chemical Waste Management Inc – 1988 to 1997

Environmental Scientist – ICF Technology – 1987 to 1988

Analytical Chemist – IT Corporation – 1985 to 1987

Analytical Chemist – Hess Environmental Laboratories – 1983 to 1985

Education

- ◆ MS in Biology – East Stroudsburg University, 1984
- ◆ BS in Environmental Studies - East Stroudsburg University, 1980

L.A.B. Validation Corp., 14 West Point Drive, East Northport, New York 11731

Lori A. Beyer

SUMMARY:

General Manager/Laboratory Director with a solid technical background combined with Management experience in environmental testing industry. Outstanding organizational, leadership, communication and technical skills. Customer focused, quality oriented professional with consistently high marks in customer/employee satisfaction.

EXPERIENCE:

1998-Present L.A.B. Validation Corporation, 14 West Point Drive, East Northport, NY

President

- Perform Data Validation activities relating to laboratory generated Organic and Inorganic Environmental Data.

1998-Present American Analytical Laboratories, LLC. 56 Toledo Street, Farmingdale, NY

Laboratory Director/Technical Director

- Plan, direct and control the operation, development and implementation of programs for the entire laboratory in order to meet AAL's financial and operational performance standards.
- Ensures that all operations are in compliance with AAL's QA manual and other appropriate regulatory requirements.
- Actively maintains a safe and healthy working environment that is demanded by local laws/regulations.
- Monitors and manages group's performance with respect to data quality, on time delivery, safety, analyst development/goal achievement and any other key performance indices.
- Reviews work for accuracy and completeness prior to release of results to customers.

1996-1998 Nytest Environmental, Inc. (NEI) Port Washington, New York

General Manager

- Responsible for controlling the operation of an 18,000 square foot facility to meet NEI's financial and operational performance standards.
- Management of 65 FTEs including Sales and Operations
- Ensure that all operations are in compliance with NEI's QA procedures
- Ensures that productivity indicators, staffing levels and other cost factors are held within established guidelines
- Maintains a quantified model of laboratory's capacity and uses this model as the basis for controlling the flow of work into and through the lab so as to ensure that customer requirements and lab's revenue and contribution targets are achieved.

1994-1996 Nytest Environmental, Inc. (NEI) Port Washington, New York

Technical Project Manager

- Responsible for the coordination and implementation of environmental testing programs requirements between NEI and their customers
- Supervise Customer Service Department
- Assist in the development of major proposals
- Complete management of all Federal and State Contracts and assigned commercial contracts
- Provide technical assistance to the customer, including data validation and interpretation
- Review and implement Project specific QAPP's.

1995-1996 Nytest Environmental, Inc. (NEI) Port Washington, New York

Corporate QA/QC Officer

- Responsible for the implementation of QA practices as required in the NJDEP and EPA Contracts
- Primary contact for NJDEP QA/QC issues including SOP preparation, review and approval
- Responsible for review, verification and adherence to the Contract requirements and NEI QA Plan

1992-1994 Nytest Environmental, Inc. (NEI) Port Washington, New York

Data Review Manager

- Responsible for the accurate compilation, review and delivery of analytical data to the company's customers. Directly and effectively supervised a department of 22 personnel.
- Managed activities of the data processing software including method development, form creation, and production
- Implement new protocol requirements for report and data management formats
- Maintained control of data storage/archival areas as EPA/CLP document control officer

1987-1991 Nytest Environmental, Inc. (NEI) Port Washington, New York

Data Review Specialist

- Responsible for the review of GC, GC/MS, Metals and Wet Chemistry data in accordance with regulatory requirements
- Proficient with USEPA, NYSDEC, NJDEP and NEESA requirements
- Review data generated in accordance with SW846, NYSDEC ASP, EPA/CLP and 40 CFR Methodologies

1986-1987 Nytest Environmental, Inc (NEI) Port Washington, New York

GC/MS VOA Analyst

EDUCATION:

1982-1985 State University of New York at Stony Brook, New York; BS Biology/Biochemistry

1981-1982 University of Delaware; Biology/Chemistry

5/91 Rutgers University; Mass Spectral Data Interpretation Course, GC/MS Training

8/92 Westchester Community College; Organic Data Validation Course

9/93 Westchester Community College; Inorganic Data Validation Course

Westchester Community College

Professional Development Center

Awards this Certificate of Achievement To

LORI BEYER

for Successfully Completing

ORGANIC DATA VALIDATION COURSE (35 HOURS)

Dr. John Samuelian

Date AUGUST 1992



Assistant Dean
Professional Development Center



President



The Professional
Development Center

Westchester Community College

Professional Development Center

Awards this Certificate of Achievement To

LORI BEYER

for Successfully Completing

INORGANIC DATA VALIDATION

Instructor: Dale Boshart

Date MARCH 1993

Robert A. West

Assistant Dean
Professional Development Center

Jill

President



The Professional
Development Center

New York State Department of Environmental Conservation
50 Wolf Road, Albany, New York 12233



Thomas C. Jorling
Commissioner

July 8, 1992

Ms. Elaine Sall
Program Coordinator
Westchester Community College
Valhalla, NY 10595-1698

Dear Elaine,

Thank you for your letter of June 29, 1992. I have reviewed the course outline for organic data validation, qualifications for teachers and qualifications for students. The course that you propose to offer would be deemed equivalent to that which is offered by EPA. The individuals who successfully complete the course and pass the final written exam would be acceptable to perform the task of organic data validation for the Department of Environmental Conservation, Division of Hazardous Waste Remediation.

As we have discussed in our conversation of July 7, 1992, you will forward to me prior to the August course deadline, the differences between the EPA SOW/90 and the NYSDEC ASP 12/91. You stated these differences will be compiled by Mr. John Samulian.

I strongly encourage you to offer an inorganic data validation course. I anticipate the same list of candidates would be interested in an inorganic validation course as well, since most of the data to be validated consists of both organic and inorganic data.

Thank you for your efforts and please contact me if I can be of any further assistance.

Sincerely,

Maureen P. Serafini

Maureen P. Serafini
Environmental Chemist II
Division of Hazardous Waste
Remediation

②



October 2, 1992

Ms. Lori Beyer
3 sparkill Drive
East Northport, NY 11731

Dear Ms. Beyer:

Congratulations upon successful completion of the Organic Data Validation course held August 17 - 21, 1992, through Westchester Community College, Professional Development Center. This course has been deemed by New York State Department of Environmental Conservation as equivalent to EPA's Organic Data Validation Course.

Enclosed is your Certificate. Holders of this Certificate are deemed competent to perform organic data validation for the New York State DEC Division of Hazardous Waste Remediation.

The Professional Development Center at Westchester Community College plans to continue to offer courses and seminars which will be valuable to environmental engineers, chemists and related personnel. Current plans include a TCLP seminar on November 17th and a conference on Environmental Monitoring Regulations on November 18th.

We look forward to seeing you again soon at another environmental program or event. Again, congratulations.

Very truly yours,

Passing Grade is 70%
Your Grade is 99%

Elaine Sall
Program Coordinator

ES/bf





June 21, 1993

Dear Ms. Beyer:

Enclosed is your graded final examination in the Inorganic Data Validation course you completed this past March. A score of 70% was required in order to receive a certificate of satisfactory completion. Persons holding this certificate are deemed acceptable to perform Inorganic Data Validation for the New York State Department of Environmental Conservation, Division of Hazardous Waste Remediation.

I am also enclosing a course evaluation for you to complete if you have not already done so. The information you provide will greatly aid us in structuring further courses. We wish to make these course offerings as relevant, targeted and comprehensive as possible. Your evaluation is vital to that end.

Congratulations on your achievement. I look forward to seeing you again at another professional conference or course. We will be co-sponsoring an environmental monitoring conference on October 21, 1993 with the New York Water Pollution Control Association, Lower Hudson Chapter, at IBM's Yorktown Heights, NY site. Information regarding this event will be going out in August.

Very truly yours,

Elaine Sall
Program Coordinator

ES/bf

Enclosures



APPENDIX B
NYSDOH INDOOR AIR QUALITY QUESTIONNAIRE AND BUILDING INVENTORY FORM

**NEW YORK STATE DEPARTMENT OF HEALTH
INDOOR AIR QUALITY QUESTIONNAIRE AND BUILDING INVENTORY
CENTER FOR ENVIRONMENTAL HEALTH**

This form must be completed for each residence involved in indoor air testing.

Preparer's Name _____ Date/Time Prepared _____

Preparer's Affiliation _____ Phone No. _____

Purpose of Investigation _____

1. OCCUPANT:

Interviewed: Y / N

Last Name: _____ First Name: _____

Address: _____

County: _____

Home Phone: _____ Office Phone: _____

Number of Occupants/persons at this location _____ Age of Occupants _____

2. OWNER OR LANDLORD: (Check if same as occupant ___)

Interviewed: Y / N

Last Name: _____ First Name: _____

Address: _____

County: _____

Home Phone: _____ Office Phone: _____

3. BUILDING CHARACTERISTICS

Type of Building: (Circle appropriate response)

Residential	School	Commercial/Multi-use
Industrial	Church	Other: _____

If the property is residential, type? (Circle appropriate response)

- | | | |
|--------------|-----------------|-------------------|
| Ranch | 2-Family | 3-Family |
| Raised Ranch | Split Level | Colonial |
| Cape Cod | Contemporary | Mobile Home |
| Duplex | Apartment House | Townhouses/Condos |
| Modular | Log Home | Other: _____ |

If multiple units, how many? _____

If the property is commercial, type?

Business Type(s) _____

Does it include residences (i.e., multi-use)? Y / N If yes, how many? _____

Other characteristics:

Number of floors _____ Building age _____

Is the building insulated? Y / N How air tight? Tight / Average / Not Tight

4. AIRFLOW

Use air current tubes or tracer smoke to evaluate airflow patterns and qualitatively describe:

Airflow between floors

Airflow near source

Outdoor air infiltration

Infiltration into air ducts

5. BASEMENT AND CONSTRUCTION CHARACTERISTICS (Circle all that apply)

- a. Above grade construction: wood frame concrete stone brick
- b. Basement type: full crawlspace slab other _____
- c. Basement floor: concrete dirt stone other _____
- d. Basement floor: uncovered covered covered with _____
- e. Concrete floor: unsealed sealed sealed with _____
- f. Foundation walls: poured block stone other _____
- g. Foundation walls: unsealed sealed sealed with _____
- h. The basement is: wet damp dry moldy
- i. The basement is: finished unfinished partially finished
- j. Sump present? Y / N
- k. Water in sump? Y / N / not applicable

Basement/Lowest level depth below grade: _____(feet)

Identify potential soil vapor entry points and approximate size (e.g., cracks, utility ports, drains)

6. HEATING, VENTING and AIR CONDITIONING (Circle all that apply)

Type of heating system(s) used in this building: (circle all that apply – note primary)

- Hot air circulation
- Space Heaters
- Electric baseboard
- Heat pump
- Stream radiation
- Wood stove
- Hot water baseboard
- Radiant floor
- Outdoor wood boiler
- Other _____

The primary type of fuel used is:

- Natural Gas
- Electric
- Wood
- Fuel Oil
- Propane
- Coal
- Kerosene
- Solar

Domestic hot water tank fueled by: _____

Boiler/furnace located in: Basement Outdoors Main Floor Other _____

Air conditioning: Central Air Window units Open Windows None

Are there air distribution ducts present? Y / N

Describe the supply and cold air return ductwork, and its condition where visible, including whether there is a cold air return and the tightness of duct joints. Indicate the locations on the floor plan diagram.

7. OCCUPANCY

Is basement/lowest level occupied? Full-time Occasionally Seldom Almost Never

Level General Use of Each Floor (e.g., familyroom, bedroom, laundry, workshop, storage)

Basement	_____
1 st Floor	_____
2 nd Floor	_____
3 rd Floor	_____
4 th Floor	_____

8. FACTORS THAT MAY INFLUENCE INDOOR AIR QUALITY

- a. Is there an attached garage? Y / N
- b. Does the garage have a separate heating unit? Y / N / NA
- c. Are petroleum-powered machines or vehicles stored in the garage (e.g., lawnmower, atv, car) Y / N / NA
Please specify _____
- d. Has the building ever had a fire? Y / N When? _____
- e. Is a kerosene or unvented gas space heater present? Y / N Where? _____
- f. Is there a workshop or hobby/craft area? Y / N Where & Type? _____
- g. Is there smoking in the building? Y / N How frequently? _____
- h. Have cleaning products been used recently? Y / N When & Type? _____
- i. Have cosmetic products been used recently? Y / N When & Type? _____

- j. Has painting/staining been done in the last 6 months? Y / N Where & When? _____
- k. Is there new carpet, drapes or other textiles? Y / N Where & When? _____
- l. Have air fresheners been used recently? Y / N When & Type? _____
- m. Is there a kitchen exhaust fan? Y / N If yes, where vented? _____
- n. Is there a bathroom exhaust fan? Y / N If yes, where vented? _____
- o. Is there a clothes dryer? Y / N If yes, is it vented outside? Y / N
- p. Has there been a pesticide application? Y / N When & Type? _____

Are there odors in the building? Y / N
 If yes, please describe: _____

Do any of the building occupants use solvents at work? Y / N
 (e.g., chemical manufacturing or laboratory, auto mechanic or auto body shop, painting, fuel oil delivery, boiler mechanic, pesticide application, cosmetologist)

If yes, what types of solvents are used? _____

If yes, are their clothes washed at work? Y / N

Do any of the building occupants regularly use or work at a dry-cleaning service? (Circle appropriate response)

- Yes, use dry-cleaning regularly (weekly) No
- Yes, use dry-cleaning infrequently (monthly or less) Unknown
- Yes, work at a dry-cleaning service

Is there a radon mitigation system for the building/structure? Y / N Date of Installation: _____
Is the system active or passive? Active/Passive

9. WATER AND SEWAGE

Water Supply: Public Water Drilled Well Driven Well Dug Well Other: _____
Sewage Disposal: Public Sewer Septic Tank Leach Field Dry Well Other: _____

10. RELOCATION INFORMATION (for oil spill residential emergency)

- a. Provide reasons why relocation is recommended: _____
- b. Residents choose to: remain in home relocate to friends/family relocate to hotel/motel
- c. Responsibility for costs associated with reimbursement explained? Y / N
- d. Relocation package provided and explained to residents? Y / N

11. FLOOR PLANS

Draw a plan view sketch of the basement and first floor of the building. Indicate air sampling locations, possible indoor air pollution sources and PID meter readings. If the building does not have a basement, please note.

Basement:

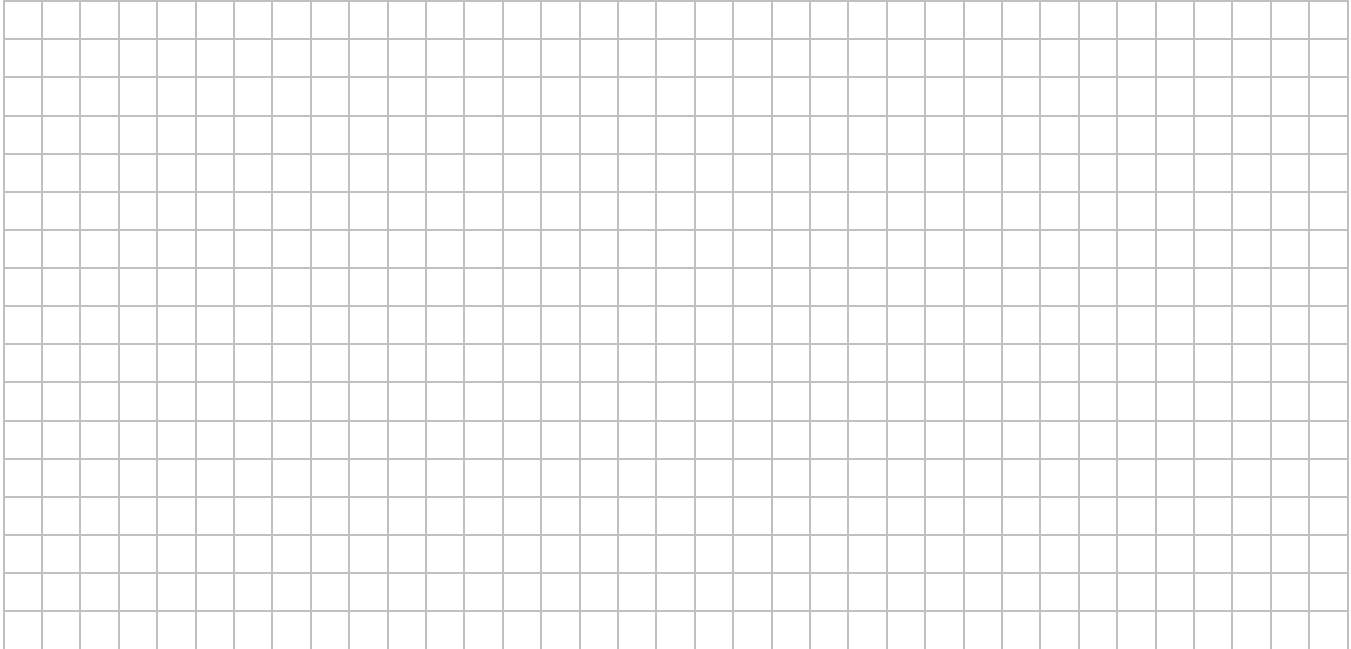

First Floor:

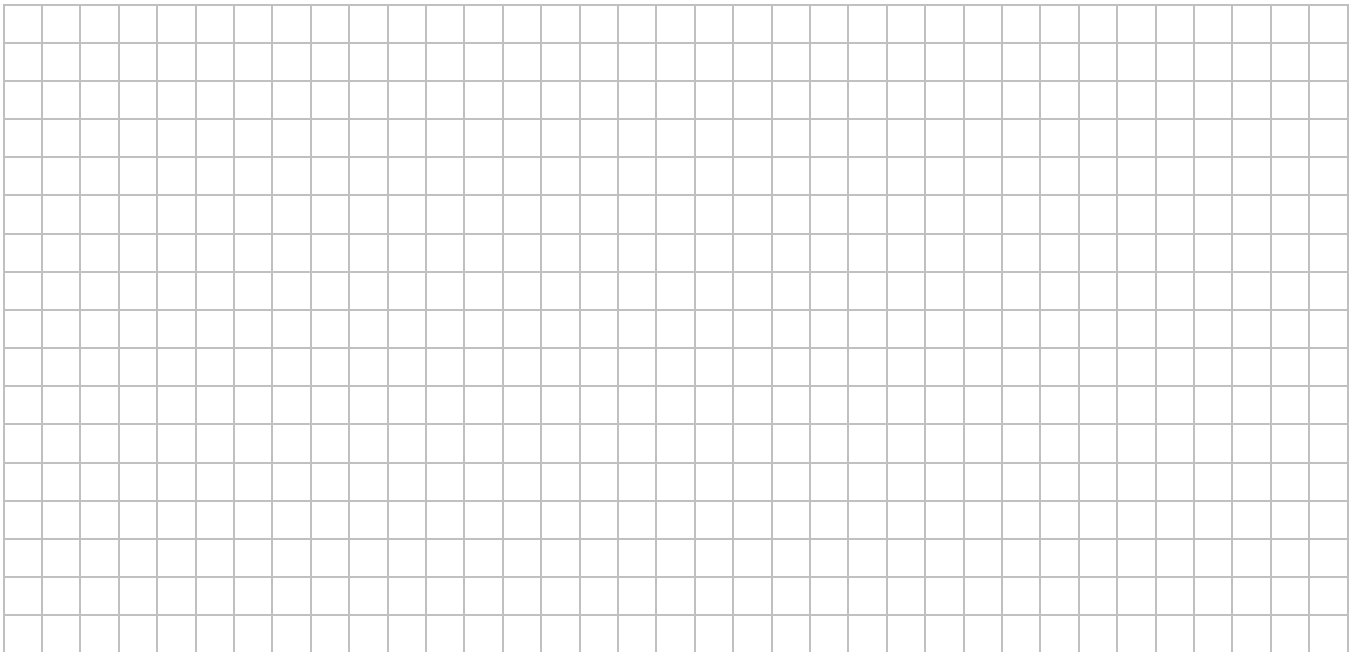

12. OUTDOOR PLOT

Draw a sketch of the area surrounding the building being sampled. If applicable, provide information on spill locations, potential air contamination sources (industries, gas stations, repair shops, landfills, etc.), outdoor air sampling location(s) and PID meter readings.

Also indicate compass direction, wind direction and speed during sampling, the locations of the well and septic system, if applicable, and a qualifying statement to help locate the site on a topographic map.

