

REVISED FINAL

Site Management Plan

**Brownfield Cleanup Program No. C360115
1-5 Holland Avenue
White Plains, NY
14206 / 65459**

Prepared for:
One Holland Avenue Development, LLC

Prepared by:
O'Brien & Gere Engineers, Inc.

DECEMBER 2014
(Updated FEBRUARY 2018)

**Site Management Plan
1-5 Holland Avenue
Site No C360115
White Plains, New York**

I, Douglas M. Crawford, certify that I am currently a NYS registered professional engineer and that this Site Management Plan was prepared in accordance with all applicable statutes and regulations and in substantial conformance with the DER Technical Guidance for Site Investigation and Remediation (DER-10).



**DOUGLAS M. CRAWFORD, P.E., VICE PRESIDENT
PROFESSIONAL ENGINEER LICENSE NO. NY 066649
O'BRIEN & GERE ENGINEERS, INC.
333 W. WASHINGTON STREET.
SYRACUSE, NY 13202**

1-5 Holland Avenue Site

WESTCHESTER, NEW YORK

Site Management Plan

NYSDEC Site Number: C360115

Prepared for:
 One Holland Avenue Development, LLC
 11280 Cornell Park Drive
 Cincinnati, Ohio 45242

Prepared by:
 O'Brien & Gere Engineers, Inc.
 22 Saw Mill River Road
 Hawthorne, NY 10532
 914-345-1616

Revisions to Final Approved Site Management Plan:

Revision #	Submitted Date	Summary of Revision	DEC Approval Date
1	11/4/2014	NYSDEC comments incorporated as detailed in October 22, 2014 letter. (Thompson. 2014)	12/23/2014
2	12/2/2014	NYSDEC comments incorporated as detailed in email from K. Thompson dated November 20, 2014	12/23/2014
3	02/16/2018	Revised to account for the removal of subsequent off-site VI potential monitoring at 2 Holland Avenue per NYSDEC PRR acceptance letter dated September 29, 2017.	09/29/2017

REVISED FINAL DECEMBER 2014
(UPDATED FEBRUARY 16, 2018)

LIST OF TABLES	iv
LIST OF FIGURES	v
LIST OF APPENDICES	vi
SITE MANAGEMENT PLAN	1
1.0 Introduction and Description of Remedial Program	1
1.1 Introduction.....	1
1.1.1 General.....	1
1.1.2 Purpose.....	1
1.1.3 Revisions.....	2
1.2 Site Background.....	2
1.2.1 Site Location and Description	2
1.2.2 Site History.....	2
1.2.3 Geologic Conditions.....	3
1.3 Summary of Remedial Investigation Findings.....	4
1.3.1 Soil	4
1.3.2 Site-Related Groundwater	4
1.3.3 Off- Site Surface Water	5
1.3.4 Site-Related Soil Vapor Intrusion	5
1.3.5 Underground Storage Tanks	5
1.4 Summary of Remedial Actions.....	5
1.4.1 Removal of Contaminated Materials from the Site	6
1.4.2 Site-Related Treatment and Control Systems	6
1.4.3 Remaining Contamination.....	7
2.0 Engineering and Institutional Control Plan	8
2.1 Introduction.....	8
2.1.1 General.....	8
2.1.2 Purpose.....	8
2.2 Engineering Controls	8
2.2.1 Engineering Control Systems	8
2.2.1.1 Composite Cover System.....	8
2.2.1.2 VI Mitigation Sub-slab Depressurization System.....	8
2.2.2 Criteria for Completion of Remediation/Termination of Remedial Systems.....	9
2.2.2.1 Composite Cover System.....	9
2.2.2.2 Sub-slab Depressurization System (SSDS)	9
2.2.2.3 Natural Attenuation with Monitoring.....	9
2.3 Institutional Controls	9
2.3.1 Excavation Work Plan	10
2.3.2 Soil Vapor Intrusion Evaluation.....	11
2.4 Inspections and Notifications	11
2.4.1 Inspections.....	11

2.4.2 Notifications	12
2.5 Contingency Plan.....	12
2.5.1 Emergency Telephone Numbers	12
2.5.2 Map and Directions to Nearest Health Facility.....	13
2.5.3 Response Procedures	15
3.0 Site Monitoring Plan.....	16
3.1 Introduction.....	16
3.1.1 General.....	16
3.1.2 Purpose and Schedule	16
3.2 Cover System Monitoring	17
3.3 Media Monitoring Program.....	17
3.3.1 Groundwater Monitoring.....	17
3.3.1.1 Sampling Protocol	18
3.3.1.2 Monitoring Well Repairs, Replacement and Decommissioning	18
3.4 Site-Wide Inspection.....	19
3.5 Monitoring Quality Assurance/Quality Control.....	19
3.6 Monitoring Reporting Requirements	20
4.0 Operation, Maintenance and Monitoring (OM&M) Plan	22
4.1 Introduction.....	22
4.2 Engineering Control System Operation and Maintenance	22
4.3 Engineering Control System Performance Monitoring.....	22
4.3.1 Monitoring Schedule.....	22
4.3.2 General Equipment Monitoring.....	23
4.3.3 System Monitoring Devices and Alarms.....	23
4.4 Maintenance and Performance Monitoring Reporting Requirements.....	23
4.4.1 Routine Maintenance Reports	23
4.4.2 Non-Routine Maintenance Reports	23
5.0 Inspections, Reporting and Certifications.....	25
5.1 Site Inspections	25
5.1.1 Inspection Frequency	25
5.1.2 Inspection Forms, Sampling Data, and Maintenance Reports.....	25
5.1.3 Evaluation of Records and Reporting.....	25
5.2 Certification of Engineering and Institutional Controls	25
5.3 Periodic Review Report.....	27
5.4 Corrective Measures Plan	27
References.....	29

LIST OF TABLES

Table 1a-c	Remedial Investigation Surface Soil Contamination Summary
Table 2.	Remedial Investigation Subsurface Soil Contamination Summary
Table 3a-b.	Remedial Investigation Groundwater Contamination Summary
Table 4.	Soil Cleanup Objectives for the Site
Table 5.	Summary of Remaining Soil Contamination
Table 6.	Emergency Contact Numbers (in text)
Table 7.	Other Contact Numbers (in text)
Table 8.	Monitoring/Inspection Schedule (in text)
Table 9.	Schedule of Monitoring/Inspection Reports (in text)

LIST OF FIGURES

Figure 1. Site Location

Figure 2. Site Boundaries

Figure 3. Geologic Cross Section Key Plan

Figure 4a. Geologic Cross-Section A-A'

Figure 4b. Geologic Cross-Section B-B'

Figure 4c. Geologic Cross-Section C-C'

Figure 5. Groundwater Flow

Figure 6a. Remedial Investigation Surface Soil Contamination Summary

Figure 6b. Remedial Investigation Subsurface Soil Contamination Summary

Figure 7a. Remedial Investigation Groundwater VOC Contamination Summary

Figure 7b. Remedial Investigation Groundwater Metals Contamination Summary

Figure 8. Remedial Investigation Soil Vapor Data

Figure 9. Extent of Remedial Excavation Performed

Figure 10. Location of Chemical Oxidation Injection Wells

Figure 11. Location of Sub-slab Depressurization Systems

Figure 12. Map of Route from Site to Hospital (in text)

Figure 13. Location of Cover System Types

Figure 14. Groundwater Monitoring Well Network

LIST OF APPENDICES

- A Responsibilities of Owner and Remedial Party
- B Environmental Easement
- C Excavation Work Plan
- D Health and Safety Plan and Community Air Monitoring Plan
- E Monitoring Well Boring and Construction Logs
- F Field Activities Plan
- G Groundwater Monitoring Well Sampling Log Form
- H Site-wide Inspection Form
- I Quality Assurance Project Plan
- J SSD System Operation and Maintenance Manual

SITE MANAGEMENT PLAN

1.0 INTRODUCTION AND DESCRIPTION OF REMEDIAL PROGRAM

1.1 INTRODUCTION

This document is required as an element of the remedial program at 1-5 Holland Avenue Site (hereinafter referred to as the “Site”) under the New York State (NYS) Brownfield Cleanup Program (BCP) administered by New York State Department of Environmental Conservation (NYSDEC). The site was remediated in accordance with Brownfield Cleanup Agreement (BCA) Index# C36-0115-11-10, Site # C360115, which was executed on December 1, 2010 and last amended on August 14, 2014.

1.1.1 General

One Holland Avenue Development, LLC (OHAD) entered into a BCA with the NYSDEC to remediate a 0.72-acre property located in White Plains, Westchester County, New York. OHAD sold the property to 1 Holland LLC on September 30, 2013 and is currently listed as a “Volunteer” under the BCA. Appendix A details the responsibilities of the owner (1 Holland LLC) and remedial party (OHAD). This BCA required the Remedial Party, OHAD, to investigate and remediate contaminated media at the site. A figure showing the site location is provided in Figure 1. The boundaries of this 0.72-acre Site are provided in Figure 2. The boundaries of the site are more fully described in the metes and bounds site description that is part of the Environmental Easement (Appendix B).

After completion of the remedial work described in the Remedial Action Work Plan (RAWP), some contamination was left in the subsurface at this site, which is hereafter referred to as “remaining contamination.” This Site Management Plan (SMP) was prepared to manage remaining contamination at the site until the Environmental Easement is extinguished in accordance with ECL Article 71, Title 36. All reports associated with the site can be viewed by contacting the NYSDEC or its successor agency managing environmental issues in New York State.

This SMP was prepared by O’Brien & Gere Engineers (O’Brien & Gere), on behalf of OHAD, in accordance with the requirements in NYSDEC DER-10 Technical Guidance for Site Investigation and Remediation, dated May, 2010, and the guidelines provided by NYSDEC. This SMP addresses the means for implementing the Institutional Controls (ICs) and Engineering Controls (ECs) that are required by the Environmental Easement for the site.

1.1.2 Purpose

The site contains contamination remaining after completion of the remedial action. Engineering Controls have been incorporated into the site remedy to control exposure to remaining contamination during the use of the site to ensure protection of public health and the environment. An Environmental Easement granted to the NYSDEC, and recorded with the Westchester County Clerk, will require compliance with this SMP and all ECs and ICs placed on the site. The ICs place restrictions on site use, and mandate operation, maintenance, monitoring and reporting measures for all ECs and ICs. This SMP specifies the methods necessary ensure compliance with all ECs and ICs required by the Environmental Easement for contamination that remains at the site. This plan has been approved by the NYSDEC, and compliance with this plan is required by the grantor of the Environmental Easement and the grantor’s successors and assigns. This SMP may only be revised with the approval of the NYSDEC.

This SMP provides a detailed description of all procedures required to manage remaining contamination at the site after completion of the Remedial Action, including: (1) implementation and management of all Engineering and Institutional Controls; (2) media monitoring; (3) operation and maintenance of all treatment, collection, containment, or recovery systems; (4) performance of periodic inspections, certification of results, and submittal of Periodic Review Reports; and (5) defining criteria for termination of treatment system operations.

To address these needs, this SMP includes three plans: (1) an Engineering and Institutional Control Plan for implementation and management of EC/ICs; (2) a Monitoring Plan for implementation of Site Monitoring; (3) an Operation and Maintenance Plan for implementation of remedial collection, containment, treatment, and recovery systems (including, where appropriate, preparation of an Operation and Maintenance Manual for complex systems).

This plan also includes a description of Periodic Review Reports for the periodic submittal of data, information, recommendations, and certifications to NYSDEC.

It is important to note that:

- This SMP details the site-specific implementation procedures that are required by the Environmental Easement. Failure to properly implement the SMP is a violation of the environmental easement, which is grounds for revocation of the Certificate of Completion (COC).
- Failure to comply with this SMP is also a violation of Environmental Conservation Law, 6 NYCRR Part 375 and the BCA (Index #C36-0115-11-10; Site # C360115) for the site, and thereby subject to applicable penalties.

1.1.3 Revisions

Revisions to this plan will be proposed in writing to the NYSDEC's project manager. In accordance with the Environmental Easement for the site, the NYSDEC will provide a notice of any approved changes to the SMP, and append these notices to the SMP that is retained in its files.

1.2 SITE BACKGROUND

1.2.1 Site Location and Description

The site is located in the City of White Plains, County of Westchester, New York and is identified as Parcel ID 125.07-1-1 on the City of White Plains Tax Map No. 125.07 and as a portion of Block 1 and Lot 3.1 on the City of White Plains Tax Map No.125.66. The site is an approximately 0.72-acre area bounded by Holland Avenue and commercial buildings to the north, White Plains rural cemetery to the south, commercial buildings to the east, and Harlem Line of Metro North Railroad tracks and parking area to the west (see Figure 2). The boundaries of the site are more fully described in Appendix B – Environmental Easement.

1.2.2 Site History

Feintool New York, Inc. (“Feintool”) leased the 1-5 Holland Avenue property from 1971 to 2009. Feintool conducted manufacturing of metal parts for the automotive, electrical, and cutlery industries at the property from 1971 through June 2008. By 1987, a total of four buildings had been constructed on the property. All four buildings remain and are shown on Figure 2, labeled as 1-5 Holland Ave. Feintool's manufacturing activities consisted of the following:

- Activities in Building #1, a 5,100 square foot building, were associated with storage, metal stamping, a machine shop, and cutting oil storage

- Activities in Building #2, a 1,350 square foot building, were associated with storage, office space, and most recently, a small printing business
- Activities in Building #3, the main 4,200 square foot manufacturing building, were associated with large metal stamping, a machine shop, shipping, and waste oil storage
- Activities in Building #4, a 5,750 square foot manufacturing building, were associated with small metal stamping, a machine shop, and office space.

Use of the property prior to 1971 included:

- Sheridan Motors, Inc. (1930's) - operated as a garage, repair shop, and an auto paint shop
- Modern Swimming Pool Company, Inc (1950's) - multiple buildings used as a warehouse, office and showroom and for manufacturing, as well as leased space used to operate a photography company
- EES Gee, Inc. and Stoffel Fine Flow Stamping (1960's) - used by an electronics company and for metal parts machining.

OHAD purchased the subject property in 2009. Previously, the property was owned by 1 Holland Avenue Associates, Inc., a real estate company that purchased the property in October 2000 from an unrelated entity. From June 2008 to October 2011, the property was vacant. From October 2011 through June 2013, the northern half of Building #3 was occupied for use by a car detailing business (Puffs Auto Salon). During this period, the remainder of the property was marketed for sale or lease, but remained vacant. The property was sold by OHAD in October 2013, to the current owner identified as 1 Holland LLC. The current owner renovated and redeveloped the entire property for use as a self-storage facility (White Plains Self Storage). OHAD remains responsible as the Participant under the BCA for completing environmental work under the BCP. The new owner, 1 Holland LLC, was added as a Volunteer under the August 14, 2014 amendment to the BCA.

1.2.3 Geologic Conditions

The Remedial Investigation (RI) was conducted from March 2011 through May 2013 and included the investigation and characterization of the overburden soil, bedrock, and groundwater as detailed in the *Remedial Investigation Report, BCP No. C360115, 1-5 Holland Avenue, White Plains, New York* (O'Brien & Gere 2014a). The following geologic conditions were documented in the *RI Report*.

The Site is underlain by 0.5 feet to 5 feet of sandy fill followed by a well sorted fine to medium grained sand to a depth between 15 and 17 feet below grade surface (bgs). A poorly sorted sandy-gravel believed to be till is present below this depth. Bedrock (Inwood Marble) is encountered between 20 and 24 feet bgs and is characterized as a calcitic-dolomitic marble with majority of fractures occurring in the upper 10 feet. These fractures act as the principal pathway for horizontal groundwater flow through the bedrock. Bedrock becomes increasingly competent and unfractured with depth. A geologic section location plan is shown in Figure 3. Three geologic sections have been provided in Figures 4a through 4c.

Groundwater is generally encountered in the overburden approximately 12-15 feet bgs with primary direction of flow from the east to the west/northwest toward the Bronx River. Groundwater in the sand flows to the west-northwest. The average hydraulic conductivity of the sand is estimated to be about 3E-03 cm/sec (9 ft/day). Horizontal groundwater flow in the highly fractured upper portion of the bedrock is generally to the west. The average estimated hydraulic conductivity of the bedrock is about 6E-05 cm/sec (0.2 ft/day). Vertical groundwater flow in the bedrock is generally limited to vertical flow

between the bedrock and overburden because of the low hydraulic conductivity of the deep bedrock and the higher hydraulic conductivity of the overburden. The ranges in hydraulic conductivity values, based on *in situ* hydraulic conductivity tests, are as follows:

- Overburden range – 1×10^{-4} cm/sec to 2.1×10^{-2} cm/sec (0.3 ft/day to 58 ft/day)
- Bedrock range – 3.6×10^{-7} cm/sec to 1.7×10^{-3} cm/sec (0.0003 ft/day to 5 ft/day).

An overburden groundwater flow figure is shown in Figure 5.

1.3 SUMMARY OF REMEDIAL INVESTIGATION FINDINGS

A Remedial Investigation (RI) was performed to characterize the nature and extent of contamination at the site. The results of the RI are described in detail in the following reports:

- *Remedial Investigation Report, Brownfield Cleanup Program No. C360115, 1-5 Holland Avenue, White Plains, New York* by O'Brien & Gere Engineers, Inc. 333 West Washington Street, Syracuse New York, April, 2014.

Generally, the RI Report concluded that tetrachlorethene (PCE) and its degradation products [1,2-dichloroethene (cis-1,2-DCE), trichloroethene (TCE), and vinyl chloride (VC)], are affecting on-Site and off-Site groundwater and soil vapor. The apparent source area of the groundwater impacts is located in the vicinity of the historic floor drains FD-2 and FD-3, though no source of PCE was identified in subsurface soil samples in this area. Semi-Volatile Organic Compounds (SVOCs) and/or metals at concentrations exceeding restricted commercial soil cleanup objectives (SCOs) were detected in soil at the Site, though these SVOCs and metals are likely not related to site activities. Surface water samples collected from the Bronx River indicate that PCE concentrations observed in the Bronx River are from an unidentified, upstream source that is unrelated to the Site. These data do not indicate the Site is impacting the surface water quality. Below is a summary of site conditions documented by the RI activities, which were completed during 2011 and 2012.

1.3.1 Soil

Surface soil analytical results from three of the four on-site areas having exposed soils (*e.g.*, areas not paved or covered by structures) indicated detectable concentrations of SVOCs and/or metals at concentrations exceeding applicable SCOs. Observed concentrations are included in Tables 1a through 1c. The extents of observed SVOCs and metal are shown on Figure 6a. The surface soils that exceeded SCOs have been addressed by remedial activities, described in Section 1.4, and are no longer present as surface soils.

Concentrations of arsenic, mercury, lead, and copper, exceeding applicable SCOs were detected in subsurface soil samples, as shown in Figure 6b. These subsurface soil samples likely reflect the presence of urban fill and are not necessarily associated with site activities. Subsurface soil analytical results, from the suspected source area of the groundwater PCE impacts, did not indicate the presence of PCE at concentrations above 6 NYCRR Part 375-6 restricted commercial or protection of groundwater soil cleanup objectives. However, the groundwater analytical data, discussed below, suggested that a residual source of PCE was present.

1.3.2 Site-Related Groundwater

Results of groundwater sampling indicated the presence of PCE and associated degradation products in overburden and bedrock groundwater, on-site and hydraulically downgradient of the Site, at concentrations above the NYS Class GA groundwater standard of 5 ug/l. The presence of PCE

degradation products in downgradient groundwater suggests that degradation of PCE is occurring. RI groundwater analytical results are presented on Figures 7a and 7b and Tables 3a and 3b.

1.3.3 Off- Site Surface Water

PCE was detected in surface water samples from the Bronx River. The surface water data indicated that the observed PCE concentrations were from an unidentified upstream source that is unrelated to the Site.

1.3.4 Site-Related Soil Vapor Intrusion

PCE was detected in soil vapor under the on-site buildings, under the western portion of the 7-11 Holland Avenue building located immediately east of the Site, and under the 2 Holland Avenue building, which is located north of the Site. Based on the New York State Department of Health (NYSDOH) Guidance matrices (NYSDOH, 2006) vapor mitigation was recommended for the Site (1-5 Holland Ave building) and the western portion of 7-11 Holland Ave. Vapor mitigation has been implemented for both sites and is described in Section 1.4. Sub-slab soil vapor analytical results for samples collected at and in the vicinity of the Site are presented on Figure 8.

1.3.5 Underground Storage Tanks

No underground storage tanks are currently located at the Site.

1.4 SUMMARY OF REMEDIAL ACTIONS

The site was remediated in accordance with the NYSDEC-approved *Interim Remedial Measure Work Plan* dated June 2013 (O'Brien & Gere 2013) and communications with NYSDEC (Frink 2013 and Becker 2014). Remedial activities conducted at the site consisted of the following as documented in the *Interim Remedial Measure Construction Completion Report* (O'Brien & Gere 2014b):

The following is a summary of the Remedial Actions performed at the site:

1. Excavation of soil/fill exceeding commercial SCOs listed in Table 4, to a depths of up to 2 ft in the areas where surface soil sample concentrations exceeded SCOs
2. Maintenance of a soil cover system consisting of soil, gravel, paving and the Site building to prevent human exposure to remaining contaminated subsurface soil/fill remaining at the site
3. Execution and recording of an Environmental Easement to restrict land use and prevent future exposure to any contamination remaining at the site
4. *In situ* chemical oxidation treatment to address the apparent source of the PCE-impacted groundwater and downgradient groundwater exceeding the New York State Class GA groundwater standards
5. Installation and maintenance of VI mitigation systems (SSD systems) for on-site buildings (1-5 Holland Avenue) and the western portion of the off-site building (7-11 Holland Avenue)
6. Development and implementation of a SMP for long term management of remaining contamination as required by the Environmental Easement, which includes plans for: (1) Institutional and Engineering Controls, (2) monitoring, (3) operation and maintenance and (4) reporting.

Remedial activities were completed at the site as follows:

- Soil excavation was completed in July and September 2013, and in February 2014
- *In situ* chemical oxidation was performed in June 2013 and September 2014
- VI Mitigation SSD System at 1-5 Holland Avenue was completed in April 2009

- VI Mitigation SSD System at 7-11 Holland Avenue was completed in February 2013.

1.4.1 Removal of Contaminated Materials from the Site

Consistent with correspondence with NYSDEC (Frink 2013 and Becker 2014), surface soil excavation activities were conducted at the Site. As documented in the *Interim Remedial Measure Construction Completion Report* (O'Brien & Gere 2014b), the areas of surface soil removal included two areas at the rear of the facility and the flower bed in the front of the building along Holland Avenue near the loading dock. A total of approximately 14 cubic yards of soil was excavated. Excavation was completed as follows:

- Southwest Corner (SS12-1) – In connection with surface drainage improvement and based on soil sampling conducted in this area soils were found to have concentrations of SVOCs exceeding the NYSDEC commercial SCOs. This area was excavated to 1 foot below grade, silt fabric laid down and one foot of crushed gravel put in place. A perforated pipe and two sumps containing electric pumps were also installed in the crushed gravel layer
- Southeast Corner (SS12-4) – Based on soil sampling conducted, this area was found to contain soils with concentrations of SVOCs exceeding the commercial SCOs. Soil in this area was excavated to approximately 1 to 2 feet below grade and a French drain was installed to mitigate localized flooding. Crushed gravel was used as backfill in this area. Silt fabric was not reportedly placed beneath the gravel in this area
- Former Northeast Flower Bed (SS12-3) – The soil in the former Northeast Flower Bed was excavated in order for a concrete access ramp to be installed at the front of the building. Excavated soils were disposed off-site. The excavation areas adjacent to the access ramp were restored with asphalt paving

A list of the SCOs for the primary COCs and applicable land use for this site is provided in Table 4. A figure showing areas where excavation was performed is shown in Figure 9.

1.4.2 Site-Related Treatment and Control Systems

In situ Chemical Oxidation Treatment

Consistent with the Interim Remedial Measure Work Plan (O'Brien & Gere, 2013), an *in situ* treatment IRM was implemented to address the apparent source of PCE in groundwater.

As described in the *Interim Remedial Measure Construction Completion Report* (O'Brien & Gere 2014b), the *in situ* treatment consisted of *in situ* chemical oxidation (ISCO) and was implemented by In-situ Oxidative Technologies, Inc. (ISOTEC) to treat PCE in subsurface soil, bedrock, and groundwater in the apparent source area. Ten injection well (IW) clusters were installed in the suspected source area between May and June 2013 by Aquifer Drilling and Testing (ADT). The injection wells were installed to depths between 44 feet bgs and 48 feet bgs. The injection wells were screened between 15 to 20 ft bgs (overburden wells), 24 to 34 ft bgs (shallow bedrock wells) and 38 to 48 ft bgs (deep bedrock wells).

ISOTEC implemented the ISCO groundwater treatment program in June 2013 and September 2014 using an activated sodium persulfate process. The combined injections utilized 12,760 pounds (lbs) of sodium persulfate in 55 lb bags and 2,024 gallons of 25% sodium hydroxide (21,600 lbs) in 55-gallon drums. A total of 14,400 gallons of BASP reagent (7,200 gallons each event into both the overburden and shallow bedrock zones) was injected during the ISCO IRM to treat an approximately 1,100 square ft area. The location of the *in situ* chemical oxidation treatment is illustrated on Figure 10.

Vapor Intrusion Mitigation SSD Systems

Vapor intrusion mitigation systems (SSD systems) were installed for on-site buildings (1-5 Holland Avenue) and off-site buildings at 7-11 Holland Avenue. As described in the *Interim Remedial Measure Construction Completion Report* (O'Brien & Gere 2014b), the SSD systems are used to induce a vacuum under the building's concrete foundation slab where concentrations in sub-slab soil vapor and indoor air samples triggered the need for mitigation based on NYSDOH's *Guidance for Evaluating Soil Vapor Intrusion in the State of New York* (NYSDOH 2006). Each SSD system uses a fan mounted on the exterior of the building, which induces a vacuum to pull sub-slab soil vapor through polyvinyl chloride (PVC) pipe that penetrates the slab.

The SSD systems for on-site structures at the 1-5 Holland Avenue property were installed in April 2009 by Enviro Testing (Division of KMT, LLC) prior to the Site entering the BCP program. In February 2013, a horizontal sub-slab vapor extraction point was installed underneath the western portion of the neighboring 7-11 Holland Avenue building and connected to the existing SSD system at 1-5 Holland Avenue.

Overall SSD at 1-5 and 7-11 Holland Avenue is achieved using five separate mitigation systems. Each separate system includes a fan and two system suction points (SSPs), totaling five fans and ten SSPs with the exception of system 4B which includes the additional horizontal suction point under 7-11 Holland Avenue. Effective SSD of the 1-5 and 7-11 Holland Avenue structures is dependent upon the proper simultaneous operation of all five systems.

System piping is constructed using schedule 40 PVC pipe. The vertical system suction points connect into a horizontal header pipe that extends to the exterior of the building, where the respective fan is mounted. On the building's exterior, PVC pipe is used to route the fans exhaust above the roof edge. Each SSP is equipped with a u-tube manometer and each mitigation system is equipped with an electronic pressure switch and audible alarm to alert the owners should the system malfunction. The location of the SSD systems is illustrated on Figure 11. Post-IRM installation indoor air samples collected in 2013 indicate that the VI mitigation system is effective at mitigating VI for the Site.

1.4.3 Remaining Contamination

As described in Section 1.4.1, soil removals and capping have been implemented in the three areas at the site where surface soils exceeded restricted commercial SCOs. As a result of these remedial activities none of the surface soils exceeding commercial SCOs remain.

As documented in the *RI Report* (O'Brien & Gere 2014a), metals in the subsurface soil with concentrations exceeding the SCOs were lead, mercury, copper and arsenic. These exceedances are considered to be related to the historic urban fill under the Site, and not related to Site activities. These locations of metals in the subsurface soils, which are covered by pavement or the building, remain on-site and are depicted on Figure 6b.

Table 2 summarizes the results of all soil samples remaining at the site after completion of Remedial Action that exceed the Track 1 (unrestricted) and restricted commercial SCOs.

Post-ISCO groundwater samples indicate that concentrations of PCE in the suspected source area of floor drains FD-2 and FD-3 based on data from MW-4S (overburden well) and MW-4D (shallow bedrock well) have decreased compared to the pre-ISCO groundwater treatment sampling event conducted on June 10, 2013. Continued monitoring, as part of this Site Management Plan, will more fully evaluate remaining impacts to groundwater.

2.0 ENGINEERING AND INSTITUTIONAL CONTROL PLAN

2.1 INTRODUCTION

2.1.1 General

Since remaining contaminated soil, groundwater, and soil vapor exists beneath the site, Engineering Controls and Institutional Controls (EC/ICs) are required to protect human health and the environment. This Engineering and Institutional Control Plan describes the procedures for the implementation and management of all EC/ICs at the site. The EC/IC Plan is one component of the SMP and is subject to revision by NYSDEC.

2.1.2 Purpose

This plan provides:

- A description of all EC/ICs on the site
- The basic implementation and intended role of each EC/IC
- A description of the key components of the ICs set forth in the Environmental Easement;
- A description of the features to be evaluated during each required inspection and periodic review
- A description of plans and procedures to be followed for implementation of EC/ICs, such as the implementation of the Excavation Work Plan (EWP) for the proper handling of remaining contamination that may be disturbed during maintenance or redevelopment work on the site
- Any other provisions necessary to identify or establish methods for implementing the EC/ICs required by the site remedy, as determined by the NYSDEC.

2.2 ENGINEERING CONTROLS

2.2.1 Engineering Control Systems

2.2.1.1 Composite Cover System

Exposure to remaining contamination in soil/fill at the site is prevented by a soil cover system placed over the site. This cover system comprises a minimum of 12 inches of clean soil or granular stone, asphalt pavement, concrete-covered sidewalks, and concrete building foundation slabs. The Excavation Work Plan that appears in Appendix C outlines the procedures required to be implemented in the event the cover system is breached, penetrated or temporarily removed, and any underlying remaining contamination is disturbed. Procedures for the inspection and maintenance of this cover are provided in the Monitoring Plan included in Section 3-of this SMP.

2.2.1.2 VI Mitigation Sub-slab Depressurization System

Five SSD systems were installed as an IRM as described in Section 1.4.2. The objective of these systems is to maintain suitable indoor air conditions at the 1-5 Holland Ave and 7-11 Holland Ave locations by inducing a negative sub-slab vacuum. Operation of the SSD system at 1-5 Holland Ave is required by Environmental Easement included as Appendix B. Should the system suction point under 7-11 Holland Avenue, located outside the limits of the Environmental Easement, be compromised, removed or damaged, the parties listed in the Brownfield Cleanup Agreement and the Environmental Easement will notify the NYSDEC within 48 hours. The system locations are shown in Figure 11.

Procedures for operating and maintaining the sub-slab depressurization system are documented in the Operation and Maintenance Plan (Section 4 of this SMP). Procedures for monitoring the system are included in the Monitoring Plan (Section 3 of this SMP). The Monitoring Plan also addresses severe condition inspections in the event that a severe condition, which may affect controls at the site, occurs.

2.2.2 Criteria for Completion of Remediation/Termination of Remedial Systems

Generally, remedial processes are considered completed when effectiveness monitoring indicates that the remedy has achieved the remedial action objectives identified by the decision document. The framework for determining when remedial processes are complete is provided in Section 6.6 of NYSDEC DER-10.

2.2.2.1 Composite Cover System

The composite cover system is a permanent control and the quality and integrity of this system will be inspected at defined, regular intervals in perpetuity.

2.2.2.2 Sub-slab Depressurization System (SSDs)

The active SSD system will not be discontinued unless prior written approval is granted by the NYSDEC. In the event that monitoring data indicates that the SSD system is no longer required, a proposal to discontinue the SSD system will be submitted by the property owner to the NYSDEC and NYSDOH.

2.2.2.3 Natural Attenuation with Monitoring

Groundwater monitoring activities to assess the effectiveness of the ISCO treatment and natural attenuation will continue, as determined by the NYSDEC, until residual groundwater concentrations are found to achieve Class GA standards or reach an asymptotic level acceptable to NYSDEC. Monitoring will continue until permission to discontinue is granted in writing by the NYSDEC. If groundwater contaminant levels become asymptotic at a level that is not acceptable to the NYSDEC, additional source removal, treatment and/or control measures (*e.g.*, additional oxidant injections) will be evaluated. For off-site wells, this evaluation would also include evaluation of potential off-site sources of contamination.

2.3 INSTITUTIONAL CONTROLS

A series of Institutional Controls are required by the RAWP and Decision Document to: (1) implement, maintain and monitor Engineering Control systems; (2) prevent future exposure to remaining contamination by controlling disturbances of the subsurface contamination; and, (3) limit the use and development of the site to Commercial and Industrial uses only. Adherence to these Institutional Controls on the site is required by the Environmental Easement and will be implemented under this SMP. These Institutional Controls are:

- Compliance with the Environmental Easement and this SMP by the Grantor and the Grantor's successors and assigns
- All Engineering Controls must be operated and maintained as specified in this SMP
- All Engineering Controls on the Controlled Property must be inspected at a frequency and in a manner defined in the SMP
- Groundwater, soil vapor and other environmental or public health monitoring must be performed as defined in this SMP

- Data and information pertinent to Site Management of the Controlled Property must be reported at the frequency and in a manner defined in this SMP.

Institutional Controls identified in the Environmental Easement may not be discontinued without an amendment to or extinguishment of the Environmental Easement.

The site has a series of Institutional Controls in the form of site restrictions. Adherence to these Institutional Controls is required by the Environmental Easement. Site restrictions that apply to the Controlled Property are:

- The property may only be used for restricted commercial and industrial use provided that the long-term Engineering and Institutional Controls included in this SMP are employed
- The property may not be used for a higher level of use, such as unrestricted, residential or restricted residential use without additional remediation and amendment of the Environmental Easement, as approved by the NYSDEC
- All future activities on the property that will disturb remaining contaminated material must be conducted in accordance with this SMP
- The use of the groundwater underlying the property is prohibited without treatment rendering it safe for intended use
- The potential for vapor intrusion must be evaluated for any new structure on the property, or any horizontal expansion of an existing structure on the property, and any potential impacts that are identified must be monitored or mitigated
- Vegetable gardens and farming on the property are prohibited
- The site owner or remedial party will submit to NYSDEC a written statement that certifies, under penalty of perjury, that: (1) controls employed at the Controlled Property are unchanged from the previous certification or that any changes to the controls were approved by the NYSDEC; and, (2) nothing has occurred that impairs the ability of the controls to protect public health and environment or that constitute a violation or failure to comply with the SMP. NYSDEC retains the right to access such Controlled Property at any time in order to evaluate the continued maintenance of any and all controls. This certification shall be submitted annually, or an alternate period of time that NYSDEC may allow and will be made by an expert that the NYSDEC finds acceptable.

2.3.1 Excavation Work Plan

The site has been remediated for restricted commercial and industrial use. Any future intrusive work that will penetrate the soil cover or cap, or encounter or disturb the remaining contamination, including any modifications or repairs to the existing cover system will be performed in compliance with the EWP that is attached as Appendix C to this SMP. Any work conducted pursuant to the EWP must also be conducted in accordance with the procedures defined in a Health and Safety Plan (HASP) and Community Air Monitoring Plan (CAMP) prepared for the site. A sample HASP is attached as Appendix D to this SMP that is in current compliance with DER-10, and 29 CFR 1910, 29 CFR 1926, and other applicable Federal, State and local regulations. Based on future changes to State and federal health and safety requirements, and specific methods employed by future contractors, the HASP and CAMP will be updated and re-submitted with the notification provided in Section C-1 of the EWP. Any intrusive construction work will be performed in compliance with the EWP, HASP and CAMP, and will be included in the periodic inspection and certification reports submitted under the Site Management Reporting Plan (See Section 5).

The State shall have no liability for actions implemented under the EWP. The site owner and parties performing work under the EWP, are responsible for the safe performance of all intrusive work, the structural integrity of excavations, proper disposal of excavation de-water, control of runoff from open excavations into remaining contamination, and for structures that may be affected by excavations (such as building foundations and bridge footings). The site owner will ensure that site development activities will not interfere with, or otherwise impair or compromise, the engineering controls described in this SMP.

2.3.2 Soil Vapor Intrusion Evaluation

Prior to the construction of any enclosed structures located over areas that contain remaining contamination and the potential for soil vapor intrusion (SVI) has been identified (see Figure 2), an SVI evaluation will be performed to determine whether any mitigation measures are necessary to eliminate potential exposure to vapors in the proposed structure. Alternatively, an SVI mitigation system may be installed as an element of the building foundation without first conducting an investigation. This mitigation system will include a vapor barrier and passive sub-slab depressurization system that is capable of being converted to an active system.

Prior to conducting an SVI investigation or installing a mitigation system, a work plan will be developed and submitted to the NYSDEC and NYSDOH for approval. This work plan will be developed in accordance with the most recent NYSDOH “Guidance for Evaluating Vapor Intrusion in the State of New York”. Measures to be employed to mitigate potential vapor intrusion will be evaluated, selected, designed, installed, and maintained based on the SVI evaluation, the NYSDOH guidance, and construction details of the proposed structure.

Preliminary (unvalidated) SVI sampling data will be forwarded to the NYSDEC and NYSDOH for initial review and interpretation. Upon validation, the final data will be transmitted to the agencies, along with a recommendation for follow-up action, such as mitigation. Validated SVI data will be transmitted to the applicable property owner within 30 days of validation. If any indoor air test results exceed NYSDOH guidelines, relevant NYSDOH fact sheets will be provided to all tenants and occupants of the property within 15 days of receipt of validated data.

SVI sampling results, evaluations, and follow-up actions will also be summarized in the next Periodic Review Report.

2.4 INSPECTIONS AND NOTIFICATIONS

2.4.1 Inspections

Inspections of all remedial components installed at the site will be conducted at the frequency specified in the SMP Monitoring Plan schedule. A comprehensive site-wide inspection will be conducted annually, regardless of the frequency of the Periodic Review Report. The inspections will determine and document the following:

- Whether Engineering Controls continue to perform as designed
- If these controls continue to be protective of human health and the environment
- Compliance with requirements of this SMP and the Environmental Easement
- Achievement of remedial performance criteria
- Sampling and analysis of appropriate media during monitoring events

- If site records are complete and up to date
- Changes, or needed changes, to the remedial or monitoring system.

Inspections will be conducted in accordance with the procedures set forth in the Monitoring Plan of this SMP (Section 3). The reporting requirements are outlined in the Periodic Review Reporting section of this plan (Section 5).

If an emergency, such as a natural disaster or an unforeseen failure of any of the ECs occurs, an inspection of the site will be conducted within 5 days of the event to verify the effectiveness of the EC/ICs implemented at the site by a qualified environmental professional as determined by NYSDEC.

2.4.2 Notifications

Notifications will be submitted by the property owner to the NYSDEC as needed for the following reasons:

- 60-day advance notice of any proposed changes in site use that are required under the terms of the BCA, 6 NYCRR Part 375, and/or Environmental Conservation Law
- 7-day advance notice of any proposed ground-intrusive activities pursuant to the Excavation Work Plan
- Notice within 48-hours of any damage or defect to the foundation, structures or engineering control that reduces or has the potential to reduce the effectiveness of an Engineering Control and likewise any action to be taken to mitigate the damage or defect (This notification includes the alteration, damage, and removal of the VI suction point at 7-11 Holland Avenue, which is outside the environmental easement boundary.)
- Verbal notice by noon of the following day of any emergency, such as a fire, flood, or earthquake that reduces or has the potential to reduce the effectiveness of Engineering Controls in place at the site, with written confirmation within 7 days that includes a summary of actions taken, or to be taken, and the potential impact to the environment and the public
- Follow-up status reports on actions taken to respond to any emergency event requiring ongoing responsive action shall be submitted to the NYSDEC within 45 days and shall describe and document actions taken to restore the effectiveness of the ECs.

Any change in the ownership of the site or the responsibility for implementing this SMP will include the following notifications:

- At least 60 days prior to the change, the NYSDEC will be notified in writing of the proposed change. This will include a certification that the prospective purchaser has been provided with a copy of the BCA and all approved work plans and reports, including this SMP
- Within 15 days after the transfer of all or part of the site, the new owner's name, contact representative, and contact information will be confirmed in writing.

2.5 CONTINGENCY PLAN

Emergencies may include injury to personnel, fire or explosion, environmental release, or serious weather conditions.

2.5.1 Emergency Telephone Numbers

In the event of any environmentally related situation or unplanned occurrence requiring assistance the Owner or Owner's representative(s) should contact the appropriate party from the contact list below. For

emergencies, appropriate emergency response personnel should be contacted. Prompt contact should also be made to a qualified environmental professional. These emergency contact lists must be maintained in an easily accessible location at the site.

Table 6: Emergency Contact Numbers

Medical, Fire, and Police:	911
Dig Safely New York:	(800) 962-7962 or 811 (3 day notice required for utility markout)
Poison Control Center:	(800) 222-1222
Pollution Toxic Chemical Oil Spills:	(800) 424-8802
NYSDEC Spills Hotline	(800) 457-7362

Table 7: Contact Numbers

Qualified Environmental Professional O'Brien & Gere Engineers, Inc. Mark Randazzo, CHMM, CPG, CSP	(781) 883-6432 (914) 345-1616, ext. 13
Primary and Emergency Property Owner Contact 1 Holland LLC Thomas Attonito	(914) 949-9075
Secondary Property Owner Contact 1 Holland LLC Dino Tomassetti	(917) 335-4115
NYSDEC Contact Kiera Thompson Engineering Geologist	(518) 402-9662

* Note: Contact numbers subject to change and should be updated as necessary

2.5.2 Map and Directions to Nearest Health Facility

Site Location: 1-5 Holland Ave
 Nearest Hospital Name: White Plains Hospital
 Hospital Location: 41 East Post Road, White Plains, NY 10601
 Hospital Telephone: 914-681-0600 (Main)

Directions to the Hospital:

- 1. Head East on Holland Ave to North Broadway
- 2. Take 1st Right onto North Broadway
- 3. Continue 1.4 miles on East Post Road
- 4. Hospital 0.5 Miles on Right

Total Distance: 2.0 Miles

Total Estimated Time: 6 Minutes

Figure 12 - Map Showing Route from the site to the Hospital:

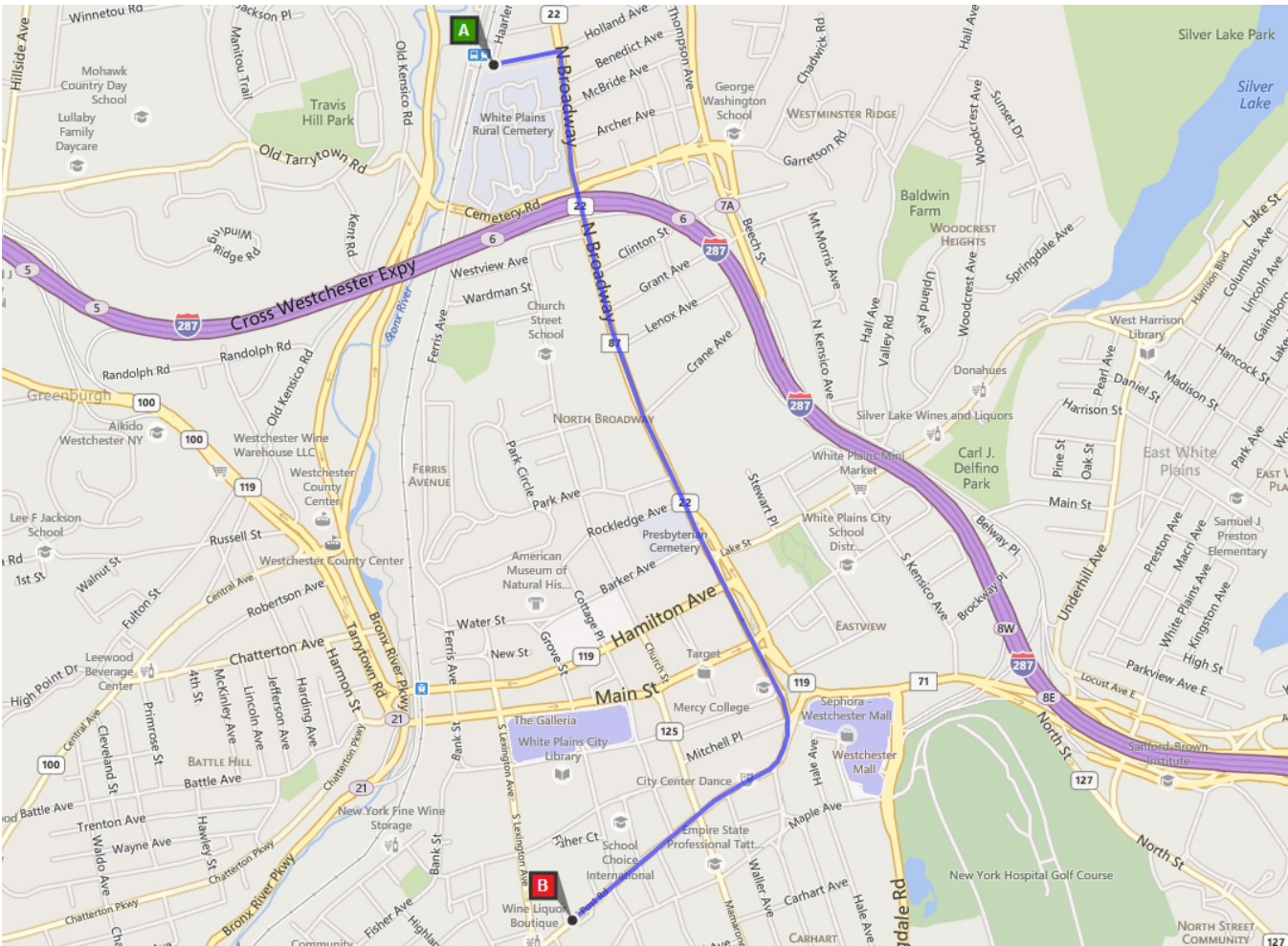

2.5.3 Response Procedures

As appropriate, the fire department and other emergency response group will be notified immediately by telephone of the emergency. The emergency telephone number list is found at the beginning of this Contingency Plan (Tables 6 and 7). The list will also be posted prominently at the site and made readily available to all personnel at all times.

3.0 SITE MONITORING PLAN

3.1 INTRODUCTION

3.1.1 General

The Monitoring Plan describes the measures for evaluating the performance and effectiveness of the remedy to reduce or mitigate contamination at the site, the soil cover system, and all affected site media identified below. Monitoring of other Engineering Controls is described in Chapter 4, Operation, Monitoring and Maintenance (OM&M) Plan. This Monitoring Plan may only be revised with the approval of NYSDEC.

3.1.2 Purpose and Schedule

This Monitoring Plan describes the methods to be used for:

- Sampling and analysis of all appropriate media (*e.g.*, groundwater, indoor air, soil vapor, soils)
- Assessing compliance with applicable NYSDEC standards, criteria and guidance, particularly ambient groundwater standards and Part 375 SCOs for soil
- Assessing achievement of the remedial performance criteria
- Evaluating site information periodically to confirm that the remedy continues to be effective in protecting public health and the environment
- Preparing the necessary reports for the various monitoring activities.

To adequately address these issues, this Monitoring Plan provides information on:

- Sampling locations, protocol, and frequency
- Information on all designed monitoring systems (*e.g.*, well logs)
- Analytical sampling program requirements
- Reporting requirements
- Quality Assurance/Quality Control (QA/QC) requirements
- Inspection and maintenance requirements for monitoring wells
- Monitoring well decommissioning procedures
- Annual inspection and periodic certification.

Semi-annual (groundwater) and annual (existing SSDS and cover systems) monitoring of the performance of the remedy and overall reduction in contamination on-site and off-site will be conducted for the first 30 years. One round of soil vapor intrusion sampling will be conducted during each of the first two heating seasons. The frequency thereafter will be determined by NYSDEC. Trends in contaminant levels in air, soil, and/or groundwater in the affected areas, will be evaluated to determine if the remedy continues to be effective in achieving remedial goals. Monitoring programs are summarized in Table 8 and outlined in detail in Sections 3.2 and 3.3 below. Groundwater monitoring frequency may be re-evaluated following the third year of semi-annual sampling by request to NYSDEC.

Discontinuation of systems in accordance with this Plan shall also alleviate the Owner from the associated monitoring/inspection whether or not this Plan is explicitly revised.

Table 8: Monitoring/Inspection Schedule

Monitoring Program	Frequency*	Matrix	Analysis
Groundwater-On-site	Year 1-30: Semi-annual (minimum 3 years)	Groundwater	Volatile Organic Compounds by USEPA Method 8260
Groundwater-Off-site	Year 1-30 Semi-annual (minimum 3 years)	Groundwater	Volatile Organic Compounds by USEPA Method 8260
SSDS	Annual (1 and 7-11 Holland)	Full System Check	Not Applicable
Cover System	Annual	Visual Inspection	Not Applicable

* The frequency of events will be conducted as specified until otherwise approved by NYSDEC and NYSDOH.

3.2 COVER SYSTEM MONITORING

Soil cover monitoring is addressed separately from the other engineering controls in this SMP, because it is a passive component of the site remedy. A site cover currently exists and will be maintained to allow for commercial and industrial use of the site. The existing cover comprises building foundation slabs, asphalt parking areas, concrete walkways and gravel and soil covers, as shown in Figure 13. These features will be inspected annually and/or when suspected failure or breach is noted to have occurred. Monitoring information will be submitted with the annual site-wide inspection form as described in Section 3.6. Inspection frequency is subject to change with the approval of the NYSDEC.

Maintenance of the cover system is included as part of the Excavation Work Plan included as Appendix C.

3.3 MEDIA MONITORING PROGRAM

3.3.1 Groundwater Monitoring

Groundwater monitoring will be performed on a periodic basis to assess the performance of the interim remedial measure and the natural attenuation remedy. Specifically, the purpose of the groundwater monitoring is to evaluate concentrations of groundwater constituents that exceed Class GA standards, primarily PCE and associated degradation products, and to monitor their continued attenuation. Effectiveness of the interim remedial measure and natural attenuation will be evaluated as continued reductions in groundwater concentrations result either in attainment of Class GA groundwater standards for PCE and its degradation products or demonstration of asymptotic concentrations of these compounds at a level acceptable to the NYSDEC. Should the monitoring data indicate that the groundwater concentrations are not attaining Class GA groundwater standards or asymptotic levels acceptable to the Department, the data will be the basis for:

- Development and implementation of additional ISCO injections, or evaluation of alternative remedial technologies should the injections be ineffective or unsatisfactory to the Department, and
- Evaluation and implementation of a contingency remedial action should natural attenuation not be effective.

Should the need for additional injections, alternative remedial technologies or a contingency remedial action arise, a plan would be developed and presented to NYSDEC for review.

The network of monitoring wells has been installed to monitor both up-gradient and down-gradient groundwater conditions at the site. The network of on-site and off-site wells has been designed to evaluate groundwater conditions in-both the overburden and bedrock. On-site and off-site wells to be sampled are shown on Figure 14. Monitoring well construction logs are included in Appendix E.

On-site groundwater will be monitored, for volatile organic constituent concentrations as follows:

- Groundwater will be analyzed from wells MW-1, MW-2, MW-2SB, MW-2DB, MW-4S, MW-4D, MW-5, MW-5SB, and MW-5DB
- Semi-Annual sampling events will be conducted during the spring and fall of each year
- Laboratory analysis of samples will be by USEPA SW846 Method 8260
- The purpose of the groundwater monitoring is to evaluate concentrations of groundwater constituents that exceed Class GA standards, primarily PCE and associated degradation products.

Off-site groundwater will be monitored for volatile organic constituent concentrations as follows:

- Groundwater will be analyzed from wells MW-6 and MW-6SB (upgradient), MW-7, MW-7SB, MW-8, MW-8SB, MW-9, and MW-9SB
- Semi-Annual sampling events will be conducted during the spring and fall of each year
- Laboratory analysis of samples will be by USEPA SW846 Method 8260
- Monitoring of off-site wells will be contingent upon physical and legal access to the wells.

The sampling frequency may be modified with the approval of NYSDEC. The SMP will be modified to reflect changes in sampling plans approved by NYSDEC. Monitoring will continue for a period totaling 30 years, or until permission to modify or discontinue sampling is granted in writing by NYSDEC, whichever is sooner. A minimum of 3 years semi-annual sampling will be conducted before any requests to modify scope, frequency, or duration can be made to NYSDEC.

Deliverables for the groundwater monitoring program are specified below.

3.3.1.1 Sampling Protocol

All monitoring well sampling activities will be conducted in accordance with the Field Activities Plan contained in Appendix F will be recorded in a field book and a groundwater-sampling log presented in Appendix G. Other observations (*e.g.*, well integrity, etc.) will be noted on the well sampling log. The well sampling log will serve as the inspection form for the groundwater monitoring well network.

3.3.1.2 Monitoring Well Repairs, Replacement and Decommissioning

If biofouling or silt accumulation occurs in the on-site and/or off-site monitoring wells, the wells will be physically agitated/surged and redeveloped. Additionally, monitoring wells will be properly decommissioned and replaced as described in the Field Activities Plan (FAP) contained in Appendix F if an event renders the wells unusable.

Repairs and/or replacement of wells in the monitoring well network will be performed based on assessments of structural integrity and overall performance.

The NYSDEC will be notified prior to any repair or decommissioning of monitoring wells for the purpose of replacement, and the repair or decommissioning and replacement process will be documented in the subsequent periodic report. Well decommissioning without replacement will be done only with the prior approval of NYSDEC. Well abandonment will be performed in accordance with NYSDEC's "CP-43: Groundwater Monitoring Well Decommissioning Policy." Monitoring wells that are decommissioned because they have been rendered unusable will be reinstalled in the nearest available location, unless otherwise approved by the NYSDEC.

3.4 SITE-WIDE INSPECTION

Site-wide inspections will be performed on a regular schedule at a minimum of once a year. Site-wide inspections will also be performed after all severe weather conditions that may affect Engineering Controls or monitoring devices. During these inspections, an inspection form will be completed (Appendix H). The form will compile sufficient information to assess the following:

- Compliance with all ICs, including site usage
- An evaluation of the condition and continued effectiveness of ECs, including the soil vapor suction point under 7-11 Holland Avenue
- General site conditions at the time of the inspection
- The site management activities being conducted including, where appropriate, confirmation sampling and a health and safety inspection
- Compliance with permits maintenance, sampling and inspection schedules included in the OM&M Plan
- Confirm that site records are up to date.

3.5 MONITORING QUALITY ASSURANCE/QUALITY CONTROL

All sampling and analyses will be performed in accordance with the requirements of the Quality Assurance Project Plan (QCD) prepared for the site (Appendix I). Main Components of the QAPP include:

- QA/QC Objectives for Data Measurement
- Sampling Program:
 - » Sample containers will be properly washed, decontaminated, and appropriate preservative will be added (if applicable) prior to their use by the analytical laboratory. Containers with preservative will be tagged as such
 - » Sample holding times will be in accordance with the NYSDEC ASP requirements
 - » Field QC samples (*e.g.*, trip blanks, coded field duplicates, and matrix spike/matrix spike duplicates) will be collected as necessary
- Sample Tracking and Custody
- Calibration Procedures:
 - » All field analytical equipment will be calibrated immediately prior to each day's use. Calibration procedures will conform to manufacturer's standard instructions

» The laboratory will follow all calibration procedures and schedules as specified in USEPA SW-846 and subsequent updates that apply to the instruments used for the analytical methods

- Analytical Procedures
- Preparation of a Data Usability Summary Report (DUSR), which will present the results of data validation, including a summary assessment of laboratory data packages, sample preservation and chain of custody procedures, and a summary assessment of precision, accuracy, representativeness, comparability, and completeness for each analytical method
- Internal QC and Checks
- QA Performance and System Audits
- Preventative Maintenance Procedures and Schedules
- Corrective Action Measures.

3.6 MONITORING REPORTING REQUIREMENTS

Forms and any other information generated during regular monitoring events and inspections will be kept on file on-site. All forms, and other relevant reporting formats used during the monitoring/inspection events: (1) will be subject to approval by NYSDEC, (2) submitted at the time of the Periodic Review Report, as specified in the Reporting Plan of this SMP, and (3) include an evaluation of site information to confirm that the remedy continues to be effective for protection of human health and the environment. All monitoring results will be reported to NYSDEC and NYSDOH as they are generated subsequent to each sampling event. The report (or letter) will include, at a minimum:

- Date of event
- Personnel conducting sampling
- Description of the activities performed
- Type of samples collected (*e.g.*, groundwater)
- Copies of all field forms completed (*e.g.*, well sampling logs, chain-of-custody documentation, inspection forms, *etc.*)
- Sampling results in comparison to appropriate standards/criteria
- A figure illustrating sample type and sampling locations
- Copies of all laboratory data sheets and the required laboratory data deliverables required for all points sampled (or be submitted electronically in the NYSDEC-identified format)
- Any observations, conclusions, or recommendations
- A determination as to whether groundwater conditions have changed since the last reporting event
- An evaluation of site information to confirm that the remedy continues to be effective for protection of human health and the environment.

Data will be reported in hard copy or digital format as determined by NYSDEC. A summary of the monitoring program deliverables are summarized below.

Table 9. Schedule of Monitoring/Inspection Reports

* The frequency of events will be conducted as specified until otherwise approved by NYSDEC

Task	Reporting Frequency*
Periodic Review Report	Annual (Starting 15 months after issuance of Certificate of Completion.)
Groundwater Data Transmittal	30 days from data being validated

4.0 OPERATION, MAINTENANCE AND MONITORING (OM&M) PLAN

4.1 INTRODUCTION

This OM&M Plan describes the measures necessary to operate, monitor and maintain the mechanical components of the remedy selected for the site. This OM&M Plan includes:

- Includes the steps necessary to allow individuals unfamiliar with the site to operate and maintain the SSD systems
- Includes an operation and maintenance manual
- Will be updated periodically to reflect changes in site conditions or the manner in which the SSD systems are operated and maintained.

Information on non-mechanical Engineering Controls (*i.e.*, soil cover system) is provided in Section 23 - Engineering and Institutional Control Plan. A copy of this OM&M Plan, along with the complete SMP, will be kept at the site. This OM&M Plan is not to be used as a stand-alone document, but as a component document of the SMP.

4.2 ENGINEERING CONTROL SYSTEM OPERATION AND MAINTENANCE

Instructions for operation and maintenance of the SSD systems are contained in the OM&M Manual included as Appendix J. This Manual contains the following:

- EC As-Built Drawings
- EC System Component Cut-Sheets
- EC Inspection Checklist
- Required Inspection and Non-Routine Maintenance.

Five separate SSD systems were installed in April 2009 and February 2013. Each system comprises a fan, PVC piping, manometer for vacuum readings, and an audible alarm system to indicate a system malfunction.

If, in the course of the SSD system lifetime, significant changes are made to the system that entail replacement of existing fans or installation of new systems, sub-slab communication testing of vacuum measurements as described in Appendix J and manufacturers' start-up procedures will be followed.

4.3 ENGINEERING CONTROL SYSTEM PERFORMANCE MONITORING

Sub-slab depressurization systems have been installed to mitigate the potential for soil vapor intrusion into occupied buildings. Performance monitoring of these systems is described in Appendix J.

4.3.1 Monitoring Schedule

Inspection frequency is subject to change with the approval of the NYSDEC. Unscheduled inspections and/or sampling may take place when a suspected failure of the SSD system - whether of the system components or the integrity of the building slab - has been reported or an emergency occurs that is deemed likely to affect the operation of the system. Monitoring deliverables for the SSD system are specified later in this Plan.

4.3.2 General Equipment Monitoring

A visual inspection of the complete system will be conducted during the monitoring event. SSD system components to be monitored include, but are not limited to, the following:

- vacuum blower and piping
- slabs and walls.

A complete list of components to be checked is provided in the Inspection Checklist, presented in Appendix J. If any equipment readings are not within their typical range, any equipment is observed to be malfunctioning, or the system is not performing within specifications, maintenance and repair as per the OM&M Plan are required immediately, and the SSD system is to be restarted.

4.3.3 System Monitoring Devices and Alarms

Each SSD system has an audible warning device to indicate that the system is not operating properly. In the event that the warning device is activated, applicable maintenance and repairs will be conducted, as specified in the OM&M Manual, and the SSD system will be restarted. The system suction points are also equipped with U-tube manometers; however, most of these manometers are no longer visible as a result of recent renovation activities (encased behind walls). Operational problems will be noted in the subsequent Periodic Review Report.

4.4 MAINTENANCE AND PERFORMANCE MONITORING REPORTING REQUIREMENTS

Maintenance reports and any other information generated during regular operations at the site will be kept on-file on-site. All reports, forms, and other relevant information generated will be available upon request to the NYSDEC and submitted as part of the Periodic Review Report, as specified in Section 5 of this SMP.

4.4.1 Routine Maintenance Reports

Checklists or forms (see Appendix J) will be completed during each routine maintenance event. Checklists/forms will include, but not be limited to the following information:

- Date
- Name, company, and position of person(s) conducting maintenance activities
- Maintenance activities conducted
- Any modifications to the system
- Summary of operation and maintenance activities necessary for the continued operation of the components of the remedy, including the provision for evaluation of the systems and recommendations to optimize performance.
- Where appropriate, color photographs or sketches showing the approximate location of any problems or incidents noted (included either on the checklist/form or on an attached sheet)
- Other documentation such as copies of invoices for maintenance work, receipts for replacement equipment, *etc.*, (attached to the checklist/form).

4.4.2 Non-Routine Maintenance Reports

During each non-routine maintenance event, a form will be completed which will include, but not be limited to, the following information:

- Date
- Name, company, and position of person(s) conducting non-routine maintenance/repair activities
- Presence of leaks
- Date of leak repair
- Other repairs or adjustments made to the system
- Where appropriate, color photographs or sketches showing the approximate location of any problems or incidents (included either on the form or on an attached sheet)
- Other documentation such as copies of invoices for repair work, receipts for replacement equipment, *etc.* (attached to the checklist/form).

5.0 INSPECTIONS, REPORTING AND CERTIFICATIONS

5.1 SITE INSPECTIONS

5.1.1 Inspection Frequency

All inspections will be conducted at the frequency specified in the schedules provided in Section 3 Monitoring Plan and Section 4 OM&M Plan of this SMP. At a minimum, a site-wide inspection will be conducted annually. Inspections of remedial components will also be conducted when a breakdown of any treatment system component has occurred or whenever a severe condition has taken place, such as an erosion or flooding event that may affect the ECs.

5.1.2 Inspection Forms, Sampling Data, and Maintenance Reports

All inspections and monitoring events will be recorded on the appropriate forms which are contained in Appendices I (SSD system). Additionally, a general site-wide inspection form will be completed during the site-wide inspection (see Appendix H). These forms are subject to NYSDEC revision.

All applicable inspection forms and other records, including all media sampling data and system maintenance reports, generated for the site during the reporting period will be provided in electronic format in the Periodic Review Report.

5.1.3 Evaluation of Records and Reporting

The results of the inspection and site monitoring data will be evaluated as part of the EC/IC certification to confirm that the:

- EC/ICs are in place, are performing properly, and remain effective
- The Monitoring Plan is being implemented
- Operation and maintenance activities are being conducted properly; and, based on the above items
- The site remedy continues to be protective of public health and the environment and is performing as designed in the RAWP and FER.

5.2 CERTIFICATION OF ENGINEERING AND INSTITUTIONAL CONTROLS

After the last inspection of the reporting period, a Professional Engineer licensed to practice in New York State will prepare the following certification:

For each institutional or engineering control identified for the site, I certify that all of the following statements are true:

- The inspection of the site to confirm the effectiveness of the institutional and engineering controls required by the remedial program was performed under my direction
- The institutional control and/or engineering control employed at this site is unchanged from the date the control was put in place, or last approved by the Department
- Nothing has occurred that would impair the ability of the control to protect the public health and environment
- Nothing has occurred that would constitute a violation or failure to comply with any site management plan for this control
- Access to the site will continue to be provided to the Department to evaluate the remedy, including access to evaluate the continued maintenance of this control

- If a financial assurance mechanism is required under the oversight document for the site, the mechanism remains valid and sufficient for the intended purpose under the document
- Use of the site is compliant with the environmental easement
- The engineering control systems are performing as designed and are effective
- To the best of my knowledge and belief, the work and conclusions described in this certification are in accordance with the requirements of the site remedial program and generally accepted engineering practices
- The information presented in this report is accurate and complete
- I certify that all information and statements in this certification form are true. I understand that a false statement made herein is punishable as a Class “A” misdemeanor, pursuant to Section 210.45 of the Penal Law. I, [name], of [business address], am certifying as [Owner or Owner’s Designated Site Representative] for the site.

The signed certification will be included in the Periodic Review Report described below.

For each institutional control identified for the site, I certify that all of the following statements are true:

- The institutional control employed at this site is unchanged from the date the control was put in place, or last approved by the Department
- Nothing has occurred that would impair the ability of the control to protect the public health and environment
- Nothing has occurred that would constitute a violation or failure to comply with any site management plan for this control
- Access to the site will continue to be provided to the Department to evaluate the remedy, including access to evaluate the continued maintenance of this control
- If a financial assurance mechanism is required under the oversight document for the site, the mechanism remains valid and sufficient for the intended purpose under the document
- Use of the site is compliant with the environmental easement
- The information presented in this report is accurate and complete
- I certify that all information and statements in this certification form are true. I understand that a false statement made herein is punishable as a Class “A” misdemeanor, pursuant to Section 210.45 of the Penal Law. I, [name], of [business address], am certifying as [Owner or Owner’s Designated Site Representative] for the site
- No new information has come to my attention, including groundwater monitoring data from wells located at the site boundary, if any, to indicate that the assumptions made in the qualitative exposure assessment of off-site contamination are no longer valid.

Every five years the following certification will be added:

- The assumptions made in the qualitative exposure assessment remain valid.

The signed certification will be included in the Periodic Review Report described below.

5.3 PERIODIC REVIEW REPORT

A Periodic Review Report will be submitted to the Department every year, beginning fifteen months after the Certificate of Completion is issued. In the event that the site is subdivided into separate parcels with different ownership, a single Periodic Review Report will be prepared that addresses the site described in Appendix B (Environmental Easement which includes the Metes and Bounds). The report will be prepared in accordance with NYSDEC DER-10 and submitted within 30 days of the end of each certification period. Media sampling results will also be incorporated into the Periodic Review Report.

The report will include:

- Identification, assessment and certification of all ECs/ICs required by the remedy for the site
- Results of the required annual site inspections and severe condition inspections, if applicable
- All applicable inspection forms and other records generated for the site during the reporting period in electronic format
- A summary of any discharge monitoring data and/or information generated during the reporting period with comments and conclusions
- Data summary tables and graphical representations of contaminants, which include a listing of all compounds analyzed, along with the applicable standards, with all exceedances highlighted. These will include a presentation of past data as part of an evaluation of contaminant concentration trends
- Results of all analyses, copies of all laboratory data sheets, and the required laboratory data deliverables for all samples collected during the reporting period will be submitted electronically in a NYSDEC-approved format.
- A site evaluation, which includes the following:
 - » The compliance of the remedy with the requirements of the site-specific RAWP, ROD or Decision Document
 - » The operation and the effectiveness of all treatment units, *etc.*, including identification of any needed repairs or modifications
 - » Any new conclusions or observations regarding site contamination based on inspections or data generated by the Monitoring Plan for the media being monitored
 - » Recommendations regarding any necessary changes to the remedy and/or Monitoring Plan
 - » The overall performance and effectiveness of the remedy.

The Periodic Review Report will be submitted, in hard-copy format, to the NYSDEC Central Office and Regional Office in which the site is located, and in electronic format to NYSDEC Central Office, Regional Office and the NYSDOH Bureau of Environmental Exposure Investigation.

Should site conditions indicate that annual submittals of PRRs are no longer needed, a letter will be issued to the NYSDEC requesting alternate submittal and certification periods, but only after three certification periods.

5.4 CORRECTIVE MEASURES PLAN

If any component of the remedy is found to have failed, or if the periodic certification cannot be provided due to the failure of an institutional or engineering control, a corrective measures plan will be submitted to the NYSDEC for approval. This plan will explain the failure and provide the details and

schedule for performing work necessary to correct the failure. Unless an emergency condition exists, no work will be performed pursuant to the corrective measures plan until it is approved by the NYSDEC.

REFERENCES

- Frink, N.A. 2013. Email: *RE: OHAD - Question on 1-5 Holland Ave Site*. Becker, K.A. New York State Department of Environmental Conservation, December 6, 2013.
- Becker, K.A. 2014. Email: *RE: BCP No. 360115 - Soil Sampling Front Flower Bed*. Randazzo, M.A. O'Brien & Gere Engineers, Inc., January 7, 2014.
- NYSDEC. 2010. *DER-10 Technical Guidance for Site Investigation and Remediation*.
- NYSDOH. 2006. *Guidance for Evaluating Soil Vapor Intrusion in the State of New York*.
- O'Brien & Gere 2014a. *Remedial Investigation Report, BCP No. C360115, 1-5 Holland Avenue, White Plains, New York*. April 2014.
- O'Brien & Gere. 2014b. *Interim Remedial Measure Construction Completion Report. BCP No. C360115, 1-5 Holland Avenue, White Plains, New York*. August 8, 2014.
- O'Brien & Gere. 2013. *Interim Remedial Measure Work Plan, BCP No. C360115, 1-5 Holland Avenue, White Plains, New York*. June 20, 2013.
- Thompson, K.A. 2014. Letter: *Draft Site Management Plan, 1-5 Holland Avenue, Brownfield Cleanup Program, Site No. C360115, City of White Plains, Westchester County*. October 22, 2014.

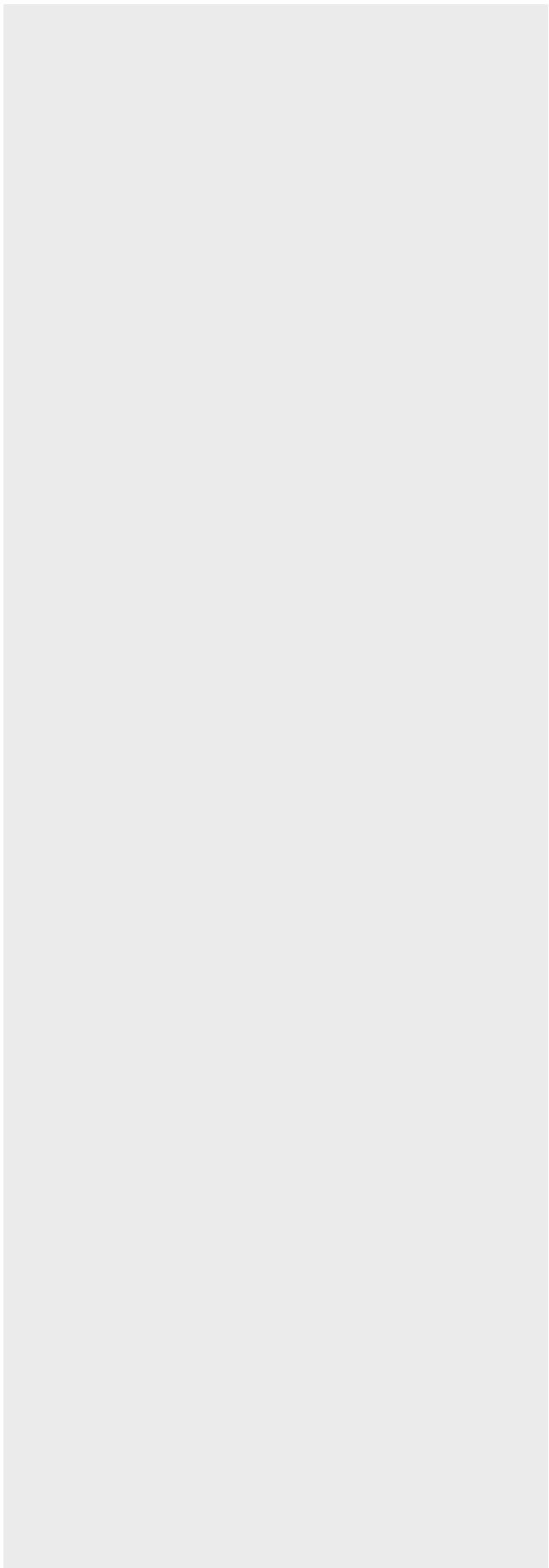

Table 1a
Surface Soil Sampling - VOC Data Summary

Remedial Investigation
Brownfield Cleanup Program No. C360115
1-5 Holland Ave
White Plains, NY

Parameter (mg/kg or ppm)	Part 375 Unrestricted ¹	Part 375 Restricted Commercial ²	Part 375 Protection of Groundwater ³	Location ID:	SS12-1	BD-SS12	SS12-2	SS12-3	SS12-4
				Sample Interval (ft bgs):	0-0.5	SS12-1	0-0.5	0-0.5	0-0.5
				Date Sampled:	5/2/2012	5/2/2012	5/2/2012	5/2/2012	5/2/2012
VOLATILE ORGANIC COMPOUNDS (VOCs)									
1,1,1-Trichloroethane	0.68	500	0.68		<0.00018	<0.000161	<0.000213	<0.00026	<0.000185
1,1,2,2-Tetrachloroethane	NS	NS	NS		<0.00018	<0.000161	<0.000213	<0.00026	<0.000185
1,1,2-Trichloro-1,2,2-trifluoroethane	NS	NS	NS		<0.000451	<0.000402	<0.000534	<0.000649	<0.000462
1,1,2-Trichloroethane	NC	NS	NS		<0.00018	<0.000161	<0.000213	<0.00026	<0.000185
1,1-Dichloroethane	0.27	240	0.27		<0.000172	<0.000153	<0.000204	<0.000248	<0.000176
1,1-Dichloroethene	0.33	500	0.33		<0.000287	<0.000256	<0.00034	<0.000413	<0.000294
1,2,3-Trichlorobenzene	NS	NS	NS		<0.000238	<0.000212	<0.000281	<0.000342	<0.000244
1,2,4-Trichlorobenzene	NS	NS	NS		<0.000246	<0.000219	<0.000291	<0.000354	<0.000252
1,2-Dibromo-3-chloropropane	NS	NS	NS		<0.000394	<0.00035	<0.000466	<0.000566	<0.000403
1,2-Dibromoethane (EDB)	NS	NS	NS		<0.000164	<0.000146	<0.000194	<0.000236	<0.000168
1,2-Dichlorobenzene	1.1	500	1.1		<0.00018	<0.000161	<0.000213	<0.00026	<0.000185
1,2-Dichloroethane (EDC)	0.02	30	0.02		<0.000164	<0.000146	<0.000194	<0.000236 UJ	<0.000168
1,2-Dichloropropane	NS	NS	NS		<0.000164	<0.000146	<0.000194	<0.000236	<0.000168
1,3-Dichlorobenzene	2.4	280	2.4		<0.000172	<0.000153	<0.000204	<0.000248	<0.000176
1,4-Dichlorobenzene	1.8	130	1.8		<0.000172	<0.000153	<0.000204	<0.000248	<0.000176
2-Butanone (MEK)	0.12	500	0.12		<0.000394	<0.00035	<0.000466	<0.000566	<0.000403
2-Hexanone	NS	NS	NS		<0.000189	<0.000168	<0.000223	<0.000271	<0.000193
4-Methyl-2-pentanone (MIBK)	NS	NS	NS		<0.000205	<0.000183	<0.000243	<0.000295	<0.00021
Acetone	0.05	500	0.05		<0.000517	<0.00046	<0.000611	<0.000743	<0.000529
Benzene	0.06	44	0.06		<0.000172	<0.000153	<0.000204	<0.000248	<0.000176
Bromochloromethane	NS	NS	NS		<0.000197	<0.000175	<0.000233	<0.000283	<0.000202
Bromodichloromethane	NS	NS	NS		<0.000197	<0.000175	<0.000233	<0.000283	<0.000202
Bromoform	NS	NS	NS		<0.000172	<0.000153	<0.000204	<0.000248	<0.000176
Bromomethane	NS	NS	NS		<0.000476	<0.000423	<0.000563	<0.000684	<0.000487
Carbon disulfide	NS	NS	NS		<0.000435	<0.000387	<0.000514	<0.000625	<0.000445
Carbon tetrachloride	0.76	22	0.76		<0.000221	<0.000197	<0.000262	<0.000319	<0.000227

Notes:

ft bgs = feet below ground surface

Bold - Exceeds 6 NYCRR Part 375 Protection of Groundwater

Shaded - Exceeds 6 NYCRR Part 375 Unrestricted and Corresponding CP-51 Soil Cleanup Objectives

Shaded - Exceeds 6 NYCRR Part 375 Commercial

UJ = The concentration was approximate and detected at a value below the Reporting Limit (RL) and above the MDL

units = mg/kg or parts per million (ppm)

NS = No Standard

¹ 6 NYCRR Part 375, Table 375-6.8(a): Unrestricted Use Soil Cleanup Objectives, December 14, 2006.

² 6 NYCRR Part 375, Table 375-6.8(b): Restricted Use Soil Cleanup Objectives, Protection of Public Health, Commercial, December 14, 2006.

³ 6 NYCRR Part 375, Table 375-6.8(b): Restricted Use Soil Cleanup Objectives, Protection of Public Health, Protection of Groundwater, December 14, 2006.

Table 1a
Surface Soil Sampling - VOC Data Summary

Remedial Investigation
Brownfield Cleanup Program No. C360115
1-5 Holland Ave
White Plains, NY

Parameter (mg/kg or ppm)	Part 375 Unrestricted ¹	Part 375 Restricted Commercial ²	Part 375 Protection of Groundwater ³	Location ID:	SS12-1	BD-SS12	SS12-2	SS12-3	SS12-4
				Sample Interval (ft bgs):	0-0.5	SS12-1	0-0.5	0-0.5	0-0.5
				Date Sampled:	5/2/2012	5/2/2012	5/2/2012	5/2/2012	5/2/2012
VOLATILE ORGANIC COMPOUNDS (VOCs)									
Chlorobenzene	1.1	500	1.1		<0.000172	<0.000153	<0.000204	<0.000248	<0.000176
Chloroethane	NS	NS	NS		<0.0005	<0.000445	<0.000592	<0.00072	<0.000512
Chloroform	0.37	350	0.37		<0.000172	<0.000153	<0.000204	<0.000248	<0.000176
Chloromethane	NS	NS	NS		<0.000312	<0.000277	<0.000369	<0.000448 UJ	<0.000319
cis-1,2-Dichloroethene	0.25	500	0.25		<0.000205	<0.000183	<0.000243	<0.000295	<0.00021
cis-1,3-Dichloropropene	NS	NS	NS		<0.00018	<0.000161	<0.000213	<0.00026	<0.000185
Cyclohexane	NS	NS	NS		<0.000344	<0.000307	<0.000407	<0.000496	<0.000353
Dibromochloromethane	NS	NS	NS		<0.000172	<0.000153	<0.000204	<0.000248	<0.000176
Dichlorodifluoromethane	NS	NS	NS		<0.000221	<0.000197	<0.000262	<0.000319	<0.000227
Ethylbenzene	1	390	1		<0.000197	<0.000175	<0.000233	<0.000283	<0.000202
Isopropylbenzene	NS	NS	NS		<0.000189	<0.000168	<0.000223	<0.000271	<0.000193
Methyl acetate	NS	NS	NS		<0.000476	<0.000423	<0.000563	<0.000684 UJ	<0.000487
Methyl tert-butyl ether (MTBE)	0.93	500	0.93		<0.000172	<0.000153	<0.000204	<0.000248	<0.000176
Methylcyclohexane	NS	NS	NS		<0.00041	<0.000365	<0.000485	<0.00059	<0.00042
Methylene chloride	0.05	500	0.05		<0.00159	<0.00139	<0.00192	<0.00234	<0.0016
Styrene	NS	NS	NS		<0.000189	<0.000168	<0.000223	<0.000271	<0.000193
Tetrachloroethene	1.3	150	1.3		<0.000164	<0.000146	<0.000194	<0.000236	<0.000168
Toluene	0.7	500	0.7		<0.000164	<0.000146	<0.000194	<0.000236	<0.000168
trans-1,2-Dichloroethene	0.19	500	0.19		<0.000221	<0.000197	<0.000262	<0.000319	<0.000227
trans-1,3-Dichloropropene	NS	NS	NS		<0.000172	<0.000153	<0.000204	<0.000248	<0.000176
Trichloroethene	0.47	200	0.47		<0.00018	<0.000161	<0.000213	<0.00026	<0.000185
Trichlorofluoromethane	NS	NS	NS		<0.000394	<0.00035	<0.000466	<0.000566 UJ	<0.000403
Vinyl chloride	0.02	13	0.02		<0.000295	<0.000263	<0.000349	<0.000425	<0.000302
Xylenes (total)	0.26	500	1.6		<0.000508	<0.000453	<0.000601	<0.000732	<0.000521

Notes:

ft bgs = feet below ground surface

Bold - Exceeds 6 NYCRR Part 375 Protection of Groundwater

Shaded - Exceeds 6 NYCRR Part 375 Unrestricted and Corresponding CP-51 Soil Cleanup Objectives

Shaded - Exceeds 6 NYCRR Part 375 Commercial

UJ = The concentration was approximate and detected at a value below the Reporting Limit (RL) and above the MDL

units = mg/kg or parts per million (ppm)

NS = No Standard

¹ 6 NYCRR Part 375, Table 375-6.8(a): Unrestricted Use Soil Cleanup Objectives, December 14, 2006.

² 6 NYCRR Part 375, Table 375-6.8(b): Restricted Use Soil Cleanup Objectives, Protection of Public Health, Commercial, December 14, 2006.

³ 6 NYCRR Part 375, Table 375-6.8(b): Restricted Use Soil Cleanup Objectives, Protection of Public Health, Protection of Groundwater, December 14, 2006.

Table 1b
Surface Soil Sampling Results - SVOC Data Summary

Remedial Investigation
Brownfield Cleanup Program No. C360115
1-5 Holland Ave
White Plains, NY

Parameter (mg/kg or ppm)	Part 375 Unrestricted ¹	Part 375 Restricted Commercial ²	Part 375 Protection of Groundwater ³	Location ID:	SS12-1	BD-SS12 (SS12-1)	SS12-2	SS12-3	SS12-4
				Sample Interval (ft bgs):	0-0.5	0-0.5	0-0.5	0-0.5	0-0.5
				Date Sampled:	5/2/2012	5/2/2012	5/2/2012	5/2/2012	5/2/2012
SEMI-VOLATILE ORGANIC COMPOUNDS (SVOCs) - SPECIAL BNA+ 1,4-DIOXANE									
1,4-Dioxane	0.1	130	0.1		<0.022	<0.022	<0.012	<0.050	<0.073
2-Methylphenol	0.33	500	0.33		<0.023	<0.023	<0.012	<0.052	<0.075
4-Methylphenol **	NS	500	0.33		<0.025	<0.025	<0.013	<0.056	<0.082
Acenaphthene	20	500	98		0.227	0.467	<0.011	<0.049	0.388
Acenaphthylene	100	500	107		0.400 J	0.405 J	<0.016	<0.068	1.06
Anthracene	100	500	1000		0.886	1.34	0.034 J	0.124 J	2.25
Benzo[a]anthracene	1	5.6	1		2.68	3.50	0.086	0.311	8.15
Benzo[a]pyrene	1	1	22		2.71	3.52	0.097	0.301	8.04
Benzo[b]fluoranthene	1	5.6	1.7		3.03	3.75	0.113	0.323	8.43
Benzo[g,h,i]perylene	100	500	1000		1.41	1.75	0.082	0.184	5.04
Benzo[k]fluoranthene	0.8	56	1.7		2.04	2.58	0.075	0.211	7.39
Chrysene	1	56	1		2.48	3.24	0.087	0.265	7.61
Dibenz[a,h]anthracene	0.33	0.56	1000		0.494	0.559	0.025 J	<0.052	2.01
Fluoranthene	100	500	1000		5.20	7.37	0.137	0.563	14.2
Fluorene	30	500	386		0.179 J	0.398 J	<0.011	<0.050	0.502
Hexachlorobenzene	0.33	NS	NS		<0.030	<0.030	<0.016	<0.068	<0.099
Indeno[1,2,3-cd]pyrene	0.5	5.6	8.2		1.41	1.83	0.065	0.205	5.32
Naphthalene	12	500	12		0.037 J	0.183	<0.011	<0.048	0.163 J
Pentachlorophenol	0.8	6.7	0.8		<0.026	<0.027	<0.014	<0.060	<0.087
Phenanthrene	100	500	1000		2.12	3.93	0.063	0.330	5.19
Phenol	0.33	500	0.33		<0.026	<0.026	<0.013	<0.058	<0.084
Pyrene	100	500	1000		3.90	5.42	0.125	0.444	13.3

Notes:

ft bgs = feet below ground surface

Bold - Exceeds 6 NYCRR Part 375 Protection of Groundwater

Shaded - Exceeds 6 NYCRR Part 375 Unrestricted and Corresponding CP-51 Soil Cleanup Objectives

Shaded - Exceeds 6 NYCRR Part 375 Commercial

UJ = The concentration was approximate and detected at a value below the Reporting Limit (RL) and above the MDL
units = mg/kg or parts per million (ppm)

NS = No Standard

¹ 6 NYCRR Part 375, Table 375-6.8(a): Unrestricted Use Soil Cleanup Objectives, December 14, 2006.

² 6 NYCRR Part 375, Table 375-6.8(b): Restricted Use Soil Cleanup Objectives, Protection of Public Health, Commercial, December 14, 2006.

³ 6 NYCRR Part 375, Table 375-6.8(b): Restricted Use Soil Cleanup Objectives, Protection of Public Health, Protection of Groundwater, December

Table 1c
Surface Soil Sampling Results - Metals Data Summary

Remedial Investigation
Brownfield Cleanup Program No. C360115
1-5 Holland Ave
White Plains, NY

Parameter (mg/kg or ppm)	Part 375 Unrestricted ¹	Part 375 Restricted Commercial ²	Part 375 Protection of Groundwater ³	Location ID:	SS12-1	BD-SS12 (SS12-1)	SS12-2	SS12-3	SS12-4
				Sample Interval (ft bgs):	0-0.5	0-0.5	0-0.5	0-0.5	0-0.5
				Date Sampled:	5/2/2012	5/2/2012	5/2/2012	5/2/2012	5/2/2012
METALS									
Aluminum	NS	NS	NS		11600	10500	16000	8490	8140
Antimony	NS	NS	NS		<0.294	<0.276	<0.311	<0.320	<0.337
Arsenic	13	16	16		2.76	3.03	3.92	4.89	17.1
Barium	350	400	820		59.7	66.3	130	68.2	47.4
Beryllium	7.2	590	47		0.259 J	0.293 J	0.506 J	0.349 J	ND
Cadmium	2.5	9.3	7.5		0.212 J	0.228 J	0.223 J	3.10	0.389 J
Calcium	NS	NS	NS		5070	5060	3090	27800	5940
Chromium	16	400 ^b	NS		24.2	27.1	53.1	99.2	186
Cobalt	NS	NS	NS		7.72	7.91	21.6	7.97	9.58
Copper	50	270	1720		48.9	61.7	116	411	723
Iron	NS	NS	NS		17600	15900	26900	18000	22000
Lead	63	1000	450		25.9	28.7	104	72.9	36.6
Magnesium	NS	NS	NS		6140	5770	6760	5700	4380
Manganese	1600	10000	2000		314	289	498	313	323
Mercury	0.18	2.8	0.73		0.030	0.032	0.076	0.101	0.049
Nickel	30	310	130		16.1	16.0	28.0	20.4	22.6
Potassium	NS	NS	NS		2740	2570	2960	1210	1300
Selenium	3.9	1500	4		<1.18	<1.11	<1.24	<1.28	<1.35
Silver	2	1500	8.3		<0.147	<0.138	0.163 J	2.42	0.227 J
Sodium	NS	NS	NS		227	199	218	170	214
Thallium	NS	NS	NS		0.167 J	0.177 J	0.278 J	0.179 J	<0.169
Vanadium	NS	NS	NS		31.5	29.1	50.0	34.6	70.2
Zinc	109	10000	2480		105	94.1	698	375	131
GENERAL CHEMISTRY									
Cyanide, Total	27	27	40		<0.780	<0.780	<0.817	<0.893	<0.859
Hexavalent Chromium	36	400	19		<0.263 UJ	<0.290 UJ	<0.275 UJ	<0.301 UJ	<0.263 UJ

Notes:

ft bgs = feet below ground surface

Bold - Exceeds 6 NYCRR Part 375 Protection of Groundwater

Shaded - Exceeds 6 NYCRR Part 375 Unrestricted and Corresponding CP-51 Soil Cleanup Objectives

Shaded - Exceeds 6 NYCRR Part 375 Commercial

UJ = The concentration was approximate and detected at a value below the Reporting Limit (RL) and above the MDL

units = mg/kg or parts per million (ppm)

NS = No Standard

¹ 6 NYCRR Part 375, Table 375-6.8(a): Unrestricted Use Soil Cleanup Objectives, December 14, 2006.

² 6 NYCRR Part 375, Table 375-6.8(b): Restricted Use Soil Cleanup Objectives, Protection of Public Health, Commercial, December 14,

³ 6 NYCRR Part 375, Table 375-6.8(b): Restricted Use Soil Cleanup Objectives, Protection of Public Health, Protection of Groundwater,

⁴ Trivalent and hexavalent chromium were not broken out for the total chromium analysis, and the more conservative soil cleanup objective for hexavalent chromium was used.

Table 2
Site Wide Surface and Subsurface Soils Metals Data Summary

Site Management Plan
Brownfield Cleanup Program No. C360115
1-5 Holland Ave
White Plains, NY

Parameter (mg/kg or ppm)	Part 375 Unrestricted ¹	Part 375 Restricted Commercial ²	Part 375 Protection of Groundwater ³	Sample ID:	GP5-SB-01	GP5-SB-02	GP5-SB-03	FNY9-SB-01	FNY9-SB-02	FNY9-SB-03	FNY-8
				Depth Interval (ft bgs)	0.5 - 4.0	0.5 - 4.0	0.5 - 4.0	0.5 - 4.0	0.5 - 4.0	0.5 - 4.0	1.0 - 3.0
				Lab ID:	04105-001	04105-004	04105-005	04105-006	04105-007	04105-008	220-7315-1
				Sample Date	4/28/2011	4/28/2011	4/28/2011	4/28/2011	4/28/2011	4/28/2011	11/20/2008
Aluminum	NS	NS	NS		6850	7040	9180	8750	7250	7580	4220
Antimony	NS	NS	NS		<0.268	<0.292	0.321	<0.292	1.09 J	<0.262	NA
Arsenic	13	16	16		1.02	0.989	17.7	3.51	98.1	1.13	1.4 J
Barium	350	400	820		37.7	45.7	86.9	80.9	101	50.6	36.6
Beryllium	7.2	590	47		<0.214	<0.234	0.263 J	0.285 J	0.374	<0.209	2.5 U
Cadmium	2.5	9.3	7.5		<0.134	<0.146	0.373	0.301	1.30	<0.131	6.1 U
Calcium	NS	NS	NS		1700	1430	5480	1450	3860	1420	1130
Chromium	1 ⁶	400 ⁶	NS		10.5	10.7	30.8	16.8	28.6	10.7	6.9
Cobalt	NS	NS	NS		4.27	4.42	6.83	6.64	10.5	4.82	3.6
Copper	50	270	1720		19.3	25.3	129	605	423	18.1	14.7
Iron	NS	NS	NS		9630	9950	21800	14500	60700	11500	7400
Lead	63	1000	450		11.5	13.6	149	84.9	276	15.3	4.1 J
Magnesium	NS	NS	NS		2540	2800	5440	3990	3610	2950	1810
Manganese	1600	10000	2000		174	197	254	240	385	204	140
Mercury	0.18	2.8	0.73		0.019	0.019	5.45	10.5	7.92	0.011 J	0.065 U
Nickel	30	310	130		9.76	10.6	19.0	14.1	36.5	11.1	9.1
Potassium	NS	NS	NS		1100	1100	1890	2270	1440	1360	802
Selenium	3.9	1500	4		<1.07	<1.17	<1.19	<1.17	<1.27	<1.05	12.3 U
Silver	2	1500	8.3		0.255 J	0.235 J	0.309 J	0.284 J	0.368 J	0.190 J	3.7 U
Sodium	NS	NS	NS		233	303	424	306	293	210	295
Thallium	NS	NS	NS		0.145 J	<0.146	0.295 J	0.193 J	0.316 J	<0.131	8.6 U
Vanadium	NS	NS	NS		14.9	14.4	26.8	24.1	26.9	15.1	10.3
Zinc	109	10000	2480		32.7	35.8	158	272	132	34.7	20.1 J

Notes:

ft bgs = feet below ground surface

Bold - Exceeds 6 NYCRR Part 375 Protection of Groundwater

Shaded - Exceeds 6 NYCRR Part 375 Unrestricted and Corresponding CP-51 Soil Cleanup Objectives

Shaded - Exceeds 6 NYCRR Part 375 Commercial

UJ = The concentration was approximate and detected at a value below the Reporting Limit (RL) and above the MDL

units = mg/kg or parts per million (ppm)

NS = No Standard

¹ 6 NYCRR Part 375, Table 375-6.8(a): Unrestricted Use Soil Cleanup Objectives, December 14, 2006.

² 6 NYCRR Part 375, Table 375-6.8(b): Restricted Use Soil Cleanup Objectives, Protection of Public Health, Commercial, December 14, 2006.

³ 6 NYCRR Part 375, Table 375-6.8(b): Restricted Use Soil Cleanup Objectives, Protection of Public Health, Protection of Groundwater, December 14, 2006.

⁴ Trivalent and hexavalent chromium were not broken out for the total chromium analysis, and the more conservative soil cleanup objective for hexavalent chromium was used.

Table 2
Site Wide Surface and Subsurface Soils Metals Data Summary

Site Management Plan
Brownfield Cleanup Program No. C360115
1-5 Holland Ave
White Plains, NY

Parameter (mg/kg or ppm)	Part 375 Unrestricted ¹	Part 375 Restricted Commercial ²	Part 375 Protection of Groundwater ³	Sample ID:	FNY-8	FNY-9	FNY-9	FNY-10	FNY-10	FNY-11	FNY-11
				Depth Interval (ft bgs)	11.0 - 13.0	1.0 - 3.0	11.0 - 13.0	1.0 - 3.0	15.0 - 17.0	1.0 - 3.0	13.0 - 15.0
				Lab ID:	220-7315-2	220-7315-3	220-7315-4	220-7315-5	220-7315-6	220-7315-9	220-7315-10
				Sample Date	11/20/2008	11/20/2008	11/20/2008	11/20/2008	11/20/2008	11/20/2008	11/20/2008
Aluminum	NS	NS	NS		2600	6360	11800	7500	9120	1940	3930
Antimony	NS	NS	NS		NA	1.2 J	9.4 U	9.3 U	11.1 U	9.8 U	9.6 U
Arsenic	13	16	16		5.8 U	13.8	1.3 J	1.4 J	1.2 J	4.9 U	0.67 J
Barium	350	400	820		21.1	187	65.7	63.7	87.0	18.9	35.3
Beryllium	7.2	590	47		2.3 U	0.54 J	0.60 J	0.41 J	0.41 J	2.0 U	0.23 J
Cadmium	2.5	9.3	7.5		5.8 U	4.4 U	4.7 U	4.7 U	5.5 U	4.9 U	4.8 U
Calcium	NS	NS	NS		14800	1990	1560	1300	4110	1510	1720
Chromium	1 ⁶	400 ⁶	NS		4.9	13	23.1	15.9	22.4	4.6	7.7
Cobalt	NS	NS	NS		3.7	5.2	8.5	8.1	7.1	8.0	3.9
Copper	50	270	1720		7.2	990	61.9	14.5	20.5	18.7	11.2
Iron	NS	NS	NS		5850	22500	18800	13300	16600	3870	8180
Lead	63	1000	450		1.4 J	239	6.5	3.7 J	4.2 J	6.6	1.5 J
Magnesium	NS	NS	NS		6940	2380	5,300	3520	6100	1,080	2,050
Manganese	1600	10000	2000		96.6	220	293	368	254	63.1	147
Mercury	0.18	2.8	0.73		0.051 U	15.4	0.062	0.050 U	0.051 U	0.050 U	0.053 U
Nickel	30	310	130		6.7	13.9	20.4	18.2	15.7	4.5 J	8.6
Potassium	NS	NS	NS		626	921	2,790	1840	2970	423	899
Selenium	3.9	1500	4		11.7 U	2.6 J	1.1 J	9.3 U	11.1 U	9.8 U	9.6 U
Silver	2	1500	8.3		3.5 U	2.6 J	2.8	2.8 U	3.3 U	2.9 U	2.9 U
Sodium	NS	NS	NS		265	336	442	324	440	180 J	234
Thallium	NS	NS	NS		8.2 U	6.1 U	6.6 U	6.5 U	7.8 U	6.9 U	6.7 U
Vanadium	NS	NS	NS		7.4	20.1	29.0	20.1	30.9	5.4	11.7
Zinc	109	10000	2480		11.3 J	283	130	31.5	43.8	238	17.1 J

Notes:

ft bgs = feet below ground surface

Bold - Exceeds 6 NYCRR Part 375 Protection of Groundwater

Shaded - Exceeds 6 NYCRR Part 375 Unrestricted and Corresponding CP-51 Soil Cleanup Objectives

Shaded - Exceeds 6 NYCRR Part 375 Commercial

UJ = The concentration was approximate and detected at a value below the Reporting Limit (RL) and above the MDL

units = mg/kg or parts per million (ppm)

NS = No Standard

¹ 6 NYCRR Part 375, Table 375-6.8(a): Unrestricted Use Soil Cleanup Objectives, December 14, 2006.

² 6 NYCRR Part 375, Table 375-6.8(b): Restricted Use Soil Cleanup Objectives, Protection of Public Health, Commercial, Decen

³ 6 NYCRR Part 375, Table 375-6.8(b): Restricted Use Soil Cleanup Objectives, Protection of Public Health, Protection of Grou

⁴ Trivalent and hexavalent chromium were not broken out for the total chromium analysis, and the more conservative soil cle

Table 2
Site Wide Surface and Subsurface Soils Metals Data Summary

Site Management Plan
Brownfield Cleanup Program No. C360115
1-5 Holland Ave
White Plains, NY

Parameter (mg/kg or ppm)	Part 375 Unrestricted ¹	Part 375 Restricted Commercial ²	Part 375 Protection of Groundwater ³	Sample ID:	FNY-12	FNY-12	FNY-13	FNY-13	FNY-14	FNY-14	FNY-15
				Depth Interval (ft bgs)	1.0 - 3.0	11.0 - 13.0	4.0 - 6.0	10.0 - 12.0	0 - 2.0	8.0 - 10.0	2.0 - 4.0
				Lab ID:	220-7315-7	220-7315-8	220-7315-14	220-7315-15	220-7315-21	220-7315-22	220-7315-11
				Sample Date	11/20/2008	11/20/2008	11/21/2008	11/21/2008	11/21/2008	11/21/2008	11/21/2008
Aluminum	NS	NS	NS		9380	9100	3670	6970	5920	7620	4340
Antimony	NS	NS	NS		9.8 U	10.5 U	10.8 U	10.5 U	9.4 U	11.3 U	9.6 U
Arsenic	13	16	16		0.78 J	0.77 J	5.4 U	0.79 J	0.78 J	1.6 J	4.8 U
Barium	350	400	820		55.5	79.8	33.5	43.0	46.9	59.8	40.1
Beryllium	7.2	590	47		0.49 J	0.42 J	2.2 U	0.37 J	0.30 J	0.40 J	0.25 J
Cadmium	2.5	9.3	7.5		4.9 U	5.2 U	5.4 U	5.3 U	4.7 U	4.7 U	4.8 U
Calcium	NS	NS	NS		889	2870	1920	2390	1720	18400	1350
Chromium	1 ⁶	400 ⁶	NS		15.5	13.7	6.6	10.8	10	13.0	7.8
Cobalt	NS	NS	NS		5.8	6.3	3.1	5.3	4.6	5.4	3.7
Copper	50	270	1720		27.9	17.7	9.5	12.8	14.1	26.2	10.3
Iron	NS	NS	NS		15400	13700	7340	10900	9980	12200	7880
Lead	63	1000	450		4.0 J	7.7	2.8 J	2.5 J	3.4 J	15.9	1.7 J
Magnesium	NS	NS	NS		3,820	6050	1440	2660	2670	8100	1750
Manganese	1600	10000	2000		216	228	152	192	213	214	139
Mercury	0.18	2.8	0.73		0.022 J	0.050 U	0.049 U	0.051 U	0.052 U	0.048 U	0.051 U
Nickel	30	310	130		15.2	13.9	8.4	11.8	10.9	12.7	8.0
Potassium	NS	NS	NS		1,580	2120	654	1210	1310	1850	788
Selenium	3.9	1500	4		9.8 U	10.5 U	10.8 U	10.5 U	0.87 J	9.3 U	9.6 U
Silver	2	1500	8.3		2.9 U	3.1 U	3.2	3.2	2.8 U	2.8 U	1.4 J
Sodium	NS	NS	NS		475	409	206 J	452	298	501	186 J
Thallium	NS	NS	NS		6.8 U	7.3 U	7.5 U	7.4 U	6.6 U	6.5 U	6.7 U
Vanadium	NS	NS	NS		21.9	22.8	8.4	15.0	14.1	17.5	10.7
Zinc	109	10000	2480		34.3	36.7	13.4 J	23.3	22.4	40.2	15.5 J

Notes:

ft bgs = feet below ground surface

Bold - Exceeds 6 NYCRR Part 375 Protection of Groundwater

Shaded - Exceeds 6 NYCRR Part 375 Unrestricted and Corresponding CP-51 Soil Cleanup Objectives

Shaded - Exceeds 6 NYCRR Part 375 Commercial

UJ = The concentration was approximate and detected at a value below the Reporting Limit (RL) and above the MDL

units = mg/kg or parts per million (ppm)

NS = No Standard

¹ 6 NYCRR Part 375, Table 375-6.8(a): Unrestricted Use Soil Cleanup Objectives, December 14, 2006.

² 6 NYCRR Part 375, Table 375-6.8(b): Restricted Use Soil Cleanup Objectives, Protection of Public Health, Commercial, Decen

³ 6 NYCRR Part 375, Table 375-6.8(b): Restricted Use Soil Cleanup Objectives, Protection of Public Health, Protection of Grou

⁴ Trivalent and hexavalent chromium were not broken out for the total chromium analysis, and the more conservative soil cle

Table 2
Site Wide Surface and Subsurface Soils Metals Data Summary

Site Management Plan
Brownfield Cleanup Program No. C360115
1-5 Holland Ave
White Plains, NY

Parameter (mg/kg or ppm)	Part 375 Unrestricted ¹	Part 375 Restricted Commercial ²	Part 375 Protection of Groundwater ³	Sample ID:	FNY-15	FNY-16	FNY-16	FNY-17	FNY-17	FNY-18	SS12-1
				Depth Interval (ft bgs)	10.0 - 12.0	0 - 2.0	12.0 - 14.0	2.0 - 4.0	14.0 - 16.0	0 - 5.0	0 - 0.5
				Lab ID:	220-7315-12	220-7315-17	220-7315-18	220-7315-19	220-7315-20	220-7315-16	-
				Sample Date	11/21/2008	11/21/2008	11/21/2008	11/21/2008	11/21/2008	11/21/2008	5/2/2012
Aluminum	NS	NS	NS		4930	14900	10300	4560	10100	11300	11600
Antimony	NS	NS	NS		11.6 U	13.1 U	9.0 U	10.5 U	11.8 U	10.9 U	<0.294
Arsenic	13	16	16		5.8 U	2.0 J	1.4 J	0.66 J	1.1 J	2.0 J	2.76
Barium	350	400	820		31.9	61.7	111	40.0	92.7	53.6	59.7
Beryllium	7.2	590	47		0.29 J	0.73 J	0.42 J	0.27 J	0.45 J	0.48 J	0.259 J
Cadmium	2.5	9.3	7.5		5.8 U	6.5 U	4.5 U	5.2 U	5.9 U	5.4 U	0.212 J
Calcium	NS	NS	NS		2230	4970	20100	1370	35500	1010	5070
Chromium	1 ⁶	400 ⁶	NS		9.6	22.2	20.5	8.4	20.8	16.7	24.2
Cobalt	NS	NS	NS		4.8	8.7	8.7	4.7	7.6	6.3	7.72
Copper	50	270	1720		12.8	19.4	21.9	10.7	23.2	18.7	48.9
Iron	NS	NS	NS		9600	21600	21800	8850	16200	15500	17600
Lead	63	1000	450		1.8 J	6.1 J	2.6 J	1.7	12.2	7.1	25.9
Magnesium	NS	NS	NS		2240	9010	15400	2090	22900	7120	6140
Manganese	1600	10000	2000		228	337	334	163	260	412	314
Mercury	0.18	2.8	0.73		0.053 U	0.022 J	0.052 U	0.049 U	0.051 U	0.052 U	0.030
Nickel	30	310	130		9.9	18.4	12.1	9.2	16.9	15.9	16.1
Potassium	NS	NS	NS		930	2120	3840	1220	4110	1490	2740
Selenium	3.9	1500	4		1.1 J	1.2 J	1.0 J	10.5 U	11.8 U	1.1 J	<1.18
Silver	2	1500	8.3		3.5 U	3.9 U	2.7 U	3.1 U	3.5 U	3.3 U	<0.147
Sodium	NS	NS	NS		218 J	994	331	316	515	256	227
Thallium	NS	NS	NS		8.1 U	9.2 U	6.3 U	7.3 U	8.3 U	7.6 U	0.167 J
Vanadium	NS	NS	NS		13.6	35.0	36.1	12.3	28.8	23.9	31.5
Zinc	109	10000	2480		18.4 J	43.7	45.1	17.7 J	48.4	36.9	105

Notes:

ft bgs = feet below ground surface

Bold - Exceeds 6 NYCRR Part 375 Protection of Groundwater

Shaded - Exceeds 6 NYCRR Part 375 Unrestricted and Corresponding CP-51 Soil Cleanup Objectives

Shaded - Exceeds 6 NYCRR Part 375 Commercial

UJ = The concentration was approximate and detected at a value below the Reporting Limit (RL) and above the MDL

units = mg/kg or parts per million (ppm)

NS = No Standard

¹ 6 NYCRR Part 375, Table 375-6.8(a): Unrestricted Use Soil Cleanup Objectives, December 14, 2006.

² 6 NYCRR Part 375, Table 375-6.8(b): Restricted Use Soil Cleanup Objectives, Protection of Public Health, Commercial, Decen

³ 6 NYCRR Part 375, Table 375-6.8(b): Restricted Use Soil Cleanup Objectives, Protection of Public Health, Protection of Grou

⁴ Trivalent and hexavalent chromium were not broken out for the total chromium analysis, and the more conservative soil cle

Table 2
Site Wide Surface and Subsurface Soils Metals Data Summary

Site Management Plan
Brownfield Cleanup Program No. C360115
1-5 Holland Ave
White Plains, NY

Parameter (mg/kg or ppm)	Part 375 Unrestricted ¹	Part 375 Restricted Commercial ²	Part 375 Protection of Groundwater ³	Sample ID:	SS12-2	SS12-3	SS12-4	GP-1	GP-2	GP-3	GP-4
				Depth Interval (ft bgs)	0 - 0.5	0 - 0.5	0 - 0.5	0 - 4.0	4.0 - 8.0	12.0 - 16.0	0.5 - 1.0
				Lab ID:	-	-	-				
				Sample Date	5/2/2012	5/2/2012	5/2/2012	4/9/1999	4/9/1999	4/9/1999	4/9/1999
Aluminum	NS	NS	NS		16000	8490	8140	NA	NA	NA	NA
Antimony	NS	NS	NS		<0.311	<0.320	<0.337	NA	NA	NA	NA
Arsenic	13	16	16		3.92	4.89	17.1	NA	NA	NA	2.9
Barium	350	400	820		130	68.2	47.4	NA	NA	NA	52
Beryllium	7.2	590	47		0.506 J	0.349 J	<0.27	NA	NA	NA	NA
Cadmium	2.5	9.3	7.5		0.223 J	3.10	0.389 J	NA	NA	NA	<1.0
Calcium	NS	NS	NS		3090	27800	5940	NA	NA	NA	NA
Chromium	1 ⁶	400 ⁶	NS		53.1	99.2	186	NA	NA	NA	11
Cobalt	NS	NS	NS		21.6	7.97	9.58	NA	NA	NA	NA
Copper	50	270	1720		116	411	723	NA	NA	NA	NA
Iron	NS	NS	NS		26900	18000	22000	NA	NA	NA	NA
Lead	63	1000	450		104	72.9	36.6	NA	NA	NA	60
Magnesium	NS	NS	NS		6760	5700	4380	NA	NA	NA	NA
Manganese	1600	10000	2000		498	313	323	NA	NA	NA	NA
Mercury	0.18	2.8	0.73		0.076	0.101	0.049	NA	NA	NA	<0.1
Nickel	30	310	130		28.0	20.4	22.6	NA	NA	NA	NA
Potassium	NS	NS	NS		2960	1210	1300	NA	NA	NA	NA
Selenium	3.9	1500	4		<1.24	<1.28	<1.35	NA	NA	NA	<0.5
Silver	2	1500	8.3		0.163 J	2.42	0.227 J	NA	NA	NA	<2.0
Sodium	NS	NS	NS		218	170	214	NA	NA	NA	NA
Thallium	NS	NS	NS		0.278 J	0.179 J	<0.169	NA	NA	NA	NA
Vanadium	NS	NS	NS		50.0	34.6	70.2	NA	NA	NA	NA
Zinc	109	10000	2480		698	375	131	NA	NA	NA	NA

Notes:

ft bgs = feet below ground surface

Bold - Exceeds 6 NYCRR Part 375 Protection of Groundwater

Shaded - Exceeds 6 NYCRR Part 375 Unrestricted and Corresponding CP-51 Soil Cleanup Objectives

Shaded - Exceeds 6 NYCRR Part 375 Commercial

UJ = The concentration was approximate and detected at a value below the Reporting Limit (RL) and above the MDL

units = mg/kg or parts per million (ppm)

NS = No Standard

¹ 6 NYCRR Part 375, Table 375-6.8(a): Unrestricted Use Soil Cleanup Objectives, December 14, 2006.

² 6 NYCRR Part 375, Table 375-6.8(b): Restricted Use Soil Cleanup Objectives, Protection of Public Health, Commercial, Decen

³ 6 NYCRR Part 375, Table 375-6.8(b): Restricted Use Soil Cleanup Objectives, Protection of Public Health, Protection of Grou

⁴ Trivalent and hexavalent chromium were not broken out for the total chromium analysis, and the more conservative soil cle

Table 2
Site Wide Surface and Subsurface Soils Metals Data Summary

Site Management Plan
Brownfield Cleanup Program No. C360115
1-5 Holland Ave
White Plains, NY

Parameter (mg/kg or ppm)	Part 375 Unrestricted ¹	Part 375 Restricted Commercial ²	Part 375 Protection of Groundwater ³	Sample ID:	GP-6	GP-5	HB-1	HB-2A	HB-3A		
				Depth Interval (ft bgs)	12.0 - 16.0	0 - 4.0	0 - 1.0	5.0 - 6.0	0 - 1.0		
				Lab ID:		-					
				Sample Date	4/9/1999	4/9/1999	4/9/1999		6/2/1999		
Aluminum	NS	NS	NS		NA	NA	NA	NA	NA		
Antimony	NS	NS	NS		NA	NA	NA	NA	NA		
Arsenic	13	16	16		NA	11	2.4	NA	<1.0		
Barium	350	400	820		NA	75	140	NA	33.6		
Beryllium	7.2	590	47		NA	NA	NA	NA	NA		
Cadmium	2.5	9.3	7.5		NA	5	5	NA	<0.5		
Calcium	NS	NS	NS		NA	NA	NA	NA	NA		
Chromium	1 ⁶	400 ⁶	NS		NA	7	25	NA	7.16		
Cobalt	NS	NS	NS		NA	NA	NA	NA	NA		
Copper	50	270	1720		NA	NA	NA	NA	NA		
Iron	NS	NS	NS		NA	NA	NA	NA	NA		
Lead	63	1000	450		NA	4200	350	NA	8.73		
Magnesium	NS	NS	NS		NA	NA	NA	NA	NA		
Manganese	1600	10000	2000		NA	NA	NA	NA	NA		
Mercury	0.18	2.8	0.73		NA	50	0.2	NA	1.18		
Nickel	30	310	130		NA	NA	NA	NA	NA		
Potassium	NS	NS	NS		NA	NA	NA	NA	NA		
Selenium	3.9	1500	4		NA	1.2	0.7	NA	1.07		
Silver	2	1500	8.3		NA	<2.0	<2.0	NA	<0.5		
Sodium	NS	NS	NS		NA	NA	NA	NA	NA		
Thallium	NS	NS	NS		NA	NA	NA	NA	NA		
Vanadium	NS	NS	NS		NA	NA	NA	NA	NA		
Zinc	109	10000	2480		NA	NA	NA	NA	NA		

Notes:

ft bgs = feet below ground surface

Bold - Exceeds 6 NYCRR Part 375 Protection of Groundwater

Shaded - Exceeds 6 NYCRR Part 375 Unrestricted and Corresponding CP-51 Soil Cleanup Objectives

Shaded - Exceeds 6 NYCRR Part 375 Commercial

UJ = The concentration was approximate and detected at a value below the Reporting Limit (RL) and above the MDL

units = mg/kg or parts per million (ppm)

NS = No Standard

¹ 6 NYCRR Part 375, Table 375-6.8(a): Unrestricted Use Soil Cleanup Objectives, December 14, 2006.

² 6 NYCRR Part 375, Table 375-6.8(b): Restricted Use Soil Cleanup Objectives, Protection of Public Health, Commercial, Decen

³ 6 NYCRR Part 375, Table 375-6.8(b): Restricted Use Soil Cleanup Objectives, Protection of Public Health, Protection of Grou

⁴ Trivalent and hexavalent chromium were not broken out for the total chromium analysis, and the more conservative soil cle

**Table 3a
Groundwater Sampling
VOC Data Summary**

Site Management Plan
Brownfield Cleanup Program No. C360115
1-5 Holland Avenue
White Plains, NY

Well ID:	MW-1	MW-1	MW-2	MW-2	MW-2DB	MW-2DB	MW-2DB	MW-2SB	MW-2SB	MW-2SB	
Screen Interval (ft above msl):	182.7 - 192.7	182.7 - 192.7	181.4 - 191.4	181.4 - 191.4	126.3 - 136.3	126.3 - 136.3	126.3 - 136.3	148.9 - 158.9	148.9 - 158.9	148.9 - 158.9	
Date Sampled:	10/19/2011	5/1/2012	10/21/2011	5/2/2012	5/5/2011	10/20/2011	5/2/2012	5/5/2011	10/21/2011	5/2/2012	
Parameter	TOGS 1.1.1 GW STD										
VOLATILE ORGANIC COMPOUNDS (VOCs)											
1,1,1-Trichloroethane	5	<0.350	<0.330	<0.350	<0.330	<0.420	<0.350	<0.330	<0.420	<0.350	<0.330
1,1,2,2-Tetrachloroethane	5	<0.310	<0.320	<0.310	<0.320	<0.280	<0.310	<0.320	<0.280	<0.310	<0.320
1,1,2-Trichloro-1,2,2-trifluoroethane	5	<0.440	<0.420	<0.440	<0.420	<0.320	<0.440	<0.420	<0.320	<0.440	<0.420
1,1,2-Trichloroethane	1	<0.360	<0.220	<0.360	<0.220	<0.570	<0.360	<0.220	<0.570	<0.360	<0.220
1,1-Dichloroethane	5	<0.430	<0.260	<0.430	<0.260	<0.440	<0.430	<0.260	<0.440	<0.430	<0.260
1,1-Dichloroethene	5	<0.710	<0.410	<0.710	<0.410	<0.410	<0.710	<0.410	<0.410	<0.710	<0.410
1,2,3-Trichlorobenzene	5	<0.420	<0.210	<0.420	<0.210	<0.550	<0.420	<0.210	<0.550	<0.420	<0.210
1,2,4-Trichlorobenzene	5	<0.390	<0.200	<0.390	<0.200	<0.340	<0.390	<0.200	<0.340	<0.390	<0.200
1,2-Dibromo-3-chloropropane	0.04	<0.00855	<0.00855	<0.00855	<0.00855	<0.660	<0.00855	<0.00855	<0.660	<0.00855	<0.00855
1,2-Dibromoethane (EDB)	0.0006	<0.00855	<0.00855	<0.00855	<0.00855	<0.400	<0.00855	<0.00855	<0.400	<0.00855	<0.00855
1,2-Dichlorobenzene	3	<0.360	<0.230	<0.360	<0.230	<0.340	<0.360	<0.230	<0.340	<0.360	<0.230
1,2-Dichloroethane (EDC)	0.6	<0.420	<0.200	<0.420	<0.200	<0.460	<0.420	<0.200	<0.460	<0.420	<0.200
1,2-Dichloropropane	1	<0.520	<0.250	<0.520	<0.250	<0.460	<0.520	<0.250	<0.460	<0.520	<0.250
1,3-Dichlorobenzene	3	<0.420	<0.230	<0.420	<0.230	<0.410	<0.420	<0.230	<0.410	<0.420	<0.230
1,4-Dichlorobenzene	3	<0.330	<0.230	<0.330	<0.230	<0.430	<0.330	<0.230	<0.430	<0.330	<0.230
1,4-Dioxane	NC	<22.5 R	<0.301	<22.5 R	<0.301	<20.2 R	<22.5 R	<0.301	<20.2 R	<22.5 R	<0.301
2-Butanone (MEK)	50	<0.630	<0.550	<0.630	<0.550	<0.510	<0.630	<0.550	<0.510	<0.630	<0.550
2-Hexanone	50	<0.260	<0.370	<0.260	<0.370	<0.370	<0.260	<0.370	<0.370	<0.260	<0.370
4-Methyl-2-pentanone (MIBK)	NC	<0.510	<0.350	<0.510	<0.350	<0.410	<0.510	<0.350	<0.410	<0.510	<0.350
Acetone	50	<0.870	<0.280	<0.870	<0.280	<0.610	<0.870	<0.280	<0.610	<0.870	<0.280
Benzene	1	<0.430	<0.250	<0.430	<0.250	<0.250	<0.430	<0.250	<0.510	<0.430	<0.250
Bromochloromethane	5	<0.470	<0.300	<0.470	<0.300	<0.560	<0.470	<0.300	<0.560	<0.470	<0.300
Bromodichloromethane	50	<0.350	<0.260	<0.350	<0.260	<0.350	<0.350	<0.260	<0.440	<0.350	<0.260
Bromoform	50	<0.260	<0.460	<0.260	<0.460	<0.520	<0.260	<0.460	<0.520	<0.260	<0.460
Bromomethane	5	<0.510	<0.250	<0.670	<0.250	<0.680	<0.670	<0.250	<0.680	<0.670	<0.250
Carbon disulfide	NC	<0.670	<0.300	<0.500	<0.300	<0.330	<0.500	<0.300	<0.330	<0.500	<0.300
Carbon tetrachloride	5	<0.500	<0.360	<0.400	<0.360	<0.290	<0.400	<0.360	<0.290	<0.400	<0.360
Chlorobenzene	5	<0.400	<0.220	<0.480	<0.220	<0.420	<0.480	<0.220	<0.420	<0.480	<0.220
Chloroethane	5	<0.480	<0.360	<0.780	<0.360	<0.480	<0.780	<0.360	<0.480	<0.780	<0.360

Notes:

and Operational Guidance Series: Ambient

ft above msl = feet above mean sea level

BOLD = Exceeds TOGS 1.1.1 Class GA Groundwater Standards/Criteria

* = Analyzed for but Not Detected at the Method Detection Limit (MDL)

¹ = Post drilling screening samples. (Not ASP Category B samples.)

J = The concentration was detected at a value below the Reporting Limit (RL) and above the MDL

R = The result was rejected during data validation.

D = Diluted sample result

units = ug/L or parts per billion

NA = Not Available

NC = No Criteria

**Table 3a
Groundwater Sampling
VOC Data Summary**

Site Management Plan
Brownfield Cleanup Program No. C360115
1-5 Holland Avenue
White Plains, NY

Well ID:	MW-1	MW-1	MW-2	MW-2	MW-2DB	MW-2DB	MW-2DB	MW-2SB	MW-2SB	MW-2SB	
Screen Interval (ft above msl):	182.7 - 192.7	182.7 - 192.7	181.4 - 191.4	181.4 - 191.4	126.3 - 136.3	126.3 - 136.3	126.3 - 136.3	148.9 - 158.9	148.9 - 158.9	148.9 - 158.9	
Date Sampled:	10/19/2011	5/1/2012	10/21/2011	5/2/2012	5/5/2011	10/20/2011	5/2/2012	5/5/2011	10/21/2011	5/2/2012	
Parameter	TOGS 1.1.1 GW STD										
VOLATILE ORGANIC COMPOUNDS (VOCs)											
Chloroform	7	<0.340	<0.220	<0.340	<0.220	2.41	<0.340	<0.220	13	2.69	2.5
Chloromethane	5	<0.350	<0.280	<0.350	<0.280	<0.430	<0.350	<0.280	<0.430	<0.350	<0.280
cis-1,2-Dichloroethene	5	<0.380	<0.300	<0.380	<0.300	<0.560	<0.380	<0.300	<0.560	<0.380	<0.300
cis-1,3-Dichloropropene	0.4	<0.360	<0.250	<0.360	<0.250	<0.360	<0.360	<0.250	<0.360	<0.360	<0.250
Cyclohexane	NC	<0.460	<0.380	<0.460	<0.380	<0.230	<0.460	<0.380	<0.230	<0.460	<0.380
Dibromochloromethane	50	<0.360	<0.240	<0.360	<0.240	<0.430	<0.360	<0.240	<0.430	<0.360	<0.240
Dichlorodifluoromethane	5	<0.420	<0.290	<0.420	<0.290	<0.420	<0.420	<0.290	<0.420	<0.420	<0.290
Ethylbenzene	5	<0.340	<0.220	<0.340	<0.220	<0.340	<0.340	<0.220	<0.340	<0.340	<0.220
Isopropylbenzene	5	<0.390	<0.210	<0.390	<0.210	<0.300	<0.390	<0.210	<0.300	<0.390	<0.210
Methyl acetate	NC	<0.350	<0.220	<0.350	<0.220	<0.600	<0.350	<0.220	<0.600	<0.350	<0.220
Methyl tert-butyl ether (MTBE)	NC	<0.380	<0.240	<0.380	<0.240	<0.450	<0.380	<0.240	<0.450	<0.380	<0.240
Methylcyclohexane	NC	<0.460	<0.360	<0.460	<0.360	<0.290	<0.460	<0.360	<0.290	<0.460	<0.360
Methylene chloride	5	<1.98	<1.98	<1.98	<1.98	<1.98	<1.98	<1.98	<1.98	<1.98	<1.98
Styrene	5	<0.330	<0.250	<0.330	<0.250	<0.380	<0.330	<0.250	<0.380	<0.330	<0.250
Tetrachloroethene	5	57.9	17.1	71.7	189 D	4.83	4.96	4.41	0.988 J	0.670 J	<0.330
Toluene	5	<0.390	<0.270	<0.390	<0.270	1.19	<0.390	<0.270	<0.230	<0.390	<0.270
trans-1,2-Dichloroethene	5	<0.550	<0.350	<0.550	<0.350	<0.500	<0.550	<0.350	<0.500	<0.550	<0.350
trans-1,3-Dichloropropene	0.4	<0.320	<0.220	<0.320	<0.220	<0.450	<0.320	<0.220	<0.450	<0.320	<0.220
Trichloroethene	5	<0.550	<0.270	<0.550	<0.270	<0.440	<0.550	<0.270	<0.440	<0.550	<0.270
Trichlorofluoromethane	5	<0.660	<0.450	<0.660	<0.450	<0.220	<0.660	<0.450	<0.220	<0.660	<0.450
Vinyl Chloride	2	<0.460	<0.290	<0.460	<0.290	<0.300	<0.460	<0.290	<0.300	<0.460	<0.290
Xylenes (Total)	5	<0.630	<0.690	<0.630	<0.690	<0.660	<0.630	<0.690	<0.660	<0.630	<0.690
Total VOCs	NA	57.9	17.1	71.7	189 D	8.43	4.96	4.41	14.0 J	3.36 J	2.5

Notes:

and Operational Guidance Series: Ambient

ft above msl = feet above mean sea level

BOLD = Exceeds TOGS 1.1.1 Class GA Groundwater Standards/Criteria

* = Analyzed for but Not Detected at the Method Detection Limit (MDL)

¹= Post drilling screening samples. (Not ASP Category B samples.)

J = The concentration was detected at a value below the Reporting Limit (RL) and above the MDL

R = The result was rejected during data validation.

D = Diluted sample result

units = ug/L or parts per billion

NA = Not Available

NC = No Criteria

**Table 3a
Groundwater Sampling
VOC Data Summary**

Site Management Plan
Brownfield Cleanup Program No. C360115
1-5 Holland Avenue
White Plains, NY

Well ID:	BD-05/12	MW-4D	MW-4D	MW-4D	MW-4S	MW-4S	MW-5	MW-5	MW-5DB	MW-5DB	
Screen Interval (ft above msl):	148.9 - 158.9	158 - 168	158 - 168	158 - 168	178.4 - 188.5	178.4 - 188.5	179.7 - 189.7	179.7 - 189.7	105.3 - 115.3	105.3 - 115.3	
Date Sampled:	5/2/2012	5/5/2011	10/19/2011	5/1/2012	10/19/2011	5/1/2012	10/21/2011	5/2/2012	5/5/2011	10/21/2011	
Parameter	TOGS 1.1.1 GW STD										
VOLATILE ORGANIC COMPOUNDS (VOCs)											
1,1,1-Trichloroethane	5	<0.330	<8.40	<17.5	<16.5	<3.50	<3.30	<0.350	<0.330	<0.420	<0.350
1,1,2,2-Tetrachloroethane	5	<0.320	<5.60	<15.5	<16.0	<3.10	<3.20	<0.310	<0.320	<0.280	<0.310
1,1,2-Trichloro-1,2,2-trifluoroethane	5	<0.420	<6.40	<22.0	<21.0	<4.40	<4.20	<0.440	<0.420	<0.320	<0.440
1,1,2-Trichloroethane	1	<0.220	<11.4	<18.0	<11.0	<3.60	<2.20	<0.360	<0.220	<0.570	<0.360
1,1-Dichloroethane	5	<0.260	<8.80	<21.5	<13.0	<4.30	<2.60	<0.430	<0.260	<0.440	<0.430
1,1-Dichloroethene	5	<0.410	<8.20	<35.5	<20.5	<7.10	<4.10	<0.710	<0.410	<0.410	<0.710
1,2,3-Trichlorobenzene	5	<0.210	<11.0	<21.0	<10.5	<4.20	<2.10	<0.420	<0.210	<0.550	<0.420
1,2,4-Trichlorobenzene	5	<0.200	<6.80	<19.5	<10.0	<3.90	<2.00	<0.390	<0.200	<0.340	<0.390
1,2-Dibromo-3-chloropropane	0.04	<0.00855	<13.2	<0.00855	<0.00855	<0.00855	<0.00855	<0.00855	<0.00855	<0.660	<0.00855
1,2-Dibromoethane (EDB)	0.0006	<0.00855	<8.00	<0.00855	<0.00855	<0.00855	<0.00855	<0.00855	<0.00855	<0.400	<0.00855
1,2-Dichlorobenzene	3	<0.230	<6.80	<18.0	<11.5	<3.60	<2.30	<0.360	<0.230	<0.340	<0.360
1,2-Dichloroethane (EDC)	0.6	<0.200	<9.20	<21.0	<10.0	<4.20	<2.00	<0.420	<0.200	<0.460	<0.420
1,2-Dichloropropane	1	<0.250	<9.20	<26.0	<12.5	<5.20	<2.50	<0.520	<0.250	<0.460	<0.520
1,3-Dichlorobenzene	3	<0.230	<8.20	<21.0	<11.5	<4.20	<2.30	<0.420	<0.230	<0.410	<0.420
1,4-Dichlorobenzene	3	<0.230	<8.60	<16.5	<11.5	<3.30	<2.30	<0.330	<0.230	<0.430	<0.330
1,4-Dioxane	NC	<0.301	<404	<1130 R	<0.301	<225 R	<0.301	<22.5 R	<0.301	<20.2	<22.5 R
2-Butanone (MEK)	50	<0.550	<10.2	<31.5	<27.5	<6.30	<5.50	<0.630	<0.550	<0.510	<0.630
2-Hexanone	50	<0.370	<7.40	<13.0	<18.5	<2.60	<3.70	<0.260	<0.370	<0.370	<0.260
4-Methyl-2-pentanone (MIBK)	NC	<0.350	<8.20	<25.5	<17.5	<5.10	<3.50	<0.510	<0.350	<0.410	<0.510
Acetone	50	<0.280	<12.2	<43.5	<14.0	<8.70	<2.80	<0.870	<0.280	<0.610	<0.870
Benzene	1	<0.250	<5.00	<21.5	<12.5	<4.30	<2.50	<0.430	<0.250	<0.250	<0.430
Bromochloromethane	5	<0.300	<11.2	<23.5	<15.0	<4.70	<3.00	<0.470	<0.300	<0.560	<0.470
Bromodichloromethane	50	<0.260	<7.00	<17.5	<13.0	<3.50	<2.60	<0.350	<0.260	<0.350	<0.350
Bromoform	50	<0.460	<10.4	<13.0	<23.0	<2.60	<4.60	<0.260	<0.460	<0.520	<0.260
Bromomethane	5	<0.250	<13.6	<33.5	<12.5	<5.10	<2.50	<0.670	<0.250	<0.680	<0.670
Carbon disulfide	NC	<0.300	<6.60	<25.0	<15.0	<6.70	<3.00	<0.500	<0.300	<0.330	<0.500
Carbon tetrachloride	5	<0.360	<5.80	<20.0	<18.0	<5.00	<3.60	<0.400	<0.360	<0.290	<0.400
Chlorobenzene	5	<0.220	<8.40	<24.0	<11.0	<4.00	<2.20	<0.480	<0.220	<0.420	<0.480
Chloroethane	5	<0.360	<9.60	<39.0	<18.0	<4.80	<3.60	<0.780	<0.360	<0.480	<0.780

Notes:

and Operational Guidance Series: Ambient

ft above msl = feet above mean sea level

BOLD = Exceeds TOGS 1.1.1 Class GA Groundwater Standards/Criteria

* = Analyzed for but Not Detected at the Method Detection Limit (MDL)

¹ = Post drilling screening samples. (Not ASP Category B samples.)

J = The concentration was detected at a value below the Reporting Limit (RL) and above the MDL

R = The result was rejected during data validation.

D = Diluted sample result

units = ug/L or parts per billion

NA = Not Available

NC = No Criteria

**Table 3a
Groundwater Sampling
VOC Data Summary**

Site Management Plan
Brownfield Cleanup Program No. C360115
1-5 Holland Avenue
White Plains, NY

Well ID:	BD-05/12	MW-4D	MW-4D	MW-4D	MW-4S	MW-4S	MW-5	MW-5	MW-5DB	MW-5DB	
Screen Interval (ft above msl):	148.9 - 158.9	158 - 168	158 - 168	158 - 168	178.4 - 188.5	178.4 - 188.5	179.7 - 189.7	179.7 - 189.7	105.3 - 115.3	105.3 - 115.3	
Date Sampled:	5/2/2012	5/5/2011	10/19/2011	5/1/2012	10/19/2011	5/1/2012	10/21/2011	5/2/2012	5/5/2011	10/21/2011	
Parameter	TOGS 1.1.1 GW STD										
VOLATILE ORGANIC COMPOUNDS (VOCs)											
Chloroform	7	2.49	<8.20	<17.0	<11.0	<3.40	<2.20	<0.340	<0.220	1.54	0.425 J
Chloromethane	5	<0.280	<8.60	<17.5	<14.0	<3.50	<2.80	<0.350	<0.280	<0.430	<0.350
cis-1,2-Dichloroethene	5	<0.300	<11.2	<19.0	<15.0	<3.80	<3.00	<0.380	<0.300	<0.560	<0.380
cis-1,3-Dichloropropene	0.4	<0.250	<7.20	<18.0	<12.5	<3.60	<2.50	<0.360	<0.250	<0.360	<0.360
Cyclohexane	NC	<0.380	<4.60	<23.0	<19.0	<4.60	<3.80	<0.460	<0.380	<0.230	<0.460
Dibromochloromethane	50	<0.240	<8.60	<18.0	<12.0	<3.60	<2.40	<0.360	<0.240	<0.430	<0.360
Dichlorodifluoromethane	5	<0.290	<8.40	<21.0	<14.5	<4.20	<2.90	<0.420	<0.290	<0.420	<0.420
Ethylbenzene	5	<0.220	<6.80	<17.0	<11.0	<3.40	<2.20	<0.340	<0.220	<0.340	<0.340
Isopropylbenzene	5	<0.210	<6.00	<19.5	<10.5	<3.90	<2.10	<0.390	<0.210	<0.300	<0.390
Methyl acetate	NC	<0.220	<12.0	<17.5	<11.0	<3.50	<2.20	<0.350	<0.220	<0.600	<0.350
Methyl tert-butyl ether (MTBE)	NC	<0.240	<9.00	<19.0	<12.0	<3.80	<2.40	<0.380	<0.240	<0.450	<0.380
Methylcyclohexane	NC	<0.360	<5.80	<23.0	<18.0	<4.60	<3.60	<0.460	<0.360	<0.290	<0.460
Methylene chloride	5	<1.98	<39.6	<99.0	<99.0	<1.98	<19.8	<1.98	<1.98	<1.98	<1.98
Styrene	5	<0.250	<7.60	<16.5	<12.5.0	<3.30	<2.50	<0.330	<0.250	<0.380	<0.330
Tetrachloroethene	5	<0.330	2570	6070	6140	1410	1020	9.19	3.14	2.53	2.37
Toluene	5	<0.270	<4.60	<19.5	<13.5	<3.90	<2.70	<0.390	<0.270	0.504 J	<0.390
trans-1,2-Dichloroethene	5	<0.350	<10.0	<27.5	<17.5	<5.50	<3.50	<0.550	<0.350	<0.500	<0.550
trans-1,3-Dichloropropene	0.4	<0.220	<9.00	<16.0	<11.0	<3.20	<2.20	<0.320	<0.220	<0.450	<0.320
Trichloroethene	5	<0.270	<8.80	<27.5	<13.5	<5.50	<2.70	<0.550	<0.270	<0.440	<0.550
Trichlorofluoromethane	5	<0.450	<4.40	<33.0	<22.5	<6.60	<4.50	<0.660	<0.450	<0.220	<0.660
Vinyl Chloride	2	<0.290	<6.00	<23.0	<14.5	<4.60	<2.90	<0.460	<0.290	<0.300	<0.460
Xylenes (Total)	5	<0.690	<13.2	<31.5	<34.5	<6.30	<6.90	<0.630	<0.690	<0.660	<0.630
Total VOCs	NA	2.49	2,570	6,070	6,140	1,410	1,020	9.19	3.14	4.57 J	2.80 J

Notes:

and Operational Guidance Series: Ambient
ft above msl = feet above mean sea level

BOLD = Exceeds TOGS 1.1.1 Class GA Groundwater Standards/Criteria

* = Analyzed for but Not Detected at the Method Detection Limit (MDL)

¹ = Post drilling screening samples. (Not ASP Category B samples.)

J = The concentration was detected at a value below the Reporting Limit (RL) and above the MDL

R = The result was rejected during data validation.

D = Diluted sample result

units = ug/L or parts per billion

NA = Not Available

NC = No Criteria

**Table 3a
Groundwater Sampling
VOC Data Summary**

Site Management Plan
Brownfield Cleanup Program No. C360115
1-5 Holland Avenue
White Plains, NY

Well ID:	MW-5DB	MW-5SB	MW-5SB	MW-5SB	MW-6 ¹	MW-6	MW-6	MW-6SB ¹	MW-6SB	FD-101811	
Screen Interval (ft above msl):	105.3 - 115.3	145.1 - 155.1	145.1 - 155.1	145.1 - 155.1	179.6 - 189.6	179.6 - 189.6	179.6 - 189.6	151.9 - 161.9	151.9 - 161.9	Blind Duplicate	
Date Sampled:	5/2/2012	5/5/2011	10/25/2011	5/2/2012	8/3/2011	10/18/2011	4/30/2012	8/3/2011	10/18/2011	10/18/2011	
Parameter	TOGS 1.1.1 GW STD										
VOLATILE ORGANIC COMPOUNDS (VOCs)											
1,1,1-Trichloroethane	5	<0.330	<0.420	<0.350	<0.330	<0.420	<0.350	<0.330	<0.420	<0.350	<0.350
1,1,2,2-Tetrachloroethane	5	<0.320	<0.280	<0.310	<0.320	<0.280	<0.310	<0.320	<0.280	<0.310	<0.310
1,1,2-Trichloro-1,2,2-trifluoroethane	5	<0.420	<0.320	<0.440	<0.420	<0.320	<0.440	<0.420	<0.320	<0.440	<0.440
1,1,2-Trichloroethane	1	<0.220	<0.570	<0.360	<0.220	<0.570	<0.360	<0.220	<0.570	<0.360	<0.360
1,1-Dichloroethane	5	<0.260	<0.440	<0.430	<0.260	<0.440	<0.430	<0.260	<0.440	<0.430	<0.430
1,1-Dichloroethene	5	<0.410	<0.410	<0.710	<0.410	<0.410	<0.710	<0.410	<0.410	<0.710	<0.710
1,2,3-Trichlorobenzene	5	<0.210	<0.550	<0.420	<0.210	<0.550	<0.420	<0.210	<0.550	<0.420	<0.420
1,2,4-Trichlorobenzene	5	<0.200	<0.340	<0.390	<0.200	<0.340	<0.390	<0.200	<0.340	<0.390	<0.390
1,2-Dibromo-3-chloropropane	0.04	<0.00855	<0.660	<0.00855	<0.00855	<0.660	<0.00855	<0.00855	<0.660	<0.00855	<0.00855
1,2-Dibromoethane (EDB)	0.0006	<0.00855	<0.400	<0.00855	<0.00855	<0.400	<0.00855	<0.00855	<0.400	<0.00855	<0.00855
1,2-Dichlorobenzene	3	<0.230	<0.340	<0.360	<0.230	<0.340	<0.360	<0.230	<0.340	<0.360	<0.360
1,2-Dichloroethane (EDC)	0.6	<0.200	<0.460	<0.420	<0.200	<0.460	<0.420	<0.200	<0.460	<0.420	<0.420
1,2-Dichloropropane	1	<0.250	<0.460	<0.520	<0.250	<0.460	<0.520	<0.250	<0.460	<0.520	<0.520
1,3-Dichlorobenzene	3	<0.230	<0.410	<0.420	<0.230	<0.410	<0.420	<0.230	<0.410	<0.420	<0.420
1,4-Dichlorobenzene	3	<0.230	<0.430	<0.330	<0.230	<0.430	<0.330	<0.230	<0.430	<0.330	<0.330
1,4-Dioxane	NC	<0.301	<20.2	<22.5 R	<0.301	<20.2	<22.5 R	<0.301	<20.2	<22.5 R	<22.5 R
2-Butanone (MEK)	50	<0.550	<0.510	<0.630	<0.550	2.33	<0.630	<0.550	<0.510	<0.630	<0.630
2-Hexanone	50	<0.370	<0.370	<0.260	<0.370	<0.370	<0.260	<0.370	<0.370	<0.260	<0.260
4-Methyl-2-pentanone (MIBK)	NC	<0.350	<0.410	<0.510	<0.350	<0.410	<0.510	<0.350	<0.410	<0.510	<0.510
Acetone	50	<0.280	10.2	<0.870	<0.280	17.7	<0.870	<0.280	1.37	<0.870	<0.870
Benzene	1	<0.250	<0.250	<0.430	<0.250	<0.250	<0.430	<0.250	<0.250	<0.430	<0.430
Bromochloromethane	5	<0.300	<0.560	<0.470	<0.300	<0.560	<0.470	<0.300	<0.560	<0.470	<0.470
Bromodichloromethane	50	<0.260	<0.350	<0.350	<0.260	<0.350	<0.350	<0.260	0.767 J	<0.350	<0.350
Bromoform	50	<0.460	<0.520	<0.260	<0.460	<0.520	<0.260	<0.460	<0.520	<0.260	<0.260
Bromomethane	5	<0.250	<0.680	<0.670	<0.250	<0.680	<0.670	<0.250	<0.680	<0.670	<0.670
Carbon disulfide	NC	<0.300	<0.330	<0.500	<0.300	<0.330	<0.500	<0.300	<0.330	<0.500	<0.500
Carbon tetrachloride	5	<0.360	<0.290	<0.400	<0.360	<0.290	<0.400	<0.360	<0.290	<0.400	<0.400
Chlorobenzene	5	<0.220	<0.420	<0.480	<0.220	<0.420	<0.480	<0.220	<0.420	<0.480	<0.480
Chloroethane	5	<0.360	<0.480	<0.780	<0.360	<0.480	<0.780	<0.360	<0.480	<0.780	<0.780

Notes:

and Operational Guidance Series: Ambient

ft above msl = feet above mean sea level

BOLD = Exceeds TOGS 1.1.1 Class GA Groundwater Standards/Criteria

* = Analyzed for but Not Detected at the Method Detection Limit (MDL)

¹ = Post drilling screening samples. (Not ASP Category B samples.)

J = The concentration was detected at a value below the Reporting Limit (RL) and above the MDL

R = The result was rejected during data validation.

D = Diluted sample result

units = ug/L or parts per billion

NA = Not Available

NC = No Criteria

**Table 3a
Groundwater Sampling
VOC Data Summary**

Site Management Plan
Brownfield Cleanup Program No. C360115
1-5 Holland Avenue
White Plains, NY

Well ID:	MW-5DB	MW-5SB	MW-5SB	MW-5SB	MW-6 ¹	MW-6	MW-6	MW-6SB ¹	MW-6SB	FD-101811	
Screen Interval (ft above msl):	105.3 - 115.3	145.1 - 155.1	145.1 - 155.1	145.1 - 155.1	179.6 - 189.6	179.6 - 189.6	179.6 - 189.6	151.9 - 161.9	151.9 - 161.9	Blind Duplicate	
Date Sampled:	5/2/2012	5/5/2011	10/25/2011	5/2/2012	8/3/2011	10/18/2011	4/30/2012	8/3/2011	10/18/2011	10/18/2011	
Parameter	TOGS 1.1.1 GW STD										
VOLATILE ORGANIC COMPOUNDS (VOCs)											
Chloroform	7	<0.220	4.22	3.12	0.533 J	11.1	<0.340	<0.220	7.28	<0.340	<0.340
Chloromethane	5	<0.280	<0.430	<0.350	<0.280	<0.430	<0.350	<0.280	<0.430	<0.350	<0.350
cis-1,2-Dichloroethene	5	<0.300	<0.560	<0.380	<0.300	<0.560	<0.380	<0.300	<0.560	<0.380	<0.380
cis-1,3-Dichloropropene	0.4	<0.250	<0.360	<0.360	<0.250	<0.360	<0.360	<0.250	<0.360	<0.360	<0.360
Cyclohexane	NC	<0.380	<0.230	<0.460	<0.380	<0.230	<0.460	<0.380	<0.230	<0.460	<0.460
Dibromochloromethane	50	<0.240	<0.430	<0.360	<0.240	<0.430	<0.360	<0.240	<0.430	<0.360	<0.360
Dichlorodifluoromethane	5	<0.290	<0.420	<0.420	<0.290	<0.420	<0.420	<0.290	<0.420	<0.420	<0.420
Ethylbenzene	5	<0.220	<0.340	<0.340	<0.220	<0.340	<0.340	<0.220	<0.340	<0.340	<0.340
Isopropylbenzene	5	<0.210	<0.300	<0.390	<0.210	<0.300	<0.390	<0.210	<0.300	<0.390	<0.390
Methyl acetate	NC	<0.220	<0.600	<0.350	<0.220	<0.600	<0.350	<0.220	<0.600	<0.350	<0.350
Methyl tert-butyl ether (MTBE)	NC	<0.240	<0.450	<0.380	<0.240	<0.450	<0.380	<0.240	<0.450	<0.380	<0.380
Methylcyclohexane	NC	<0.360	<0.290	<0.460	<0.360	<0.290	<0.460	<0.360	<0.290	<0.460	<0.460
Methylene chloride	5	<1.98	<1.98	<1.98	<1.98	<1.98	<1.98	<1.98	<1.98	<1.98	<1.98
Styrene	5	<0.250	<0.380	<0.330	<0.250	<0.380	<0.330	<0.250	<0.380	<0.330	<0.330
Tetrachloroethene	5	4.08	37.6	5.67	24.1	<0.380	<0.470	<0.330	<0.380	<0.470	<0.470
Toluene	5	<0.270	<0.230	<0.390	<0.270	<0.230	<0.350	<0.270	<0.230	<0.390	<0.390
trans-1,2-Dichloroethene	5	<0.350	<0.500	<0.550	<0.350	<0.500	<0.550	<0.350	<0.500	<0.550	<0.550
trans-1,3-Dichloropropene	0.4	<0.220	<0.450	<0.320	<0.220	<0.450	<0.320	<0.220	<0.450	<0.320	<0.320
Trichloroethene	5	<0.270	<0.440	<0.550	<0.270	<0.440	<0.350	<0.270	<0.440	<0.550	<0.550
Trichlorofluoromethane	5	<0.450	<0.220	<0.660	<0.450	<0.220	<0.660	<0.450	<0.220	<0.660	<0.660
Vinyl Chloride	2	<0.290	<0.300	<0.460	<0.290	<0.300	<0.460	<0.290	<0.300	<0.460	<0.460
Xylenes (Total)	5	<0.690	<0.660	<0.630	<0.690	<0.660	<0.630	<0.690	<0.660	<0.630	<0.630
Total VOCs	NA	4.08	52	8.79	24.6 J	31.1	---	---	9.42 J	---	---

Notes:

and Operational Guidance Series: Ambient
ft above msl = feet above mean sea level

BOLD = Exceeds TOGS 1.1.1 Class GA Groundwater Standards/Criteria

* = Analyzed for but Not Detected at the Method Detection Limit (MDL)

¹ = Post drilling screening samples. (Not ASP Category B samples.)

J = The concentration was detected at a value below the Reporting Limit (RL) and above the MDL

R = The result was rejected during data validation.

D = Diluted sample result

units = ug/L or parts per billion

NA = Not Available

NC = No Criteria

**Table 3a
Groundwater Sampling
VOC Data Summary**

Site Management Plan
Brownfield Cleanup Program No. C360115
1-5 Holland Avenue
White Plains, NY

	Well ID:	MW-6SB	MW-7	MW-7	MW-7SB	MW-7SB	MW-8	MW-8	MW-8SB	MW-8SB	MW-9
	Screen Interval (ft above msl):	151.9 - 161.9	174.7 - 184.7	174.7 - 184.7	145.8 - 155.8	145.8 - 155.8	172.3 - 182.3	172.3 - 182.3	141.7 - 151.7	141.7 - 151.7	175.8 - 185.8
	Date Sampled:	4/30/2012	10/18/2011	5/1/2012	10/19/2011	5/2/2012	10/20/2011	4/30/2012	10/20/2011	4/30/2012	10/20/2011
Parameter	TOGS 1.1.1 GW STD										
VOLATILE ORGANIC COMPOUNDS (VOCs)											
1,1,1-Trichloroethane	5	<0.330	<0.350	<0.330	<0.350	<0.330	<0.350	<0.330	<0.700	<0.330	<0.350
1,1,2,2-Tetrachloroethane	5	<0.320	<0.310	<0.320	<0.310	<0.320	<0.310	<0.320	<0.620	<0.320	<0.310
1,1,2-Trichloro-1,2,2-trifluoroethane	5	<0.420	<0.440	<0.420	<0.440	<0.420	<0.440	<0.420	<0.880	<0.420	<0.440
1,1,2-Trichloroethane	1	<0.220	<0.360	<0.220	<0.360	<0.220	<0.360	<0.220	<0.720	<0.220	<0.360
1,1-Dichloroethane	5	<0.260	<0.430	<0.260	<0.430	<0.260	<0.430	<0.260	<0.860	<0.260	<0.430
1,1-Dichloroethene	5	<0.410	<0.710	<0.410	<0.710	<0.410	<0.710	<0.410	<1.42	<0.410	<0.710
1,2,3-Trichlorobenzene	5	<0.210	<0.420	<0.210	<0.420	<0.210	<0.420	<0.210	<0.840	<0.210	<0.420
1,2,4-Trichlorobenzene	5	<0.200	<0.390	<0.200	<0.390	<0.200	<0.390	<0.200	<0.780	<0.200	<0.390
1,2-Dibromo-3-chloropropane	0.04	<0.00855	<0.00855	<0.00855	<0.00855	<0.00855	<0.00855	<0.00855	<0.00855	<0.00855	<0.00855
1,2-Dibromoethane (EDB)	0.0006	<0.00855	<0.00855	<0.00855	<0.00855	<0.00855	<0.00855	<0.00855	<0.00855	<0.00855	<0.00855
1,2-Dichlorobenzene	3	<0.230	<0.360	<0.230	<0.360	<0.230	<0.360	<0.230	<0.720	<0.230	<0.360
1,2-Dichloroethane (EDC)	0.6	<0.200	<0.420	<0.200	<0.420	<0.200	<0.420	<0.200	<0.840	<0.200	<0.420
1,2-Dichloropropane	1	<0.250	<0.520	<0.250	<0.520	<0.250	<0.520	<0.250	<1.04	<0.250	<0.520
1,3-Dichlorobenzene	3	<0.230	<0.420	<0.230	<0.420	<0.230	<0.420	<0.230	<0.840	<0.230	<0.420
1,4-Dichlorobenzene	3	<0.230	<0.330	<0.230	<0.330	<0.230	<0.330	<0.230	<0.660	<0.230	<0.330
1,4-Dioxane	NC	<0.301	<22.5 R	<0.301	<22.5 R	<0.301	<22.5 R	<0.301	<45.1 R	<0.301	<22.5 R
2-Butanone (MEK)	50	<0.550	<0.630	<0.550	<0.630	<0.550	<0.630	<0.550	<1.26	<0.550	<0.630
2-Hexanone	50	<0.370	<0.260	<0.370	<0.260	<0.370	<0.260	<0.370	<0.520	<0.370	<0.260
4-Methyl-2-pentanone (MIBK)	NC	<0.350	<0.510	<0.350	<0.510	<0.350	<0.510	<0.350	<1.02	<0.350	<0.510
Acetone	50	<0.280	<0.870	<0.280	<0.870	<0.280	<0.870	<0.280	<1.74	<0.280	<0.870
Benzene	1	<0.250	<0.430	<0.250	<0.430	<0.250	<0.430	<0.250	<0.860	<0.250	<0.430
Bromochloromethane	5	<0.300	<0.470	<0.300	<0.470	<0.300	<0.470	<0.300	<0.940	<0.300	<0.470
Bromodichloromethane	50	<0.260	<0.350	<0.260	<0.350	<0.260	<0.350	<0.260	<0.700	<0.260	<0.350
Bromoform	50	<0.460	<0.260	<0.460	<0.260	<0.460	<0.260	<0.460	<0.520	<0.460	<0.260
Bromomethane	5	<0.250	<0.670	<0.250	<0.510	<0.250	<0.510	<0.250	<1.34	<0.250	<0.670
Carbon disulfide	NC	<0.300	<0.500	<0.300	<0.670	<0.300	<0.670	<0.300	<1.00	<0.300	<0.500
Carbon tetrachloride	5	<0.360	<0.400	<0.360	<0.500	<0.360	<0.500	<0.360	<0.800	<0.360	<0.400
Chlorobenzene	5	<0.220	<0.480	<0.220	<0.400	<0.220	<0.400	<0.220	<0.960	<0.220	<0.480
Chloroethane	5	<0.360	<0.780	<0.360	<0.480	<0.360	<0.480	<0.360	<1.56	<0.360	<0.780

Notes:

and Operational Guidance Series: Ambient

ft above msl = feet above mean sea level

BOLD = Exceeds TOGS 1.1.1 Class GA Groundwater Standards/Criteria

* = Analyzed for but Not Detected at the Method Detection Limit (MDL)

¹ = Post drilling screening samples. (Not ASP Category B samples.)

J = The concentration was detected at a value below the Reporting Limit (RL) and above the MDL

R = The result was rejected during data validation.

D = Diluted sample result

units = ug/L or parts per billion

NA = Not Available

NC = No Criteria

**Table 3a
Groundwater Sampling
VOC Data Summary**

Site Management Plan
Brownfield Cleanup Program No. C360115
1-5 Holland Avenue
White Plains, NY

Well ID:	MW-6SB	MW-7	MW-7	MW-7SB	MW-7SB	MW-8	MW-8	MW-8SB	MW-8SB	MW-9	
Screen Interval (ft above msl):	151.9 - 161.9	174.7 - 184.7	174.7 - 184.7	145.8 - 155.8	145.8 - 155.8	172.3 - 182.3	172.3 - 182.3	141.7 - 151.7	141.7 - 151.7	175.8 - 185.8	
Date Sampled:	4/30/2012	10/18/2011	5/1/2012	10/19/2011	5/2/2012	10/20/2011	4/30/2012	10/20/2011	4/30/2012	10/20/2011	
Parameter	TOGS 1.1.1 GW STD										
VOLATILE ORGANIC COMPOUNDS (VOCs)											
Chloroform	7	<0.220	<0.340	<0.220	0.635 J	0.868 J	<0.340	<0.220	2.23	<0.220	9.28
Chloromethane	5	<0.280	<0.350	<0.280	<0.350	<0.280	<0.350	<0.280	<0.700	<0.280	<0.350
cis-1,2-Dichloroethene	5	<0.300	<0.380	<0.300	1.03	<0.300	2.21	8.56	7.32	3.98	<0.380
cis-1,3-Dichloropropene	0.4	<0.250	<0.360	<0.250	<0.360	<0.250	<0.360	<0.250	<0.720	<0.250	<0.360
Cyclohexane	NC	<0.380	<0.460	<0.380	<0.460	<0.380	<0.460	<0.380	<0.920	<0.380	<0.460
Dibromochloromethane	50	<0.240	<0.360	<0.240	<0.360	<0.240	<0.360	<0.240	<0.720	<0.240	<0.360
Dichlorodifluoromethane	5	<0.290	<0.420	<0.290	<0.420	<0.290	<0.420	<0.290	<0.840	<0.290	<0.420
Ethylbenzene	5	<0.220	<0.340	<0.220	<0.340	<0.220	<0.340	<0.220	<0.680	<0.220	<0.340
Isopropylbenzene	5	<0.210	<0.390	<0.210	<0.390	<0.210	<0.390	<0.210	<0.780	<0.210	<0.390
Methyl acetate	NC	<0.220	<0.350	<0.220	<0.350	<0.220	<0.350	<0.220	<0.700	<0.220	<0.350
Methyl tert-butyl ether (MTBE)	NC	<0.240	<0.380	<0.240	<0.380	<0.240	<0.380	<0.240	<0.760	<0.240	<0.380
Methylcyclohexane	NC	<0.360	<0.460	<0.360	<0.460	<0.360	<0.460	<0.360	<0.920	<0.360	<0.460
Methylene chloride	5	<1.98	<1.98	<1.98	<1.98	<1.98	<1.98	<1.98	<3.96	<1.98	<1.98
Styrene	5	<0.250	<0.330	<0.250	<0.330	<0.250	<0.330	<0.250	<0.660	<0.250	<0.330
Tetrachloroethene	5	<0.330	26.2	9.53	24.7	16	21.3	26.3	250	217 D	<0.470
Toluene	5	<0.270	<0.390	<0.270	<0.390	<0.270	<0.390	<0.270	<0.780	<0.270	<0.390
trans-1,2-Dichloroethene	5	<0.350	<0.550	<0.350	<0.550	<0.350	<0.550	<0.350	<1.10	<0.350	<0.550
trans-1,3-Dichloropropene	0.4	<0.220	<0.320	<0.220	<0.320	<0.220	<0.320	<0.220	<0.640	<0.220	<0.320
Trichloroethene	5	<0.270	<0.550	<0.270	6.71	2.81	0.598 J	<0.270	8.99	9.22	<0.550
Trichlorofluoromethane	5	<0.450	<0.660	<0.450	<0.660	<0.450	<0.660	<0.450	<1.32	<0.450	<0.660
Vinyl Chloride	2	<0.290	<0.460	<0.290	<0.460	<0.290	2.67	3.34	<0.920	<0.290	<0.460
Xylenes (Total)	5	<0.690	<0.630	<0.690	<0.630	<0.690	<0.630	<0.690	<1.26	<0.690	<0.630
Total VOCs	NA	---	26.2	9.53	33.1 J	19.7 J	26.8 J	39.5	269	230	9.28

Notes:

and Operational Guidance Series: Ambient
ft above msl = feet above mean sea level

BOLD = Exceeds TOGS 1.1.1 Class GA Groundwater Standards/Criteria

* = Analyzed for but Not Detected at the Method Detection Limit (MDL)

¹ = Post drilling screening samples. (Not ASP Category B samples.)

J = The concentration was detected at a value below the Reporting Limit (RL) and above the MDL

R = The result was rejected during data validation.

D = Diluted sample result

units = ug/L or parts per billion

NA = Not Available

NC = No Criteria

**Table 3a
Groundwater Sampling
VOC Data Summary**

Site Management Plan
Brownfield Cleanup Program No. C360115
1-5 Holland Avenue
White Plains, NY

	Well ID:	MW-9	MW-9SB	MW-9SB						
	Screen Interval (ft above msl):	175.8 - 185.8	144.8 - 155.8	144.8 - 155.8						
	Date Sampled:	5/1/2012	10/20/2011	5/2/2012						
Parameter	TOGS 1.1.1 GW STD									
VOLATILE ORGANIC COMPOUNDS (VOCs)										
1,1,1-Trichloroethane	5	<0.330	<0.350	<0.330						
1,1,2,2-Tetrachloroethane	5	<0.320	<0.310	<0.320						
1,1,2-Trichloro-1,2,2-trifluoroethane	5	<0.420	<0.440	<0.420						
1,1,2-Trichloroethane	1	<0.220	<0.360	<0.220						
1,1-Dichloroethane	5	<0.260	<0.430	<0.260						
1,1-Dichloroethene	5	<0.410	<0.710	<0.410						
1,2,3-Trichlorobenzene	5	<0.210	<0.420	<0.210						
1,2,4-Trichlorobenzene	5	<0.200	<0.390	<0.200						
1,2-Dibromo-3-chloropropane	0.04	<0.00855	<0.00855	<0.00855						
1,2-Dibromoethane (EDB)	0.0006	<0.00855	<0.00855	<0.00855						
1,2-Dichlorobenzene	3	<0.230	<0.360	<0.230						
1,2-Dichloroethane (EDC)	0.6	<0.200	<0.420	<0.200						
1,2-Dichloropropane	1	<0.250	<0.520	<0.250						
1,3-Dichlorobenzene	3	<0.230	<0.420	<0.230						
1,4-Dichlorobenzene	3	<0.230	<0.330	<0.230						
1,4-Dioxane	NC	<0.301	<22.5 R	<0.301						
2-Butanone (MEK)	50	<0.550	<0.630	<0.550						
2-Hexanone	50	<0.370	<0.260	<0.370						
4-Methyl-2-pentanone (MIBK)	NC	<0.350	<0.510	<0.350						
Acetone	50	<0.280	<0.870	<0.280						
Benzene	1	<0.250	2	<0.250						
Bromochloromethane	5	<0.300	<0.470	<0.300						
Bromodichloromethane	50	<0.260	<0.350	<0.260						
Bromoform	50	<0.460	<0.260	<0.460						
Bromomethane	5	<0.250	<0.670	<0.250						
Carbon disulfide	NC	<0.300	<0.500	<0.300						
Carbon tetrachloride	5	<0.360	<0.400	<0.360						
Chlorobenzene	5	<0.220	<0.480	<0.220						
Chloroethane	5	<0.360	<0.780	<0.360						

Notes:

and Operational Guidance Series: Ambient

ft above msl = feet above mean sea level

BOLD = Exceeds TOGS 1.1.1 Class GA Groundwater Standards/Criteria

* = Analyzed for but Not Detected at the Method Detection Limit (MDL)

¹ = Post drilling screening samples. (Not ASP Category B samples.)

J = The concentration was detected at a value below the Reporting Limit (RL) and above the MDL

R = The result was rejected during data validation.

D = Diluted sample result

units = ug/L or parts per billion

NA = Not Available

NC = No Criteria

**Table 3a
Groundwater Sampling
VOC Data Summary**

Site Management Plan
Brownfield Cleanup Program No. C360115
1-5 Holland Avenue
White Plains, NY

	Well ID:	MW-9	MW-9SB	MW-9SB						
	Screen Interval (ft above msl):	175.8 - 185.8	144.8 - 155.8	144.8 - 155.8						
	Date Sampled:	5/1/2012	10/20/2011	5/2/2012						
Parameter	TOGS 1.1.1 GW STD									
VOLATILE ORGANIC COMPOUNDS (VOCs)										
Chloroform	7	<0.220	3.81	0.563 J						
Chloromethane	5	<0.280	<0.350	<0.280						
cis-1,2-Dichloroethene	5	<0.300	1.55	1.14						
cis-1,3-Dichloropropene	0.4	<0.250	<0.360	<0.250						
Cyclohexane	NC	<0.380	<0.460	<0.380						
Dibromochloromethane	50	<0.240	<0.360	<0.240						
Dichlorodifluoromethane	5	<0.290	<0.420	<0.290						
Ethylbenzene	5	<0.220	<0.340	<0.220						
Isopropylbenzene	5	<0.210	<0.390	<0.210						
Methyl acetate	NC	<0.220	<0.350	<0.220						
Methyl tert-butyl ether (MTBE)	NC	<0.240	<0.380	<0.240						
Methylcyclohexane	NC	<0.360	<0.460	<0.360						
Methylene chloride	5	<1.98	<1.98	<1.98						
Styrene	5	<0.250	<0.330	<0.250						
Tetrachloroethene	5	<0.330	1.23	1.09						
Toluene	5	<0.270	<0.390	<0.270						
trans-1,2-Dichloroethene	5	<0.350	<0.550	<0.350						
trans-1,3-Dichloropropene	0.4	<0.220	<0.320	<0.220						
Trichloroethene	5	<0.270	<0.550	<0.270						
Trichlorofluoromethane	5	<0.450	<0.660	<0.450						
Vinyl Chloride	2	<0.290	<0.460	<0.290						
Xylenes (Total)	5	<0.690	<0.630	<0.690						
Total VOCs	NA	---	8.59	2.79 J						

Notes:

and Operational Guidance Series: Ambient

ft above msl = feet above mean sea level

BOLD = Exceeds TOGS 1.1.1 Class GA Groundwater Standards/Criteria

* = Analyzed for but Not Detected at the Method Detection Limit (MDL)

¹= Post drilling screening samples. (Not ASP Category B samples.)

J = The concentration was detected at a value below the Reporting Limit (RL) and above the MDL

R = The result was rejected during data validation.

D = Diluted sample result

units = ug/L or parts per billion

NA = Not Available

NC = No Criteria

**Table 3b
Groundwater Sampling Metals Data Summary**

Remedial Investigation
Brownfield Cleanup Program No. C360115
1-5 Holland Avenue
White Plains, NY

Parameter	Well ID:	MW-1	MW-1	MW-2	MW-2	MW-2DB	MW-2DB	MW-2DB	MW-2SB	MW-2SB	MW-2SB
	Screen Interval (ft above msl):	182.7 - 192.7	182.7 - 192.7	181.4 - 191.4	181.4 - 191.4	126.3 - 136.3	126.3 - 136.3	126.3 - 136.3	148.9 - 158.9	148.9 - 158.9	148.9 - 158.9
	Date Sampled:	10/19/2011	5/1/2012	10/21/2011	5/2/2012	5/5/2011	10/20/2011	5/2/2012	5/5/2011	10/21/2011	5/2/2012
	TOGS 1.1.1 GW STD										
Aluminum	NC	417	202	153	29.8 J	NA	37.7 J	248	NA	30.6 J	20.8 J
Antimony	3	<1.00	<1.00	<1.00	<1.00	NA	<1.00	<1.00	NA	<1.00	<1.00
Arsenic	25	<1.00	<1.00	<1.00	<1.00	NA	1.20 J	1.36 J	NA	<1.00	<1.00
Barium	1000	52.4	118	57.8	78.5	NA	70.5	87.4	NA	45.4	56.2
Beryllium	3	<1.00	<1.00	<1.00	<1.00	NA	<1.00	<1.00	NA	<1.00	<1.00
Cadmium	5	<0.500	<0.500	<0.500	<0.500	NA	<0.500	<0.500	NA	<0.500	<0.500
Calcium	NC	45300	96600	40000	79900	NA	28100	33300	NA	33500	35700
Chromium	50	2.14 J	<2.00	<2.00	<2.00	NA	<2.00	<2.00	NA	<2.00	<2.00
Cobalt	NC	<2.00	<2.00	<2.00	<2.00	NA	<2.00	<2.00	NA	<2.00	<2.00
Copper	200	<2.00	<4.00	<2.00	<2.00	NA	2.04 J	4.69 J	NA	<2.00	<4.00
Iron	300	630	372 J	404	132 R	NA	307	474 J	NA	82.0 J	108 R
Lead	25	0.678 J	0.62 J	0.741 J	<0.500	NA	1.71 J	3.57	NA	1.50 J	1.51 J
Magnesium	35000	20200	42300	17200	34300	NA	16900	18200	NA	20100	22300
Manganese	300	54.5	38.3	48	6.31	NA	4.66	8.10	NA	6.42	5.77
Mercury	0.7	<0.300	<0.300	<0.300	<0.300	NA	<0.300	<0.300	NA	<0.300	<0.300
Nickel	100	<1.00	<1.00	<1.00	<1.00	NA	<1.00	<1.00	NA	<1.00	<1.00
Potassium	NC	1720	2670	3340	3060	NA	4090	3690	NA	2810	3170
Selenium	10	<4.00	<4.00	<4.00	<4.00	NA	<4.00	<4.00	NA	<4.00	<4.00
Silver	50	<0.500	<0.500	<0.500	<0.500	NA	<0.500	<0.500	NA	<0.500	<0.500
Sodium	20000	22000	70400	50900	27400	NA	16300	16800	NA	8400	9270
Thallium	0.5	<0.500	<0.500	<0.500	<0.500	NA	<0.500	<0.500	NA	<0.500	<0.500
Vanadium	NC	2.30 J	<2.00	<2.00	<2.00	NA	<2.00	<2.00	NA	<2.00	<2.00
Zinc	2000	<4.00	<4.00	<4.00	<4.00	NA	<4.00	<4.00	NA	<4.00	<4.00
Cyanide, Total	200	NA	<14.0	NA	<14.0	NA	NA	<14.0	NA	NA	<14.0
Hexavalent Chromium	50	<5.00	<6.00	<5.00	<6.00	NA	<5.00	<6.00	NA	<5.00	<6.00

Notes:

TOGS 1.1.1 = Division of Water Technical and Operational Guidance Series: Ambient Water Quality Standards and Guidance Values and Groundwater Effluent Limitations

ft above msl = feet above mean sea level

BOLD = Exceeds TOGS 1.1.1 Class GA Groundwater Standards/Criteria

* = Analyzed for but Not Detected at the Method Detection Limit (MDL)

¹ = Post drilling screening samples. (Not ASP Category B samples.)

J = The concentration was detected at a value below the Reporting Limit (RL) and above the MDL

R = The concentration was rejected during the data validation process

units = ug/L or parts per billion

NA = Not Available

NC = No Criteria

Table 3b
Groundwater Sampling Metals Data Summary

Remedial Investigation
Brownfield Cleanup Program No. C360115
1-5 Holland Avenue
White Plains, NY

Well ID:	BD-05/12	MW-4D	MW-4D	MW-4D	MW-4S	MW-4S	MW-5	MW-5	MW-5DB	MW-5DB	
Screen Interval (ft above msl):	148.9 - 158.9	158 - 168	158 - 168	158 - 168	178.4 - 188.5	178.4 - 188.5	179.7 - 189.7	179.7 - 189.7	105.3 - 115.3	105.3 - 115.3	
Date Sampled:	5/2/2012	5/5/2011	10/19/2011	5/1/2012	10/19/2011	5/1/2012	10/21/2011	5/2/2012	5/5/2011	10/21/2011	
Parameter	TOGS 1.1.1 GW STD										
Aluminum	NC	28.8 J	NA	75.6	46.5	132	163	69.8	47.3	NA	63.5
Antimony	3	<1.00	NA	<1.00	<1.00	<1.00	<1.00	<1.00	<1.00	NA	<1.00
Arsenic	25	<1.00	NA	<1.00	<1.00	<1.00	<1.00	<1.00	<1.00	NA	<1.00
Barium	1000	48.8	NA	36.6 J	39 J	36.6 J	41.7	36.7	34.7 J	NA	45.4
Beryllium	3	<1.00	NA	<1.00	<1.00	<1.00	<1.00	<1.00	<1.00	NA	<1.00
Cadmium	5	<0.500	NA	<0.500	<0.500	<0.500	<0.500	<0.500	<0.500	NA	<0.500
Calcium	NC	36500	NA	49800	55200	42300	47100	36500	44800	NA	13200
Chromium	50	<2.00	NA	<2.00	<2.00	2.34 J	<2.00	<2.00	<2.00	NA	2.92 J
Cobalt	NC	<2.00	NA	<2.00	<2.00	<2.00	<2.00	<2.00	<2.00	NA	<2.00
Copper	200	<4.00	NA	<2.00	<4.00	<2.00	<4.00	<2.00	<4.00	NA	<2.00
Iron	300	<50.0 J	NA	115	190 R	224	411 J	202	122 R	NA	69
Lead	25	1.22 J	NA	<0.50	0.683 J	0.695 J	1.22 J	<0.500	<0.500	NA	0.651 J
Magnesium	35000	22500	NA	23800	26100	17500	19300	11900	18700	NA	13000
Manganese	300	5.77	NA	9.97	4.72	34.9	55.8	11.9	4.97	NA	4.64
Mercury	0.7	<0.300	NA	<0.300	<0.300	<0.300	<0.300	<0.300	<0.300	NA	<0.300
Nickel	100	<1.00	NA	<1.00	<1.00	<1.00	<1.00	<1.00	<1.00	NA	<1.00
Potassium	NC	3350	NA	1490	1680	1740	1870	1400	1490	NA	9900
Selenium	10	<4.00	NA	<4.00	<4.00	<4.00	<4.00	<4.00	<4.00	NA	<4.00
Silver	50	<0.500	NA	<0.500	<0.500	<0.500	<0.500	<0.500	<0.500	NA	<0.500
Sodium	20000	9470	NA	8720	9390	12800	12300	28400	9270	NA	30000
Thallium	0.5	<0.500	NA	<0.500	<0.500	<0.500	<0.500	<0.500	<0.500	NA	<0.500
Vanadium	NC	<2.00	NA	<2.00	<2.00	<2.00	<2.00	<2.00	<2.00	NA	<2.00
Zinc	2000	<4.00	NA	<4.00	<4.00	<4.00	<4.00	<4.00	<4.00	NA	<4.00
Cyanide, Total	200	<14.0	NA	NA	<14.0	NA	<14.0	NA	<14.0	NA	NA
Hexavalent Chromium	50	<6.00	NA	<5.00	<6.00	<5.00	<6.00	<5.00	<6.00	NA	<5.00

Notes:

TOGS 1.1.1 = Division of Water Technical and Operational Guidance Series: Ambient Water Quality Standards and Guidance Values and Groundwater Effluent Limitations
ft above msl = feet above mean sea level

BOLD = Exceeds TOGS 1.1.1 Class GA Groundwater Standards/Criteria

* = Analyzed for but Not Detected at the Method Detection Limit (MDL)

¹ = Post drilling screening samples. (Not ASP Category B samples.)

J = The concentration was detected at a value below the Reporting Limit (RL) and above the MDL

R = The concentration was rejected during the data validation process

units = ug/L or parts per billion

NA = Not Available

NC = No Criteria

**Table 3b
Groundwater Sampling Metals Data Summary**

Remedial Investigation
Brownfield Cleanup Program No. C360115
1-5 Holland Avenue
White Plains, NY

Well ID:	MW-5DB	MW-5SB	MW-5SB	MW-5SB	MW-6 ¹	MW-6	MW-6	MW-6SB ¹	MW-6SB	FD-101811	
Screen Interval (ft above msl):	105.3 - 115.3	145.1 - 155.1	145.1 - 155.1	145.1 - 155.1	179.6 - 189.6	179.6 - 189.6	179.6 - 189.6	151.9 - 161.9	151.9 - 161.9	Blind Duplicate	
Date Sampled:	5/2/2012	5/5/2011	10/25/2011	5/2/2012	8/3/2011	10/18/2011	4/30/2012	8/3/2011	10/18/2011	10/18/2011	
Parameter	TOGS 1.1.1 GW STD										
Aluminum	NC	308	NA	96.5	152	NA	438	188	NA	290	267
Antimony	3	<1.00	NA	<1.00	<1.00	NA	<1.00	<1.00	NA	<1.00	5.74
Arsenic	25	1.11 J	NA	<1.00	<1.00	NA	<1.00	<1.00	NA	<1.00	<1.00
Barium	1000	41.7	NA	124	120	NA	88.6	167	NA	33.8 J	37.8 J
Beryllium	3	<1.00	NA	<1.00	<1.00	NA	<1.00	<1.00	NA	<1.00	<1.00
Cadmium	5	<0.500	NA	<0.500	<0.500	NA	<0.500	<0.500	NA	<0.500	<0.500
Calcium	NC	13600	NA	178000	288000	NA	106000	152000	NA	51100	55200
Chromium	50	<2.00	NA	8.05	7.19 J	NA	<2.00	<2.00	NA	<2.00	<2.00
Cobalt	NC	<2.00	NA	<2.00	<2.00	NA	<2.00	<2.00	NA	<2.00	<2.00
Copper	200	<4.00	NA	3.65	4.14 J	NA	4.01 J	<4.00	NA	<2.00	<2.00
Iron	300	253 R	NA	798	1280 J	NA	1400	296 J	NA	344	316
Lead	25	1.98 J	NA	6.75	11.4	NA	<0.500	<0.500	NA	<0.500	<0.500
Magnesium	35000	12500	NA	99700	148000	NA	47000	66600	NA	25000	27000
Manganese	300	7.54	NA	68.4	132	NA	724	579	NA	47.7	69.6
Mercury	0.7	<0.300	NA	<0.300	<0.300	NA	<0.300	<0.300	NA	<0.300	<0.300
Nickel	100	<1.00	NA	<1.00	<1.00	NA	1.49 J	<1.00	NA	<1.00	<1.00
Potassium	NC	7910	NA	4720	4210	NA	6280	6090	NA	1340	1400
Selenium	10	<4.00	NA	<4.00	<4.00	NA	<4.00	<4.00	NA	<4.00	<4.00
Silver	50	<0.500	NA	<0.500	<0.500	NA	<0.500	<0.500	NA	<0.500	<0.500
Sodium	20000	30100	NA	24300	16900	NA	60000	88900	NA	7740	8130
Thallium	0.5	<0.500	NA	<0.500	<0.500	NA	<0.500	<0.500	NA	<0.500	<0.500
Vanadium	NC	<2.00	NA	<2.00	2.53 J	NA	<2.00	<2.00	NA	<2.00	<2.00
Zinc	2000	16.7	NA	<4.00	23.7	NA	<4.00	<4.00	NA	<4.00	<4.00
Cyanide, Total	200	<14.0	NA	NA	<14.0	NA	NA	<14.0	NA	NA	NA
Hexavalent Chromium	50	<6.00	NA	7.00 J	<6.00	NA	<5.00	<6.00	NA	<5.00	<5.00

Notes:

TOGS 1.1.1 = Division of Water Technical and Operational Guidance Series: Ambient Water Quality Standards and Guidance Values and Groundwater Effluent Limitations
ft above msl = feet above mean sea level

BOLD = Exceeds TOGS 1.1.1 Class GA Groundwater Standards/Criteria

* = Analyzed for but Not Detected at the Method Detection Limit (MDL)

¹ = Post drilling screening samples. (Not ASP Category B samples.)

J = The concentration was detected at a value below the Reporting Limit (RL) and above the MDL

R = The concentration was rejected during the data validation process

units = ug/L or parts per billion

NA = Not Available

NC = No Criteria

Table 3b
Groundwater Sampling Metals Data Summary

Remedial Investigation
Brownfield Cleanup Program No. C360115
1-5 Holland Avenue
White Plains, NY

Well ID:	MW-6SB	MW-7	MW-7	MW-7SB	MW-7SB	MW-8	MW-8	MW-8SB	MW-8SB	MW-9	
Screen Interval (ft above msl):	151.9 - 161.9	174.7 - 184.7	174.7 - 184.7	145.8 - 155.8	145.8 - 155.8	172.3 - 182.3	172.3 - 182.3	141.7 - 151.7	141.7 - 151.7	175.8 - 185.8	
Date Sampled:	4/30/2012	10/18/2011	5/1/2012	10/19/2011	5/2/2012	10/20/2011	4/30/2012	10/20/2011	4/30/2012	10/20/2011	
Parameter	TOGS 1.1.1 GW STD										
Aluminum	NC	105	206	101	187	388	396	72.6	373	<20.0	685
Antimony	3	<1.00	<1.00	2.24 J	<1.00	<1.00	<1.00	<1.00	<1.00	<1.00	<1.00
Arsenic	25	<1.00	<1.00	<1.00	<1.00	<1.00	<1.00	2.32	<1.00	<1.00	<1.00
Barium	1000	34.8 J	55.6	59.7	198	194	187	215	257	284	114
Beryllium	3	<1.00	<1.00	<1.00	<1.00	<1.00	<1.00	<1.00	<1.00	<1.00	<1.00
Cadmium	5	<0.500	<0.500	<0.500	9.12	204	<0.500	<0.500	<0.500	<0.500	<0.500
Calcium	NC	55800	58900	62400	98600	139000	77100	85600	147000	157000	84600
Chromium	50	<2.00	<2.00	<2.00	10.3	<2.00	<2.00	<2.00	<2.00	<2.00	33.7
Cobalt	NC	<2.00	<2.00	<2.00	<2.00	<2.00	<2.00	<2.00	<2.00	<2.00	<2.00
Copper	200	<4.00	<2.00	<4.00	19.5	35.1	4.45 J	<4.00	2.04 J	<4.00	2.48 J
Iron	300	183 R	306	162 R	403	1730 J	1100	4640	1120	<50.0	1130
Lead	25	0.530 J	0.794 J	0.751 J	20.1	19.4	8.37	1.26 J	2.36	<0.500	1.69 J
Magnesium	35000	25300	24700	29900	46600	55700	31500	34600	64900	60500	24100
Manganese	300	31.0	40.2	7.99	14.5	41.9	1290	559	46.2	12.6	147
Mercury	0.7	<0.300	<0.300	<0.300	<0.300	<0.300	<0.300	<0.300	<0.300	<0.300	<0.300
Nickel	100	<1.00	<1.00	<1.00	<1.00	<1.00	<1.00	<1.00	<1.00	<1.00	<1.00
Potassium	NC	1660	2940	2490	23300	11100	5280	5070	21000	19500	30300
Selenium	10	<4.00	<4.00	<4.00	<4.00	<4.00	<4.00	<4.00	<4.00	<4.00	4.11 J
Silver	50	<0.500	<0.500	<0.500	<0.500	<0.500	<0.500	<0.500	<0.500	<0.500	<0.500
Sodium	20000	9040	37400	44300	54700	146000	200000	231000	119000	129000	202000
Thallium	0.5	<0.500	<0.500	<0.500	<0.500	<0.500	<0.500	<0.500	<0.500	<0.500	<0.500
Vanadium	NC	<2.00	<2.00	<2.00	<2.00	2.27 J	<2.00	<2.00	<2.00	<2.00	2.36 J
Zinc	2000	<4.00	<4.00	8.5 R	<4.00	30.5	<4.00	11.0 R	<4.00	<4.00	<4.00
Cyanide, Total	200	<14.0	NA	<14.0	NA	<14.0	NA	<14.0	NA	<14.0	NA
Hexavalent Chromium	50	<6.00	<5.00	<6.00	9.00 J	<6.00	<5.00	<6.00	<5.00	<6.00	33

Notes:

TOGS 1.1.1 = Division of Water Technical and Operational Guidance Series: Ambient Water Quality Standards and Guidance Values and Groundwater Effluent Limitations
ft above msl = feet above mean sea level

BOLD = Exceeds TOGS 1.1.1 Class GA Groundwater Standards/Criteria

* = Analyzed for but Not Detected at the Method Detection Limit (MDL)

¹ = Post drilling screening samples. (Not ASP Category B samples.)

J = The concentration was detected at a value below the Reporting Limit (RL) and above the MDL

R = The concentration was rejected during the data validation process

units = ug/L or parts per billion

NA = Not Available

NC = No Criteria

Table 3b
Groundwater Sampling Metals Data Summary

Remedial Investigation
Brownfield Cleanup Program No. C360115
1-5 Holland Avenue
White Plains, NY

	Well ID:	MW-9	MW-9SB	MW-9SB						
	Screen Interval (ft above msl):	175.8 - 185.8	144.8 - 155.8	144.8 - 155.8						
	Date Sampled:	5/1/2012	10/20/2011	5/2/2012						
Parameter	TOGS 1.1.1 GW STD									
Aluminum	NC	1160	69.9	71.2						
Antimony	3	<1.00	2.05 J	<1.00						
Arsenic	25	<1.00	<1.00	1.10 J						
Barium	1000	31 J	95.3	137						
Beryllium	3	<1.00	<1.00	<1.00						
Cadmium	5	<0.500	<0.500	<0.500						
Calcium	NC	34800	31300	52600						
Chromium	50	<2.00	7.52 J	<2.00						
Cobalt	NC	<2.00	<2.00	<2.00						
Copper	200	<4.00	<2.00	<4.00						
Iron	300	171 R	202	208 R						
Lead	25	0.713 J	0.575 J	0.541 J						
Magnesium	35000	10900	19500	23400						
Manganese	300	23	2.42 J	10.3						
Mercury	0.7	<0.300	<0.300	<0.300						
Nickel	100	<1.00	<1.00	<1.00						
Potassium	NC	7120	11600	7050						
Selenium	10	<4.00	<4.00	<4.00						
Silver	50	<0.500	<0.500	<0.500						
Sodium	20000	41500	19800	24800						
Thallium	0.5	<0.500	<0.500	<0.500						
Vanadium	NC	<2.00	<2.00	<2.00						
Zinc	2000	9.02 R	<4.00	<4.00						
Cyanide, Total	200	<14.0	NA	<14.0						
Hexavalent Chromium	50	<6.00	7.00 J	<6.00						

Notes:

TOGS 1.1.1 = Division of Water Technical and Operational Guidance Series: Ambient Water Quality Standards and Guidance Values and Groundwater Effluent Limitations
ft above msl = feet above mean sea level

BOLD = Exceeds TOGS 1.1.1 Class GA Groundwater Standards/Criteria

* = Analyzed for but Not Detected at the Method Detection Limit (MDL)

¹ = Post drilling screening samples. (Not ASP Category B samples.)

J = The concentration was detected at a value below the Reporting Limit (RL) and above the MDL

R = The concentration was rejected during the data validation process

units = ug/L or parts per billion

NA = Not Available

NC = No Criteria

Table 4
Soil Cleanup Objectives

Remedial Investigation
Brownfield Cleanup Program No. C360115
1-5 Holland Ave
White Plains, NY

Parameter (mg/kg or ppm)	Part 375 Restricted Commercial
1,1,1-Trichloroethane	500
1,1,2,2-Tetrachloroethane	NS
1,1,2-Trichloro-1,2,2-trifluoroethane	NS
1,1,2-Trichloroethane	NS
1,1-Dichloroethane	240
1,1-Dichloroethene	500
1,2,3-Trichlorobenzene	NS
1,2,4-Trichlorobenzene	NS
1,2-Dibromo-3-chloropropane	NS
1,2-Dibromoethane (EDB)	NS
1,2-Dichlorobenzene	500
1,2-Dichloroethane (EDC)	30
1,2-Dichloropropane	NS
1,3-Dichlorobenzene	280
1,4-Dichlorobenzene	130
2-Butanone (MEK)	500
2-Hexanone	NS
4-Methyl-2-pentanone (MIBK)	NS
Acetone	500
Benzene	44
Bromochloromethane	NS
Bromodichloromethane	NS
Bromoform	NS
Bromomethane	NS
Carbon disulfide	NS
Carbon tetrachloride	22
Chlorobenzene	500
Chloroethane	NS
Chloroform	350
Chloromethane	NS
cis-1,2-Dichloroethene	500
cis-1,3-Dichloropropene	NS
Cyclohexane	NS
Dibromochloromethane	NS
Dichlorodifluoromethane	NS
Ethylbenzene	390
Isopropylbenzene	NS

Parameter (mg/kg or ppm)	Part 375 Restricted Commercial
Methyl acetate	NS
Methyl tert-butyl ether (MTBE)	500
Methylcyclohexane	NS
Methylene chloride	500
Styrene	NS
Tetrachloroethene	150
Toluene	500
trans-1,2-Dichloroethene	500
trans-1,3-Dichloropropene	NS
Trichloroethene	200
Trichlorofluoromethane	NS
Vinyl chloride	13
Xylenes (total)	500
1,4-Dioxane	130
2-Methylphenol	500
4-Methylphenol	500
Acenaphthene	500
Acenaphthylene	500
Anthracene	500
Benzo[a]anthracene	5.6
Benzo[a]pyrene	1
Benzo[b]fluoranthene	5.6
Benzo[g,h,i]perylene	500
Benzo[k]fluoranthene	56
Chrysene	56
Dibenz[a,h]anthracene	0.56
Fluoranthene	500
Fluorene	500
Hexachlorobenzene	NS
Indeno[1,2,3-cd]pyrene	5.6
Naphthalene	500
Pentachlorophenol	6.7
Phenanthrene	500
Phenol	500
Pyrene	500
Aluminum	NS
Antimony	NS

Parameter (mg/kg or ppm)	Part 375 Restricted Commercial
Arsenic	16
Barium	400
Beryllium	590
Cadmium	9.3
Calcium	NS
Chromium	400
Cobalt	NS
Copper	270
Iron	NS
Lead	1000
Magnesium	NS
Manganese	10000
Mercury	2.8
Nickel	310
Potassium	NS
Selenium	1500
Silver	1500
Sodium	NS
Thallium	NS
Vanadium	NS
Zinc	10000

Notes:

units = mg/kg or parts per million (ppm)

NS = No Standard

6 NYCRR Part 375, Table 375-6.8(b): Restricted Use Soil Cleanup Objectives, Protection of Public Health, Commercial, December 14, 2006.

Table 5
Summary of Remaining Soil Contamination

Site Management Plan
Brownfield Cleanup Program No. C360115
1-5 Holland Ave
White Plains, NY

Parameter (mg/kg or ppm)	Part 375 Unrestricted ¹	Part 375 Restricted Commercial ²	Part 375 Protection of Groundwater ³	Sample ID:	GP5-SB-01	GP5-SB-02	GP5-SB-03	FNY9-SB-01	FNY9-SB-02	FNY9-SB-03	FNY-8
				Depth Interval (ft bgs)	0.5 - 4.0	0.5 - 4.0	0.5 - 4.0	0.5 - 4.0	0.5 - 4.0	0.5 - 4.0	1.0 - 3.0
				Lab ID:	04105-001	04105-004	04105-005	04105-006	04105-007	04105-008	220-7315-1
				Sample Date	4/28/2011	4/28/2011	4/28/2011	4/28/2011	4/28/2011	4/28/2011	11/20/2008
Aluminum	NS	NS	NS		6850	7040	9180	8750	7250	7580	4220
Antimony	NS	NS	NS		<0.268	<0.292	0.321	<0.292	1.09 J	<0.262	NA
Arsenic	13	16	16		1.02	0.989	17.7	3.51	98.1	1.13	1.4 J
Barium	350	400	820		37.7	45.7	86.9	80.9	101	50.6	36.6
Beryllium	7.2	590	47		<0.214	<0.234	0.263 J	0.285 J	0.374	<0.209	2.5 U
Cadmium	2.5	9.3	7.5		<0.134	<0.146	0.373	0.301	1.30	<0.131	6.1 U
Calcium	NS	NS	NS		1700	1430	5480	1450	3860	1420	1130
Chromium	1 ⁶	400 ⁶	NS		10.5	10.7	30.8	16.8	28.6	10.7	6.9
Cobalt	NS	NS	NS		4.27	4.42	6.83	6.64	10.5	4.82	3.6
Copper	50	270	1720		19.3	25.3	129	605	423	18.1	14.7
Iron	NS	NS	NS		9630	9950	21800	14500	60700	11500	7400
Lead	63	1000	450		11.5	13.6	149	84.9	276	15.3	4.1 J
Magnesium	NS	NS	NS		2540	2800	5440	3990	3610	2950	1810
Manganese	1600	10000	2000		174	197	254	240	385	204	140
Mercury	0.18	2.8	0.73		0.019	0.019	5.45	10.5	7.92	0.011 J	0.065 U
Nickel	30	310	130		9.76	10.6	19.0	14.1	36.5	11.1	9.1
Potassium	NS	NS	NS		1100	1100	1890	2270	1440	1360	802
Selenium	3.9	1500	4		<1.07	<1.17	<1.19	<1.17	<1.27	<1.05	12.3 U
Silver	2	1500	8.3		0.255 J	0.235 J	0.309 J	0.284 J	0.368 J	0.190 J	3.7 U
Sodium	NS	NS	NS		233	303	424	306	293	210	295
Thallium	NS	NS	NS		0.145 J	<0.146	0.295 J	0.193 J	0.316 J	<0.131	8.6 U
Vanadium	NS	NS	NS		14.9	14.4	26.8	24.1	26.9	15.1	10.3
Zinc	109	10000	2480		32.7	35.8	158	272	132	34.7	20.1 J

Notes:

ft bgs = feet below ground surface

Bold - Exceeds 6 NYCRR Part 375 Protection of Groundwater

Shaded - Exceeds 6 NYCRR Part 375 Unrestricted and Corresponding CP-51 Soil Cleanup Objectives

Shaded - Exceeds 6 NYCRR Part 375 Commercial

UJ = The concentration was approximate and detected at a value below the Reporting Limit (RL) and above the MDL

units = mg/kg or parts per million (ppm)

NS = No Standard

¹ 6 NYCRR Part 375, Table 375-6.8(a): Unrestricted Use Soil Cleanup Objectives, December 14, 2006.

² 6 NYCRR Part 375, Table 375-6.8(b): Restricted Use Soil Cleanup Objectives, Protection of Public Health, Commercial, December 14, 2006.

³ 6 NYCRR Part 375, Table 375-6.8(b): Restricted Use Soil Cleanup Objectives, Protection of Public Health, Protection of Groundwater, December 14, 2006.

⁴ Trivalent and hexavalent chromium were not broken out for the total chromium analysis, and the more conservative soil cleanup objective for hexavalent chromium was used.

Table 5
Summary of Remaining Soil Contamination

Site Management Plan
Brownfield Cleanup Program No. C360115
1-5 Holland Ave
White Plains, NY

Parameter (mg/kg or ppm)	Part 375 Unrestricted ¹	Part 375 Restricted Commercial ²	Part 375 Protection of Groundwater ³	Sample ID:	FNY-8	FNY-9	FNY-9	FNY-10	FNY-10	FNY-11	FNY-11
				Depth Interval (ft bgs)	11.0 - 13.0	1.0 - 3.0	11.0 - 13.0	1.0 - 3.0	15.0 - 17.0	1.0 - 3.0	13.0 - 15.0
				Lab ID:	220-7315-2	220-7315-3	220-7315-4	220-7315-5	220-7315-6	220-7315-9	220-7315-10
				Sample Date	11/20/2008	11/20/2008	11/20/2008	11/20/2008	11/20/2008	11/20/2008	11/20/2008
Aluminum	NS	NS	NS		2600	6360	11800	7500	9120	1940	3930
Antimony	NS	NS	NS		NA	1.2 J	9.4 U	9.3 U	11.1 U	9.8 U	9.6 U
Arsenic	13	16	16		5.8 U	13.8	1.3 J	1.4 J	1.2 J	4.9 U	0.67 J
Barium	350	400	820		21.1	187	65.7	63.7	87.0	18.9	35.3
Beryllium	7.2	590	47		2.3 U	0.54 J	0.60 J	0.41 J	0.41 J	2.0 U	0.23 J
Cadmium	2.5	9.3	7.5		5.8 U	4.4 U	4.7 U	4.7 U	5.5 U	4.9 U	4.8 U
Calcium	NS	NS	NS		14800	1990	1560	1300	4110	1510	1720
Chromium	1 ⁶	400 ⁶	NS		4.9	13	23.1	15.9	22.4	4.6	7.7
Cobalt	NS	NS	NS		3.7	5.2	8.5	8.1	7.1	8.0	3.9
Copper	50	270	1720		7.2	990	61.9	14.5	20.5	18.7	11.2
Iron	NS	NS	NS		5850	22500	18800	13300	16600	3870	8180
Lead	63	1000	450		1.4 J	239	6.5	3.7 J	4.2 J	6.6	1.5 J
Magnesium	NS	NS	NS		6940	2380	5,300	3520	6100	1,080	2,050
Manganese	1600	10000	2000		96.6	220	293	368	254	63.1	147
Mercury	0.18	2.8	0.73		0.051 U	15.4	0.062	0.050 U	0.051 U	0.050 U	0.053 U
Nickel	30	310	130		6.7	13.9	20.4	18.2	15.7	4.5 J	8.6
Potassium	NS	NS	NS		626	921	2,790	1840	2970	423	899
Selenium	3.9	1500	4		11.7 U	2.6 J	1.1 J	9.3 U	11.1 U	9.8 U	9.6 U
Silver	2	1500	8.3		3.5 U	2.6 J	2.8	2.8 U	3.3 U	2.9 U	2.9 U
Sodium	NS	NS	NS		265	336	442	324	440	180 J	234
Thallium	NS	NS	NS		8.2 U	6.1 U	6.6 U	6.5 U	7.8 U	6.9 U	6.7 U
Vanadium	NS	NS	NS		7.4	20.1	29.0	20.1	30.9	5.4	11.7
Zinc	109	10000	2480		11.3 J	283	130	31.5	43.8	238	17.1 J

Notes:

ft bgs = feet below ground surface

Bold - Exceeds 6 NYCRR Part 375 Protection of Groundwater

Shaded - Exceeds 6 NYCRR Part 375 Unrestricted and Corresponding CP-51 Soil Cleanup Objectives

Shaded - Exceeds 6 NYCRR Part 375 Commercial

UJ = The concentration was approximate and detected at a value below the Reporting Limit (RL) and above the MDL

units = mg/kg or parts per million (ppm)

NS = No Standard

¹ 6 NYCRR Part 375, Table 375-6.8(a): Unrestricted Use Soil Cleanup Objectives, December 14, 2006.

² 6 NYCRR Part 375, Table 375-6.8(b): Restricted Use Soil Cleanup Objectives, Protection of Public Health, Commercial, Decen

³ 6 NYCRR Part 375, Table 375-6.8(b): Restricted Use Soil Cleanup Objectives, Protection of Public Health, Protection of Grou

⁴ Trivalent and hexavalent chromium were not broken out for the total chromium analysis, and the more conservative soil cle

Table 5
Summary of Remaining Soil Contamination

Site Management Plan
Brownfield Cleanup Program No. C360115
1-5 Holland Ave
White Plains, NY

Parameter (mg/kg or ppm)	Part 375 Unrestricted ¹	Part 375 Restricted Commercial ²	Part 375 Protection of Groundwater ³	Sample ID:	FNY-12	FNY-12	FNY-13	FNY-13	FNY-14	FNY-14	FNY-15
				Depth Interval (ft bgs)	1.0 - 3.0	11.0 - 13.0	4.0 - 6.0	10.0 - 12.0	0 - 2.0	8.0 - 10.0	2.0 - 4.0
				Lab ID:	220-7315-7	220-7315-8	220-7315-14	220-7315-15	220-7315-21	220-7315-22	220-7315-11
				Sample Date	11/20/2008	11/20/2008	11/21/2008	11/21/2008	11/21/2008	11/21/2008	11/21/2008
Aluminum	NS	NS	NS		9380	9100	3670	6970	5920	7620	4340
Antimony	NS	NS	NS		9.8 U	10.5 U	10.8 U	10.5 U	9.4 U	11.3 U	9.6 U
Arsenic	13	16	16		0.78 J	0.77 J	5.4 U	0.79 J	0.78 J	1.6 J	4.8 U
Barium	350	400	820		55.5	79.8	33.5	43.0	46.9	59.8	40.1
Beryllium	7.2	590	47		0.49 J	0.42 J	2.2 U	0.37 J	0.30 J	0.40 J	0.25 J
Cadmium	2.5	9.3	7.5		4.9 U	5.2 U	5.4 U	5.3 U	4.7 U	4.7 U	4.8 U
Calcium	NS	NS	NS		889	2870	1920	2390	1720	18400	1350
Chromium	1 ⁶	400 ⁶	NS		15.5	13.7	6.6	10.8	10	13.0	7.8
Cobalt	NS	NS	NS		5.8	6.3	3.1	5.3	4.6	5.4	3.7
Copper	50	270	1720		27.9	17.7	9.5	12.8	14.1	26.2	10.3
Iron	NS	NS	NS		15400	13700	7340	10900	9980	12200	7880
Lead	63	1000	450		4.0 J	7.7	2.8 J	2.5 J	3.4 J	15.9	1.7 J
Magnesium	NS	NS	NS		3,820	6050	1440	2660	2670	8100	1750
Manganese	1600	10000	2000		216	228	152	192	213	214	139
Mercury	0.18	2.8	0.73		0.022 J	0.050 U	0.049 U	0.051 U	0.052 U	0.048 U	0.051 U
Nickel	30	310	130		15.2	13.9	8.4	11.8	10.9	12.7	8.0
Potassium	NS	NS	NS		1,580	2120	654	1210	1310	1850	788
Selenium	3.9	1500	4		9.8 U	10.5 U	10.8 U	10.5 U	0.87 J	9.3 U	9.6 U
Silver	2	1500	8.3		2.9 U	3.1 U	3.2	3.2	2.8 U	2.8 U	1.4 J
Sodium	NS	NS	NS		475	409	206 J	452	298	501	186 J
Thallium	NS	NS	NS		6.8 U	7.3 U	7.5 U	7.4 U	6.6 U	6.5 U	6.7 U
Vanadium	NS	NS	NS		21.9	22.8	8.4	15.0	14.1	17.5	10.7
Zinc	109	10000	2480		34.3	36.7	13.4 J	23.3	22.4	40.2	15.5 J

Notes:

ft bgs = feet below ground surface

Bold - Exceeds 6 NYCRR Part 375 Protection of Groundwater

Shaded - Exceeds 6 NYCRR Part 375 Unrestricted and Corresponding CP-51 Soil Cleanup Objectives

Shaded - Exceeds 6 NYCRR Part 375 Commercial

UJ = The concentration was approximate and detected at a value below the Reporting Limit (RL) and above the MDL

units = mg/kg or parts per million (ppm)

NS = No Standard

¹ 6 NYCRR Part 375, Table 375-6.8(a): Unrestricted Use Soil Cleanup Objectives, December 14, 2006.

² 6 NYCRR Part 375, Table 375-6.8(b): Restricted Use Soil Cleanup Objectives, Protection of Public Health, Commercial, Decen

³ 6 NYCRR Part 375, Table 375-6.8(b): Restricted Use Soil Cleanup Objectives, Protection of Public Health, Protection of Grou

⁴ Trivalent and hexavalent chromium were not broken out for the total chromium analysis, and the more conservative soil cle

Table 5
Summary of Remaining Soil Contamination

Site Management Plan
Brownfield Cleanup Program No. C360115
1-5 Holland Ave
White Plains, NY

Parameter (mg/kg or ppm)	Part 375 Unrestricted ¹	Part 375 Restricted Commercial ²	Part 375 Protection of Groundwater ³	Sample ID:	FNY-15	FNY-16	FNY-16	FNY-17	FNY-17	FNY-18	SS12-1
				Depth Interval (ft bgs)	10.0 - 12.0	0 - 2.0	12.0 - 14.0	2.0 - 4.0	14.0 - 16.0	0 - 5.0	0 - 0.5
				Lab ID:	220-7315-12	220-7315-17	220-7315-18	220-7315-19	220-7315-20	220-7315-16	-
				Sample Date	11/21/2008	11/21/2008	11/21/2008	11/21/2008	11/21/2008	11/21/2008	5/2/2012
Aluminum	NS	NS	NS		4930	14900	10300	4560	10100	11300	11600
Antimony	NS	NS	NS		11.6 U	13.1 U	9.0 U	10.5 U	11.8 U	10.9 U	<0.294
Arsenic	13	16	16		5.8 U	2.0 J	1.4 J	0.66 J	1.1 J	2.0 J	2.76
Barium	350	400	820		31.9	61.7	111	40.0	92.7	53.6	59.7
Beryllium	7.2	590	47		0.29 J	0.73 J	0.42 J	0.27 J	0.45 J	0.48 J	0.259 J
Cadmium	2.5	9.3	7.5		5.8 U	6.5 U	4.5 U	5.2 U	5.9 U	5.4 U	0.212 J
Calcium	NS	NS	NS		2230	4970	20100	1370	35500	1010	5070
Chromium	1 ⁶	400 ⁶	NS		9.6	22.2	20.5	8.4	20.8	16.7	24.2
Cobalt	NS	NS	NS		4.8	8.7	8.7	4.7	7.6	6.3	7.72
Copper	50	270	1720		12.8	19.4	21.9	10.7	23.2	18.7	48.9
Iron	NS	NS	NS		9600	21600	21800	8850	16200	15500	17600
Lead	63	1000	450		1.8 J	6.1 J	2.6 J	1.7	12.2	7.1	25.9
Magnesium	NS	NS	NS		2240	9010	15400	2090	22900	7120	6140
Manganese	1600	10000	2000		228	337	334	163	260	412	314
Mercury	0.18	2.8	0.73		0.053 U	0.022 J	0.052 U	0.049 U	0.051 U	0.052 U	0.030
Nickel	30	310	130		9.9	18.4	12.1	9.2	16.9	15.9	16.1
Potassium	NS	NS	NS		930	2120	3840	1220	4110	1490	2740
Selenium	3.9	1500	4		1.1 J	1.2 J	1.0 J	10.5 U	11.8 U	1.1 J	<1.18
Silver	2	1500	8.3		3.5 U	3.9 U	2.7 U	3.1 U	3.5 U	3.3 U	<0.147
Sodium	NS	NS	NS		218 J	994	331	316	515	256	227
Thallium	NS	NS	NS		8.1 U	9.2 U	6.3 U	7.3 U	8.3 U	7.6 U	0.167 J
Vanadium	NS	NS	NS		13.6	35.0	36.1	12.3	28.8	23.9	31.5
Zinc	109	10000	2480		18.4 J	43.7	45.1	17.7 J	48.4	36.9	105

Notes:

ft bgs = feet below ground surface

Bold - Exceeds 6 NYCRR Part 375 Protection of Groundwater

Shaded - Exceeds 6 NYCRR Part 375 Unrestricted and Corresponding CP-51 Soil Cleanup Objectives

Shaded - Exceeds 6 NYCRR Part 375 Commercial

UJ = The concentration was approximate and detected at a value below the Reporting Limit (RL) and above the MDL

units = mg/kg or parts per million (ppm)

NS = No Standard

¹ 6 NYCRR Part 375, Table 375-6.8(a): Unrestricted Use Soil Cleanup Objectives, December 14, 2006.

² 6 NYCRR Part 375, Table 375-6.8(b): Restricted Use Soil Cleanup Objectives, Protection of Public Health, Commercial, Decen

³ 6 NYCRR Part 375, Table 375-6.8(b): Restricted Use Soil Cleanup Objectives, Protection of Public Health, Protection of Grou

⁴ Trivalent and hexavalent chromium were not broken out for the total chromium analysis, and the more conservative soil cle

Table 5
Summary of Remaining Soil Contamination

Site Management Plan
Brownfield Cleanup Program No. C360115
1-5 Holland Ave
White Plains, NY

Parameter (mg/kg or ppm)	Part 375 Unrestricted ¹	Part 375 Restricted Commercial ²	Part 375 Protection of Groundwater ³	Sample ID:	SS12-2	SS12-3	SS12-4	GP-1	GP-2	GP-3	GP-4
				Depth Interval (ft bgs)	0 - 0.5	0 - 0.5	0 - 0.5	0 - 4.0	4.0 - 8.0	12.0 - 16.0	0.5 - 1.0
				Lab ID:	-	-	-				
				Sample Date	5/2/2012	5/2/2012	5/2/2012	4/9/1999	4/9/1999	4/9/1999	4/9/1999
Aluminum	NS	NS	NS		16000	8490	8140	NA	NA	NA	NA
Antimony	NS	NS	NS		<0.311	<0.320	<0.337	NA	NA	NA	NA
Arsenic	13	16	16		3.92	4.89	17.1	NA	NA	NA	2.9
Barium	350	400	820		130	68.2	47.4	NA	NA	NA	52
Beryllium	7.2	590	47		0.506 J	0.349 J	<0.27	NA	NA	NA	NA
Cadmium	2.5	9.3	7.5		0.223 J	3.10	0.389 J	NA	NA	NA	<1.0
Calcium	NS	NS	NS		3090	27800	5940	NA	NA	NA	NA
Chromium	1 ⁶	400 ⁶	NS		53.1	99.2	186	NA	NA	NA	11
Cobalt	NS	NS	NS		21.6	7.97	9.58	NA	NA	NA	NA
Copper	50	270	1720		116	411	723	NA	NA	NA	NA
Iron	NS	NS	NS		26900	18000	22000	NA	NA	NA	NA
Lead	63	1000	450		104	72.9	36.6	NA	NA	NA	60
Magnesium	NS	NS	NS		6760	5700	4380	NA	NA	NA	NA
Manganese	1600	10000	2000		498	313	323	NA	NA	NA	NA
Mercury	0.18	2.8	0.73		0.076	0.101	0.049	NA	NA	NA	<0.1
Nickel	30	310	130		28.0	20.4	22.6	NA	NA	NA	NA
Potassium	NS	NS	NS		2960	1210	1300	NA	NA	NA	NA
Selenium	3.9	1500	4		<1.24	<1.28	<1.35	NA	NA	NA	<0.5
Silver	2	1500	8.3		0.163 J	2.42	0.227 J	NA	NA	NA	<2.0
Sodium	NS	NS	NS		218	170	214	NA	NA	NA	NA
Thallium	NS	NS	NS		0.278 J	0.179 J	<0.169	NA	NA	NA	NA
Vanadium	NS	NS	NS		50.0	34.6	70.2	NA	NA	NA	NA
Zinc	109	10000	2480		698	375	131	NA	NA	NA	NA

Notes:

ft bgs = feet below ground surface

Bold - Exceeds 6 NYCRR Part 375 Protection of Groundwater

Shaded - Exceeds 6 NYCRR Part 375 Unrestricted and Corresponding CP-51 Soil Cleanup Objectives

Shaded - Exceeds 6 NYCRR Part 375 Commercial

UJ = The concentration was approximate and detected at a value below the Reporting Limit (RL) and above the MDL

units = mg/kg or parts per million (ppm)

NS = No Standard

¹ 6 NYCRR Part 375, Table 375-6.8(a): Unrestricted Use Soil Cleanup Objectives, December 14, 2006.

² 6 NYCRR Part 375, Table 375-6.8(b): Restricted Use Soil Cleanup Objectives, Protection of Public Health, Commercial, Decen

³ 6 NYCRR Part 375, Table 375-6.8(b): Restricted Use Soil Cleanup Objectives, Protection of Public Health, Protection of Grou

⁴ Trivalent and hexavalent chromium were not broken out for the total chromium analysis, and the more conservative soil cle

Table 5
Summary of Remaining Soil Contamination

Site Management Plan
Brownfield Cleanup Program No. C360115
1-5 Holland Ave
White Plains, NY

Parameter (mg/kg or ppm)	Part 375 Unrestricted ¹	Part 375 Restricted Commercial ²	Part 375 Protection of Groundwater ³	Sample ID:	GP-6	GP-5	HB-1	HB-2A	HB-3A		
				Depth Interval (ft bgs)	12.0 - 16.0	0 - 4.0	0 - 1.0	5.0 - 6.0	0 - 1.0		
				Lab ID:		-					
				Sample Date	4/9/1999	4/9/1999	4/9/1999		6/2/1999		
Aluminum	NS	NS	NS		NA	NA	NA	NA	NA		
Antimony	NS	NS	NS		NA	NA	NA	NA	NA		
Arsenic	13	16	16		NA	11	2.4	NA	<1.0		
Barium	350	400	820		NA	75	140	NA	33.6		
Beryllium	7.2	590	47		NA	NA	NA	NA	NA		
Cadmium	2.5	9.3	7.5		NA	5	5	NA	<0.5		
Calcium	NS	NS	NS		NA	NA	NA	NA	NA		
Chromium	1 ⁶	400 ⁶	NS		NA	7	25	NA	7.16		
Cobalt	NS	NS	NS		NA	NA	NA	NA	NA		
Copper	50	270	1720		NA	NA	NA	NA	NA		
Iron	NS	NS	NS		NA	NA	NA	NA	NA		
Lead	63	1000	450		NA	4200	350	NA	8.73		
Magnesium	NS	NS	NS		NA	NA	NA	NA	NA		
Manganese	1600	10000	2000		NA	NA	NA	NA	NA		
Mercury	0.18	2.8	0.73		NA	50	0.2	NA	1.18		
Nickel	30	310	130		NA	NA	NA	NA	NA		
Potassium	NS	NS	NS		NA	NA	NA	NA	NA		
Selenium	3.9	1500	4		NA	1.2	0.7	NA	1.07		
Silver	2	1500	8.3		NA	<2.0	<2.0	NA	<0.5		
Sodium	NS	NS	NS		NA	NA	NA	NA	NA		
Thallium	NS	NS	NS		NA	NA	NA	NA	NA		
Vanadium	NS	NS	NS		NA	NA	NA	NA	NA		
Zinc	109	10000	2480		NA	NA	NA	NA	NA		

Notes:

ft bgs = feet below ground surface

Bold - Exceeds 6 NYCRR Part 375 Protection of Groundwater

Shaded - Exceeds 6 NYCRR Part 375 Unrestricted and Corresponding CP-51 Soil Cleanup Objectives

Shaded - Exceeds 6 NYCRR Part 375 Commercial

UJ = The concentration was approximate and detected at a value below the Reporting Limit (RL) and above the MDL

units = mg/kg or parts per million (ppm)

NS = No Standard

¹ 6 NYCRR Part 375, Table 375-6.8(a): Unrestricted Use Soil Cleanup Objectives, December 14, 2006.

² 6 NYCRR Part 375, Table 375-6.8(b): Restricted Use Soil Cleanup Objectives, Protection of Public Health, Commercial, Decen

³ 6 NYCRR Part 375, Table 375-6.8(b): Restricted Use Soil Cleanup Objectives, Protection of Public Health, Protection of Grou

⁴ Trivalent and hexavalent chromium were not broken out for the total chromium analysis, and the more conservative soil cle

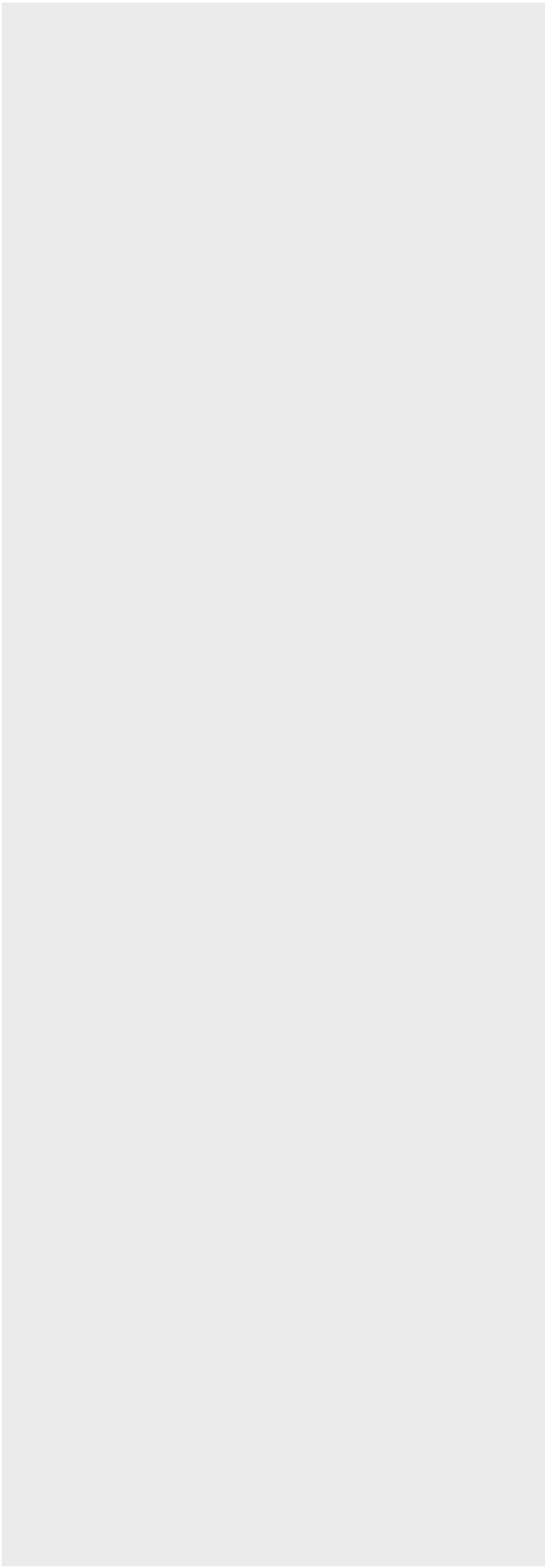

PATH: I:\Feintool\Ny_14206\STDS\GIS\White-Plains\MXD\GIS\10\SITE_loc.mxd

PLOT DATE: 06/06/14 9:53:45 AM stantosa

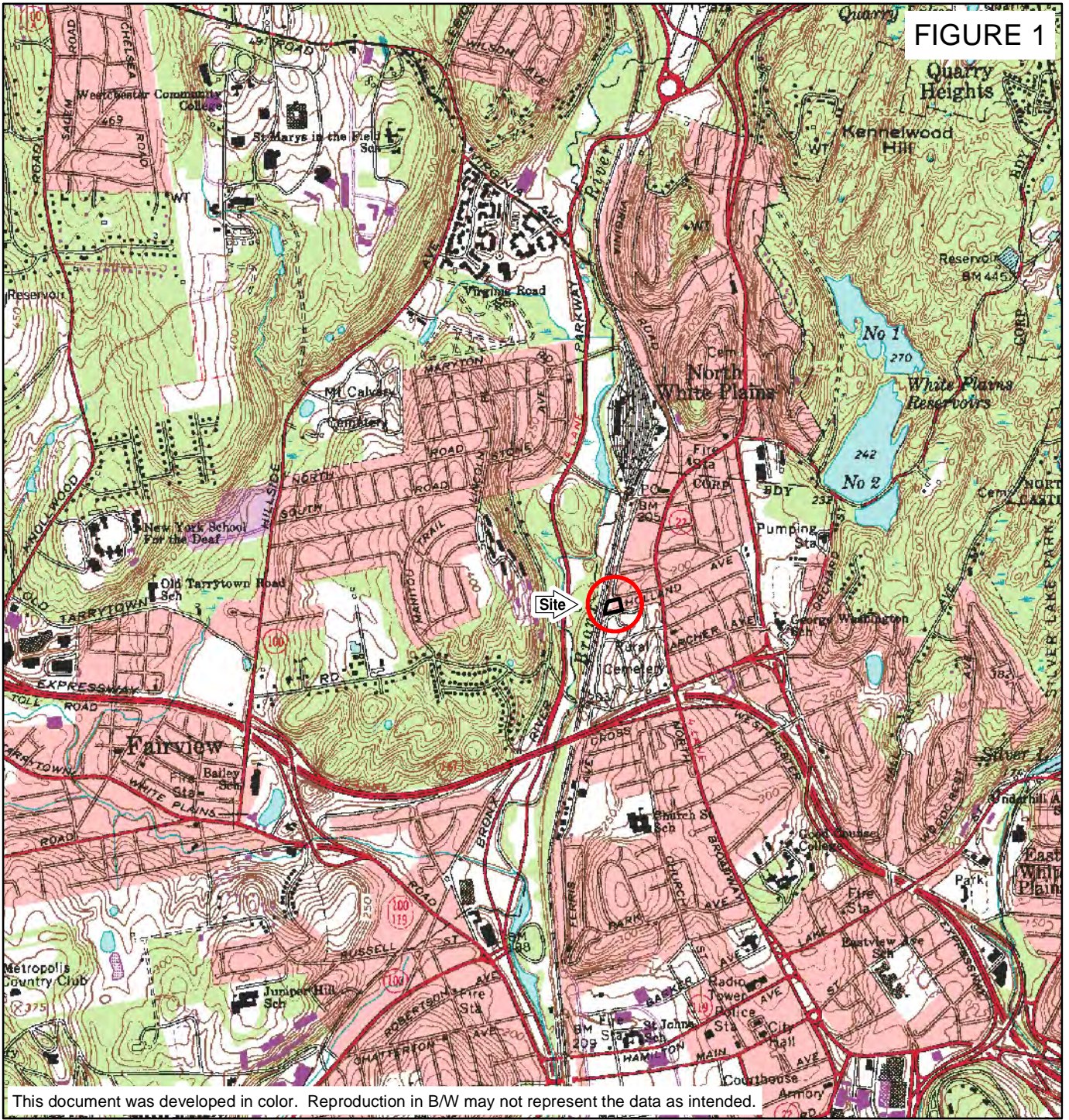

FIGURE 1

This document was developed in color. Reproduction in B/W may not represent the data as intended.

ADAPTED FROM: WHITE PLAINS, NY USGS QUADRANGLE

BROWNFIELD SITE MANAGEMENT PLAN
PROGRAM NO. C360115
1-5 HOLLAND AVENUE
WHITE PLAINS, NY



MAP LOCATION



SITE LOCATION

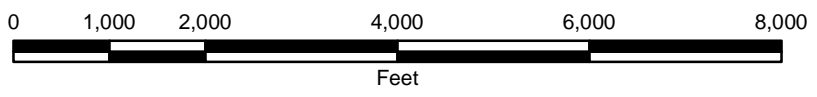



FIGURE 2



LEGEND

- PROPERTY BOUNDARY
- SURFACE WATER

**BROWNFIELD SITE
MANAGEMENT PLAN
PROGRAM NO. C360115
1-5 HOLLAND AVENUE
WHITE PLAINS, NY**

SITE BOUNDARIES

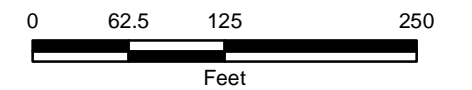

OCTOBER 2014
14206.47376



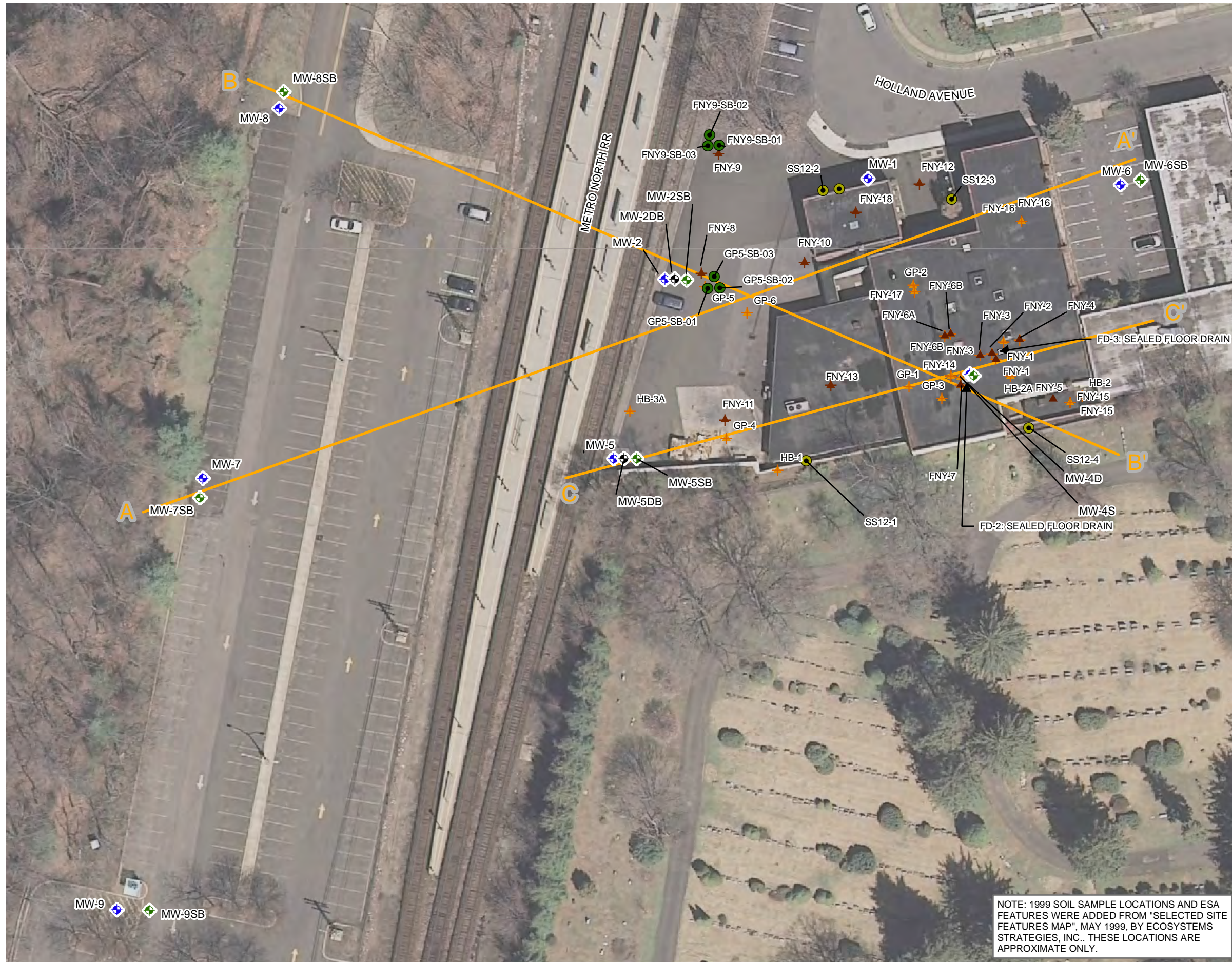

FIGURE 3



LEGEND

- OVERBURDEN WELL
- SHALLOW BEDROCK WELL
- DEEP BEDROCK WELL
- RI OUTSIDE METALS SAMPLE
- RI SURFACE SOIL SAMPLE
- GEOPROBE
- 2008 SOIL SAMPLE LOCATION
- 2001 SOIL SAMPLE LOCATION
- 1999 SOIL SAMPLE LOCATION
- XSEC_TRANSECTS

BROWNFIELD SITE
 MANAGEMENT PLAN
 PROGRAM NO. C360115
 1-5 HOLLAND AVENUE
 WHITE, PLAINS, NY

GEOLOGIC CROSS SECTION(S) KEY PLAN







NOTE: 1999 SOIL SAMPLE LOCATIONS AND ESA FEATURES WERE ADDED FROM "SELECTED SITE FEATURES MAP", MAY 1999, BY ECOSYSTEMS STRATEGIES, INC.. THESE LOCATIONS ARE APPROXIMATE ONLY.

JUNE 2014
 14206.47376

FIGURE 4a

LEGEND

-  WELL SCREEN
-  SOIL SAMPLE
-  WEATHERED BEDROCK FRACTURE
-  UNWEATHERED BEDROCK FRACTURE

BROWNFIELD SITE
 MANAGEMENT PLAN
 PROGRAM NO. C360115
 1-5 HOLLAND AVENUE
 WHITE PLAINS, NEW YORK

CROSS SECTION
TRANSECT A-A'

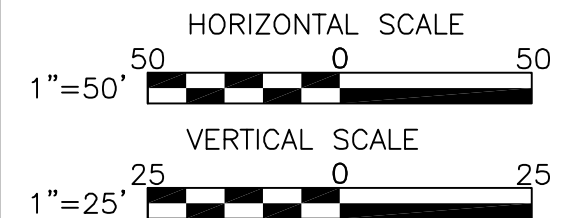
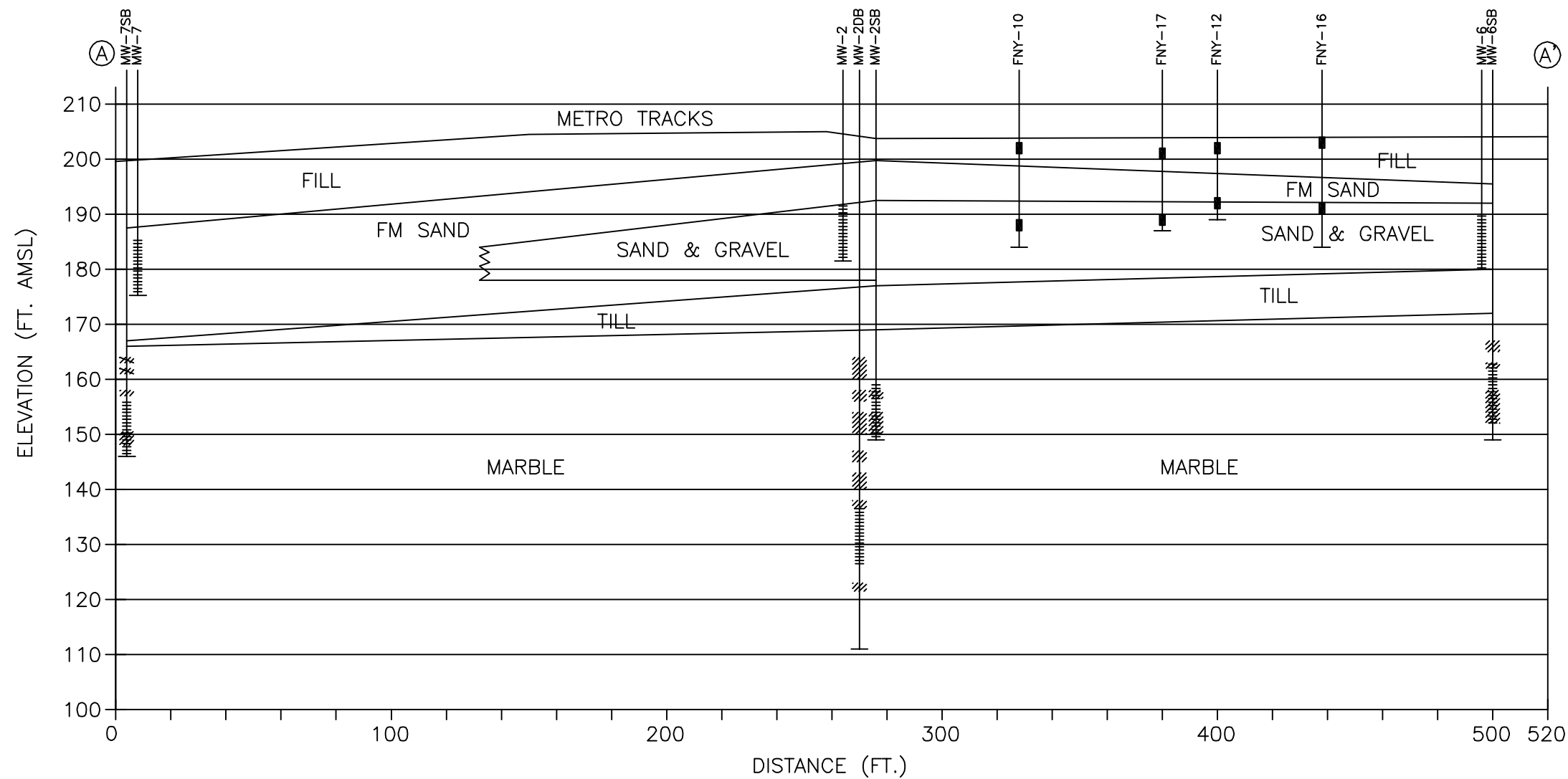

14206.47376.001
 JUNE 2014





NOTE: VERTICAL DATUM - NAVD88 (FT)

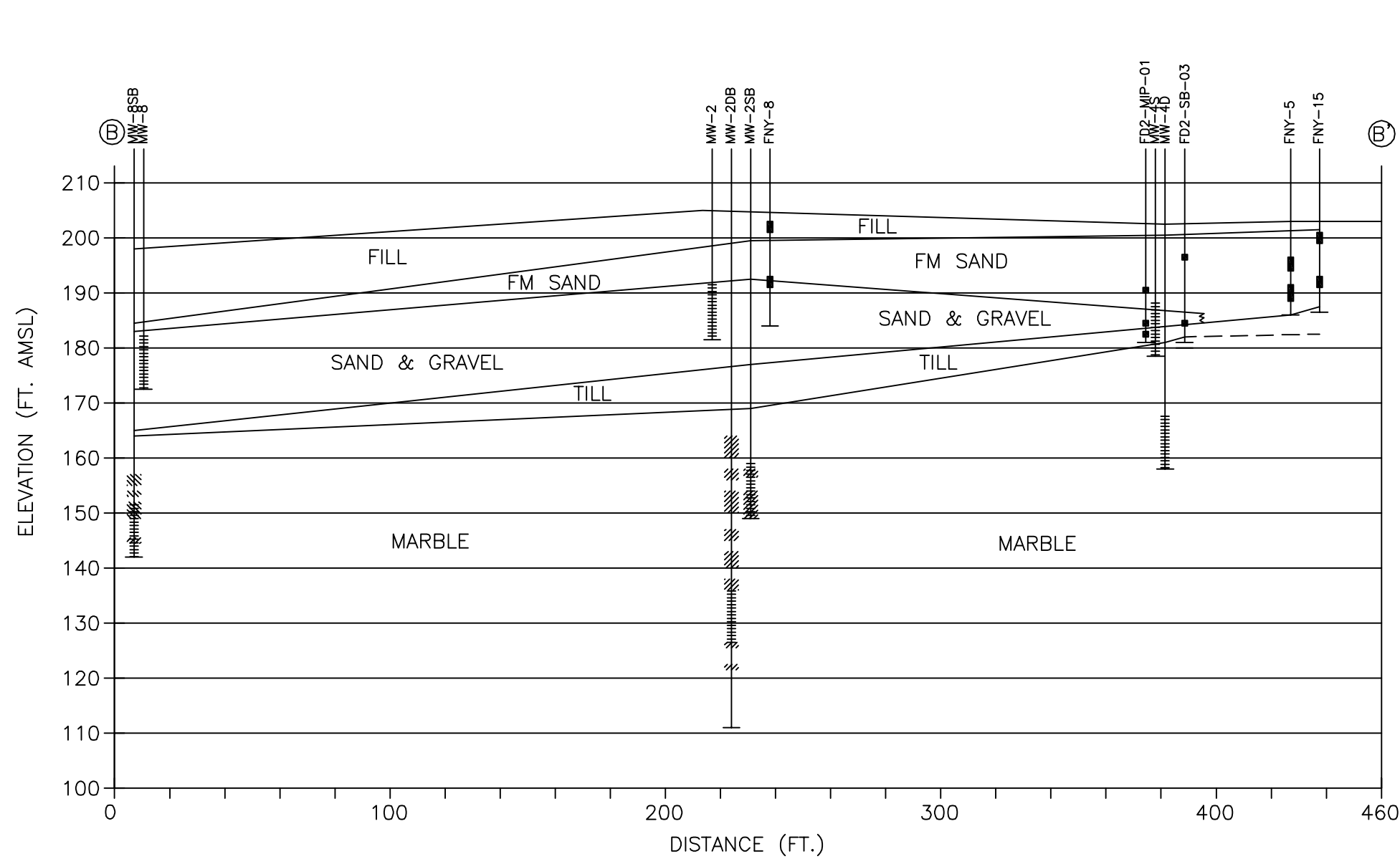

FIGURE 4b



LEGEND

-  WELL SCREEN
-  SOIL SAMPLE
-  WEATHERED BEDROCK FRACTURE
-  UNWEATHERED BEDROCK FRACTURE

BROWNFIELD SITE
 MANAGEMENT PLAN
 PROGRAM NO. C360115
 1-5 HOLLAND AVENUE
 WHITE PLAINS, NEW YORK

CROSS SECTION
TRANSECT B-B'

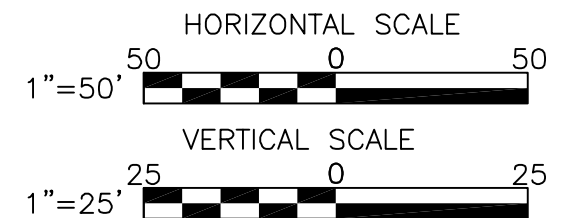

14206.47376.001
 JUNE 2014





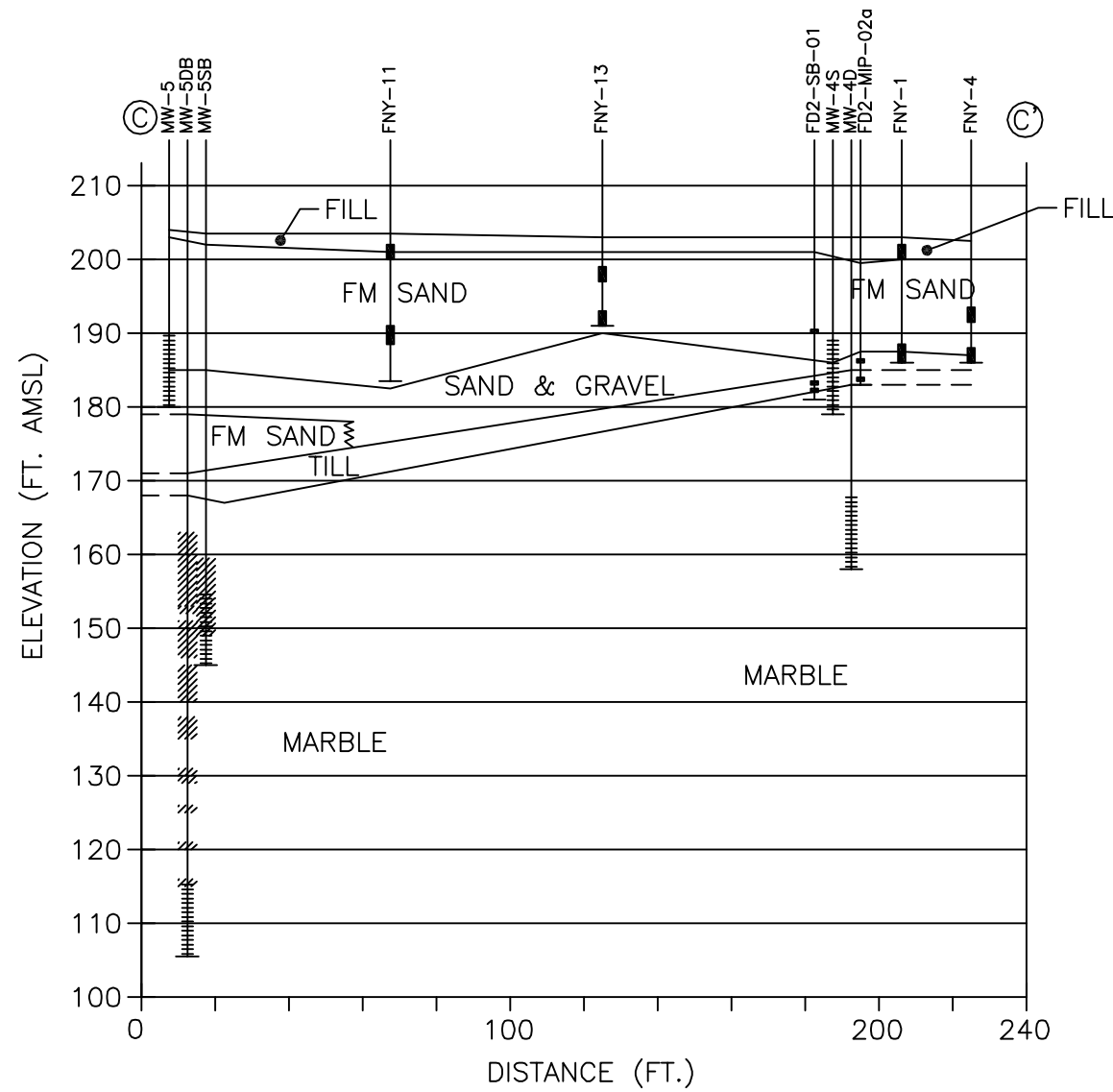

NOTE: VERTICAL DATUM - NAVD88 (FT)

FIGURE 4c



LEGEND

-  WELL SCREEN
-  SOIL SAMPLE
-  WEATHERED BEDROCK FRACTURE
-  UNWEATHERED BEDROCK FRACTURE

BROWNFIELD SITE
 MANAGEMENT PLAN
 PROGRAM NO. C360115
 1-5 HOLLAND AVENUE
 WHITE PLAINS, NEW YORK

CROSS SECTION
TRANSECT C-C'

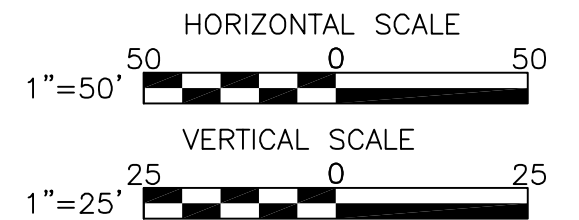

14206.47376.001
 JUNE 2014



NOTE: VERTICAL DATUM - NAVD88 (FT)

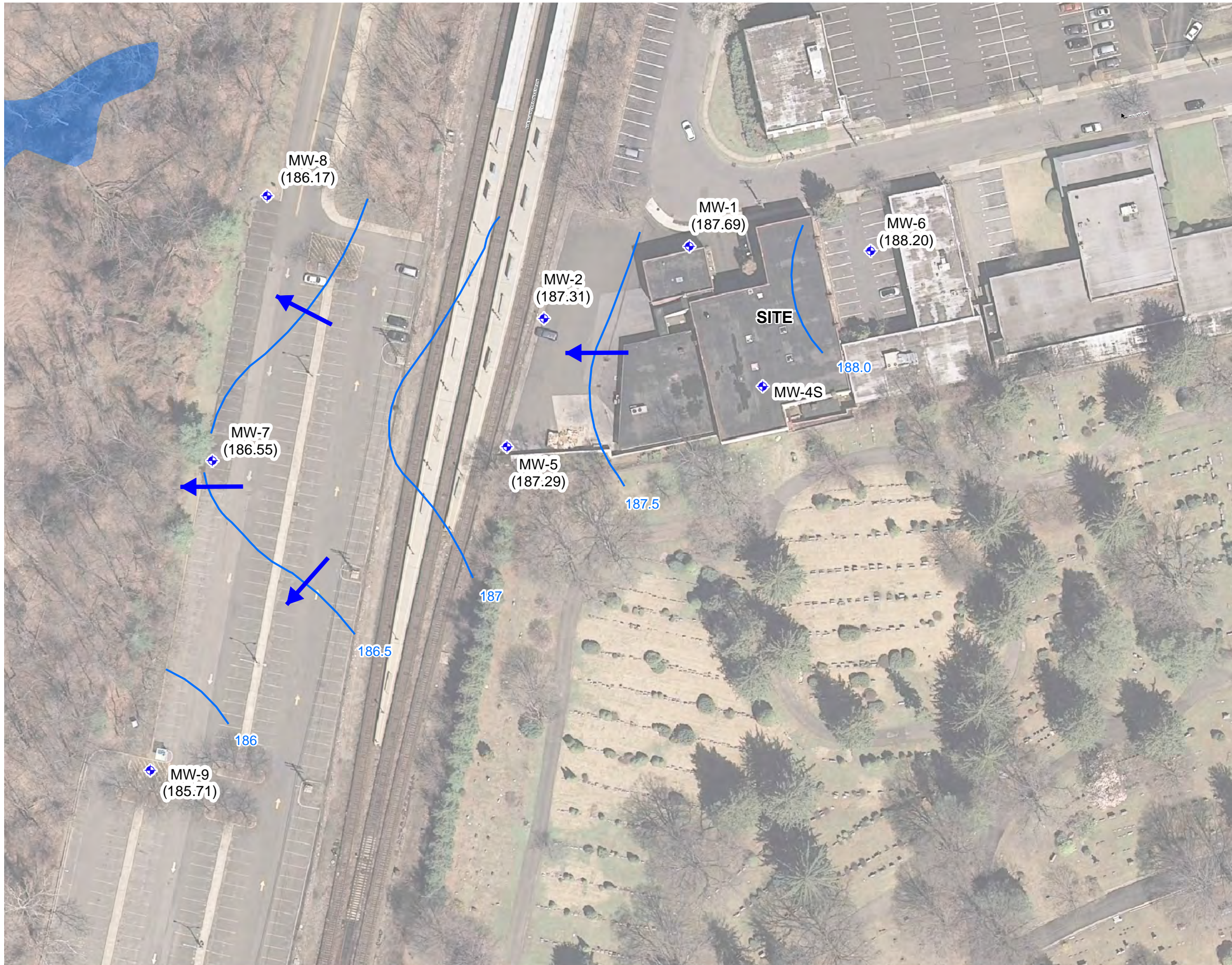





FIGURE 5



LEGEND

-  OVERBURDEN MONITORING WELL
-  GROUNDWATER CONTOUR
(CONTOUR INTERVAL = 0.5 FEET)
- (188.5) Groundwater Elevation (ft amsl)
-  GROUNDWATER FLOW

NOTE:
 THE BUILDING WAS INACCESSIBLE ON 1/26/2012
 AND NO GROUNDWATER ELEVATION MEASUREMENTS
 WERE COLLECTED FOR MW-4S.
 ALL GROUNDWATER ELEVATIONS ARE MEASURED
 AS FEET ABOVE MEAN SEA LEVEL (ft amsl)
 TO THE VERTICAL DATUM NAVD88.

**BROWNFIELD SITE
 MANAGEMENT PLAN
 PROGRAM NO. C360115
 1-5 HOLLAND AVENUE
 WHITE, PLAINS, NY**

**GROUNDWATER
FLOW**

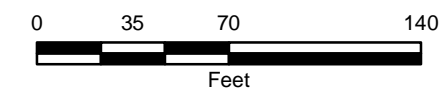

JUNE 2014
 14206.47376



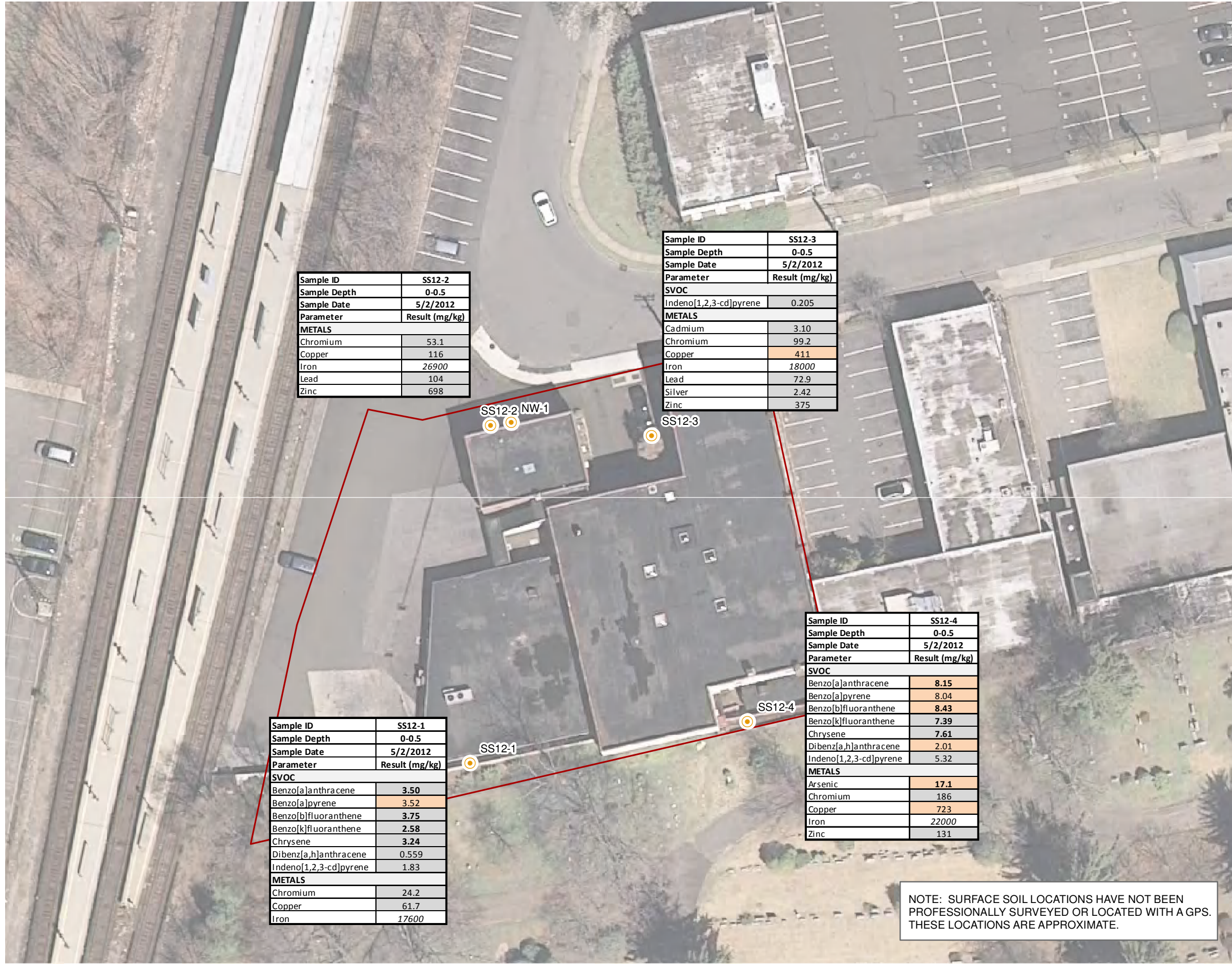

Sample ID	SS12-2
Sample Depth	0-0.5
Sample Date	5/2/2012
Parameter	Result (mg/kg)
METALS	
Chromium	53.1
Copper	116
Iron	26900
Lead	104
Zinc	698

Sample ID	SS12-3
Sample Depth	0-0.5
Sample Date	5/2/2012
Parameter	Result (mg/kg)
SVOC	
Indeno[1,2,3-cd]pyrene	0.205
METALS	
Cadmium	3.10
Chromium	99.2
Copper	411
Iron	18000
Lead	72.9
Silver	2.42
Zinc	375

Sample ID	SS12-1
Sample Depth	0-0.5
Sample Date	5/2/2012
Parameter	Result (mg/kg)
SVOC	
Benzo[a]anthracene	3.50
Benzo[a]pyrene	3.52
Benzo[b]fluoranthene	3.75
Benzo[k]fluoranthene	2.58
Chrysene	3.24
Dibenz[a,h]anthracene	0.559
Indeno[1,2,3-cd]pyrene	1.83
METALS	
Chromium	24.2
Copper	61.7
Iron	17600

Sample ID	SS12-4
Sample Depth	0-0.5
Sample Date	5/2/2012
Parameter	Result (mg/kg)
SVOC	
Benzo[a]anthracene	8.15
Benzo[a]pyrene	8.04
Benzo[b]fluoranthene	8.43
Benzo[k]fluoranthene	7.39
Chrysene	7.61
Dibenz[a,h]anthracene	2.01
Indeno[1,2,3-cd]pyrene	5.32
METALS	
Arsenic	17.1
Chromium	186
Copper	723
Iron	22000
Zinc	131

NOTE: SURFACE SOIL LOCATIONS HAVE NOT BEEN PROFESSIONALLY SURVEYED OR LOCATED WITH A GPS. THESE LOCATIONS ARE APPROXIMATE.

FIGURE 6a



LEGEND

SURFACE SOIL SAMPLE LOCATION

PROPERTY BOUNDARY

BOLD - EXCEEDS PART 375 PROTECTION OF GROUNDWATER

BOLD - EXCEEDS PART 375 UNRESTRICTED

BOLD - EXCEEDS PART 375 RESTRICTED COMMERCIAL

BROWNFIELD SITE
MANAGEMENT PLAN
PROGRAM NO. C360115
1-5 HOLLAND AVENUE
WHITE, PLAINS, NY

REMEDIAL
INVESTIGATION
SURFACE SOIL
CONTAMINATION
SUMMARY



JUNE 2014
14206.47376



FIGURE 6b

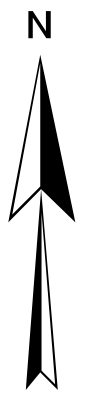

LEGEND

- SOIL BORING (INSIDE BUILDING)
- ▲ SOIL BORING (OUTSIDE BUILDING)
- GROUND PROBE
- + MONITORING WELL
- BOLD** - EXCEEDS PART 375 PROTECTION OF GROUNDWATER
- BOLD** - EXCEEDS PART 375 UNRESTRICTED
- BOLD** - EXCEEDS PART 375 RESTRICTED COMMERCIAL

BROWNFIELD SITE
MANAGEMENT PLAN
PROGRAM NO. C360115
1-5 HOLLAND AVENUE
WHITE, PLAINS, NY

REMEDIAL
INVESTIGATION
SUBSURFACE
SOIL METALS
CONTAMINATION
SUMMARY

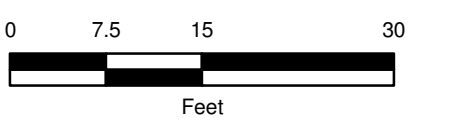

JUNE 2014
14206.47376



This document was developed in color. Reproduction in B/W may not represent the data as intended.

FIGURE 7a



LEGEND

- OVERBURDEN MONITORING WELL
- SHALLOW BEDROCK MONITORING WELL
- DEEP BEDROCK MONITORING WELL
- PROPERTY BOUNDARY
- SURFACE WATER

BOLD - EXCEEDS TOGS 1.1.1 CLASS GA STANDARDS/CRITERIA

BROWNFIELD SITE
MANAGEMENT PLAN
PROGRAM NO. C360115
1-5 HOLLAND AVENUE
WHITE, PLAINS, NY

REMEDIAL
INVESTIGATION
GROUNDWATER
VOC
CONTAMINATION
SUMMARY



JUNE 2014
14206.47376

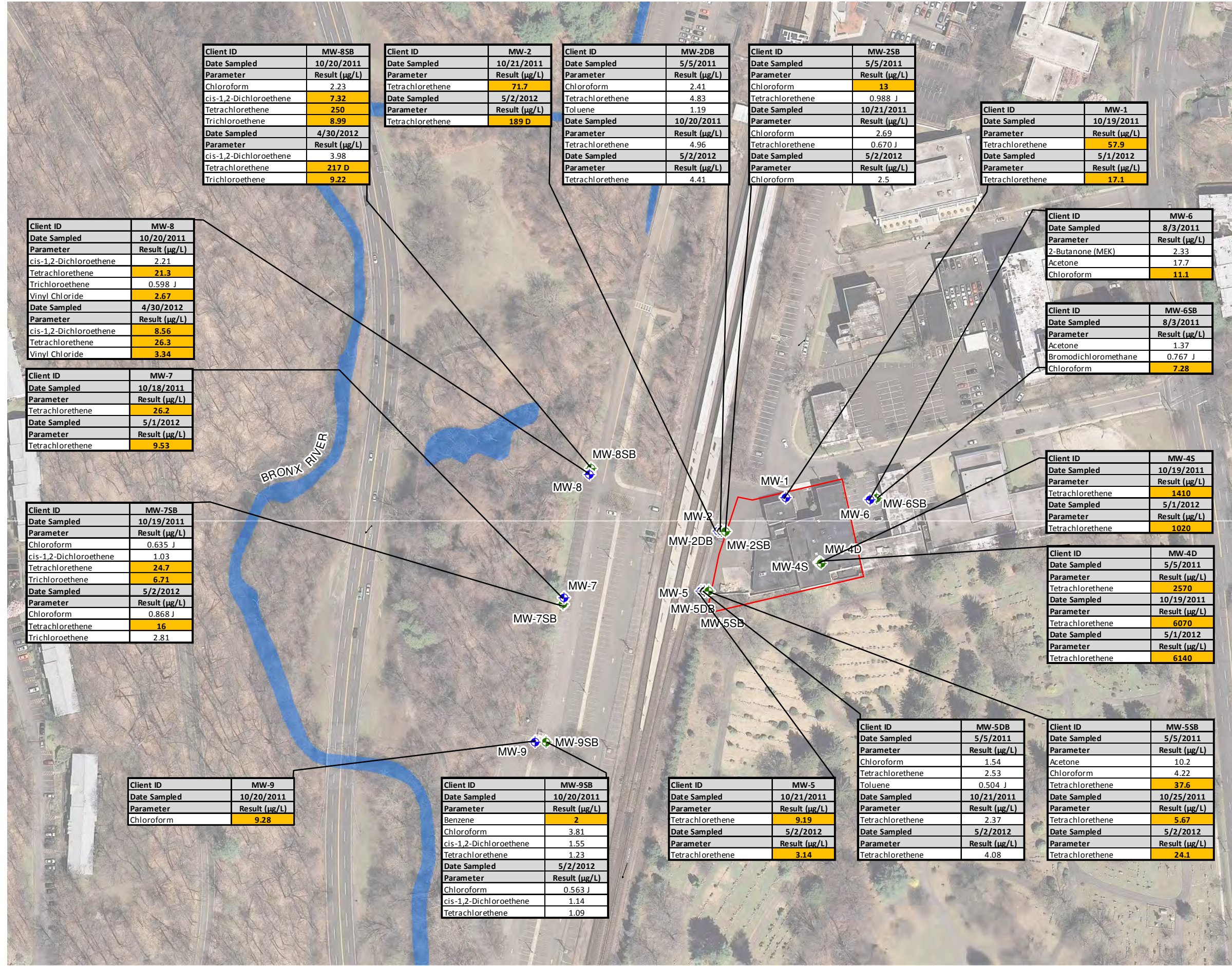

Client ID	MW-8SB
Date Sampled	10/20/2011
Parameter	Result (µg/L)
Chloroform	2.23
cis-1,2-Dichloroethene	7.32
Tetrachlorethene	250
Trichloroethene	8.99
Date Sampled	4/30/2012
Parameter	Result (µg/L)
cis-1,2-Dichloroethene	3.98
Tetrachlorethene	217 D
Trichloroethene	9.22

Client ID	MW-2
Date Sampled	10/21/2011
Parameter	Result (µg/L)
Tetrachlorethene	71.7
Date Sampled	5/2/2012
Parameter	Result (µg/L)
Tetrachlorethene	189 D

Client ID	MW-2DB
Date Sampled	5/5/2011
Parameter	Result (µg/L)
Chloroform	2.41
Tetrachlorethene	4.83
Toluene	1.19
Date Sampled	10/20/2011
Parameter	Result (µg/L)
Tetrachlorethene	4.96
Date Sampled	5/2/2012
Parameter	Result (µg/L)
Tetrachlorethene	4.41

Client ID	MW-2SB
Date Sampled	5/5/2011
Parameter	Result (µg/L)
Chloroform	13
Tetrachlorethene	0.988 J
Date Sampled	10/21/2011
Parameter	Result (µg/L)
Chloroform	2.69
Tetrachlorethene	0.670 J
Date Sampled	5/2/2012
Parameter	Result (µg/L)
Chloroform	2.5

Client ID	MW-1
Date Sampled	10/19/2011
Parameter	Result (µg/L)
Tetrachlorethene	57.9
Date Sampled	5/1/2012
Parameter	Result (µg/L)
Tetrachlorethene	17.1

Client ID	MW-6
Date Sampled	8/3/2011
Parameter	Result (µg/L)
2-Butanone (MEK)	2.33
Acetone	17.7
Chloroform	11.1

Client ID	MW-6SB
Date Sampled	8/3/2011
Parameter	Result (µg/L)
Acetone	1.37
Bromodichloromethane	0.767 J
Chloroform	7.28

Client ID	MW-4S
Date Sampled	10/19/2011
Parameter	Result (µg/L)
Tetrachlorethene	1410
Date Sampled	5/1/2012
Parameter	Result (µg/L)
Tetrachlorethene	1020

Client ID	MW-4D
Date Sampled	5/5/2011
Parameter	Result (µg/L)
Tetrachlorethene	2570
Date Sampled	10/19/2011
Parameter	Result (µg/L)
Tetrachlorethene	6070
Date Sampled	5/1/2012
Parameter	Result (µg/L)
Tetrachlorethene	6140

Client ID	MW-5DB
Date Sampled	5/5/2011
Parameter	Result (µg/L)
Chloroform	1.54
Tetrachlorethene	2.53
Toluene	0.504 J
Date Sampled	10/21/2011
Parameter	Result (µg/L)
Tetrachlorethene	2.37
Date Sampled	5/2/2012
Parameter	Result (µg/L)
Tetrachlorethene	4.08

Client ID	MW-5SB
Date Sampled	5/5/2011
Parameter	Result (µg/L)
Acetone	10.2
Chloroform	4.22
Tetrachlorethene	37.6
Date Sampled	10/25/2011
Parameter	Result (µg/L)
Tetrachlorethene	5.67
Date Sampled	5/2/2012
Parameter	Result (µg/L)
Tetrachlorethene	24.1

Client ID	MW-5
Date Sampled	10/21/2011
Parameter	Result (µg/L)
Tetrachlorethene	9.19
Date Sampled	5/2/2012
Parameter	Result (µg/L)
Tetrachlorethene	3.14

Client ID	MW-9SB
Date Sampled	10/20/2011
Parameter	Result (µg/L)
Benzene	2
Chloroform	3.81
cis-1,2-Dichloroethene	1.55
Tetrachlorethene	1.23
Date Sampled	5/2/2012
Parameter	Result (µg/L)
Chloroform	0.563 J
cis-1,2-Dichloroethene	1.14
Tetrachlorethene	1.09

Client ID	MW-9
Date Sampled	10/20/2011
Parameter	Result (µg/L)
Chloroform	9.28

Client ID	MW-7SB
Date Sampled	10/19/2011
Parameter	Result (µg/L)
Chloroform	0.635 J
cis-1,2-Dichloroethene	1.03
Tetrachlorethene	24.7
Trichloroethene	6.71
Date Sampled	5/2/2012
Parameter	Result (µg/L)
Chloroform	0.868 J
Tetrachlorethene	16
Trichloroethene	2.81

Client ID	MW-7
Date Sampled	10/18/2011
Parameter	Result (µg/L)
Tetrachlorethene	26.2
Date Sampled	5/1/2012
Parameter	Result (µg/L)
Tetrachlorethene	9.53

Client ID	MW-8
Date Sampled	10/20/2011
Parameter	Result (µg/L)
cis-1,2-Dichloroethene	2.21
Tetrachlorethene	21.3
Trichloroethene	0.598 J
Vinyl Chloride	2.67
Date Sampled	4/30/2012
Parameter	Result (µg/L)
cis-1,2-Dichloroethene	8.56
Tetrachlorethene	26.3
Vinyl Chloride	3.34

FIGURE 7b



LEGEND

- OVERBURDEN MONITORING WELL
- SHALLOW BEDROCK MONITORING WELL
- DEEP BEDROCK MONITORING WELL
- PROPERTY BOUNDARY
- SURFACE WATER

BOLD - EXCEEDS TOGS 1.1.1 CLASS GA STANDARDS/CRITERIA

BROWNFIELD SITE
MANAGEMENT PLAN
PROGRAM NO. C360115
1-5 HOLLAND AVENUE
WHITE, PLAINS, NY

REMEDIAL
INVESTIGATION
GROUNDWATER
METALS
CONTAMINATION
SUMMARY



JUNE 2014
14206.47376

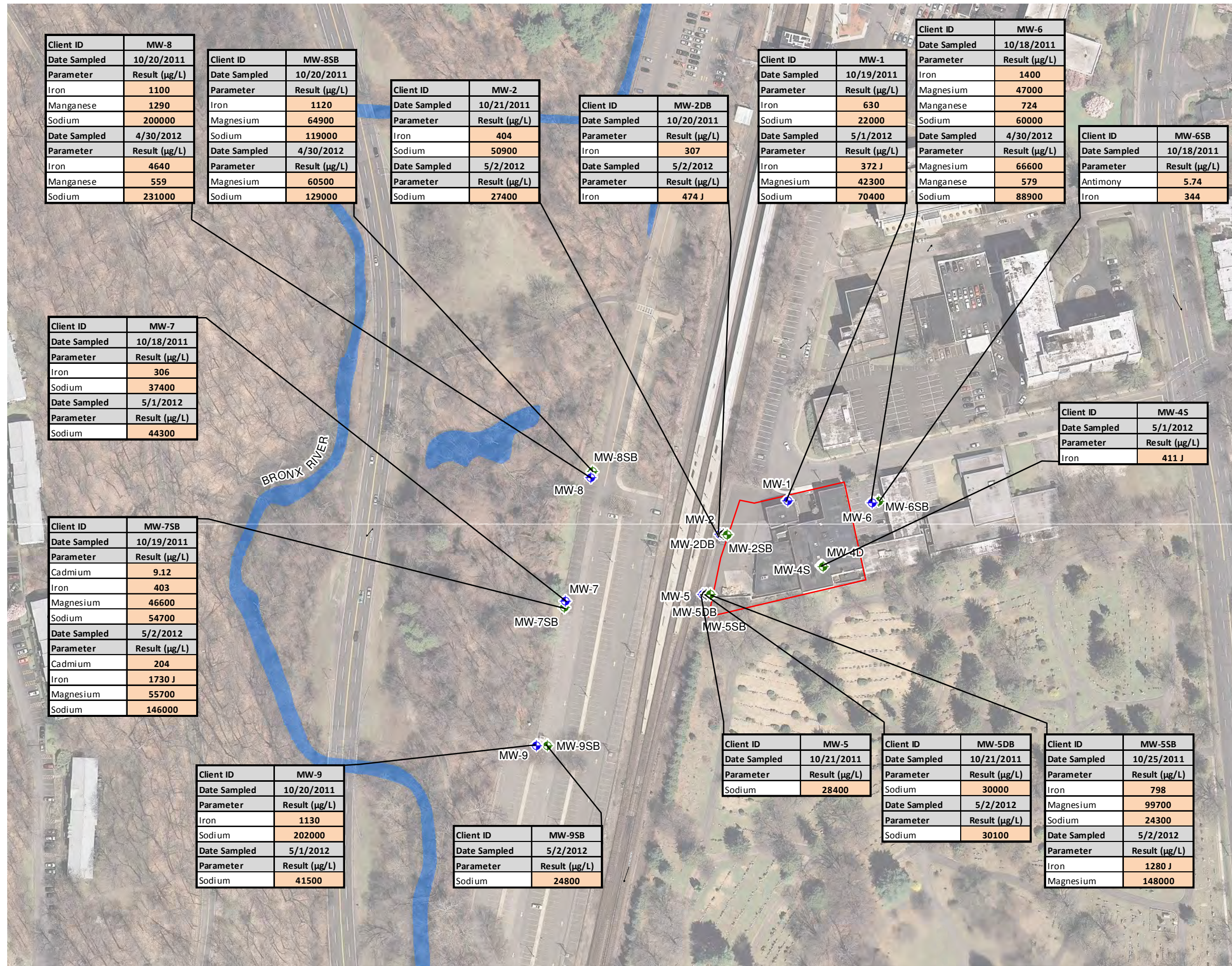

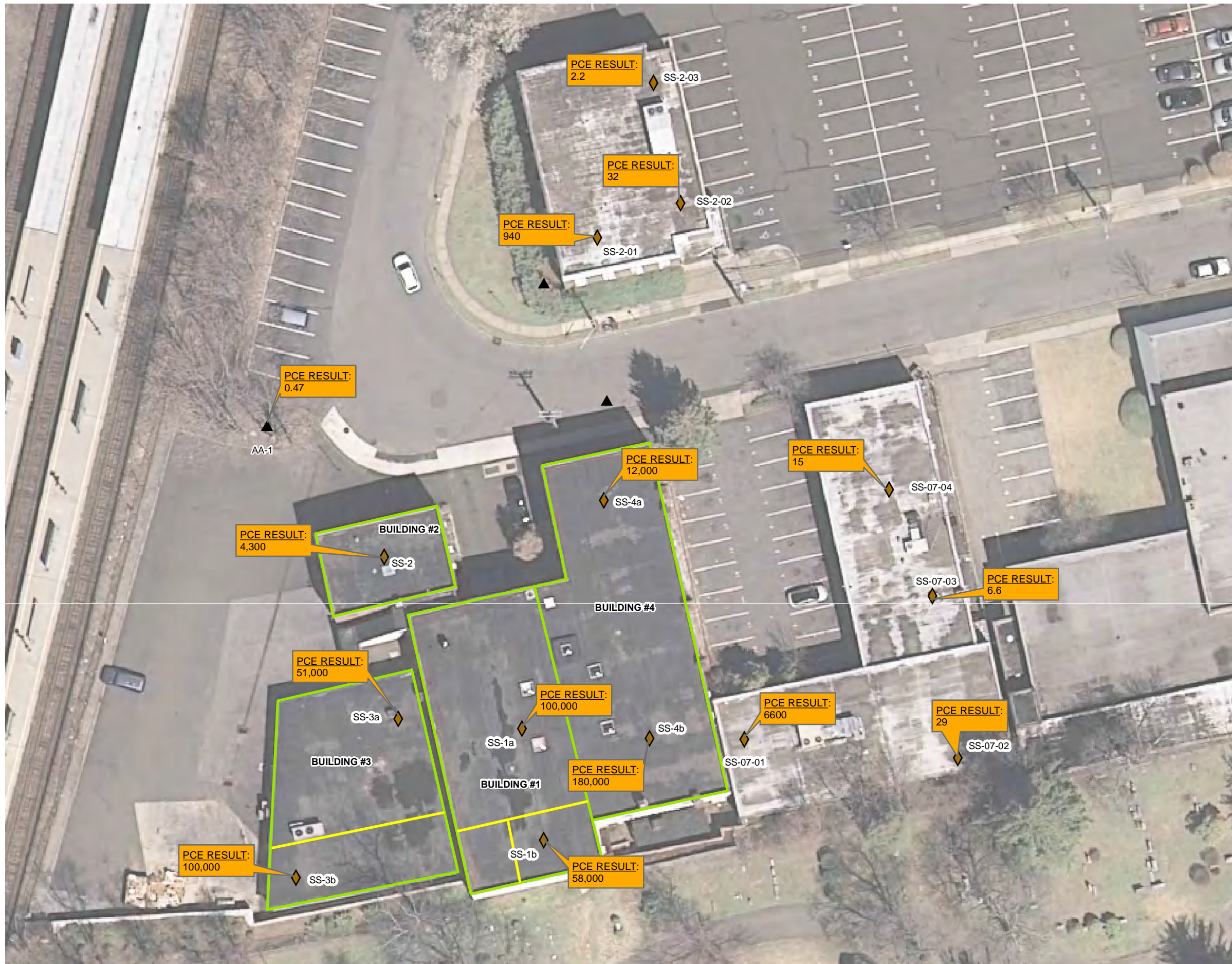

FIGURE 8



LEGEND

- ▲ AMBIENT AIR SAMPLE (mg/m³)
- ◆ SUBSLAB VAPOR SAMPLE (mg/m³)
- WALLS
- BUILDINGS

ONE HOLLAND AVENUE DEVELOPMENT
1-5 HOLLAND AVENUE
WHITE PLAINS, NY

REMEDIAL INVESTIGATION
SOIL VAPOR RESULTS



JUNE 2014
14206.47376









FIGURE 9



LEGEND

-  SURFACE SOIL SAMPLE LOCATION
-  EXPOSED SURFACE SOIL AREA REMAINING IN PLACE
-  EXPOSED SURFACE SOIL AREA REMEDIATION
-  APPROXIMATE PROPERTY BOUNDARY

BROWNFIELD SITE
 MANAGEMENT PLAN
 PROGRAM NO. C360115
 1-5 HOLLAND AVENUE
 WHITE, PLAINS, NY

**EXTENT OF REMEDIAL
 EXCAVATION
 PERFORMED**

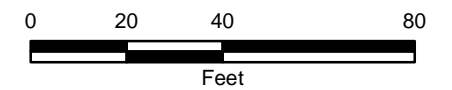

NOTE: SURFACE SOIL LOCATIONS HAVE NOT BEEN PROFESSIONALLY SURVEYED OR LOCATED WITH A GPS. THESE LOCATIONS ARE APPROXIMATE.



AUGUST 2014
 14206.47376



FIGURE 10



LEGEND:

-  MW-4S MONITORING WELL
-  IW-5 INJECTION WELL

NOTE:

IW-2: NOT INSTALLED DUE TO WATER CONTROL ISSUES

IW-6: NOT INSTALLED DUE TO LARGE BOULDER IN OVERBURDEN, WHICH PREVENTED INSTALLATION OF CASING

BROWNFIELD SITE
MANAGEMENT PLAN
PROGRAM NO. C360115
1-5 HOLLAND AVE
WHITE PLAINS, NY

LOCATION OF CHEM-OX
INJECTION WELLS



FILE NO. 14206.47376-002
JUNE 2014

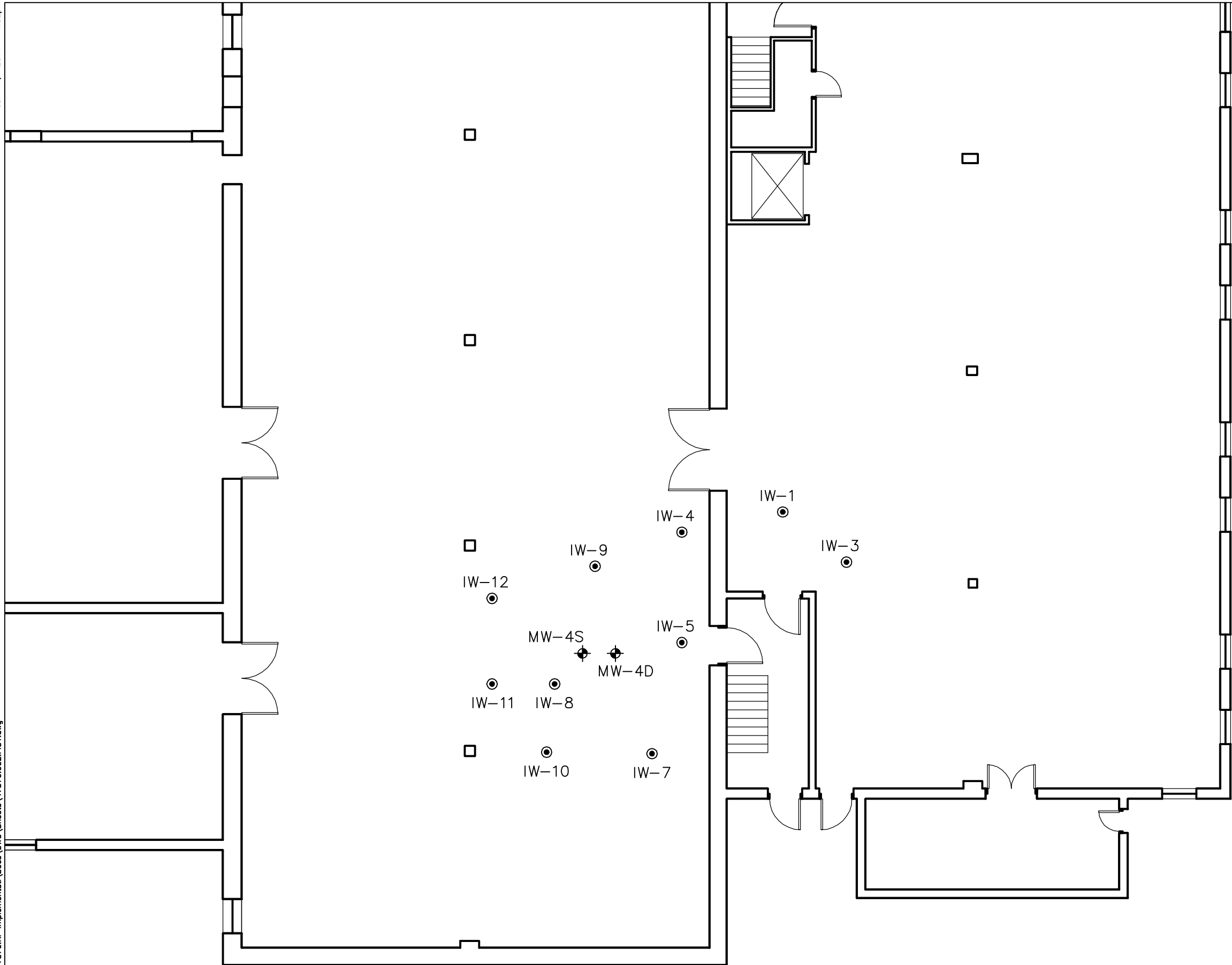

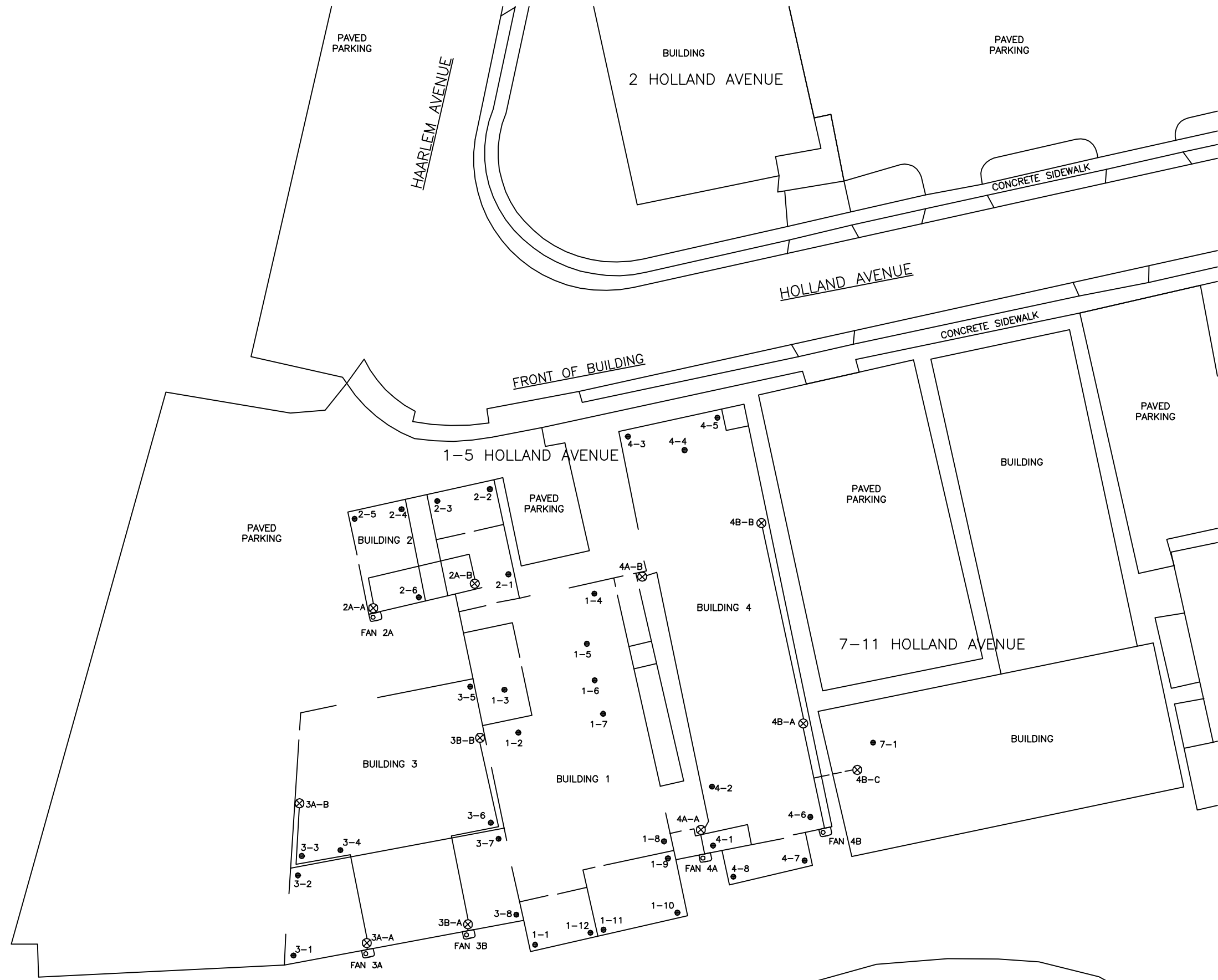

LEGEND

- EXISTING WALL
- ⊗ SYSTEM SUCTION POINT (SSP)
- COMMUNICATION TEST POINT (CTP)
- EXHAUST PIPE
- ⊗ EXHAUST FAN
- - HORIZONTAL SUB-SLAB SUCTION POINT

FLOOR PLAN
 BUILDING AREA - ~14,480 SQ. FT.

- GENERAL NOTES:**
1. THE BUILDING AND SYSTEM LAYOUTS WERE DERIVED FROM A 2009 SKETCH PROVIDED BY ENVIRO TESTING.
 2. THE LOCATION OF WALLS, SYSTEM SUCTION POINTS, SYSTEM PIPING AND COMMUNICATION TEST POINTS ARE APPROXIMATE.
 3. POST-MITIGATION TEST RESULTS WERE OBTAINED PRIOR TO POST-MITIGATION INDOOR AIR SAMPLING BY O'BRIEN & GERE IN MARCH 2013.

IT IS A VIOLATION OF LAW FOR ANY PERSON, UNLESS ACTING UNDER THE DIRECTION OF A LICENSED ENGINEER, TO ALTER THIS DOCUMENT.

THIS DRAWING WAS PREPARED AT THE SCALE INDICATED IN THE TITLE BLOCK. INACCURACIES IN THE STATED SCALE MAY BE INTRODUCED WHEN DRAWINGS ARE REPRODUCED BY ANY MEANS. USE THE GRAPHIC SCALE BAR IN THE TITLE BLOCK TO DETERMINE THE ACTUAL SCALE OF THIS DRAWING.

IN CHARGE OF	EMA
DESIGNED BY	CHECKED BY
DRAWN BY	EMA

NO.	DATE	REVISION	INIT.

O'BRIEN & GERE
 333 W. WASHINGTON STREET
 SYRACUSE, NY 13221
 2014 © O'Brien & Gere Engineers, Inc.

LOCATION OF SSD SYSTEMS

BROWNFIELD SITE
 MANAGEMENT PLAN
 1-5 HOLLAND AVENUE
 WHITE PLAINS, NEW YORK

FILE NO.	14206.47376
DATE	JUNE 2014





FIGURE
 11



FIGURE 13



LEGEND

-  APPROXIMATE PROPERTY BOUNDARY
-  BUILDING SLAB
-  ASPHALT PAVING
-  CLEAN SOIL
-  12-INCHES GRANULAR STONE

BROWNFIELD SITE
MANAGEMENT PLAN
PROGRAM NO. C360115
1-5 HOLLAND AVENUE
WHITE, PLAINS, NY

COVER TYPES

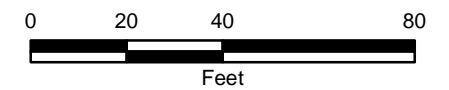



NOVEMBER 2014
14206.47376



FIGURE 14



LEGEND

-  OVERBURDEN WELL
-  SHALLOW BEDROCK WELL
-  DEEP BEDROCK WELL

BROWNFIELD SITE
 MANAGEMENT PLAN
 PROGRAM NO. C360115
 1-5 HOLLAND AVENUE
 WHITE, PLAINS, NY

**GROUNDWATER
 MONITORING
 WELL NETWORK**

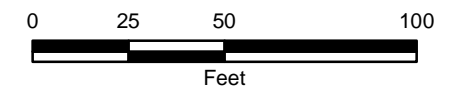

AUGUST 2014
 14206.47376

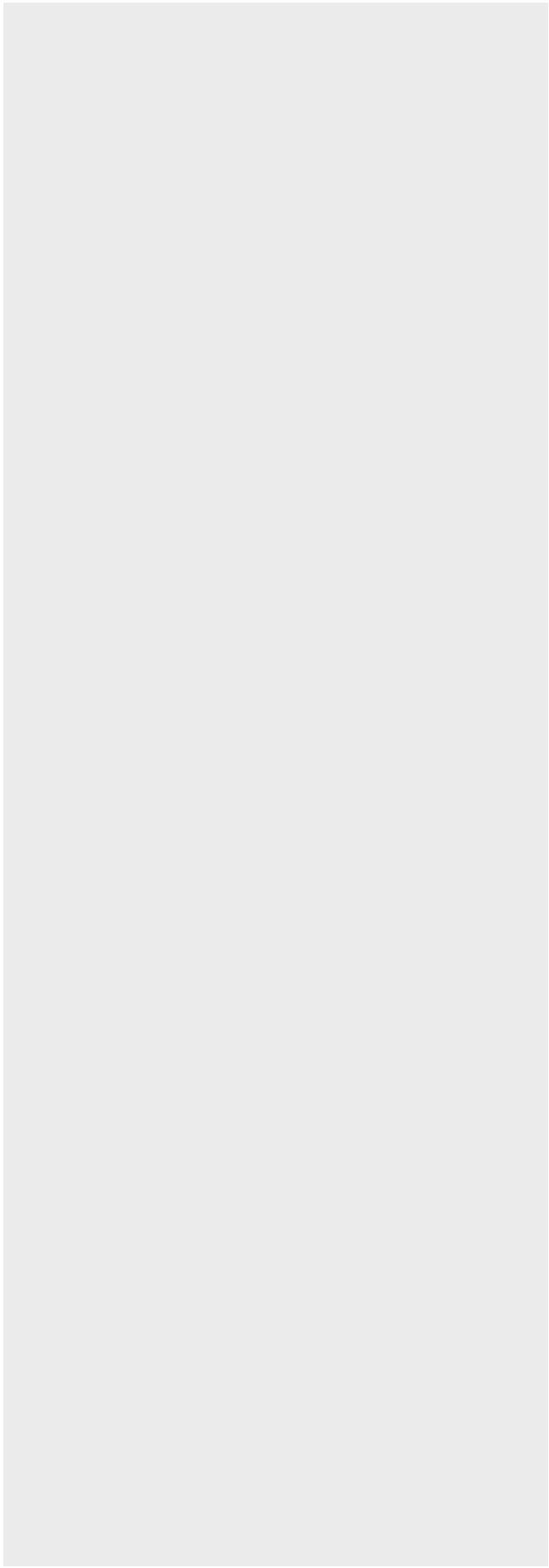

*Responsibilities of Owner
and Remedial Party*

Responsibilities

The responsibilities for implementing the Site Management Plan (“SMP”) for the 1-5 Holland Avenue site (the “site”), number C360115, are divided between the site owner (“Owner”) and Remedial Parties, as defined below.

The Owner is currently listed as:

Owner

1 Holland LLC
1 Holland Avenue
White Plains, NY 10603

Owner’s Contact

Tommy Attonito
1 Holland LLC
1 Holland Avenue
White Plains, NY 10603
phone: 914.879.6962
email: tattonito@yahoo.com

Owner’s Attorney

Denise Forte, Esq.
1311 Mamaroneck Ave, Suite 170
White Plains, NY 10605
phone: 914.949.9075
email: denise@tfsllp.com

Solely for the purposes of this document and based upon the facts related to a particular site and the remedial program being carried out, the term Remedial Party (“RP”) refers to any of the following: certificate of completion holder, volunteer, applicant, responsible party, and, in the event the New York State Department of Environmental Conservation (“NYSDEC”) is carrying out remediation or site management, the NYSDEC and/or an agent acting on its behalf.

One Holland Avenue Development LLC (OHAD) is the Participant under the Brownfield Cleanup Agreement (“BCA”) for the site and is referred to for purposes of this document as the RP. 1 Holland LLC is a Volunteer under the BCA and the certificate of completion holder for the site, but as noted above is referred to for purposes of this document as the Owner.

RP

One Holland Avenue Development LLC
11280 Cornell Park Drive
Cincinnati, OH 45242

RP Contact

Karen Puckett
One Holland Avenue Development LLC
11280 Cornell Park Drive
Cincinnati, OH 45242
phone: 513.247.4041
email: karen.puckett@feintool.com

RP's Attorney

Neal Frink, Esq.
 The Frink Law Firm LLC
 250 East Fifth Street, Suite 1500
 Cincinnati, OH 45202
 phone: 513.746.5445
 email: neal.frink@frinklaw.com

Nothing on this page shall supersede the provisions of an Environmental Easement, Consent Order, Consent Decree, agreement, or other legally binding document that affects rights and obligations relating to the site.

Site Owner's Responsibilities:

- 1) The owner shall follow the provisions of the SMP as they relate to future construction and excavation at the site.
- 2) In accordance with a periodic time frame determined by the NYSDEC, the owner shall periodically certify, in writing, that all Institutional Controls set forth in an Environmental Easement remain in place and continue to be complied with. The owner shall provide a written certification to the RP, upon the RP's request, in order to allow the RP to include the certification in the site's Periodic Review Report (PRR) certification to the NYSDEC.
- 3) In the event the site is delisted, the Owner remains bound by the Environmental Easement and shall submit, upon request by the NYSDEC, a written certification that the Environmental Easement is still in place and has been complied with.
- 4) The Owner shall grant access to the site to the RP and the NYSDEC and its agents for the purposes of performing activities required under the SMP and assuring compliance with the SMP.
- 5) The Owner is responsible for assuring the security of the remedial components located on its property to the best of its ability. In the event that damage to the remedial components or vandalism is evident, the owner shall notify the site's RP and NYSDEC in accordance with the timeframes indicated in Section 2.4.2 -Notifications.
- 6) In the event some action or inaction by the Owner adversely impacts the site, the Owner must (i) notify the site's RP and the NYSDEC in accordance with the time frame indicated in Section 2.4.2 - Notifications and (ii) coordinate the performance of necessary corrective actions with the RP.
- 7) The owner must notify the RP and the NYSDEC of any change in ownership of the site property (identifying the tax map numbers in any correspondence) and provide contact information for the new owner of the site property. 6 NYCRR Part 375-1.11(d) and 375-1.9(d) contains notification requirements applicable to any construction or activity changes and changes in ownership. Among the notification requirements is the following: Sixty days prior written notification must be made to the NYSDEC of any "change in use" of the site property. Change in use of the site property includes construction activities, change in site ownership, change in responsibility for remedial programs, or transfer of Certificate of Completion. Notification is to be submitted to the NYSDEC Division of Environmental Remediation's Site Control Section. Notification requirements for a change in use are detailed in Section 2.4 of the SMP. A 60-Day Advance Notification Form and Instructions are found at <http://www.dec.ny.gov/chemical/76250.html>.
- 8) The owner is responsible for routine maintenance and repair of the cover system at the site property including all areas covered by concrete, asphalt, gravel or soils. The owner is also responsible for any repair of the cover system required in connection with owner's construction activities. Prior notice to the RP and NYSDEC is required for any planned maintenance or repair work that may expose contaminated soils at the site.

- 9) Until such time as the NYSDEC deems the vapor mitigation system unnecessary, the owner shall operate the system, pay for the utilities for the system's operation, and report any maintenance issues to the RP and the NYSDEC.
- 10) The owner is responsible for any required modification or recommissioning of the vapor mitigation system required as a result of owner's construction activities at the site, including required pre-notification to the RP and NYSDEC.
- 11) In accordance with the tenant notification law, within 15 days of receipt, the owner must supply a copy of any vapor intrusion data, that is produced with respect to structures and that exceeds NYSDOH or OSHA guidelines on the site, whether produced by the NYSDEC, RP, or owner, to the tenants on the property. The owner must otherwise comply with the tenant and occupant notification provisions of Environmental Conservation Law Article 27, Title 24.

Remedial Party Responsibilities

- 1) The RP must follow the SMP provisions regarding any construction and/or excavation it undertakes at the site.
- 2) The RP shall report to the NYSDEC all activities required for remediation, operation, maintenance, monitoring, and reporting. Such reporting includes, but is not limited to, periodic review reports and certifications, electronic data deliverables, corrective action work plans and reports, and updated SMPs.
- 3) Before accessing the site property to undertake a specific activity, the RP shall provide the owner advance notification that shall include an explanation of the work expected to be completed. The RP shall provide to (i) the owner, upon the owner's request, (ii) the NYSDEC, and (iii) other entities, if required by the SMP, a copy of any data generated during the site visit and/or any final report produced.
- 4) If the NYSDEC determines that an update of the SMP is necessary, the RP shall update the SMP and obtain final approval from the NYSDEC. Within 5 business days after NYSDEC approval, the RP shall submit a copy of the approved SMP to the owner(s).
- 5) The RP shall notify the NYSDEC and the owner of any changes in RP ownership and/or control and of any changes in the party/entity responsible for the operation, maintenance, and monitoring of and reporting with respect to any remedial system (Engineering Controls). The RP shall provide contact information for the new party/entity. Such activity constitutes a Change of Use pursuant to 375-1.11(d) and requires 60-days prior notice to the NYSDEC. A 60-Day Advance Notification Form and Instructions are found at <http://www.dec.ny.gov/chemical/76250.html>.
- 6) The RP shall notify the NYSDEC of any damage to or modification of the systems as required under Section 2.4.2- Notifications of the SMP.
- 7) The RP is responsible for the proper maintenance of any installed vapor intrusion mitigation systems associated with the site, as required in Section 4.0 (Operation, Maintenance and Monitoring Plan) or Appendix J (SSD System, Operation & Maintenance Manual).
- 8) The RP is responsible for proper maintenance and closure of all groundwater monitoring wells and Interim Remedial Measures injection wells at the Site.
- 9) Prior to a change in use that impacts the remedial system or requirements and/or responsibilities for implementing the SMP, the RP shall submit to the NYSDEC for approval an amended SMP.
- 10) Any change in use, change in ownership, change in site classification (e.g., delisting), reduction or expansion of remediation, and other significant changes related to the site may result in a change in responsibilities and, therefore, necessitate an update to the SMP and/or updated legal documents. The RP shall contact the Department to discuss the need to update such documents.

Change in RP ownership and/or control and/or site ownership does not affect the RP's obligations with respect to the site unless a legally binding document executed by the NYSDEC releases the RP of its obligations.

Future site owners and RPs and their successors and assigns are required to carry out the activities set forth above.

(Template Source: NYSDEC Site Management Plan Template, Appendix B, February 2013.)

Environmental Easement

Neal A. Frink
(513) 746-5445
neal.frink@frinklawn.com

The Frink Law Firm LLC
250 East Fifth Street
Suite 1500, Chiquita Building
Cincinnati, OH 45202

June 6, 2014

Kiera Thompson
New York State Department of Environmental Conservation
Division of Environmental Remediation
625 Broadway
Albany, NY 12233

Re: Environmental Easement Package and BCA Amendment No. 1
1-5 Holland Avenue, White Plains, NY
BCP Site No. C360115

Dear Ms. Thompson:

Enclosed is the draft Environmental Easement Package for the 1-5 Holland Avenue Site, including the following materials.

1. Copy of current deed (final)
2. Copy of tax map (final)
3. Easement (for execution)
4. Authority to Obligate Owner (title verification included, owner authority to follow)
5. Legal description of easement area (final)
6. Survey (final)
7. Draft notice to municipality (final)
8. Attorney Checklist with certifications (draft, with notations)

Also enclosed is the draft application for an amendment to the BCA (Amendment No. 1). First, the BCA Amendment adds the new owner (1 Holland LLC) as a Volunteer under the BCA. 1 Holland LLC purchased the property in late 2013 and has redeveloped the property for use as a self-storage facility. The new owner would like to be added as a party to the BCA so that they are best positioned to take advantage of any tax credits that may become available in connection with the project. Second, the BCA Amendment corrects a mistake in the stated acreage for the property (0.65 acres) to the actual acreage (0.7221 acres) without making any change to the metes/bounds or Tax Block Lot description for the property.

I am submitting substantially complete materials for both the Environmental Easement Package and the BCA Amendment at the same time so that their review can be coordinated.

Ms. Kiera Thompson
June 6, 2014
Page 2

Please do not hesitate to contact me via email or by calling me at 513.746.5445 to discuss any changes or additional materials required to process final updates to these materials.

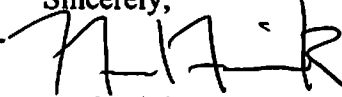
Sincerely,

Neal Frink

c: Thomas Attonito – 1 Holland LLC
Denise Forte – attorney for 1 Holland LLC
David Crosby - NYSDEC
Rosalie Rusinko, Esq – NYSDEC Region 3 Office of General Counsel
Karen Puckett – One Holland Avenue Development LLC

**1-5 Holland Avenue
BCP Site No. C360115
Environmental Easement Package**

Item #1 – Copy of Current Deed

BARGAIN AND SALE DEED WITH COVENANT AGAINST GRANTOR'S ACTS

THIS INDENTURE, made as of the 30th day of September, two thousand thirteen, between

ONE HOLLAND AVENUE DEVELOPMENT LLC, a New York Limited Liability Company, with an address at 11280 Cornell Park Drive, Cincinnati, Ohio 45242

party of the first part, and

1 HOLLAND LLC, a New York Limited Liability Company, with an address at 1 Holland Avenue, White Plains, NY 10603,

party of the second part,

WITNESSETH, that the party of the first part, in consideration of Ten (\$10.00) dollars and other good and valuable consideration, lawful money of the United States, paid by the party of the second part, does hereby grant and release unto the party of the second part, the heirs or successors and assigns of the party of the second part forever,

ALL that certain plot, piece or parcel of land, with the buildings and improvements thereon erected, situate, lying and being in the City of White Plains, County of Westchester and State of New York, located at and known as 1 Holland Avenue, White Plains, NY as more particularly described on SCHEDULE 'A' attached hereto.

TOGETHER with all right, title and interest, if any, of the party of the first part in and to any streets and roads abutting the above described premises to the center lines thereof,

TOGETHER with the appurtenances and all the estate and rights of the party of the first part in and to said premises,

TO HAVE AND TO HOLD the premises herein granted unto the party of the second part, the heirs or successors and assigns of the party of the second part forever.

PARTY OF THE FIRST PART herein is the same person as Grantee and the premises is and is intended to be the same premises in a certain Deed dated August 13, 2009 and recorded on September 14, 2009 in Control No. 492430014 in the Westchester County Clerk's Office, Division of Land Records.

AND the party of the first part, covenants that the party of the first part has not done or suffered anything whereby the said premises have been encumbered in any way whatever, except as aforesaid.

AND the party of the first part, in compliance with Section 13 of the Lien Law, covenants that the party of the first part will receive the consideration for this conveyance and will hold the right to receive such consideration as a trust fund to be applied first for the purpose of paying the cost of the improvement and will apply the same first to the payment of the cost of the improvement before using any part of the total of the same for any other purpose.

The word "party" shall be construed as if it read "parties" whenever the sense of this indenture so requires.

KYE

IN WITNESS WHEREOF, the party of the first part has duly executed this deed as of the day and year first above written.

IN PRESENCE OF:

ONE HOLLAND AVENUE DEVELOPMENT LLC

By: *Karen Puckett*
KAREN PUCKETT, Vice President

State of Ohio)
County of Hamilton) ss:

On the 30th day of September in the year 2013 before me, the undersigned, personally appeared KAREN PUCKETT, personally known to me or proved to me on the basis of satisfactory evidence to be the individual whose name is subscribed to the within instrument and acknowledged to me that she executed the same in her capacity, and that by her signature on the instrument, the individual, or the person upon behalf of which the individual acted, executed the instrument.

09.13.2013

Jennifer A. Davidson
Notary Public

Jennifer A. Davidson
Notary Public, State of Ohio
My Commission Expires 02-13-2015

**BARGAIN & SALE DEED
WITH COVENANT AGAINST GRANTOR'S ACTS**

ONE HOLLAND AVENUE DEVELOPMENT LLC

TO

1 HOLLAND LLC

SECTION: 125.7
BLOCK: 1
LOT: 1
COUNTY: Westchester
PREMISES: 1 Holland Avenue
White Plains, NY

RECORD & RETURN TO:

1 THE JUDICIAL TITLE INSURANCE AGENCY LLC
800 WESTCHESTER AVENUE | SUITE S-340
RYE BROOK, NY 10573
914-381-6700

WP

THE JUDICIAL TITLE INSURANCE AGENCY LLC

Title Number: 113135ST-W

SCHEDULE A

PARCEL I

ALL those certain lots, pieces or parcels of land, situate, lying and being in the City of White Plains, County of Westchester and State of New York, known and designated as Lot Numbers 1, 2, 3, 4 and 13 in Block 3, on a certain map entitled, "Map of North White Plains, the Terminal City, situated in the Town and Village of White Plains and the Town of North Castle, in the County of Westchester and State of New York, surveyed for New York Suburbs Co." made by Lewis T. Haney, Civil Engineer and City Surveyor, 1907 and filed in the County Clerk's Office, Division of Land Records, formerly Register's Office of Westchester County, September 23, 1907 as Map Number 1749 and bounded and described as follows:

BEGINNING at the corner formed by the intersection of the southerly side of Holland Avenue with the easterly side of lands of New York Central Railroad;

RUNNING THENCE along the southerly side of Holland Avenue, north 88 degrees 12 minutes 40 seconds east 140 feet to a point on the westerly side of Lot No. 5;

RUNNING THENCE along the same, south 1 degrees 47 minutes 20 seconds east 150.65 feet to a point;

RUNNING THENCE south 87 degrees 58 minutes west 76.28 feet and south 88 degrees 14 minutes 00 seconds west 135.27 feet to the easterly side of land of New York Central Railroad;

RUNNING THENCE along the same, north 23 degrees 34 minutes 54 seconds east 167 feet to the point of **BEGINNING**.

PARCEL II

ALL that certain plot, piece or parcel of land, situate, lying and being in the City of White Plains, County of Westchester and State of New York, bounded and described as follows:

BEGINNING at the southeasterly corner of the premises described and designated as Parcel No. 1 in deed from Margaretta S. Clark to the New York Central and Hudson River Railroad Company, dated April 9, 1901 recorded in the Office of the Clerk of said

THE JUDICIAL TITLE INSURANCE AGENCY LLC

Title Number: 113135ST-W

SCHEDULE A (continued)

County of Westchester, now Division of Land Records in Liber 1577 of deeds at page 216; and

RUNNING THENCE westerly along the southerly line of said Parcel No. 1 described in deed dated and recorded as aforesaid south 88 degrees 10 minutes 50 seconds west 33.08 feet to the southwesterly corner thereof, said corner being distant southeasterly 41.25 feet measured at right angles from the original center line of the New York and Harlem Railroad, said center line being marked by stone monument set in the ground;

THENCE north 22 degrees 55 minutes 50 seconds east 90 feet, to a point opposite Chaining Station 125 plus 057.30 in said monumented center line;

THENCE north 29 degrees 09 minutes 05 seconds east 91.39 feet to a point distant southeasterly 51.15 feet measured at right angles from said monumented center line at Chaining Station 125 plus 148.12 feet therein;

THENCE south 67 degrees 06 minutes 12 seconds east 22.25 feet to a point in the southeasterly line of Parcel No. 1 in deed dated and recorded aforesaid where the same is intersected by the southerly line of Holland Avenue;

THENCE southwesterly along said southeasterly line of said Parcel No. 1 in deed dated and recorded aforesaid south 23 degrees 34 minutes 54 seconds west 167 feet to the point or place of BEGINNING.

**FOR
CONVEYANCING
ONLY**

The policy to be issued under this report will insure the title to such buildings and improvements erected on the premises which by law constitute real property.

TOGETHER with all the right, title and interest of the party in the first part, or, in and to the land lying in the street in front of and adjoining said premises.

**1-5 Holland Avenue
BCP Site No. C360115
Environmental Easement Package**

Item #2 – Copy of Tax Map

Tax Parcel Maps

Address: 1 HOLLAND AVE

Print Key: 125.07-1-1

SBL: Null

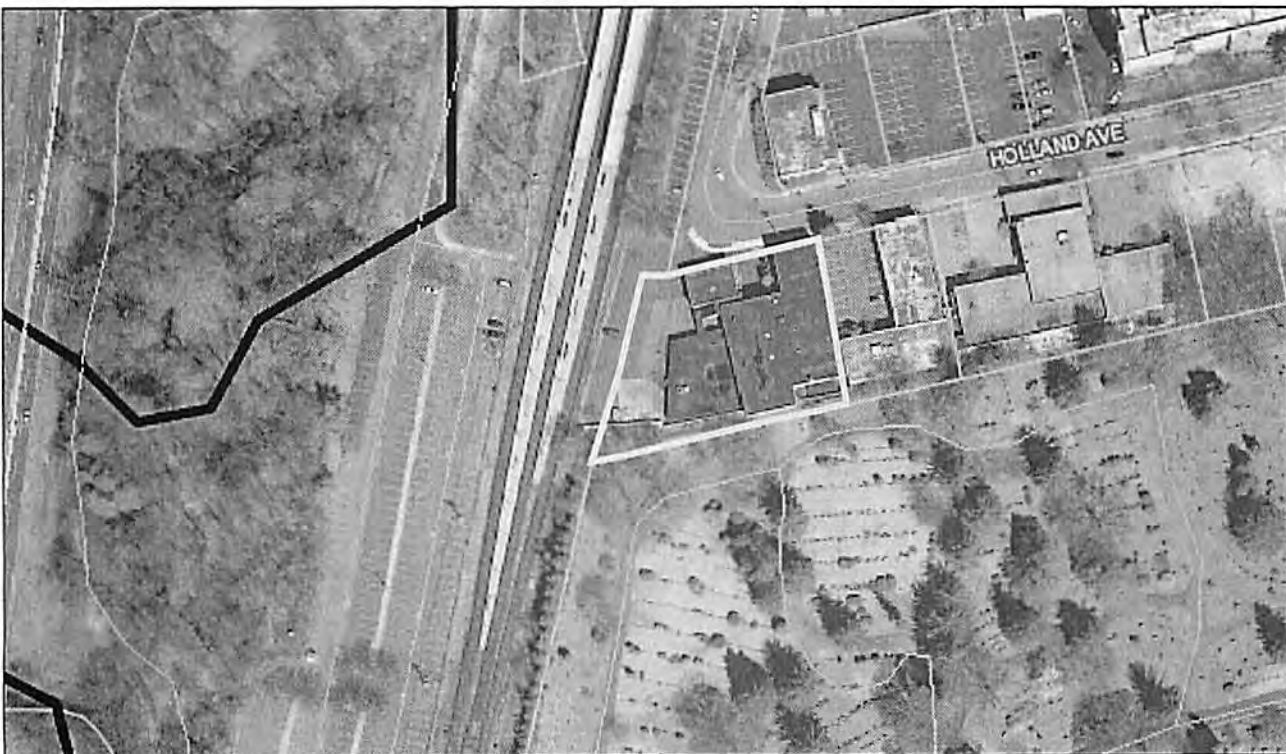
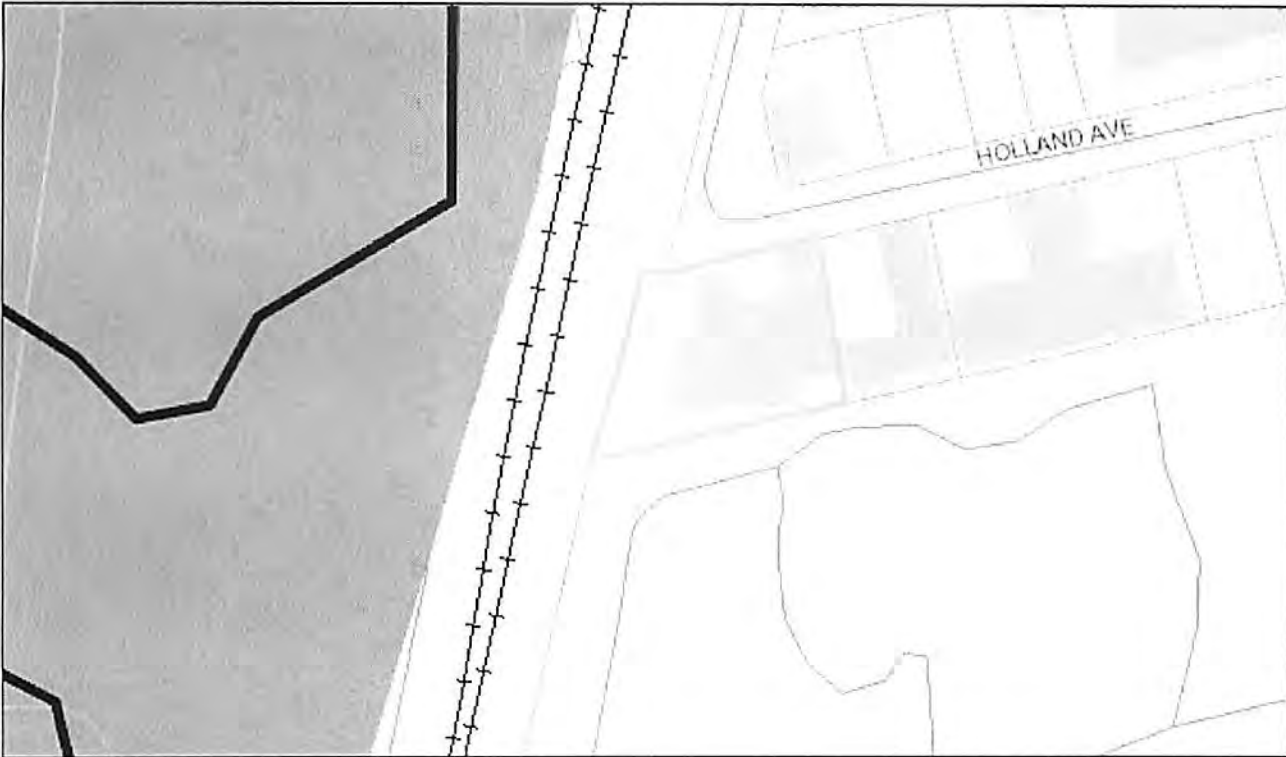

Disclaimer:

This tax parcel map is provided as a public service to Westchester County residents for general information and planning purposes only, and should not be relied upon as a sole informational source. The County of Westchester hereby disclaims any liability from the use of this GIS mapping system by

any person or entity. Tax parcel boundaries represent approximate property line location and should **NOT** be interpreted as or used in lieu of a survey or property boundary description. Property descriptions must be obtained from surveys or deeds. For more information please contact the assessor's office of the municipality.

**1-5 Holland Avenue
BCP Site No. C360115
Environmental Easement Package**

Item #3 – Environmental Easement

**ENVIRONMENTAL EASEMENT GRANTED PURSUANT TO ARTICLE 71, TITLE 36
OF THE NEW YORK STATE ENVIRONMENTAL CONSERVATION LAW**

THIS INDENTURE made this _____ day of _____, 20___, between Owner(s) 1 Holland LLC, having an office at 1 Holland Avenue, White Plains, County of Westchester, State of New York (the "Grantor"), and The People of the State of New York (the "Grantee."), acting through their Commissioner of the Department of Environmental Conservation (the "Commissioner", or "NYSDEC" or "Department" as the context requires) with its headquarters located at 625 Broadway, Albany, New York 12233,

WHEREAS, the Legislature of the State of New York has declared that it is in the public interest to encourage the remediation of abandoned and likely contaminated properties ("sites") that threaten the health and vitality of the communities they burden while at the same time ensuring the protection of public health and the environment; and

WHEREAS, the Legislature of the State of New York has declared that it is in the public interest to establish within the Department a statutory environmental remediation program that includes the use of Environmental Easements as an enforceable means of ensuring the performance of operation, maintenance, and/or monitoring requirements and the restriction of future uses of the land, when an environmental remediation project leaves residual contamination at levels that have been determined to be safe for a specific use, but not all uses, or which includes engineered structures that must be maintained or protected against damage to perform properly and be effective, or which requires groundwater use or soil management restrictions; and

WHEREAS, the Legislature of the State of New York has declared that Environmental Easement shall mean an interest in real property, created under and subject to the provisions of Article 71, Title 36 of the New York State Environmental Conservation Law ("ECL") which contains a use restriction and/or a prohibition on the use of land in a manner inconsistent with engineering controls which are intended to ensure the long term effectiveness of a site remedial program or eliminate potential exposure pathways to hazardous waste or petroleum; and

WHEREAS, Grantor, is the owner of real property located at the address of 1-5 Holland Avenue in the City of White Plains, County of Westchester and State of New York, known and designated on the tax map of the County Clerk of Westchester as tax map parcel numbers: Section 125.07 Block 1 Lot 1, being the same as that property conveyed to Grantor by deed dated September 30, 2013 and recorded in the Westchester County Clerk's Office in Instrument No. 532733496. The property subject to this Environmental Easement (the "Controlled Property") comprises approximately 0.72 +/- acres, and is hereinafter more fully described in the Land Title Survey dated June 30, 2009 and revised on May ___ 2014 prepared by Aristotle Bournazos, which will be attached to the Site Management Plan. The Controlled Property description is set forth in and attached hereto as Schedule A; and

WHEREAS, the Department accepts this Environmental Easement in order to ensure the protection of public health and the environment and to achieve the requirements for remediation

established for the Controlled Property until such time as this Environmental Easement is extinguished pursuant to ECL Article 71, Title 36; and

NOW THEREFORE, in consideration of the mutual covenants contained herein and the terms and conditions of Brownfield Cleanup Agreement Index Number: C360115-11-10, as amended by Amendment #1. Grantor conveys to Grantee a permanent Environmental Easement pursuant to ECL Article 71, Title 36 in, on, over, under, and upon the Controlled Property as more fully described herein ("Environmental Easement")

1. **Purposes.** Grantor and Grantee acknowledge that the Purposes of this Environmental Easement are: to convey to Grantee real property rights and interests that will run with the land in perpetuity in order to provide an effective and enforceable means of encouraging the reuse and redevelopment of this Controlled Property at a level that has been determined to be safe for a specific use while ensuring the performance of operation, maintenance, and/or monitoring requirements; and to ensure the restriction of future uses of the land that are inconsistent with the above-stated purpose.

2. **Institutional and Engineering Controls.** The controls and requirements listed in the Department approved Site Management Plan ("SMP") including any and all Department approved amendments to the SMP are incorporated into and made part of this Environmental Easement. These controls and requirements apply to the use of the Controlled Property, run with the land, are binding on the Grantor and the Grantor's successors and assigns, and are enforceable in law or equity against any owner of the Controlled Property, any lessees and any person using the Controlled Property.

A. (1) The Controlled Property may be used for:

Commercial as described in 6 NYCRR Part 375-1.8(g)(2)(iii) and Industrial as described in 6 NYCRR Part 375-1.8(g)(2)(iv) if current land use is selected.
ENTER CURRENT USE.

(2) All Engineering Controls must be operated and maintained as specified in the Site Management Plan (SMP);

(3) All Engineering Controls must be inspected at a frequency and in a manner defined in the SMP;

(4) The use of groundwater underlying the property is prohibited without necessary water quality treatment as determined by the NYSDOH or the Westchester County Department of Health to render it safe for use as drinking water or for industrial purposes, and the user must first notify and obtain written approval to do so from the Department;

(5) Groundwater and other environmental or public health monitoring must be performed as defined in the SMP;

(6) Data and information pertinent to Site Management of the Controlled Property must be reported at the frequency and in a manner defined in the SMP;

(7) All future activities on the property that will disturb remaining contaminated material must be conducted in accordance with the SMP;

(8) Monitoring to assess the performance and effectiveness of the remedy must be performed as defined in the SMP;

(9) Operation, maintenance, monitoring, inspection, and reporting of any mechanical or physical components of the remedy shall be performed as defined in the SMP;

(10) Access to the site must be provided to agents, employees or other representatives of the State of New York with reasonable prior notice to the property owner to assure compliance with the restrictions identified by this Environmental Easement.

B. The Controlled Property shall not be used for Residential or Restricted Residential purposes as defined in 6NYCRR 375-1.8(g)(2)(i) and (ii), and the above-stated engineering controls may not be discontinued without an amendment or extinguishment of this Environmental Easement.

C. The SMP describes obligations that the Grantor assumes on behalf of Grantor, its successors and assigns. The Grantor's assumption of the obligations contained in the SMP which may include sampling, monitoring, and/or operating a treatment system, and providing certified reports to the NYSDEC, is and remains a fundamental element of the Department's determination that the Controlled Property is safe for a specific use, but not all uses. The SMP may be modified in accordance with the Department's statutory and regulatory authority. The Grantor and all successors and assigns, assume the burden of complying with the SMP and obtaining an up-to-date version of the SMP from:

Site Control Section
Division of Environmental Remediation
NYSDEC
625 Broadway
Albany, New York 12233
Phone: (518) 402-9553

D. Grantor must provide all persons who acquire any interest in the Controlled Property a true and complete copy of the SMP that the Department approves for the Controlled Property and all Department-approved amendments to that SMP.

E. Grantor covenants and agrees that until such time as the Environmental Easement is extinguished in accordance with the requirements of ECL Article 71, Title 36 of the ECL, the property deed and all subsequent instruments of conveyance relating to the Controlled Property shall state in at least fifteen-point bold-faced type:

This property is subject to an Environmental Easement held

by the New York State Department of Environmental Conservation pursuant to Title 36 of Article 71 of the Environmental Conservation Law.

F. Grantor covenants and agrees that this Environmental Easement shall be incorporated in full or by reference in any leases, licenses, or other instruments granting a right to use the Controlled Property.

G. Grantor covenants and agrees that it shall, at such time as NYSDEC may require, submit to NYSDEC a written statement by an expert the NYSDEC may find acceptable certifying under penalty of perjury, in such form and manner as the Department may require, that:

(1) the inspection of the site to confirm the effectiveness of the institutional and engineering controls required by the remedial program was performed under the direction of the individual set forth at 6 NYCRR Part 375-1.8(h)(3).

(2) the institutional controls and/or engineering controls employed at such site:
(i) are in-place;
(ii) are unchanged from the previous certification, or that any identified changes to the controls employed were approved by the NYSDEC and that all controls are in the Department-approved format; and

(iii) that nothing has occurred that would impair the ability of such control to protect the public health and environment;

(3) the owner will continue to allow access to such real property to evaluate the continued maintenance of such controls;

(4) nothing has occurred that would constitute a violation or failure to comply with any site management plan for such controls;

(5) the report and all attachments were prepared under the direction of, and reviewed by, the party making the certification;

(6) to the best of his/her knowledge and belief, the work and conclusions described in this certification are in accordance with the requirements of the site remedial program, and generally accepted engineering practices; and

(7) the information presented is accurate and complete.

3. Right to Enter and Inspect. Grantee, its agents, employees, or other representatives of the State may enter and inspect the Controlled Property in a reasonable manner and at reasonable times to assure compliance with the above-stated restrictions.

4. Reserved Grantor's Rights. Grantor reserves for itself, its assigns, representatives, and successors in interest with respect to the Property, all rights as fee owner of the Property, including:

A. Use of the Controlled Property for all purposes not inconsistent with, or limited by the terms of this Environmental Easement;

B. The right to give, sell, assign, or otherwise transfer part or all of the underlying fee

Albany, NY 12233

All notices and correspondence shall be delivered by hand, by registered mail or by Certified mail and return receipt requested. The Parties may provide for other means of receiving and communicating notices and responses to requests for approval.

7. Recordation. Grantor shall record this instrument, within thirty (30) days of execution of this instrument by the Commissioner or her/his authorized representative in the office of the recording officer for the county or counties where the Property is situated in the manner prescribed by Article 9 of the Real Property Law.

8. Amendment. Any amendment to this Environmental Easement may only be executed by the Commissioner of the New York State Department of Environmental Conservation or the Commissioner's Designee, and filed with the office of the recording officer for the county or counties where the Property is situated in the manner prescribed by Article 9 of the Real Property Law.

9. Extinguishment. This Environmental Easement may be extinguished only by a release by the Commissioner of the New York State Department of Environmental Conservation, or the Commissioner's Designee, and filed with the office of the recording officer for the county or counties where the Property is situated in the manner prescribed by Article 9 of the Real Property Law.

10. Joint Obligation. If there are two or more parties identified as Grantor herein, the obligations imposed by this instrument upon them shall be joint and several.

IN WITNESS WHEREOF, Grantor has caused this instrument to be signed in its name.

1 Holland LLC:

By: _____

Print Name: _____

Title: _____ Date: _____

Grantor's Acknowledgment

STATE OF NEW YORK)
) ss:
COUNTY OF)

On the _____ day of _____, in the year 20 __, before me, the undersigned, personally appeared _____, personally known to me or proved to me on the basis of satisfactory evidence to be the individual(s) whose name is (are) subscribed to the within instrument and acknowledged to me that he/she/they executed the same in his/her/their capacity(ies), and that by his/her/their signature(s) on the instrument, the individual(s), or the person upon behalf of which the individual(s) acted, executed the instrument.

Notary Public - State of New York

THIS ENVIRONMENTAL EASEMENT IS HEREBY ACCEPTED BY THE PEOPLE OF THE STATE OF NEW YORK, Acting By and Through the Department of Environmental Conservation as Designee of the Commissioner,

By:

Robert W. Schick, Director
Division of Environmental Remediation

Grantee's Acknowledgment

STATE OF NEW YORK)
) ss:
COUNTY OF ALBANY)

On the _____ day of _____, in the year 20__, before me, the undersigned, personally appeared Robert W. Schick, personally known to me or proved to me on the basis of satisfactory evidence to be the individual(s) whose name is (are) subscribed to the within instrument and acknowledged to me that he/she/ executed the same in his/her/ capacity as Designee of the Commissioner of the State of New York Department of Environmental Conservation, and that by his/her/ signature on the instrument, the individual, or the person upon behalf of which the individual acted, executed the instrument.

Notary Public - State of New York

SCHEDULE "A" PROPERTY DESCRIPTION

PARCEL I

ALL those certain lots, pieces or parcels of land, situate, lying and being in the City of White Plains, County of Westchester and State of New York, known and designated as Lot Numbers 1, 2, 3, 4 and 13 in Block 3, on a certain map entitled, "Map of North White Plains, the Terminal City, situated in the Town and Village of White Plains and the Town of North Castle, in the County of Westchester and State of New York, surveyed for New York Suburbs Co." made by Lewis T. Haney, Civil Engineer and City Surveyor, 1907 and filed in the County Clerk's Office, Division of Land Records, formerly Register's Office of Westchester County, September 23, 1907 as Map Number 1749 and bounded and described as follows:

BEGINNING at the corner formed by the intersection of the southerly side of Holland Avenue and the easterly side of lands of the New York Central Railroad;

RUNNING THENCE along the southerly side of Holland Avenue, north 88 degrees 12 minutes 40 seconds east 140 feet to a point on the westerly side of Lot No. 5;

RUNNING THENCE along the same, south 1 degrees 47 minutes 20 seconds east 150.65 feet to a point;

RUNNING THENCE south 87 degrees 58 minutes west 76.28 feet and south 88 degrees 14 minutes 00 seconds west 135.27 feet to the easterly side of land of New York Central Railroad;

RUNNING THENCE along the same, north 23 degrees 34 minutes 54 seconds east 167 feet to the point of BEGINNING.

Comprising ____ acres.

PARCEL II

ALL that certain plot, piece or parcel of land, situate, lying and being in the City of White Plains, County of Westchester and State of New York, bounded and described as follows:

BEGINNING at the southeasterly corner of the premises described and designated as Parcel No 1 in deed from Margaretta S. Clark to the New York Central and Hudson River Railroad Company, dated April 9, 1901 recorded in the Office of the Clerk of said County of Westchester, now Division of Land Records in Liber 1577 of deeds at page 216; and

RUNNING THENCE westerly along the southerly line of said Parcel No. 1 described in deed dated and recorded as aforesaid south 88 degrees 10 minutes 50 seconds west 33.08 feet to the southwesterly corner thereof, said corner being distant southeasterly 41.25 feet measured at right angles from the original center line of the New York and Harlem Railroad, said center line being marked by stone monument set in the ground;

THENCE north 22 degrees 55 minutes 50 seconds east 90 feet, to a point opposite Chaining Station 125 plus 057.30 in said monumented center line;

THENCE north 29 degrees 09 minutes 05 seconds east 91.39 feet to a point distant southeasterly 51.15 feet measured at right angles from said monumented center line at chaining station 125 plus 148.12 feet therein;

THENCE south 67 degrees 06 minutes 12 seconds east 22.25 feet to a point in the

southeasterly line of Parcel No. 1 in deed dated and recorded aforesaid where the same is intersected by the southerly line of Holland Avenue;
...SCHEDULE "A" PROPERTY DESCRIPTION (continued)

THENCE southwesterly along said southeasterly line of said Parcel No. 1 in deed dated and recorded aforesaid south 23 degrees 34 minutes 54 seconds west 167 feet to the point or place of BEGINNING.

Comprising ____ acres.

**1-5 Holland Avenue
BCP Site No. C360115
Environmental Easement Package**

Item #4 – Title Verification; Last Owner Search



JUDICIAL RESEARCH CORP.
Your Co-op Experts

June 2, 2014

Neal Frink, Esq.
The Frink Law Firm LLC
250 East Fifth Street Suite 1500
Chiquita Building
Cincinnati, OH 45202

RE: Invoice No.: 247554
Premises: 1-5 Holland Avenue, White Plains, NY
County: Westchester

Dear Mr. Frink:

Thank you for choosing the Judicial Research Corp. to assist you in the above-referenced matter. Your request for the *Last Deed of Record Search* has been received. Attached are the results as well as the copies to substantiate our findings.

Enclosed you will also find our invoice for services rendered. Payment is required regardless of a closing. Should you have any further questions, please do not hesitate to call our legal department at 914-899-3838 or 1-800-281-8485.

Very truly yours,
Legal Department

LIABILITY FOR THIS SEARCH IS LIMITED TO THE COST OF THE SEARCH ONLY.

800 Westchester Avenue | Suite S-340 | Rye Brook, NY 10573 | 914-381-6700 | Fax 914-381-3131
114 West 47th Street | 19th Floor | New York, NY 10036 | 800-281-TITLE (8485) | 212-432-3272 | Fax 800-FAX-9396
www.judicialtitle.com

JUDICIAL RESEARCH CORPORATION

Last Deed of Record Search

1 Holland LLC

By Deed from: One Holland Avenue Development LLC

Dated: 9/30/2013 **Recorded:** 10/15/2013 **Control No.** 532733496

Copy(s) attached

Please contact our Legal Department with any questions that you may have regarding this search.

LIABILITY OF THIS SEARCH IS LIMITED TO THE COST OF THIS SEARCH ONLY

The Office of the Westchester County Clerk: This page is part of the instrument; the County Clerk will rely on the information provided on this page for purposes of indexing this instrument. To the best of submitter's knowledge, the information contained on this Recording and Endorsement Cover Page is consistent with the information contained in the attached document.



532733496DED0016

Westchester County Recording & Endorsement Page

Submitter Information

Name:	Judicial Title Insurance- PICK UP	Phone:	914-381-6700
Address 1:	800 Westchester Avenue	Fax:	914-381-6785
Address 2:		Email:	ltriglia@judicialtitle.com
City/State/Zip:	Rye Brook NY 10573	Reference for Submitter:	113135

Document Details

Control Number:	532733496	Document Type:	Deed (DED)
Package ID:	2013093000271001001	Document Page Count:	4
		Total Page Count:	5

Parties

1st PARTY		2nd PARTY	
1:	ONE HOLLAND AVE DEVELOPMENT LLC	1:	1 HOLLAND LLC
2:		2:	

Additional Parties on Continuation page

Property

Street Address:	1-5 HOLLAND AVENUE	Tax Designation:	125.07-1-1
City/Town:	WHITE PLAINS	Village:	

Additional Properties on Continuation page

Cross-References

1:	2:	3:	4:
----	----	----	----

Additional Cross-Refs on Continuation page

Supporting Documents

1: RP-5217	2: TP-584
------------	-----------

Recording Fees

Statutory Recording Fee:	\$40.00
Page Fee:	\$25.00
Cross-Reference Fee:	\$0.00
Mortgage Affidavit Filing Fee:	\$0.00
RP-5217 Filing Fee:	\$250.00
TP-584 Filing Fee:	\$5.00
Total Recording Fees Paid:	\$320.00

Mortgage Taxes

Document Date:	
Mortgage Amount:	
Basic:	\$0.00
Westchester:	\$0.00
Additional:	\$0.00
MTA:	\$0.00
Special:	\$0.00
Yonkers:	\$0.00
Total Mortgage Tax:	\$0.00
Dwelling Type:	Exempt: <input type="checkbox"/>
Serial #:	

Transfer Taxes

Consideration:	\$1,825,000.00
Transfer Tax:	\$7,300.00
Mansion Tax:	\$0.00
Transfer Tax Number:	3566

RECORDED IN THE OFFICE OF THE WESTCHESTER COUNTY CLERK



Recorded: 10/15/2013 at 04:34 PM
 Control Number: 532733496
 Witness my hand and official seal

Timothy C. Idoni
Westchester County Clerk

Record and Return To

Pick-up at County Clerk's office

Judicial title insurance
 800 westchester avenue
 rye brook , NY 10573

BARGAIN AND SALE DEED WITH COVENANT AGAINST GRANTOR'S ACTS

THIS INDENTURE, made as of the 30th day of September, two thousand thirteen, between

ONE HOLLAND AVENUE DEVELOPMENT LLC, a New York Limited Liability Company, with an address at 11280 Cornell Park Drive, Cincinnati, Ohio 45242

party of the first part, and

1 HOLLAND LLC, a New York Limited Liability Company, with an address at 1 Holland Avenue, White Plains, NY 10603,

party of the second part,

WITNESSETH, that the party of the first part, in consideration of Ten (\$10.00) dollars and other good and valuable consideration, lawful money of the United States, paid by the party of the second part, does hereby grant and release unto the party of the second part, the heirs or successors and assigns of the party of the second part forever,

ALL that certain plot, piece or parcel of land, with the buildings and improvements thereon erected, situate, lying and being in the City of White Plains, County of Westchester and State of New York, located at and known as 1 Holland Avenue, White Plains, NY as more particularly described on SCHEDULE "A" attached hereto.

TOGETHER with all right, title and interest, if any, of the party of the first part in and to any streets and roads abutting the above described premises to the center lines thereof,

TOGETHER with the appurtenances and all the estate and rights of the party of the first part in and to said premises,

TO HAVE AND TO HOLD the premises herein granted unto the party of the second part, the heirs or successors and assigns of the party of the second part forever.

PARTY OF THE FIRST PART herein is the same person as Grantee and the premises is and is intended to be the same premises in a certain Deed dated August 13, 2009 and recorded on September 14, 2009 in Control No. 492430014 in the Westchester County Clerk's Office, Division of Land Records.

AND the party of the first part, covenants that the party of the first part has not done or suffered anything whereby the said premises have been encumbered in any way whatever, except as aforesaid.

AND the party of the first part, in compliance with Section 13 of the Lien Law, covenants that the party of the first part will receive the consideration for this conveyance and will hold the right to receive such consideration as a trust fund to be applied first for the purpose of paying the cost of the improvement and will apply the same first to the payment of the cost of the improvement before using any part of the total of the same for any other purpose.

The word "party" shall be construed as if it read "parties" whenever the sense of this indenture so requires.

KIP

IN WITNESS WHEREOF, the party of the first part has duly executed this deed as of the day and year first above written.

IN PRESENCE OF:

ONE HOLLAND AVENUE DEVELOPMENT LLC

By: *Karen Puckett*
KAREN PUCKETT, Vice President

State of Ohio)
County of Hamilton) ss:

On the 30th day of September in the year 2013 before me, the undersigned, personally appeared **KAREN PUCKETT**, personally known to me or proved to me on the basis of satisfactory evidence to be the individual whose name is subscribed to the within instrument and acknowledged to me that she executed the same in her capacity, and that by her signature on the instrument, the individual, or the person upon behalf of which the individual acted, executed the instrument.

02-13-2015

Jennifer A. Davidson
Notary Public

Jennifer A. Davidson
Notary Public, State of Ohio
My Commission Expires 02-13-2015

**BARGAIN & SALE DEED
WITH COVENANT AGAINST GRANTOR'S ACTS**

ONE HOLLAND AVENUE DEVELOPMENT LLC

TO

1 HOLLAND LLC

SECTION: 125.7
BLOCK: 1
LOT: 1
COUNTY: Westchester
PREMISES: 1 Holland Avenue
White Plains, NY

RECORD & RETURN TO:

**THE JUDICIAL TITLE INSURANCE AGENCY LLC
800 WESTCHESTER AVENUE | SUITE 9-340
1 RYE BROOK, NY 10573
914-381-6700**

WP

THE JUDICIAL TITLE INSURANCE AGENCY LLC

Title Number: 113135ST-W

SCHEDULE A

PARCEL I

ALL those certain lots, pieces or parcels of land, situate, lying and being in the City of White Plains, County of Westchester and State of New York, known and designated as Lot Numbers 1, 2, 3, 4 and 13 in Block 3, on a certain map entitled, "Map of North White Plains, the Terminal City, situated in the Town and Village of White Plains and the Town of North Castle, in the County of Westchester and State of New York, surveyed for New York Suburbs Co." made by Lewis T. Haney, Civil Engineer and City Surveyor, 1907 and filed in the County Clerk's Office, Division of Land Records, formerly Register's Office of Westchester County, September 23, 1907 as Map Number 1749 and bounded and described as follows:

BEGINNING at the corner formed by the intersection of the southerly side of Holland Avenue with the easterly side of lands of New York Central Railroad;

RUNNING THENCE along the southerly side of Holland Avenue, north 88 degrees 12 minutes 40 seconds east 140 feet to a point on the westerly side of Lot No. 5;

RUNNING THENCE along the same, south 1 degrees 47 minutes 20 seconds east 150.65 feet to a point;

RUNNING THENCE south 87 degrees 58 minutes west 76.28 feet and south 88 degrees 14 minutes 00 seconds west 135.27 feet to the easterly side of land of New York Central Railroad;

RUNNING THENCE along the same, north 23 degrees 34 minutes 54 seconds east 167 feet to the point of **BEGINNING**.

PARCEL II

ALL that certain plot, piece or parcel of land, situate, lying and being in the City of White Plains, County of Westchester and State of New York, bounded and described as follows:

BEGINNING at the southeasterly corner of the premises described and designated as Parcel No. 1 in deed from Margaretta S. Clark to the New York Central and Hudson River Railroad Company, dated April 9, 1901 recorded in the Office of the Clerk of said

THE JUDICIAL TITLE INSURANCE AGENCY LLC

Title Number: 113135ST-W

SCHEDULE A (continued)

County of Westchester, now Division of Land Records in Liber 1577 of deeds at page 216; and

RUNNING THENCE westerly along the southerly line of said Parcel No. 1 described in deed dated and recorded as aforesaid south 88 degrees 10 minutes 50 seconds west 33.08 feet to the southwesterly corner thereof, said corner being distant southeasterly 41.25 feet measured at right angles from the original center line of the New York and Harlem Railroad, said center line being marked by stone monument set in the ground;

THENCE north 22 degrees 55 minutes 50 seconds east 90 feet, to a point opposite Chaining Station 125 plus 057.30 in said monumented center line;

THENCE north 29 degrees 09 minutes 05 seconds east 91.39 feet to a point distant southeasterly 51.15 feet measured at right angles from said monumented center line at Chaining Station 125 plus 148.12 feet therein;

THENCE south 67 degrees 06 minutes 12 seconds east 22.25 feet to a point in the southeasterly line of Parcel No. 1 in deed dated and recorded aforesaid where the same is intersected by the southerly line of Holland Avenue;

THENCE southwesterly along said southeasterly line of said Parcel No. 1 in deed dated and recorded aforesaid south 23 degrees 34 minutes 54 seconds west 167 feet to the point or place of BEGINNING.

**FOR
CONVEYANCING
ONLY**

The policy to be issued under this report will insure the title to such buildings and improvements erected on the premises which by law constitute real property.

TOGETHER with all the right, title and interest of the party in the first part, or, in and to the land lying in the street in front of and adjoining said premises.

**1-5 Holland Avenue
BCP Site No. C360115
Environmental Easement Package**

Item #5 – Legal Description of Easement Area

Legal Description
Environmental Easement Area
1-5 Holland Avenue
BCP Site #C360115

PARCEL I

ALL those certain lots, pieces or parcels of land, situate, lying and being in the City of White Plains, County of Westchester and State of New York, known and designated as Lot Numbers 1, 2, 3, 4 and 13 in Block 3, on a certain map entitled, "Map of North White Plains, the Terminal City, situated in the Town and Village of White Plains and the Town of North Castle, in the County of Westchester and State of New York, surveyed for New York Suburbs Co." made by Lewis T. Haney, Civil Engineer and City Surveyor, 1907 and filed in the County Clerk's Office, Division of Land Records, formerly Register's Office of Westchester County, September 23, 1907 as Map Number 1749 and bounded and described as follows:

BEGINNING at the corner formed by the intersection of the southerly side of Holland Avenue and the easterly side of lands of the New York Central Railroad;

RUNNING THENCE along the southerly side of Holland Avenue, north 88 degrees 12 minutes 40 seconds east 140 feet to a point on the westerly side of Lot No. 5;

RUNNING THENCE along the same, south 1 degrees 47 minutes 20 seconds east 150.65 feet to a point;

RUNNING THENCE south 87 degrees 58 minutes west 76.28 feet and south 88 degrees 14 minutes 00 seconds west 135.27 feet to the easterly side of land of New York Central Railroad;

RUNNING THENCE along the same, north 23 degrees 34 minutes 54 seconds east 167 feet to the point of BEGINNING.

Comprising 0.6089 acres.

PARCEL II

ALL that certain plot, piece or parcel of land, situate, lying and being in the City of White Plains, County of Westchester and State of New York, bounded and described as follows:

BEGINNING at the southeasterly corner of the premises described and designated as Parcel No 1 in deed from Margaretta S. Clark to the New York Central and Hudson River Railroad Company, dated April 9, 1901 recorded in the Office of the Clerk of said County of Westchester, now Division of Land Records in Liber 1577 of deeds at page 216; and

RUNNING THENCE westerly along the southerly line of said Parcel No. 1 described in deed dated and recorded as aforesaid south 88 degrees 10 minutes 50 seconds west 33.08 feet to the southwesterly corner thereof, said corner being distant southeasterly 41.25 feet measured at right angles from the original center line of the New York and Harlem Railroad, said center line being marked by stone monument set in the ground;

THENCE north 22 degrees 55 minutes 50 seconds east 90 feet, to a point opposite Chaining Station 125 plus 057.30 in said monumented center line;

THENCE north 29 degrees 09 minutes 05 seconds east 91.39 feet to a point distant southeasterly 51.15 feet measured at right angles from said monumented center line at chaining station 125 plus 148.12 feet therein; THENCE south 67 degrees 06 minutes 12 seconds east 22.25 feet to a point in the southeasterly line of Parcel No. 1 in deed dated and recorded aforesaid where the same is intersected by the southerly line of Holland Avenue;

THENCE southwesterly along said southeasterly line of said Parcel No. 1 in deed dated and recorded aforesaid south 23 degrees 34 minutes 54 seconds west 167 feet to the point or place of BEGINNING.

Comprising 0.1132 acres

**1-5 Holland Avenue
BCP Site No. C360115
Environmental Easement Package**

Item #6 – Survey

(Separate File)

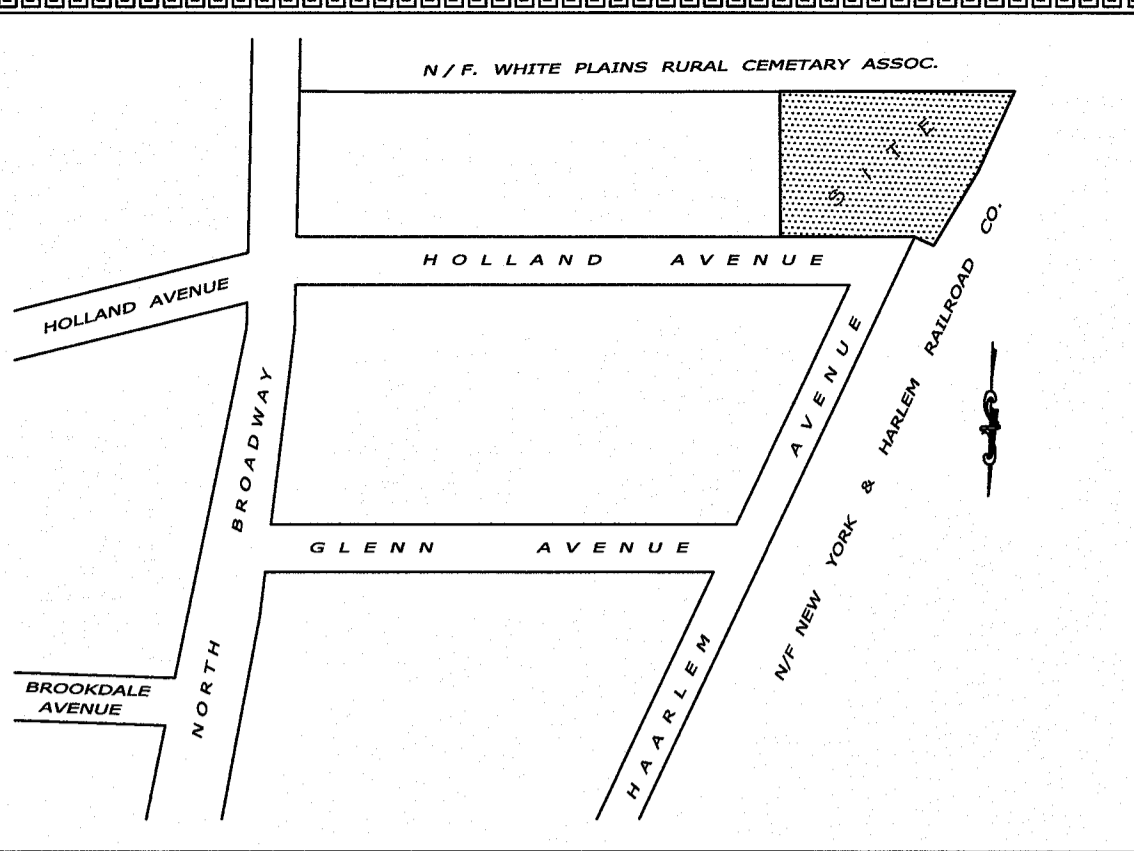

LOCATION MAP (N.T.S)

ARISTOTLE BOURNAZOS, P.C.

LAND SURVEYORS - PLANNERS

20 CEDAR STREET
NEW ROCHELLE
NEW YORK, 10801
(914)633-0100



LICENSED IN
NEW YORK
NEW JERSEY
CONNECTICUT

SURVEY
OF

TAX LOT 1, BLOCK 1, SECTION 125.07 AS SHOWN ON THE
TAX ASSESSMENT MAPS OF THE CITY OF WHITE PLAINS,
WESTCHESTER COUNTY, NEW YORK.

(Property also known as Lots 1, 2, 3, 4 & 13, Block 3 as shown on
"Map of North White Plains, the Terminal City...", and filed in the
Westchester County Clerk's Office, Division of Land Records on Sept. 23, 1907
as Map No. 1749; together with a parcel of land adjacent to the west.)

SURVEY COMPLETED : June 30, 2009
MAP DRAWN : July 6, 2009
REVISED : JULY 23, 2009
SURVEY UPDATED : MAY 27, 2014
REVISED : JUNE 4, 2014

SCALE : 1 IN. = 20 FT

I hereby certify this survey to:
One Holland Avenue Development LLC
1 Holland LLC

6/14/14
DATE

Aristotle Bournazos, P.C.
ARISTOTLE BOURNAZOS, L.S., N.Y.S. L.C. No.46553

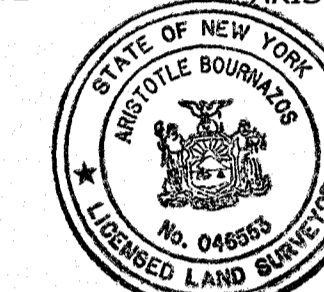

NOTES:

- Property shown hereon lies in Zone X (area determined to be outside the 0.2% annual chance floodplain) as per Firm 36119C0267; effective date 9/28/07 for City of White Plains, NY; Community No. 360935.
- Area of property shown hereon = 31,456 Square Feet.
Area of Parcel I = 26,525 Square Feet.
Area of Parcel II = 4931 Square Feet.
- Property shown hereon lies in Zone LI (Light Industrial).
 - Max bldg. coverage = 80%
 - Max F.A.R. = 2.00
 - Min lot area = 5000 S.F.
 - Min lot frontage = 50 Ft.
 - Min yard setbacks = None
 - Max bldg. height = 4 Stories
- Total area of footprint of buildings at ground level = 16,417 sq. ft.
- Address of subject premises: 1-5 Holland Avenue
White Plains, NY 10603

Environmental Easement and Engineering Controls:

- Environmental Easement: the entire 31,456 sq. ft. (0.7221 acres) of the surveyed property is subject to an Environmental Easement.
- Soil Cover System: the entire 31,456 sq. ft. (0.7221 acres) of the surveyed property is subject to an engineering control that prevents exposure to remaining contamination in soils/fill at the Site.
- Sub-Slab Depressurization System: the Building Structures area covering the footprint of buildings at ground level and comprising 16,417 sq. ft. (0.3769 acres) is subject to an engineering control that mitigates potential for vapor intrusion into building structures at the Site. A metes and bounds description of the Building Structures area is provided below.

MAIN BUILDING No. 1

ALL that certain plot, piece or parcel of land, and the building situated thereon, situate, lying and being in the City of White Plains, County of Westchester and State of New York, known and designated as portions of Lot Numbers 1, 2, 3, 4 and 13 in Block 3 on a certain map entitled, "Map of North White Plains, the Terminal City, situated in the Town and Village of White Plains and the Town of North Castle, in the County of Westchester and State of New York, surveyed for New York Suburbs Co." made by Lewis T. Hane, Civil Engineer and City Surveyor, 1907 and filed in the County Clerk's Office, Division of Land Records, formerly Register's Office of Westchester County, September 23, 1907 as Map Number 1749 and bounded and described as follows:

BEGINNING at a point lying within Lot 4 as shown on said Map being distant 5.73 feet on a bearing of S 08°27'44" W from the northeasterly corner of said Lot 4;

RUNNING THENCE through Lots 4, 3, 2, 1 and 13 the following courses and distances:

- S 01°43'38" E, 125.2 feet to a point,
- S 88°04'20" W, 10.3 feet to a point,
- S 01°55'40" E, 9.5 feet to a point,
- S 88°04'20" W, 26.0 feet to a point,
- N 01°55'40" W, 9.5 feet to a point,
- S 88°04'20" W, 12.6 feet to a point,
- S 01°55'40" E, 15.6 feet to a point,
- S 88°04'20" W, 46.6 feet to a point,
- N 01°55'40" W, 11.7 feet to a point,
- S 88°13'11" W, 70.7 feet to a point,
- N 14°11'25" E, 70.5 feet to a point,
- N 88°13'11" E, 51.1 feet to a point,
- N 01°48'49" W, 19.0 feet to a point,
- N 87°57'45" E, 57.2 feet to a point,
- N 01°52'20" W, 40.7 feet to a point,
- and N 88°01'39" E, 45.0 feet to the point or place of beginning.

SMALL 2 STORY BRICK & STUCCO BUILDING

ALL that certain plot, piece or parcel of land, and the building situated thereon, situate, lying and being in the City of White Plains, County of Westchester and State of New York, known and designated as portions of Lot Numbers 1 and 13 in Block 3 on a certain map entitled, "Map of North White Plains, the Terminal City, situated in the Town and Village of White Plains and the Town of North Castle, in the County of Westchester and State of New York, surveyed for New York Suburbs Co." made by Lewis T. Hane, Civil Engineer and City Surveyor, 1907 and filed in the County Clerk's Office, Division of Land Records, formerly Register's Office of Westchester County, September 23, 1907 as Map Number 1749 and bounded and described as follows:

BEGINNING at a point lying within Lot 1 as shown on said Map being distant 80.18 feet on a bearing of S 80°15'40" W from the northeasterly corner of Lot 4 as shown on said Map;

RUNNING THENCE through Lots 1 and 13 the following courses and distances:

- S 01°48'35" E, 30.0 feet to a point,
- S 87°59'10" W, 18.7 feet to a point,
- S 01°48'00" E, 1.8 feet to a point,
- S 88°14'00" W, 4.0 feet to a point,
- N 02°00'50" W, 1.8 feet to a point,
- S 87°59'10" W, 22.2 feet to a point,
- N 01°58'05" W, 30.0 feet to a point,
- and N 88°01'39" E, 45.0 feet to the point or place of beginning.

N/F. WHITE PLAINS RURAL CEMETARY ASSOC.

TAX LOT 1, BLOCK 1, SECTION 125.08

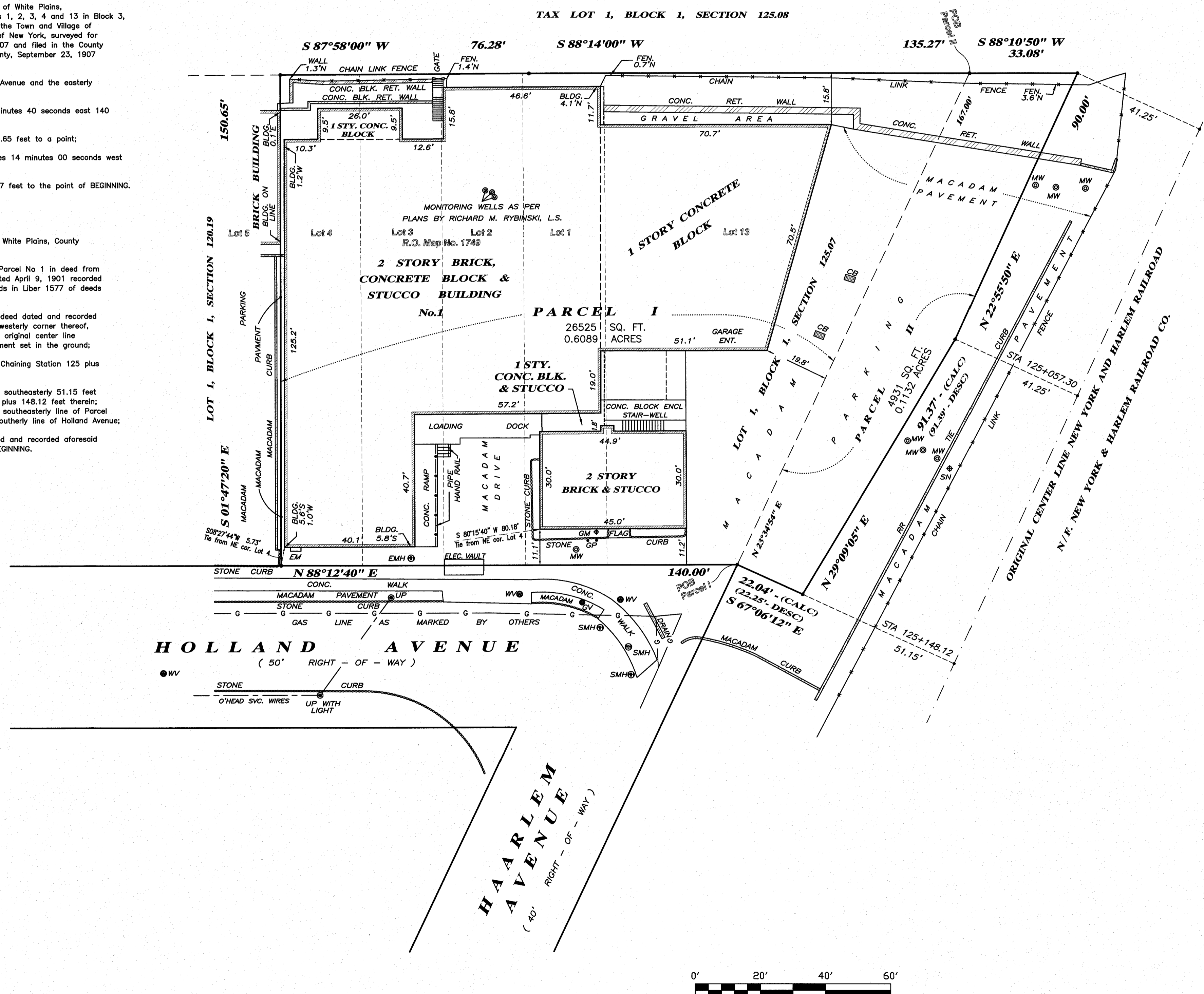

LEGEND	
CB	CATCH BASIN
SMH	SEWER MANHOLE
EMH	ELECTRIC MANHOLE
WV	WATER VALVE
SN	SIGN
EM	ELECTRIC METER
MW	MONITORING WELL
UP	UTILITY POLE
CONC	CONCRETE
SRW	STONE RETAINING WALL
RR	RAIL ROAD
ELEC	ELECTRIC
FLAG	FLAGSTONE
ENT	ENTRANCE
GM	GAS METER
GP	GUARD POST
GV	GAS VALVE

Unauthorized alteration or additions to this survey map is a violation of section 7209 sub-section 2, of the New York State Education Law. No guarantee is implied by this map as to the existence or non-existence of any easements of record that would affect subject property, unless surveyor has been furnished a complete copy of the title report. Dimensions shown from structures to property lines are not intended to be used for construction of fences, structures or other improvements.

**1-5 Holland Avenue
BCP Site No. C360115
Environmental Easement Package**

Item #7 – Draft Notice to Municipality

Notice to Municipality

_____, 2014

Damon Amadio, Commissioner
Building Department
City of White Plains
70 Church Street
White Plains, NY 10601

Re: Environmental Easement

Dear Mr. Amadio:

Attached please find a copy of an environmental easement granted to the New York State Department of Environmental Conservation ("DEC"):

on _____, 2014,
by 1 Holland LLC,
for property at 1-5 Holland Avenue, White Plains, Westchester County, New York,
Tax Map No. 125.07-1-1
DEC Site No: C360115.

This Environmental Easement restricts future use of the above-referenced property to restricted commercial or industrial uses. Any on-site activity must be done in accordance with the Environmental Easement and the Site Management Plan which is incorporated into the Environmental Easement. Department approval is also required prior to any groundwater use.

Article 71, Section 71-3607 of the New York State Environmental Conservation Law requires that:

1. Whenever the department is granted an environmental easement, it shall provide each affected local government with a copy of such easement and shall also provide a copy of any documents modifying or terminating such environmental easement.
2. Whenever an affected local government receives an application for a building permit or any other application affecting land use or development of land that is subject to an environmental easement and that may relate to or impact such easement, the affected local government shall notify the department and refer such application to the department. The department shall evaluate whether the application is consistent with the environmental easement and shall notify the affected local government of its determination in a timely fashion, considering the time frame for the local government's review of the application. The

affected local government shall not approve the application until it receives approval from the department.

An electronic version of every environmental easement that has been accepted by this Department is available to the public at: <http://www.dec.ny.gov/chemical/36045.html>. If you have any questions or comments regarding this matter, please do not hesitate to contact me.

Very truly yours,

**1-5 Holland Avenue
BCP Site No. C360115
Environmental Easement Package**

Item #8 – Environmental Easement Checklist/Certification

**ENVIRONMENTAL EASEMENT
CHECKLIST/CERTIFICATION
SITE No. C360115**

The following requirements and attachments must be included as part of the submission to the Department for an Environmental Easement. Upon completion of the review, an attorney must sign the certification certifying that they have fully completed the checklist. The Department will not accept submissions which have not been signed and certified as complete by both the Owner and Owner's Attorney.

1) Special Circumstances

The last owner search was completed and the deed transfer is by Quit Claim or other restricted transfer deed Yes No

The property in the Brownfield Cleanup Agreement includes lands under water Yes No

The property has multiple owners Yes No

If you answered "Yes" to any of these items, contact the Department's Environmental Easement contact person for a determination as to whether further title work is necessary.

2) Verification of ownership of the property

Authorized "Person" is signatory on the Easement. (1 Holland LLC)

Current Deed has been reviewed and correct name of owner has been verified.

Verification reviewed and included for authority to sign Easement.

→ Updated copies of legal organizational documents have been reviewed and are included. Examples of the appropriate documentation will include, for: (1 Holland LLC to provide)

- corporations: articles of incorporation, organizational agreements, minutes of annual meetings, resolutions, authorities for signature;
- partnerships: a copy of the partnership agreement; verification that necessary parties are participating in the Easement;
- trusts: trust agreement, affidavit of no change in the trust; and
- estates: estate letters, powers of attorney.

3) Verification of Property Subject to Easement

Description of the property in the Easement and DEC Agreement/Order/SAC matches description of property in the deed (Separate submittal must be included to explain to the satisfaction of the Department why there is any discrepancy).

The Tax Map identifier (SBL) matches on all documents.

4) Survey Review

Survey includes metes and bounds description.

Survey includes a graphic scale.

↓
only change is
correction to acreage
0.65 acre → 0.7221
acre.

- Survey includes physical Address and is consistent with the DEC Agreement/Order/SAC.

5) Review of Easement

- Attorney certifies Easement is in the form provided by the Department and that entries have been made only in those sections where authorized.
- Verification that the proper party has signed the Easement. Acknowledgement is in the proper form, notary stamp is clear and has a current expiration date.
- Name, property address, SBL, engineering controls/institutional controls, SMP references and any information that was inserted into the Easement form has been verified as correct and accurate.

- Two original Easements have been signed by the proper party. → will be executed following review

6) Submissions

- The Environmental Easement Package being submitted to the Department includes the applicable documents set forth in Attachment A.

PLEASE READ THE FOLLOWING CAREFULLY

The Owner and the Owner's attorney understand and acknowledge that the New York State Department of Environmental Conservation will rely on each and every answer in this statement: (1) to determine whether the Easement Package can be reviewed in a timely fashion; and (2) to determine whether the Easement Package should be approved. The Owner and the Owner's attorney understand and acknowledge that any false statement or misrepresentation herein will constitute cause for the revocation of the Certificate of Compliance issued in reliance on this checklist and accompanying documentation. The Owner and the Owner's attorney further acknowledge that the failure to provide the Department with valid and enforceable Environmental Easement on the property may be grounds for the Department to revoke any Certificate of Completion for the site.

Statement of Certification and Signatures

1) By Owner:

I hereby affirm that information provided on this form and its attachments is true and complete to the best of my knowledge and belief. I further acknowledge that the failure to provide the Department with valid and enforceable Environmental Easement on the property may be grounds for the Department to revoke any Certificate of Completion for the site.

Date: _____ Signature: _____

Print Name: _____

2) By Owner's Attorney:

I hereby affirm that I am the attorney for _____ (entity); that I am authorized by that entity to make this certification; that this certification was prepared by me or under my supervision and direction; and that information provided on this form and its attachments is true and complete to the best of my knowledge and belief.

Date: _____ Signature: _____

Print Name: _____

Attachment

Attachment A

Documents required for a complete Environmental Easement package:

- 1) Copy(ies) of current deed(s).
- 2) Copy of Tax map.
- 3) Two original easements and an electronic version submitted to both the project manager and project attorney.
- 4) Proof of authority to obligate owner of property as set forth in “Verification of ownership of property” on the Easement checklist.
- 5) Legal description of the easement area in a Department approved electronic form (i.e., Word).
- 6) Signed Survey, two full size copies and an electronic survey for review to both the project manager and project attorney.
- 7) A draft Notice to Municipality, with appropriate site-specific provisions.
- 8) Attorney Checklist with certification signed by attorney and owner.

1-5 Holland Avenue

BCP Site No. C360115

BCP Application to Amend and Amendment



NEW YORK STATE
DEPARTMENT OF ENVIRONMENTAL CONSERVATION



BROWNFIELD CLEANUP PROGRAM (BCP)
APPLICATION TO AMEND AND AMENDMENT

PART I. BROWNFIELD CLEANUP AMENDMENT APPLICATION

Check the appropriate box below based on the nature of the amendment modification requested:

Amendment to [check one or more boxes below]

- Add
- Substitute
- Remove
- Change in Name

an applicant(s) to the existing Brownfield Cleanup Agreement [Complete Section I-IV below and Part II]

Does this proposed amendment involve a transfer of title to all or part of the brownfield site? Yes No

If yes, pursuant to 6 NYCRR Part 375-1.11(d), please also submit a Change of Use form.

See <http://www.dec.ny.gov/chemical/76250.html>

Already submitted

Amendment to modify description of the property(ies) listed in the existing Brownfield Cleanup Agreement [Complete Sections I and V below and Part II]

Amendment to Expand or Reduce property boundaries of the property(ies) listed in the existing Brownfield Cleanup Agreement [Complete Section I and V below and Part II]

Other (explain in detail below)

Please provide a brief narrative on the nature of the amendment:

- ① Amendment to add new property owner (1 Holland LLC) as a Volunteer under the BCA
- ② Amendment to correct listed acreage of property from 0.65 to 0.7221 acres.
Note: No change in property boundary or TBL information, merely corrects misstatement of acreage.

Please refer to the attached instructions for guidance on filling out this application

04/2014

Section I. Existing Application Information			
BCP SITE NAME: 1-5 Holland Avenue		BCP SITE NUMBER: C360115	
NAME OF CURRENT APPLICANT(S): One Holland Avenue Development, LLC			
INDEX NUMBER OF EXISTING AGREEMENT: C360115-11-10		DATE OF EXISTING AGREEMENT: December 1, 2010	
Section II. New Requestor Information (if no change to Current Applicant, skip to Section V)			
NAME: 1 Holland LLC			
ADDRESS: 1 Holland Avenue			
CITY/TOWN: White Plains		ZIP CODE: 10603	
PHONE: 914-879-6962	FAX: N/A	E-MAIL: tatonito@yahoo.com	
Is the requestor authorized to conduct business in New York State (NYS)? <input checked="" type="checkbox"/> Yes <input type="checkbox"/> No			
-If the requestor is a Corporation, LLC, LLP or other entity requiring authorization from the NYS Department of State to conduct business in NYS, the requestor's name must appear, exactly as given above, in the NYS Department of State's (DOS) Corporation & Business Entity Database. A print-out of entity information from the DOS database must be submitted to DEC with the application, to document that the applicant is authorized to do business in NYS.			
NAME OF NEW REQUESTOR'S REPRESENTATIVE: Thomas Attonito			
ADDRESS: 1 Holland Avenue			
CITY/TOWN: White Plains		ZIP CODE: 10603	
PHONE: 914-879-6962	FAX: N/A	E-MAIL: tatonito@yahoo.com	
NAME OF NEW REQUESTOR'S CONSULTANT (if applicable): N/A			
ADDRESS:			
CITY/TOWN:		ZIP CODE:	
PHONE:	FAX:	E-MAIL:	
NAME OF NEW REQUESTOR'S ATTORNEY (if applicable): Denise Forte, Trivella & Forte LLP			
ADDRESS: 1311 Mamaroneck Ave, Suite 170			
CITY/TOWN: White Plains		ZIP CODE: 10605	
PHONE: 914-949-9075	FAX: 914-949-4759	E-MAIL: denise@tfsllp.com	
THE NEW REQUESTOR MUST CERTIFY THAT IT IS EITHER A PARTICIPANT OR VOLUNTEER IN ACCORDANCE WITH ECL §27-1405 (1) BY CHECKING ONE OF THE BOXES BELOW:			
<input type="checkbox"/> PARTICIPANT A requestor who either 1) was the owner of the site at the time of the disposal of contamination or 2) is otherwise a person responsible for the contamination, unless the liability arises solely as a result of ownership, operation of, or involvement with the site subsequent to the disposal of contamination.		<input checked="" type="checkbox"/> VOLUNTEER A requestor other than a participant, including a requestor whose liability arises solely as a result of ownership, operation of or involvement with the site subsequent to the contamination.	
NOTE: By checking this box, the requestor certifies that he/she has exercised appropriate care with respect to the contamination found at the facility by taking reasonable steps to: i) stop any continuing discharge; ii) prevent any threatened future release; and iii) prevent or limit human, environmental, or natural resource exposure to any previously released contamination.			

Section II. New Requestor Information continued (if no change to Current Applicant, skip to Section V)

Requestor's Relationship to Property (check one):

Prior Owner Current Owner Potential /Future Purchaser Other _____ Yes No
 If requestor is not the site owner, requestor will have access to the property throughout the BCP project.
 (Note: proof of site access must be submitted for non-owners)

Requester must submit proof that the party signing this Application and Amendment has the authority to bind the Requester. This would be documentation from corporate organizational papers, which are updated, showing the authority to bind the corporation, or a Corporate Resolution showing the same, or an Operating Agreement or Resolution for an LLC.

Describe Requestor's Relationship to Existing Applicant:

Requester (1 Holland LLC) purchased the property located at 1-5 Holland Avenue, White Plains, NY from Participant (One Holland Avenue Development LLC) on September 30, 2013

Section III. Current Property Owner/Operator Information (only include if new owner/operator or new existing owner/operator information is provided, and highlight new information)

OWNER'S NAME (if different from requestor)	1 Holland LLC		
ADDRESS	1 Holland Avenue		
CITY/TOWN	White Plains	ZIP CODE	10603
PHONE	914-949-9075	FAX	N/A
		E-MAIL	tattonito@ychsu.com
OPERATOR'S NAME (if different from requestor or owner)	White Plains Self Storage		
ADDRESS	1 Holland Avenue		
CITY/TOWN	White Plains	ZIP CODE	10603
PHONE	914-949-9075	FAX	N/A
		E-MAIL	tattonito@ychsu.com

Section IV. Eligibility Information for New Requestor (Please refer to ECL § 27-1407 for more detail).

If answering "yes" to any of the following questions, please provide an explanation as an attachment.

- | | | |
|--|------------------------------|--|
| 1. Are any enforcement actions pending against the requestor regarding this site? | <input type="checkbox"/> Yes | <input checked="" type="checkbox"/> No |
| 2. Is the requestor subject to an existing order relating to contamination at the site? | <input type="checkbox"/> Yes | <input checked="" type="checkbox"/> No |
| 3. Is the requestor subject to an outstanding claim by the Spill Fund for this site? | <input type="checkbox"/> Yes | <input checked="" type="checkbox"/> No |
| 4. Has the requestor been determined to have violated any provision of ECL Article 27? | <input type="checkbox"/> Yes | <input checked="" type="checkbox"/> No |
| 5. Has the requestor previously been denied entry to the BCP? | <input type="checkbox"/> Yes | <input checked="" type="checkbox"/> No |
| 6. Has the requestor been found in a civil proceeding to have committed a negligent or intentionally tortious act involving contaminants? | <input type="checkbox"/> Yes | <input checked="" type="checkbox"/> No |
| 7. Has the requestor been convicted of a criminal offense that involves a violent felony, fraud, bribery, perjury, theft, or offense against public administration? | <input type="checkbox"/> Yes | <input checked="" type="checkbox"/> No |
| 8. Has the requestor knowingly falsified or concealed material facts or knowingly submitted or made use of a false statement in a matter before the Department? | <input type="checkbox"/> Yes | <input checked="" type="checkbox"/> No |
| 9. Is the requestor an individual or entity of the type set forth in ECL 27-1407.9(f) that committed an act or failed to act, and such act or failure to act could be the basis for denial of a BCP application? | <input type="checkbox"/> Yes | <input checked="" type="checkbox"/> No |

Section V. Property description and description of changes/additions/reductions (if applicable)

ADDRESS 1-5 Holland Avenue

CITY/TOWN White Plains ZIP CODE 10603

TAX BLOCK AND LOT (TBL) (in existing agreement)

Parcel Address	Parcel No.	Section No.	Block No.	Lot No.	Acreage
<u>1-5 Holland Avenue, White Plains</u>	<u>I/II</u>	<u>125.07</u>	<u>1</u>	<u>1</u>	<u>0.65</u>

Check appropriate boxes below:

- Changes to metes and bounds description or TBL correction
- Addition of property (may require a standard application depending on the size and nature of addition – see attached instructions)

Approximate acreage added: 0.0721 → no actual property added, just corrected acreage listed

ADDITIONAL PARCELS:

Parcel Address	Parcel No.	Section No.	Block No.	Lot No.	Acreage
<u>1-5 Holland Avenue, White Plains</u>	<u>I/II</u>	<u>125.07</u>	<u>1</u>	<u>1</u>	<u>0.7221</u>

- Reduction of property
- Approximate acreage removed: _____

PARCELS REMOVED:

Parcel Address	Parcel No.	Section No.	Block No.	Lot No.	Acreage

If requesting to modify a metes and bounds description or requesting changes to the boundaries of a site, please attach a revised metes and bounds description, survey, or acceptable site map to this application.

Note: There is no change in the property subject to the BCA. The acreage was identified as 0.65 acres from an older report, but actual surveyed acreage for property remains as 0.7221 acres for same metes/bands and some TBL descriptions.

Statement of Certification and Signatures: Existing Applicant(s) (an authorized representative of each applicant must sign)

(Individual)

I hereby affirm that I am a party to the ~~Brownfield Cleanup Agreement and/or Application~~ referenced in Section I above and that I am aware of this Application for an Amendment to that ~~Agreement and/or Application~~. My signature below constitutes the requisite approval for the amendment to the BCA Application, which will be effective upon signature by the Department.

Date: _____ Signature: _____ Print Name: _____

(Entity)

I hereby affirm that I am Vice President (title) of One Holland Avenue Development LLC (entity) which is a party to the Brownfield Cleanup Agreement and/or Application referenced in Section I above and that I am aware of this Application for an Amendment to that Agreement and/or Application. Karen Puckett's signature below constitutes the requisite approval for the amendment to the BCA Application, which will be effective upon signature by the Department.

Date: 7/28/14 Signature: Karen Puckett Print Name: Karen S. Puckett

REMAINDER OF THIS AMENDMENT WILL BE COMPLETED SOLELY BY THE DEPARTMENT

Status of Agreement:

<input type="checkbox"/> PARTICIPANT A requestor who either 1) was the owner of the site at the time of the disposal of contamination or 2) is otherwise a person responsible for the contamination, unless the liability arises solely as a result of ownership, operation of, or involvement with the site subsequent to the disposal of contamination	<input type="checkbox"/> VOLUNTEER A requestor other than a participant, including a requestor whose liability arises solely as a result of ownership, operation of or involvement with the site subsequent to the contamination.
--	---

Effective Date of the Original Agreement:

Effective Date of the Amendment:

Signature by the Department:

DATED:

AUG 15 2014

NEW YORK STATE DEPARTMENT OF ENVIRONMENTAL CONSERVATION

By:

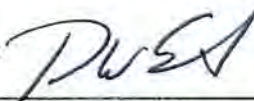

Robert W. Schiek, P.E., Director
Division of Environmental Remediation

PART II. BROWNFIELD CLEANUP PROGRAM AMENDMENT

Existing Agreement Information	
BCP SITE NAME:	1-5 Holland Avenue BCP SITE NUMBER: C360115
NAME OF CURRENT APPLICANT(S):	One Holland Avenue Development LLC
INDEX NUMBER OF EXISTING AGREEMENT:	C360115-11-10
EFFECTIVE DATE OF EXISTING AGREEMENT:	December 1, 2010

Declaration of Amendment:

By the Requestor(s) and/or Applicant(s) signatures below, and subsequent signature by the Department, the above application to amend the Brownfield Cleanup Agreement described above is hereby approved. This Amendment is made in accordance with and subject to all of the BCA and all applicable guidance, regulations and state laws applicable thereto. All other substantive and procedural terms of the Agreement will remain unchanged and in full force and effect regarding the parties to the Agreement.

Nothing contained herein constitutes a waiver by the Department or the State of New York of any rights held in accordance with the Agreement or any applicable state and/or federal law or a release for any party from any obligations held under the Agreement or those same laws.

Statement of Certification and Signatures: New Requestor(s) (if applicable)
<p>(Individual)</p> <p>I acknowledge and agree to the general terms and conditions set forth in DER-32 <i>Brownfield Cleanup Program Applications and Agreements</i>. I also agree that in the event of a conflict between the general terms and conditions of participation set forth in DER-32 and the terms contained in a site-specific BCA, the terms in the BCA shall control. I hereby affirm that information provided on this form and its attachments is true and complete to the best of my knowledge and belief. I am aware that any false statement made herein is punishable as a Class A misdemeanor pursuant to section 210.45 of the Penal Law. My signature below constitutes the requisite approval for the amendment to the BCA Application, which will be effective upon signature by the Department.</p> <p>Date: <u>7/10/2014</u> Signature: <u>[Signature]</u> Print Name: <u>Edward Sokoluk</u></p>
<p>(Entity)</p> <p style="margin-left: 40px;">A Member 1 Holland LLC</p> <p>I hereby affirm that I am (title) of (entity); that I am authorized by that entity to make this application; that this application was prepared by me or under my supervision and direction; and that information provided on this form and its attachments is true and complete to the best of my knowledge and belief. I acknowledge and agree to the general terms and conditions set forth in DER-32 <i>Brownfield Cleanup Program Applications and Agreements</i>. I also agree that in the event of a conflict between the general terms and conditions of participation set forth in DER-32 and the terms contained in a site-specific BCA, the terms in the BCA shall control. I am aware that any false statement made herein is punishable as a Class A misdemeanor pursuant to Section 210.45 of the Penal Law. <u>Edward Sokoluk</u> signature below constitutes the requisite approval for the amendment to the BCA Application, which will be effective upon signature by the Department.</p> <p>Date: <u>7/10/2014</u> Signature: <u>[Signature]</u> Print Name: <u>Edward Sokoluk</u></p>

SUBMITTAL INFORMATION:

Three (3) complete copies are required.

- Two (2) copies, one hard copy with original signatures and one electronic copy in Portable Document Format (PDF) on a CD, must be sent to:

Chief, Site Control Section
New York State Department of Environmental Conservation
Division of Environmental Remediation
625 Broadway
Albany, NY 12233-7020

- One (1) paper copy must be sent to the DEC regional contact in the regional office covering the county in which the site is located. Please check [DEC's website](#) for information on our regional offices.

FOR DEPARTMENT USE ONLY

BCP SITE T&A CODE: _____

LEAD OFFICE: _____

PROJECT MANAGER: _____

NYS Department of State

Division of Corporations

Entity Information

The information contained in this database is current through July 22, 2014.

Selected Entity Name: 1 HOLLAND LLC

Selected Entity Status Information

Current Entity Name: 1 HOLLAND LLC

DOS ID #: 4369595

Initial DOS Filing Date: MARCH 06, 2013

County: WESTCHESTER

Jurisdiction: NEW YORK

Entity Type: DOMESTIC LIMITED LIABILITY COMPANY

Current Entity Status: ACTIVE

Selected Entity Address Information

DOS Process (Address to which DOS will mail process if accepted on behalf of the entity)

1 HOLLAND LLC

1 HOLLAND AVENUE

WHITE PLAINS, NEW YORK, 10604

Registered Agent

NONE

This office does not require or maintain information regarding the names and addresses of members or managers of nonprofessional limited liability companies. Professional limited liability companies must include the name(s) and address(es) of the original members, however this information is not recorded and only available by viewing the certificate.

***Stock Information**

of Shares Type of Stock \$ Value per Share

No Information Available

*Stock information is applicable to domestic business corporations.

Name History

Filing Date	Name Type	Entity Name
MAR 06, 2013	Actual	1 HOLLAND LLC

A **Fictitious** name must be used when the **Actual** name of a foreign entity is unavailable for use in New York State. The entity must use the fictitious name when conducting its activities or business in New York State.

NOTE: New York State does not issue organizational identification numbers.

[Search Results](#) | [New Search](#)

[Services/Programs](#) | [Privacy Policy](#) | [Accessibility Policy](#) | [Disclaimer](#) | [Return to DOS](#)
[Homepage](#) | [Contact Us](#)

Excavation Work Plan

C-1 NOTIFICATION

At least 15 days prior to the start of any activity that is anticipated to encounter remaining contamination (as defined in Section 1.4.3), the site owner or their representative will notify the Department. Currently, this notification will be made to:

Kiera Thompson

Engineering Geologist

NYSDEC – Division of Environmental Remediation

625 Broadway, 11th Floor

Albany, NY 12233-7014

This notification will include:

- A detailed description of the work to be performed, including the location and areal extent, plans for site re-grading, intrusive elements or utilities to be installed below the soil cover, estimated volumes of contaminated soil to be excavated and any work that may impact an EC;
- A summary of environmental conditions anticipated in the work areas, including the nature and concentration levels of contaminants of concern, potential presence of grossly-contaminated media, and plans for any pre-construction sampling;
- A schedule for the work, detailing the start and completion of all intrusive work;
- A summary of the applicable components of this EWP;
- A statement that the work will be performed in compliance with this EWP and 29 CFR 1910.120;
- A copy of the contractor's health and safety plan, in electronic format, if it differs from the HASP provided in Appendix D of this document,
- Identification of disposal facilities for potential waste streams;
- Identification of sources of any anticipated backfill, along with all required chemical testing results.

C-2 SOIL SCREENING METHODS

Visual, olfactory, and instrument-based soil screening will be performed by a qualified environmental professional during remedial and development excavations into known or potentially contaminated material (remaining contamination). Soil screening will be performed regardless of when the invasive work is done and will include excavation and invasive work performed during development, such as excavations for foundations and utility work, after issuance of the COC.

Soils will be segregated based on previous environmental data and screening results into material that requires off-site disposal, material that requires testing, material that can be returned to the subsurface, and material that can be used as cover soil.

Materials shall be analyzed for volatile organic compounds (USEPA Test Method 8260) and metals (USEPA Test Method 6010) prior to disposal or reuse. Sampling and analysis for these purposes shall be in accordance with the Site Management Plan and associated Quality Control Document appended thereto.

C-3 STOCKPILE METHODS

NYSDEC-accepted erosion and sediment control measures will be employed to prevent environmental impacts that could be caused by stormwater runoff from stockpiles of potentially-impacted material.

Stockpiles of potentially-impacted material will be kept covered at all times with appropriately anchored tarps. Stockpiles will be routinely inspected, and damaged tarp covers will be promptly replaced.

Stockpiles of potentially-impacted material will be inspected at a minimum once each week and after every storm event. Results of inspections will be recorded in a logbook, maintained at the site, and will be available for inspection by NYSDEC. Unless otherwise approved by NYSDEC, impacted soil stockpiles shall not remain on-site for greater than 60 days from the date of excavation.

C-4 MATERIALS EXCAVATION AND LOAD OUT

A qualified environmental professional or person under their supervision will oversee invasive work and the excavation and load-out of excavated material.

The owner of the property and its contractors are solely responsible for safe execution of invasive and other work performed under this Plan.

The presence of utilities and easements on the site will be investigated by the qualified environmental professional. It will be determined whether a risk or impediment to the planned work under this SMP is posed by utilities or easements on the site.

Loaded vehicles leaving the site will be appropriately lined, tarped, securely covered, manifested, and placarded in accordance with applicable Federal, State, local, and NYSDOT requirements (and all other applicable transportation requirements).

Locations where vehicles enter or exit the site shall be inspected daily for evidence of off-site soil tracking.

The qualified environmental professional will be responsible for ensuring requiring that all egress points for truck and equipment transport from the site are clean of dirt and other materials derived from the site during intrusive excavation activities. Cleaning of the adjacent streets will be performed as needed to maintain a clean condition with respect to site-derived materials.

C-5 MATERIALS TRANSPORT OFF-SITE

Transport of materials will be performed by licensed haulers in accordance with applicable local, State, and Federal regulations, including 6 NYCRR Part 364. Haulers will be appropriately licensed and trucks properly placarded.

Material transported by trucks exiting the site will be secured with tight-fitting covers. Loose-fitting canvas-type truck covers will be prohibited. If loads contain wet material capable of producing free liquid, truck liners will be used.

All trucks will be cleaned of loose soils prior to leaving the site. If truck wash water is generated it will be collected and disposed off-site in an appropriate manner.

Trucks will be prohibited from stopping and idling in the neighborhood outside the project site.

Egress points for truck and equipment transport from the site will be kept clean of dirt and other materials during site remediation and development.

Queuing of trucks will be performed on-site in order to minimize off-site disturbance. Off-site queuing will be prohibited.

C-6 MATERIALS DISPOSAL OFF-SITE

Soil/fill/solid waste excavated and removed from the site will be assumed contaminated and regulated material and will be transported and disposed in accordance with applicable local, State (including 6NYCRR Part 360) and Federal regulations, until chemical analysis demonstrated otherwise. If disposal of soil/fill from this site is proposed for unregulated off-site disposal (*i.e.*, clean soil removed for development purposes), a formal request with an associated plan will be made to the NYSDEC. Unregulated off-site management of materials from this site will not occur without formal NYSDEC approval.

Off-site disposal locations for excavated soils will be identified in the pre-excavation notification. This will include estimated quantities and a breakdown by class of disposal facility if appropriate (*i.e.*, hazardous waste disposal facility, solid waste landfill, petroleum treatment facility, C/D recycling facility, *etc.*). Actual disposal quantities and associated documentation will be reported to the NYSDEC in the Periodic Review Report (if preparation of this report becomes necessary at a later date). This documentation will include: waste profiles, test results, facility acceptance letters, manifests, bills of lading and facility receipts.

Non-hazardous historic fill and contaminated soils taken off-site will be handled, at minimum, as a Municipal Solid Waste per 6 NYCRR Part 360-1.2. Material that does not meet Track 1 unrestricted SCOs is prohibited from being taken to a New York State recycling facility (6 NYCRR Part 360-16 Registration Facility).

C-7 MATERIALS REUSE ON-SITE

The qualified environmental professional will ensure that procedures defined for material reuse in the SMP and DER-10 (Section 5.4(e)4/Table 5.4(e)4 – Reuse of Soil) are followed and unacceptable material does not remain on-site. Contaminated on-site material, including historic fill and contaminated soil, that is acceptable for re-use on-site will be placed below the demarcation layer or impervious surface, and will not be reused within a cover soil layer, within landscaping berms, or as backfill for subsurface utility lines.

Demolition material proposed for reuse on-site will be sampled for asbestos and the results will be reported to the NYSDEC for acceptance. Concrete crushing or processing on-site will not be performed without prior NYSDEC approval. Organic matter (wood, roots, stumps, *etc.*) or other solid waste derived from clearing and grubbing of the site will not be reused on-site.

C-8 FLUIDS MANAGEMENT

Liquids to be removed from the site, including excavation dewatering and groundwater monitoring well purge and development waters, will be handled, transported, and disposed in accordance with applicable local, State, and Federal regulations. Dewatering, purge, and development fluids will not be recharged back to the land surface or subsurface of the site, but will be managed off-site.

Discharge of water generated during large-scale construction activities to surface waters (*i.e.* a local pond, stream, or river) will be performed in accordance with State and local law.

C-9 COVER SYSTEM RESTORATION

After the completion of soil removal and any other invasive activities the cover system will be restored in kind unless otherwise previously approved by NYSDEC. The cover system shall comprise a minimum of 12 inches of clean soil or granular stone, asphalt pavement, concrete-covered sidewalks, and concrete building foundation slabs. Where a soil cover is required it will be a minimum of one foot of soil, meeting the SCOs for cover material as set forth in 6 NYCRR Part 375- 6.7(d) for commercial use. The soil cover will be placed over a demarcation layer, with the upper six inches of the soil of sufficient quality to maintain a vegetation layer.

Redevelopment of the site that includes removal of an existing cover-type that subsequently exposes soils exceeding restricted commercial SCOs as set forth in 6 NYCRR Part 375- 6.7(d) (or the most stringent criteria should site-use be changed in accordance with the requirements of this Plan), and is not proposed to be re-covered to the minimum requirement as part of the redevelopment, shall excavate and properly dispose of the subject materials. Imported backfill shall meet the SCOs for cover material as set forth in 6 NYCRR Part 375- 6.7(d) for the site use at the time of the development, but shall meet commercial SCOs at a minimum.

C-10 BACKFILL FROM OFF-SITE SOURCES

Materials proposed for import onto the site for use as backfill in areas of remaining contamination will be approved by the qualified environmental professional and will be in compliance with provisions in this SMP prior to receipt at the site.

Material from industrial sites, spill sites, other environmental remediation sites, or potentially contaminated sites will not be imported to the site.

Imported soils will meet the backfill and cover soil quality standards established in 6NYCRR 375-6.7(d). Based on an evaluation of the land use, protection of groundwater and protection of ecological resources criteria, the resulting soil quality standards are those that meet Unrestricted Use Soil Cleanup Objectives listed in NYS Part 375. Soils that meet ‘exempt’ fill requirements under 6 NYCRR Part 360, but do not meet backfill or cover soil objectives for this site, will not be imported onto the site without prior approval by NYSDEC. Solid waste will not be imported onto the site.

Trucks entering the site with imported soils will be securely covered with tight fitting covers. Imported soils will be stockpiled separately from excavated materials and covered to prevent dust releases.

C-11 STORMWATER POLLUTION PREVENTION

If stormwater pollution prevention is required at a later date, based on development plans and/or activities, a Stormwater Pollution Prevention Plan (SWPPP) will be implemented and conform to the requirements of the NYSDEC Division of Water guidelines and NYS regulations.

C-12 CONTINGENCY PLAN

If previously unidentified contaminant sources are found during post-remedial subsurface excavations or development related construction, excavation activities will be suspended until sufficient equipment is mobilized to address the condition.

Sampling will be performed on product, sediment and surrounding soils, etc. as necessary to determine the nature of the material and proper disposal method. Chemical analysis will be performed for full a full list of analytes (TAL metals; TCL volatiles and semi-volatiles, TCL pesticides and PCBs), unless the site history and previous sampling results provide a sufficient justification to limit the list of analytes. In this case, a reduced list of analytes will be proposed to the NYSDEC for approval prior to sampling.

Identification of unknown or unexpected contaminated media identified by screening during invasive site work will be promptly communicated by phone to NYSDEC’s Project Manager. Reportable quantities of petroleum product will also be reported to the NYSDEC Spills Hotline listed in

Table 1. These findings will be also included in reporting prepared pursuant to Section 3.6 and Section 5 of the SMP.

C-13 COMMUNITY AIR MONITORING PLAN

Requirements for Community Air Monitoring are included in Appendix C of this document.

C-14 ODOR CONTROL PLAN

An Odor Control Plan is not required as of the date of this SMP; however, this will be reevaluated if future work conducted at the site has the potential to create nuisance odor concerns.

C-15 DUST CONTROL PLAN

A Dust Control Plan is not required as of the date of this SMP; however, this will be reevaluated if future work conducted at the site has the potential to create dust management concerns.

*Health and Safety Plan and
Community Air Monitoring
Plan*

WORK PLAN

**Health and Safety Plan and
Community Air Monitoring Plan
1 – 5 Holland Avenue Site
White Plans, New York**

One Holland Avenue Development

October 2014



14206 | 47376

**Health and Safety Plan and
Community Air Monitoring Plan
1-5 Holland Avenue Site
White Plains, New York**

Prepared for:

One Holland Avenue Development

TABLE OF CONTENTS

List of Tables	ii
List of Figures	ii
List of Appendices	ii
1. Introduction	1
1.1 Purpose and Requirements	1
1.2 Site Description.....	1
1.3 Scope of Work.....	1
1.4 Implementation of Health and Safety Plan	1
1.5 Project Team Organization	1
2. Hazard Analysis.....	4
2.1 General Hazards	4
2.1.1 Chemical Hazards.....	4
2.1.2 Environmental Hazards	4
2.1.3 Physical Hazards	4
2.1.4 Heat Stress	5
2.1.5 Cold Weather Exposure.....	6
2.1.6 Work Near Heavy Equipment.....	7
2.2. Task Hazards.....	8
2.2.2 Soil Boring and Groundwater Monitoring Well Installation Field Activities.....	8
2.2.3 Vapor Intrusion Sampling	9
2.2.4 Groundwater Sampling.....	9
2.2.5 River Sampling.....	10
3. Personnel Training.....	11
3.1 Site Workers.....	11
3.2 Emergency Response Personnel	11
3.3 Site-Specific Training	11
3.4 Training Certification	11
3.5 Medical Monitoring	11
3.6 Respirator Certification.....	12
3.7 Personnel Protection.....	12
3.7.1 General.....	12
3.7.2 Protective Equipment Description	13
3.8 Monitoring Requirements.....	13
3.8.1 Breathing Zone Air Monitoring.....	13
3.9. Community Air Monitoring Plan	13
3.9.1. Monitoring Requirements.....	14
3.9.2. Organic Vapors.....	14

3.9.3. Dust/Particulate.....	15
4. Work Zones and Decontamination.....	16
4.1 Site Work Zones.....	16
4.2 Decontamination.....	16
4.2.1 Decontamination of Personnel.....	16
4.2.2 Decontamination Equipment.....	17
4.2.3 Decontamination Protocol.....	17
4.2.4 Monitoring Equipment Decontamination Procedures.....	17
4.2.5 Collection and Disposition of Impacted Materials and Refuse.....	18
5. Accident Prevention and Contingency Plan.....	19
5.1. Accident Prevention.....	19
5.2 Responsibilities.....	19
5.3 Accidents and Injuries.....	20
5.3.1 Evacuation Procedures.....	20
5.4 Safe Refuge.....	20
5.5 Firefighting Procedures.....	20
5.6 Emergency Equipment.....	21
5.7 Emergency Site Communications.....	21
5.8 Security and Control.....	21

LIST OF TABLES

1. Project Personnel (in text)
2. Protective Clothing and Equipment for Levels C and D (in text)
3. Emergency Telephone Numbers (in text)

LIST OF FIGURES

1. Site Location Map
2. Directions to Hospital

LIST OF APPENDICES

- A SDS for tetrachloroethylene

1. INTRODUCTION

1.1 PURPOSE AND REQUIREMENTS

This Health and Safety Plan (HASP) is specifically intended for guiding the conduct of O'Brien & Gere activities defined in the Site Management Plan (SMP) at the 1-5 Holland Avenue Site (Site). Although this HASP can be made available to interested persons for informational purposes, O'Brien & Gere does not assume responsibility for the interpretations or activities of any persons or entities other than employees of O'Brien & Gere. Subcontractors, if utilized, will have activity specific health and safety plans that meet or exceed this HASP as it relates to their scope of services.

1.2 SITE DESCRIPTION

The Site is zoned light industrial, comprises 0.72 acres and is located at 1-5 Holland Avenue, White Plains, New York as depicted on Figures 1. The property is located in an area surrounded by buildings of mixed use. Nearby property uses are as follows:

- White Plains rural cemetery to the south;
- Harlem Line of Metro North Railroad tracks immediately to the west;
- commercial buildings immediately to the east and north; and
- commercial and residential buildings further to the north and east.

1.3 SCOPE OF WORK

Tasks that will or may be conducted at the site include:

- Removal of contaminated soils.
- Soil sampling.
- Bedrock coring.
- Monitoring well construction activities.
- Groundwater sampling and monitoring.
- Surface water sampling.
- Land surveying to locate borings and monitoring wells.
- Vapor intrusion sampling.

1.4 IMPLEMENTATION OF HEALTH AND SAFETY PLAN

The requirements and guidelines presented in this HASP are based on a review of available information and an evaluation of potential on-site hazards. This HASP incorporates by reference the applicable Occupational Safety and Health Administration (OSHA) requirements in 29 CFR Part 1910 and 29 CFR Part 1926. The protective equipment selection was made according to Subpart I of 29 CFR 1910. O'Brien & Gere personnel are required to read this HASP before beginning work on site. This HASP will be available for inspection and review by O'Brien & Gere employees while work activities are underway.

When conducting the SMP activities, O'Brien & Gere personnel will comply with this HASP. On-site O'Brien & Gere personnel will notify the O'Brien & Gere Site Safety and Health Coordinator (SSHC) of matters of health and safety. The SSHC is responsible to the Project Manager for monitoring activities, monitoring compliance with the provisions of this HASP, and for modifying this HASP to the extent necessary, if site conditions change.

1.5 PROJECT TEAM ORGANIZATION

All personnel involved in the activities at the 1-5 Holland Avenue Site implicitly have a part in implementing the HASP. Among them, the Project Officer, the Senior Technical Director, the Project Manager/Field Operations

Manager, the Corporate Associate for Safety and Health, and the SSHC, have specifically designated responsibilities. Their names and telephone numbers are listed in Table 1. Other key O'Brien & Gere project personnel, the project's organization, and other primary contacts for the project are presented in the SMP.

Key project personnel and their responsibilities with regard to the sampling activities are discussed below.

Project Officer

Douglas M. Crawford, P.E., is the Project Officer. The Project Officer is responsible for the overall administration and technical execution of the project. The Project Officer is further responsible for the acquisition and delegation of resources necessary for project completion and HASP implementation.

Senior Technical Director

Guy A. Swenson, CPG is the Senior Technical Director and reports directly to the Project Officer. The Senior Technical Director is directly responsible for the technical aspects of the project.

Project Manager

Mark A. Randazzo, CHMM, CPG, CSP is the Project Manager and reports to the Senior Technical Director and Project Officer. The Project Manager is responsible for the execution and financial control of the project.

Associate for Safety and Health

Jeffrey R. Parsons, CIH is the Corporate Manager for Safety and Health. Mr. Parsons will be responsible for implementation of this HASP. Mr. Parsons must approve procedural changes and modifications to this HASP.

Site Safety and Health Coordinator

The O'Brien & Gere Site Safety and Health Coordinator (SSHC) for SMP activities will be designated by the O'Brien & Gere Project Manager. The SSHC for O'Brien & Gere employees reports to the O'Brien & Gere Project Manager, coordinates his activities with the O'Brien & Gere Associate for Safety and Health and establishes operating standards and coordinates overall project safety and health activities for the site. The SSHC reviews project plans and revisions to plans to determine that safety and health procedures are maintained throughout the investigation. The SSHC audits the effectiveness of the HASP on a continuing basis and suggests changes, if necessary, to the Project Manager.

Specifically, the SSHC is responsible for the conducting the following actions:

- Provide a complete copy of the HASP at the site before the start of activities;
- Familiarize workers with the HASP;
- Conduct on-site health and safety training and briefing sessions;
- Document the availability, use, and maintenance of personal protective and other safety or health equipment;
- Maintain safety awareness among O'Brien & Gere employees on site and communicating safety and health matters to them;
- Review field activities for performance in a manner consistent with O'Brien & Gere policy and this HASP;
- Monitor health and safety conditions during field activities;
- Coordinate with emergency response personnel and medical support facilities;
- Notify the Project Manager of the need to initiate corrective actions in the event of an emergency, an accident, or identification of a potentially unsafe condition;
- Notify the Project Manager of an emergency, an accident, the presence of a potentially unsafe condition, a health or safety problem encountered, or an exception to this HASP;

- Recommend improvements in safety and health measures to the Project Manager; and,
- Conduct safety and health performance and system audits.

The SSHC has the authority to recommend that the Project Manager take the following actions:

1. Suspend field activities or otherwise limit exposures, if the health or safety of any O'Brien & Gere employee appears to be endangered;
2. Notify O'Brien & Gere personnel to alter work practices that the SSHC deems to not protect them; and,
3. Suspend an O'Brien & Gere employee from field activities for violating the requirements of this HASP.

Table 1. Project Personnel

Name and Title	Telephone
Douglas M. Crawford, P.E. Project Officer Syracuse, New York	(315) 956-6442
Guy A. Swenson, CPG Senior Technical Director Syracuse, New York	(315) 956-6342
Mark A. Randazzo, CPG Project Manager/Field Operations Manager Hawthorne, New York	(781) 883-6432
Jeffrey R Parsons., C.I.H., Associate for Safety and Health Syracuse, New York	(315) 956-6070 (315) 391-0639, cell
Site Safety & Health Coordinator Syracuse, New York	To be identified

2. HAZARD ANALYSIS

General site chemical, physical, and environmental hazards are summarized in Section 2.1. Specific health and safety considerations for field tasks detailed in the SMP are presented in separate subsections as outlined below. Additional field tasks such as soil borings and river sampling, which are not detailed in the SMP, are also presented in the event these tasks need to be conducted in the future.

- site reconnaissance, mobilizations, and observation (Section 2.2.1.)
- soil boring and ground water monitoring well installation field activities (Section 2.2.2.)
- vapor intrusion sampling (Section 2.2.3.)
- ground water sampling (2.2.4.)
- river sampling (Section 2.2.5).

2.1 GENERAL HAZARDS

2.1.1 Chemical Hazards

The following compounds and constituents have been identified as hazardous constituents for this site:

- tetrachloroethylene (PCE)
- metals (arsenic and copper)

Please refer to Material Safety Data Sheet (MSDS) for specific health effects associated with PCE (Appendix A).

2.1.2 Environmental Hazards

Prior to initiating activity, the site conditions will be discussed with the field personnel. Hazards will be identified and protective measures will be explained.

Environmental hazards, in addition to site contaminants, include site fauna and flora. Aggressive fauna (biological hazards), such as ticks, fleas, mosquitoes, bees, wasps, spiders and snakes may be present at the site. Poison ivy and poison oak may also be present.

Safety controls for biological hazards include:

- Be able to identify hazardous plants, insects, and snakes commonly found in the area.
- Keep isopropyl alcohol or equivalent poison ivy cleanser on site to wipe down exposed skin that may have come in contact with poison ivy.
- Persons known to be highly allergic to poison ivy should consider applying Ivy Block® to areas of exposed skin prior to entering areas where poison ivy has been identified.
- Perform a personal inspection of extremities when leaving the work area.
- Insect repellent should be utilized as follows when entering brushy/overgrown areas where ticks are known to exist:
 - » Use DEET (≥ 25%) on exposed skin (ankles/calves, hands/arms, and neck).
 - » Use permethrin repellent on clothes (pants and shirts). Apply according to container directions.

2.1.3 Physical Hazards

Physical Hazards involved with field activities are primarily associated with the site environment. Weather related hazard include wet, muddy, slick, walking surfaces and unstable soil, sunburn, lightning, rain, snow, ice, and heat and cold related illnesses. There exists a potential for incidents involving personnel struck by or struck against objects resulting in fractures, cuts, punctures, or abrasions.

Materials handling and manual site preparation may cause blisters, sore muscles, and joint and skeletal injuries; and may present eye, contusion, and laceration hazards. A common type of accident that occurs in material

handling operations is the "caught between" situation when a load is being handled and a finger or toe gets caught between two objects. Extreme care must be taken when loading and unloading material. Proper lifting technique must be employed.

The work area presents hazards of slips, trips, and falls from scattered debris and irregular walking surfaces. Working surfaces that are slippery can increase the likelihood of back injuries and overexertion injuries. Walking and working surfaces during activities may involve slip, trip, and fall hazards. All personnel should frequently inspect working surfaces and keep working surfaces clear of debris and moisture.

Refer to Section 2.1.6 for information related to working near heavy equipment, including drilling rigs.

2.1.4 Heat Stress

General

The use of protective equipment, if required, may create heat stress. Monitoring of personnel wearing personal protective clothing should commence when the ambient temperature is 70° F or above. Monitoring frequency should increase as ambient temperature increases or as slow recovery rates are observed. A person who is trained to recognize heat stress symptoms should perform heat stress monitoring.

Monitoring

For monitoring the body's recuperative abilities, one or more of the following techniques will be used. Other methods for heat stress monitoring, such as the wet bulb globe temperature (WBGT) Index from the American Conference of Governmental Industrial Hygienists (ACGIH) TLV Booklet can be used. To monitor the worker, measure:

Heart Rate: Count the radial pulse during a 30-second period as early as possible in the rest period.

- If the heart rate exceeds 110 beats per minute at the beginning of the rest period, shorten the next work cycle by one-third and keep the rest period the same.
- If the heart rate still exceeds 110 beats per minute at the beginning of the next rest period, shorten the following work cycle by one third.

Oral temperature: Use a clinical thermometer or similar device for three minutes under the tongue to measure the oral temperature at the end of the work period. Measure before drinking.

- Do not permit a worker to remain in a semi-permeable or impermeable garment when the worker's oral temperature exceeds 100.6°F (38.1°C)
- If the oral temperature exceeds 99.6°F (37.6°C), shorten the next work cycle by one third without changing the rest period.
- If the oral temperature still exceeds 99.6°F (37.6°C) at the beginning of the next rest period, shorten the following work cycle by one third.

Prevention

Proper training and preventive measures will aid in averting loss of worker productivity and serious illness. Heat stress prevention is of particular importance because once a person suffers from heat stroke or heat exhaustion, that person is more susceptible to additional heat related illness. To avoid heat stress, the following steps should be taken.

- Adjust work schedules
- Mandate work slowdowns as needed
- Perform work during cooler hours of the day if possible or at night if adequate lighting can be provided.
- Provide shelter (air conditioned if possible) or shaded areas to protect personnel during rest periods.

- Maintain workers' body fluid at normal levels. This is necessary to ensure that the cardiovascular system functions adequately. Daily fluid intake must equal the amount of water lost in sweat. The normal thirst mechanism is not sensitive enough to ensure that enough water will be drunk to replace that lost in sweat. When heavy sweating occurs, require workers to increase drinking levels.
- Use the following strategy:
 - » Maintain water temperature between 50° and 60° F (10° to 16° C)
 - » Provide small individual cups that hold about four ounces of fluid
 - » Require workers to drink 4 cups (16 ounces) of fluid before beginning work.
 - » Require workers to drink two cups every 20 minutes and at each monitoring break.
 - » Require workers to drink at least 42 cups (168 ounces) of fluid per day. More fluid may be necessary to maintain body weight.
- Train workers to recognize the symptoms of heat related illness in themselves and in co-workers.

2.1.5 Cold Weather Exposure

Work/rest schedules must be altered to minimize the potential for cold stress. Cold stress is defined as a decrease in core body temperature to 96.8°F and / or cold injury to body extremities. Decreases in core body temperature are associated with reduced mental alertness, reduction in rational decision making, or loss of consciousness in severe cases. Symptoms of cold stress include pain in extremities (*i.e.*, hands and feet) and severe shivering. If workers experience these symptoms, then stop work and implement the following controls.

- Workers must don adequate dry insulating clothing.
- Adjust the work / rest schedule to increase the amount of rest / re-warming time.
- Toolbox safety meetings discussing symptoms of cold stress, clothing requirements, and work breaks must be held when the wind chill temperature drops below 0°F and EACH DAY the wind chill temperature is below 25°F.

The wind chill index provided below shows the effective cooling on exposed skin. When the wind blows across the skin, it removes the insulating layer of warm air adjacent to the skin. When all factors are the same, the faster the wind blows, the greater the heat loss, which results in a colder feeling. Wind chill temperatures that are **25°F** below zero or are extremely dangerous. Workers must protect any exposed skin, especially the face, ears, and fingers.

Temperature (Degrees F)	Wind Speed - mph							
	Calm	5	10	15	20	25	30	35
45		43	34	29	26	23	21	20
40		37	28	23	19	16	13	12
35		32	22	16	12	8	6	4
30		27	16	9	4	1	-2	-4
25		22	10	2	-3	-7	-10	-12
20		16	3	-5	-10	-15	-18	-20
15		11	-3	-11	-17	-22	-25	-27
10		6	-9	-18	-24	-29	-33	-35
5		0	-15	-25	-31	-36	-41	-43
0		-5	-22	-31	-39	-44	-49	-52
-5		-10	-27	-38	-46	-51	-59	-64
-10		-15	-34	-45	-51	-59	-64	-67
-15		-21	-40	-51	-60	-66	-71	-74

Wind Speed - mph							
Calm	5	10	15	20	25	30	35
-20	-26	-46	-58	-67	-74	-79	-82
-25	-31	-52	-65	-74	-81	-86	-89

If you would like to calculate the wind chill index for combinations of temperature and wind other than those given in the table above, you can use the formula:

$$WC = 91.4 - (0.474677 - 0.020425 * V + 0.303107 * \text{SQRT}(V)) * (91.4 - T)$$

Where: WC = wind chill index; V = wind speed (mph); T = temperature (° F)

2.1.6 Work Near Heavy Equipment

Precaution should be taken when working near heavy equipment. Heavy equipment machines include, but are not limited to, tractors, drilling rigs, front-end loaders, bulldozers, compacting rollers, and backhoes. Not included are vehicles, trucks, and tractor-trailers.

■ Machine Inspection

All vehicles in use shall be checked at the beginning of each shift to assure that the following parts, equipment, and accessories are in safe operating condition and free of apparent damage.

- 1) Seat Belts are provided on equipment (and used by operators);
- 2) Fire Extinguishers (Class A/B/C, 5 lb. or greater) must be on each machine;
- 3) Brakes - service brakes, parking/hand brake; emergency stopping brakes;
- 4) Signal Devices - lights, reflectors, horn, backup alarm. Backup alarms are required for all heavy equipment.
- 5) Tires - proper inflation, tread is acceptable,
- 6) Cabs - no broken or cracked glass
- 7) Kill switches - must be in working order

■ General Machine Safety

- 1) Inspect each machine prior to operation on each shift.
- 2) Ensure that the manufacturer's operating instructions are in each machine and that safe operating guidelines are followed.
- 3) Operators are responsible to ensure that the travel direction and work area is clear of other site personnel or obstructions. For rotating equipment with counterweights, this includes keeping the counterweight area clear.
- 4) Operators shall use seatbelts when provided by the manufacturer.
- 5) No employee shall ride on any load, in bucket, or on part of machinery not designed for personnel.
- 6) Machines shall be equipped with Rollover Protective Structures (ROPS) and Falling Object Protective Structures (FOPS), except for equipment where machines are capable of 360 degree rotation.
- 7) Ensure that the guarding is in place at all times the machine is in operation.
- 8) Before the operator leaves the machine unattended: place the parking brake on, moving elements (blades, buckets, shears, *etc.*) shall be lowered to the ground (or blocked/pinned), and release hydraulic and pneumatic pressure as specified by the manufacturer. Control lockout levers shall also be engaged.

- 9) Maintain the O'Brien & Gere required minimum safe distance to overhead powerlines of twenty (20) feet or make arrangements to de-energize powerlines prior to work if these clearances cannot be maintained. If equipment must approach closer than 20' (but NEVER closer than the OSHA minimum clearance of 10'), then a dedicated spotter will be used to ensure that the equipment does not approach closer than the OSHA minimum distance of 10' or otherwise contact the power lines.
- 10) Identify and mark all underground utilities prior to excavation or drilling work.
- 11) Operators will maintain a safe distance to rotating and moving parts. Loose hair, clothing, jewelry, etc. will be secured.
- 12) Non-essential personnel will be kept clear of rotating and moving parts, pinch points, and blind spots.

2.2. TASK HAZARDS

2.2.1 Site Reconnaissance, Mobilization and Observation

The site reconnaissance task will include identifying locations for exclusion, contamination reduction, and support zones for field efforts. Project personnel will walk the site to observe the existence of anticipated hazards and to identify safety and health issues that may have arisen since the writing of this plan.

Potential health hazards and contaminants

Surveying, site reconnaissance, and observation activities may involve a potential for exposure to physical and health hazards. Hazards may be associated with the site and the environmental conditions. The hazards of this phase of activity are associated with heavy equipment movement, manual materials handling, installation of temporary on site facilities, and manual site preparation.

Hazard and contaminant control

The initial level of protection will be Level D. Coveralls are to be worn when there is the potential for contact with contaminated soil or liquid. Dust masks (N95) will be available should activities result in dust generation. Disposable boot covers will be worn if muddy conditions exist due to the potential presence of contaminated surface soil.

2.2.2 Soil Boring and Groundwater Monitoring Well Installation Field Activities

Field operations will consist of well and soil boring installation and sampling for groundwater and sub-surface soil samples. The physical hazards of this operation are primarily associated with operation of the well driller and contact with well or soil boring contents.

Potential health hazards and contaminants

Hazards generally associated with well drilling operations include noise levels exceeding the OSHA PEL of 90 dBA that are both a hazard and a hindrance to communication, carbon monoxide from the drill rig, and overhead electrical and telephone wires which can be hazardous when the drill rig boom is in the upright position. Moving parts on the drill rig may catch clothing. Free or falling parts from the cat head may cause head injury. Moving the drill rig over uneven terrain may cause the vehicle to roll over or get stuck in a rut or mud. High pressure hydraulic lines and air lines used on drill rigs are hazardous when they are in disrepair or incorrectly assembled. There may be underground utilities in the area where drilling is being performed.

During the retrieval of augers/drilling rods, the possibility exists for splashing of exposed subsurface materials onto the workers and release of dust and volatile materials onto workers' bodies and into the workers' breathing zones.

There is the potential for arm and back strain during the purging of the wells.

There is the potential for combustible gases to be released during drilling activities. **Hazard and contaminant control**

General PPE requirements presented in Section 3.7 apply to this task. Personnel must wear hard hats and ear muffs and/or ear plugs when working near operating heavy machinery. Coveralls will be worn during drilling and when there is a need to handle or work with potentially impacted soil or liquid. Prior to approaching a drill rig, loose clothing will be secured and the boom position will be checked.

O'Brien & Gere personnel will remain upwind from the vehicle exhausts unless required by sampling work. During drilling, if wet methods are not used, air in the breathing zone of the worker will be sampled for respirable dust using a Real-time air meter (RAM) at approximately five-minute intervals. Air will be sampled for volatile organic vapors using a PID at approximately five-minute intervals. Subsequent monitoring and respirator wear will be in accordance with Chapter 3 of this HASP.

The drilling subcontractor will be required to inspect chains, lines, cables, and high-pressure lines daily for weak spots, frays, and other signs of wear. The drilling subcontractor will be required to make repairs as necessary. To avoid contact with overhead lines, the drilling subcontractor will be required to lower the drill rig boom prior to moving the rig. The drilling subcontractor will be required to verify the location of underground utilities with both the facility and the local power and utility companies prior to drilling. Overhead and underground utilities will be considered "live" until verified otherwise.

Back strain can be prevented by employing proper lifting and bailing techniques. Heavy equipment, such as pumps and generators, will only be lifted with the legs, preferably using two or three personnel.

Equipment that is potentially contaminated will be cleaned to the satisfaction of the Field Operations Manager or SSHO. The field sampling equipment will be cleaned and decontaminated using the equipment decontamination procedures outlined in the FAP. The field decontamination wastes will be collected and disposed of properly according to the FAP.

2.2.3 Vapor Intrusion Sampling

Field operations will consist of the installation of sub-slab and indoor air sampling points.

Potential health hazards and contaminants:

Potential exposure to contaminants is consistent with those identified in previous sections. Potential health hazards may include inhalation of concrete dust while installing sub-slab sample points, hearing related injuries due to noise levels while operating hammer drills, and hand injuries from pinch points when using hammer drills to penetrate sub-slabs.

Hazard and contaminant control:

Hazards and contaminant control are consistent with those in previous sections. When installing sub-slab sampling points through concrete, small amounts of water will be used to minimize the generation of concrete dust. Modified Level D PPE will be worn. In addition, hearing protection will be worn if voices need to be raised when communicating at distances of less than 5 feet. Leather work glove will also be worn while installing sub-slab sampling points.

2.2.4 Groundwater Sampling

The potential exists that field technicians may come in contact with contaminated groundwater.

Potential health hazards and contaminants:

Potential health hazards and contaminants are consistent with those identified in previous sections. Additional exposures include contact with preservatives in laboratory sample bottles during the collection of water samples.

Hazard and contaminant control:

Hazards and contaminant control are consistent with those in previous sections. Initially, Modified Level D protective equipment, to prevent contact with groundwater, sample bottle preservatives, will be provided.

Employing proper lifting and bailing techniques while developing wells and sampling wells will prevent back strain. Heavy equipment, such as pumps and generators, will only be lifted with the legs, preferably using two or three persons.

2.2.5 River Sampling

Should sampling of the Bronx River be necessary it will involve collection of water samples for field and laboratory analysis. The samples will be placed in containers and shipped to an analytical laboratory for analysis.

Potential health hazards and contaminants

The hazards associated with these types of sampling methods are generally limited to strains/sprains resulting from collecting samples, uneven walking surfaces (river embankment), and potential eye hazards resulting from water sampling activities. The areas subject to sampling along the river are less than 3 feet deep and water currents are slow thus drowning is not a significant concern. Surface water sampling will be postponed if high water conditions exist because of recent precipitation.

Hazard and contaminant control

General PPE requirements presented Section 3.7 apply to this task.

Wading is permitted in the river if water depths are three feet or less and the river velocities are low. When wading in the river, a personal floatation device must be worn. In unfamiliar areas of the river bed, a sediment probe should be used to evaluate water depth and bed conditions before wading those areas. Bed surfaces may be slippery and uneven, proceed with caution at all times. A shoreline observer will be present if sample collection requires wading in the river.

3. PERSONNEL TRAINING

3.1 SITE WORKERS

O'Brien & Gere employees performing the activities listed in the SMP must have completed a training course of at least 40 hours meeting the requirements of 29 CFR 1910.120(e) for safety and health at hazardous waste operations. If the course was completed more than 12 months before the date of site work, completion of an approved 8-hr refresher course on health and safety at hazardous waste operations is required.

O'Brien & Gere employees must comply with the O'Brien & Gere Quality Assurance Manual. The respiratory protection program is specified in Section 004.2 of Vol. 3. The Hazard Communication Program is specified in Section 003 of Vol. 3. The Audit Program is specified in Section 019 of Vol. 3.

3.2 EMERGENCY RESPONSE PERSONNEL

O'Brien & Gere employees who respond as Good Samaritans to emergency situations involving health and safety hazards must be trained in how to respond to such emergencies in accordance with the provisions of 29 CFR 1910.120(l). Skills such as cardiopulmonary resuscitation (CPR), mouth-to-mouth rescue breathing, avoidance of blood-borne pathogens, and basic first aid skills may be necessary.

3.3 SITE-SPECIFIC TRAINING

Site-specific training will be provided to each O'Brien & Gere employee and reviewed before assignment. O'Brien & Gere personnel will be briefed daily by the Field Operations or by the SSHC as to the potential hazards that may be encountered during that day. Topics will include:

- Availability of this HASP
- Tasks to be performed
- General site hazards and specific hazards in the work areas
- Selection, use, testing, and care of the body, eye, hand, foot, and respiratory protective equipment being worn and the limitations of each
- Decontamination procedures for O'Brien & Gere personnel, their personal protective equipment, and other equipment used on-site
- Emergency response procedures and requirements
- Emergency notification procedures and evacuation routes to be followed
- Time constraints (*e.g.*, rest breaks, cartridge changes)
- Hazards that may be encountered, including their effects, how to recognize symptoms or monitor them, concentration limits, or other danger signals
- Other emergency procedures.

3.4 TRAINING CERTIFICATION

A record of employee training completion will be maintained by the SSHC for each O'Brien & Gere employee who is trained. This record will include the dates of the completion of worker training, supervisor training, refresher training, emergency response training, and site-specific training for on-site O'Brien & Gere employees.

3.5 MEDICAL MONITORING

O'Brien & Gere has implemented a medical monitoring program in accordance with 29 CFR 1910.120. The O'Brien & Gere program is designed to monitor and reduce health risks to employees potentially exposed to hazardous materials and to provide baseline medical data for each employee involved in work activities. It is also designed to evaluate the employee's ability to wear PPE such as chemical-resistant clothing and respirators.

Medical examinations are administered on a post-hire and annual basis and as warranted by symptoms of exposure or of specialized activities. The post-hire examination provides baseline data. The examining physician is required to make a report to O'Brien & Gere of any medical condition that would increase the employee's risk when wearing a respirator or other PPE. O'Brien & Gere maintains site personnel medical records as required by 29 CFR 1910.120 and by 29 CFR 1910.1020, as applicable.

O'Brien & Gere employees performing the activities listed in the SMP or this document have or will receive medical tests as regulated by 29 CFR 1910.120. Where medical requirements of 29 CFR 1910.120 overlap those of 29 CFR 1910.134 or 29 CFR 1910.1025, the more stringent standard will be enforced.

3.6 RESPIRATOR CERTIFICATION

Employees who wear or may wear respiratory protection have been provided respirators as required by 29 CFR 1910.134. This standard requires that an individual's ability to wear respiratory protection be medically certified before performing designated duties.

3.7 PERSONNEL PROTECTION

3.7.1 General

Workers and authorized visitors will be provided with personal protective equipment and clothing appropriate to their work task and potential exposure. The personal protective equipment has been selected in accordance with the applicable provisions of Subpart I, 29 CFR Part 1910. Each individual will be trained in the use of this safety equipment before the start of field activities. Safety equipment and protective clothing will be used as directed by this HASP. Personal protective equipment will be worn at times designated by this HASP. Equipment and clothing will be cleaned and maintained in accordance with manufacturer's instructions and within the guidance of Subpart I, 29 CFR Part 1910 by project personnel. The SSHC will monitor the protective equipment maintenance procedures.

Results from the site walk-through and on-site monitoring will be used to set task and point specific action levels and levels of personal protection with respect to upgrading and downgrading. Each individual will be trained in the use of the protective equipment prior to the start of their on-site activities.

Personal protective equipment will be used during the investigation to minimize exposures to site-related chemical compounds and physical and biological hazards. Levels of protective clothing and equipment have been assigned to specific tasks at Level C or Level D as shown in Table 2. These personal protection levels are detailed below. If field measurements or observations indicate that an exposure is greater than the protection afforded by the equipment or procedures specified in the following sections of this HASP, work will be stopped and workers removed until the exposure has been reduced and/or the level of protection has been increased. The basic level of PPE to be used during activities is OSHA Level D. PPE may be upgraded based on air monitoring results or at the discretion of the Project Manager and based on the SSHC's recommendations. The SSHC and the Project Manager must approve a downgrade of PPE.

If the SSHC verifies that a potential exposure is greater than the protection afforded by the equipment or procedures specified in this or other sections of this HASP, the work will be stopped. O'Brien & Gere personnel will be removed from the site until the exposure has been reduced or the level of protection has been increased.

O'Brien & Gere respirator users have been trained and medically approved to use respiratory protection. Respirators issued are approved for protection against dust and organic vapors by NIOSH. Respirators are issued for the exclusive use of one worker and will be cleaned and disinfected after each use by the worker. Respirator users must check the fit of the respirator before each day's use and verify the integrity of the respirator and that it seals properly. The respirator must seal against the face so that the wearer receives air only through the air purifying cartridges attached to the respirator. No facial hair that interferes with the effectiveness of a respirator will be permitted on personnel required to wear respiratory PPE. Cartridges and filters for air-purifying respirators in use will be changed daily at a minimum.

Table 2. Protective Clothing and Equipment for Levels C & D

Task	Monitoring	Airborne Action Level*	Initial PPE Level
Site reconnaissance, mobilization and observation	VOCs	25 ppm	Level D
Soil boring and groundwater monitoring well installations	VOCs	25 ppm	Level D

Note: * Exceedance of action level will require upgrade to Level C respiratory protection or implementation of engineering controls.

3.7.2 Protective Equipment Description

The level of PPE is categorized as Level A, B, C, or D, based upon the degree of protection required. The following is a brief summary of the levels that may be used on this site.

Level C

All personnel will move upwind or upgrade the level of personal protection to Level C if the VOC concentration is consistently greater than 25 ppm. When it is necessary to upgrade to Level C, a full-face air-purifying respirator equipped with organic vapor and P 100 or N95 dust filter combination cartridges will be worn in addition to the level D Protection. All personnel will move upwind or upgrade the level of personal protection to Level C, if the VOC concentration is consistently above 25 ppm above background.

Level D

A work uniform affording minimal protection used for nuisance contamination only. Level D protection will be worn for initial entry on-site and initially for all activities. The following constitute Level D equipment:

- Overalls (cloth) or long pants.
- Gloves (nitrile or leather)
- Boots or shoes, leather, steel toe and shank
- Optional chemical resistant boot covers (neoprene or butyl rubber)
- Eye protection (goggles, face shield or safety glasses).
- Hard hat (Class B), when overhead hazard exists near drill rigs.
- Face shield when not wearing other eye protection.
- Hearing protection when heavy equipment is operating, as defined in O'Brien & Gere's Quality Assurance Manual.

3.8 MONITORING REQUIREMENTS

3.8.1 Breathing Zone Air Monitoring

A photoionization detector (PID) will be used to continuously monitor upwind background and downwind air. These devices will also be used to periodically monitor the work zone area. Breathing zone action levels presented in Table 2 above will be used to establish whether respirator protection is needed.

3.9. COMMUNITY AIR MONITORING PLAN

Action levels identified in the following sections are assumed to be above background.

3.9.1. Monitoring Requirements

The upwind and downwind perimeter of the exclusion zone at the Site will be monitored during intrusive work. A PID will monitor total organic vapors while a particulate meter will monitor particulate concentrations. The monitors will be equipped with audible and visual alarms, have recorders and display 15 minute time weighted averages. All readings will be downloaded and available for New York State Department of Health (NYSDOH) and NYSDEC personnel to review. Action levels for organic vapors and particulate emissions are outlined in the following subsections.

3.9.2. Organic Vapors

Organic vapor action levels.

Real-time air monitoring for VOCs will be performed at the work zone **perimeter** and will be done continuously during intrusive work.

When the 15-minute average VOCs level remains below 5 ppm above background, intrusive work activities may continue.

When the 15-minute average VOCs level exceeds 5 ppm above background, intrusive work activities will be suspended. Monitoring will continue under the provisions of the Vapor Emission Response Plan described below.

When the 15-minute average VOCs level exceeds 25 ppm above background, intrusive work will be stopped and the Major Vapor Emissions Plan described below will be activated. Monitoring will continue under the provisions of the Major Vapor Emission Plan described below.

Vapor emission response plan.

If the vapor levels increase above 5 ppm over background at the downwind perimeter of the exclusion zone but remain below 25 ppm above background, work can resume provided:

- The source of the vapors has been identified and corrective actions have been taken to abate the emissions. These actions must reduce the exclusion zone perimeter emissions below 5 ppm.
- The organic vapor level 200 feet downwind of the work area or half of the distance to the nearest residential or commercial structure, whichever is less, is less than 5 ppm over background. If the distance to the nearest occupied building is less than 20 feet, the monitor will be placed at the perimeter of the work area.
- Continuous monitoring continues.

Major vapor emission plan.

If organic levels greater than 5 ppm over background are identified 200 feet downwind from the work area or half of the distance to the nearest residential or commercial property, whichever is less, all work activities at the site will be halted.

If, following the cessation of the work activities, the downwind organic levels persist above 5 ppm above background, then the air quality must be monitored within 20 feet of the perimeter of the nearest residential or commercial structure (20-Foot Zone).

If efforts to abate the emission source are unsuccessful and if organic vapors persist at levels ≥ 5 ppm for more than 30 minutes or any level ≥ 10 ppm in the 20-foot Zone, then the following actions will be taken:

1. Monitoring will be conducted continuously in the "20 foot zone" until VOC levels are below 5 ppm. All intrusive site activities will be halted during this time.
2. The site owner will be notified.
3. The NYSDEC will be notified.

3.9.3. Dust/Particulate

Dust/Particulate action levels

Real-time air monitoring for particulates will be performed at the work zone **perimeter** and will be done continuously during intrusive work.

When the 15-minute average particulate level remains below 100 micrograms per cubic meter (mcg/m^3) above background, intrusive work activities may continue.

If the downwind PM-10 particulate level is $100 \text{ mcg}/\text{m}^3$ greater than background (upwind perimeter) for the 15-minute period or if airborne dust is observed leaving the work area, then dust suppression techniques must be employed.

If, after implementation of dust suppression techniques, downwind PM-10 particulate levels are greater than $150 \text{ mcg}/\text{m}^3$ above the upwind level, work must be stopped and a re-evaluation of activities initiated. Work can resume provided that dust suppression measures and other controls are successful in reducing the downwind PM-10 particulate concentration to within $150 \text{ mcg}/\text{m}^3$ of the upwind level and in preventing visible dust migration.

Particulate emission response plan

If the particulate levels increase above $100 \text{ mcg}/\text{m}^3$ over background at the downwind perimeter of the exclusion zone, but remain below $150 \text{ mcg}/\text{m}^3$ above background, work can resume provided:

- Dust suppression techniques are employed and no visible dust is migrating from the work area.

If the particulate levels increase above $150 \text{ mcg}/\text{m}^3$ over background at the downwind perimeter of the exclusion zone, work can resume provided:

- Dust suppression measures and other controls are successful in reducing the downwind PM-10 particulate concentration to within $150 \text{ mcg}/\text{m}^3$ of the upwind level and in preventing visible dust migration.

4. WORK ZONES AND DECONTAMINATION

4.1 SITE WORK ZONES

To reduce the spread of hazardous materials by workers from the contaminated areas to the clean areas, work zones will be delineated at the site. The flow of personnel between the zones shall be controlled. The establishment of the work zones will help ensure that: personnel are protected against the hazards present where they are working, that work activities and contamination are confined to the appropriate areas, and that personnel can be located and evacuated in an emergency.

An exclusion zone, a contamination reduction zone, and support zone will be established by the SSHC at the site.

Exclusion zone

The exclusion zone is where sampling/drilling activities are conducted. The SSHC will identify this zone. It must be at least 30 ft in diameter and centered, when possible, on the work activities. This zone will be designated with red flags attached to portable stakes or cones installed before beginning the fieldwork. The zone may be enlarged to contain the necessary ancillary equipment and personnel for the work to be done.

Contamination reduction zone

The contamination reduction zone (CRZ) contains personnel and equipment decontamination stations. This zone will be established between the exclusion zone and the support zone. Personnel and equipment in the exclusion zone must pass through this zone before entering the support zone. The CRZ will be located upwind from the work activities. It will only be large enough to contain equipment and personnel necessary to keep potentially impacted media and materials in the immediate work area. This area will be designated with yellow flags attached to portable stakes or cones. The CRZ will be established on the day site work commences within a particular exclusion zone, based on the direction of the wind on that day.

Support zone

The remainder of the Site is defined as the support zone. The support zone contains support facilities, extra equipment, transport vehicles, and the additional personnel and equipment necessary to manage and perform work activities. No equipment or personnel will be permitted to enter the support zone from the exclusion zone without passing through the CRZ. Eating, smoking, and drinking will be allowed only in this area.

Site communications

A cellular telephone will be used during activities to facilitate communications for emergency response and other purposes and to serve as the primary off-site communication network. Hand signals may be used between on-site personnel during heavy equipment operation.

4.2 DECONTAMINATION

4.2.1 Decontamination of Personnel

Personnel decontamination will not be necessary if Level D protection is used. However, personnel will be encouraged to remove clothing and shower as soon as is practicable at the end of the day. All clothing should be machine-washed. All personnel must wash hands and face prior to eating.

Decontamination will be necessary if Level C protection is used. Decontamination involves scrubbing with a soap and water solution followed by rinses with potable water. Dirt, oil, grease, or other foreign materials that are visible will be removed from surfaces. Scrubbing with a brush may be required to remove materials that adhere to the surfaces. Wastewaters from personnel decontamination will be disposed of with the wastewaters from the sampling equipment decontamination. Respirators will be decontaminated each day as well as sanitized before re-use. The manufacturer's instructions will be followed to sanitize the respirator masks.

A line for decontamination from Level C, providing the same level of decontamination as the example in the O'Brien & Gere Hazardous Waste Health and Safety Training Manual will be established by the Project Manager and monitored by the SSHC.

4.2.2 Decontamination Equipment

The following equipment will be available on site to decontaminate personnel and equipment.

- Plastic drop cloths
- DOT approved fiberboard drums with plastic liners, to collect non-reusable protective clothing. (unless facility dumpster is available)
- Plastic wash tubs
- Soft bristled toilet brushes
- Plastic drums or carboys, to collect wash and rinse water
- Hand spray units for decontamination
- Sufficient soap, water, alcohol wipes and towels to wash hands, faces and respirators.

4.2.3 Decontamination Protocol

As appropriate given the level of protection worn on site, the following decontamination protocol will be used:

1. Segregated equipment and drop on plastic drop clothes. Deposit equipment used on-site (tools, sampling devices and containers, monitoring instruments, radios, clipboards, *etc.*) on plastic drop cloths. During hot weather operations, a cool down station may be set up within this area.
2. Wash station for gloves, boots and protective suit will be set up. Scrub outer boots, outer gloves and splash suit with detergent water. Rinse off using copious amounts of water.
3. Removal and disposal of outer boots. Remove outer boots. Deposit them in a container with a plastic liner. If the boots are to be reused (*e.g.*, when the worker is dressed in Level C protection), after cleaning, place them in a secure on-site location, preferably in plastic.
4. Removal and disposal of outer gloves. Remove outer gloves. Deposit them in a container with a plastic liner. At this station, the worker's filter can be exchanged, new outer gloves and outer boots donned, joints taped, and the worker can return to duty.
5. Removal and disposal of outer garment. Remove outer garment. Deposit it in a container with a plastic liner.
6. Removal of respirator. Remove respirator. Avoid touching face with fingers. Deposit respirator on a plastic sheet.
7. Removal and disposal of inner gloves. Remove inner gloves. Deposit them in a container with a plastic liner.
8. Field Wash. Wash hands and face thoroughly. Shower if body contamination is suspected.

4.2.4 Monitoring Equipment Decontamination Procedures

Sampling equipment used for health monitoring purposes will be cleaned of visible contamination and debris before initial use on-site, between uses, and after final use. Monitoring equipment that contacts impacted media will be decontaminated after each use by a low-phosphate detergent brushing followed by a clean water rinse. After decontamination, monitoring equipment will be stored separately from PPE. Decontaminated or clean equipment not in use will be covered with plastic and stored in a designated storage area in the support zone.

Non-dedicated sample collecting equipment contacting samples will be decontaminated after each use by a low phosphate detergent brushing followed by a clean water rinse. A methanol rinse followed by a final rinse with analyte-free deionized or distilled water will complete the decontamination procedure. Decontaminated equipment will be allowed to air dry before wrapping in aluminum foil, shiny side out, for transport.

Monitoring equipment will be cleaned of all visible contamination prior to initial use on site, between each use, and after final use. Monitoring equipment, after decontamination, will be stored separately from personal protective equipment. Decontaminated or clean sampling equipment not in use will be covered with plastic and stored in a designated storage area in the support zone.

The surface of the equipment will be washed as follows:

1. Detergent/water rinse.
2. Tap water rinse.
3. Deionized/distilled water rinse.

4.2.5 Collection and Disposition of Impacted Materials and Refuse

Used PPE will be placed in plastic garbage bags and placed in a 55-gallon drum for off-site disposal.

Investigation derived waste (IDW) will be managed as described in the RI Work Plan. If used, commercial laundries or cleaning establishments that decontaminate protective clothing or equipment will be informed of the potentially harmful effects of exposures.

5. ACCIDENT PREVENTION AND CONTINGENCY PLAN

5.1. ACCIDENT PREVENTION

All personnel must have received health and safety training prior to the initiation of site activities. While working, personnel must be constantly alert for indicators of potentially hazardous situations and for signs and symptoms in themselves and others warning of hazardous conditions and exposures. Rapid recognition of dangerous situations can avert an emergency and an emergency response requirement.

In an emergency, site personnel will signal distress either verbally or with three blasts from a horn (vehicle horn, air horn, and so forth). The SSHC, Field Operations Manager, or the Project Manager will immediately be notified of the nature and extent of the emergency.

Table 3 contains emergency telephone numbers. This table will be kept with the portable telephone and updated as needed by the SSHC. The portable telephone will be used to notify off-site personnel of emergencies. The operating condition of this telephone will be verified daily before initiation of activities.

Location	Telephone
Fire Department	911
Police Department	911
Ambulance	911
Poison Control Center	800-942-5969
White Plains Medical Center 41 East Post Road	914-681-0600
National Spill Response Center	800-424-8802

Source: O'Brien & Gere Engineers, Inc.

Directions to White Plains Medical Center from the site are shown on Figure 2 and are as follows:

- At 1 Holland Ave go north to North Broadway (0.1 miles).
- Turn Right on North Broadway (1.2 miles).
- Continue to Route 22.
- To 41 East Post Road.

5.2 RESPONSIBILITIES

The SSHC is responsible for responding to, or coordinating the response of off-site personnel to, emergencies. In the event of an emergency, the SSHC will direct notification and response, and will assist the Field Operations Manager in arranging follow-up actions. Upon notification of an exposure incident, the SSHC will call 911 and request that hospital, fire, and police emergency response personnel as necessary recommend medical diagnosis, treatment if necessary, and provide transportation to the hospital. The Field Operations Manager will contact local, state, and federal government agencies, as appropriate.

Before the start of SMP activities at the site, the SSHC will:

1. Confirm that the following safety equipment is available: eyewash, first aid supplies, and fire extinguisher.
2. Have a working knowledge of the O'Brien & Gere safety equipment.

3. Collect and maintain a file of SDS for materials used at the site.

Before work may resume following an emergency, used emergency equipment must be recharged, refilled, or replaced and government agencies must be notified as required.

The Project Manager, assisted by the SSHC and the Field Operations Manager, must investigate the incident as soon as possible. The Project Manager will assess whether and to what extent exposure actually occurred, the cause of exposure, and the means to prevent similar incidents. The resulting report must be signed and dated by the Project Manager, SSHC, and the Field Operations Manager.

5.3 ACCIDENTS AND INJURIES

In the event of an accident or injury, workers will immediately implement emergency isolation measures to assist those who have been injured or exposed and to protect others from hazards. Upon notification of an exposure incident, the SSHC will contact emergency response personnel who can provide medical diagnosis and treatment. If necessary, personnel trained in first aid procedures will provide immediate medical care. Personnel competent in on-site medical or first aid response to an injury or illness will provide assistance in such matters. Accidents will be reported to O'Brien & Gere following the procedure in the O'Brien & Gere Quality Assurance Manual (QAM).

If the chemical is on the skin, the skin should be washed with copious amounts of water. If the chemical is on clothing, the chemical should be neutralized or clothing removed. In case of eye contact, use the emergency eyewash. Eyes should be rinsed for at least 15 minutes. All chemical exposure incidents must be reported in writing to the Manager for Safety and Health (Jeff Parsons). The SSHC or the Field Operations Manager is responsible for completing the accident report. An ambulance should be called to transport the victim to the nearest hospital or medical center. Only persons with very minor injuries should be transported by a company vehicle. Follow-up action should be taken to correct the situation that caused the accident.

5.3.1 Evacuation Procedures

In the event the site must be evacuated, the following procedures should be followed:

- The Field Operations Manager will initiate evacuation procedure by signaling to leave the site.
- All personnel in the work area will evacuate the area and meet in the designated safe refuge area.
- All personnel must be accounted for and the whereabouts of missing persons determined immediately.
- The Field Operations Manager will give further instruction.

5.4 SAFE REFUGE

Before commencing site activities, a place of refuge for O'Brien & Gere workers will be identified by the SSHC. For the purpose of this HASP, a location in the western parking lot will be selected as the place of safe refuge during a site evacuation. In case of an emergency, personnel in the exclusion zone should evacuate the work area both for their own safety and to prevent hampering rescue efforts. Following an evacuation, the SSHC will account for site personnel. If evacuation from the on-site refuge location is necessary, the project vehicles will be used to transport personnel to the place of refuge.

5.5 FIREFIGHTING PROCEDURES

A fire extinguisher meeting the requirements of 29 CFR Part 1910, Subpart L, as a minimum, will be available in the support zone during on-site activities. This is intended to control small fires. When a fire cannot be controlled with the extinguisher, the exclusion zone will be evacuated, and the fire department will be contacted immediately. The SSHC or the Field Operations Manager will decide when to contact the fire department.

5.6 EMERGENCY EQUIPMENT

The following equipment, selected based on potential site hazards, will be maintained in the support zone for safety and emergency response purposes:

- Fire extinguisher
- First aid kit
- Eye wash bottles.

5.7 EMERGENCY SITE COMMUNICATIONS

Hand and verbal signals will be used at the site for emergency communications.

5.8 SECURITY AND CONTROL

The SSHC or the Field Operations Manager will monitor work zone security and control during emergencies, accidents, and incidents. The duties of the SSHC or the Field Operations Manager include limiting access to the work zones to authorized personnel and overseeing emergency response activities.

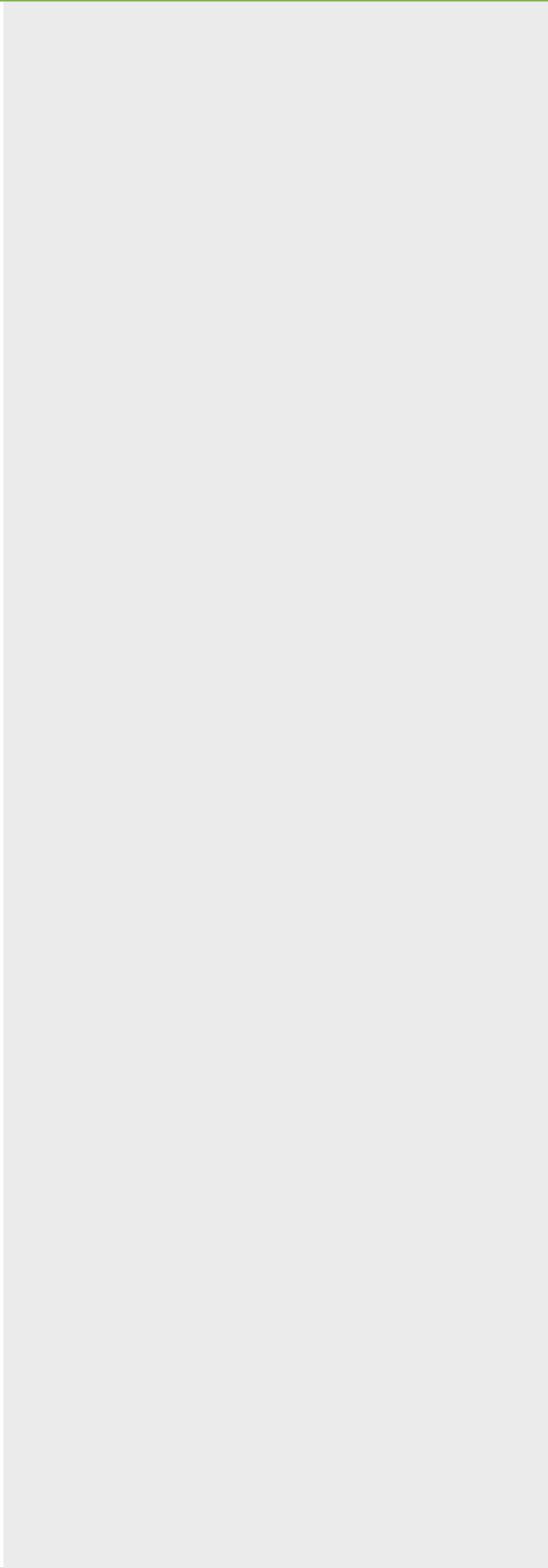



FIGURE 1



LEGEND

 SURFACE WATER

1-5 Holland Avenue
White Plains, NY

SITE LOCATION

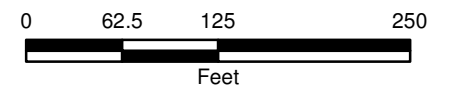

MARCH 2011
14206.46073



FIGURE 2



LEGEND

-  ROUTE TO HOSPITAL
- TOTAL DISTANCE APPROXIMATELY 2 MILES

1-5 Holland Avenue
White Plains, NY

DIRECTIONS TO HOSPITAL

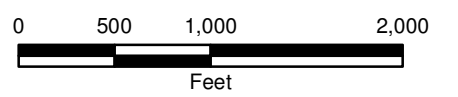

MARCH 2011
14206.46073



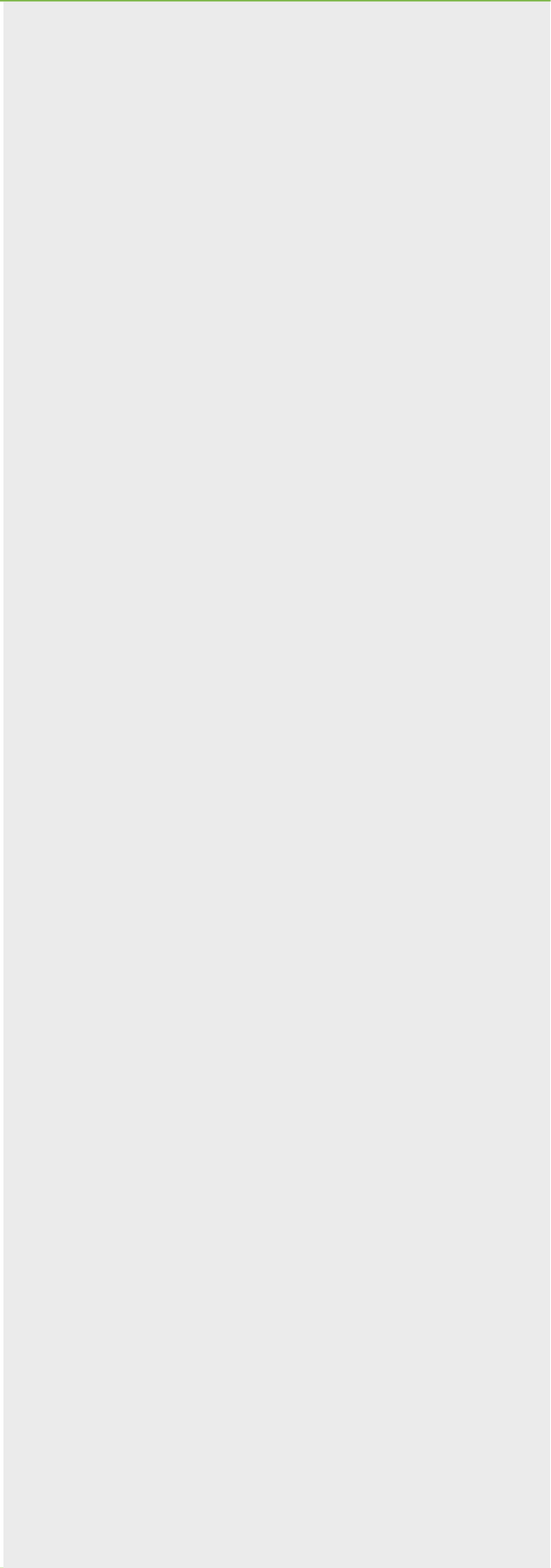

SDS for Tetrachloroethylene

MSDS: TETRACHLOROETHYLENE

SECTION 1 CHEMICAL PRODUCT AND COMPANY IDENTIFICATION

TELECHEM INTERNATIONAL, INC

524 E. WEDDELL

Sunnyvale, CA 94089

1-408-744-1331

www.arrayit.com

EMERGENCY TELEPHONE NUMBER: 1-800-424-9300 (NORTH AMERICA)

SUBSTANCE: TETRACHLOROETHYLENE

TRADE NAMES/SYNONYMS:

ETHENE, TETRACHLORO-; ETHYLENE, TETRACHLORO-; ANKILOSTIN;
DIDAKEN; NEMA;

ETHYLENE TETRACHLORIDE; PERCHLOROETHYLENE; PERC;
PERCHLOROETHENE; PERCLEN;

1,1,2,2-TETRACHLOROETHYLENE; TETRACAP; TETRACHLOROETHENE; PCE;
RCRA U210;

NCI-C04580; ENT 1,860; STCC 4940355; UN 1897; C2CL4; OHS22900; RTECS
KX3850000

CHEMICAL FAMILY: halogenated, aliphatic

CREATION DATE: Oct 25 1984

REVISION DATE: Dec 01 2000

SECTION 2 COMPOSITION, INFORMATION ON INGREDIENTS

COMPONENT: TETRACHLOROETHYLENE

CAS NUMBER: 127-18-4

EC NUMBER (EINECS): 204-825-9

EC INDEX NUMBER: 602-028-00-4

PERCENTAGE: 100.0

SECTION 3 HAZARDS IDENTIFICATION

NFPA RATINGS (SCALE 0-4): HEALTH=2 FIRE=0 REACTIVITY=0

EC CLASSIFICATION (ASSIGNED):

N Dangerous for the Environment

Carcinogen Category 3

R 40-51/53

EC Classification may be inconsistent with independently-researched data.

EMERGENCY OVERVIEW:

COLOR: colorless

PHYSICAL FORM: volatile liquid

ODOR: sweet odor

MAJOR HEALTH HAZARDS: respiratory tract irritation, skin irritation, eye irritation, central nervous system depression, cancer hazard (in humans)

POTENTIAL HEALTH EFFECTS:

INHALATION:

SHORT TERM EXPOSURE: irritation, metallic taste, ringing in the ears, nausea, vomiting, chest pain, difficulty breathing, irregular heartbeat, headache, drowsiness, symptoms of drunkenness, blurred vision, lung congestion

LONG TERM EXPOSURE: asthma, menstrual disorders, reproductive effects, cancer

SKIN CONTACT:

SHORT TERM EXPOSURE: irritation (possibly severe), symptoms of drunkenness

LONG TERM EXPOSURE: same as effects reported in short term exposure

EYE CONTACT:

SHORT TERM EXPOSURE: irritation, tearing

LONG TERM EXPOSURE: same as effects reported in short term exposure

INGESTION:

SHORT TERM EXPOSURE: vomiting, digestive disorders, headache, symptoms of drunkenness

LONG TERM EXPOSURE: kidney damage, liver damage, cancer

CARCINOGEN STATUS:

OSHA: N

NTP: Y

IARC: Y

SECTION 4 FIRST AID MEASURES

INHALATION: If adverse effects occur, remove to uncontaminated area. Give artificial respiration if not breathing. If breathing is difficult, oxygen should be administered by qualified personnel. Get immediate medical attention.

SKIN CONTACT: Wash skin with soap and water for at least 15 minutes while removing contaminated clothing and shoes. Get medical attention, if needed.

Thoroughly clean and dry contaminated clothing and shoes before reuse.

EYE CONTACT: Flush eyes with plenty of water for at least 15 minutes. Then get immediate medical attention.

INGESTION: Contact local poison control center or physician immediately. Never make an unconscious person vomit or drink fluids. When vomiting occurs, keep head lower than hips to help prevent aspiration. If person is unconscious, turn head to side. Get medical attention immediately.

NOTE TO PHYSICIAN: For inhalation, consider oxygen. For ingestion, consider gastric lavage and catharsis.

SECTION 5 FIRE FIGHTING MEASURES

FIRE AND EXPLOSION HAZARDS: Negligible fire hazard.

EXTINGUISHING MEDIA: carbon dioxide, regular dry chemical

Large fires: Use regular foam or flood with fine water spray.

FIRE FIGHTING: Cool containers with water spray until well after the fire is out. Stay away from the ends of tanks. For tank, rail car or tank truck, evacuation radius: 800 meters (1/2 mile).

FLASH POINT: No data available.

SECTION 6 ACCIDENTAL RELEASE MEASURES

AIR RELEASE:

Reduce vapors with water spray. Collect runoff for disposal as potential hazardous waste.

SOIL RELEASE:

Trap spilled material at bottom in deep water pockets, excavated holding areas or within sand bag barriers. Dike for later disposal. Absorb with sand or other non-combustible material.

WATER RELEASE:

Absorb with activated carbon. Remove trapped material with suction hoses. Subject to California Safe Drinking Water and Toxic Enforcement Act of 1986 (Proposition 65). Keep out of water supplies and sewers.

OCCUPATIONAL RELEASE:

Avoid heat, flames, sparks and other sources of ignition. Stop leak if possible without personal risk. Small liquid spills: Absorb with sand or other non-combustible material. Large spills: Dike for later disposal. Remove

sources of ignition. Keep unnecessary people away, isolate hazard area and deny entry. Notify Local Emergency Planning Committee and State Emergency Response Commission for release greater than or equal to RQ (U.S. SARA Section 304). If release occurs in the U.S. and is reportable under CERCLA Section 103, notify the National Response Center at (800)424-8802 (USA) or (202)426-2675 (USA).

SECTION 7 HANDLING AND STORAGE

Store and handle in accordance with all current regulations and standards.

Store in a cool, dry place. Store in a well-ventilated area. Avoid heat, flames, sparks and other sources of ignition. Keep separated from incompatible substances.

SECTION 8 EXPOSURE CONTROLS, PERSONAL PROTECTION

EXPOSURE LIMITS:

TETRACHLOROETHYLENE:

TETRACHLOROETHYLENE (PERCHLOROETHYLENE):

100 ppm OSHA TWA

200 ppm OSHA ceiling

300 ppm OSHA peak 5 minute(s)/3 hour(s)

25 ppm (170 mg/m³) OSHA TWA (vacated by 58 FR 35338, June 30, 1993)

25 ppm ACGIH TWA

100 ppm ACGIH STEL

50 ppm (345 mg/m³) UK OES TWA

100 ppm (689 mg/m³) UK OES STEL

MEASUREMENT METHOD: Charcoal tube; Carbon disulfide; Gas chromatography with flame ionization detection; NIOSH IV # 1003, Halogenated Hydrocarbons

VENTILATION: Provide local exhaust or process enclosure ventilation system.

Ensure compliance with applicable exposure limits.

EYE PROTECTION: Wear splash resistant safety goggles. Provide an emergency eye wash fountain and quick drench shower in the immediate work area.

CLOTHING: Wear appropriate chemical resistant clothing.

GLOVES: Wear appropriate chemical resistant gloves.

RESPIRATOR: The following respirators and maximum use concentrations are drawn from NIOSH and/or OSHA.

At any detectable concentration -

Any self-contained breathing apparatus that has a full facepiece and is operated in a pressure-demand or other positive-pressure mode.

Any supplied-air respirator with full facepiece and operated in a pressure-demand or other positive-pressure mode in combination with a separate escape supply.

Escape -

Any air-purifying respirator with a full facepiece and an organic vapor canister.

Any appropriate escape-type, self-contained breathing apparatus.

For Unknown Concentrations or Immediately Dangerous to Life or Health -

Any supplied-air respirator with full facepiece and operated in a pressure-demand or other positive-pressure mode in combination with a separate escape supply.

Any self-contained breathing apparatus with a full facepiece.

SECTION 9 PHYSICAL AND CHEMICAL PROPERTIES

PHYSICAL STATE: liquid

APPEARANCE: clear

COLOR: colorless

PHYSICAL FORM: volatile liquid

ODOR: sweet odor

MOLECULAR WEIGHT: 165.83

MOLECULAR FORMULA: ClC(Cl)CCl

BOILING POINT: 250 F (121 C)

FREEZING POINT: -2 F (-19 C)

VAPOR PRESSURE: 14 mmHg @ 20 C

VAPOR DENSITY (air=1): 5.83

SPECIFIC GRAVITY (water=1): 1.6227

WATER SOLUBILITY: 0.015%

PH: Not available

VOLATILITY: 100%

ODOR THRESHOLD: 50 ppm

EVAPORATION RATE: 2.8 (butyl acetate=1)

COEFFICIENT OF WATER/OIL DISTRIBUTION: Not available

SOLVENT SOLUBILITY:

Soluble: alcohol, ether, benzene, chloroform, oils, hexane

SECTION 10 STABILITY AND REACTIVITY

REACTIVITY: Stable at normal temperatures and pressure.

CONDITIONS TO AVOID: Avoid heat, flames, sparks and other sources of ignition.

Containers may rupture or explode if exposed to heat.

INCOMPATIBILITIES: acids, metals, bases, oxidizing materials, combustible materials

TETRACHLOROETHYLENE (PERCHLOROETHYLENE):

ACIDS (STRONG): Incompatible.

ALUMINUM: May form explosive mixture.

BARIUM: Forms a detonable mixture.

BASES: May form explosive mixture.

BERYLLIUM: Possible explosive mixture.

DINITROGEN TETRAOXIDE: Explosive when subjected to extreme shock.

METALS (LIGHT): Violent reaction.

OXIDIZERS: Incompatible.

OXYGEN (LIQUID): Incompatible.

PLASTICS, RUBBER, AND COATINGS: May be attacked.

POTASSIUM HYDROXIDE: May form explosive mixture.

SODIUM HYDROXIDE: May form explosive mixture.

HAZARDOUS DECOMPOSITION:

Thermal decomposition products: phosgene, halogenated compounds, oxides of carbon

POLYMERIZATION: Will not polymerize.

SECTION 11 TOXICOLOGICAL INFORMATION

TETRACHLOROETHYLENE:

IRRITATION DATA:

810 mg/24 hour(s) skin-rabbit severe; 500 mg/24 hour(s) skin-rabbit mild;

162 mg eyes-rabbit mild; 500 mg/24 hour(s) eyes-rabbit mild

TOXICITY DATA:

>10000 mg/kg skin-rabbit LD50 (Dow); 96 ppm/7 hour(s) inhalation-human TCLo;

545 mg/kg oral-child TDLo; 600 ppm/10 minute(s) inhalation-man TCLo; 2629

mg/kg oral-rat LD50; 34200 mg/m³/8 hour(s) inhalation-rat LC50; 4678 mg/kg

intraperitoneal-rat LD50; 450 mg/kg intratracheal-rat LDLo; 8100 mg/kg

oral-mouse LD50; 5200 ppm/4 hour(s) inhalation-mouse LC50; >500 mg/kg

intraperitoneal-mouse LD; 65 gm/kg subcutaneous-mouse LD50; 4 gm/kg oral-dog

LDLo; 2100 mg/kg intraperitoneal-dog LD50; 85 mg/kg intravenous-dog LDLo; 4

gm/kg oral-cat LDLo; 5 gm/kg oral-rabbit LDLo; >3228 mg/kg skin-rabbit LD;

2200 mg/kg subcutaneous-rabbit LDLo; 14 gm/kg/4 week(s) intermittent

oral-rat TDLo; 36 gm/kg/90 day(s) continuous oral-rat TDLo; 3 gm/kg/6

week(s) intermittent oral-rat TDLo; 1750 ppm/6 hour(s)-14 day(s)

intermittent inhalation-rat TCLo; 19300 mg/m³/24 hour(s)-94 day(s)

continuous inhalation-rat TClO; 200 ppm/4 week(s) continuous inhalation-rat TClO; 7000 ppm/8 hour(s)-50 day(s) intermittent inhalation-rat TClO; 49750 ug/kg/3 day(s) intermittent intraperitoneal-rat TDLo; 23215 mg/kg/8 week(s) intermittent oral-mouse TDLo; 200 ppm/4 hour(s)-8 week(s) intermittent inhalation-mouse TClO; 1750 ppm/6 hour(s)-14 day(s) intermittent inhalation-mouse TClO; 1600 ppm/6 hour(s)-13 week(s) intermittent inhalation-mouse TClO; 2500 ppm/7 hour(s)-39 day(s) intermittent inhalation-rabbit TClO; 200 ppm/7 hour(s)-32 week(s) intermittent inhalation-guinea pig TClO; 120 ppm/24 hour(s)-1 year(s) continuous inhalation-gerbil TClO

CARCINOGEN STATUS: NTP: Anticipated Human Carcinogen; IARC: Human Limited

Evidence, Animal Sufficient Evidence, Group 2A; ACGIH: A3 -Animal Carcinogen; EC: Category 2; TRGS 905: K 3

In mice, oral administration and inhalation produced hepatocellular carcinomas in both sexes. Exposure of rats by inhalation produced an increased incidence of mononuclear cell leukemia in both sexes.

LOCAL EFFECTS:

Irritant: inhalation, skin, eye

ACUTE TOXICITY LEVEL:

Moderately Toxic: ingestion

Slightly Toxic: inhalation

TARGET ORGANS: central nervous system

MEDICAL CONDITIONS AGGRAVATED BY EXPOSURE: eye disorders, heart or cardiovascular disorders, kidney disorders, liver disorders, nervous system disorders, skin disorders and allergies

TUMORIGENIC DATA:

200 ppm inhalation-rat TCLo/6 hour(s)-2 year(s) intermittent; 195 gm/kg oral-mouse TDLo/50 week(s) intermittent; 100 ppm inhalation-mouse TCLo/6 hour(s)-2 year(s) intermittent; 240 gm/kg oral-mouse TD/62 week(s) intermittent; 200 ppm inhalation-rat TC/6 hour(s)-2 year(s) intermittent; 100 ppm inhalation-mouse TC/6 hour(s)-2 year(s) intermittent

MUTAGENIC DATA:

mutation in microorganisms - Salmonella typhimurium 50 uL/plate (+S9); mutation in microorganisms - Salmonella typhimurium 200 uL/plate (-S9); unscheduled DNA synthesis - human lung 100 mg/L; morphological transformation - rat embryo 97 umol/L; cytogenetic analysis - rat inhalation 500 ppm; DNA damage - mouse intraperitoneal 4 mmol/kg; other mutation test systems - mouse oral 1 gm/kg; host-mediated assay - mouse Salmonella typhimurium 100 ppm; sperm - mouse inhalation 500 ppm; sex chromosome loss and non disjunction - hamster lung 190 umol/L

REPRODUCTIVE EFFECTS DATA:

1000 ppm inhalation-rat TCLo/24 hour(s) 14 day(s) pre pregnancy/1-22 day(s) pregnant female continuous; 1000 ppm inhalation-rat TCLo/24 hour(s) 1-22 day(s) pregnant female continuous; 900 ppm inhalation-rat TCLo/7 hour(s) 7-13 day(s) pregnant female continuous; 300 ppm inhalation-rat TCLo/7

hour(s) 6-15 day(s) pregnant female continuous; 300 ppm inhalation-mouse

TCLo/7 hour(s) 6-15 day(s) pregnant female continuous; 500 ppm

inhalation-mouse TCLo/7 hour(s) 5 day(s) male

ADDITIONAL DATA: May be excreted in breast milk. Alcohol may enhance the toxic effects. Stimulants such as epinephrine may induce ventricular fibrillation.

One study shows an increased risk of leukemia for children whose fathers had occupational exposure to chlorinated solvents after the birth of the child.

A significant excess of bladder cancer mortality and elevated digestive tract cancer mortality, as well as, excess esophageal cancer has been associated with tetrachloroethylene use in the dry-cleaning industry.

HEALTH EFFECTS:

INHALATION:

ACUTE EXPOSURE:

TETRACHLOROETHYLENE (PERCHLOROETHYLENE): Vapor concentrations from 100-400

ppm may cause irritation of the nose, throat and mucous membranes, flushed face and neck, sinus congestion, nasal discharge, headache, dizziness, lightheadedness, drowsiness, thick tongue, tightness around the mouth, slurred speech, confusion, incoordination, nausea, and reversible liver and kidney changes; 400-600 ppm may cause salivation, metallic taste, perspiration of the hands, and loss of inhibitions; 1000-2000 ppm may cause marked upper respiratory irritation, anesthesia of the lips and nose, congested eustachian tubes, aching facial muscles, inebriation,

exhilaration, mental sluggishness, lassitude, gagging, faintness, tinnitus, dyspnea upon exertion, narcosis, and liver and kidney damage. Other reported symptoms include weakness, ataxia, coughing, chest pains, rapid, weak pulse, blurred vision, irritability, anorexia, vomiting, hallucinations, distorted perceptions, acidosis, latent jaundice and abnormal liver function tests, albuminuria, hematuria, anuria, and premature ventricular beats. Massive exposures may cause pulmonary edema, unconsciousness, coma and death from anesthesia or respiratory arrest. In one fatal case, pathologic findings included central fatty necrosis and fatty infiltration of the liver and moderate cloudy swelling of the renal tubular epithelium. Epinephrine-induced cardiac arrhythmias have occurred with some hydrocarbons, but testing of tetrachloroethylene in dogs has been negative.

CHRONIC EXPOSURE:

TETRACHLOROETHYLENE (PERCHLOROETHYLENE): Workers exposed to 1-40 ppm over

7.5 years showed altered electrodiagnostic and neurological rating scores; 4 of 16 exposed to 60-450 ppm for 2-20 years had abnormal EEG's. Repeated exposure may also cause respiratory tract irritation, central nervous system depression without narcosis, confusion, headache, fatigue, dizziness, inebriation, insomnia, nausea, anorexia, abdominal pain, constipation, blurred vision, multiple premature ventricular beats, and

peripheral neuropathy with numbness in the fingers, trembling, neuritis, and memory defects. Hepatic damage may occur and be persistent. Exposure to levels around 250 ppm for 4 months has been reported to have caused hemoptysis, coughing, sweating attacks, jaundice, oliguria, hematemesis, cardiovascular failure and death. Occasional idiosyncratic reactions have been reported including pulmonary edema, bronchial asthma, dependency, and hypersensitivity. Chronic studies in rats have produced liver and kidney damage. In studies of women working in the dry cleaning industry, one study showed higher incidences of menstrual disorders, indicating an effect on the hormone system. Another study revealed an association between exposure during early pregnancy and a significantly increased incidence of spontaneous abortions. Reproductive effects have also been reported in animals. Inhalation studies indicate an increased incidence of liver carcinomas in mice and mononuclear cell leukemia in rats.

SKIN CONTACT:

ACUTE EXPOSURE:

TETRACHLOROETHYLENE (PERCHLOROETHYLENE): Brief immersion of the hands in

the liquid usually causes only mild irritation. However, the liquid on the skin for 40 minutes resulted in a progressively severe burning sensation, beginning within 5-10 minutes, and marked erythema, which subsided after 1-2 hours. Severe exposures may result in vesiculation and possibly burns. Absorption may occur but is probably not a significant route of exposure.

CHRONIC EXPOSURE:

TETRACHLOROETHYLENE (PERCHLOROETHYLENE): Repeated or prolonged skin

contact may produce dermatitis with dry, scaly, fissured skin.

EYE CONTACT:

ACUTE EXPOSURE:

TETRACHLOROETHYLENE (PERCHLOROETHYLENE): Vapor concentrations from 100-200

may cause mild irritation. Higher levels or direct contact may cause pain, lacrimation, and burning, but serious injury is unlikely. At 1500 ppm, the irritation is almost intolerable. Two studies of direct application to rabbit eyes resulted in conjunctivitis and effects on the corneal epithelium; recovery was complete in 2 days to 2 weeks.

CHRONIC EXPOSURE:

TETRACHLOROETHYLENE (PERCHLOROETHYLENE): Repeated or prolonged exposure may

cause conjunctivitis. One study has reported an increased incidence of lacrimal duct disease in exposed workers.

INGESTION:

ACUTE EXPOSURE:

TETRACHLOROETHYLENE (PERCHLOROETHYLENE): May cause severe gastrointestinal

irritation with nausea, vomiting, abdominal cramps and diarrhea, possibly with bloody stools. Narcotic effects may include headache, dizziness, exhilaration, inebriation and other effects as in acute inhalation. A dose of 500 mg/kg was ingested and survived. Dogs given lethal doses exhibited cardiac and respiratory depression; autopsy revealed fatty infiltration of the heart and liver and marked inflammation and shriveling of the small intestine.

CHRONIC EXPOSURE:

TETRACHLOROETHYLENE (PERCHLOROETHYLENE): Long-term ingestion of 50 mg/kg

produced liver and kidney damage in mice. Chronic ingestion has produced hepatocellular carcinomas in mice.

SECTION 12 ECOLOGICAL INFORMATION

ECOTOXICITY DATA:

FISH TOXICITY: 8430 ug/L 96 hour(s) LC50 (Mortality) Flagfish (*Jordanella floridae*)

INVERTEBRATE TOXICITY: 7500 ug/L 48 hour(s) EC50 (Immobilization) Water flea (*Daphnia magna*)

ALGAL TOXICITY: 509000 ug/L 96 hour(s) EC50 (Photosynthesis) Diatom
(Skeletonema costatum)

FATE AND TRANSPORT:

BIOCONCENTRATION: 49 ug/L 1-21 hour(s) BCF (Residue) Bluegill (Lepomis
macrochirus) 3.43 ug/L

SECTION 13 DISPOSAL CONSIDERATIONS

Subject to disposal regulations: U.S. EPA 40 CFR 262. Hazardous Waste
Number(s): U210. Hazardous Waste Number(s): D039. Dispose of in accordance
with U.S. EPA 40 CFR 262 for concentrations at or above the Regulatory
level. Regulatory level- 0.7 mg/L. Dispose in accordance with all applicable
regulations.

SECTION 14 TRANSPORT INFORMATION

U.S. DOT 49 CFR 172.101 SHIPPING NAME-UN NUMBER:

Tetrachloroethylene-UN1897

U.S. DOT 49 CFR 172.101 HAZARD CLASS OR DIVISION:

6.1

U.S. DOT 49 CFR 172.101 PACKING GROUP:

III

U.S. DOT 49 CFR 172.101 AND SUBPART E LABELING REQUIREMENTS:

Poison

U.S. DOT 49 CFR 172.101 PACKAGING AUTHORIZATIONS:

EXCEPTIONS: 49 CFR 173.153

NON-BULK PACKAGING: 49 CFR 173.203

BULK PACKAGING: 49 CFR 173.241

U.S. DOT 49 CFR 172.101 QUANTITY LIMITATIONS:

PASSENGER AIRCRAFT OR RAILCAR: 60 L

CARGO AIRCRAFT ONLY: 220 L

LAND TRANSPORT ADR/RID:

SUBSTANCE NAME: Tetrachloroethylene

UN NUMBER: UN1897

ADR/RID CLASS: 6.1

ITEM NUMBER: 15(c)

WARNING SIGN/LABEL: 6.1

HAZARD ID NUMBER: 60

AIR TRANSPORT IATA/ICAO:

CORRECT TECHNICAL NAME: Tetrachloroethylene

UN/ID NUMBER: UN1897

IATA/ICAO CLASS: 6.1

PACKAGING GROUP: III

LABEL: Toxic/Poison

MARITIME TRANSPORT IMDG:

CORRECT TECHNICAL NAME: Perchloroethylene

UN/ID NUMBER: UN1897

IMDG CLASS: 6.1

PACKAGING GROUP: III

EmS No.: 6.1-02

MFAG Table No.: 340

MARINE POLLUTANT: Y

SECTION 15 REGULATORY INFORMATION

U.S. REGULATIONS:

TSCA INVENTORY STATUS: Y

TSCA 12(b) EXPORT NOTIFICATION: Not listed.

CERCLA SECTION 103 (40CFR302.4): Y

TETRACHLOROETHYLENE (PERCHLOROETHYLENE): 100 LBS RQ

SARA SECTION 302 (40CFR355.30): N

SARA SECTION 304 (40CFR355.40): N

SARA SECTION 313 (40CFR372.65): Y

TETRACHLOROETHYLENE (PERCHLOROETHYLENE)

SARA HAZARD CATEGORIES, SARA SECTIONS 311/312 (40CFR370.21):

ACUTE: Y

CHRONIC: Y

FIRE: N

REACTIVE: N

SUDDEN RELEASE: N

OSHA PROCESS SAFETY (29CFR1910.119): N

STATE REGULATIONS:

California Proposition 65: Y

Known to the state of California to cause the following:

TETRACHLOROETHYLENE (PERCHLOROETHYLENE)

Cancer (Apr 01, 1988)

EUROPEAN REGULATIONS:

EC NUMBER (EINECS): 204-825-9

EC RISK AND SAFETY PHRASES:

- R 40 Possible risks of irreversible effects.
- R 51/53 Toxic to aquatic organisms, may cause long-term adverse effects in the aquatic environment.
- S 2 Keep out of reach of children.
- S 23 Do not breathe gas, fumes, vapour, or spray.
- S 36/37 Wear suitable protective clothing and gloves.
- S 61 Avoid release to the environment. Refer to special instructions/Safety data sheets.

CONCENTRATION LIMITS:

C_{>=1%} Xn R 40

GERMAN REGULATIONS:

WATER HAZARD CLASS (WGK): 3 (Official German Classification)

SECTION 16 OTHER INFORMATION

MSDS SUMMARY OF CHANGES

SECTION 8 EXPOSURE CONTROLS, PERSONAL PROTECTION

SECTION 11 TOXICOLOGICAL INFORMATION

*Monitoring Well Boring and
Construction Logs*



BORING LOG

WELL NO. **FD2-MIP-02a**

PROJECT: Brownfield Cleanup Program No. C360115
CLIENT: One Holland Avenue Development, LLC.
INSPECTOR: Nate Vogan

SHEET 1 OF 1
JOB NO. 14206.47376

DRILLING CONTRACTOR: Boart Longyear
DRILLER: Kevin Regan
PURPOSE: Remedial Investigation
DRILLING METHOD: Rotasonic
DRILL RIG TYPE: Mini Sonic 200C

GROUND ELEV.
DATUM
DATE STARTED 2/6/2012
DATE FINISHED 2/6/2012

	SAMPLE	CORE	CASING
TYPE	RS	---	---
DIA.	6"	---	---

DEPTH (ft)	Sample Type	Number	Blows/6" (N Value)	Penetration/ Recovery	MATERIAL DESCRIPTION	Graphic Log	Stratum Change	Field Testing PID (ppm)	Well Graphic	REMARKS		
2	RS-1	NA-NA-NA-NA (NA)	2.0'	2.0'	Concrete		FILL	10.2				
4	RS-2	NA-NA-NA-NA (NA)	2.0'	1.8'	Moderate yellowish brown (10YR 5/4), dry, loose; mf SAND, little mc subrounded gravel; no odor.			7.1				
6	RS-3	NA-NA-NA-NA (NA)	2.0'	0.9'	Moderate yellowish brown (10YR 5/4), dry, loose; mf SAND, little mc subrounded gravel.		SAND	9.7				
8	RS-4	NA-NA-NA-NA (NA)	2.0'	1.6'				3.8				
10	RS-5	NA-NA-NA-NA (NA)	2.0'	1.6'	Moderate yellowish brown (10YR 5/4), dry, loose; mf SAND.			0.2				
12	RS-6	NA-NA-NA-NA (NA)	2.0'	1.0'	Moderate yellowish brown (10YR 5/4), moist, medum dense; mf SAND.			0.2				
14	RS-7	NA-NA-NA-NA (NA)	2.0'	1.1'	Moderate yellowish brown (10YR 5/4), wet, medium dense; f SAND, little m sand, trace silt.			0.0				
16	RS-8	NA-NA-NA-NA (NA)	2.0'	0.8'	Moderate yellowish brown (10YR 5/4), saturated, medium dense; f SAND, little m sand, trace silt.			0.1				
18	RS-9	NA-NA-NA-NA (NA)	2.0'	1.1'	Dark yellowish brown (10YR 4/2), saturated, dense; fmc SAND with grayish orange (10YR 7/4) hard weathered stone, little mc subrounded gravel, trace silt.			TILL		0.3		
20	RS-10	NA-NA-NA-NA (NA)	2.0'	1.1'	Grayish orange (10YR 7/4), moist, dense; weathered MARBLE with fmc sand matrix, some mc subrounded gravel.					0.4		
22					Refusal at 20.0'. End of Borehole at 20.0'.							
24												
26												
28												
30												

Report Name: NEW OBG BORING LOG - NO USCS Data Template: OBG GINT STD US BC.GDT

Notes: Grout to grade. Sample 16.5-17 ft bgs and 19-19.5 ft bgs.
 I:\Feintool-NY.14206\47376\Docs\Reports\SMP\Appendix\AppD_\
 Soil Boring and Bedrock Core Logs August 26, 2014



BORING LOG

WELL NO. **FD2-MIP-04a**

PROJECT: Brownfield Cleanup Program No. C360115
CLIENT: One Holland Avenue Development, LLC.
INSPECTOR: Nate Vogan

SHEET 1 OF 1
 JOB NO. 14206.47376

DRILLING CONTRACTOR: Boart Longyear
DRILLER: Kevin Regan
PURPOSE: Remedial Investigation
DRILLING METHOD: Rotasonic
DRILL RIG TYPE: Mini Sonic 200C

GROUND ELEV.
 DATUM
 DATE STARTED 2/6/2012
 DATE FINISHED 2/6/2012

	SAMPLE	CORE	CASING
TYPE	RS	---	---
DIA.	6"	---	---

DEPTH (ft)	Sample Type	Number	Blows/6" (N Value)	Penetration/ Recovery	MATERIAL DESCRIPTION	Graphic Log	Stratum Change	Field Testing PID (ppm)	Well Graphic	REMARKS
2	RS-1	NA-NA-NA-NA (NA)	2.0'/1.4'	2.0'/1.4'	Concrete			39.2		
2					Dark yellowish brown (10YR 4/2), dry, loose; mf SAND, little c sand and crushed stone.		FILL	0.5		
4	RS-2	NA-NA-NA-NA (NA)	2.0'/0.8'	2.0'/0.8'	Moderate yellowish brow (10YR 5/4), dry, loose; fm SAND, trace mc subrounded gravel adn large 1" subrounded cobbles.					
4					Dark yellowish brown (10YR 4/2), wet, medium dense; trace fm gravel and c sand.			1.5		
6	RS-3	NA-NA-NA-NA (NA)	2.0'/1.4'	2.0'/1.4'	Pale yellowish brown (10YR 6/2), moist, loose; f SAND, some m sand.		SAND	0.1		
8	RS-4	NA-NA-NA-NA (NA)	2.0'/1.5'	2.0'/1.5'				3.2		
10	RS-5	NA-NA-NA-NA (NA)	2.0'/1.6'	2.0'/1.6'				1.2		
10					becoming more moderate yellowish brown (10YR 5/4).					
12	RS-6	NA-NA-NA-NA (NA)	2.0'/1.1'	2.0'/1.1'						
12					Dark yellowish brown (10YR 4/2), saturated, loose; mc SAND, little f subrounded gravel.		S & G	1.1		
14	RS-7	NA-NA-NA-NA (NA)	2.0'/0.6'	2.0'/0.6'				3.1		
14					Grayish orange (10YR 7/4); weathered MARBLE with fmc sand matrix; little mc subangular gravel.		TILL			
16	RS-8	NA-NA-NA-NA (NA)	2.0'/1.5'	2.0'/1.5'						
16					Refusal at 15.5'. End of Borehole at 15.5'.					
18										
20										
22										
24										
26										
28										
30										

Report Name: NEW OBG BORING LOG - NO USCS Data Template: OBG GINT STD US BC.GDT

Notes: Grout to grade. Sample 15-15.5 ft bgs.



BORING LOG

WELL NO. **FD2-SB-01**

PROJECT: Brownfield Cleanup Program No. C360115
CLIENT: One Holland Avenue Development, LLC.
INSPECTOR: Nate Vogan

SHEET 1 OF 1
JOB NO. 14206.47376

DRILLING CONTRACTOR: Boart Longyear
DRILLER: Kevin Regan
PURPOSE: Remedial Investigation
DRILLING METHOD: Rotasonic
DRILL RIG TYPE: Mini Sonic 200C

GROUND ELEV.
DATUM
DATE STARTED 2/7/2012
DATE FINISHED 2/7/2012

	SAMPLE	CORE	CASING
TYPE	RS	---	---
DIA.	6"	---	---

DEPTH (ft)	Sample Type	Number	Blows/6" (N Value)	Penetration/ Recovery	MATERIAL DESCRIPTION	Graphic Log	Stratum Change	Field Testing PID (ppm)	Well Graphic	REMARKS
2	RS-1	NA-NA-NA-NA (NA)	2.0'/1.9'	2.0'/1.9'	Concrete	[Concrete Pattern]	FILL	30.3	[Well Graphic]	
4	RS-2	NA-NA-NA-NA (NA)	2.0'/1.4'	2.0'/1.4'	Moderate yellowish brown (10YR 5/4), dry, loose; mf SAND, little c sand; trace large angular crushed stone.	[Sand Pattern]	SAND	1.3	[Well Graphic]	
6	RS-3	NA-NA-NA-NA (NA)	2.0'/1.2'	2.0'/1.2'	Pale yellowish brown (10YR 6/2), dry, loose; fm SAND, trace silt.	[Sand Pattern]		0.0	[Well Graphic]	
8	RS-4	NA-NA-NA-NA (NA)	2.0'/0.8'	2.0'/0.8'		[Sand Pattern]		0.0	[Well Graphic]	
10	RS-5	NA-NA-NA-NA (NA)	2.0'/1.2'	2.0'/1.2'	Dark yellowish brown (10YR 4/2), dry, loose; mc SAND, little f sand and large 1-3" cobbles.	[Sand & Cobbles Pattern]		SAND & COBBLES	0.0	[Well Graphic]
12	RS-6	NA-NA-NA-NA (NA)	2.0'/0.8'	2.0'/0.8'	Dark yellowish brown (10 YR 4/2), saturated, loose; mc SAND, little f sand, 1 large 6" subrounded cobble.	[Sand & Cobbles Pattern]	0.0		[Well Graphic]	
14	RS-7	NA-NA-NA-NA (NA)	2.0'/0.9'	2.0'/0.9'	no large cobbles	[Sand & Cobbles Pattern]	0.0		[Well Graphic]	
16	RS-8	NA-NA-NA-NA (NA)	2.0'/0.6'	2.0'/0.6'	Moderate yellowish brown (10YR 5/4) with grayish orange (10YR 7/4), moist, medium dense; fmc SAND, some weathered marble, little fm gravel and 1" subrounded cobbles.	[Sand & Cobbles Pattern]	0.0		[Well Graphic]	
18	RS-9	NA-NA-NA-NA (NA)	2.0'/0.6'	2.0'/0.6'	Dark yellowish brown (10YR 4/2), saturated, loose; mc SAND, some mc gravel and large 1-4" subrounded cobbles.	[Sand & Cobbles Pattern]	0.1		[Well Graphic]	
20	RS-10	NA-NA-NA-NA (NA)	2.0'/0.4'	2.0'/0.4'	Grayish orange (10YR 7/4), saturated medium dense; fmc SAND, some mc subangular gravel, little angular 1-2" cobbles.	[Sand & Cobbles Pattern]	0.0		[Well Graphic]	
22	RS-12	NA-NA-NA-NA (NA)	2.0'/1.4'	2.0'/1.4'	Crushed MARBLE.	[Marble Pattern]	INWOOD MARBLE TILL	1.1	[Well Graphic]	
22					Refusal at 22.0'. End of Borehole at 22.0'.	[Marble Pattern]				
24										
26										
28										
30										

Report Name: NEW OBG BORING LOG - NO USCS Data Template: OBG GINT STD US BC.GDT

Notes: Grout to grade. Sample 12.5-13 ft bgs, 19.5-20 ft bgs, 20.5-21 ft bgs.



BORING LOG

WELL NO. **FD2-SB-02**

PROJECT: Brownfield Cleanup Program No. C360115
CLIENT: One Holland Avenue Development, LLC.
INSPECTOR: Nate Vogan

SHEET 1 OF 1
JOB NO. 14206.47376

DRILLING CONTRACTOR: Boart Longyear
DRILLER: Kevin Regan
PURPOSE: Remedial Investigation
DRILLING METHOD: Rotasonic
DRILL RIG TYPE: Mini Sonic 200C

GROUND ELEV.
DATUM
DATE STARTED 2/7/2012
DATE FINISHED 2/7/2012

	SAMPLE	CORE	CASING
TYPE	RS	---	---
DIA.	6"	---	---

DEPTH (ft)	Sample Type	Number	Blows/6" (N Value)	Penetration/ Recovery	MATERIAL DESCRIPTION	Graphic Log	Stratum Change	Field Testing PID (ppm)	Well Graphic	REMARKS
2	RS-1	NA-NA-NA-NA (NA)	2.0'/1.2'	2.0'/1.2'	Concrete	[Concrete symbol]	FILL	0.4	[Diagonal lines symbol]	
4	RS-2	NA-NA-NA-NA (NA)	2.0'/0.8'	2.0'/0.8'	Dusky brown (5YR 2/2), dry, loose; fm SAND, little fm gravel; coal fragments. Moderate yellowish brown (10YR 5/4), dry, loose; mf SAND, trace subrounded 1" cobbles. no cobbles, some fm gravel trace subangular cobbles	[Cross-hatch symbol]		5.5	[Diagonal lines symbol]	
6	RS-3	NA-NA-NA-NA (NA)	2.0'/1.1'	2.0'/1.1'		[Cross-hatch symbol]		0.9	[Diagonal lines symbol]	
8	RS-4	NA-NA-NA-NA (NA)	2.0'/1.1'	2.0'/1.1'	Dark yellowish brown (10YR 4/2), dry, loose; fmc SAND, little fmc gravel, trace 3/4" subangular to subrounded cobbles.	[Dotted symbol]	SAND & GRAVEL	0.3	[Diagonal lines symbol]	
10	RS-5	NA-NA-NA-NA (NA)	2.0'/1.5'	2.0'/1.5'	Grayish orange (10YR 7/4) to pale yellowish orange (10YR 8/6), dry, loose; fmc SAND, little fm gravel.	[Dotted symbol]		0.1	[Diagonal lines symbol]	
12	RS-6	NA-NA-NA-NA (NA)	2.0'/1.5'	2.0'/1.5'	Pale yellowish orange (10YR 8/6) to light brown (5YR 5/6), moist, medium dense; fmc SAND matrix with fmc subrounded gravel and large 1" subrounded cobbles. Crushed marble cobble	[Dotted symbol]		0.0	[Diagonal lines symbol]	
14	RS-7	NA-NA-NA-NA (NA)	2.0'/0.8'	2.0'/0.8'	Grayish brown (5YR 3/2), moist, medium dense; fmc SAND matrix with fmc subrounded gravel and large 1" subrounded cobbles.	[Dotted symbol]		14	[Diagonal lines symbol]	
16	RS-8	NA-NA-NA-NA (NA)	2.0'/0.8'	2.0'/0.8'	Grayish brown (5YR 3/2), saturated, loose; fmc subangular to subrounded GRAVEL, some fmc sand, little clay bits. Gray pulverized rock	[Dotted symbol]	TILL	2.3	[Diagonal lines symbol]	
18	RS-9	NA-NA-NA-NA (NA)	2.0'/1.4'	2.0'/1.4'	Grayish brown (5YR 3/2), moist, medium dense; fmc subangular to subrounded GRAVEL, some fmc sand, little clay bits. Grayish brown (5YR 3/2), wet, dense; fmc SAND supporting fmc subangular to subrounded gravel and cobbles.	[Dotted symbol]		NA	[Diagonal lines symbol]	
20	RS-10	NA-NA-NA-NA (NA)	2.0'/1.1'	2.0'/1.1'	Weathered white marble pieces and little clay Pale yellowish brown (10YR 6/2) to grayish orange (10YR 7/4), wet, dense; fmc SAND matrix with weathered marble, little clay.	[Dotted symbol]		0.0	[Diagonal lines symbol]	
22	RS-11	NA-NA-NA-NA (NA)	2.0'/1.4'	2.0'/1.4'	Pulverized, white MARBLE, hard rock chips.	[Dotted symbol]	INWOOD MARBLE	NA	[Diagonal lines symbol]	
24					Refusal at 22.0'. End of Borehole at 22.0'.	[Dotted symbol]				
26										
28										
30										

Report Name: NEW OBG BORING LOG - NO USCS Data Template: OBG GINT STD US BC.GDT

Notes: Grout to grade. Sample 9-9.5 ft bgs, 17.5-18 ft bgs.



BORING LOG

WELL NO. **FD2-SB-03**

PROJECT: Brownfield Cleanup Program No. C360115
CLIENT: One Holland Avenue Development, LLC.
INSPECTOR: Nate Vogan

SHEET 1 OF 1
JOB NO. 14206.47376

DRILLING CONTRACTOR: Boart Longyear
DRILLER: Kevin Regan
PURPOSE: Remedial Investigation
DRILLING METHOD: Rotasonic
DRILL RIG TYPE: Mini Sonic 200C

GROUND ELEV.
DATUM
DATE STARTED 2/9/2012
DATE FINISHED 2/9/2012

	SAMPLE	CORE	CASING
TYPE	RS	---	---
DIA.	6"	---	---

DEPTH (ft)	Sample Type	Number	Blows/6" (N Value)	Penetration/ Recovery	MATERIAL DESCRIPTION	Graphic Log	Stratum Change	Field Testing PID (ppm)	Well Graphic	REMARKS
2	RS-1	NA-NA-NA-NA (NA)	2.0/1.0'	2.0/1.0'	Concrete	[Concrete Pattern]	FILL	15.7	[Hatched Pattern]	
4	RS-2	NA-NA-NA-NA (NA)	2.0/0.0'	2.0/0.0'	Dusky yellowish brown (10YR 4/2), dry, loose; mc SAND, some f sand, little mc subangular gravel. Becoming moderate yellowish brown (10YR 5/4), some angular crushed stone. No recovery	[Cross-hatch Pattern]		NA		
6	RS-3	NA-NA-NA-NA (NA)	2.0/2.0'	2.0/2.0'	Moderate yellowish brown (10YR 5/4), dry, loose; fm SAND.	[Dotted Pattern]	SAND	9.4	[Diagonal Pattern]	
8	RS-4	NA-NA-NA-NA (NA)	2.0/1.0'	2.0/1.0'	Moderate yellowish brown (10YR 5/4), moist, loose; fm SAND, some c sand.	[Dotted Pattern]		5.8		
10	RS-5	NA-NA-NA-NA (NA)	2.0/1.4'	2.0/1.4'	trace c sand	[Dotted Pattern]		0.0		
12	RS-6	NA-NA-NA-NA (NA)	2.0/1.1'	2.0/1.1'	Moderate yellowish brown (10YR 5/4), wet, medium dense; mf SAND, little c sand.	[Dotted Pattern]	S & G	0.6	[Diagonal Pattern]	
14	RS-7	NA-NA-NA-NA (NA)	2.0/1.1'	2.0/1.1'	Moderate yellowish brown (10YR 5/4), saturated, loose; mf SAND, little c sand.	[Dotted Pattern]		0.4		
16	RS-8	NA-NA-NA-NA (NA)	2.0/0.6'	2.0/0.6'	Moderate yellowish brown (10YR 5/4), saturated, loose; mf SAND, little c sand.	[Dotted Pattern]	TILL	0.4	[Diagonal Pattern]	
18	RS-9	NA-NA-NA-NA (NA)	2.0/1.2'	2.0/1.2'	Dark yellowish brown (10YR 4/2), wet, medium dense; mc SAND, little f sand, trace mc subrounded gravel.	[Dotted Pattern]		2.0		
20	RS-10	NA-NA-NA-NA (NA)	2.0/1.2'	2.0/1.2'	Dark yellowish brown (10YR 4/2), wet, loose; cm SAND, some fmc subrounded to subangular gravel, large 1-3" angular cobbles.	[Dotted Pattern]	INWOOD MARBLE	32.4	[Diagonal Pattern]	
22	RS-11	NA-NA-NA-NA (NA)	2.0/2.0'	2.0/2.0'	Moderate brown (5YR 3/4), wet, dense; fmc SAND, supporting fmc subangular gravel, little silt, trace clay. Grayish orange (5YR 3/4), wet dense; fmc SAND supporting large weathered marble cobbles, little silt and clay.	[Dotted Pattern]		17.1		
22					White, weathered MARBLE.	[Marble Pattern]				
24					Refusal at 22.0'. End of Borehole at 22.0'.					
26										
28										
30										

Report Name: NEW OBG BORING LOG - NO USCS Data Template: OBG GINT STD US BC.GDT

Notes: Grout to grade. Sample 5.5-6 ft bgs, 19.5-20 ft bgs.



BORING LOG

WELL NO. **FD3-MIP-02a**

PROJECT: Brownfield Cleanup Program No. C360115
CLIENT: One Holland Avenue Development, LLC.
INSPECTOR: Nate Vogan

SHEET 1 OF 1
JOB NO. 14206.47376

DRILLING CONTRACTOR: Boart Longyear
DRILLER: Kevin Regan
PURPOSE: Remedial Investigation
DRILLING METHOD: Rotasonic
DRILL RIG TYPE: Mini Sonic 200C

GROUND ELEV.
DATUM
DATE STARTED 2/8/2012
DATE FINISHED 2/8/2012

	SAMPLE	CORE	CASING
TYPE	RS	---	---
DIA.	6"	---	---

DEPTH (ft)	Sample Type	Number	Blows/6" (N Value)	Penetration/ Recovery	MATERIAL DESCRIPTION	Graphic Log	Stratum Change	Field Testing PID (ppm)	Well Graphic	REMARKS
2	RS-1	NA-NA-NA-NA (NA)	2.0'/0.0'	2.0'/0.0'	Concrete			NA		
4	RS-2	NA-NA-NA-NA (NA)	4.0'/1.0'	4.0'/1.0'	Moderate yellowish brown (10YR 5/4), dry, loose; fm SAND, some silt, little mc subangular gravel.		FILL	0.4		
6								0.0		
8	RS-3 RS-4	NA-NA-NA-NA (NA)	6.0'/1.0'	6.0'/1.0'	Pale yellowish brown (10YR 6/2), dry, loose; fm SAND, trace silt.			0.0		
10	RS-5	NA-NA-NA-NA (NA)	2.0'/1.2'	2.0'/1.2'	Moist		SAND	0.0		
12	RS-6	NA-NA-NA-NA (NA)	2.0'/1.8'	2.0'/1.8'	Moderate yellowish brown (10YR 4/2), moist, medium dense; mf SAND, trace c sand.			0.0		
14	RS-7	NA-NA-NA-NA (NA)	2.0'/1.4'	2.0'/1.4'	Pale yellowish brown (10YR 4/2), moist to wet, medium dense; fm SAND, little silt, trace large subrounded cobbles.			0.0		
16	RS-8	NA-NA-NA-NA (NA)	2.0'/1.4'	2.0'/1.4'	Moderate brown (5YR 3/4), moist, medium dense; mf SAND, some large subrounded 1-3" cobbles.		SAND & GRAVEL	0.0		
18	RS-9	NA-NA-NA-NA (NA)	2.0'/0.9'	2.0'/0.9'	Dark yellowish brown (10YR 4/2), wet, medium dense; mc SAND, some fm gravel, trace large subrounded cobbles.			0.0		
20	RS-10	NA-NA-NA-NA (NA)	2.0'/0.3'	2.0'/0.3'				0.0		
22	RS-11	NA-NA-NA-NA (NA)	2.0'/1.1'	2.0'/1.1'	Moderate brown (5YR 3/4) to grayish brown (5YR 3/2), moist, dense; fm SAND, trace c sand and large cobbles.		TILL	0.0		
24	RS-12	NA-NA-NA-NA (NA)	2.0'/2.0'	2.0'/2.0'	Pulverized white MARBLE		MARBLE	0.0		
24					Refusal at 24.0'. End of Borehole at 24.0'.		INWOOD MARBLE			
26										
28										
30										

Report Name: NEW OBG BORING LOG - NO USCS Data Template: OBG GINT STD US BC.GDT

Notes: Grout to grade, Drilled on a 55 degree angle. Sample 22-22.5 tool length (18-18.5 ft bgs)



BORING LOG

WELL NO. **FD3-MIP-04a**

PROJECT: Brownfield Cleanup Program No. C360115
CLIENT: One Holland Avenue Development, LLC.
INSPECTOR: Nate Vogan

SHEET 1 OF 2
JOB NO. 14206.47376

DRILLING CONTRACTOR: Boart Longyear
DRILLER: Kevin Regan
PURPOSE: Remedial Investigation
DRILLING METHOD: Rotasonic
DRILL RIG TYPE: Mini Sonic 200C

GROUND ELEV.
DATUM
DATE STARTED 2/8/2012
DATE FINISHED 2/9/2012

	SAMPLE	CORE	CASING
TYPE	RS	---	---
DIA.	6"	---	---

DEPTH (ft)	Sample Type	Number	Blows/6" (N Value)	Penetration/ Recovery	MATERIAL DESCRIPTION	Graphic Log	Stratum Change	Field Testing PID (ppm)	Well Graphic	REMARKS		
2	RS-1	NA-NA-NA-NA (NA)	NA	2.0'/1.9'	Broken concrete	0.7	FILL	0.0	[Diagonal Hatching]			
	RS-2	0	0	2.0'/1.5'	Dusky brown (5YR 3/2), dry, loose; mf SAND, little silt, organic odor. Moderate brown (5YR 4/4) to moderate yellowish brown (10YR 5/4), dry, loose;	0.9		5.9				
4	RS-3	0	0	2.0'/1.5'	Moderate brown (5YR 4/4), moist to dry, loose; mf SAND, little c sand.	4.0	SAND	8.9	[Dotted Pattern]			
6	RS-4	0	0	2.0'/1.6'				0.4				
8	RS-5	0	0	2.0'/1.7'				0.0				
10	RS-6	0	0	2.0'/1.4'				0.0				
12	RS-7	0	0	2.0'/1.4'	Moist Moderate yellowish brown (10YR 5/4), wet to moist, medium dense; mc SAND, some f sand.	11.2		0.0				
14	RS-8	0	0	2.0'/1.3'		12.0		0.0				
16	RS-9	0	0	2.0'/0.8'	Moderate yellowish brown (10YR 5/4), wet, medium dense; mf SAND, some c sand.	16.0		0.0				
18	RS-10	0	0	2.0'/0.7'	Saturated	18.0		0.0				
20	RS-11	0	0	2.0'/0.8'	Moderate brown (5YR 4/4), saturated, loose; c SAND, some m sand and subrounded to subangular cobbles, little fmc gravel.	20.0		SAND & GRAVEL		0.0	[Cobble Pattern]	
22	RS-12	0	0	2.0'/1.5'	some gravel, little cobbles	22.0				0.0		
24	RS-13	0	0	2.0'/0.9'			0.0					
26	RS-14	0	0	2.0'/1.6'	some cobbles	26.0	0.0					
28	RS-15	0	0	2.0'/0.3'		30.0	0.0					

Report Name: NEW OBG BORING LOG - NO USCS Data Template: OBG GINT STD US BC.GDT

Notes: Grout to grade, Drilled on a 45 degree angle, picture logged. Sample 31-31.5 tool length (22-22.5 ft bgs)



BORING LOG

WELL NO. **FD3-MIP-04a**

PROJECT: Brownfield Cleanup Program No. C360115
CLIENT: One Holland Avenue Development, LLC.
INSPECTOR: Nate Vogan

SHEET 2 OF 2
JOB NO. 14206.47376

DEPTH (ft)	Sample Type	Number	Blows/6" (N Value)	Penetration/ Recovery	MATERIAL DESCRIPTION	Graphic Log	Stratum Change	Field Testing PID (ppm)	Well Graphic	REMARKS
32		RS-16	0	2.0'/1.4'	Grayish orange (10YR 7/4), wet, dense; fmc SAND supporting angular fmc gravel and cobbles.		TILL	0.2		
					Crushed MARBLE.		INWOOD MARBLE			
34					Refusal at 32.0'. End of Borehole at 32.0'.					
36										
38										
40										
42										
44										
46										
48										
50										
52										
54										
56										
58										
60										
62										
64										
66										

Report Name: NEW OBG BORING LOG - NO USCS Data Template: OBG GINT STD US BC.GDT



BORING LOG

WELL NO. **MW-2DB**

PROJECT: Brownfield Cleanup Program No. C360115
CLIENT: One Holland Avenue Development, LLC.
INSPECTOR: Nate Vogan

SHEET 1 OF 3
JOB NO. 14206.47376
GROUND ELEV. 204.32

DRILLING CONTRACTOR: Parratt Wolff, Inc.
DRILLER: Glenn Lansing
PURPOSE: Remedial Investigation
DRILLING METHOD: Direct Push, HSA
DRILL RIG TYPE: CME 850

DATUM
DATE STARTED 4/12/2011
DATE FINISHED 4/19/2011

	SAMPLE	CORE	CASING
TYPE	SS	---	---
DIA.	2"	---	---

DEPTH (ft)	Sample Type	Number	Blows/6" (N Value)	Penetration/ Recovery	MATERIAL DESCRIPTION	Graphic Log	Stratum Change	Field Testing PID (ppm)	Well Graphic	REMARKS
2	SS-1	6-5-4 (11)	1.5/0.3'	203.8	Asphalt	0.5	FILL	1.1		
2				202.3	Dark Yellowish Brown (10YR 4/2), moist, loose, f SAND, some m sand and silt, little subrounded c grave, trace crushed brick and coarse sand.	2.0				
4	SS-2	3-5-6-9 (11)	2.0/0.2'		Moderate Yellowish Brown (10YR 5/4), moist, loose, f-m SAND, trace f subrounded gravel, quartz cobble lodged in spoon nose.			1.6		
6	SS-3	2-3-4-5 (7)	2.0/0.8'					0.1		
8	SS-4	4-4-6-5 (10)	2.0/1.4'	197.7	Pale Yellowish Brown (10YR 6/2), moist, loose, m-f SAND, trace c sand and f rounded gravel.	6.6	SAND	0.1		
10	SS-5	7-4-6-6 (10)	2.0/1.3'					0.2		
12	SS-6	1-2-4-6 (6)	2.0/1.0'					0.1		
14	SS-7	5-6-7-6 (13)	2.0/1.3'	190.3	Pale Yellowish Brown (10YR 6/2), moist, loose, m-c SAND, little f sand, trace large cobble.	14.0		1.1		
16	SS-8	2-8-8-6 (16)	2.0/1.0'	188.3	Moderate Yellowish Brown (10YR 5/4), wet, loose, c SAND, some f-m subrounded gravel, trace m sand and 1" cobbles.	16.0		0.3		
18	SS-9	8-8-8-5 (16)	2.0/0.9'	186.3	Moderate Yellowish Brown (10YR 5/4), wet, loose, m-c SAND.	18.0		0.4		
20	SS-10	4-3-3-2 (6)	2.0/0.4'					0.9		
22	SS-11	WOH-1-2-2 (3)	2.0/0.3'	182.3	Moderate Yellowish Brown (10YR 5/4), wet, medium dense, m SAND, some c sand, little f sand.	22.0	SAND & GRAVEL	0.8		
24	SS-12	3-3-5-6 (8)	2.0/1.4'					3.2		
26	SS-13	1-2-3-4 (5)	2.0/0.8'					0.7		
28	SS-14	5-8-9-6 (17)	2.0/1.0'	176.3	Moderate Yellowish Brown (10YR 5/4), wet, medium dense, m-c SAND, little f sand.	28.0		0.8		
30	SS-15	4-7-9-5 (16)	2.0/0.6'	174.3		30.0				

Report Name: NEW OBG BORING LOG - NO USCS Data Template: OBG GINT STD US BC.GDT

Notes: 0.010" Slot Screen: 68-78 ft bgs; Riser: 0.5-68 ft bgs; #0 Sand: 66-78.5 ft bgs; Bentonite seal: 63-66 ft bgs; Grout: 1-63 ft bgs; Hole bottom sand 80-93 ft bgs, benonlite 78.5-80 ft bgs.

(Continued Next Page)



BORING LOG

WELL NO. **MW-2DB**

PROJECT: Brownfield Cleanup Program No. C360115
CLIENT: One Holland Avenue Development, LLC.
INSPECTOR: Nate Vogan

SHEET 2 OF 3

JOB NO. 14206.47376

DEPTH (ft)	Sample Type	Number	Blows/6" (N Value)	Penetration/ Recovery	MATERIAL DESCRIPTION	Graphic Log	Stratum Change	Field Testing PID (ppm)	Well Graphic	REMARKS	
32	SS-16		3-9-6-7 (15)	2.0'/0.7'	Moderate Yellowish Brown (10YR 5/4), wet, medium dense, c SAND, some f-m subrounded gravel, little m sand, trace cobbles.		S & G	1.0			
34	SS-17		13-9-7-11 (16)	2.0'/0.5'				170.3			34.0
34	SS-18		50/0.1 (>50)	0.1'/0.1'	Grayish Brown (5YR 3/2), wet, dense, f SAND, little m sand matrix supporting crushed cobbles, weathered marble lodged in spoon nose.		TILL	1.5			
36					No samples, roller bit for rock socket.						
40					164.3	40.0					
42	RC-1		0	3.0'/3.4'	MARBLE; very light gray (N8), medium to coarse grained, moderately fractured, hard; vertical weathered fracture with remineralization 41.1-42.2 ft, high angle fractures (weathered) at 41.1 and 42.6 ft; horizontal fractures (weathered) at 41.6, 42.2, and 42.7 ft; healed vertical fracture 41.6-42.2 ft.		INWOOD MARBLE			Penetration rate = 3.7 min/ft; Core recovery = 3.4 ft (113%)	
44					161.3	43.0					Penetration rate = 2.4 min/ft; Core recovery = 5.1 ft (102%)
46	RC-2		0	5.0'/5.1'	MARBLE; very light gray (N8), some grayish yellow green (5GY 7/2) banding and mottling 44.0-44.9 and 47.1 ft, medium to coarse grained, moderately fractured, hard; horizontal fractures (mechanical) at 43.2, 45.2, 45.9, 46.1, 46.8 ft; high angle fractures (weathered) at 44.3 and 47.5 ft.						
48					156.3	48.0					Penetration rate = 2.2 min/ft; Core recovery = 5.0 ft (100%)
50	RC-3		0	5.0'/5.0'	MARBLE; very light gray (N8), medium to coarse grained, hard; Grayish yellow green (5GY7/2) healed fractures at 48.0-48.6 and 49.0-49.2; vertical weathered fracture 48.0-48.4; high angle weathered fracture 49.0; horizontal mechanical fractures 48.6, 50.7, 51.4; horizontal weathered fracture 52.1-53.0 (sample taken).						
54					151.3	53.0					Penetration rate = 2.4 min/ft; Core recovery = 5.0 ft (100%)
56	RC-4		0	5.0'/5.0'	MARBLE; very light gray (N8), medium to coarse grained, hard; Some grayish green (5GY 7/2) fracture mineralization 53.0-53.8; weathered high angle fractures at 53.5, 56.4, 56.7; mechanical high angle fracture 53.3; horizontal mechanical fractures at 54.5, 55.5, 55.6.						
58					146.3	58.0				Penetration rate = 3.6 min/ft; Core recovery = 5.1 ft (102%)	
60	RC-5		0	5.0'/5.1'	MARBLE; very light gray (N8), medium to coarse grained, hard; Medium gray (N5) and grayish yellow green (5GY 7/2) mottling 58.0-59.6, very hard, siliceous; wavy inclined yellowish gray (5Y 8/1) band 59.9-60.6; horizontal fractures at 58.4 (mech.), 61.9 (weath.); high angle fractures at 59.6 (mech), 60.7 (mech), 62.1 (mech).						
62					141.3	63.0					
64	RC-6		0	5.0'/5.1'	MARBLE; very light gray (N8), medium to coarse grained, hard; Pale yellowish green (10GY 7/2) bands at 65.7 and 66.7 (weathered); high angle fractures 63.1 (weath), 64.1 (weath), 64.7 (mech), 65.9 (mech), 66.7 (weath), 67.6 (mech), 67.9 (mech).					Penetration rate = 2.8 min/ft; Core recovery = 5.1 ft (102%)	
66											

Report Name: NEW OBG BORING LOG - NO USCS Data Template: OBG GINT STD US BC.GDT

(Continued Next Page)



BORING LOG

WELL NO. MW-2DB

PROJECT: Brownfield Cleanup Program No. C360115
CLIENT: One Holland Avenue Development, LLC.
INSPECTOR: Nate Vogan

SHEET 3 OF 3
JOB NO. 14206.47376

DEPTH (ft)	Sample Type	Number	Blows/6" (N Value)	Penetration/ Recovery	MATERIAL DESCRIPTION	Graphic Log	Stratum Change	Field Testing PID (ppm)	Well Graphic	REMARKS
68					.136.3					
70	RC-7		0	5.0'/5.0'	MARBLE; very light gray (N8), medium to coarse grained, hard; Greenish gray (5GY 6/1) and medium dark gray (N4) chert nodules 69.6-70.8 and 72.3; high angle fractures at 71.5 (mech) and 72.8 (mech); reprecipitated fractures 68.3-69.0.					Penetration rate = 2.8 min/ft; Core recovery = 5.0 ft (100%)
72										
74	RC-8		0	5.0'/5.0'	.131.3					Penetration rate = 2.2 min/ft; Core recovery = 5.0 ft (100%); Core break at 75.1 and 76.1 for box.
76										
78										
80	RC-9		0	5.0'/5.0'	.126.3					Penetration rate = 3.6 min/ft; Core recovery = 5.0 ft (100%)
82										
84	RC-10		0	5.0'/5.0'	.121.3					Penetration rate = 2.4 min/ft; Core recovery = 5.0 ft (100%); Core break at 85.4, 86.0, and 84.3 for box.
86										
88	RC-11		0	5.0'/5.0'	.116.3					Penetration rate = 2.8 min/ft; Core recovery = 5.0 ft (100%)
90										
92										
94					.111.3					Refusal at 34.1'. End of Borehole at 93.0'.
96										
98										
100										
102										
104										

Report Name: NEW OBG BORING LOG - NO USCS Data Template: OBG GINT STD US BC.GDT

INWOOD MARBLE



BORING LOG

WELL NO. **MW-2SB**

PROJECT: Brownfield Cleanup Program No. C360115
CLIENT: One Holland Avenue Development, LLC.
INSPECTOR: Nate Vogan

SHEET 1 OF 2
JOB NO. 14206.47376
GROUND ELEV. 203.94

DRILLING CONTRACTOR: Parratt Wolff, Inc.
DRILLER: Glenn Lansing
PURPOSE: Remedial Investigation
DRILLING METHOD: Direct Push, HSA
DRILL RIG TYPE: CME 850

	SAMPLE	CORE	CASING
TYPE	SS	---	---
DIA.	2"	---	---

DATUM
DATE STARTED 4/12/2011
DATE FINISHED 4/19/2011

DEPTH (ft)	Sample Type	Number	Blows/6" (N Value)	Penetration/ Recovery	MATERIAL DESCRIPTION	Graphic Log	Stratum Change	Field Testing PID (ppm)	Well Graphic	REMARKS
2	SS-1	4-8-8 (12)	1.5'/1.0'	203.4	Asphalt	0.5	FILL	0.2	[Well Graphic]	
4	SS-2	6-7-7-6 (14)	2.0'/0.8'	202.8	Dark yellowish brown (10YR 4/2), moist, loose; f SAND, some m sand and silt. Pale yellowish brown (10YR 6/2), dry, loose; mf SAND, some crushed stone, little c angular gravel.	1.1		1.8		
6	SS-3	6-5-3-3 (8)	2.0'/1.4'	199.0	Moderate yellowish brown (10YR 5/4), moist, loose; mf SAND.	4.9	SAND	0.4	[Well Graphic]	
8	SS-4	4-5-6-7 (11)	2.0'/1.2'	197.7	Pale yellowish brown (10YR 6/2), moist, loose; mf SAND, trace mf rounded gravel.	6.2		0.4		
10	SS-5	5-5-6-5 (11)	2.0'/1.5'	195.9	Pale yellowish brown (10YR 6/2), moist, loose; mf SAND, little c sand.	8.0	SAND & GRAVEL	0.5	[Well Graphic]	
12	SS-6	1-2-3-5 (5)	2.0'/0.9'	193.9	no coarse sand	10.0		0.7		
14	SS-7	6-9-10-12 (19)	2.0'/1.2'	191.9	Pale yellowish brown (10YR 6/2), moist, loose; mc SAND, some f sand, little subrounded to angular mc gravel.	12.0	SAND & GRAVEL	0.8	[Well Graphic]	
16	SS-8	3-4-8-7 (12)	2.0'/0.7'	187.9	Dark yellowish brown (10YR 4/2), wet, medium dense; c SAND, some m sand, little to some mc subrounded gravel.	16.0		0.4		
18	SS-9	6-5-6-3 (11)	2.0'/1.1'	183.9	1" cobble lodged in spoon nose	20.0	SAND & GRAVEL	0.5	[Well Graphic]	
20	SS-10	2-3-2-3 (5)	2.0'/0.8'	181.9	Dark yellowish brown (10YR 4/2), wet, medium dense; mf SAND, trace f gravel.	22.0		0.2		
22	SS-11	4-1-1-2 (2)	2.0'/0.2'	177.9	Dark yellowish brown (10YR 4/2), wet, dense; f SAND, trace m sand.	26.0	TILL	0.2	[Well Graphic]	
24	SS-12	1-3-4-7 (7)	2.0'/0.3'	176.7	Pale yellowish orange (10YR 8/6), wet, dense; crushed sandstone COBBLE.	27.2		0.3		
26	SS-13	8-5-3-4 (8)	2.0'/0.6'	175.9	Dark yellowish brown (10YR 4/2) to pale yellowish brown (10YR 6/2), f SAND and SILT matrix, mc subrounded gravel and cobbles.	28.0	TILL	0.2	[Well Graphic]	
28	SS-14	3-4-9-11 (13)	2.0'/1.4'	173.9		30.0		0.3		
30	SS-15	13-14-20-50/0.2 (34)	2.0'/0.7'							

Report Name: NEW OBG BORING LOG - NO USCS Data Template: OBG GINT STD US BC.GDT

Notes: 0.010" Slot Screen: 45-55 ft bgs; Riser: 0.5-45 ft bgs; #0 Sand: 43-55 ft bgs; Bentonite seal: 40-43 ft bgs; Grout: 1-40 ft bgs.

(Continued Next Page)



BORING LOG

WELL NO. **MW-2SB**

PROJECT: Brownfield Cleanup Program No. C360115
CLIENT: One Holland Avenue Development, LLC.
INSPECTOR: Nate Vogan

SHEET 2 OF 2

JOB NO. 14206.47376

DEPTH (ft)	Sample Type	Number	Blows/6" (N Value)	Penetration/ Recovery	MATERIAL DESCRIPTION	Graphic Log	Stratum Change	Field Testing PID (ppm)	Well Graphic	REMARKS
32	SS-16		50/0.2 (>50)	2.0'/0.2'	Cobble lodged in spoon nose			0.0		
32					171.9 No samples, auger to top of rock at 35 ft		TILL			
34										
36					168.9 No samples, roller bit to 40 ft for rock socket					
38										
40					163.9 MARBLE; very light gray (N8), medium to coarse grained, moderately fractured, hard; Grayish yellow green (5GY 7/2) mottling and banding 40.5-41.2, 41.6-43.1; low angle fractures at 40.5 (mech), 41.5 (mech, old healed); horizontal fracture at 42.0 (mech); high angle fracture at 41.1 (mech).		INWOOD MARBLE			Penetration Rate = 2.8 min/ft
42	RC-1		0	3.5'/3.4'						
44					160.4 MARBLE; very light gray (N8), medium to coarse grained, moderately fractured, hard; Grayish yellow green (5GY 7/2) bands 46.2-46.9 (soft, slightly weathered); low angle fracture at 44.1 (mech), 44.6 (mech), 45.5 (mech), 47.2 (mech), 47.6 (mech), 48.2 (mech); high angle fracture at 46.7 (weath), 47.4 (mech), 47.9 (mech).					Penetration Rate = 2.8 min/ft
46	RC-2		0	5.0'/5.0'						
48										
50					155.4 MARBLE; very light gray (N8), medium to coarse grained, moderately fractured, hard; Numerous healed fractures; shattered and weathered from 51.4-52.7; low angle fracture at 49.5 (mech), 50.7 (mech), 53.0; high angle fracture at 51.3 (mech), 52.9 (remineralized), 53.3 (slightly weathered).					Penetration Rate = 2.0 min/ft
52	RC-3		0	5.0'/5.0'						
54					150.4 MARBLE; very light gray (N8), medium to coarse grained, moderately fractured, hard; Healed, white (N9) fracture 148.9 52.0-52.6; high angle fracture 53.8 (mech), 54.7 (mech).					Penetration Rate = 2.7 min/ft
54	RC-4		0	1.5'/1.3'						
56					Refusal at 32.2'. End of Borehole at 55.0'.					
58										
60										
62										
64										
66										

Report Name: NEW OBG BORING LOG - NO USCS Data Template: OBG GINT STD US BC.GDT



BORING LOG

WELL NO. **MW-5DB**

PROJECT: Brownfield Cleanup Program No. C360115
CLIENT: One Holland Avenue Development, LLC.
INSPECTOR: Nate Vogan

SHEET 1 OF 3
JOB NO. 14206.47376
GROUND ELEV. 203.35

DRILLING CONTRACTOR: Parratt Wolff, Inc.
DRILLER: Glenn Lansing
PURPOSE: Remedial Investigation
DRILLING METHOD: Direct Push, HSA
DRILL RIG TYPE: CME 850

	SAMPLE	CORE	CASING
TYPE	AU	---	---
DIA.	2"	---	---

DATUM
DATE STARTED 4/4/2011
DATE FINISHED 4/12/2011

DEPTH (ft)	Sample Type	Number	Blows/6" (N Value)	Penetration/ Recovery	MATERIAL DESCRIPTION	Graphic Log	Stratum Change	Field Testing PID (ppm)	Well Graphic	REMARKS
2					No samples taken, auger to 10 ft bgs.			0.1		
4							NO SAMPLE			
6	AU-NA	NA-NA-NA-NA (NA)		10.0/0.0'						
10					193.4	10.0				
12	SS-1	6-4-7-8 (11)	2.0/1.5'		192.7 Moderate yellowish brown (10YR 5/4), moist, loose; mf SAND, slight chemical odor, trace crushed asphalt (sluff). 191.4 Pale yellowish brown (10YR 6/2), moist, loose; f SAND, little m sand, thinly laminated, no odor.			0.1		
14	SS-2	7-7-7-9 (14)	2.0/1.2'		189.4 some moderate yellowish brown sand with little c rounded gravel.		SAND	0.2		
16	SS-3	5-5-3-4 (8)	2.0/1.2'		187.4 Dark yellowish brown (10YR 4/2), wet, loose to medium dense; mc SAND, little f sand, well graded, no odor.			0.1		
18	SS-4	4-5-8-7 (13)	2.0/1.4'		187.4 some c sand layers alternating with mf sand layers 3-4" thick, no odor			0.1		
20	SS-5	3-4-5-5 (9)	2.0/1.9'		185.4 Dark yellowish brown (10YR 4/2), wet, medium dense; mc SAND, little f sand, trace mc rounded gravel, no odor.		SAND & GRAVEL	0.1		
22	SS-6	1-1-2-1 (3)	2.0/1.4'		183.4 no gravel			0.4		
24	SS-7	2-3-3-5 (6)	2.0/1.3'		181.4 trace c rounded gravel			0.0		
26	SS-8	1-1-2-4 (3)	2.0/0.6'		179.4 Dark yellowish brown (10YR 4/2), wet, medium dense; fm SAND, little c sand, trace f gravel, no odor.			0.1		
28	SS-9	5-7-8-11 (15)	2.0/1.8'		177.4 Pale yellowish brown (10YR 4/2), wet, medium dense; mf SAND, little c sand, no odor.		SAND	0.1		
30	SS-10	2-5-10-10 (15)	2.0/1.2'					0.0		

Report Name: NEW OBG BORING LOG - NO USCS Data Template: OBG GINT STD US BC.GDT

Notes: Soil descriptions taken from MW-5SB. 0.010" Slot Screen: 88-98 ft bgs; Riser: 0.5-88 ft bgs; #0 Sand: 86-98.5 ft bgs; Bentonite seal: 83-86 ft bgs; Grout: 1-83 ft bgs; Hole bottom: sand 100-104 ft bgs, bentonite 98.5-100 ft bgs.



BORING LOG

WELL NO. **MW-5DB**

PROJECT: Brownfield Cleanup Program No. C360115
CLIENT: One Holland Avenue Development, LLC.
INSPECTOR: Nate Vogan

SHEET 2 OF 3

JOB NO. 14206.47376

DEPTH (ft)	Sample Type	Number	Blows/6" (N Value)	Penetration/ Recovery	MATERIAL DESCRIPTION	Graphic Log	Stratum Change	Field Testing PID (ppm)	Well Graphic	REMARKS	
32	SS-11		2-3-3-4 (6)	2.0'/1.2'	Pale yellowish brown (10YR 4/2), wet, medium dense; mf SAND, little c sand, no odor. (continued)		SAND	0.2			
34	SS-12		13-22-9-7 (31)	2.0'/1.4'	170.6 170.2 32.8 32.2 Grayish brown (5YR 3/2), wet, dense; f SAND, little m sand, trace c sand.		TILL	0.0			
36	SS-13		12-17-13-9 (30)	2.0'/0.4'	Pale yellowish brown (10YR 6/2), wet, dense; f SAND matrix supporting crushed cobbles (1") and mc subangular gravel, some clay, little silt.		TILL	0.0			
36	SS-14		25-50/0.25 (>50)	0.8'/0.5'	No samples taken. Roller bit to 41 ft bgs for installation of 6" threaded pipe.			0.1			
42	RC-1		0	3.5'/3.3'	162.4 41.0 MARBLE; very light gray (N8), medium to coarse grained, highly fractured, hard; some iron staining, vertical fracture along a weathered calcite seam 41.4-42.4; vertical fracture 42.5-43.0, 43.6-44.2; high angle fractures 41.2, 41.4, 42.9; high angle fractures 41.1-41.2, 42.3, 43.1, 43.3, 44.1, 44.2; horizontal fractures 41.2, 41.4, 42.9; highly fractured 42.9-44.1		INWOOD MARBLE			Penetration Rate = 4.3 min/ft	
46	RC-2		0	5.0'/5.2'	158.9 44.5 MARBLE; very light gray (N8), medium to coarse grained, moderately fractured, hard; high angle fracture at 44.7, 45.2, 45.9, 46.3, 47.3, 47.6, 48.0, 48.5, 48.9; some calcite weathering in fractures; iron discoloration 49.2-49.6.					Penetration Rate = 2.4 min/ft	
50	RC-3		0	5.0'/5.1'	153.9 49.5 MARBLE; very light gray (N8), medium to coarse grained, slightly fractured, hard; high angle fracture 50.3, 51, 53, 53.7 54.4; mechanical fracture along vertical weathered calcite seam 49.9-50.3.					Penetration Rate = 3 min/ft	
56	RC-4		0	5.0'/5.0'	148.9 54.5 MARBLE; very light gray (N8), medium to coarse grained, slightly fractured, hard; high angle fracture at 55.1, 55.7, 56.2, 56.7, 57.2, 59.1; Horizontal mechanical fractures at 55.3, 57.6, 58.5; Some weathering at 57.2.						Penetration Rate = 2.8 min/ft
60	RC-5		0	5.0'/5.2'	143.9 59.5 MARBLE; very light gray (N8), medium to coarse grained, slightly fractured, hard; high angle fracture 59.9, 60.3, 60.5, 60.9, 61.4, 61.9-62.1, 62.6 (some weathering in fractures); mechanical fractures 59.6, 59.7; Vug at 60.8; Sample taken 60.5-61.4 for COD, bulk density, moisture.						Penetration Rate = 2.6 min/ft
66	RC-6		0	5.0'/5.1'	138.9 64.5 MARBLE; very light gray (N8), medium to coarse grained, slightly fractured, hard; light bluish gray (5B 7/1) chert nodules; Light greenish gray (5GY 8/1) splotches 65.2, 66.3; High angle fractures 65.7, 66.4, 67.2, 67.9; Slight calcite precipitation in fracture planes.						Penetration Rate = 2.6 min/ft

Report Name: NEW OBG BORING LOG - NO USCS Data Template: OBG GINT STD US BC.GDT

(Continued Next Page)



BORING LOG

WELL NO. MW-5DB

PROJECT: Brownfield Cleanup Program No. C360115
CLIENT: One Holland Avenue Development, LLC.
INSPECTOR: Nate Vogan

SHEET 3 OF 3

JOB NO. 14206.47376

DEPTH (ft)	Sample Type	Number	Blows/6" (N Value)	Penetration/ Recovery	MATERIAL DESCRIPTION	Graphic Log	Stratum Change	Field Testing PID (ppm)	Well Graphic	REMARKS	
68											
70					133.9 69.5 MARBLE; very light gray (N8), medium to coarse grained, slightly fractured, hard; high angle fractures 71.1 (mech), 72.2 (mech), 72.7 (mech), 73.0 (remineralized); Shattered and highly weathered 73.5-73.8, soft, granular, some calcite remineralization.					Penetration Rate = 2.2 min/ft	
72		RC-7	0	5.0'/4.9'							
74					128.9 74.5 MARBLE; very light gray (N8), medium to coarse grained, slightly fractured, hard; dark grey (N3) chert nodules 74.7-76.6; high angle fractures at 76.8 (mech); 77.4 (mech); 77.9 (reprecipitated calcite), 78.5 (mech), 78.8 (mech); Horizontal fracture at 78.3.					Penetration Rate = 3 min/ft	
76		RC-8	0	5.0'/5.2'							
78											
80					123.9 79.5 MARBLE; very light gray (N8), medium to coarse grained, slightly fractured, hard; dark grey (N3) chert nodules 82.3-83.1; high angle fracture at 80.3 (mech), 81.3 (mech), 82.1 (mech), 83.3 (reprecipitated calcite); low angle fracture 81.5 (mech).					Penetration Rate = 3.4 min/ft	
82		RC-9	0	5.0'/4.9'							
84											
86					118.9 84.5 MARBLE; very light gray (N8), medium to coarse grained, slightly fractured, hard; pale olive (10Y 6/2) mottling 87.5-87.9 and 88.4-89.5; dark grey (N3) chert with green; Horizontal fracture at 85.1 (mech), 86.1 (mech); Low angle fracture 85.3 (mech), 86.6 (mech), 86.5 (mech), 88.7 (mech); remineralized zones at 84.6 and 85.5.					Penetration Rate = 2.8 min/ft	
88		RC-10	0	5.0'/5.0'							
90											
92					113.9 89.5 MARBLE; very light gray (N8), medium to coarse grained, barely fractured, hard; pale olive banding and mottling 89.5-94.3; Dark grey (N3) chert 89.6, 91.1-94.3; Some light brownish gray (5YR 6/1) 90-90.3; horizontal fracture at 90.9 (mech); high angle fracture at 93.1 (mech).						Penetration Rate = 4 min/ft
94		RC-11	0	5.0'/5.1'							
96											
98					108.9 94.5 MARBLE; very light gray (N8), medium to coarse grained, slightly fractured, hard; pale olive (10Y 6/2) banding and mottling with dark grey (N3) chert from 94.8 to 99; one horizontal fracture at 96.7.					Penetration Rate = 2.2 min/ft	
100		RC-12	0	4.5'/4.5'							
102											
104					104.4 99.0 MARBLE; very light gray (N8), medium to coarse grained, slightly fractured, hard; pale olive gray (10Y 6/2) banding 99-99.7; dark grey (N3) chert 99-102; low angle fracture at 102.5 (mech); horizontal fracture and 103.2 (mech), 103.9 (mech).					Penetration Rate = 2.2 min/ft	
104		RC-13	0	5.0'/4.9'							
104					99.4 104.0 Refusal at 35.5'. End of Borehole at 104.0'.						

Report Name: NEW OBG BORING LOG - NO USCS Data Template: OBG GINT STD US BC.GDT

INWOOD MARBLE



BORING LOG

WELL NO. **MW-5SB**

PROJECT: Brownfield Cleanup Program No. C360115
CLIENT: One Holland Avenue Development, LLC.
INSPECTOR: Nate Vogan

SHEET 1 OF 2
JOB NO. 14206.47376
GROUND ELEV. 203.11

DRILLING CONTRACTOR: Parratt Wolff, Inc.
DRILLER: Glenn Lansing
PURPOSE: Remedial Investigation
DRILLING METHOD: Direct Push, HSA
DRILL RIG TYPE: CME 850

	SAMPLE	CORE	CASING
TYPE	AU	---	---
DIA.	2"	---	---

DATUM
DATE STARTED 4/4/2011
DATE FINISHED 4/12/2011

DEPTH (ft)	Sample Type	Number	Blows/6" (N Value)	Penetration/ Recovery	MATERIAL DESCRIPTION	Graphic Log	Stratum Change	Field Testing PID (ppm)	Well Graphic	REMARKS
2					No samples taken, auger to 10 ft bgs.			0.1		
4							NO SAMPLE			
6	AU-NA	NA-NA-NA-NA (NA)		10.0/0.0'						
10					193.1	10.0				
12	SS-1	6-4-7-8 (11)	2.0/1.5'		192.4 Moderate yellowish brown (10YR 5/4), moist, loose; mf SAND, slight chemical odor, trace crushed asphalt (sluff). 191.1 Pale yellowish brown (10YR 6/2), moist, loose; f SAND, little m sand, thinly laminated, no odor.	10.7		0.1		
14	SS-2	7-7-7-9 (14)	2.0/1.2'		some moderate yellowish brown sand with little c rounded gravel.	12.0	SAND	0.2		
16	SS-3	5-5-3-4 (8)	2.0/1.2'		Dark yellowish brown (10YR 4/2), wet, loose to medium dense; mc SAND, little f sand, well graded, no odor.	14.0		0.1		
18	SS-4	4-5-8-7 (13)	2.0/1.4'		some c sand layers alternating with mf sand layers 3-4" thick, no odor	16.0		0.1		
20	SS-5	3-4-5-5 (9)	2.0/1.9'		Dark yellowish brown (10YR 4/2), wet, medium dense; mc SAND, little f sand, trace mc rounded gravel, no odor.	18.0	SAND & GRAVEL	0.1		
22	SS-6	1-1-2-1 (3)	2.0/1.4'		no gravel			0.4		
24	SS-7	2-3-3-5 (6)	2.0/1.3'		trace c rounded gravel			0.0		
26	SS-8	1-1-2-4 (3)	2.0/0.6'		Dark yellowish brown (10YR 4/2), wet, medium dense; fm SAND, little c sand, trace f gravel, no odor.	179.1		0.1		
28	SS-9	5-7-8-11 (15)	2.0/1.8'		Pale yellowish brown (10YR 4/2), wet, medium dense; mf SAND, little c sand, no odor.	26.0	SAND	0.1		
30	SS-10	2-5-10-10 (15)	2.0/1.2'					0.0		

Report Name: NEW OBG BORING LOG - NO USCS Data Template: OBG GINT STD US BC.GDT

Notes: 0.010" Slot Screen: 48-58 ft bgs; Riser: 0.5-48 ft bgs; #0 Sand: 46-58 ft bgs; Bentonite seal: 43-46 ft bgs; Grout: 1-43 ft bgs.



BORING LOG

WELL NO. MW-5SB

PROJECT: Brownfield Cleanup Program No. C360115
CLIENT: One Holland Avenue Development, LLC.
INSPECTOR: Nate Vogan

SHEET 2 OF 2
JOB NO. 14206.47376

DEPTH (ft)	Sample Type	Number	Blows/6" (N Value)	Penetration/ Recovery	MATERIAL DESCRIPTION	Graphic Log	Stratum Change	Field Testing PID (ppm)	Well Graphic	REMARKS
32	SS-11		2-3-3-4 (6)	2.0'/1.2'	Pale yellowish brown (10YR 4/2), wet, medium dense; mf SAND, little c sand, no odor. (continued)		SAND	0.2		
34	SS-12		13-22-9-7 (31)	2.0'/1.4'	170.3 169.9 Grayish brown (5YR 3/2), wet, dense; f SAND, little m sand, trace c sand.			0.0		
36	SS-13		12-17-13-9 (30)	2.0'/0.4'	Pale yellowish brown (10YR 6/2), wet, dense; f SAND matrix supporting crushed cobbles (1") and mc subangular gravel, some clay, little silt.		TILL	0.0		
38	SS-14		25-50/0.25 (>50)	0.8'/0.5'	Crushed cobble in spoon nose.			0.1		
38	SS-15		50/0.3 (>50)	0.3'/0.1'	165.1 164.8 Crushed marble			0.1		
40					No samples, roller bit to 43 ft bgs to set 6" casing					
44	RC-1		()	5.0'/5.0'	160.1 43.0 MARBLE; very light gray (N8), medium to coarse grained, highly fractured, hard; some greenish gray (5GY 6/1) banding 43.0-43.3 and 43.7-43.8; low angle fracture at 43.8 (mech), 44.4 (mech), 44.7-45.2 (weath), 45.4 (weath), 45.5 (mech), 45.7-48.1 (weath), 49.1 (mech), 49.2 (mech), 49.3 (mech), 49.4 (mech), 49.5 (mech), 49.9 (mech); vertical fracture 46.1-46.5, very coarse grained, weathered.		INWOOD MARBLE			Penetration Rate = 1.6 min/ft
48	RC-2		()	5.0'/4.9'	155.1 48.0 MARBLE; very light gray (N8), medium to coarse grained, moderately fractured, hard; some light brownish gray banding at 50.3; high angle fracture at 48.1 (mech), 48.3-48.9 (weathered with iron staining, possible clay), 49.7 (mech), 50.5 (weath), 51.2 (weath), 51.6 (weath), 52.2 (weath), 52.6-52.9 (weath), remineralization on weathered fracture faces.					Penetration Rate = 1.6 min/ft
54	RC-3		()	5.0'/5.1'	150.1 53.0 MARBLE; very light gray (N8), medium to coarse grained, slightly fractured, hard; high angle fractures 53.1 (mech), 53.7 (weath with remineralization), 54.1 (mech), 55.6 (mech), 56.5 (mech), 57.1 (mech).					Penetration Rate = 1.6 min/ft
58					145.1 58.0 Refusal at 38.3'. End of Borehole at 58.0'.					
60										
62										
64										
66										

Report Name: NEW OBG BORING LOG - NO USCS Data Template: OBG GINT STD US BC.GDT



BORING LOG

WELL NO. **MW-6**

PROJECT: Brownfield Cleanup Program No. C360115
CLIENT: One Holland Avenue Development, LLC.
INSPECTOR: Nate Vogan

SHEET 1 OF 1
JOB NO. 14206.47376
GROUND ELEV. 204.02

DRILLING CONTRACTOR: Parratt Wolff, Inc.
DRILLER: Glenn Lansing
PURPOSE: Remedial Investigation
DRILLING METHOD: Direct Push, HSA
DRILL RIG TYPE: CME 850

	SAMPLE	CORE	CASING
TYPE	SS	---	---
DIA.	2"	---	---

DATUM
DATE STARTED 8/1/2011
DATE FINISHED 8/1/2011

DEPTH (ft)	Sample Type	Number	Blows/6" (N Value)	Penetration/ Recovery	MATERIAL DESCRIPTION	Graphic Log	Stratum Change	Field Testing PID (ppm)	Well Graphic	REMARKS
2	SS-1	8-10-14 (18)	2.0'/0.2'	2.0'/0.2'	203.5 Asphalt	0.5		0.0		
4	SS-2	11-16-17-23 (33)	2.0'/1.2'	2.0'/1.2'	Moderate brown (5YR 4/4), dry loose; mf SAND, little mc gravel, trace silt.	2.0	FILL	13.3		
6	SS-3	6-12 (NA)	1.0'/0.1'	1.0'/0.1'	202.0 moist, quartzite cobble lodged in nose	5.0		NA		
8	SS-4	11-18-13-17 (31)	2.0'/1.6'	2.0'/1.6'	199.0 Auger to 5 ft bgs, poor sample recovery, 2" rounded cobble in spoon nose.	6.0	0.0			
10	SS-5	23-22-15-12 (37)	2.0'/0.5'	2.0'/0.5'	Moderate brown (5YR 3/4), moist, medium dense; f SAND, some silt, little m sand, trace large rounded cobbles.	8.4	0.0			
12	SS-6	3-6-8-20 (14)	2.0'/1.0'	2.0'/1.0'	195.6 Yellowish gray (5Y 7/2), moist, loose, mf SAND, trace c sand.	12.0	SAND	0.0		
14	SS-7	20-27-34-35 (61)	2.0'/1.4'	2.0'/1.4'	Dark yellowish brown (10YR 4/2), f sand, some silt, little mf gravel (subrounded), trace crushed cobble.	20.0	SAND & GRAVEL	0.0		
16	SS-8	16-19-35-32 (54)	2.0'/1.8'	2.0'/1.8'		0.0		0.0		
18	SS-9	27-50/0.25 (>50)	1.0'/0.3'	1.0'/0.3'		0.0		0.0		
20	SS-10	22-38-33-22 (71)	2.0'/1.1'	2.0'/1.1'	184.0 Dark yellowish brown (10YR 4/2), wet, dense; mc SAND, some mc subrounded gravel, little subrounded cobbles, trace silt.	20.0	0.0			Wet at 19-19.5
22	SS-11	19-26-32-50/0.25 (58)	2.0'/1.4'	2.0'/1.4'		0.0	0.0			
24	SS-12	38-53 (>50)	1.0'/0.9'	1.0'/0.9'	180.0 End of Borehole at 24.0'.	24.0	0.0			

Report Name: NEW OBG BORING LOG - NO USCS Data Template: OBG GINT STD US BC.GDT

Notes: Soil descriptions taken from MW-6SB. 0.010" Slot Screen: 14-24 ft bgs; Riser: 0.5-14 ft bgs; #0 Sand: 12-24 ft bgs; Bentonite seal: 9-12 ft bgs; Grout: 1-9 ft bgs



BORING LOG

WELL NO. **MW-6SB**

PROJECT: Brownfield Cleanup Program No. C360115
CLIENT: One Holland Avenue Development, LLC.
INSPECTOR: Nate Vogan

SHEET 1 OF 2
JOB NO. 14206.47376
GROUND ELEV. 204.2

DRILLING CONTRACTOR: Parratt Wolff, Inc.
DRILLER: Glenn Lansing
PURPOSE: Remedial Investigation
DRILLING METHOD: Direct Push, HSA
DRILL RIG TYPE: CME 850

	SAMPLE	CORE	CASING
TYPE	SS	---	---
DIA.	2"	---	---

DATUM
DATE STARTED 7/30/2011
DATE FINISHED 8/1/2011

DEPTH (ft)	Sample Type	Number	Blows/6" (N Value)	Penetration/ Recovery	MATERIAL DESCRIPTION	Graphic Log	Stratum Change	Field Testing PID (ppm)	Well Graphic	REMARKS
2	SS-1	8-10-14 (18)	2.0'/0.2'	2.0'/0.2'	203.7 Asphalt Moderate brown (5YR 4/4), dry loose; mf SAND, little mc gravel, trace silt.	0.5	FILL	0.0		
4	SS-2	11-16-17-23 (33)	2.0'/1.2'	2.0'/1.2'	202.2 moist, quartzite cobble lodged in nose	2.0		13.3		
6	SS-3	6-12 (NA)	1.0'/0.1'	1.0'/0.1'	199.2 Auger to 5 ft bgs, poor sample recovery, 2" rounded cobble in spoon nose.	5.0	SAND	NA		
8	SS-4	11-18-13-17 (31)	2.0'/1.6'	2.0'/1.6'	198.2 Moderate brown (5YR 3/4), moist, medium dense; f SAND, some silt, little m sand, trace large rounded cobbles.	6.0		0.0		
10	SS-5	23-22-15-12 (37)	2.0'/0.5'	2.0'/0.5'	195.8 Yellowish gray (5Y 7/2), moist, loose, mf SAND, trace c sand.	8.4	SAND & GRAVEL	0.0		
12	SS-6	3-6-8-20 (14)	2.0'/1.0'	2.0'/1.0'	192.2 Dark yellowish brown (10YR 4/2), f sand, some silt, little mf gravel (subrounded), trace crushed cobble.	12.0		0.0		
14	SS-7	20-27-34-35 (61)	2.0'/1.4'	2.0'/1.4'	184.2 Dark yellowish brown (10YR 4/2), wet, dense; mc SAND, some mc subrounded gravel, little subrounded cobbles, trace silt.	20.0	TILL	0.0		
16	SS-8	16-19-35-32 (54)	2.0'/1.8'	2.0'/1.8'				19-26-32-50/0.25 (58)		0.0
18	SS-9	27-50/0.25 (>50)	1.0'/0.3'	1.0'/0.3'	180.2 Grayish orange (10YR 7/4), wet, dense; mc SAND, some mc subrounded gravel, little crushed cobbles.	24.0	TILL	0.0		
20	SS-10	22-38-33-22 (71)	2.0'/1.1'	2.0'/1.1'				49-50/0.25 (>50)		0.0
22	SS-11	38-53 (>50)	1.0'/0.9'	1.0'/0.9'	174.2	30.0	TILL	0.0		
24	SS-12	33-35-34-41 (69)	2.0'/1.4'	2.0'/1.4'				11-33-41-47 (74)		0.0
26	SS-13	49-50/0.25 (>50)	0.8'/0.8'	0.8'/0.8'				0.0		
28	SS-14	11-33-41-47 (74)	2.0'/0.9'	2.0'/0.9'				0.0		
30	SS-15							0.0		

Wet at 19-19.5

Report Name: NEW OBG BORING LOG - NO USCS Data Template: OBG GINT STD US BC.GDT

Notes: 0.010" Slot Screen: 42-52 ft bgs; Riser: 0.5-42 ft bgs; #0 Sand: 40-52 ft bgs; Bentonite seal: 37-40 ft bgs; Grout 0-37 ft bgs

(Continued Next Page)



BORING LOG

WELL NO. MW-6SB

PROJECT: Brownfield Cleanup Program No. C360115
CLIENT: One Holland Avenue Development, LLC.
INSPECTOR: Nate Vogan

SHEET 2 OF 2
JOB NO. 14206.47376

DEPTH (ft)	Sample Type	Number	Blows/6" (N Value)	Penetration/Recovery	MATERIAL DESCRIPTION	Graphic Log	Stratum Change	Field Testing PID (ppm)	Well Graphic	REMARKS
32	SS-16		33-50/0.25 (>50)	1.0'/0.8'	Moderate brown (5YR 4/4), wet, dense; mf SAND, trace silt.		TILL	0.0		
32	SS-17		50/0.2 (>50)	0.2'/0.2'	172.0 Weathered MARBLE			0.0		
34					170.2 No samples taken, roller bit to 38 ft bgs to set casing.					
38	RC-1		()	1.0'/0.6'	166.2 MARBLE; very light gray (N8), medium to coarse grained, thinly bedded; some grayish orange remineralization, Fractured 38.0-38.2; vertical fracture with clay on bedding plane 38.2-38.6.		INWOOD MARBLE	29.7		Penetration Rate = 3.0 min/ft
40	RC-2		()	5.0'/2.8'	165.2 MARBLE; very light gray (N8), coarse grained, highly fractured; weathered with loose grains; Horizontal fractures at 39.3, 39.6, 39.8, 40.0, 40.1, 40.3, 40.7, 40.9, 41.2, 41.3; vertical fracture with iron staining and a pitted surface 41.3-41.7; Shattered from 41.7-41.8; 121 ppm at 41.3, 20 ppm on average.			121		Penetration Rate = 2.0 min/ft
44					160.2 No recovery; last 1.5 feet of run was free fall; Very coarse sand washed out as cuttings; Lost 100 gallons of water.			>9999		Penetration Rate = 2.4 min/ft
50	RC-3		()	5.0'/0.0'						
52	RC-4		()	5.0'/2.1'	155.2 MARBLE; very light gray (N8), medium to coarse grained, thinly bedded; highly fractured and weathered; mix of broken rock pieces and loose very coarse sand sized grains; lost 50 gallons of water.					Penetration Rate = 2.4 min/ft
54					149.2					
56					Refusal at 32.2'. End of Borehole at 55.0'.					

Report Name: NEW OBG BORING LOG - NO USCS Data Template: OBG GINT STD US BC.GDT



BORING LOG

WELL NO. **MW-7**

PROJECT: Brownfield Cleanup Program No. C360115
CLIENT: One Holland Avenue Development, LLC.
INSPECTOR: Nate Vogan

SHEET 1 OF 1
JOB NO. 14206.47376
GROUND ELEV. 200.15

DRILLING CONTRACTOR: Parratt Wolff, Inc.
DRILLER: Glenn Lansing
PURPOSE: Remedial Investigation
DRILLING METHOD: Direct Push, HSA
DRILL RIG TYPE: CME 850

DATUM
DATE STARTED 10/5/2011
DATE FINISHED 10/6/2011

	SAMPLE	CORE	CASING
TYPE	SS	---	---
DIA.	2"	---	---

DEPTH (ft)	Sample Type	Number	Blows/6" (N Value)	Penetration/ Recovery	MATERIAL DESCRIPTION	Graphic Log	Stratum Change	Field Testing PID (ppm)	Well Graphic	REMARKS
2	SS-1	5-5-6	(10)	1.5'/0.6'	199.7 Asphalt Dark yellowish brown (10YR 4/2), wet, medium dense; mc SAND, some mc angular gravel, little silt.	0.5		0.0		
4	SS-2	6-12-12-9	(24)	2.0'/0.8'	196.2 Dark yellowish brown (10YR 4/2) to light brown (5YR 5/6), wet, medium dense; mc SAND, some f gravel, trace crushed stone.	4.0		0.1		
6	SS-3	4-6-6-5	(12)	2.0'/0.7'	194.2 some crushed brick	6.0	FILL	0.0		
8	SS-4	4-4-5-12	(9)	2.0'/0.4'				0.1		
10	SS-5	3-3-4-9	(7)	2.0'/1.1'				0.2		
12	SS-6	10-19-10-6	(29)	2.0'/1.2'	189.4 Grayish brown (5YR 3/2), moist, medium dense; mf SAND, some coal fragments, trace f gravel.	10.8		0.0		
14	SS-7	4-6-6-8	(12)	2.0'/1.0'	187.9 187.6 Light brown (5YR 5/6), wet, medium dense, f SAND. Pale yellowish brown (10YR 6/2), moist, medium dense; mf SAND, little c sand.	12.3 12.6		0.0		
16	SS-8	5-4-4-4	(8)	2.0'/1.0'	186.2 Pale yellowish brown (10YR 6/2), wet, medium dense; mf SAND, some c sand.	14.0		0.0		
18	SS-9	4-4-8-10	(12)	2.0'/1.8'	183.1 Moderate yellowish brown (10YR 4/2), wet, medium dense; m SAND, little f sand.	17.1	SAND	0.0		
20	SS-10	3-3-3-4	(6)	2.0'/1.5'				0.0		
22	SS-11	3-4-3-4	(7)	2.0'/1.9'	178.2 Yellowish brown (10YR 6/2), wet, medium dense; m SAND, little cf sand.	22.0		0.0		
24	SS-12	3-4-5-4	(9)	2.0'/1.7'	176.2 Yellowish brown (10YR 6/2), wet, medium dense; m SAND, little f sand, trace c gravel.	24.0		0.0		
26	SS-13	3-4	(0)	1.0'/1.0'	175.2 End of Borehole at 25.0'.	25.0		0.0		

Report Name: NEW OBG BORING LOG - NO USCS Data Template: OBG GINT STD US BC.GDT

Notes: Soil descriptions taken from MW-7SB. 0.010" Slot Screen: 15-25 ft bgs; Riser: 0.5-15 ft bgs; #0 Sand: 13-25 ft bgs; Bentonite: 10-13 ft bgs; Grout: 1-10 ft bgs



BORING LOG

WELL NO. **MW-7SB**

PROJECT: Brownfield Cleanup Program No. C360115
CLIENT: One Holland Avenue Development, LLC.
INSPECTOR: Nate Vogan

SHEET 1 OF 2
JOB NO. 14206.47376
GROUND ELEV. 200.21

DRILLING CONTRACTOR: Parratt Wolff, Inc.
DRILLER: Glenn Lansing
PURPOSE: Remedial Investigation
DRILLING METHOD: Direct Push, HSA
DRILL RIG TYPE: CME 850

	SAMPLE	CORE	CASING
TYPE	SS	---	---
DIA.	2"	---	---

DATUM
DATE STARTED 10/3/2011
DATE FINISHED 10/5/2011

DEPTH (ft)	Sample Type	Number	Blows/6" (N Value)	Penetration/ Recovery	MATERIAL DESCRIPTION	Graphic Log	Stratum Change	Field Testing PID (ppm)	Well Graphic	REMARKS
2	SS-1	5-5-6	(10)	1.5'/0.6'	199.7 Asphalt Dark yellowish brown (10YR 4/2), wet, medium dense; mc SAND, some mc angular gravel, little silt.	0.5		0.0		
4	SS-2	6-12-12-9	(24)	2.0'/0.8'	196.2 Dark yellowish brown (10YR 4/2) to light brown (5YR 5/6), wet, medium dense; mc SAND, some f gravel, trace crushed stone.	4.0		0.1		
6	SS-3	4-6-6-5	(12)	2.0'/0.7'	194.2 some crushed brick	6.0	FILL	0.0		
8	SS-4	4-4-5-12	(9)	2.0'/0.4'				0.1		
10	SS-5	3-3-4-9	(7)	2.0'/1.1'				0.2		
12	SS-6	10-19-10-6	(29)	2.0'/1.2'	189.4 Grayish brown (5YR 3/2), moist, medium dense; mf SAND, some coal fragments, trace f gravel.	10.8		0.0		
14	SS-7	4-6-6-8	(12)	2.0'/1.0'	187.9 187.6 Light brown (5YR 5/6), wet, medium dense, f SAND. Pale yellowish brown (10YR 6/2), moist, medium dense; mf SAND, little c sand.	12.3 12.6		0.0		
16	SS-8	5-4-4-4	(8)	2.0'/1.0'	186.2 Pale yellowish brown (10YR 6/2), wet, medium dense; mf SAND, some c sand.	14.0		0.0		
18	SS-9	4-4-8-10	(12)	2.0'/1.8'	183.1 Moderate yellowish brown (10YR 4/2), wet, medium dense; m SAND, little f sand.	17.1		0.0		
20	SS-10	3-3-3-4	(6)	2.0'/1.5'				0.0		
22	SS-11	3-4-3-4	(7)	2.0'/1.9'	178.2 Yellowish brown (10YR 6/2), wet, medium dense; m SAND, little cf sand.	22.0	SAND	0.0		
24	SS-12	3-4-5-4	(9)	2.0'/1.7'	176.2 Yellowish brown (10YR 6/2), wet, medium dense; m SAND, little f sand, trace c gravel.	24.0		0.0		
26	SS-13	3-4-5-4	(9)	2.0'/2.0'				0.0		
28	SS-14	2-2-3-4	(5)	2.0'/2.0'	172.2 Yellowish brown (10YR 6/2), wet, medium dense; mc SAND, little f sand.	28.0		0.0		
30	SS-15	6-4-6-12	(10)	2.0'/1.2'	170.2	30.0		0.0		

Report Name: NEW OBG BORING LOG - NO USCS Data Template: OBG GINT STD US BC.GDT

Notes: 0.010" Slot Screen: 44-54 ft bgs; Riser: 0.5-44 ft bgs; #0 Sand: 42-54 ft bgs; Bentonite: 39-42 ft bgs; Grout: 1-39 ft bgs



BORING LOG

WELL NO. **MW-7SB**

PROJECT: Brownfield Cleanup Program No. C360115
CLIENT: One Holland Avenue Development, LLC.
INSPECTOR: Nate Vogan

SHEET 2 OF 2

JOB NO. 14206.47376

DEPTH (ft)	Sample Type	Number	Blows/6" (N Value)	Penetration/ Recovery	MATERIAL DESCRIPTION	Graphic Log	Stratum Change	Field Testing PID (ppm)	Well Graphic	REMARKS	
32	SS-16		6-7-9-11 (16)	2.0'/1.8'	Moderate yellowish brown (10YR 5/4), wet, medium dense; mf SAND, little c sand.		SAND	0.0			
34	SS-17		26-33-22-46 (55)	2.0'/1.5'	167.2 Very pale orange (10YR 8/2), wet, dense; crushed COBBLES in a fmc sand matrix, little silt. 166.2		TILL	0.0			
36					Roller bit to 36 ft bgs for casing install, no samples taken.						
38	RC-1		0	3.0'	164.2 MARBLE; very light gray (N8), medium to coarse grained, slightly fractured, hard, inclined bedding; high angle fracture at 36.7 (remineralized), 37.4 (mech), 38.5 (remineralized); Horizontal fracture at 37.3 (mech).		INWOOD MARBLE			Penetration Rate = 5.7 min/ft	
40	RC-2		0	5.0'	161.2 MARBLE; very light gray (N8), medium to coarse grained, slightly fractured, hard, inclined bedding; some micaceous zones; High angle fractures at 39.5 (mech), 40.3 (mech), 40.6 (mech), 41.3 (mech), 42.5 (weath), 43.7 (mech); Horizontal fractures at 39.9 (mech), 43.2 (mech).					Penetration Rate = 5.6 min/ft	
44					156.2 MARBLE; very light gray (N8), medium to coarse grained, slightly fractured, hard, inclined bedding; some micaceous zones; High angle fractures at 45.4 (mech), 45.9 (mech), 48.5 (mech); Horizontal fractures at 44.8 (mech), 46.6 (mech), 47.2 (mech), 47.9 (mech).					Penetration Rate = 5.0 min/ft	
46	RC-3		0	5.0'							
50	RC-4		0	5.0'	151.2 MARBLE; very light gray (N8), medium to coarse grained, slightly fractured, hard, inclined bedding; micaceous; high angle fractures at 49.9 (mech), 50.2 (remineralized), 51.5 (mech), 51.7 (weathered); horizontal fractures at 52.6 (mech), 53.15 (mech).						Penetration Rate = 5.6 min/ft
54					146.2 Refusal at 34.0'. End of Borehole at 54.0'. 54.0						
56											
58											
60											
62											
64											
66											

Report Name: NEW OBG BORING LOG - NO USCS Data Template: OBG GINT STD US BC.GDT



BORING LOG

WELL NO. **MW-8**

PROJECT: Brownfield Cleanup Program No. C360115
CLIENT: One Holland Avenue Development, LLC.
INSPECTOR: Nate Vogan

SHEET 1 OF 1
JOB NO. 14206.47376
GROUND ELEV. 197.55

DRILLING CONTRACTOR: Parratt Wolff, Inc.
DRILLER: Glenn Lansing
PURPOSE: Remedial Investigation
DRILLING METHOD: Direct Push, HSA
DRILL RIG TYPE: CME 850

	SAMPLE	CORE	CASING
TYPE	SS	---	---
DIA.	2"	---	---

DATUM
DATE STARTED 10/10/2011
DATE FINISHED 10/11/2011

DEPTH (ft)	Sample Type	Number	Blows/6" (N Value)	Penetration/ Recovery	MATERIAL DESCRIPTION	Graphic Log	Stratum Change	Field Testing PID (ppm)	Well Graphic	REMARKS
2	SS-1	2-6-3-7 (9)	2.0/1.2'	195.3	Brownish black (5YR 2/1), moist, medium dense; mf SAND, little crushed brick, f gravel and coal fragements.			0.0		
	SS-2	21-50/0.3 (>50)	0.9/0.6'	193.3	Crushed amphibolite cobble			0.0		
4	SS-3	18-8-9-7 (17)	2.0/1.2'	193.6	Brownish black (5YR 2/1), moist to dry, medium dense; mf SAND, some coal fragments, crushed mica schist, trace crushed brick and glass.			0.0		
6	SS-4	50/0.3 (>50)	0.3/0.9'	189.6	Creosol odor			0.0		
8	SS-5	16-11-17-16 (28)	2.0/1.0'	187.6	Brownish black (5YR 2/1), moist to dry; mf SAND, some coal and woody fragments, large crushed mica schist cobble.			0.0		
10	SS-6	21-18-15-13 (33)	2.0/1.3'	184.7	Brownish gray (5YR 4/1), moist, medium dense; mf SAND, little silt, trace woody fragments.			0.0		
12	SS-7	10-12-7-7 (19)	2.0/1.5'	183.2	Brownish gray (5YR 4/1) to dark yellowish brown (10YR 4/2), wet, soft to medium dense; m SAND increasing to c sand at 14.4, trace mc subrounded gravel.			0.0		
14	SS-8	3-3-7-12 (10)	2.0/1.1'	181.6	Dark yellowish brown (10YR 4/2), wet, soft; c SAND and GRAVEL, little m sand, and fm gravel.			0.0		
16	SS-9	23-18-17-14 (35)	2.0/1.4'	179.6	Brownish gray (5YR 4/1), wet, soft; mf SAND, little silt, broken mica schist cobbles (possible sluff).			0.0		
18	SS-10	15-15-14-6 (29)	2.0/0.8'	179.0	Pale brown (5YR 5/2), wet, soft; mc SAND, mc subrounded weathered sandstone gravel,			0.0		
20	SS-11	6-5-5-5 (10)	2.0/0.6'	175.6	Dark yellowish brown (10YR 4/2), wet, medium dense; mc SAND, little mc subrounded gravel.			0.0		
22	SS-12	7-9-12-8 (21)	2.0/1.1'	173.6	some quartzite cobbles			0.0		
24	SS-13	11-8-5-3 (13)	2.0/0.6'	172.6	End of Borehole at 25.0'.			0.0		
26										
28										
30										

Report Name: NEW OBG BORING LOG - NO USCS Data Template: OBG GINT STD US BC.GDT

Notes: Soil descriptions taken from MW-8SB. 0.010" Slot Screen: 15-25 ft bgs; Riser: 0.5-15 ft bgs; #0 Sand: 13-25 ft bgs; Bentonite: 10-13 ft bgs; Grout: 1-10 ft bgs



BORING LOG

WELL NO. **MW-8SB**

PROJECT: Brownfield Cleanup Program No. C360115
CLIENT: One Holland Avenue Development, LLC.
INSPECTOR: Nate Vogan

SHEET 1 OF 2
JOB NO. 14206.47376
GROUND ELEV. 197.27

DRILLING CONTRACTOR: Parratt Wolff, Inc.
DRILLER: Glenn Lansing
PURPOSE: Remedial Investigation
DRILLING METHOD: Direct Push, HSA
DRILL RIG TYPE: CME 850

	SAMPLE	CORE	CASING
TYPE	SS	---	---
DIA.	2"	---	---

DATUM
DATE STARTED 10/6/2011
DATE FINISHED 10/10/2011

DEPTH (ft)	Sample Type	Number	Blows/6" (N Value)	Penetration/ Recovery	MATERIAL DESCRIPTION	Graphic Log	Stratum Change	Field Testing PID (ppm)	Well Graphic	REMARKS			
2	SS-1		2-6-3-7 (9)	2.0'/1.2'	Brownish black (5YR 2/1), moist, medium dense; mf SAND, little crushed brick, f gravel and coal fragements.	[Cross-hatched pattern]	FILL	0.0	[Well diagram]				
	SS-2		21-50/0.3 (>50)	0.9'/0.6'	195.0 2.3 Crushed amphibolite cobble					0.0			
4					193.3 4.0					0.0			
	SS-3		18-8-9-7 (17)	2.0'/1.2'	Brownish black (5YR 2/1), moist to dry, medium dense; mf SAND, some coal fragments, crushed mica schist, trace crushed brick and glass.					0.0			
6										0.0			
	SS-4		50/0.3 (>50)	0.3'/0.9'						0.0			
8					189.3 8.0 Creosol odor					0.0			
10										0.0			
	SS-5		16-11-17-16 (28)	2.0'/1.0'						0.0			
12					187.3 10.0 Brownish black (5YR 2/1), moist to dry; mf SAND, some coal and woody fragments, large crushed mica schist cobble.					0.0			
	SS-6		21-18-15-13 (33)	2.0'/1.3'						0.0			
14					184.4 12.9 Brownish gray (5YR 4/1), moist, medium dense; mf SAND, little silt, trace woody fragments.			[Dotted pattern]		SAND	0.0		
	SS-7		10-12-7-7 (19)	2.0'/1.5'								0.0	
16					182.9 14.4 Brownish gray (5YR 4/1) to dark yellowish brown (10YR 4/2), wet, soft to medium dense; m SAND increasing to c sand at 14.4, trace mc subrounded gravel.							0.0	
	SS-8		3-3-7-12 (10)	2.0'/1.1'								0.0	
18					181.3 16.0 Dark yellowish brown (10YR 4/2), wet, soft; c SAND and GRAVEL, little m sand, and fm gravel.	[Pattern with circles]	SAND & GRAVEL		0.0				
	SS-9		23-18-17-14 (35)	2.0'/1.4'							0.0		
20					179.3 18.0 178.7 18.6 Brownish gray (5YR 4/1), wet, soft; mf SAND, little silt, broken mica schist cobbles (possible sluff).						0.0		
	SS-10		15-15-14-6 (29)	2.0'/0.8'							0.0		
22					175.3 22.0 Pale brown (5YR 5/2), wet, soft; mc SAND, mc subrounded weathered sandstone gravel,						0.0		
	SS-11		6-5-5-5 (10)	2.0'/0.6'							0.0		
24					173.3 24.0 Dark yellowish brown (10YR 4/2), wet, medium dense; mc SAND, little mc subrounded gravel.				0.0				
	SS-12		7-9-12-8 (21)	2.0'/1.1'					0.0				
26					171.3 26.0 171.1 26.2 some quartzite cobbles Pale yellowish brown (10YR 6/2), wet, soft; SILT and f sand.		0.0						
	SS-13		11-8-5-3 (13)	2.0'/0.6'			0.0						
28					Moderate yellowish brown (10YR 5/4), wet, medium dense; m SAND, some c sand, little f gravel.		0.0						
	SS-14		3-4-6-8 (10)	2.0'/0.7'			0.0						
30					167.3 30.0		0.0						
	SS-15		12-6-5-7 (11)	2.0'/0.4'			0.0						

Report Name: NEW OBG BORING LOG - NO USCS Data Template: OBG GINT STD US BC.GDT

Notes: 0.010" Slot Screen: 45-55 ft bgs; Riser: 0.5-45 ft bgs; #0 Sand: 43-55 ft bgs; Bentonite: 40-43 ft bgs; Grout: 1-40 ft bgs



BORING LOG

WELL NO. **MW-8SB**

PROJECT: Brownfield Cleanup Program No. C360115
CLIENT: One Holland Avenue Development, LLC.
INSPECTOR: Nate Vogan

SHEET 2 OF 2

JOB NO. 14206.47376

DEPTH (ft)	Sample Type	Number	Blows/6" (N Value)	Penetration/ Recovery	MATERIAL DESCRIPTION	Graphic Log	Stratum Change	Field Testing PID (ppm)	Well Graphic	REMARKS
32	SS-16		6-12-50/0.3 (>50)	1.3'/0.9'	166.6 Moderate yellowish brown (10YR 5/4), wet, medium dense; mf SAND, little silt.	30.7	TILL	0.0		
					165.3 Very pale orange (10YR 8/2), wet, dense; mc SAND, little silt and clay, trace mc gravel.	32.0				
34	SS-17		23-42-50/0.3 (>50)	1.3'/0.6'	162.3 Very pale orange (10YR 8/2), wet, dense; mc SAND matrix supporting c angular cobblesand fmc gravel, trace silt and clay.	35.0		0.0		
36					Roller bit to 40 ft for casing install, no samples taken.					
40					157.3	40.0	INWOOD MARBLE			Penetration Rate = 10.2 min/ft
42	RC-1		()	5.0'	MARBLE; very light gray (N8), medium to coarse grained, highly fractured, hard, inclined bedding; greenish gray (5G 6/1) banding and medium dark gray (N4) chert nodules; high angle fractures at 41.0 (weath), 41.5 (mech), 42.0 (weath), 43.0 (mech), 43.6 (weath); vertical fractures at 41.6 (mech), 47.1 (weath); horizontal fractures at 40.2 (mech), 40.3 (mech), 42.5 (mech).					
46	RC-2		()	5.0'	152.3 MARBLE; very light gray (N8) to pale brown (5Y 5/2), coarse grained, hard, inclined bedding; highly fractured with clay seams, some pyrite and possible garnets, becoming darker with higher mineral occurrences at 46.1; High angle fractures at 45.2 (mech), 45.4-46.0 (weath), 46.1 (mech), 46.4 (mech, break on mineralized plane), 47.0 (weath), 47.4 (weath), 47.6 (mech), 47.9 (weath), 48.0 (mech), 48.1 (mech), 48.2 (mech); Shattered 48.5-48.9 (weath), 49.2-49.3 (weath).	45.0				Penetration Rate = 4.6 min/ft
50					147.3	50.0				Penetration Rate = 4.6 min/ft
52	RC-3		()	5.0'	MARBLE; very light gray (N8) to pale brown (5Y 5/2), coarse grained, hard, inclined bedding, slightly fractured; very mineral rich 50-52.2, some mica reprecipitation in fractures; High angle fracture at 51.0 (mech), 52.2 (weath), 53.5 (mech), 53.9 (mech); Horizontal fracture at 52.9 (mech) and 54.1 (mech).					
56					142.3 Refusal at 35.3'. End of Borehole at 55.0'.	55.0				

Report Name: NEW OBG BORING LOG - NO USCS Data Template: OBG GINT STD US BC.GDT



BORING LOG

WELL NO. **MW-9**

PROJECT: Brownfield Cleanup Program No. C360115
CLIENT: One Holland Avenue Development, LLC.
INSPECTOR: Nate Vogan

SHEET 1 OF 1
JOB NO. 14206.47376
GROUND ELEV. 201.31

DRILLING CONTRACTOR: Parratt Wolff, Inc.
DRILLER: Glenn Lansing
PURPOSE: Remedial Investigation
DRILLING METHOD: Direct Push, HSA
DRILL RIG TYPE: CME 850

	SAMPLE	CORE	CASING
TYPE	SS	---	---
DIA.	2"	---	---

DATUM
DATE STARTED 10/12/2011
DATE FINISHED 10/13/2011

DEPTH (ft)	Sample Type	Number	Blows/6" (N Value)	Penetration/ Recovery	MATERIAL DESCRIPTION	Graphic Log	Stratum Change	Field Testing PID (ppm)	Well Graphic	REMARKS
2	SS-1	NA-18-45-35 (69)	2.0'/1.7'	199.3		[Cross-hatched pattern]	FILL	1.5	[Well diagram]	
4	SS-2	25-36-50/0.4 (>86)	1.4'/0.4'					0.3		
6	SS-3	16-8-10-19 (18)	2.0'/0.9'					3.9		
8	SS-4	28-50/0.4 (>50)	0.9'/0.7'					0.1		
10	SS-5	3-4-4-3 (8)	2.0'/0.4'					1.3		
12	SS-6	5-21-32-16 (53)	2.0'/0.7'					1.4		
14	SS-7	41-34-15-14 (49)	2.0'/1.2'	187.3				0.0		
16	SS-8	15-5-7-7 (12)	2.0'/0.9'					0.0		
18	SS-9	5-6-8-8 (14)	2.0'/1.7'	183.3				0.1		
20	SS-10	7-6-6-5 (12)	2.0'/1.2'					0.0		
22	SS-11	4-6-8-9 (14)	2.0'/2.0'					0.0		
24	SS-12	7-9-9-8 (18)	2.0'/2.0'					0.0		
26	SS-13	4-2-2-5 (4)	2.0'/1.7'	176.6 176.3				0.1		
28										
30										

Report Name: NEW OBG BORING LOG - NO USCS Data Template: OBG GINT STD US BC.GDT

Notes: Soil descriptions taken from MW-9SB. 0.010" Slot Screen: 15-25 ft bgs; Riser: 0.5-15 ft bgs; #0 Sand: 13-25 ft bgs; Bentonite: 10-13 ft bgs; Grout: 1-10 ft bgs



BORING LOG

WELL NO. **MW-9SB**

PROJECT: Brownfield Cleanup Program No. C360115
CLIENT: One Holland Avenue Development, LLC.
INSPECTOR: Nate Vogan

SHEET 1 OF 2
JOB NO. 14206.47376
GROUND ELEV. 201.33

DRILLING CONTRACTOR: Parratt Wolff, Inc.
DRILLER: Glenn Lansing
PURPOSE: Remedial Investigation
DRILLING METHOD: Direct Push, HSA
DRILL RIG TYPE: CME 850

	SAMPLE	CORE	CASING
TYPE	SS	---	---
DIA.	2"	---	---

DATUM
DATE STARTED 10/11/2011
DATE FINISHED 10/13/2011

DEPTH (ft)	Sample Type	Number	Blows/6" (N Value)	Penetration/ Recovery	MATERIAL DESCRIPTION	Graphic Log	Stratum Change	Field Testing PID (ppm)	Well Graphic	REMARKS
2	SS-1	NA-18-45-35 (69)	2.0'/1.7'		200.8 Asphalt			1.5		
2	SS-2	25-36-50/0.4 (>86)	1.4'/0.4'		Grayish brown (5YR 3/2), dry, dense; f SAND and SILT supporting 1" angular crushed stone.			0.3		
4					199.3					
4	SS-3	16-8-10-19 (18)	2.0'/0.9'		Grayish brown (5YR 3/2), dry, dense; fmc SAND, little crushed brick and stone.			3.9		
6	SS-4	28-50/0.4 (>50)	0.9'/0.7'		197.3 crushed cobble in spoon nose			0.1		
6					195.3 crushed cobble in spoon nose					
8					193.3 crushed cobbles			1.3		
8	SS-5	3-4-4-3 (8)	2.0'/0.4'					1.4		
10	SS-6	5-21-32-16 (53)	2.0'/0.7'					0.0		
12	SS-7	41-34-15-14 (49)	2.0'/1.2'							
14	SS-8	15-5-7-7 (12)	2.0'/0.9'		187.3 Moderate brown (5YR 3/4), moist, medium dense; mf SAND, trace mc subrounded gravel.			0.0		
16	SS-9	5-6-8-8 (14)	2.0'/1.7'		184.8 wet at 16.5 ft bgs			0.1		
18	SS-10	7-6-6-5 (12)	2.0'/1.2'		183.3 Moderate brown (5YR 4/4) to moderate yellowish brown (10YR 5/4), saturated, medium dense; mf SAND, little c sand, trace mc subrounded gravel.			0.0		
20	SS-11	4-6-8-9 (14)	2.0'/2.0'					0.0		
22	SS-12	7-9-9-8 (18)	2.0'/2.0'					0.0		
24	SS-13	4-2-2-5 (4)	2.0'/1.7'		176.6 Moderate yellowish brown (10YR 5/4), saturated, medium dense; fm SAND, trace c sand.			0.1		
26	SS-14	4-5-5-6 (10)	2.0'/2.0'					0.0		
28	SS-15	9-5-6-7 (11)	2.0'/1.7'					0.0		
30										

Report Name: NEW OBG BORING LOG - NO USCS Data Template: OBG GINT STD US BC.GDT

Notes: 0.010" Slot Screen: 46-56 ft bgs; Riser: 0.5-46 ft bgs; #0 Sand: 44-56 ft bgs; Bentonite: 41-44 ft bgs; Grout: 1-41 ft bgs

(Continued Next Page)



BORING LOG

WELL NO. **MW-9SB**

PROJECT: Brownfield Cleanup Program No. C360115
CLIENT: One Holland Avenue Development, LLC.
INSPECTOR: Nate Vogan

SHEET 2 OF 2

JOB NO. 14206.47376

DEPTH (ft)	Sample Type	Number	Blows/6" (N Value)	Penetration/ Recovery	MATERIAL DESCRIPTION	Graphic Log	Stratum Change	Field Testing PID (ppm)	Well Graphic	REMARKS
32	SS-16		5-9-6-6 (15)	2.0'/2.0'	Moderate yellowish brown (10YR 5/4), saturated, medium dense; fm SAND, trace c sand. <i>(continued)</i>		SAND	0.0		
34	SS-17		3-3-4-11 (7)	2.0'/1.2'	some silty seams at 32.8 and 33.3 ft bgs		SAND	0.0		
36	SS-18		8-9-50/0.2 (>59)	1.2'/0.8'	Pale yellowish brown (10YR 6/2), wet, very dense; fmc SAND supporting subangular cobbles, little silt and clay.		TILL	0.1		
36					No samples, roller bit to 40 ft bgs for rock socket.		TILL			
40					MARBLE; very light gray (N8), coarse grained, hard, inclined bedding; light gray (N7), horizontal fractures at 41.1 (mech), 41.7 (mech), 43.6 (mech), 43.9 (mech), 44.6 (mech).		INWOOD MARBLE			Penetration Rate = 5.6 min/ft
42	RC-1		0	5.0'			INWOOD MARBLE			
46					MARBLE; very light gray (N8), coarse grained, hard, inclined bedding; light gray (N7) banding and light brownish gray (5YR 6/1) from 45.3-46.9, pyrite at 48.0; horizontal fractures at 46.0 (mech), 47.2 (mech), 48.0 (mech), 49.4 (mech); Healed high angle fractures with slight weathering 45.2-45.3.		INWOOD MARBLE			Penetration Rate = 5.0 min/ft
48	RC-2		0	5.0'			INWOOD MARBLE			
50					MARBLE; very light gray (N8), coarse grained, hard, inclined bedding; medium light gray (N6) banding with light gray (N7) sections; High angle fractures with reprecipitation on bedding planes at 51.2, 52.5, 52.7; Horizontal fracture at 53.4 (mech); Weathered vein at 50.7.		INWOOD MARBLE			Penetration Rate = 5.4 min/ft
52	RC-3		0	5.0'			INWOOD MARBLE			
56	RC-4		0	1.0'	MARBLE; medium light gray (N6), coarse grained, hard, inclined bedding; light brownish gray banding; high angle fracture at 55.8 with soft fracture planes and reprecipitated minerals (calcite?).		INWOOD MARBLE			Penetration Rate = 5.0 min/ft
58					Refusal at 35.2'. End of Borehole at 56.0'.					

Report Name: NEW OBG BORING LOG - NO USCS Data Template: OBG GINT STD US BC.GDT



Date 4/20/11 Field Personnel Nvogan Weather ~50° overcast
 Site Name Feintool, NY Inc. Contractor Parrat-Wolff Project No. 14206/47376
 Site Location White Plains, NY Evacuation Method Grundfos Rediflow / Bailer

Well information:

Depth to Bottom (Initial)* 77.71 ft. Date(s) Installed 4/19/11 Date(s) Developed 4/20-4/21/11
 Depth to Bottom (Final)* 77.74 ft. Well condition Good, New Development Time Start: 0855
 Depth to Water (Initial)* 10.57 ft. Well Diameter 2 in. Stop: 1312
 Depth to Water (Final)* 74.6 ft. Casing Volume 12.7 gal.
 Length of Water Column (LWC) 67.14 ft. Air Monitoring PID Development Method Submersible pump/Bailer
 1 Well Volume (0.163xLWC) 10.9 gall. Pump setting* NA * Measuring point TOC
 (intake)

Well Volumes	Volume of Water Removed (Gallons)	Temperature °C	pH s.u	Conductivity (mS/cm or µS/cm)	Turbidity (NTU)	Approximate Flow Rate (gal/min)	Hydrometer	Depth to Water (ft.)
Start	1	13.8	9.04	0.35	120	NA	NA	NA
2	6	14.4	8.82	0.323	75	NA	NA	NA
3	9	15.7	8.75	0.346	250	NA	NA	NA
4 1	12	16.1	8.78	0.360	950	NA	NA	NA
5	15	16.1	8.66	0.337	>999	NA	NA	NA
6	15.5	14.7	10.04	0.367	16	NA	NA	NA
7 2.5	26	14.4	9.65	0.334	90	NA	NA	NA
8							NA	NA
9							NA	NA
10							NA	NA

Development Water Characteristics:

Total volume of Development water removed: 29 gallons
 Development Water Disposal Method: drum
 Physical appearance at start
 Color clear Physical appearance at end Color clear
 Odor no Odor no
 Sheen/Free Product no Sheen/Free Product no

NOTES: Switch to bailer on 4/21 for 2nd round of
purging
4/21 DTC (15.31)

Geologist Signature: _____



Date 4/20/11 Field Personnel Nvogan Weather 50° overcast
 Site Name Feintool, NY Inc. Contractor Parrat-Wolff Project No. 14206/47376
 Site Location White Plains, NY Evacuation Method Grundfos Rediflow / Bailer

Well information:

Depth to Bottom (Initial)* 54.41 ft. Date(s) Installed 4/19/11 Date(s) Developed 4/20
 Depth to Bottom (Final)* 54.41 ft. Well condition Good, New Development Time Start: 0943
 Depth to Water (Initial)* 16.39 ft. Well Diameter 2 in. Stop: 1032
 Depth to Water (Final)* 16.86 ft. Casing Volume 8.9 gal.
 Length of Water Column (LWC) 38.02 ft. Air Monitoring PID Development Method Submersible pump
 1 Well Volume (0.163xLWC) 6.2 gall. Pump setting* NA * Measuring point TOC
 (intake)

Well Volumes	Volume of Water Removed (Gallons)	Temperature °C	pH s.u	Conductivity mS/cm or µS/cm	Turbidity (NTU)	Approximate Flow Rate (gal/min)	Hydrometer	Depth to Water (ft.)
	2	14.4	8.97	0.180	280	NA	NA	NA
x 1	6	15.4	8.92	0.196	500	NA	NA	NA
x 2	12	15.8	8.64	0.250	200	NA	NA	NA
x	15	15.3	8.46	0.287	36	NA	NA	NA
x 3	18	15.2	8.40	0.290	35	NA	NA	NA
x	20	15.3	8.36	0.304	36	NA	NA	NA
x	22	15.3	8.30	0.316	20	NA	NA	NA
x 4	24	15.4	8.23	0.335	14	NA	NA	NA
x	25	15.3	8.22	0.336	11	NA	NA	NA
x	26	15.3	8.22	0.335	12	NA	NA	NA
18							NA	NA

Development Water Characteristics:

Total volume of Development water removed: 26 gallons

Development Water Disposal Method: Down

Physical appearance at start

Color slightly milky
 Odor none

Sheen/Free Product none

Physical appearance at end

Color clear
 Odor no

Sheen/Free Product no

NOTES:

Geologist Signature: _____



Date 4/20/11 Field Personnel Nvogon Weather ~50°, overcast
 Site Name Feintool, NY Inc. Contractor Parrat-Wolf Project No. 14206/47376
 Site Location White Plains, NY Evacuation Method Grundfos Rediflow / Bailer

Well information:

Depth to Bottom (Initial)* 97.80 ft. Date(s) Installed 4/19/11 Date(s) Developed 4/20 - 4/21/11
 Depth to Bottom (Final)* 97.82 ft. Well condition Good, New Development Time Start: 0812
 Depth to Water (Initial)* 6.09 ft. Well Diameter 2 in. Stop: 1220
 Depth to Water (Final)* 96.54 ft. Casing Volume 16 gal.
 Length of Water Column (LWC) 91.71 ft. Air Monitoring PID Development Method Submersible pump / bailer
 1 Well Volume (0.163xLWC) 15 gall. Pump setting* NA * Measuring point TOC
 (intake)

Well Volumes	Volume of Water Removed (Gallons)	Temperature °C	pH s.u	Conductivity <u>mS/cm or µS/cm</u>	Turbidity (NTU)	Approximate Flow Rate (gal/min)	Hydrometer	Depth to Water (ft.)
Start	2	12.6	9.77	0.282	200	NA	NA	NA
1	6	13.2	9.82	0.234	220	NA	NA	NA
2	10	14.6	9.86	0.213	95	NA	NA	NA
3	15	14.8	9.95	0.221	210	NA	NA	NA
4	16 (dry)	15.5	9.83	0.218	7999 200	NA	NA	NA
5	4/21 16.5	13.5	11.23	1.25	1.96 200	NA	NA	NA
6	29	12.8	11.23	0.97	60	NA	NA	NA
7							NA	NA
8							NA	NA
9							NA	NA
10							NA	NA

Development Water Characteristics:

Total volume of Development water removed: 30.5
 Development Water Disposal Method: Drum
 Physical appearance at start
 Color clear
 Odor none
 Sheen/Free Product none

Physical appearance at end
 Color clear
 Odor none
 Sheen/Free Product none

NOTES: Switch to bailer on 4/21 for 2nd well volume
4/21 DFL (17.39)

Geologist Signature: _____



Date 4/20/11 Field Personnel Nvogan Weather 50° overcast
 Site Name Feintool, NY Inc. Contractor Parrat-Wolff Project No. 14206/47376
 Site Location White Plains, NY Evacuation Method Grundfos Rediflow / Bailer

Well information:

Depth to Bottom (Initial)* 57.04 ft. Date(s) Installed 4/19/11 Date(s) Developed 4/20/11
 Depth to Bottom (Final)* 57.48 ft. Well condition Good, New Development Time Start: 1129
 Depth to Water (Initial)* 14.36 ft. Well Diameter 2 in. Stop: 1530
 Depth to Water (Final)* 53.14 ft. Casing Volume 9.4 gal.
 Length of Water Column (LWC) 42.68 ft. Air Monitoring PID Development Method Submersible pump
 1 Well Volume (0.163xLWC) 7.0 gall. Pump setting* NA * Measuring point TOC
 (intake)

Well Volumes	Volume of Water Removed (Gallons)	Temperature °C	pH s.u	Conductivity mS/cm or µS/cm	Turbidity (NTU)	Approximate Flow Rate (gal/min)	Hydrometer	Depth to Water (ft.)
Start	2	12.4	9.19	0.182	7999	NA	NA	NA
* 1	7	14.5	9.52	0.197	190	NA	NA	NA
2 2	14	13.9	8.11	0.720	2999	NA	NA	NA
* 3	21	14.9	7.85	0.95	70	NA	NA	NA
* 4							NA	NA
* 5							NA	NA
* 6							NA	NA
* 7							NA	NA
* 8							NA	NA
* 9							NA	NA
* 10							NA	NA

Development Water Characteristics:

Total volume of Development water removed: 21 gallons
 Development Water Disposal Method: drum

Physical appearance at start

Color milky white
 Odor no
 Sheen/Free Product no

Physical appearance at end

Color clear
 Odor no
 Sheen/Free Product no

NOTES:

cycle and purge pump allowing recharge of screen
interval, takes ~ 30 minutes for 10 ft recharge

Geologist Signature: _____



Date 8/13/11 Field Personnel N. Vogan Weather ~75° sunny
 Site Name OHAD Brownfields Contractor Parrott-Wolff Project No. 47376-001-400
 Site Location 7-11 Holland Evacuation Method ~~shower~~ bailer

Well information:

Depth to Bottom (Initial) * 23.71 ft. Date(s) Installed 8/2/11 Date(s) Developed 8/13/11
 Depth to Bottom (Final)* _____ ft. Well condition new Development Time Start: 1032
 Depth to Water (Initial)* 16.28 ft. Well Diameter 2 in. Stop: 1130
 Depth to Water (Final)* _____ ft. Casing Volume 3.9 gal.
 Length of Water Column (LWC) 7.43 ft. Air Monitoring NA Development Method Bail
 1 Well Volume (0.163xLWC) 1.2 gall. Pump setting* NA * Measuring point TOIC
 (intake)

Well Volumes	Volume of Water Removed (Gallons)	Temperature °C	pH s.u	Conductivity mS/cm	Turbidity (NTU)	Approximate Flow Rate (gal/min)	Hydrometer	Depth to Water (ft.)
Start	0	NA	7.95	1.07	2320	NA	NA	17.11
1	1.2	NA	7.97	1.02	2671	NA	NA	18.89
LWC 2	2.4	NA	8.14	0.854	2532	NA	NA	21.54
3	3.6	NA	8.17	0.894	1916	NA	NA	20.72
4								
5								
6								
7								
8								
9								
10								

Development Water Characteristics:

Total volume of Development water removed: 4 gallons
 Development Water Disposal Method: Drum
 Physical appearance at start
 Color turbid brown Physical appearance at end
 Color slightly turbid
 Odor no Odor no
 Sheen/Free Product no Sheen/Free Product no

NOTES: Sample taken for VO (volatiles) at 1200
MW-6-080311

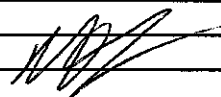
 Geologist Signature: 



WELL DEVELOPMENT LOG

Well ID: MW-6513

Date	<u>8/2/11</u>	Field Personnel	<u>N. Vogan</u>	Weather	<u>~80° sunny</u>
Site Name	<u>OHAD Brownfields</u>	Contractor	<u>Parratt-Volk</u>	Project No.	<u>47376-001-400</u>
Site Location	<u>7-11 Holland</u>	Evacuation Method	<u>Submersible Pump</u>		

Well Information:

Depth to Bottom (Initial)*	<u>51.31</u> ft.	Date(s) Installed	<u>8/1/11</u>	Date(s) Developed	<u>8/2/11</u>
Depth to Bottom (Final)*	<u>51.39</u> ft.	Well condition	<u>New</u>	Development Time	<u>Start: 1156</u>
Depth to Water (Initial)*	<u>16.67</u> ft.	Well Diameter	<u>2</u> in.		<u>Stop: 1243</u>
Depth to Water (Final)*	<u>16.67</u> ft.	Casing Volume	<u>8.4</u> gal.		
Length of Water Column (LWC)	<u>34.64</u> ft.	Air Monitoring	<u>NA</u>	Development Method	<u>Submersible pump</u>
1 Well Volume (0.163xLWC)	<u>5.6</u> gall.	Pump setting* (intake)	<u>110-120 ft</u>	* Measuring point	<u>TOIC</u>

Well Volumes	Volume of Water Removed (Gallons)	Temperature	pH s.u.	Conductivity mS/cm	Turbidity (NTU)	Approximate Flow Rate (gal/min)	Hydrometer	Depth to Water (ft.)
Start	0	NA	-	-	-	-	NA	17.51
1	5.6	NA	7.44	0.497	2272	0.4	NA	18.20
2	11.2	NA	7.81	0.421	201	0.6	NA	18.40
3	16.8	NA	8.05	0.411	129	0.7	NA	18.80
4	22.4	NA	8.08	0.425	60.1	0.6	NA	18.80
5	28.0	NA	8.15	0.438	32.6	0.6	NA	18.90
6								
7								
8								
9								
10								

Development Water Characteristics:

Total volume of Development water removed: 30 gallons
 Development Water Disposal Method: Drum

Physical appearance at start

Color slightly cloudy
 Odor no
 Sheen/Free Product no

Physical appearance at end

Color clear
 Odor no
 Sheen/Free Product no

NOTES:

Sample for Vol (volatiles) taken on 8/13/11 w/ bailer
- MW-65R-080311

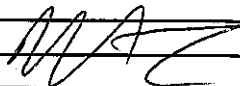
Geologist Signature: 



Date	<u>10/11/11</u>	Field Personnel	<u>Nvogan</u>	Weather	<u>65° cloudy</u>
Site Name	<u>OHAD - Brownfields</u>	Contractor	<u>Parratt-Wolff</u>	Project No.	<u>14206.47376</u>
Site Location	<u>White Plains, NY</u>	Evacuation Method	<u>Whale Pump</u>		

Well information:

Depth to Bottom (Initial) *	<u>24.06</u> ft.	Date(s) Installed	<u>10/5/11</u>	Date(s) Developed	<u>10/11/11</u>
Depth to Bottom (Final)*		Well condition	<u>Good, New</u>	Development Time	<u>Start: 1325</u>
Depth to Water (Initial)*	<u>13.98</u> ft.	Well Diameter	<u>2 in.</u>		<u>Stop: 1340</u>
Depth to Water (Final)*		Casing Volume			
Length of Water Column (LWC)	<u>10.08</u> ft.	Air Monitoring	<u>PID</u>	Development Method	<u>Submersible pump</u>
1 Well Volume (1.469xLWC)	<u>1.64</u> gall.	Pump setting* (intake)	<u>NA</u>	* Measuring point	<u>TOC</u>

Well Volumes	Volume of Water Removed (Gallons)	Temperature °C	pH s.u	Conductivity (mS/cm or µS/cm)	Turbidity (NTU)	Approximate Flow Rate (gal/min)	Hydrometer	Depth to Water (ft.)
Start	5	17.10	6.04	0.821	300	4	-	14.66
1	15	16.14	7.11	0.879	170	4	-	15.15
2	25	17.09	6.49	-	250	4	-	15.15
3	40	15.77	7.24	0.913	14	4	-	15.15
4								
5								
6								
7								
8								
9								
10								

Development Water Characteristics:

Total volume of Development water removed: 40 gallons

Development Water Disposal Method: Drummed for off site

Physical appearance at start	Physical appearance at end
Color <u>cloudy brown</u>	Color <u>clear</u>
Odor <u>no</u>	Odor <u>no</u>
Sheen/Free Product <u>no</u>	Sheen/Free Product <u>no</u>

NOTES:

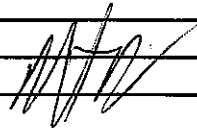
Geologist Signature: 

Date 10/11/11 Field Personnel Nvogon Weather 65° mcloudy
 Site Name OHAD - Brownfields Contractor Parratt-Wolff Project No. 14206.47376
 Site Location White Plains, NY Evacuation Method Whale Pump

Well information:

Depth to Bottom (Initial)* 53.48 ft. Date(s) Installed 10/5/11 Date(s) Developed 10/11 - 10/12
 Depth to Bottom (Final)* _____ ft. Well condition Good, New Development Time Start: 1535 10/11
 Depth to Water (Initial)* 13.17 ft. Well Diameter 2 in. Stop: 1630 10/12
 Depth to Water (Final)* _____ ft. Casing Volume _____ gal.
 Length of Water Column (LWC) 40.31 ft. Air Monitoring PID Development Method Submersible pump
 1 Well Volume (1.469xLWC) 6.5 gall. Pump setting* NA * Measuring point TOC
 (intake)

Well Volumes	Volume of Water Removed (Gallons)	Temperature °C	pH s.u	Conductivity <u>mS/cm or µS/cm</u>	Turbidity (NTU)	Approximate Flow Rate (gal/min)	Hydrometer	Depth to Water (ft.)
Start	5	16.43	8.24	0.301	7999	4	—	50.3
1 ^{10/12}	11.5				7999	4		32.16
2	18.5				26	4		35.41
3								
4								
5								
6								
7								
8								
9								
10								

Development Water Characteristics:

Total volume of Development water removed: 18.5 gallons
 Development Water Disposal Method: drum for offsite disposal
 Physical appearance at start Physical appearance at end
 Color milky white Color clear
 Odor no Odor no
 Sheen/Free Product no Sheen/Free Product no

NOTES: page dry 3 times, Horiba malfunctioning on 10/12 no
WQ measurements

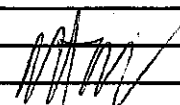
Geologist Signature: 



Date 10/12/11 Field Personnel Nvogan Weather 55° overcast
 Site Name OHAD - Brownfields Contractor Parratt-Wolff Project No. 14206.47376
 Site Location White Plains, NY Evacuation Method Whale Pump

Well information:

Depth to Bottom (Initial)* 24.50 ft. Date(s) Installed 10/11/11 Date(s) Developed 10/12/11
 Depth to Bottom (Final)* _____ ft. Well condition Good, New Development Time Start: 1155
 Depth to Water (Initial)* 9.78 ft. Well Diameter 2 in. Stop: 1235
 Depth to Water (Final)* _____ ft. Casing Volume _____ gal.
 Length of Water Column (LWC) 14.72 ft. Air Monitoring PID Development Method Submersible pump
 1 Well Volume (1.469xLWC) 2.4 gall. Pump setting* NA * Measuring point TOC
 (intake)

Well Volumes	Volume of Water Removed (Gallons)	Temperature °C	pH s.u	Conductivity mS/cm or µS/cm	Turbidity (NTU)	Approximate Flow Rate (gal/min)	Hydrometer	Depth to Water (ft.)
Start	10				7999	4		
1	20				600	4		
2	30				170	4		
3	40				34	4		
4								
5								
6								
7								
8								
9								
10								

Development Water Characteristics:

Total volume of Development water removed: 40 gallons

Development Water Disposal Method: _____

Physical appearance at start

Color cloudy brown

Odor no

Sheen/Free Product no

Physical appearance at end

Color clear

Odor no

Sheen/Free Product no

NOTES:

Horiba Malfunctioning / no LWC measurements

Geologist Signature: _____



Date	<u>10/12/11</u>	Field Personnel	<u>Nvogan</u>	Weather	<u>55° overcast</u>
Site Name	<u>OHAD - Brownfields</u>	Contractor	<u>Parratt-Wolff</u>	Project No.	<u>14206.47376</u>
Site Location	<u>White Plains, NY</u>	Evacuation Method	<u>Whale Pump</u>		

Well Information:

Depth to Bottom (Initial) *	<u>59.11</u> ft.	Date(s) Installed	<u>10/10/11</u>	Date(s) Developed	<u>10/12/11</u>
Depth to Bottom (Final)*		Well condition	<u>Good, New</u>	Development Time	<u>Start: 0905</u>
Depth to Water (Initial)*	<u>10.01</u> ft.	Well Diameter	<u>2 in.</u>		<u>Stop: 1007</u>
Depth to Water (Final)*		Casing Volume			
Length of Water Column (LWC)	<u>49.1</u> ft.	Air Monitoring	<u>PID</u>	Development Method	<u>Submersible pump</u>
1 Well Volume (1.469xLWC)	<u>7.2</u> gall.	Pump setting* (intake)	<u>NA</u>	* Measuring point	<u>TOC</u>

Well Volumes	Volume of Water Removed (Gallons)	Temperature °C	pH s.u	Conductivity (mS/cm or µS/cm)	Turbidity (NTU)	Approximate Flow Rate (gal/min)	Hydrometer	Depth to Water (ft.)
Start	1.5	15.12	8.17	0.786	>999	~.7	-	19.68
1	5	15.07	8.17 9.04	0.632	800	.7	-	-
2	7	16.03	8.17 8.92	0.907	450	.7	-	-
3	12	15.60	8.29	1.50	140	.7	-	-
4	15	15.14	7.87	1.64	100	.7	-	-
5	18	15.18	8.16	1.48	80	.7	-	-
6	25	15.12	7.87	1.79	65	.7	-	-
7	35	14.95	7.89	1.65	31	.7	-	-
8								
9								
10								

Development Water Characteristics:

Total volume of Development water removed: 35 gallons

Development Water Disposal Method: dump for offsite disposal

Physical appearance at start	Physical appearance at end
Color <u>milky white</u>	Color <u>clear</u>
Odor <u>no</u>	Odor <u>no</u>
Sheen/Free Product <u>no</u>	Sheen/Free Product <u>no</u>

NOTES:

~~Submersible pump used for development~~

Geologist Signature: 



Date: 10/13/11 Field Personnel: Nvogan Weather: 60° L Rain
 Site Name: OHAD - Brownfields Contractor: Parratt-Wolff Project No.: 14206.47376
 Site Location: White Plains, NY Evacuation Method: Whale Pump

Well information:

Depth to Bottom (Initial)* 26.00 ft. Date(s) Installed: 10/12/11 Date(s) Developed: 10/13/11
 Depth to Bottom (Final)* _____ ft. Well condition: Good, New Development Time: Start: 1315
 Depth to Water (Initial)* 14.65 ft. Well Diameter: _____ 2 in. Stop:
 Depth to Water (Final)* _____ ft. Casing Volume: _____ gal.
 Length of Water Column (LWC) 16.35 ft. Air Monitoring: PID Development Method: Submersible pump
 1 Well Volume (1.469xLWC) 1.85 gall. Pump setting*: NA * Measuring point: TOC
 (intake)

Well Volumes	Volume of Water Removed (Gallons)	Temperature °C	pH s.u	Conductivity <u>mS/cm</u> or µS/cm	Turbidity (NTU)	Approximate Flow Rate (gal/min)	Hydrometer	Depth to Water (ft.)
Start	5	16.93	8.21	1.18	7999	4	-	17.62
1	15	15.98	7.66	1.17	7999	4	-	17.81
2	30	15.79	7.53	1.01	160	4	-	17.02
3	45	15.76	7.60	0.818	34	4	-	17.01
4								
5								
6								
7								
8								
9								
10								

Development Water Characteristics:

Total volume of Development water removed: 60 gallons
 Development Water Disposal Method: Drum for off site disposal
 Physical appearance at start: Color cloudy green Physical appearance at end: Color clear
 Odor: no Odor: no
 Sheen/Free Product: no Sheen/Free Product: no

NOTES:

Developed prior to adding gravel

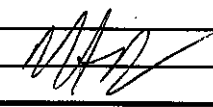
 Geologist Signature: 



Date 10/13/11 Field Personnel Nvogan Weather 60° & Rain
 Site Name OHAD - Brownfields Contractor Parratt-Wolff Project No. 14206.47376
 Site Location White Plains, NY Evacuation Method Whale Pump

Well information:

Depth to Bottom (Initial)* 56.00 ft. Date(s) Installed 10/13/11 Date(s) Developed 10/13/11
 Depth to Bottom (Final)* _____ ft. Well condition Good, New Development Time Start: 1245
 Depth to Water (Initial)* 14.62 ft. Well Diameter 2 in. Stop: 1315
 Depth to Water (Final)* _____ ft. Casing Volume _____ gal.
 Length of Water Column (LWC) 41.38 ft. Air Monitoring PID Development Method Submersible pump
 1 Well Volume (1.469xLWC) 6.7 gall. Pump setting* NA * Measuring point TOC
 (intake)

Well Volumes	Volume of Water Removed (Gallons)	Temperature °C	pH s.u	Conductivity mS/cm or µS/cm	Turbidity (NTU)	Approximate Flow Rate (gal/min)	Hydrometer	Depth to Water (ft.)
Start	1	-	-	-	>999	~.4	-	-
1	5	-	-	-	>999	.4	-	-
2	10	-	-	-	140	.4	-	-
3								
4								
5								
6								
7								
8								
9								
10								

Development Water Characteristics:

Total volume of Development water removed: 15 gallons
 Development Water Disposal Method: drum for offsite disposal
 Physical appearance at start Physical appearance at end
 Color milky white Color sl. cloudy
 Odor no Odor no
 Sheen/Free Product no Sheen/Free Product no

NOTES:

auge well dry
- no water quality other than turbidity
- develop w/ sandpack installed, no grout
- will redevelop w/ bailer prior to sampling
- recharge at 51ml/min
 Geologist Signature:

Field Activities Plan

F-1 GROUNDWATER SAMPLING

Pre-sampling

Prior to each sampling event, a complete round of ground water elevations will be recorded from the monitoring well network noted in section 3.3.1. An electronic water level probe will be used to measure the depth to water in each well. The depth to water will be measured to the nearest 0.01 foot from the surveyed points on the well casings. The depth to water measurements will be recorded in the field logbook. In addition to the depth to water measurements, the condition of the wells protective casings and locks, and each well head will also be recorded in the field logbook.

Passive-Diffusion Bag Sampler Installation/Retrieval

- Step 1 - Don appropriate personal protective equipment (as required by the Health and Safety Plan, Appendix D).
- Step 2 - Measure the depth to water. If a complete round of water level measurements were obtained prior to conducting the ground water sampling event, redundant water-level measurements do not need to be collected at the actual time of sampling.
- Step 3 - Remove the appropriate passive-diffusion bag sampler from the shipping container. Passive-diffusion bag samplers will be purchased from a licensed commercial supplier.
- Step 4 - Attach the de-ionized water-filled polyethylene bag to the line of the well-specific passive bag holder or the dedicated holder using the stainless-steel snap hooks. The position of the bag(s) on the well-specific holders will be such that when installed they hang at the center of the screened interval submerged.
- Step 5 - Slowly lower the passive bag sampler down the well until the stainless-steel weight reaches the bottom of the well indicating that the sampler is properly positioned in the screened interval. The passive bag sampler will be positioned adjacent to the midpoint of the well screen.
- Step 6 - Secure the line extending above the top of the well riser pipe either to the steel casing or the locking cap.
- Step 7 - Close and lock the well.
- Step 8 - Record the date and time of placement of the passive bag sampler in the well in the field log book.
- Step 9 - Allow an equilibration period of 14 days or more before retrieving the passive-diffusion bag. If necessary, the well may be accessed briefly during the equilibration period (*e.g.*, to obtain fluid water level measurements), provided that the line remains at the top of the well casing throughout the equilibration period, which should be a minimum of 14 days.
- Step 10 - After the equilibration period, unlock and open the well and slowly remove the passive-diffusion bag sampler from the monitoring well. Remove the sample-filled polyethylene bag from the stainless-steel snap hooks and dry with a clean paper towel. Cut a small hole in the sample-filled polyethylene bag using a decontaminated knife or decontaminated stainless-steel scissors. Pour water from the bag directly into appropriate laboratory sample containers.
- Step 11 - Complete the sample label and place sample container in a cooler containing wet ice.
- Step 12 - Submit samples to a NYS ELAP certified laboratory under Chain of Custody procedures. Samples shall be packed on ice and be transported with one trip blank per cooler.

F-2 WELL REPLACEMENT

Installation of new wells or reinstallation of decommissioned wells will occur as follows:

OVERBURDEN WELLS

Drilling for overburden monitoring well installations will be conducted using a truck-mounted drill rig. The boreholes will be advanced using 4¼-inch inside diameter (I.D.) hollow stem augers with continuous soil sampling. The overburden wells will be installed to replicate the well being replaced, or to screen to a pre-determined interval based on the monitoring well intent. Each soil sample will be described as to its color, moisture content, density, grain-size distribution, and sample recovery. This descriptive information will be recorded on boring logs. An example boring log is included in Exhibit B. Soil samples from the borings will also be screened for the presence of VOCs using a portable photoionization detector (PID). The PID screening information will be recorded on the boring logs.

The overburden monitoring wells will be constructed as 2-inch diameter schedule 40 PVC wells consisting of a 10-ft length of 0.010-inch (or appropriate) slot screen flush-threaded to riser casing. The riser casings will be extended to ground surface. A sandpack suitable for use with the screen slot size will be installed within the annular space between the borehole and the well. The sandpack will extend from the bottom of the well to 1-ft to 2-ft above the top of the well screen. A minimally 2-ft thick bentonite seal will be installed in the annular space above the sand pack. The remaining annular space will be filled with a Portland cement/bentonite grout. The grout will extend to approximately 1-ft below grade. Approximately 0.5-ft of sand will be placed on top of the grout. Wellhead completion will include the installation of a flush mounted protective casing/road box. A concrete pad will be installed around the well to direct surface runoff away from the top of the wellhead.

BEDROCK WELLS

Drilling for bedrock monitoring well installations will be conducted using a truck-mounted drill rig. The boreholes through the overburden will be advanced using 6¼-inch inside diameter (I.D.) hollow stem augers with continuous soil sampling to the top of the bedrock. Each soil sample will be described as to its color, moisture content, density, grain-size distribution, and recovery, and screened using a PID. This descriptive information will be recorded on boring logs.

Upon reaching the top of bedrock, the boreholes will be advanced approximately 2 ft into bedrock. The boreholes will be advanced using a 5⅞-inch roller bit through the augers. A 4-inch diameter steel casing will be lowered through the auger string. The annular space between the borehole wall and the 4-inch casing will be filled with cement/bentonite grout using a tremie pipe as the auger string is removed. The grout will be allowed to cure for a minimum of 24 hours prior to further borehole advancement.

Subsequent to curing of the grout, coring drilling methods will be used to extend the boreholes to the terminal depths. Fluids and cuttings that are carried to the ground surface will be managed according to Section 3 of the FAP. The volume of drilling water lost to the bedrock formation, if any, will be recorded. The bedrock cores will be described in a core log to include at a minimum rock description, RQD, drill breaks, and fracture correlation.

Subsequent to reaching the terminal depth for the bedrock boreholes, a 2-inch diameter schedule 40 PVC well consisting of a 10-ft length of 0.010-inch (or appropriate) slot screen flush-threaded to riser casing will be lowered through the 4-inch casing. The riser casing will be extended to ground surface. A sandpack suitable for use with the screen slot size will be installed within the annular space between the borehole and the well. The sandpack will extend from the bottom of the well to 1-ft to 2-ft above the top of the well screen. A minimally 2-ft thick bentonite seal will be installed in the annular space above the sand pack. The remaining annular space will be filled with a Portland cement/bentonite grout through a tremie pipe. The grout will extend to approximately 1-ft below grade. Approximately 0.5-ft of sand will be placed on top of the grout. Wellhead completion will include the installation of a flush mounted protective casing/road box. A concrete pad will be installed around the well to direct surface runoff away from the top of the wellhead.

WELL DEVELOPMENT

The newly installed monitoring wells will be developed no sooner than 24 hours following installation. Well development will consist of alternately surging and pumping each well to remove the fine material which may have settled in the monitoring wells, to remove introduced drilling fluids, and to provide better hydraulic communication with the surrounding formation. For bedrock wells, a minimum of 1.5 times the volume of drilling water lost to the bedrock formation will be removed. A development goal where temperature, conductivity, and pH have stabilized and a turbidity of 50 Nephelometric Turbidity Units (NTUs) has been achieved will be established. If this goal cannot be achieved within a reasonable timeframe, the current environmental professional will be notified, and discussions will be implemented with NYSDEC to establish a mutually agreeable development volume.

F-3 INVESTIGATION DERIVED WASTE

Site field activities will produce investigation-derived wastes (IDW) which will require appropriate management. IDW includes the following:

- Drill cuttings;
- Ground water resulting from development of new monitoring wells;
- Ground water resulting from the sampling of the monitoring wells;
- Decontamination fluids resulting from decontamination of the drill rig and ground water sampling pump; and
- Personnel protective equipment (PPE).

The management of these materials will be in accordance with Section IV of Technical and Administrative Guidance Memorandum (TAGM) 4032 (NYSDEC, November 21, 1989). Specific IDW handling is discussed below.

3.1 DRILL CUTTINGS

Drill cuttings generated during the installation of monitoring wells will be temporarily placed in 55-gallon drums as the cuttings are generated during the drilling process. The drums will be temporarily staged within the Site buildings until the drum contents are characterized and can be properly disposed.

3.2 GROUND WATER

Ground water produced during development and sampling activities will be temporarily placed in 55-gallon drums as the water is generated. The drummed ground water will be transported and stored within the Site buildings until the drum contents are characterized and can be properly disposed.

3.3 DECONTAMINATION FLUIDS

Equipment requiring decontamination will take place on a temporary decontamination pad (*i.e.* augers, drill rods, and other drilling tools). Decontamination of other equipment, such as sampling equipment, will take place at the work location, with the decontamination fluids being contained in 5-gallon buckets. Decontamination fluids produced during the decontamination of drilling and sampling equipment will be temporarily placed in 55-gallon drums and temporarily staged within the Site buildings until the drum contents are characterized and can be properly disposed.

3.4 PPE AND GENERAL REFUSE

Used PPE and other general refuse will be placed in trash bags and disposed of in appropriate waste receptacles.

3.5 WASTE CHARACTERIZATION ANALYSIS

At the conclusion of field activities, the soil cuttings, ground water, and decontamination fluids will be appropriately characterized and, after receiving the necessary approvals, will be transported for treatment and/or disposal at a permitted facility.

It is anticipated the waste characterization of solid samples (soil cuttings) and liquid samples (*i.e.* ground water and decontamination fluids) will be based on soil and ground water analytical obtained during RI activities and historical soil and ground water analytical data obtained at the site.

*Groundwater Monitoring
Well Sampling Log Form*



PDB Groundwater Sampling Log

Well ID: _____

Project No.: _____
Site Name: _____
Site Loc.: _____

Field Personnel: _____
Date: _____
Weather: _____

Well Information:

Depth of Well: _____ ft. bmp*
Depth to Water: _____ ft. bmp*
Length of Water Column (LWC): _____ ft.
PDB Midpoint: _____ ft.

* Measurement Point:
 Well Casing
 Protective Casing
 Other: _____

PDB Installation Date: _____

PDB Removal Date: _____

Samples collected:

Container Size	Container Type	# Collected	Field Filtered	Preservative	Container pH

Notes:



PDB Groundwater Sampling Log

Well ID: _____

Project No.: _____
Site Name: _____
Site Loc.: _____

Field Personnel: _____
Date: _____
Weather: _____

Well Information:

Depth of Well: _____ ft. bmp*
Depth to Water: _____ ft. bmp*
Length of Water Column (LWC): _____ ft.
PDB Midpoint: _____ ft.

* Measurement Point:
 Well Casing
 Protective Casing
 Other: _____

PDB Installation Date: _____

PDB Removal Date: _____

Samples collected:

Container Size	Container Type	# Collected	Field Filtered	Preservative	Container pH

Notes:

Site-wide Inspection Form

Site Inspection Form

Date Performed: _____
Site Name: 1-5 Holland Ave
Site Location: Westchester, NY

Weather: _____
Inspector Name: _____
Inspector Signature: _____

Cap/Cover Inpection					
Cap/Cover Type (e.g. gravel, pavement)	Cap/Cover Area (e.g. west lot, building south)	Inspected (Y/N)	Acceptable (Y/N)	Maintenance Required (Y/N)	Description of Required Maintenance or Comments

Conditions to Review

- | | |
|---|--|
| <ul style="list-style-type: none"> a. erosion b. missing cap/cover material c. vegetation growing through cap/cover (excluding vegetated covers) | <ul style="list-style-type: none"> d. areas of ponded water e. areas of settlement f. damage from burrowing animals |
|---|--|

Site Fence Inpection			
Inspected (Y/N)	Acceptable (Y/N)	Maintenance Required	Description of Required Maintenance or Comments

Site Inspection Form

Date Performed: _____
Site Name: 1-5 Holland Ave
Site Location: Westchester, NY

Weather: _____
Inspector Name: _____
Inspector Signature: _____

Well Integrity Inspection				
Well ID	Inspected (Y/N)	Acceptable (Y/N)	Maintenance Required (Y/N)	Description of Required Maintenance or Comments
MW-1				
MW-2				
MW-2SB				
MW-2DB				
MW-4S				
MW-4D				
MW-5				
MW-5SB				
MW-5DB				
MW-6				
MW-6SB				
MW-7				
MW-7SB				
MW-8				
MW-8SB				
MW-9				
MW-9SB				

Conditions to Review

- a. depth Sounding matches construction
- d. well cap is functional and properly preventing water infiltration
- b. well pad is not broken or falling apart
- e. well casing or flush mount protective cover is protective the well
- c. lock functions properly

VI System Inspection*			
Inspected (Y/N)	Acceptable (Y/N)	Maintenance Required (Y/N)	Description of Required Maintenance or Comments

* Complete VI System Field Inspection Form contained in Operation and Maintenance Manual and append.

*Quality Assurance Project
Plan*

SITE MANAGEMENT PLAN

**Quality Control Document
1 – 5 Holland Avenue Site
White Plains, New York**

One Holland Avenue Development

November 2014

TABLE OF CONTENTS

List of Tables.....	ii
QCD Document Distribution	iii
1. Introduction	1
2. Project Description	2
2.1 Project Objectives and Scope.....	2
2.1.1 Laboratory Analysis.....	2
2.2.2 Data Validation.....	2
2.2.3 Audits	3
2.2.4 Documentation.....	3
3. Project Organization and Responsibility	4
3.1 Regulatory Agency and Client Key Personnel.....	4
3.2 One Holland Avenue development Representative	4
3.3 O'Brien & Gere Key Personnel.....	4
3.3.1 O'Brien & Gere Project Officer	4
3.3.2 O'Brien & Gere Senior Technical Director.....	4
3.3.3 O'Brien & Gere Project Manager.....	4
3.3.4 O'Brien & Gere QA Officer	4
3.3.5 Field Sampling Personnel.....	4
3.3.6 Site Health and Safety Officer	4
3.4 Laboratory Management	5
3.4.1 Laboratory Project Manager	5
3.4.2 Laboratory QA Manager.....	5
3.4.3 Laboratory Sample Management Supervisors	5
4. Sampling Handling and Custody	7
4.1 Sampling Custody and Procedures.....	7
4.2 Sample Preparation	7
4.3 Field Custody Procedures.....	7
4.4 Chain-of-Custody Procedures.....	8
4.5 Laboratory Chain-of-Custody Procedures	10
4.6 Final Evidence Files	11
5. Laboratory QA/QC Procedures.....	13
5.1 GC/MS Tuning	13
5.2 Calibration	13
5.3 Blanks.....	13
5.4 Internal Standards Performance.....	13
5.5 Surrogate Evaluation.....	13
5.6 Laboratory Control Samples	13

5.7 MS/MSD and Laboratory Duplicate Samples..... 13

5.8 Analyte Identification and Quantitation 14

5.9 Corrective Action 14

5.10 Preventive Maintenance..... 14

6. Field QA/QC Procedures..... 15

6.1 Field Duplicate Samples 15

6.2 MS/MSD and Duplicate Samples 15

6.3 Field Blanks 15

6.4 Trip Blanks..... 15

6.5 Temperature Blanks 15

7. Data Validation and Usability 16

7.1 Scope of ValidatiOn 16

7.2 Validation Procedures 16

7.3 Data Usability Evaluation 19

7.4 Data Usability Summary Report..... 19

References 21

LIST OF TABLES

1. Analytical Methods and Field Sampling Summary
2. Laboratory MDLs, QLs and Screening Criteria for VOCs in Groundwater and Surface Water
3. Laboratory MDLs, QLs and Screening Criteria for VOCs in Low and Medium Level Soil
4. Laboratory QLs and Screening Criteria for VOCs in Air
5. Laboratory MDLs, QLs and Screening Criteria for Dissolved Gases in Groundwater
6. Laboratory MDLs, QLs and Screening Criteria for Organic Acids in Groundwater
7. Laboratory MDLs, QLs and Screening Criteria for Metals, Cyanide, Hexavalent Chromium, Ferrous Iron, Hardness and Alkalinity in Groundwater
8. Laboratory MDLs, QLs and Screening Criteria for Metals, Cyanide, Hexavalent Chromium, COD, TOC and TIC in Soil
9. Laboratory MDLs, QLs and Screening Criteria for Sulfide, Phosphate, Nitrite, Nitrate, Chloride, Sulfate, TOC, Ammonia, COD, TIC, BOD, Total Phosphorus, TDS, and TSS in Groundwater
10. VOCs using USEPA Method 8260B Quality Control Requirements and Corrective Actions
11. VOCs using USEPA Method TO-15 Quality Control Requirements and Corrective Actions
12. Dissolved Gases using Method RSK-175 Quality Control Requirements and Corrective Actions
13. Organic Acids using Laboratory Method VFA-IC Quality Control Requirements and Corrective Actions
14. Metals using USEPA Methods 6010B and 6020, Mercury using USEPA Methods 7470A/7471A, Cyanide using Methods 9010B/9012A and Hardness using SM 2340B Quality Control Requirements and Corrective Actions
15. TOC using USEPA Method 9060, Sulfide using SM 4500 S2E, BOD using SM 5210B, COD using USEPA Method 410.4, Alkalinity using SM 2320B, TDS using SM 2540C, TSS using SM 2540D, Ferrous Iron using SM 3500B, Phosphate, Nitrate, Nitrate, Chloride and Sulfate using USEPA Method 9056, Ammonia using SM 4500 NH3G, TIC using SM 5310B, Total Phosphorus using SM 4500 PE Quality Control Requirements and Corrective Actions.
16. Hexavalent chromium using USEPA Methods 3096A/7196A Quality Control Requirements and Corrective Actions

QCD DOCUMENT DISTRIBUTION

1. Guy Swenson – O'Brien & Gere
2. Mark Randazzo – O'Brien & Gere
3. Karen Storne – O'Brien & Gere
4. Merit Laboratories, Inc. and TestAmerica Laboratories, Inc. - Laboratories

1. INTRODUCTION

This Quality Control Document (QCD) has been developed by O'Brien & Gere for the 1-5 Holland Avenue Brownfield Site (No. C360115) in White Plains, New York (the Site). This QCD is provided as a part of the Site Management Plan (SMP).

This QCD presents the groundwater and soil vapor/indoor air monitoring objectives and quality assurance/quality control (QA/QC) activities and associated work efforts pertaining to the sampling and analysis of environmental samples at the Site. The procedures in this QCD will be followed by personnel participating in the sampling of groundwater and soil vapor and in the laboratory analyses of environmental samples.

2. PROJECT DESCRIPTION

This section describes the general scope of work and project objectives for the activities to be performed at the Site. Additional information is presented in the Remedial Investigation Field Activities Plan (FAP) and SMP.

2.1 PROJECT OBJECTIVES AND SCOPE

The project tasks and objectives associated with sample collection and analysis are provided in the FAP. The SMP environmental sampling activities consist of the collection of groundwater and air samples and their submission to the laboratories for analysis. Although soil and surface water sampling are not proposed as part of the SMP activities at this time, the QCD includes soil and surface water samples should these samples be collected in the future.

Table 1 presents the analytical methods, sample collection containers and volumes, preservation, holding times and associated quality control sample frequency for the SMP environmental sampling activities.

The groundwater, surface water, soil, and air results will be compared to the following screening criteria, where applicable:

- Title 6 of the Official Compilation of New York Codes, Rules, and Regulations (6 NYCRR Part 375) – Remedial Program Soil Cleanup Objectives
- Part 703 – Surface Water and Groundwater Quality Standards and Groundwater Effluent Limitations – New York State Class GA Groundwater Standards
- Soil Vapor/Indoor Air Matrices 1 and 2 contained with the Guidance for Evaluation Soil Vapor Intrusion in the State of New York (New York State Department of Health, October 2006)

2.1.1 LABORATORY ANALYSIS

Sample analyses and analytical methods to be utilized in SMP activities are listed in Table 1. The target analytes are listed in Tables 2 through 9.

The QC requirements and corrective actions listed in Tables 10 through 16, which supplement the method requirements, are to be followed by the laboratories during the implementation of the SMP.

The laboratories will report non-detected sample results to the method detection limits (MDLs). For the remaining data, results that are less than the quantitation limits (QLs) but greater than the MDLs will be reported by the laboratories using the “J” flag. The QLs and MDLs listed in Tables 2 through 9, or the most recent MDLs and QLs, will be reported by the laboratories on the sample result sheets. The tables also present the applicable screening criteria, which will be used to evaluate the analytical data.

The laboratories will provide sample containers and canisters for the investigation, prepared in accordance with United States Environmental Protection Agency (USEPA) requirements.

Communications with O’Brien & Gere will be documented by the laboratories in the data packages.

The analytical data will be reported in New York State Department of Environmental Conservation (NYSDEC) Analytical Services Protocol (ASP) Category B deliverable format, including the forms described in the NYSDEC guidance, in both hardcopy and electronic data format, for data generated during Task 1c, Task 2, and Task 5a. Deliverables for the remaining Tasks will include comprehensive data packages, appropriate for full data validation.

2.2.2 Data Validation

Data validation will be performed on the laboratory data collected utilizing the NYSDEC Data Usability Summary Review (DUSR) guidance (NYSDEC 2002). O’Brien & Gere data validators will provide data validation services.

Data will be evaluated during validation using the QA/QC criteria established in the methods, the quality control requirements and corrective actions listed in Tables 10 through 16, and laboratory established control limits.

Data affected by excursions from the previously described QA/QC criteria will be qualified using USEPA Region II data validation guidance and professional judgment. The application of these validation guidelines will be modified to reflect method and QAPP requirements, where applicable.

Upon request of the data validator, the laboratory will provide additional or supplemental information within three working days of the request during the validation process.

The specific data quality requirements including precision, accuracy, representativeness, completeness, comparability, and sensitivity will be assessed during data validation. Data usability with respect to the data quality objectives (DQOs) and data uses will be compared to the project requirements. In the event that the completeness objective of 95 percent is not achieved, samples will be recollected at the discretion of the O'Brien & Gere Project Manager.

The laboratory will provide two copies of the data packages and the electronic deliverables within 21 days from the receipt of the last sample at the laboratory.

2.2.3 Audits

At the discretion of the Project Manager, one field audit and one laboratory audit may be performed. Additional audits may be required if issues that would severely limit the use of the sample data are identified during the investigation. Corrective action procedures will be implemented based on unacceptable audit results, as defined herein.

2.2.4 Documentation

Data will be managed in a relational NYSDEC Environmental Information Management System. Laboratory analytical data will be provided in a EQUIS™ electronic disk deliverable (EDD) format for direct upload into the EIMS. Data validation qualifiers will be entered into the EIMS by hand and checked independently. EDDs will be uploaded prior to each Periodic Review Report submittal.

Records will be incorporated into the final project files for the samples. The field logs, data packages, and records will be included in the project files, which will be archived by O'Brien & Gere for a period of 10 years.

3. PROJECT ORGANIZATION AND RESPONSIBILITY

O'Brien & Gere will be responsible for project management and sample collection. The laboratories to be utilized are Merit Laboratories, Inc. and TestAmerica Laboratories, Inc. . Responsibilities for key project team members are summarized below.

3.1 REGULATORY AGENCY AND CLIENT KEY PERSONNEL

NYSDEC Project Manager (Ms. Kiera Thompson) has oversight authority for the NYSDEC.

3.2 ONE HOLLAND AVENUE DEVELOPMENT REPRESENTATIVE

Neal Frink, Esq. is responsible for the execution of each phase of the project, including corresponding and coordinating activities with NYDEC.

3.3 O'BRIEN & GERE KEY PERSONNEL

3.3.1 O'Brien & Gere Project Officer

Douglas M. Crawford, P.E. is the O'Brien & Gere Project Officer and has overall responsibility for meeting the stated project objectives. In addition, he is responsible for providing the O'Brien & Gere Project Manager with access to O'Brien & Gere corporate resources.

3.3.2 O'Brien & Gere Senior Technical Director

Guy A. Swenson, CPG is the Senior Technical Director and reports directly to the Project Officer. The Senior Technical Director is directly responsible for the technical aspects of the project.

3.3.3 O'Brien & Gere Project Manager

Mark A. Randazzo, CPG is the O'Brien & Gere Project Manager and is responsible for implementing the project and has the authority to commit the resources necessary to meet project objectives and requirements. His primary function is to meet the technical, financial, and scheduling objectives and milestones. He will provide direction to O'Brien & Gere Project Team.

3.3.4 O'Brien & Gere QA Officer

Karen Storne is the O'Brien & Gere QA Officer (QAO) for this project. She will manage and be responsible for QA/QC review of data generated. Data processing and validation will be overseen and reviewed by the O'Brien & Gere QAO. If QA problems or deficiencies requiring special action are identified, the O'Brien & Gere QAO, Project Manager, and Project Officer will determine the appropriate corrective action. The QA Officer will then be responsible for follow-up and oversight of corrective action implementation, to the satisfaction of the client and the NYSDEC representative.

The QAO may perform data validation activities or may designate additional data validators to work under her direction. Data validators will be responsible for review of laboratory data for compliance with the project-specific DQOs and for such parameters as precision; accuracy; representativeness; comparability; and completeness. Data validators will notify the QAO of any noted QA deficiencies.

3.3.5 Field Sampling Personnel

O'Brien & Gere field sampling personnel will be responsible for collection, packaging, preservation, and shipping of environmental samples in accordance with the Remedial Investigation Field Activities Plan (FAP), QCD, and applicable NYSDEC requirements. Field sampling personnel will also collect field data and monitor Site health and safety.

3.3.6 Site Health and Safety Officer

The O'Brien & Gere Site Health and Safety Officer (SHSO) will be responsible for adherence of the field crew to Site health and safety requirements as described in the Health and Safety Plan, (HASP). Specific responsibilities of the SHSO are outlined in the HASP.

3.4 LABORATORY MANAGEMENT

The laboratories will be determined at a future date. The laboratory shipping addresses and National Environmental Laboratory Accreditation Conference (NELAC) Certification numbers will be provided.

The laboratories to be utilized are as follows:

Air Samples (USEPA Test Method TO-15)

TestAmerica Laboratories, Inc.
30 Community Drive
Suite 11
South Burlington, VT 05403
(NYSDOH NELAC Laboratory Identification No. 10391.)

Groundwater Samples (USEPA Test Method 8260)

Merit Laboratories, Inc.
2680 East Lansing Dr.
East Lansing, MI 48823
(NYSDOH NELAC Laboratory Identification No. 11814.)

3.4.1 Laboratory Project Manager

The Laboratory Project Manager will be responsible for:

- Coordinating laboratory analysis
- Supervising in-house chain-of-custody
- Scheduling sample analysis
- Overseeing data review
- Overseeing preparation of analytical reports.

It will also be the responsibility of the Laboratory Project Manager to approve final analytical reports prior to submission to O'Brien & Gere.

3.4.2 Laboratory QA Manager

The Laboratory QA Managers will be responsible for overview of the laboratory QA, overview of the QA/QC documentation, and conducting detailed data review. The Laboratory QA Manager will decide if laboratory corrective actions are required in addition to seeing that laboratory Standard Operation Procedures (SOPs) are followed.

3.4.3 Laboratory Sample Management Supervisors

The Laboratory Sample Management Supervisors will be responsible for the following tasks:

- Receive and inspect incoming sample containers
- Record condition of incoming sample containers
- Sign appropriate documents
- Verify chain-of-custody and its correctness
- Notify Laboratory Project Manager of sample receipt and inspection
- Assign unique identification number and customer number, and enter each into sample receiving log
- Initiate transfer of samples to appropriate lab sections
- Control and monitor access/storage of samples and extracts.

Primary responsibility for project quality rests with the O'Brien & Gere Project Manager. Independent QA will be provided by the Laboratory QA Managers prior to release of data to O'Brien & Gere.

4. SAMPLING HANDLING AND CUSTODY

4.1 SAMPLING CUSTODY AND PROCEDURES

Chain-of-custody procedures will be instituted and followed throughout the investigation. These procedures include field custody, laboratory custody, and evidence files. Samples are physical evidence and will be handled according to strict chain-of-custody protocols. The O'Brien & Gere QAO must be prepared to produce documentation that traces the samples from the field to the laboratory and through analysis. USEPA has defined custody of evidence as follows:

- In actual possession;
- In view after being in physical possession;
- In a locked laboratory; and
- In a secure, restricted area.

4.2 SAMPLE PREPARATION

The analytical laboratories will supply appropriate sample containers for sediment and surface water samples in coolers, as well as preservatives (as appropriate). Sample containers for soil samples collected for VOC analysis will be provided by the laboratories and prepared using USEPA Method 5035 medium level sample preparation technique.

QA measures for this project will begin with the sample containers; pre-cleaned containers will be purchased from a USEPA-certified manufacturer (I-Chem 200 or equivalent).

Immediately after collection, samples will be transferred to properly labeled sample containers, and properly preserved. Table 1 lists the proper sample container, sample volumes, preservation, and holding times. Samples requiring refrigeration for preservation will be promptly transferred to coolers packed with wet ice and/or ice packs. If field storage is required, the samples will be stored in a secured storage facility and a cooler temperature of 4 °C will be maintained.

4.3 FIELD CUSTODY PROCEDURES

The field sampler is personally responsible for the care and custody of the sample until transferred.

The field logbook will be used to note information regarding collection of samples and any observations. All entries will be signed and dated. Field logbooks will be waterproof and bound. The logbook will be dedicated to the project and pages will not be removed. Corrections will be made by drawing a single line through the incorrect data and initialing and dating the correction that was made to the side of the error. An initialed diagonal line will be used to indicate the end of an entry or the end of the day's activities.

The following information will be recorded in the field logbook by the field sampling team:

- Name and title of author, date, and time of site entry, and physical/environmental conditions during the field activity;
- Meteorological data;
- Project number, client name, and Site name;
- Name and title of field crew members;
- Sample media;
- Sample collection method, including equipment utilized;
- Number and volume of samples collected;
- Description of sample locations;

- Date and time of sample collection;
- Diagrams of sampling process;
- Sample and QA/QC identification numbers;
- Sample distribution;
- Field observations;
- Field measurements made and equipment used;
- Calculations, results, and calibration data for field sampling and measurements;
- References for maps and photographs of the sample location;
- Bottle lot numbers; and
- Dates and method of sample shipments.

A completed sample identification label or tag that will be sequentially numbered, will be attached to each investigative or QC sample and the sample placed in a shipping container. The identification on the label/tag must be sufficient to enable cross-reference with the logbook. The sample label/tag will be recorded using waterproof, non-erasable ink and will be attached to the sample container using adhesive.

The sample labels/tags will contain the following information:

- Sample number identification;
- Project number;
- Date and time of sample collection;
- Designation of the sample as a grab or composite;
- Type of sample matrix;
- Sample location;
- Signature of the sampler;
- Whether the sample is preserved or unpreserved;
- Space for laboratory sample number (only on the sample tag); and
- General types of analysis to be performed.

4.4 CHAIN-OF-CUSTODY PROCEDURES

Chain-of-custody records will be kept starting at the time that sample containers are placed in the coolers for transportation to the laboratory. One completed chain-of-custody record must be kept with each sample cooler at all times.

The following measures will be taken when completing a chain-of-custody record:

- Chain-of-custody forms will be completed in waterproof, non-erasable ink.
- Chain-of-custody forms will be completed neatly using printed text. If a simple mistake is made, the error will be lined out with a single line and initialed and dated.
- Each separate sample entry will be sequentially numbered.
- The use of "Ditto" or quotation marks to indicate repetitive information in columnar entries should be avoided. If numerous repetitive entries must be made in the same column, a continuous vertical arrow will be used between the first entry and the next different entry.

- When more than one chain-of-custody form is used for a single shipment, each form will be consecutively numbered using the "Page ___ of ___" format.
- If necessary, additional instructions will be placed directly onto the chain-of-custody form.
- Acronyms used on a chain-of-custody form will be defined.

The chain-of-custody form will contain the following information:

- Project identification and number;
- Sample description/location;
- Required analysis;
- Date and time of sample collection;
- Type and matrix of sample;
- Technique used to collect VOC samples in soil (Encore® or methanol preservation)
- Number of sample containers;
- Analysis requested/comments;
- Sampler signature/date/time;
- Date and signature of the field representative;
- Date and signature of the laboratory representative;
- Carrier used to ship coolers; and
- Air bill number (if shipped by a commercial carrier).

In the case that high concentrations are suspected to be present in the samples, a note to that effect will be included on the chain-of-custody form.

Environmental samples will be packed prior to shipment using the following procedures:

- Select a sturdy cooler in good repair and clean. Secure and tape the drain plug with fiber or duct tape.
- Air samples do not require preservation and may be shipped using alternative shipping containers.
- Be sure the lids on all bottles are tight (will not leak) and baggies are sealed.
- Where applicable, put ice that has been placed in heavy-duty polyethylene bags and properly sealed on top of or between the samples. Pack samples securely to eliminate breakage during shipment with ice packs to maintain the inside temperature at approximately 4°C.
- Sampling containers will be packed with packing materials. When possible, sample container preparation and packing for shipment will be completed in a well-organized and clean area. Sample containers will be prepared for shipment by wiping containers clean of debris/water using paper towels. Paper towels will be disposed with the personal protective equipment (PPE).
- Place chain-of-custody record into a Ziploc plastic bag, tape the bag to the inner side of the cooler lid, and close the cooler and securely tape (preferably with fiber tape) the top of the cooler shut. Two custody seals will be affixed to the latch and lid of the cooler. The number of the security seal will be recorded on the chain-of-custody form. The custody seals will consist of adhesive-backed tape that easily rips if it is disturbed. The field sampler will initial and date the seal. The seals must be broken to open the cooler and will indicate tampering if the seal is broken before receipt at the laboratory.
- A label containing the name and address of the shipper will be placed on the outside of the container.

The field sampling team will transport or ship the cooler via an overnight delivery service or hand deliver to the laboratory. Prior to shipment of sample coolers, the field sampling team will contact the laboratory to notify the laboratory of the shipment.

Samples will remain in the custody of the sampler until transfer of custody is completed. Transfer consists of:

- Delivery of samples to the Laboratory Sample Custodian; and/or
- Signature of the Laboratory Sample Custodian on the chain-of-custody form as receiving the samples and signature of sampler as relinquishing the samples.

The field sampling team will ship by commercial carrier the coolers containing environmental samples to the laboratories identified for this project. Samples will not be shipped to another laboratory without the permission of the O'Brien & Gere Project Manager.

Canisters used to collect air samples must be returned to the laboratory within 15 days of evacuation and shipment to the Site for sampling due to the loss of pressure during storage.

The chain-of-custody document will be completed by the field sampler and provided for each sample cooler. When transferring the possession of samples, individuals relinquishing and receiving will sign, date, and note the time on the chain-of-custody. Custody of samples must be continuous between parties and time gaps must not be present. Each shipment of samples to the laboratory must have its own chain-of-custody record with the contents of the shipment, method of shipment, name of courier, and other pertinent information written on the record. The original record accompanies the shipment and the copies are kept with the field logbook and distributed to the O'Brien & Gere Project Manager. A copy of the chain-of-custody will be faxed to the laboratory and to the Project Manager on the same day of sample shipment. Freight bills, postal service receipts, and bills of lading will be retained as permanent documentation.

If a carrier is used to take samples between the sampler and the laboratory, the air bill number must be written on the chain-of-custody.

Samples will be shipped or transported within 24 hours of being collected and will arrive at the laboratory no later than 48 hours after sample collection.

4.5 LABORATORY CHAIN-OF-CUSTODY PROCEDURES

Laboratory custody procedures continue when the samples are received by the laboratory. When the samples arrive at the laboratory, the Laboratory Sample Custodian will sign the courier's air bill or bill of lading (unless hand-delivered) and will note the cooler temperature on the chain-of-custody form. If the cooler temperature is greater than 6 °C, the O'Brien & Gere Project Manager will be notified. If the samples were shipped, the courier's air bill number will be attached to the chain-of-custody and the air bill number will be written on the chain-of-custody form. If the cooler arrives at the laboratory after hours, an external chain-of-custody will be properly filled out and will accompany the cooler until the laboratory receives the cooler.

The Laboratory Sample Custodian's duties and responsibilities upon sample receipt will be to:

- Document receipt of samples by signing the record with the date and time of sample receipt.
- Note the cooler temperature on the chain-of-custody form.
- Inspect sample shipping containers for the presence or absence of custody seals (only if shipped via overnight courier) and for container integrity.
- Document canister pressures for air samples and notify the O'Brien & Gere Project Manager if pressure requirements are not met.
- Sign the appropriate forms or documents, verify, and record the agreement or disagreement of information on sample documents and, if there are discrepancies, record the problem and notify the O'Brien & Gere Project Manager.

- Assign a number for each sample upon receipt. That sample number will be placed on the sample label which will remain attached to the sample container.
- Log sample information into the laboratory sample tracking system.
- Label sample with a unique, sequential laboratory sample number.
- Place samples in the walk-in cooler or sample storage area that is a secure, limited-access storage.

If QC samples have not been properly identified during sample collection, the Laboratory Project Manager will contact the O'Brien & Gere Field Operations Manager to assign QC samples prior to the start of sample analysis.

The laboratory will immediately contact the O'Brien & Gere Project Manager if issues pertaining to sample condition or documentation are detected (*e.g.*, broken security seal; broken, open, or otherwise compromised sample containers; chain-of-custody information in disagreement with sample labels). The laboratory will also contact the O'Brien & Gere Project Manager if sample canister pressure issues are detected upon receipt.

At the laboratory, the analysts will be required to log samples and extracts in and out of storage as the analysis proceeds.

There must not be a lapse in the custody for the sample containers and canisters and exchanges of custody must be documented on the form. Samples will be returned to secure storage at the close of business. Care must be exercised to properly complete, date, and sign records needed to generate the data package.

Procedures to be followed by the laboratory include:

- Samples will be handled by the minimum number of people possible.
- The laboratory will set aside a secured sample storage area consisting of a clean, dry, refrigerated, isolated room.
- A specific person will be designated sample custodian. Incoming samples will be received by the custodian who will indicate receipt by signing the chain-of-custody form.
- The custodian will ensure that samples which are heat-sensitive, light-sensitive, radioactive, or which require special handling in other ways, are properly stored and maintained prior to analysis.
- The analytical area will be restricted to authorized personnel only.
- After sample analyses are complete, the analytical data will be kept secured and released to authorized personnel only.

4.6 FINAL EVIDENCE FILES

The final evidence file will be the central repository for documents that constitute evidence relevant to sampling and analysis activities as described in this QCD. O'Brien & Gere is the custodian of the evidence file and maintains the contents of evidence files for the Site, including relevant records, reported, logs, field notebooks, pictures, subcontractor reports, and data reviews.

Copies of the laboratory data packages will be stored by the laboratory for incorporation into the sample file. The Laboratory Project Manager will be responsible for laboratory data packages.

Upon completion of the analyses, the Laboratory Project Manager will begin assimilating the field and laboratory data. In this way, the file for the samples will be generated. The final file for the sample will be stored at O'Brien & Gere and will consist of the following:

- Laboratory data packages, including summary and raw data from the analysis of environmental and QC samples, chromatograms, mass spectra, calibration data, work sheets, and sample preparation log
- Chain-of-custody records
- Data validation reports

- Field notebooks and data
- Field collection report
- Pictures and drawings
- Progress and QA reports
- Contractor and subcontractor reports
- Correspondence.

The evidence file must be maintained in a secured, limited access area until submittals for the project have been reviewed and approved, and for a minimum of ten years past the submittal date of the final report.

5. LABORATORY QA/QC PROCEDURES

A brief description of laboratory quality assurance/ quality control (QA/QC) analyses is presented in the following sections.

5.1 GC/MS TUNING

Tuning and performance criteria are established to verify mass resolution, identification, and to some degree, instrument sensitivity. These criteria are not sample specific; conformance is determined using standard materials. Therefore, these criteria should be met in all circumstances.

5.2 CALIBRATION

Compliance requirements for satisfactory instrument calibration are established to verify that the instrument is capable of producing acceptable quantitative data. Initial calibration demonstrates that the instrument is capable of acceptable performance at the beginning of analysis, and continuing calibration and performance checks document satisfactory maintenance and adjustment of the instrument on a day-to-day basis.

5.3 BLANKS

Corrective action procedures are implemented for blank analyses if target compounds are detected at concentrations greater than the requirements presented in corrective action Tables 10 through 16. The criteria for evaluation of blanks apply to any blank associated with a group of samples. If problems with a blank exist, data associated with the project must be carefully evaluated to determine whether or not there is an inherent variability in the data for the project, or if the problem is an isolated occurrence not affecting other data.

5.4 INTERNAL STANDARDS PERFORMANCE

Internal standards, which are compounds not found in environmental samples, will be spiked into samples, blanks, method spikes and method spike duplicates (MS/MSDs), and laboratory control samples (LCSs) at the time of sample preparation for applicable methods. Internal standards will meet the criteria specified in the corrective action tables.

5.5 SURROGATE EVALUATION

Accuracy and matrix biases for individual samples are monitored for organic analyses using surrogate additions for applicable methods. Surrogates are compounds similar in nature to the target analytes; the surrogates are spiked into environmental samples, blanks, and quality control samples prior to sample preparation for organic analyses. The evaluation of the results of these surrogate spikes is not necessarily straightforward. The sample itself may produce effects due to such factors as interferences and high concentrations of analytes. Since the effects of the sample matrix are frequently outside the control of the laboratory and may present relatively unique problems, the review and validation of data based on specific sample results is frequently subjective.

5.6 LABORATORY CONTROL SAMPLES

Laboratory control samples (LCSs) are standard solutions that consist of known concentrations of the complete list of target analytes spiked into laboratory analyte-free matrix. They are prepared or purchased from a certified manufacturer from a source independent from the calibration standards to provide an independent verification of the calibration procedure. These QC samples are then prepared and analyzed following the same procedures employed for environmental sample analysis to assess method accuracy independently of sample matrix effects. The laboratory prepares and analyzes a LCS with each group of twenty samples of similar matrix that are extracted, digested, or analyzed at the same time. Percentage recoveries are evaluated to assess the efficiency of the preparation and analysis method independent of environmental sample matrix effects.

5.7 MS/MSD AND LABORATORY DUPLICATE SAMPLES

MS/MSD and laboratory duplicate analyses are performed on environmental samples at a frequency of one per every twenty samples of similar matrix. MS/MSD samples are spiked at the laboratory with the complete list of

target analytes. MS/MSD and laboratory duplicate data are generated to evaluate precision and accuracy of the analytical method with respect to sample matrices.

5.8 ANALYTE IDENTIFICATION AND QUANTITATION

The objective of the qualitative criteria is to minimize the number of erroneous identifications of compounds. An erroneous identification can either be a false positive (reporting a compound present when it is not) or a false negative (not reporting a compound that is present). The identification criteria can be applied much more easily in detecting false positives than false negatives. Negatives, or non-detected compounds, on the other hand represent an absence of data and are, therefore, much more difficult to assess. The objective for quantitative requirements is to maximize the accuracy of data and sensitivity of the instrument. Unless sample screening indicates the presence of high concentration target analytes, samples are analyzed undiluted to maximize sensitivity. Samples are reanalyzed at the appropriate dilution when concentrations exceed the linear calibration range to maximize accuracy.

Interferences are identified and documented. Samples are diluted only if analytes of concern generate responses in excess of the linear range of the instrument.

5.9 CORRECTIVE ACTION

Generally, the following corrective actions are taken by the laboratory. When calibration, instrument performance, and blank criteria are not met, the cause of the problem is located and corrected. The analytical system is then recalibrated. Sample analysis does not begin until calibration, instrument performance, and blank criteria are met. When matrix spike, reference standard, or duplicate analyses are out of control, the analyses of these samples are investigated. Depending on the results of the overall QC program for the sample set, the data may be accepted, accepted with qualification, or determined to be unusable.

5.10 PREVENTIVE MAINTENANCE

Preventative maintenance procedures are carried out on laboratory equipment in accordance with the laboratory procedures. Maintenance activities conducted are recorded in laboratory documents.

6. FIELD QA/QC PROCEDURES

A brief description of field QA/QC samples is presented in the following sections.

6.1 FIELD DUPLICATE SAMPLES

Collection of field duplicate samples provides for the evaluation of the laboratory's precision performance by comparing analytical results of two samples from the same location. They are also collected to evaluate field sample collection precision procedures. Samples are collected from one location and sent to the laboratory blind (with two different sample identifications). Duplicates of aqueous samples are obtained by alternately filling samples containers from the same sampling device for each parameter. Duplicates of aqueous samples submitted for VOC analysis from monitoring wells are filled from the same bailer full of water whenever possible and are the first set of containers filled. Duplicates of solid samples submitted for VOC analysis are obtained from discrete locations without mixing. Duplicates for the remaining analyses require homogenization by filling a decontaminated stainless steel tray or bowl with the sample and mixing it with a decontaminated stainless steel instrument. The mixed sample is divided in half and scooped alternatively from each half to fill the sample container. One field duplicate sample will be collected for every 20 environmental samples (minimum frequency of 5%) or one per matrix for less than 20 samples. If less than 20 samples are collected, one field duplicate sample will be collected.

6.2 MS/MSD AND DUPLICATE SAMPLES

MS/MSD samples are duplicate samples that have spiking solutions added at the laboratory during sample preparation. MS/MSD samples are considered identical to the original sample. The percent recovery of the spiked amount indicates the accuracy of the extraction as well as interferences caused by the matrix. Relative percent differences (RPD) between spike sample recoveries will indicate the precision of the data. Duplicates of aqueous samples are obtained by alternately filling samples containers from the same sampling device for each parameter. One MS/MSD sample set will be collected for every 20 environmental samples submitted to the laboratory (minimum frequency of 5%) or one MS/MSD for less than 20 samples.

For inorganic analyses, duplicate analyses will be performed on environmental samples at a frequency of one per sample matrix and every 20 samples of similar matrix. Duplicate samples will be prepared and analyzed within the same batch as the environmental samples. Duplicate data are generated to determine precision of the analytical method with respect to sample matrices.

6.3 FIELD BLANKS

Field blanks will consist of samples of analyte-free water that are passed through and/or over decontaminated sampling equipment. One field blank will be collected per set of sampling equipment per sampling event. Field blanks will not be required if dedicated sampling equipment is utilized. The field blank samples will be subject to the same analyses as the environmental samples. One field blank will be collected per 10 samples or once per day, whichever is more conservative.

6.4 TRIP BLANKS

Trip blanks will be prepared as the other preservation containers and will contain analyte-free solvent. The trip blank will undergo shipment from the sampling site to the laboratory in coolers with the environmental samples to be analyzed for VOCs. Trip blanks will be analyzed for VOCs to determine if contamination has taken place during sample handling and/or shipment. Trip blanks will be utilized for samples at a frequency of one each per shipment per cooler sent to the laboratory for VOCs.

6.5 TEMPERATURE BLANKS

Temperature blanks will consist of vials of water that have undergone shipment from the sampling site to the laboratory in coolers with the environmental samples to be analyzed for the sampling program. The temperature of these blanks will be measured at the laboratory upon receipt of the sample cooler to verify compliance with the cooler temperature requirement.

7. DATA VALIDATION AND USABILITY

7.1 SCOPE OF VALIDATION

Data validation will be performed on the data collected utilizing the NYSDEC DUSR guidance (NYSDEC 2002). O'Brien & Gere data validators will provide data validation services.

Upon request by the data validator, the laboratory will provide additional or supplemental information within three working days of the request.

7.2 VALIDATION PROCEDURES

Data Validation is a process of determining the suitability of a measurement system for providing useful analytical data. Data validation is essentially a three-step process in which the analytical data's quality assurance/quality control information is first compared to a series of QA/QC criteria. Based on the results of this comparison, the analytical data are then assigned qualifiers, which provide an indication of the data's usability. Finally, an overall evaluation of the data's usability is performed.

Full validation will be performed for the samples collected for each type of analysis. Full data validation will consist of a review of data summary forms and supportive raw analytical data that are provided in the data packages.

Evaluation of laboratory data will be performed utilizing the QA/QC criteria established in this QCD, as listed in Tables 10 through 16, the analytical methods, and laboratory established control limits.

In accordance with the DUSR process, the following questions will be answered during the validation:

1. Is the data package complete as defined under the project requirements for the NYSDEC ASP Category B?
2. Have the holding times been met?
3. Do all the QC data: blanks, instrument tunings, calibration standards, calibration verifications, surrogate recoveries, spike recoveries, duplicate analyses, laboratory controls and sample data fall within the protocol required limits and specifications?
4. Have the data been generated using established and project-specific protocols?
5. Does an evaluation of the raw data confirm the results provided in the data summary sheets and quality control verification forms?
6. Have the correct data qualifiers been applied?

Data affected by excursions from the previously described QA/QC criteria will be qualified using the following USEPA Region II data validation guidance documents or the most current documents and professional judgment:

- USEPA. 2006a. *USEPA Region II Evaluation of Metals Data for the CLP Program, SOP HW-2* Revision 13. New York, NY.
- USEPA. 2006b. *USEPA Region II Validating Volatile Organic Compounds by SW-846 Method 8260B, SOP HW-24* Revision 2. New York, NY.
- USEPA. 2006c. *Validating Volatile Organic Analysis of Ambient Air in canister by Method TO-15. SOP HW-31, Revision 4.* Albany, New York

These validation guidelines will be modified to reflect the QA/QC criteria established in this QCD and the analytical methods.

Data validators will be responsible for reviewing the QC parameters as listed below. Data validators will recalculate approximately ten percent of the laboratory sample calculations using raw data when verifying sample results for full validation. In addition, data validators will review approximately ten percent of the raw

data to verify that compound identification was performed correctly and transcription errors are not present for full validation.

Data quality will be evaluated using current laboratory control limits as provided in the data packages. Sample data will be qualified based on excursions from control limits. Data validators will check corrective action reports and results of reanalysis if available. Corrective actions implemented by the laboratory will be referenced in the data validation report.

Data will be qualified using the following validation approach:

- If percent recoveries are less than laboratory control limits but greater than ten percent (greater than thirty percent for aqueous metals and inorganic parameters), non-detected and detected results are qualified as approximate (U, J) to indicate minor excursions.
- If percent recoveries are greater than laboratory control limits, detected results are qualified as approximate (J) to indicate minor excursions.
- If percent recoveries are less than ten percent (less than thirty percent for aqueous metals and inorganic parameters), detected results are qualified as approximate (J) and non-detected results are qualified as rejected (R) to indicate major excursions.
- If relative percent differences (RPDs) for matrix spikes (MSs) and matrix spike duplicates (MSDs) are outside of laboratory control limits, detected results are qualified as approximate (J).
- If RPDs for field duplicates are outside of validation criteria, detected and non-detected results are qualified as approximate (U, J).
- The following actions are taken for blank evaluation:
 1. If methylene chloride, acetone or 2-butanone is detected in the sample at a concentration that is less than ten times the concentration in the associated blank, the sample result is identified as non-detected and qualified as "U".
 2. If other target analytes are detected in the sample at a concentration that is less than five times the concentration detected in the associated blank, the sample result is identified as non-detected and qualified as "U".
 3. For blank impacted sample concentrations that are less than the QL, the QL is reported and the "U" qualifier is added.
 4. For blank impacted sample concentrations that are greater than the QL, the "U" qualifier is added to the existing sample concentration.
 5. The highest concentrations of the target analytes are used to evaluate the associated samples.
- Qualification of organic data for MS/MSD analyses excursions will be performed only when both MS and MSD percent recoveries are outside of laboratory control limits.
- Organic data will be rejected in the case that both MS/MSD recoveries are less than ten percent.
- Qualification of data will not be performed if MS/MSD or surrogate recoveries are outside of laboratory control limits due to sample dilution.
- In the case that excursions were detected in more than one quality control sample of the same matrix within one sample delivery group, samples will be batched according to collection date and qualified accordingly.
- For organic analyses, qualification of data associated with MS/MSD or field duplicate excursions will be limited to the un-spiked sample or the field duplicate pair, respectively.
- Field duplicate data will be evaluated against relative RPD criteria of less than 100 percent for solid samples, 50 percent for aqueous samples, and 25 percent for air samples when results are greater than five times the

QL. When sample results for field duplicate pairs are less than five times the QL, the data will be evaluated using control limits of plus or minus two times the QL.

- Inorganic laboratory duplicate data will be evaluated against laboratory control limits established for RPD criteria when results are greater than five times the QL. When sample results for laboratory duplicate pairs are less than five times the QL, the data will be evaluated using control limits of plus or minus two times the QL.
- Results for samples submitted for organic analyses impacted by cooler temperatures of greater than 10°C, will be qualified as approximate. Inorganic results will not be qualified for elevated cooler temperatures.
- Results for samples submitted for organic and inorganic analyses that are impacted by percent solids of 50 percent or less will be qualified as approximate.

In accordance with the USEPA guidance, and utilizing professional judgment, the following qualifiers will be used in the data validation:

- "R" Indicates that the reporting limit or sample result is determined to be unusable due to a major deficiency in the data generation process. The data should not be used for any qualitative or quantitative purposes.
- "U" Indicates that the analyte was analyzed for, but a concentration was not detected. The sample quantitation limit is presented. This qualifier is also used in the validation process to signify that the detection limit of an analyte was raised due to blank contamination.
- "J" Indicates that the concentration should be considered approximate. This qualifier is used when the data validation process identifies a deficiency in the data generation process. This qualifier is also applied by the laboratory for organic analyses when the analyte concentration was greater than the MDL but less than the QL. In the latter case, the identification of the analyte is not in question but the quantitation of the analyte concentration may be uncertain.
- "UJ" Indicates that the analyte was analyzed for, but a concentration was not detected. The sample quantitation limit is presented, and should be considered approximate. This qualifier is used when the data validation process identifies a deficiency in the data generation process.
- "JN" Indicates that there is presumptive evidence that the analyte is present, but it has not been confirmed due to column confirmation excursions.

The following guidelines will be used regarding the assignment of qualifiers and the evaluation of data:

- The data quality evaluation results in only one type of qualifier ("U", "J", "UJ," or "R") for each analyte; in a case when several qualifiers are applicable to the same analyte, the cumulative effect of the various QA/QC excursions is employed in assigning the final data qualifiers. For example, if a sample result is affected by low surrogate recoveries for which the "UJ" qualifier is applied, but low MS/MSD recoveries result in the rejection of the sample result (application of the "R" qualifier), the final data qualifier is the "R" qualifier.

The following parameters will be included in the review for organic and inorganic analyses for full validation (where applicable):

1. Chain-of-custody
2. Sample collection and sample preservation
3. Holding times
4. GC/MS tuning criteria
5. Initial calibration and calibration verification
6. Blank analysis

7. Surrogate recovery
8. Matrix spike/matrix spike duplicate (MS/MSD) analysis
9. Laboratory duplicate analysis
10. Field duplicate analysis
11. LCS analysis
12. ICP interference check sample analysis
13. ICP serial dilution analysis
14. Internal standards performance
15. Target analyte identification, quantitation, and QLS
16. Documentation completeness
17. QCD compliance

Tentatively identified compounds (TICs) for organic analyses will not be evaluated as part of the validation process.

7.3 DATA USABILITY EVALUATION

Based on the QA/QC information review and the qualifiers assigned to the analytical data, an overall evaluation of the data's usability will be performed. Data usability is defined as the percentage of data that remains unqualified or is qualified as approximate or non-detected due to blank contamination, divided by the data reported by the laboratory times 100. The percentage usability excludes the data qualified as rejected due to major QA/QC excursions. The non-usable data are defined as the percentage of the data qualified as rejected divided by the data reported by the laboratory times 100. The data usability will be provided for each the complete data set for this project.

The data usability evaluation considers the data parameters of precision, sensitivity, accuracy, representativeness, comparability, and completeness, which are described as follows:

- Precision is evaluated through the review of field duplicate samples, laboratory duplicates, and MS/MSD samples.
- Sensitivity is evaluated through the review of QLS.
- Accuracy is evaluated through the review of MS/MSD samples, internal standards, surrogate recoveries, LCS recoveries, calibration, instruction performance check, ICP interference check analysis, and ICP serial dilutions.
- Representativeness is evaluated through the review of holding times, sample preservation and preparation, blank analysis and target compound identification and quantification.
- Comparability is evaluated through the review of the analytical methods and reporting procedures for consistency.
- Completeness is defined as the overall percentage of sample results that are determined to be usable.

7.4 DATA USABILITY SUMMARY REPORT

The DUSR will contain separate QA sections in which data quality information collected during the investigation is summarized. The DUSR will include the following:

- Guidelines used to evaluate the data.
- Data qualifiers applied to sample results.

- Summary of samples collected and analyses performed.
- Narrative that identifies major and minor analysis excursions detected for each parameter evaluated for each analysis.
- Additional issues and information that may be beneficial to the data user are discussed.
- Data summary forms.
- Data usability.

The DUSR will be prepared under the direction of the O'Brien & Gere QA Officer.

REFERENCES

- American Water Works Association (AWWA), American Public Health Association (APHA) and Water Environment Federation (WEF). 1998. *Standard Methods for the Examination of Water and Wastewater*, 20th Edition. Washington, D.C.
- Kampbell, D.H., J.T. Wilson, S.A. Vandegrift. 1991. *Dissolved Oxygen and Methane in Water by a GC Headspace Equilibration Technique*, International Journal of Environmental Analytical Chemistry, Volume 36, pp. 249-257.
- O'Brien & Gere. 2010. *Feintool Site Investigation Work Plan, White Plains, New York*. Syracuse, New York.
- USEPA. 1983. *Methods for Chemical Analysis of Water and Wastes*, EPA-600/4-79-020. Cincinnati, Ohio.
- USEPA. 1999. *Compendium of Methods for the Determination of Toxic Organic Compounds in Ambient Air*. Cincinnati, Ohio
- USEPA. 2004. *Test Methods for Evaluating Solid Waste: Physical/Chemical Methods, SW-846, 3rd Edition, Update IIIB*. Washington D.C.
- USEPA. 2006a. *USEPA Region II Evaluation of Metals Data for the CLP Program, SOP HW-2 Revision 13*. New York, NY.
- USEPA. 2006b. *USEPA Region II Validating Volatile Organic Compounds by SW-846 Method 8260B, SOP HW-24 Revision 2*. New York, NY.
- USEPA. 2006c. *Validating Volatile Organic Analysis of Ambient Air in canister by Method TO-15. SOP HW-31, Revision 4*. Albany, New York

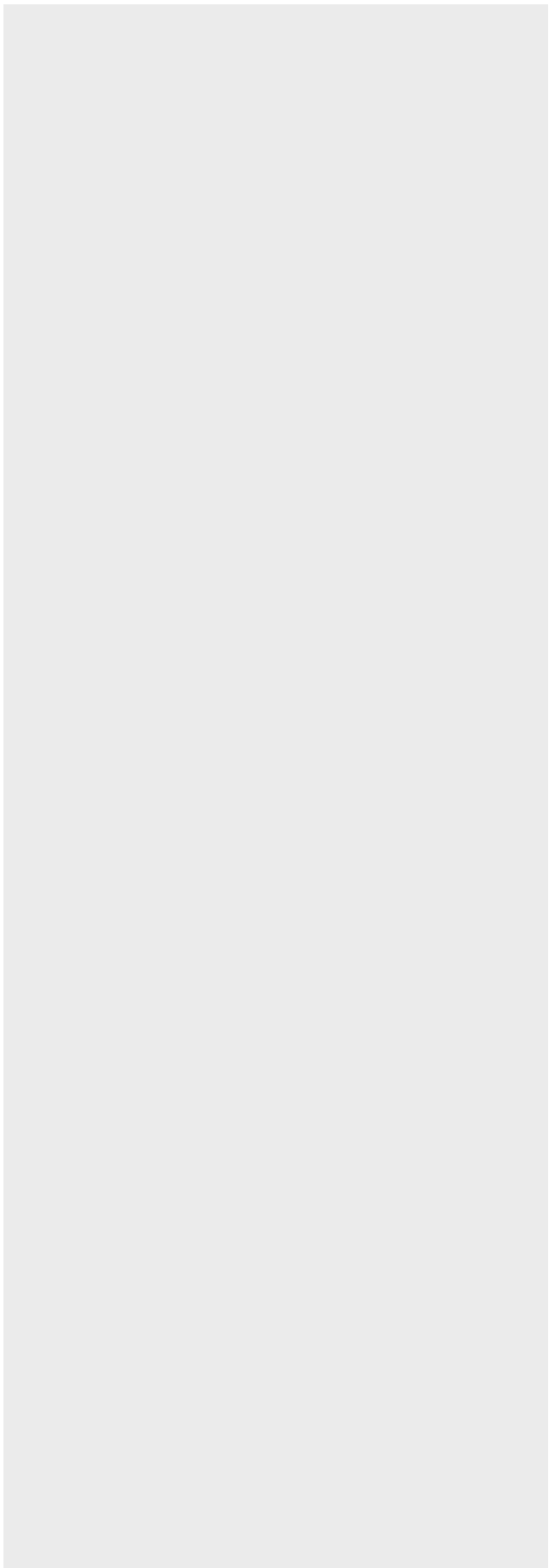

TABLE 1. ANALYTICAL METHODS AND FIELD SAMPLING SUMMARY

Sample Matrix	Analytical Group and Level	Analytical and Preparation Methods and References	Sample Collection Containers and Volumes	Preservation Requirements	Maximum Holding Times	No. of Field Duplicates	No. of MS/MSD Pairs	No. of Trip Blanks	No. of Field Blanks	Total No. of Samples to Lab
Ground water And Surface Water	VOCs Low Level	USEPA Methods 5030B/8000B/8260B ¹	Three 40 milliliter glass vials with Teflon® lined septum caps.	Less than 6 degrees C, HCL to pH <2 *	14 days from collection for analysis for preserved sample; 7 days from collection for unpreserved sample	One per 20 samples	One per 20 samples	1 for each cooler	One per 20 samples	TBD
			3 – 40 milliliter vials							
Ground water And Surface Water	Vinyl chloride Styrene Low Level	USEPA Methods 5030B/8000B/8260B ¹	Three 40 milliliter glass vials with Teflon® lined septum caps.	Less than 6 degrees C No acid preservation*	7 days from collection to analysis for unpreserved samples.	One per 20 samples	One per 20 samples	1 for each cooler	One per 20 samples	TBD

***If carbonaceous material or methyl tert butyl ether present or other fuel oxygenated ether present and a high temperature sample preparation method used, do not preserve. If free chlorine is present in the sample, appropriate addition of sodium thiosulfate solution as described in the method must be performed.**

TABLE 1. ANALYTICAL METHODS AND FIELD SAMPLING SUMMARY

Sample Matrix	Analytical Group and Level	Analytical and Preparation Methods and References	Sample Collection Containers and Volumes	Preservation Requirements	Maximum Holding Times	No. of Field Duplicates	No. of MS/MSD Pairs	No. of Trip Blanks	No. of Field Blanks	Total No. of Samples to Lab
Soil	VOCs Low Level and Medium Level	USEPA Methods 5035/8000B/8260B ¹	Three- En Core [®] samplers (5 grams) for each sample location in accordance with USEPA Method 5035. Two En Core [®] samples for Low Level preparation One En Core [®] sample for Medium Level preparation	Less than 6 degrees C	Use Encore sampler to transport samples to laboratory. Transfer sample to soil container within 48 hours from collection and prepare as described below. Otherwise 48 hours from collection to analysis. Freeze sample to -7°C Low level- Soil preserved with 5 mls di-ionized water and frozen to -7°C Medium level- Soil preserved with 5 mls methanol For Low and Medium level- If extruded sample is chemically preserved or frozen, analysis holding time extended to 14 days from collection.	One per 20 samples	One per 20 samples	1 for each cooler	One per 20 samples	TBD

TABLE 1. ANALYTICAL METHODS AND FIELD SAMPLING SUMMARY

Sample Matrix	Analytical Group and Level	Analytical and Preparation Methods and References	Sample Collection Containers and Volumes	Preservation Requirements	Maximum Holding Times	No. of Field Duplicates	No. of MS/MSD Pairs	No. of Trip Blanks	No. of Field Blanks	Total No. of Samples to Lab
Soil	Vinyl chloride Styrene Low Level	USEPA Methods 5030B/8000B/8260B ¹	Three En Core [®] samplers (5 grams) for each sample location in accordance with USEPA Method 5035.	Less than 6 degrees C	Sample aliquot extruded from EnCore [®] sampler. Either de-ionized water is added and the sample is frozen (for low level preparation) until analysis, or methanol is added and the sample preserved at 4°C (for medium level preparation) until analysis. Analysis within 7 days from collection. If not preserved as described above, then 48 hours from collection to analysis.	One per 20 samples	One per 20 samples	1 for each cooler	One per 20 samples	TBD
			Two En Core [®] samples for Low Level preparation One En Core [®] sample for Medium Level preparation							
Air	VOCs	USEPA Method TO-15 ²	6-Liter Stainless-Steel SUMMA [™] Vacuum Canister	None	30 days from collection to analysis	One per 20 samples	NA	NA	One per 20 samples	TBD
Ground Water	Dissolved Gas	Method RSK-175 ³	4-40 milliliter glass vials with Teflon [®] lined septum caps	4°C HCL to pH≤2	14 days from collection to analysis for preserved samples	One per 20 samples	One per 20 samples	NA	One per 20 samples	TBD
Ground Water	Organic Acids	Laboratory Method VFA by IC ⁴	3-40 milliliter Amber glass vials with Teflon [®] lined septum caps Zero headspace	4°C	28 days from collection to analysis	One per 20 samples	One per 20 samples	NA	One per 20 samples	TBD
Ground Water	TOC	USEPA Method 9060 ¹	250-milliliter plastic bottle 200 milliliters	Less than 6 degrees C HCL or H ₂ SO ₄ to pH<2	28 days from collection to analysis	One per 20 samples	One per 20 samples	NA	One per 20 samples	TBD

TABLE 1. ANALYTICAL METHODS AND FIELD SAMPLING SUMMARY

Sample Matrix	Analytical Group and Level	Analytical and Preparation Methods and References	Sample Collection Containers and Volumes	Preservation Requirements	Maximum Holding Times	No. of Field Duplicates	No. of MS/MSD Pairs	No. of Trip Blanks	No. of Field Blanks	Total No. of Samples to Lab
Soil	TOC	USEPA Method 9060 ¹	250 milliliter wide mouth glass container with Teflon® lined lid 100 grams	Less than 6 degrees C	28 days from collection to analysis	One per 20 samples	One per 20 samples	NA	One per 20 samples	TBD
Groundwater	Total Inorganic Carbon	Standard Methods 20 5310B ⁵	250-milliliter plastic bottle 100 milliliters	Less than 6 degrees C HCL, H ₂ SO ₄ or H ₃ PO ₄ to pH<2	28 days from collection to analysis	One per 20 samples	One per 20 samples	NA	One per 20 samples	TBD
Soil	Total Inorganic Carbon	Standard Methods 20 5310B ⁵	250 milliliter wide mouth glass container with Teflon® lined lid 100 grams	Less than 6 degrees C	28 days from collection to analysis	One per 20 samples	One per 20 samples	NA	One per 20 samples	TBD
Groundwater	Metals	USEPA Methods 3010A/6010B/ 6020 ¹	250-milliliter polyethylene or fluorocarbon (TFE or PFA) container 100 milliliters	Less than 6 degrees C HNO ₃ to pH<2	180 days from collection to analysis	One per 20 samples	One per 20 samples	NA	One per 20 samples	TBD
Soil	Metals	USEPA Methods 3050B/6010B/ 6020 ¹	4 ounce wide mouth polyethylene or fluorocarbon (TFE or PFA) container 200 grams	Less than 6 degrees C	180 days from collection to analysis	One per 20 samples	One per 20 samples	NA	One per 20 samples	TBD
Groundwater	Total Mercury	USEPA Methods 7470A ¹	250-milliliter polyethylene or fluorocarbon (TFE or PFA) container 100 milliliters	Less than 6 degrees C HNO ₃ to pH<2	28 days from collection to analysis	One per 20 samples	One per 20 samples	NA	One per 20 samples	TBD

TABLE 1. ANALYTICAL METHODS AND FIELD SAMPLING SUMMARY

Sample Matrix	Analytical Group and Level	Analytical and Preparation Methods and References	Sample Collection Containers and Volumes	Preservation Requirements	Maximum Holding Times	No. of Field Duplicates	No. of MS/MSD Pairs	No. of Trip Blanks	No. of Field Blanks	Total No. of Samples to Lab
Soil	Total Mercury	USEPA Method 7471A ¹	4 ounce wide mouth polyethylene or fluorocarbon (TFE or PFA) container 50 grams	Less than 6 degrees C	28 days from collection to analysis	One per 20 samples	One per 20 samples	NA	One per 20 samples	TBD
Groundwater	Hexavalent Chromium	USEPA Method 7196A ¹	250 or 500 milliliter plastic bottle 100 milliliter	Less than 6 degrees C	24 hours from collection to analysis	One per 20 samples	One per 20 samples	NA	One per 20 samples	TBD
Soil	Hexavalent Chromium	USEPA Methods 3096A/7196A ¹	4 ounce wide mouth glass container. 100 grams	Less than 6 degrees C	Analyze within 30 Days from collection. Analysis is performed within 24 hours of extraction.	One per 20 samples	One per 20 samples	NA	One per 20 samples	TBD
Groundwater	Total Cyanide	USEPA Methods 9010B/9012A ¹	1-500 milliliter plastic bottle. 500 milliliters	NaOH to pH>12 Less than 6 degrees C OA	14 days from collection to analysis	One per 20 samples	One per 20 samples	NA	One per 20 samples	TBD
Soil	Total Cyanide	USEPA Methods 9010B/9012A ¹	4 ounce wide mouth glass container with Teflon® lined lid. 100 grams	Less than 6 degrees C	14 days from collection to analysis	One per 20 samples	One per 20 samples	NA	One per 20 samples	TBD
Groundwater	Ferrous Iron	Standard Methods 20 3500 FE B ⁵	250-milliliter polyethylene or fluorocarbon (TFE or PFA) container 1000 milliliters	Less than 6 degrees C HNO ₃ to pH<2	24 hours from collection to analysis	One per 20 samples	One per 20 samples	NA	One per 20 samples	TBD

TABLE 1. ANALYTICAL METHODS AND FIELD SAMPLING SUMMARY

Sample Matrix	Analytical Group and Level	Analytical and Preparation Methods and References	Sample Collection Containers and Volumes	Preservation Requirements	Maximum Holding Times	No. of Field Duplicates	No. of MS/MSD Pairs	No. of Trip Blanks	No. of Field Blanks	Total No. of Samples to Lab
Groundwater	Hardness	Standard Methods 20 2340B ⁵	NA	NA	NA	NA	NA	NA	NA	TBD
Groundwater	Alkalinity (including carbonate)	Standard Methods 20 2320B ⁵	500-milliliter plastic bottle 200 milliliters	4 degrees C	14 days from collection to analysis	One per 20 samples	One per 20 samples	NA	One per 20 samples	TBD
Groundwater	COD	USEPA Method 410.4 ⁶	500-milliliter plastic bottle 100 milliliters	4 degrees C H ₂ SO ₄ to pH<2	28 days from collection to analysis	One per 20 samples	One per 20 samples	NA	One per 20 samples	TBD
Soil	COD	USEPA Method 410.4 ⁶	4 ounce wide mouth polyethylene or fluorocarbon (TFE or PFA) container 200 grams	4 degrees C	28 days from collection to analysis	One per 20 samples	One per 20 samples	NA	One per 20 samples	TBD
Groundwater	Ammonia	Standard Methods 20 4500 NH ₃ G ⁵	One 1000-milliliter plastic bottle 500 milliliters	4 degrees C H ₂ SO ₄ to pH<2	28 days from collection to analysis	One per 20 samples	One per 20 samples	NA	One per 20 samples	TBD
Groundwater	BOD	Standard Methods 20 5210B ⁵	1000-milliliter plastic bottle 1000 milliliters	4 degrees C	48 hours from collection to analysis	One per 20 samples	One per 20 samples	NA	One per 20 samples	TBD
Groundwater	Total Phosphorus	Standard Methods 20 4500 PE ⁵	One 1000-milliliter plastic bottle 500 milliliters	4 degrees C H ₂ SO ₄ to pH<2	28 days from collection to analysis	One per 20 samples	One per 20 samples	NA	One per 20 samples	TBD
Groundwater	TDS	Standard Methods 20 2540C ⁵	One 250-milliliter plastic bottle 200 milliliters	4 degrees C	7 days from collection to analysis	One per 20 samples	One per 20 samples	NA	One per 20 samples	TBD

TABLE 1. ANALYTICAL METHODS AND FIELD SAMPLING SUMMARY

Sample Matrix	Analytical Group and Level	Analytical and Preparation Methods and References	Sample Collection Containers and Volumes	Preservation Requirements	Maximum Holding Times	No. of Field Duplicates	No. of MS/MSD Pairs	No. of Trip Blanks	No. of Field Blanks	Total No. of Samples to Lab
Groundwater	TSS	Standard Methods 20 2540D ⁵	One 250-milliliter plastic bottle 200 milliliters	4 degrees C	7 days from collection to analysis	One per 20 samples	One per 20 samples	NA	One per 20 samples	TBD
Groundwater	Sulfide	Standard Methods 20 4500 S2E ⁵	One 1000-milliliter plastic bottle 500 milliliters	4 degrees C Add zinc acetate, NaOH to pH>9	7 days from collection to analysis	One per 20 samples	One per 20 samples	NA	One per 20 samples	TBD
Groundwater	Phosphate, Nitrite, Chloride, Sulfate	USEPA Method 9056 ¹	One 250-milliliter plastic bottle 200 milliliters	Less than 6 degrees C	28 days from collection to analysis	One per 20 samples	One per 20 samples	NA	One per 20 samples	TBD
Groundwater	Nitrate	USEPA Method 9056 ¹	One 1000-milliliter plastic bottle 1000 milliliters	Less than 6 degrees C	48 hours from collection to analysis	One per 20 samples	One per 20 samples	NA	One per 20 samples	TBD
Soil	Percent Solids	USEPA Methods Standard Methods 20 2540G ⁵	4 ounce wide mouth polyethylene or fluorocarbon (TFE or PFA) container 50 grams	4 degrees C	As soon as possible	NA	NA	NA	NA	NA
Bedrock	Porosity, Bulk Density	Golder Associates Procedure ⁷	Intact sections of HQ-size core with lengths from 2 to 12 inches depending on test(s) planned, wrapped in the field to prevent moisture loss (aluminum foil, saran wrap, parafilm.	4 degrees C	None	NA	NA	NA	NA	NA

TABLE 1. ANALYTICAL METHODS AND FIELD SAMPLING SUMMARY

Sample Matrix	Analytical Group and Level	Analytical and Preparation Methods and References	Sample Collection Containers and Volumes	Preservation Requirements	Maximum Holding Times	No. of Field Duplicates	No. of MS/MSD Pairs	No. of Trip Blanks	No. of Field Blanks	Total No. of Samples to Lab
---------------	----------------------------	---	--	---------------------------	-----------------------	-------------------------	---------------------	--------------------	---------------------	-----------------------------

Notes:

NA indicates not applicable.

TBD indicates to be determined at a later date.

USEPA indicates United States Environmental Protection Agency.

VOC indicates volatile organic compounds.

TOC indicates total organic carbon.

BOD indicates biochemical oxygen demand.

COD indicates chemical oxygen demand.

TDS indicates total dissolved solids.

TSS indicates total suspended solids.

Hardness will be determined through calculation.

OA indicates that if oxidizing agents are present, add 5 ml 0.1N NaAsO₂ per liter and 0.6g of ascorbic acid per liter.

Method References:

1. USEPA. 2004. *Test Methods for Evaluating Solid Waste: Physical/Chemical Methods, SW-846, 3rd Edition, Update IIIB*. Washington D.C.
2. USEPA. 1999. *Compendium of Methods for the Determination of Toxic Organic Compounds in Ambient Air*. Cincinnati, Ohio
3. Kampbell, D.H., J.T. Wilson, S.A. Vandegrift. 1991. *Dissolved Oxygen and Methane in Water by a GC Headspace Equilibration Technique*, International Journal of Environmental Analytical Chemistry, Volume 36, pp 249-257.
4. TestAmerica. VFA by IC- Organic Acids.
5. AWWA, APHA and WEF. 1998. *Standard Methods for the Examination of Water and Wastewater, 20th Edition*. Washington, D.C.
6. USEPA. 1983. *Methods for Chemical Analysis of Water and Wastes*, EPA-600/4-79-020. Cincinnati, Ohio.
7. Golder Associates Geotechnical Laboratory, Mississauga, Ontario, Canada.

Table 2. Laboratory MDLs, QLs, and Screening Criteria for VOCs in Groundwater and Surface Water

Target Analyte	USEPA Method	QL (ug/L)	MDL (ug/L)	GWGA (ug/L)
1,1,1-Trichloroethane	8260B	TBD	TBD	*
1,1,2,2-Tetrachloroethane	8260B	TBD	TBD	*
1,1,2-Trichloro-1,2,2-trifluoroethane	8260B	TBD	TBD	*
1,1,2-Trichloroethane	8260B	TBD	TBD	1.0
1,1-Dichloroethane	8260B	TBD	TBD	*
1,1-Dichloroethene	8260B	TBD	TBD	*
1,2,3-Trichlorobenzene	8260B	TBD	TBD	*
1,2,4-Trichlorobenzene	8260B	TBD	TBD	*
1,2-Dibromo-3-chloropropane	8260B	TBD	TBD	0.04
1,2-Dibromoethane	8260B	TBD	TBD	NL
1,2-Dichlorobenzene	8260B	TBD	TBD	3.0
1,2-Dichloroethane	8260B	TBD	TBD	0.6
1,2-Dichloropropane	8260B	TBD	TBD	1.0
1,3-Dichlorobenzene	8260B	TBD	TBD	3.0
1,4-Dioxane	8260B	TBD	TBD	NL
1,4-Dichlorobenzene	8260B	TBD	TBD	3.0
2-Butanone	8260B	TBD	TBD	NL
2-Hexanone	8260B	TBD	TBD	NL
4-Methyl-2-pentanone	8260B	TBD	TBD	NL
Acetone	8260B	TBD	TBD	NL
Benzene	8260B	TBD	TBD	1.0
Bromodichloromethane	8260B	TBD	TBD	NL
Bromoform	8260B	TBD	TBD	NL
Bromochloromethane	8260B	TBD	TBD	*
Bromomethane	8260B	TBD	TBD	*
Carbon disulfide	8260B	TBD	TBD	60
Carbon tetrachloride	8260B	TBD	TBD	5.0
Chlorobenzene	8260B	TBD	TBD	*
Chloroethane	8260B	TBD	TBD	*
Chloroform	8260B	TBD	TBD	7.0
Chloromethane	8260B	TBD	TBD	NL
cis-1,2-Dichloroethene	8260B	TBD	TBD	*
cis-1,3-Dichloropropene	8260B	TBD	TBD	0.4
Cyclohexane	8260B	TBD	TBD	NL
Dibromochloromethane	8260B	TBD	TBD	NL
Dichlorodifluoromethane	8260B	TBD	TBD	*
Ethylbenzene	8260B	TBD	TBD	*
Isopropylbenzene	8260B	TBD	TBD	*
Methyl acetate	8260B	TBD	TBD	NL
Methyl tert-butyl ether	8260B	TBD	TBD	NL
Methylcyclohexane	8260B	TBD	TBD	NL
Methylene chloride	8260B	TBD	TBD	*
Styrene	8260B	TBD	TBD	*
Tetrachloroethene	8260B	TBD	TBD	*
Toluene	8260B	TBD	TBD	*
trans-1,2-Dichloroethene	8260B	TBD	TBD	*
trans-1,3-Dichloropropene	8260B	TBD	TBD	0.4
Trichloroethene	8260B	TBD	TBD	*
Trichlorofluoromethane	8260B	TBD	TBD	*
Vinyl chloride	8260B	TBD	TBD	2.0
Xylenes (total)	8260B	TBD	TBD	*

Notes:

QL indicates quantitation limit.

MDL indicate method detection limit.

GWGA indicates New York State Class GA Ground Water Standards, as of April 2009.

ug/L indicates micrograms per liter.

NL indicates not listed.

*The principle organic contaminant standard for ground water of 5 ug/L applies to this compound.

MDLs and QLs will be obtained from the laboratory when determined

Method reference:

1. United States Environmental Protection Agency (USEPA). 2004. *Test Methods for Evaluating Solid Waste: Physical/Chemical Methods*, SW-846, 3rd Edition, Update IIIB. Washington D.C.

Table 3. Laboratory MDLs, QLs, and Screening Criteria for VOCs in Low and Medium Level Soil

Target Analytes	USEPA Method	Low Level QL (ug/kg)	Low Level MDL (ug/kg)	Medium Level QL (ug/kg)	Medium Level MDL (ug/kg)	Un-restricted SCOs (mg/kg)
1,1,1-Trichloroethane	8260B	TBD	TBD	TBD	TBD	0.68
1,1,2,2-Tetrachloroethane	8260B	TBD	TBD	TBD	TBD	NL
1,1,2-Trichloro-1,2,2-trifluoroethane	8260B	TBD	TBD	TBD	TBD	NL
1,1,2-Trichloroethane	8260B	TBD	TBD	TBD	TBD	NL
1,1-Dichloroethane	8260B	TBD	TBD	TBD	TBD	0.27
1,1-Dichloroethene	8260B	TBD	TBD	TBD	TBD	0.33
1,2,3-Trichlorobenzene	8260B	TBD	TBD	TBD	TBD	NL
1,2,4-Trichlorobenzene	8260B	TBD	TBD	TBD	TBD	NL
1,2-Dibromo-3-chloropropane	8260B	TBD	TBD	TBD	TBD	NL
1,2-Dibromoethane	8260B	TBD	TBD	TBD	TBD	NL
1,2-Dichlorobenzene	8260B	TBD	TBD	TBD	TBD	1.1
1,2-Dichloroethane	8260B	TBD	TBD	TBD	TBD	0.02
1,2-Dichloropropane	8260B	TBD	TBD	TBD	TBD	NL
1,3-Dichlorobenzene	8260B	TBD	TBD	TBD	TBD	2.4
1,4-Dioxane	8260B	TBD	TBD	TBD	TBD	0.1
1,4-Dichlorobenzene	8260B	TBD	TBD	TBD	TBD	1.8
2-Butanone	8260B	TBD	TBD	TBD	TBD	0.12
2-Hexanone	8260B	TBD	TBD	TBD	TBD	NL
4-Methyl-2-pentanone	8260B	TBD	TBD	TBD	TBD	NL
Acetone	8260B	TBD	TBD	TBD	TBD	0.05
Benzene	8260B	TBD	TBD	TBD	TBD	0.06
Bromochloromethane	8260B	TBD	TBD	TBD	TBD	NL
Bromodichloromethane	8260B	TBD	TBD	TBD	TBD	NL
Bromoform	8260B	TBD	TBD	TBD	TBD	NL
Bromomethane	8260B	TBD	TBD	TBD	TBD	NL
Carbon disulfide	8260B	TBD	TBD	TBD	TBD	NL
Carbon tetrachloride	8260B	TBD	TBD	TBD	TBD	0.76
Chlorobenzene	8260B	TBD	TBD	TBD	TBD	1.1
Chloroethane	8260B	TBD	TBD	TBD	TBD	NL
Chloroform	8260B	TBD	TBD	TBD	TBD	0.37
Chloromethane	8260B	TBD	TBD	TBD	TBD	NL
cis-1,2-Dichloroethene	8260B	TBD	TBD	TBD	TBD	0.25
cis-1,3-Dichloropropene	8260B	TBD	TBD	TBD	TBD	NL
Cyclohexane	8260B	TBD	TBD	TBD	TBD	NL
Dibromochloromethane	8260B	TBD	TBD	TBD	TBD	NL
Dichlorodifluoromethane	8260B	TBD	TBD	TBD	TBD	NL
Ethylbenzene	8260B	TBD	TBD	TBD	TBD	1
Isopropylbenzene	8260B	TBD	TBD	TBD	TBD	NL
Methyl acetate	8260B	TBD	TBD	TBD	TBD	NL
Methyl tert-butyl ether	8260B	TBD	TBD	TBD	TBD	0.93
Methylcyclohexane	8260B	TBD	TBD	TBD	TBD	NL
Methylene chloride	8260B	TBD	TBD	TBD	TBD	0.05
Styrene	8260B	TBD	TBD	TBD	TBD	NL
Tetrachloroethene	8260B	TBD	TBD	TBD	TBD	1.3
Toluene	8260B	TBD	TBD	TBD	TBD	0.7
trans-1,2-Dichloroethene	8260B	TBD	TBD	TBD	TBD	0.19
trans-1,3-Dichloropropene	8260B	TBD	TBD	TBD	TBD	NL
Trichloroethene	8260B	TBD	TBD	TBD	TBD	0.47
Trichlorofluoromethane	8260B	TBD	TBD	TBD	TBD	NL
Vinyl chloride	8260B	TBD	TBD	TBD	TBD	0.02
Xylenes (total)	8260B	TBD	TBD	TBD	TBD	0.26

Notes:

QL indicates quantitation limit.
MDL indicate method detection limit.
SCOs indicates 6 NYCRR Part 375 soil cleanup objectives, as of April 2009.
ug/kg indicates micrograms per kilogram.
mg/kg indicates milligrams per kilogram.
NL indicates not listed.
MDLs and QLs will be obtained from the laboratory when determined.
Medium level soil assumes 5 grams of sample and 100 microliters of extract analyzed.

Method reference:

1. United States Environmental Protection Agency (USEPA). 2004. *Test Methods for Evaluating Solid Waste: Physical/Chemical Methods*, SW-846, 3rd Edition, Update IIIB. Washington D.C.

Table 4. Laboratory QLs and Screening Criteria for VOCs in Air

			Indoor Air and Ambient Air	Indoor Air and Ambient Air	Soil Vapor	Soil Vapor	Indoor Air NYS Screening Levels ²	Indoor Air NYS Screening Levels ²	Soil Vapor NYS Screening Levels ²	Soil Vapor NYS Screening Levels ²
			Laboratory QL ^{1,*}	Laboratory QL ^{1,*}	Laboratory QL ^{1,*}	Laboratory QL ^{1,*}	ppbv	ug/m3	ppbv	ug/m3
Target Analyte	USEPA Method	M.W.	ppbv	ug/m3	ppbv	ug/m3	ppbv	ug/m3	ppbv	ug/m3
Acetone	USEPA Method TO-15	58.078	TBD	TBD	TBD	TBD	NA	NA	NA	NA
Benzene	USEPA Method TO-15	78.108	TBD	TBD	TBD	TBD	NA	NA	NA	NA
Bromodichloromethane	USEPA Method TO-15	163.83	TBD	TBD	TBD	TBD	NA	NA	NA	NA
Bromoform	USEPA Method TO-15	252.75	TBD	TBD	TBD	TBD	NA	NA	NA	NA
Bromomethane	USEPA Method TO-15	94.94	TBD	TBD	TBD	TBD	NA	NA	NA	NA
Chlorobenzene	USEPA Method TO-15	112.55	TBD	TBD	TBD	TBD	NA	NA	NA	NA
Chloroethane	USEPA Method TO-15	64.52	TBD	TBD	TBD	TBD	NA	NA	NA	NA
Chloroform	USEPA Method TO-15	119.38	TBD	TBD	TBD	TBD	NA	NA	NA	NA
Chloromethane	USEPA Method TO-15	50.49	TBD	TBD	TBD	TBD	NA	NA	NA	NA
Carbon disulfide	USEPA Method TO-15	76.14	TBD	TBD	TBD	TBD	NA	NA	NA	NA
Carbon tetrachloride	USEPA Method TO-15	153.81	TBD	TBD	TBD	TBD	0.25	NA	5	NA
Cyclohexane	USEPA Method TO-15	84.16	TBD	TBD	TBD	TBD	NA	NA	NA	NA
Dibromochloromethane	USEPA Method TO-15	208.29	TBD	TBD	TBD	TBD	NA	NA	NA	NA
1,1-Dichloroethane	USEPA Method TO-15	98.96	TBD	TBD	TBD	TBD	NA	NA	NA	NA
1,2-Dichloroethane	USEPA Method TO-15	98.96	TBD	TBD	TBD	TBD	NA	NA	NA	NA
1,1-Dichloroethene	USEPA Method TO-15	96.94	TBD	TBD	TBD	TBD	3	NA	100	NA
1,2-Dichloroethene (cis)	USEPA Method TO-15	96.94	TBD	TBD	TBD	TBD	3	NA	100	NA
1,2-Dichloroethene (trans)	USEPA Method TO-15	96.94	TBD	TBD	TBD	TBD	NA	NA	NA	NA
1,2-Dichloroethene (total)**	USEPA Method TO-15	—	TBD	TBD	TBD	TBD	NA	NA	NA	NA
1,2-Dichloropropane	USEPA Method TO-15	112.99	TBD	TBD	TBD	TBD	NA	NA	NA	NA

Table 4. Laboratory QLs and Screening Criteria for VOCs in Air

			Indoor Air and Ambient Air	Indoor Air and Ambient Air	Soil Vapor	Soil Vapor	Indoor Air NYS Screening Levels ²	Indoor Air NYS Screening Levels ²	Soil Vapor NYS Screening Levels ²	Soil Vapor NYS Screening Levels ²
			Laboratory QL ^{1,*}	Laboratory QL ^{1,*}	Laboratory QL ^{1,*}	Laboratory QL ^{1,*}				
Target Analyte	USEPA Method	M.W.	ppbv	ug/m3	ppbv	ug/m3	ppbv	ug/m3	ppbv	ug/m3
1,3-Dichloropropene (cis)	USEPA Method TO-15	110.97	TBD	TBD	TBD	TBD	NA	NA	NA	NA
1,3-Dichloropropene (trans)	USEPA Method TO-15	110.97	TBD	TBD	TBD	TBD	NA	NA	NA	NA
1,3-Dichloropropene (total)**	USEPA Method TO-15	-	TBD	TBD	TBD	TBD	NA	NA	NA	NA
Ethylbenzene	USEPA Method TO-15	106.17	TBD	TBD	TBD	TBD	NA	NA	NA	NA
Methylene Chloride	USEPA Method TO-15	84.93	TBD	TBD	TBD	TBD	NA	NA	NA	NA
Methyl isobutyl ketone	USEPA Method TO-15	100.16	TBD	TBD	TBD	TBD	NA	NA	NA	NA
Styrene	USEPA Method TO-15	104.15	TBD	TBD	TBD	TBD	NA	NA	NA	NA
1,1,2,2-Tetrachloroethane	USEPA Method TO-15	167.85	TBD	TBD	TBD	TBD	NA	NA	NA	NA
Tetrachloroethene	USEPA Method TO-15	165.83	TBD	TBD	TBD	TBD	3	NA	100	NA
Toluene	USEPA Method TO-15	92.14	TBD	TBD	TBD	TBD	NA	NA	NA	NA
1,1,1-Trichloroethane	USEPA Method TO-15	133.41	TBD	TBD	TBD	TBD	3	NA	100	NA
1,1,2-Trichloroethane	USEPA Method TO-15	133.41	TBD	TBD	TBD	TBD	NA	NA	NA	NA
Trichloroethene	USEPA Method TO-15	131.39	TBD	TBD	TBD	TBD	0.25	NA	5	NA
1,2,4-Trimethylbenzene	USEPA Method TO-15	120.2	TBD	TBD	TBD	TBD	NA	NA	NA	NA
Vinyl chloride	USEPA Method TO-15	62.5	TBD	TBD	TBD	TBD	0.25	NA	5	NA
Xylenes (m&p)	USEPA Method TO-15	106.17	TBD	TBD	TBD	TBD	NA	NA	NA	NA
Xylenes (o)	USEPA Method TO-15	106.17	TBD	TBD	TBD	TBD	NA	NA	NA	NA
Xylenes (total)	USEPA Method TO-15	-	TBD	TBD	TBD	TBD	NA	NA	NA	NA

Notes:

1 The values will be based on 6 Liter sample container.

2 New York State Department of Health, Guidance for Evaluating Soil Vapor Intrusion in the State of New York, October 2006

USEPA indicates United States Environmental Protection Agency

MW indicates Molecular weight

QL indicates Quantitation limit

ppbv indicates parts per billion by volume

ug/m3 indicates micrograms per cubic meter

* Indicates that the laboratory will report the results to the QL level only.

TBD indicates that the laboratory will provide the QLs when determined.

NL indicates that the screening level is not listed.

Method reference:
 United States Environmental Protection Agency. 1999. *Compendium of Methods for the Determination of Toxic Organic Compounds in Ambient Air*. Cincinnati, Ohio

Table 5. Laboratory MDLs, QLs, and Screening Criteria for Dissolved Gases in Groundwater

Target Analyte	Method	QL (ug/L)	MDL (ug/L)	GWGA (ug/L)
Methane	RSK-175	TBD	TBD	NL
Ethane	RSK-175	TBD	TBD	NL
Ethene	RSK-175	TBD	TBD	NL

Notes:
QL indicates quantitation limit.
MDL indicate method detection limit.
GWGA indicates New York State Class GA Ground Water Standards, as of April 2009.
ug/L indicates micrograms per liter.
NL indicates not listed.

MDLs and QLs will be obtained from the laboratory when determined

Method reference:
1. Kampbell, D.H., J.T. Wilson, S.A. Vandegrift. 1991. Dissolved Oxygen and Methane in Water by a GC Headspace Equilibration Technique, International Journal of Environmental Analytical Chemistry, Volume 36, pp 249-257.

Table 6. Laboratory MDLs, QLs, and Screening Criteria for Organic Acids in Groundwater

Target Analyte	Method	QL (ug/L)	MDL (ug/L)	GWGA (ug/L)
Lactate	Laboratory Method VFA by IC	TBD	TBD	NL
Propionate	Laboratory Method VFA by IC	TBD	TBD	NL
Butyrate	Laboratory Method VFA by IC	TBD	TBD	NL
Acetate	Laboratory Method VFA by IC	TBD	TBD	NL

Notes:
 QL indicates quantitation limit.
 MDL indicate method detection limit.
 GWGA indicates New York State Class GA Ground Water Standards, as of April 2009.
 ug/L indicates micrograms per liter.
 NL Indicates not listed.

MDLs and QLs will be obtained from the laboratory when determined

Method reference:

1. TestAmerica. VFA by IC- Organic Acids.

Table 7. Laboratory MDLs, QLs, and Screening Criteria for Metals, Hexavalent Chromium, Cyanide, Ferrous Iron, Hardness and Alkalinity in Groundwater

TAL Target Analytes	Method	QL (ug/L)	MDL (ug/L)	GWGA (ug/L)
Aluminum	USEPA Methods 6010B/6020 ¹	TBD	TBD	NL
Antimony	USEPA Methods 6010B/6020 ¹	TBD	TBD	3
Arsenic	USEPA Methods 6010B/6020 ¹	TBD	TBD	25
Barium	USEPA Methods 6010B/6020 ¹	TBD	TBD	1000
Beryllium	USEPA Methods 6010B/6020 ¹	TBD	TBD	NL
Cadmium	USEPA Methods 6010B/6020 ¹	TBD	TBD	5
Calcium	USEPA Methods 6010B/6020 ¹	TBD	TBD	NL
Total Chromium	USEPA Methods 6010B/6020 ¹	TBD	TBD	50
Cobalt	USEPA Methods 6010B/6020 ¹	TBD	TBD	NL
Copper	USEPA Methods 6010B/6020 ¹	TBD	TBD	200
Iron*	USEPA Methods 6010B/6020 ¹	TBD	TBD	300
Lead	USEPA Methods 6010B/6020 ¹	TBD	TBD	25
Magnesium	USEPA Methods 6010B/6020 ¹	TBD	TBD	NL
Manganese*	USEPA Methods 6010B/6020 ¹	TBD	TBD	300
Total Mercury	USEPA Method 7470A ¹	TBD	TBD	0.7
Nickel	USEPA Methods 6010B/6020 ¹	TBD	TBD	100
Potassium	USEPA Methods 6010B/6020 ¹	TBD	TBD	NL
Selenium	USEPA Methods 6010B/6020 ¹	TBD	TBD	10
Silver	USEPA Methods 6010B/6020 ¹	TBD	TBD	50
Sodium	USEPA Methods 6010B/6020 ¹	TBD	TBD	20000
Thallium	USEPA Methods 6010B/6020 ¹	TBD	TBD	NL
Vanadium	USEPA Methods 6010B/6020 ¹	TBD	TBD	NL
Zinc	USEPA Methods 6010B/6020 ¹	TBD	TBD	NL
Total Cyanide	USEPA Methods 9010B/9012A ¹	TBD	TBD	200
Hexavalent chromium	USEPA Method 7196A ¹	TBD	TBD	50
Ferrous Iron	SM 3500 FE B ²	TBD	TBD	NL
Alkalinity	SM 2320B ²	TBD	TBD	NL
Hardness	SM 2340B ²	TBD	TBD	NL

Notes:

QL indicates quantitation limit.

MDL indicate method detection limit.

ug/L indicates micrograms per liter.

NL Indicates not listed.

Target Analyte List (TAL) resource - ILM05.4.

GWGA indicates New York State Class GA Ground Water Standards, as of December 2010.

MDLs and QLs will be obtained from the laboratory when determined

* Indicates the screening criterion of 500 ug/L for total iron and manganese is applied.

Method references:

1- United States Environmental Protection Agency (USEPA). 2004. Test Methods for Evaluating Solid Waste: Physical/Chemical Methods, SW-846, 3rd Edition, Update IIIB. Washington D.C.

2- American Water Works Association (AWWA), American Public Health Association (APHA) and Water Environment Federation (WEF). 1998. Standard Methods for the Examination of Water and Wastewater, 20th Edition. Washington, D.C.

Table 8. Laboratory MDLs, QLs, and Screening Criteria for Metals, Cyanide, Hexavalent Chromium, COD, TOC and TIC in Soil

Target Analyte	Method	QL (ug/Kg)	MDL (ug/Kg)	Un-restricted SCOs (mg/kg)
Aluminum	USEPA Methods 6010B/6020 ¹	TBD	TBD	NL
Antimony	USEPA Methods 6010B/6020 ¹	TBD	TBD	NL
Arsenic	USEPA Methods 6010B/6020 ¹	TBD	TBD	13 ^c
Barium	USEPA Methods 6010B/6020 ¹	TBD	TBD	350 ^c
Beryllium	USEPA Methods 6010B/6020 ¹	TBD	TBD	7.2
Cadmium	USEPA Methods 6010B/6020 ¹	TBD	TBD	2.5 ^c
Calcium	USEPA Methods 6010B/6020 ¹	TBD	TBD	NL
Total Chromium	USEPA Methods 6010B/6020 ¹	TBD	TBD	30 ^c
Cobalt	USEPA Methods 6010B/6020 ¹	TBD	TBD	NL
Copper	USEPA Methods 6010B/6020 ¹	TBD	TBD	50
Iron*	USEPA Methods 6010B/6020 ¹	TBD	TBD	NL
Lead	USEPA Methods 6010B/6020 ¹	TBD	TBD	63 ^c
Magnesium	USEPA Methods 6010B/6020 ¹	TBD	TBD	NL
Manganese*	USEPA Methods 6010B/6020 ¹	TBD	TBD	1600 ^c
Total Mercury	USEPA Method 7471A ¹	TBD	TBD	0.18 ^c
Nickel	USEPA Methods 6010B/6020 ¹	TBD	TBD	30
Potassium	USEPA Methods 6010B/6020 ¹	TBD	TBD	NL
Selenium	USEPA Methods 6010B/6020 ¹	TBD	TBD	3.9 ^c
Silver	USEPA Methods 6010B/6020 ¹	TBD	TBD	2
Sodium	USEPA Methods 6010B/6020 ¹	TBD	TBD	NL
Thallium	USEPA Methods 6010B/6020 ¹	TBD	TBD	NL
Vanadium	USEPA Methods 6010B/6020 ¹	TBD	TBD	NL
Zinc	USEPA Methods 6010B/6020 ¹	TBD	TBD	109 ^c
Total Cyanide	USEPA Methods 9010B/9012A ¹	TBD	TBD	27
Hexavalent chromium	USEPA Method 7196A ¹	TBD	TBD	1 ^b
COD	USEPA Method 410.4 ²	TBD	TBD	NL
TOC	USEPA Method 9060 ¹	TBD	TBD	NL
TIC	SM 5310B ³	TBD	TBD	NL
<p>Notes: QL indicates quantitation limit. MDL indicate method detection limit. ug/Kg indicates micrograms per kilogram. mg/kg indicates milligrams per kilogram. NL Indicates not listed. SCOs indicates 6 NYCRR Part 375 soil cleanup objectives, as of December 2010. b indicates that for constituents where the calculated SCO was lower than the contract required quantitation limit (CRQL), the CRQL is used as the Track 1 SCO value c indicates that for constituents where the calculated SCO was lower than the rural soil background concentration, as determined by the Department and Department of Health rural soil survey, the rural soil background concentration is used as the Track 1 SCO value for this use of the site. MDLs and QLs will be obtained from the laboratory when determined.</p> <p>Method references: 1- United States Environmental Protection Agency (USEPA). 2004. Test Methods for Evaluating Solid Waste: Physical/Chemical Methods, SW-846, 3rd Edition, Update IIIB. Washington D.C. 2- United States Environmental Protection Agency (USEPA). 1983. Methods for Chemical Analysis of Water and Wastes, EPA-600/4-79-020. Cincinnati, Ohio. 3- American Water Works Association (AWWA), American Public Health Association (APHA) and Water Environment Federation (WEF). 1998. Standard Methods for the Examination of Water and Wastewater, 20th Edition. Washington, D.C.</p>				

Table 9. Laboratory MDLs, QLs, and Screening Criteria for Sulfide, Phosphate, Nitrate, Nitrite, Chloride, Sulfate, TOC, Ammonia, COD, TIC, BOD, Total Phosphorus, TDS and TSS in Ground Water

Target Analyte	Method	QL (ug/L)	MDL (ug/L)	GWGA (ug/L)
Sulfide	SM 4500 S2E ¹	TBD	TBD	NL
Phosphate	USEPA Method 9056 ²	TBD	TBD	NL
Nitrate**	USEPA Method 9056 ²	TBD	TBD	10,000
Nitrite**	USEPA Method 9056 ²	TBD	TBD	1,000
Chloride	USEPA Method 9056 ²	TBD	TBD	250,000
Sulfate	USEPA Method 9056 ²	TBD	TBD	250,000
TOC	USEPA Method 9060 ²	TBD	TBD	NL
Ammonia	SM 4500 NH3G ¹	TBD	TBD	2,000
COD	USEPA Method 410.4 ³	TBD	TBD	NL
TIC	SM 5310B ¹	TBD	TBD	NL
BOD	SM 5210B ¹	TBD	TBD	NL
Total Phosphorus	SM 4500 PE ¹	TBD	TBD	NL
TDS	SM 2540C ¹	TBD	TBD	500,000
TSS	SM 2540D ¹	TBD	TBD	NL

Notes:

QL indicates quantitation limit.

MDL indicate method detection limit.

ug/L indicates micrograms per liter.

*The principle organic contaminant standard for ground water of 5 ug/L applies to this compound.

NL indicates screening criteria not listed.

* Indicates the screening criterion of 10,000 ug/L for total nitrate and nitrite is applied.

GWGA indicates New York State Class GA Ground Water Standards, as of April 2009.

MDLs and QLs will be obtained from the laboratory when determined

Method references:

1- American Water Works Association (AWWA), American Public Health Association (APHA) and Water Environment Federation (WEF). 1998. Standard Methods for the Examination of Water and Wastewater, 20th Edition. Washington, D.C.

2- United States Environmental Protection Agency (USEPA). 2004. Test Methods for Evaluating Solid Waste: Physical/Chemical Methods, SW-846, 3rd Edition, Update IIIB. Washington D.C.

3- United States Environmental Protection Agency (USEPA). 1983. Methods for Chemical Analysis of Water and Wastes, EPA-600/4-79-020. Cincinnati, Ohio.

Table 10. VOCs using USEPA Method 8260B Quality Control Requirements and Corrective Actions.

Audit	Frequency	Control Limits	Corrective Action
Holding times	Samples must be analyzed within holding time.	<p>Analyze within 7 days from collection for unpreserved aqueous samples and for vinyl chloride and styrene, and 14 days from collection for preserved aqueous samples.</p> <p>For solid samples: Sample aliquot extruded from EnCore® sampler. Either de-ionized water is added and the sample is frozen (for low level preparation) until analysis, or methanol is added and the sample preserved at 4°C (for medium level preparation) until analysis. Analysis within 14 days from collection.</p> <p>If not preserved as described above, then 48 hours from collection for analysis.</p>	<ol style="list-style-type: none"> 1. If holding times are exceeded for initial or any re-analyses required due to quality control (QC) excursions. 2. Notify QA Officer since re-sampling may be required. 3. Document corrective action in the case narrative.
GC/MS Instrument Performance Check	<p>Once every 12 hours prior to initial calibration and calibration verifications.</p> <p>Analytical sequence must be completed within 12 hours of the GC/MS Instrument Performance Check</p>	<ol style="list-style-type: none"> 1. Bromofluorobenzene (BFB) key ions and abundance criteria listed in the method must be met for all 9 ions and analyses must be performed within 12 hours of injection of the BFB. 2. Part of the BFB peak will not be background subtracted to meet tune criteria. 3. Documentation of all bromofluorobenzene analyses and evaluation must be included in the data packages. 	<ol style="list-style-type: none"> 1. Tune the mass spectrometer. 2. Document corrective action in the case narrative. 3. Samples cannot be analyzed until control limit criteria have been met.

Table 10. VOCs using USEPA Method 8260B Quality Control Requirements and Corrective Actions.

Audit	Frequency	Control Limits	Corrective Action
Initial Calibration	<p>Prior to sample analysis and when calibration verifications criteria are not met.</p> <p>Initial calibration will contain all target analytes in each standard.</p> <p>Quantitation of analyses will utilize the initial calibration results.</p>	<ol style="list-style-type: none"> Five concentrations bracketing expected concentration range for all compounds of interest. One second-source standard must be analyzed immediately following the initial calibration at the mid-calibration concentration. This standard must be within 30% recovery or within laboratory control limits. It is also recommended that a separate standard at the MDL level be analyzed after calibration is complete to check sensitivity. Minimum average response factor (RF) as listed in Method 8260B, with remaining min. avg. RFs factor ≥ 0.050 except for ketones with allowable min. avg. response factor ≥ 0.010. For compound with %RSD >15, quantitation must be performed using a separate calibration curve and the Coefficient of Determination (COD) must be ≥ 0.990. 	<ol style="list-style-type: none"> Identify and correct problem. If criteria are still not met, recalibrate. Document corrective action in the case narrative. Samples should not be analyzed until calibration control limit criteria are met. Contact QA Officer to discuss problem target analytes before proceeding with analysis.
Calibration Verification	<p>Every 12 hours, following BFB.</p> <p>The calibration verification will contain all target analytes in each standard at a concentration that is representative of the midpoint of the initial calibration.</p>	<ol style="list-style-type: none"> Within percent drift or percent difference (%D) of ≤ 20 for CCCs and $\leq 50\%$ for all non-CCC compounds. RF requirements are the same as listed in the initial calibration. The internal standards areas and retention times must meet the method criteria. 	<ol style="list-style-type: none"> Reanalyze. If criteria are still not met, identify and correct problem, recalibrate. Document corrective action in the case narrative; samples should not be analyzed until calibration control limit criteria are met.
Preparation Blank Analysis	<p>Every 12 hours, following calibration verification</p>	<p>Methylene chloride less than 3 times QL, 2-butanone and acetone less than 5 times QL. Remaining analytes less than QL. QLs and MDLs will be provided along with the preparation blank results.</p>	<ol style="list-style-type: none"> Reanalyze blank. If limits are still exceeded, clean instrument, recalibrate analytical system, and reanalyze all samples if detected for same compounds as in blank. Document corrective action in the case narrative - samples cannot be analyzed until blank criteria have been met.
Field/Equipment Blank Analysis	<p>Collected one per sampling event, or one per 20 samples or one per matrix (for less than 20 samples)</p>	<p>Methylene chloride less than 3 times QL, 2-butanone and acetone less than 5 times QL. Remaining analytes less than QL. QLs and MDLs will be provided along with the preparation blank results.</p>	<ol style="list-style-type: none"> Report results .

Table 10. VOCs using USEPA Method 8260B Quality Control Requirements and Corrective Actions.

Audit	Frequency	Control Limits	Corrective Action
Trip Blank	1 per cooler containing VOC samples.	Methylene chloride less than 3 times QL, 2-butanone and acetone less than 5 times QL. Remaining analytes less than QL. QLs and MDLs will be provided along with the preparation blank results.	1. Report results .
Laboratory Control Sample Analysis	Each analytical batch (every 12 hours). Prepared independently from calibration standards. Spike must contain all target analytes and should be at a concentration, which is in the lower 1/2 of the calibration curve.	Recovery within laboratory control limits. For compounds without established laboratory control limits, 70-130% recovery will be used. The lowest acceptable control limits for recovery will be 10%.	1. If recovery failures are above control limits and these compounds are not detected in the associated samples, corrective action is not required. 2. If recovery failures are below control limits, reanalyze LCS and examine results of other QC analyses. 3. If other QC criteria have not been met, stop analysis, locate and correct problem, recalibrate instrument and reanalyze samples since last satisfactory LCS. 4. Document corrective action in the case narrative.
Internal Standards	All samples and blanks (including MS/MSD)	1. Response -50% - +200% of internal standards from continuing calibration of the day. 2. RT must be \pm 30 sec. from associated calibration verification standard of that sequence.	1. Reanalyze. 2. If still outside of the limits, report both analyses. 3. Document corrective action in the case narrative.
Surrogate Spike	All samples and blanks (including MS/MSD)	Recovery within laboratory control limits. The lowest acceptable control limits for recovery will be 10%.	1. Reanalyze any environmental or QC sample with surrogates that exceed control limits. 2. If still outside of the limits, report both analyses. 3. Document corrective action in the case narrative.

Table 10. VOCs using USEPA Method 8260B Quality Control Requirements and Corrective Actions.

Audit	Frequency	Control Limits	Corrective Action
Matrix Spike/ Matrix Spike Dup. (MS/MSD) Analysis	<p>Collected one per 20 samples or one per matrix (for less than 20 samples)</p> <p>Samples from the investigation must be used for MS/MSD analysis. If samples were not designated as MS/MSD samples, contact Project Manager upon receipt of samples at the laboratory.</p> <p>Spike must contain complete list of target analytes.</p>	<p>Recovery and RPD within laboratory control limits. For compounds without established laboratory control limits, 70-130% recovery will be used.</p> <p>The lowest acceptable control limits for recovery will be 10%.</p>	<ol style="list-style-type: none"> 1. If LCS criteria are met, document in case narrative; no additional corrective action required. 2. If LCS criteria are exceeded also, examine other QC data for source of problem; <i>i.e.</i>, surrogate recoveries for extraction efficiency and calibration data for instrument performance issues. 3. Reanalyze samples and associated MS/MSD and LCSs as required. 4. Document corrective action in the case narrative
Field Dup. Analysis	<p>Collected one per 20 samples or one per matrix (for less than 20 samples)</p> <p>Field duplicate will not be identified to the laboratory.</p>	<p>Validation criteria: 50% RPD for waters, 100% RPD for solids.</p> <p>For sample results that are less than or equal to five times the QL, the criterion of plus or minus two times the QL will be applied to evaluate field duplicates.</p>	<p>No corrective action required of the laboratory since the laboratory will not know the identity of the field duplicate samples. If these criteria are not met, sample results will be evaluated on a case-by-case basis.</p>

Table 10. VOCs using USEPA Method 8260B Quality Control Requirements and Corrective Actions.

Audit	Frequency	Control Limits	Corrective Action
Target Analyte Identification	As required for identification of target analytes	<ol style="list-style-type: none"> 1. The intensities of the characteristic ions of a compound maximize in the same scan or within one scan of each other. Selection of a peak by a data system target compound search routine where the search is based on the presence of a target chromatographic peak containing ions specific for the target compound at a compound-specific retention time will be accepted as meeting this criterion. 2. The relative retention time (RRT) of the sample component is within ± 0.06 RRT units of the RRT of the standard component. 3. The relative intensities of the characteristic ions agree within 30% of the relative intensities of these ions in the reference spectrum. (Example: For an ion with an abundance of 50% in the reference spectrum, the corresponding abundance in a sample spectrum can range between 20% and 80%.) 4. Structural isomers that produce very similar mass spectra should be identified as individual isomers if they have sufficiently different GC retention times 5. Identification is hampered when sample components are not resolved chromatographically and produce mass spectra containing ions contributed by more than one analyte. When gas chromatographic peaks obviously represent more than one sample component (i.e., a broadened peak with shoulder(s) or a valley between two or more maxima), appropriate selection of analyte spectra and background spectra is important. 	Not applicable

Table 10. VOCs using USEPA Method 8260B Quality Control Requirements and Corrective Actions.

Audit	Frequency	Control Limits	Corrective Action
Target Analyte Identification	As required for identification of target analytes	Examination of extracted ion current profiles of appropriate ions can aid in the selection of spectra, and in qualitative identification of compounds. When analytes co-elute (i.e., only one chromatographic peak is apparent), the identification criteria may be met, but each analyte spectrum will contain extraneous ions contributed by the coeluting compound.	Not applicable
Target Analyte Quantitation	Apply USEPA Method 8000C for medium level extraction technique	Moisture correction in accordance with USEPA Method 8000C will be applied to the complete set of solid samples, regardless of the percent moisture content..	Not applicable
Tentatively Identified Compound	If required, perform for each sample and blank analysis. Non-target compounds will be reported using a Mass Spectral Library search.	Not applicable	Not applicable
Dilutions	<ol style="list-style-type: none"> 1. When target analyte concentration exceeds upper limit of calibration curve. 2. When matrix interference is demonstrated by the lab and documented in the case narrative (highly viscous samples or a large number of nontarget peaks on the chromatogram). 3. It is recommended that a reagent blank be analyzed if an analyte saturates the detector or if highly concentrated analytes are detected. Otherwise data impacted from carryover cannot be used. 4. Laboratory will note in the data deliverables which analytical runs were reported. 	<ol style="list-style-type: none"> 1. The reagent blank will meet the method blank criteria. 	<ol style="list-style-type: none"> 1. Reanalyze reagent blank until method blank criteria are met. 2. Document corrective action in the case narrative.
Percent solids	For soil samples, the percent solids will be determined and sample results will be corrected for percent solids.	Not applicable	Not applicable
pH Determination	Once sample analysis is complete, the pH of water samples must be determined.	Record pH and report in the case narrative.	Not applicable
Sample Batching	The laboratory will batch project samples together along with QC samples specified from the project. Non-project information will not be included in the data packages.	Not applicable	Not applicable

Table 10. VOCs using USEPA Method 8260B Quality Control Requirements and Corrective Actions.

Audit	Frequency	Control Limits	Corrective Action
Laboratory control limits	Generated with results for an analyte from a minimum of 20 sample analyses. The average of the sample results and the standard deviation are calculated. The internal warning limits are established at 2 times the standard deviation and the control limits are established at 3 times the standard deviation. The control limits are updated annually.	Not applicable	Not applicable
Deliverables	<ol style="list-style-type: none"> 1. CLP-like deliverables must be provided to document each audit item for easy reference and inspection. 2. The calculation formula will be provided for each analysis, for each type of matrix in the data package. 3. Any laboratory abbreviations or notations presented in the raw data or summary information will be explained or referenced in the case narrative. 4. Final spiking concentrations will be presented in summary form. 5. Cooler temperatures and any observations of bubbles in sample containers will be provided in the data packages. 6. Run logs will be provided in the data packages. 	Not applicable	Provide missing or additional deliverables for validation purposes.
Method and QC Document requirements	The laboratory will perform the method as presented in this QC Document and will adhere to the QC Document requirements presented herein. Otherwise the laboratory will specifically note any procedures that differ from the method or the QC Document in the data package case narrative.	Not applicable	Not applicable
<p>Notes:</p> <p>Data validation will be performed in accordance with QA/QC criteria established in these tables and the analytical methods. Excursions from QA/QC criteria will be qualified based on guidance provided in this QCD.</p> <p>Communications with the QA Officer will be documented and included in the data packages.</p> <p>Source: O'Brien & Gere</p>			

Table 11. VOCs using USEPA Method TO-15 Quality Control Requirements and Corrective Actions.

Audit	Frequency	Control Limits	Corrective Action
Holding Times	<p>Samples must be analyzed within holding time.</p> <p>Used and un-used canisters must be returned to the laboratory within 15 days of shipment of the canisters to the sampling location.</p>	<p>Analyze within 30 days of sample collection.</p> <p>Preservation of sample containers is not required.</p>	<p>If holding times are exceeded for initial or re-analyses required, notify QAO since re-sampling may be required.</p> <p>Document corrective action in the case narrative</p>
Canister Preparation	<ol style="list-style-type: none"> 1. Canisters are equipped with a laboratory preset regulator, pressure gauge, critical orifice, stainless steel frit dust filter over the orifice, and specially prepared interior surfaces. 2. The flow controller (regulator) is preset at the laboratory for sample collection periods and the collection period is identified for each canister. 3. Canisters are shipped to the site at sub-atmospheric pressure approximating negative 30 inches of mercury. 4. The laboratory evacuates the canister to approximately - 30 inches of Hg prior to shipping. 		
Sample collection using canisters	<ol style="list-style-type: none"> 1. Air samples will be collected at a rate of 25 milliliters per minute. 2. A 6-Liter canister with a preset flow rate of 25 milliliters per minute and not drawing against backpressure constraints, will fill in approximately 4 hours. 3. The backpressure is primarily a factor of the length of the tubing from the sampling point to the canister, the interior diameter of the tubing, the construction of the sampling probe, and the soil type. 4. If the backpressure constraint is greater than the vacuum in the canister, sample collection will not occur. 5. When possible, the system backpressure should be evaluated prior to sampling. 6. The method by which the ambient pressure and temperature will be obtained must be either weather station or portable instrument for exterior samples. 		
Canister Leak Test Evaluation Prior to Collection	<p>All canisters are leak tested prior to each sampling. Canister pressure must be recorded by lab prior to shipment to the client (approximately -30 inches of mercury), and by field after sample collection. The pressure must be recorded by lab upon receipt.</p>	<p>The difference between the initial canister pressure recorded at the laboratory and the subsequent pressure reading prior to sample collection at the field location must not be greater than 10 in Hg.</p>	<ol style="list-style-type: none"> 1. If canister pressure is exceeded notify QAO since re-sampling may be required. 2. Document communications and corrective action in the case narrative.

Table 11. VOCs using USEPA Method TO-15 Quality Control Requirements and Corrective Actions.

Audit	Frequency	Control Limits	Corrective Action
Canister Leak Test Evaluation After Collection	Canister pressure should be recorded by the field after sample collection, and by the lab upon receipt at the lab.	<p>The difference between the pressure recorded in the field after sample collection and the pressure recorded by the lab upon sample receipt must not be greater than 10 in Hg.</p> <p>If pressure difference is exceeded, documentation instructing the lab to analyze the sample must be provided.</p>	<ol style="list-style-type: none"> 1. If canister pressure is exceeded notify QAO since re-sampling may be required. 2. Document communications and corrective action in the case narrative.
Canister Filling	The canisters should be filled to a minimum of -15 in Hg, but ideally filled to between -5 in Hg and -2 in Hg when collection of sample is completed.	Canisters used for sample collection should be filled properly.	<ol style="list-style-type: none"> 1. If canister filling requirement is exceeded notify QAO since re-sampling may be required. 2. Document communications and corrective action in the case narrative.
Canister Cleaning	<ol style="list-style-type: none"> 1. Canisters must be clean and free of any contaminants before sample collection. 2. Canisters will be batch certified. It is recommended that canisters are individually certified for low level, indoor air samples (<0.5 ug/m3). 3. The same laboratory that certifies the canisters as clean must analyze the sample canisters. 4. Certification should be provided in the data package. The laboratory must document which canisters are associated with each batch certification. 	<ol style="list-style-type: none"> 1. Canisters are cleaned using either humid zero nitrogen cleaning procedures as described in USEPA Method TO-15 or the canisters are heated in an isothermal oven or by use of heating bands. 2. Batch certified: 1 of the canisters per batch of 12 (8.3%) are analyzed by TO-15. 3. Clean canisters do not contain analytes above or equal to the quantitation limit (QL). 4. Any canister that has not tested clean will not be used. 	<ol style="list-style-type: none"> 1. If canister cleaning requirement is exceeded notify QAO since re-sampling may be required. 1. 2. Document communications and corrective action in the case narrative.
GC/MS tuning	Once every 24 hours prior to initial calibration and calibration verification.	<ol style="list-style-type: none"> 1. Tune key ions and abundance criteria listed in USEPA Method TO-15 must be met for all ions and analyses must be performed within 24 hours of injection of the tune. 2. Part of the tune peak will not be background subtracted to meet tune criteria. 2. Documentation of all tune analyses and evaluations must be included in the data packages. 	<ol style="list-style-type: none"> 1. Tune the mass spectrometer. 2. Document corrective action in the case narrative - samples must not be analyzed until control limit criteria have been met.
Analytical Sequence	Analytical sequence is defined as analyses performed within a 24-hour period.	Not applicable	Not applicable

Table 11. VOCs using USEPA Method TO-15 Quality Control Requirements and Corrective Actions.

Audit	Frequency	Control Limits	Corrective Action
Initial Calibration (IC)	Prior to sample analysis and when calibration verification criteria are not met. Initial calibration will contain all target analytes in each standard.	<ol style="list-style-type: none"> 1. Minimally five concentrations of standards bracketing the expected concentration range for all compounds of interest. One standard must be at or below the QL. 2. The %RSD must be less than or equal to 30 for all target analytes or calibration coefficient of greater than 0.990 for calibration curves. The following exception is allowed: Up to two analytes can exceed 30% RSD but must be less than or equal to 40%. 3. 4. Minimum relative response factor (RRF) of ≥ 0.05. 5. If used, tracer gas should be included in calibration. 6. Quantitation of analyses will utilize the initial calibration results. 	<ol style="list-style-type: none"> 1. Identify and correct problem. 2. Recalibrate instrument. Samples must not be analyzed until initial calibration criteria are met.
Calibration Verification (CCV)	<p>Every 24 hours, following tune.</p> <p>Calibration verification will contain all target analytes in each standard at a concentration that is representative of the midpoint of the initial calibration.</p>	<ol style="list-style-type: none"> 1. The percent difference must be less than or equal to 30 for all target analytes 2. Minimum RRF of ≥ 0.05. 	<ol style="list-style-type: none"> 1. Reanalyze. 2. If criteria are still not met, identify and correct problem and recalibrate. Samples must not be analyzed until continuing calibration criteria are met.
Method Blank Analysis	<p>Prepared with each analytical sequence of 24-hour period.</p> <p>The method blank is an unused, certified canister that has not left the laboratory. The blank canister is pressurized with humidified, ultra-pure zero air and carried through the same analytical procedure as a field sample. The injected aliquot of the blank must contain the same amount of internal standards that are added to each sample.</p>	<ol style="list-style-type: none"> 1. The laboratory method blank should be analyzed after the calibration standard and before any samples are analyzed. 2. The blank can not contain any target analyte at a concentration greater than the QL or analytes with elution characteristics and mass spectral features that would interfere with identification and measurement of a method analyte. 	<ol style="list-style-type: none"> 1. Reanalyze blank. 2. If limits are still exceeded, investigate and correct problem. Otherwise, flag data indicating blank contamination was detected. 3. Document corrective action in the case narrative.
Field/ Equipment Blank Analysis (when requested)	<p>Laboratory-supplied clean canister for each batch of canisters.</p> <p>Collected one per sampling day and/or one after every 20 samples, if required.</p> <p>Canister blank may not be required for a project.</p>	<p>The blank can not contain any target analyte at a concentration greater than the QL or analytes with elution characteristics and mass spectral features that would interfere with identification and measurement of a method analyte.</p>	<ol style="list-style-type: none"> 1. Investigate problem. 2. Document in the case narrative.

Table 11. VOCs using USEPA Method TO-15 Quality Control Requirements and Corrective Actions.

Audit	Frequency	Control Limits	Corrective Action
Internal Standards	<p>Samples, blanks, LCSs must be spiked with method specified internal standards.</p> <p>Add sufficient internal standard equivalent to 10 ppbv in the sample.</p>	<ol style="list-style-type: none"> The area response for each internal standard must be within ± 40 percent of the mean area response of the internal standard in the most recent valid calibration verification. The retention time for each of the internal standards in the blanks must be within ± 0.33 minutes between the analysis and the most recent valid calibration verification. 	<ol style="list-style-type: none"> Reanalyze. If recovery is still outside criteria, report both analyses. Document corrective action in the case narrative.
Laboratory Control Sample (LCS)	<p>Every 20 samples, one per analysis sequence.</p> <p>LCS will contain all target analytes in each calibration standard, using a second source, at a concentration that is near a midpoint calibration standard.</p>	<p>Recovery within laboratory control limits. For compounds without established laboratory control limits, 60-140% recovery will be used.</p> <p>The lowest acceptable control limits for recovery will be 10%.</p>	<p>If recovery failures are above control limits and these compounds are not detected in the associated samples above the MDL or QL, corrective action is not required.</p> <p>If recovery failures are below control limits, reanalyze LCS and examine results of other QC analyses.</p> <p>If other QC criteria have not been met, stop analysis, locate and correct problem, recalibrate instrument and reanalyze samples since last satisfactory LCS.</p> <p>Document corrective action in the case narrative.</p>
Field Duplicate Analysis	<p>One per 20 samples, or as collected during the project.</p>	<p>Within 25 relative percent difference (RPD) for air samples.</p> <p>For sample results that are less than or equal to five times the QL, the criterion of plus or minus two times the QL will be applied to evaluate field duplicates.</p>	<p>No corrective action required of the laboratory since the laboratory will not know the identity of the field duplicate samples. If these criteria are not met, sample results will be evaluated on a case-by-case basis.</p>
Sample Batching	<p>The laboratory will batch project samples together along with QC samples specified from the project.</p> <p>Non-project information will not be included in the data packages.</p>	<p>Not applicable</p>	<p>Not applicable</p>
Sample Analysis	<p>All Canister samples should be at temperature equilibrium in the laboratory.</p>	<p>Not applicable</p>	<p>Not applicable</p>

Table 11. VOCs using USEPA Method TO-15 Quality Control Requirements and Corrective Actions.

Audit	Frequency	Control Limits	Corrective Action
Sample Dilution	<p>Automatic dilution of samples is permitted to obtain an aliquot of sample from the canister.</p> <p>Samples must be diluted and re-analyzed when concentrations exceed the highest calibration standard.</p>	<p>Makeup air should only be humidified ultra pure air. Air source must be same as that used for method blank preparation.</p> <p>Dilution will keep the concentration in the upper half of the initial calibration range.</p>	Not applicable
Laboratory control limits	<p>1. Generated with results for an analyte from a minimum of 20 sample analyses. The average of the sample results and the standard deviation are calculated. The internal warning limits are established at 2 times the standard deviation and the control limits are established at 3 times the standard deviation. The control limits are updated annually.</p>	Not applicable	Not applicable
Deliverables	<p>1. Data deliverables must be provided to document each audit item for easy reference and inspection.</p> <p>2. An example calculation will be provided for each type of analysis, for each type of matrix in the data package using samples from the project.</p> <p>3. Any laboratory abbreviations or notations presented in the raw data or summary information will be explained or referenced in the case narrative.</p> <p>4. Final spiking concentrations will be presented in summary form.</p> <p>5. Run logs will be provided in the data packages.</p> <p>6. Canister pressures prior to shipment and upon receipt, canister certification documentation and leak check evaluation documentation must be included in the data package.</p>	Not applicable	Provide missing or additional deliverables for validation purposes.
Method requirements	<p>The laboratory will perform the method as presented in this table and will adhere to the requirements presented herein. Otherwise the laboratory will specifically note any procedures that differ from the method or the table in the data package case narrative.</p>	Not applicable	Not applicable

Table 11. VOCs using USEPA Method TO-15 Quality Control Requirements and Corrective Actions.

Audit	Frequency	Control Limits	Corrective Action
<p>Notes: Data validation will be performed in accordance with QA/QC criteria established in this table and the analytical methods that are currently used by the laboratory. Excursions from QA/QC criteria will be qualified based on guidance provided in this QCD. Communications with O'Brien & Gere will be documented and referenced in the data packages. Source: O'Brien & Gere</p>			

Table 12. Dissolved Gases using Method RSK-175 Quality Control Requirements and Corrective Actions

Audit	Frequency	Control Limits	Laboratory Corrective Action
Holding times	Samples must be analyzed within holding time.	Analyze within 14 days from collection for preserved aqueous samples.	<ol style="list-style-type: none"> 1. If holding times are exceeded for initial or any re-analyses required due to QC excursions. 2. Notify QA Officer since re-sampling may be required. 3. Document corrective action in the case narrative.
Initial Calibration	<p>Prior to sample analysis and when calibration verifications criteria are not met.</p> <p>Initial calibration will contain all target analytes in each standard.</p> <p>Quantitation of analyses will utilize the initial calibration results.</p>	<ol style="list-style-type: none"> 1. A minimum of five concentrations and one calibration standard must be at concentration less than or equal to the QL. 2. If RSD <20% the average RRF (internal calibration) or average calibration factor (external calibration) is used for quantitation. If RSD >20% a linear regression calibration that does not pass through the origin with a correlation coefficient (r) >0.990 is used for quantitation; or a nonlinear first or second order calibration curve with a coefficient of determination (COD) or $r^2 \geq 0.990$ is used for quantitation. 	<ol style="list-style-type: none"> 1. Identify and correct problem. 2. If criteria are still not met, recalibrate. 3. Document corrective action in the case narrative. 4. Samples should not be analyzed until calibration control limit criteria are met. 5. Contact QA Officer to discuss problem target analytes before proceeding with analysis.
Calibration Verification	<p>Calibration standards must contain all target analytes at mid-range concentration.</p> <p>Minimally, analyze calibration standards daily and every 12 hours during sequence. Calibration verification standards should be analyzed every 20 samples.</p>	<ol style="list-style-type: none"> 1. Response (% difference) or concentration (% drift) < 15%. 	<ol style="list-style-type: none"> 1. Reanalyze. 2. If criteria are still not met, identify and correct problem, recalibrate. 3. Document corrective action in the case narrative; samples should not be analyzed until calibration control limit criteria are met.

Table 12. Dissolved Gases using Method RSK-175 Quality Control Requirements and Corrective Actions

Audit	Frequency	Control Limits	Laboratory Corrective Action
MS/MSD Analysis	<p>1 per 20 samples of similar matrix may be prepared at the same times.</p> <p>For MS/MSDs analyzed, must be spiked with all target analytes.</p> <p>Samples from the investigation must be used for MS/MSD analysis.</p>	<p>Recovery and RPD within laboratory control limits.</p> <p>For compounds without established laboratory control limits, 70-130% recovery will be used.</p> <p>The lowest acceptable control limits for recovery will be 10%.</p>	<ol style="list-style-type: none"> 1. Reanalyze if <10%. 2. If reanalysis is still <10%, report both analyses and document in the case narrative. 3. If re-analysis is >10% and LCS criteria are met, document in case narrative; no additional corrective action required. 4. If LCS criteria are exceeded also, examine other QC data for source of problem; <i>i.e.</i>, surrogate recoveries and calibration data for instrument performance issues. 5. Re-analyze samples and associated MS/MSD and LCSs as required. 6. Document corrective action in the case narrative.
Surrogate Spike	<p>Samples, blanks, MS/MSDs, and LCSs may be spiked with surrogate compounds.</p>	<p>Recovery within laboratory control limits.</p> <p>The lowest acceptable control limits for recovery will be 10%.</p>	<ol style="list-style-type: none"> 1. Reanalyze. 2. If reanalysis recovery fails criteria but is >10%, report both analyses and document in case narrative report. 3. If reanalysis recovery is <10%, re-extract and reanalyze the sample. <p>Document corrective action in the case narrative.</p>
Retention Time Windows	<p>Retention time windows must be established for each target analyte.</p>	<p>Compounds must be within established retention time windows or within laboratory established relative retention time criteria for the associated calibration standards.</p> <p>Retention time windows must be provided for each calibration verification.</p>	<ol style="list-style-type: none"> 1. Reanalyze. 2. If criteria are still not met, identify and correct problem, recalibrate; reanalyze samples back to last compliant calibration standard. 3. Document corrective action in the case narrative.
Preparation Blank Analysis	<p>1 per 20 samples of similar matrix extracted at the same time.</p>	<p>Target analyte concentrations must be <QL.</p> <p>QLs will be provided with preparation blank results.</p>	<ol style="list-style-type: none"> 1. Reanalyze blank. 2. If limits are still exceeded, clean instrument, recalibrate analytical system, and reanalyze all samples if detected for same compounds as in blank. 3. Document corrective action in the case narrative - samples cannot be analyzed until blank criteria have been met.

Table 12. Dissolved Gases using Method RSK-175 Quality Control Requirements and Corrective Actions

Audit	Frequency	Control Limits	Laboratory Corrective Action
Laboratory Control Sample Analysis	<p>1 per 20 samples of similar matrix extracted at the same times.</p> <p>Prepared independently from calibration standards.</p> <p>Spike must contain all target analytes and should be at a concentration, which is in the lower 1/2 of the calibration curve.</p>	Recovery within laboratory control limits. The lowest acceptable control limits for recovery will be 10%.	<ol style="list-style-type: none"> 1. If recovery failures are above control limits and these compounds are not detected in the associated samples, corrective action is not required. 2. If recovery failures are below control limits, reanalyze LCS and examine results of other QC analyses. 3. If other QC criteria have not been met, stop analysis, locate and correct problem, recalibrate instrument and reanalyze samples since last satisfactory LCS. 4. Document corrective action in the case narrative.
Laboratory Duplicate	<p>Collected one per 20 samples or one per matrix (for less than 20 samples)</p> <p>Samples from the investigation must be used for Duplicate analysis.</p>	RPD within laboratory control limits.	<ol style="list-style-type: none"> 1. Reanalyze if RPD not within laboratory limits. 2. If reanalysis is still out, report both analyses and document in the case narrative.
Identification	Samples, blanks, and QC data.	<p>Retention times must be within established retention time windows or must meet relative retention time criteria.</p> <p>Retention time windows must be provided for each calibration verification.</p>	<ol style="list-style-type: none"> 1. Investigate problem; reanalyze calibration standards to check for retention time shift. 2. Document corrective action in the case narrative.
Quantitation	Samples, blanks, and QC data.	<p>Verify concentration is within linear calibration range of standards.</p> <p>Every effort must be made to meet specified QL requirements. Soil samples concentrations must be corrected to dry weight.</p> <p>Lab must state the technique used to quantitate results for the samples.</p>	<ol style="list-style-type: none"> 1. If concentration is above linear calibration range, dilute sample and reanalyze. Dilution should result in concentration in the upper calibration range of the instrument. 2. Document corrective action in the case narrative.
Equipment Blank Analysis	Collected one per sampling equipment and after every 20 samples.	Compounds concentrations must be <QL.	<ol style="list-style-type: none"> 1. Investigate problem; reanalyze to verify laboratory cross contamination is not a factor. 2. Document in the case narrative.

Table 12. Dissolved Gases using Method RSK-175 Quality Control Requirements and Corrective Actions

Audit	Frequency	Control Limits	Laboratory Corrective Action
Field Duplicate Analysis	Collected 1 per matrix type; every 20 samples of similar matrix.	50% RPD for waters For sample results that are less than or equal to five times the QL, the criterion of plus or minus two times the QL will be applied to evaluate field duplicates.	1. No corrective action required of the laboratory since the laboratory will not know the identity of the field duplicate samples. If these criteria are not met, sample results will be evaluated on a case-by-case basis during the validation process.
Chromatography Presentation	For each standard, sample and QC sample analysis.	Copies of chromatograms provided in the data package must be large enough to view during validation; detail of each peak involved in the identification, including peak shape and associated baseline. In the case that matrix interference is detected or manual integration is performed, enlarged copies of those manipulations will be included in the data package for review.	1. Provide requested information.
Sample Batching	The laboratory will batch project samples together along with QC samples specified from the project. Non-project information will not be included in the data packages. USEPA Form 8 Summary form, providing the date, time of analysis of samples and QC samples will be provided.	Not applicable	Not applicable
Laboratory control limits	1. Generated with results for an analyte from a minimum of 20 sample analyses. The average of the sample results and the standard deviation are calculated. The internal warning limits are established at 2 times the standard deviation and the control limits are established at 3 times the standard deviation. The control limits are updated annually.	Not applicable	Not applicable

Table 12. Dissolved Gases using Method RSK-175 Quality Control Requirements and Corrective Actions

Audit	Frequency	Control Limits	Laboratory Corrective Action
Dilutions	<ol style="list-style-type: none"> 2. When target analyte concentration exceed upper limit of calibration curve. 3. When matrix interference demonstrated by lab and documented in the case narrative (highly viscous samples or a large number of nontarget peaks on the chromatogram). 4. Laboratory will note in the data deliverables which analytical runs were reported. 	<ol style="list-style-type: none"> 1. The reagent blank will meet the method blank criteria. 	<ol style="list-style-type: none"> 1. Reanalyze reagent blank until method blank criteria are met.
Deliverables	<ol style="list-style-type: none"> 1. CLP-like deliverables must be provided to document each audit item for easy reference and inspection. 2. An example calculation will be provided for each analysis, for each type of matrix in the data package using samples from the project. 3. Any laboratory abbreviations or notations presented in the raw data or summary information will be explained or referenced in the case narrative. 4. Final spiking concentrations will be presented in summary form. 5. Standard tracing information will be provided for one of the first data packages provided for the project or other arrangements will be made to evaluate standard tracing. 6. Cooler temperatures will be provided in the data packages. 7. Run logs will be provided in the data packages. 	Not applicable	Provide missing or additional deliverables for validation purposes.

Table 12. Dissolved Gases using Method RSK-175 Quality Control Requirements and Corrective Actions

Audit	Frequency	Control Limits	Laboratory Corrective Action
Method and QCD requirements	The laboratory will perform the method as presented in this QCD and will adhere to the QCD requirements presented herein. Otherwise the laboratory will specifically note any procedures that differ from the method or the QCD in the data package case narrative.	Not applicable	Not applicable

Note
 Data validation will be performed in accordance with QA/QC criteria established in these tables and the analytical methods that are currently used by the laboratory. Excursions from QA/QC criteria will be qualified based on guidance provided in this QCD.
 Communications with the QA Officer will be documented and included in the data packages.
 Source: O'Brien & Gere

Table 13. Organic Acids using Laboratory Method VFA-IC Quality Control Requirements and Corrective Actions

Audit	Frequency	Control Limits	Corrective Action
Holding times	Aqueous samples must be analyzed within holding time.	Analyze within 28 days from collection.	If holding times are exceeded for initial or any re-analyses required due to QC excursions, notify QA Officer since re-sampling may be required.
Initial Calibration	Prior to sample analysis and when calibration verification criteria are not met.	Five concentrations for each target analyte bracketing expected concentration range for all target compounds. One standard must be at the QL concentration. The calibration curve for quantitation COD must be ≥ 0.995 .	<ol style="list-style-type: none"> 1. Identify and correct problem. 2. If criteria are still not met, recalibrate. 3. Document corrective action. 4. Samples cannot be analyzed until calibration control limit criteria are met.
Initial and Continuing Calibration Verification	Every analysis batch, following initial calibration for ICV. CCV at the beginning of the analysis sequence and every 10 samples.	The recoveries for the ICV and CCV target analytes must be within 20% of the true value.	<ol style="list-style-type: none"> 1. Reanalyze ICV or CCV. 2. If criteria are still not met, identify and correct problem, recalibrate. 3. Document corrective action. 4. Samples cannot be analyzed until calibration criteria are met.
Continuing Calibration Blank Analysis	Every analysis batch, following calibration standards.	Target analytes less than QL.	<ol style="list-style-type: none"> 1. Reanalyze ICB or CCB. 2. If limits are still exceeded, clean instrument, recalibrate analytical system, and reanalyze all samples if detected for same compounds as in blank. 3. Document corrective action. 4. Samples cannot be analyzed until ICB and CCB criteria have been met.
Laboratory Method Blank Analysis	Every analysis batch, following calibration standards.	Target analytes less than QL.	<ol style="list-style-type: none"> 1. Reanalyze blank. 2. If limits are still exceeded, clean instrument, recalibrate analytical system, and reanalyze all samples if detected for same compounds as in blank. 3. Document corrective action. 4. Samples cannot be analyzed until blank criteria have been met.
LCS Analysis	Each day of analysis. LCSs must be prepared independently from calibration standards and must contain all target analytes.	Recovery within laboratory control limits.	<ol style="list-style-type: none"> 1. Reanalyze LCS and examine results of other QC analyses. 2. If recovery is still outside limits, and other QC criteria are met discuss in case narrative. 3. If other QC criteria have not been met, stop analysis, locate and correct problem, recalibrate instrument and reanalyze samples since last satisfactory LCS. 4. Document corrective action.

Table 13. Organic Acids using Laboratory Method VFA-IC Quality Control Requirements and Corrective Actions

Audit	Frequency	Control Limits	Corrective Action
Matrix spike/ matrix spike duplicate Analysis	One per every 20 samples. Also, one spike per month of analysis. MS/MSDs contain all target analytes.	Percent recovery within laboratory control limits.	<ol style="list-style-type: none"> 1. Reanalyze if <10%. 2. If >10% and LCS criteria are met, document in case narrative; no additional corrective action required. 3. If LCS criteria are exceeded also, examine other QC data for source of problem; i.e., surrogate recoveries for calibration data for instrument performance issues. 4. Take corrective action as required, reanalyze samples and associated MS/MSD and LCSs as required.
Equipment Blank Analysis	Every 20 samples as required. Note equipment blank is not required if dedicated sampling equipment used.	Target analytes less than QL.	<ol style="list-style-type: none"> 1. Reanalyze to confirm. 2. Document in case narrative.
Field Dup. Analysis	1 per matrix and analytical batch and every 20 samples of similar matrix	<ol style="list-style-type: none"> 1. 50% RPD for waters. 2. For sample results that are less than or equal to five times the QL, the criterion of plus or minus two times the QL will be applied to evaluate field duplicates. 	No corrective action required of the laboratory since the laboratory will not know the identity of the field duplicate samples. If these criteria are not met, sample results will be evaluated on a case-by-case basis.
Sample Batching	The laboratory will batch project samples together along with QC samples specified from the project. Non-project information will not be included in the data packages.	Not applicable	Not applicable

Table 13. Organic Acids using Laboratory Method VFA-IC Quality Control Requirements and Corrective Actions

Audit	Frequency	Control Limits	Corrective Action
Deliverables	<ol style="list-style-type: none"> 1. CLP-like deliverables must be provided to document each audit item for easy reference and inspection. 2. An example calculation will be provided for each analysis, for each type of matrix in the data package using samples from the project. 3. Any laboratory abbreviations or notations presented in the raw data or summary information will be explained or referenced in the case narrative. 4. Final spiking concentrations will be presented in summary form. 5. Standard tracing information will be provided. 6. Cooler temperatures and any observations of bubbles in sample containers will be provided in the data packages. 7. Run logs will be provided in the data packages. 	Not applicable	Provide missing or additional deliverables for validation purposes.
Method and QCD requirements	The laboratory will perform the method as presented in this QCD and will adhere to the QCD requirements presented herein. Otherwise the laboratory will specifically note any procedures that differ from the method or the QCD in the data package case narrative.	Not applicable	Not applicable

Table 13. Organic Acids using Laboratory Method VFA-IC Quality Control Requirements and Corrective Actions

Audit	Frequency	Control Limits	Corrective Action
<p>Notes: Data validation will be performed in accordance with QA/QC criteria established in these tables and the analytical methods. Excursions from QA/QC criteria will be qualified based on guidance provided in this QCD. Communications with the QA Manager will be documented and included in the data packages. Source: O'Brien & Gere</p>			

Table 14. Metals using USEPA Methods 6010B and 6020, Mercury using USEPA Methods 7470A/7471A, Cyanide using USEPA Methods 9010B/9012A and Hardness using SM 2340B Quality Control Requirements and Corrective Actions.

Audit	Frequency	Control Limits	Corrective Action
Holding Times	Samples must be digested and analyzed within holding time.	Metals: 180 days from collection to analysis. Mercury: 28 days from collection to analysis. Cyanide: 14 days from collection to analysis.	<ol style="list-style-type: none"> 1. If holding times are exceeded for initial or any reanalysis required due to QC excursions, notify the QAO since re-sampling may be required. 2. Document any observation or corrective action in the case narrative.
Mass Tuning	A solution containing elements representing mass regions of interest (Li, Co, In, and Tl for example) must be analyzed prior to sample analysis.	Mass calibrations must be within 0.1amu from the true value. The resolution should be <0.9amu full width at 10 percent peak height.	<ol style="list-style-type: none"> 1. Adjust the mass calibration until criteria are met.

Table 14. Metals using USEPA Methods 6010B and 6020, Mercury using USEPA Methods 7470A/7471A, Cyanide using USEPA Methods 9010B/9012A and Hardness using SM 2340B Quality Control Requirements and Corrective Actions.

Audit	Frequency	Control Limits	Corrective Action
<p>Initial Calibration Verification and Continuous Calibration Verification (Metals, mercury, cyanide) (ICV, CCV)</p>	<p>A minimum of two-point calibration for ICP consisting of one at least one standard and one blank. Is required.</p> <p>An appropriate internal standard is required for each analyte. Recommended internal standards are 6Li, 45Sc, 74Ge, 89Y, 103Rh, 115In, 159Tb, 169Ho, and 209Bi.</p> <p>Five point calibration for remaining methods, with one standard at the QL level.</p> <p>Should calibrate each time the instrument is set up.</p> <p>After calibration, Initial calibration verification (ICV) is performed. The ICV is from a source independent of the calibration standards.</p> <p>For cyanide, the ICV must be distilled.</p> <p>A continuing calibration verification (CCV) is analyzed at the beginning of the run, at 10% or every 2 hours. Also verify at the end of each run.</p> <p>It is also recommended that low level initial calibration standard (LLICV) and a low level calibration verification (LLCCV) standard be analyzed at the beginning and end of the run.</p>	<p>ICV, CCV - 90% to 110% of expected value for ICP, AA, colorimeter, and spectrophotometer.</p> <p>ICV for Mercury – 90% to 110% of expected true value.</p> <p>CCV for Mercury - 80% to 120% of expected true value.</p> <p>Correlation coefficient for first or second order curve must be ≥ 0.995.</p> <p>For cyanide the ICV and CCV must meet 85 to 115% recovery.</p> <p>Percent recoveries for LLICV/LLCCV must be within 70-130%.</p>	<ol style="list-style-type: none"> 1. Reanalyze. 2. If criteria are still not met, identify and correct problem, recalibrate. 3. Document any observation or corrective action in the case narrative - samples should not be analyzed until calibration control limit criteria have been met.

Table 14. Metals using USEPA Methods 6010B and 6020, Mercury using USEPA Methods 7470A/7471A, Cyanide using USEPA Methods 9010B/9012A and Hardness using SM 2340B Quality Control Requirements and Corrective Actions.

Audit	Frequency	Control Limits	Corrective Action
Lower Limit of Quantitation Check (LLQC)	For ICP, AA, and cyanide, LLQC is a standard at the QL concentration analyzed at the beginning of each run for all elements at the QL level	The percent recovery of the LLQC must meet the control limits of 70-130%.	<ol style="list-style-type: none"> 1. The LLQC shall be re-analyzed immediately for those analytes; if the results of the re-analysis for those analytes fall within the control limits, no further corrective action is required. 2. If the results of the re-analysis for those analytes do not fall within the control limits, the analysis shall be terminated, the problem corrected, the instrument recalibrated, the LLQC analyzed, and the samples associated with the LLQC re-analyzed. 3. Document any observation or corrective action in the case narrative.
Initial and Continuing Calibration Blank (ICB/CCB) (Metals, mercury, cyanide)	After ICV, CCV, at beginning and end of run and at a rate of 10% or every 2 hours during run.	The absolute value of the ICB and CCB must not exceed the QL.	<ol style="list-style-type: none"> 1. Identify and correct problem. 2. If criteria are still not met, recalibrate and reanalyze affected samples. 3. Document any observation or corrective action in the case narrative- samples cannot be analyzed until blank control limit criteria have been met.
Rinse Blank	Rinse blank must be analyzed following every sample and standard to flush the instrument..	The absolute value of the rinse blank must not exceed the QL.	<ol style="list-style-type: none"> 1. Identify and correct problem. 2. If criteria are still not met, recalibrate and reanalyze affected samples. 3. Document any observation or corrective action in the case narrative - samples cannot be analyzed until blank control limit criteria have been met.
Preparation Blank Analysis	One for each batch of samples prepared/ digested, or 1 in 20 samples, whichever is greater. PB shall be carried through the complete procedure and contain the same acid concentration in the final solution as the sample solution used for analysis.	The absolute value of the method blank must not exceed the QL.	<ol style="list-style-type: none"> 1. Reanalyze blank. 2. If limits are still exceeded, clean instrument and recalibrate analytical system and re-preparation and reanalyze affected samples if detected. 3. Document any observation or corrective action in the case narrative - samples cannot be analyzed until blank criteria are met.
Field/Equipment Blank Analysis	Field collected - One per sampling event, or one per 20 samples or one per matrix (for less than 20 samples)	Less than QL	<ol style="list-style-type: none"> 1. Investigate problem. 2. Document any observation or in the case narrative.

Table 14. Metals using USEPA Methods 6010B and 6020, Mercury using USEPA Methods 7470A/7471A, Cyanide using USEPA Methods 9010B/9012A and Hardness using SM 2340B Quality Control Requirements and Corrective Actions.

Audit	Frequency	Control Limits	Corrective Action
Laboratory Control Sample Analysis	<p>Every 20 samples or each digestion batch.</p> <p>Prepared independently from calibration standards.</p>	Recovery within 80 to 120%	<ol style="list-style-type: none"> 1. Reanalyze LCS and examine results of other QC analyses. 2. If recovery is still outside limits, and other QC criteria are met, report both runs. 3. If other QC criteria have not been met, stop analysis, locate and correct problem, recalibrate instrument and reanalyze samples since last satisfactory LCS. 4. Document corrective action in the case narrative.
Serial Dilution Analysis for ICP (Metals)	<p>Required once per analytical batch when analyte concentration is >10 times the instrument detection limit (IDL) (or MDL if applicable).</p> <p>Samples from the investigation must be used for Serial dilution analysis.</p>	An analysis of a 1:5 dilution of the sample should provide a result with 90% to 110% of the original determination (for concentrations 10x the lower limit of quantitation after dilution)	<ol style="list-style-type: none"> 1. Report results. 2. Document corrective action in the case narrative.
Interference Check Sample Analysis for ICP (Metals)	<p>Beginning and end of each analytical run or twice during every 8 hours, whichever is more frequent for ICP.</p> <p>Solution A consists of the interferences, and Solution AB consists of the analytes mixed with the interferences.</p>	Results for the ICS Solution AB (ICSAB) during the analytical runs shall fall within the control limit of ± 2 times the QL of the true value or $\pm 20\%$ of the true value, whichever is greater, for the analytes included in the ICSAB	<ol style="list-style-type: none"> 1. Reanalyze. 2. If limits are still exceeded, adjust instrument. 3. Restart analytical run and reanalyze samples analyzed since last satisfactory ICS. 4. Document any observation or corrective action in the case narrative.
Matrix Spike Analysis (Metals, mercury, cyanide)	<p>Collected one per 20 samples or one per matrix (for less than 20 samples)</p> <p>Samples from the investigation must be used for MS/MSD analysis.</p>	<p>Recovery within laboratory control limits or 75-125%, or in-house laboratory limits. Recovery does not apply if sample concentration > 4 X spike concentration.</p> <p>Spike must contain all analytes.</p> <p>The lowest acceptable laboratory control limits for recovery will be 10%.</p>	<ol style="list-style-type: none"> 1. Analyze post-digestion/post-distillation spike at two times the QL or two times the indigenous level, whichever is greater. 2. Document any observation or corrective action in the case narrative.
Post-Digestion Spike (Recommended for Metals, mercury, cyanide)	<p>Spike must contain all target elements.</p> <p>Performed every 20 samples as necessary.</p>	Recovery within 80-120% of true value.	<ol style="list-style-type: none"> 1. Dilute sample and reanalyze. 2. Recovery of the reanalysis must be 90-110% of the original analysis. 3. If recovery is outside limits, document in the case narrative. 4. Standard additions may be used to compensate for matrix effects.

Table 14. Metals using USEPA Methods 6010B and 6020, Mercury using USEPA Methods 7470A/7471A, Cyanide using USEPA Methods 9010B/9012A and Hardness using SM 2340B Quality Control Requirements and Corrective Actions.

Audit	Frequency	Control Limits	Corrective Action
Internal standard	Monitored for all samples, blanks, standards, and QC samples analyzed.	Internal Standard counts should be within 30% of Internal Standard counts of the calibration standard for all samples and standards.	<ol style="list-style-type: none"> 1. If internal standard area is not within 30%, review the internal areas of the closest calibration blanks for compliance. If the calibration blanks meet criteria; dilute the sample five fold and reanalyze. 2. If the internal standard area of the calibration blank is also outside of 30%, stop sample analysis and recalibrate.
Laboratory Duplicate or Matrix Spike Duplicate Analysis	<p>Collected one per 20 samples or one per matrix (for less than 20 samples)</p> <p>Samples from the investigation must be used for Laboratory Duplicate and MSD analysis</p>	<p>Laboratory control limit or 20% for RPD shall be used for original and duplicate sample values greater than or equal to five times the QL.</p> <p>A control limit of the QL value shall be used if either the sample or duplicate value is less than five times the CRQL.</p>	<ol style="list-style-type: none"> 1. Investigate problem and reanalyze. 2. Document any observation or corrective action in the case narrative.
Field Duplicate Analysis	<p>Field collected – One for each matrix; every 20 samples of similar matrix.</p> <p>The field duplicate identification will not be provided to the laboratory.</p>	<p>Validation criteria: 50% RPD for waters and 100% RPD for solids.</p> <p>For sample results that are less than or equal to five times the QL, the criterion of plus or minus two times the QL will be applied to evaluate field duplicates.</p>	No corrective action required of the laboratory since the laboratory will not know the identity of the field duplicate samples. If these criteria are not met, sample results will be evaluated on a case-by-case basis.
Percent solids	For solid samples, the percent solids will be determined and sample results will be corrected for percent solids.	Not applicable	Not applicable
Laboratory control limits	Generated with results for an analyte from a minimum of 20 sample analyses. The average of the sample results and the standard deviation are calculated. The internal warning limits are established at 2 times the standard deviation and the control limits are established at 3 times the standard deviation. The control limits are updated annually.	Not applicable	Not applicable

Table 14. Metals using USEPA Methods 6010B and 6020, Mercury using USEPA Methods 7470A/7471A, Cyanide using USEPA Methods 9010B/9012A and Hardness using SM 2340B Quality Control Requirements and Corrective Actions.

Audit	Frequency	Control Limits	Corrective Action
IDL Determination for ICP	Recommended within 30 days of the start of analysis and semiannually.	Not applicable	Not applicable
MDL Determination	Before any field samples are analyzed, the MDLs shall be determined for non-prepared analyses, each digestion procedure and instrument used, prior to the start of analyses, and annually thereafter.	Not applicable	Not Applicable
Linear Range Analysis for ICP	Every 6 months must be routinely monitored by analysis of high concentration standard.	Results for high point standard must be within 10% of true value.	Not applicable
Interelement Correction For ICP	Within 6 months of the start of analysis and annually. Correction factors for Al, Ca, Fe, and Mg must be reported and for others if they are applied.	Not applicable	Not applicable
Sample Batching	The laboratory will batch project samples together along with QC samples specified from the project. Non-project information will not be included in the data packages.	Not applicable	Not applicable
Dilutions	<ol style="list-style-type: none"> 1. When target analyte concentration exceed linear dynamic range of the instrument. 2. When matrix interference demonstrated by lab and documented in the case narrative. 3. Laboratory will note in the data deliverables which analytical runs were reported. 	Not applicable	Not applicable

Table 14. Metals using USEPA Methods 6010B and 6020, Mercury using USEPA Methods 7470A/7471A, Cyanide using USEPA Methods 9010B/9012A and Hardness using SM 2340B Quality Control Requirements and Corrective Actions.

Audit	Frequency	Control Limits	Corrective Action
Deliverables	<ol style="list-style-type: none"> 1. CLP-like deliverables must be provided to document each audit item for easy reference and inspection. 2. An example calculation will be provided for each analysis, for each type of matrix in the data package using samples from the project. 3. Any laboratory abbreviations or notations presented in the raw data or summary information will be explained or referenced in the case narrative. 4. Final spiking concentrations will be presented in summary form. 5. Standard tracing information will be provided. 6. Cooler temperatures will be provided in the data packages. 7. Run logs will be provided in the data packages. 	Not applicable	Provide missing or additional deliverables for validation purposes.
Method and QCD requirements	The laboratory will perform the method as presented in this QCD and will adhere to the QCD requirements presented herein. Otherwise the laboratory will specifically note any procedures that differ from the method or the QCD in the data package case narrative.	Not applicable	Not applicable

Table 14. Metals using USEPA Methods 6010B and 6020, Mercury using USEPA Methods 7470A/7471A, Cyanide using USEPA Methods 9010B/9012A and Hardness using SM 2340B Quality Control Requirements and Corrective Actions.

Audit	Frequency	Control Limits	Corrective Action
<p>Note Data validation will be performed in accordance with QA/QC criteria established in these tables and the analytical methods. Excursions from QA/QC criteria will be qualified based on guidance provided in this QCD. Communications with the QAO will be documented and included in the data packages. Source: O'Brien & Gere</p>			

Table 15. TOC using USEPA Method 9060, Sulfide using SM 4500 S2E, BOD using SM 5210B, COD using USEPA Method 410.4, Alkalinity using SM 2320B, TDS using SM 2540C, TSS using SM 2540D, Ferrous Iron using SM 3500B, Phosphate, Nitrate, Nitrate, Chloride and Sulfate using USEPA Method 9056, Ammonia using SM 4500 NH3G, TIC using SM 5310B, Total Phosphorus using SM 4500 PE Quality Control Requirements and Corrective Actions.

Audit (Where applicable)	Frequency	Control Limits	Corrective Action
Holding Times	Samples must be digested and analyzed within holding time.	<ol style="list-style-type: none"> 1. Alkalinity, COD, TOC, TIC, Phosphate, Nitrite, Chloride, Sulfate, Ammonia, Total Phosphorus: Analyze 28 days from collection. 2. TDS, TSS and Sulfide: Analyze 7 days from collection. 3. Alkalinity: Analyze 14 days from collection. 4. Nitrate and BOD: Analyze 48 hours from collection. 5. Ferrous Iron: Analyze within 6 months from collection. 	<ol style="list-style-type: none"> 1. If holding times are exceeded for initial or any reanalysis required due to QC excursions, notify the QA Officer since re-sampling may be required. 2. Document corrective action in the case narrative.
<p>Initial Calibration, Initial Calibration Verifications (ICV), Continuing Calibration Verification (CCV)</p> <p>Applies to methods utilizing calibrations.</p>	<p>Five point calibration, one standard must be at or less than the QL. Initial calibration must be performed at a minimum annually and whenever ICV/CCV criteria are not met.</p> <p>After initial calibration ICV is performed. The ICV is from a source independent of the calibration standards.</p> <p>Verify with CCV at frequency of every 10 samples and at the end of the analytical sequence.</p> <p>For analyses involving titration, it is highly recommended that the concentration of the titrant be verified prior to sample analysis unless all associated LCS spike recoveries are within 10%.</p>	<p>ICV/CCV: Recovery of 90% to 110% of expected value.</p> <p>Five point calibration curve correlation coefficient for first or second order curve must be ≥ 0.995 or calibration factor RSD $< 10\%$.</p>	<ol style="list-style-type: none"> 1. Reanalyze. 2. If criteria are still not met, identify and correct problem, recalibrate. 3. Document corrective action in the case narrative - samples cannot be analyzed until calibration control limit criteria have been met.

Table 15. TOC using USEPA Method 9060, Sulfide using SM 4500 S2E, BOD using SM 5210B, COD using USEPA Method 410.4, Alkalinity using SM 2320B, TDS using SM 2540C, TSS using SM 2540D, Ferrous Iron using SM 3500B, Phosphate, Nitrate, Nitrate, Chloride and Sulfate using USEPA Method 9056, Ammonia using SM 4500 NH3G, TIC using SM 5310B, Total Phosphorus using SM 4500 PE Quality Control Requirements and Corrective Actions.

Audit (Where applicable)	Frequency	Control Limits	Corrective Action
Initial and Continuing Calibration Blank (ICB/CCB) Applies to methods utilizing calibrations.	After ICV, CCV, at beginning and end of run and at a rate of 10% or every 2 hours during run.	The absolute value of the ICB and CCB must not exceed the QL.	<ol style="list-style-type: none"> Identify and correct problem. If criteria are still not met, recalibrate and reanalyze affected samples. Document corrective action in the case narrative - samples cannot be analyzed until blank control limit criteria have been met.
Retention Time Windows	Retention time windows (absolute retention time) must be established.	<p>Target analytes must be within established retention time windows for the associated calibration standards.</p> <p>Retention time windows must be provided for each calibration verification.</p>	<ol style="list-style-type: none"> Reanalyze. If criteria are still not met, identify and correct problem, recalibrate; reanalyze samples back to last compliant calibration standard. Document corrective action in the case narrative.
Preparation Blank Analysis	1 per batch of samples digested, or 1 in 20, whichever is greater. PB shall be carried through the complete procedure and contain the same acid concentration in the final solution as the sample solution used for analysis.	The absolute value of the method blank must not exceed the QL.	<ol style="list-style-type: none"> Reanalyze blank. If limits are still exceeded, clean instrument and recalibrate analytical system and re-preparation and reanalyze affected samples if detected. Document corrective action in the case narrative - samples cannot be analyzed until blank criteria are met.
Laboratory Control Sample Analysis	Every 20 samples or each digestion batch. Prepared independently from calibration standards.	<p>Recovery within laboratory control limits.</p> <p>The lowest acceptable control limits for recovery will be 10%.</p>	<ol style="list-style-type: none"> Reanalyze LCS and examine results of other QC analyses. If recovery is still outside limits, and other QC criteria are met, report both runs. If other QC criteria have not been met, stop analysis, locate and correct problem, recalibrate instrument and reanalyze samples since last satisfactory LCS. Document corrective action in the case narrative.
Matrix Spike Analysis	Collected one per 20 samples or one per matrix (for less than 20 samples) Samples from the investigation must be used for MS/MSD or MS/Duplicate analysis.	<p>Recovery within laboratory control limits or 75-125%, or in-house laboratory limits. Recovery does not apply if sample concentration > 4 X spike concentration.</p> <p>Spike must contain all analytes.</p> <p>The lowest acceptable laboratory control limits for recovery will be 10%.</p>	<ol style="list-style-type: none"> If LCS criteria are met, document in the case narrative. If LCS criteria are not met, examine other QC data to identify the source of the problem. Re-prepare/ reanalyze samples associated with the matrix spike and LCS. Document corrective action.

Table 15. TOC using USEPA Method 9060, Sulfide using SM 4500 S2E, BOD using SM 5210B, COD using USEPA Method 410.4, Alkalinity using SM 2320B, TDS using SM 2540C, TSS using SM 2540D, Ferrous Iron using SM 3500B, Phosphate, Nitrate, Nitrate, Chloride and Sulfate using USEPA Method 9056, Ammonia using SM 4500 NH3G, TIC using SM 5310B, Total Phosphorus using SM 4500 PE Quality Control Requirements and Corrective Actions.

Audit (Where applicable)	Frequency	Control Limits	Corrective Action
Laboratory Duplicate or Matrix Spike Duplicate Analysis	<p>Collected one per 20 samples or one per matrix (for less than 20 samples)</p> <p>Samples from the investigation must be used for Laboratory Duplicate and MSD analysis</p>	<p>Laboratory control limit or 20% for RPD shall be used for original and duplicate sample values greater than or equal to five times the QL.</p> <p>A control limit of the QL value shall be used if either the sample or duplicate value is less than five times the CRQL.</p>	<ol style="list-style-type: none"> 1. Investigate problem and reanalyze. 2. Document corrective action.
Equipment Blank Analysis	<p>Collected one per sampling event, or one per 20 samples or one per matrix (for less than 20 samples)</p>	<p>Less than QL</p>	<ol style="list-style-type: none"> 1. Investigate problem. 2. Document in the case narrative.
Field Dup. Analysis	<p>Collected 1 per matrix; every 20 samples of similar matrix.</p> <p>The field duplicate identification will not be provided to the laboratory.</p>	<p>Validation criteria: 50% RPD for waters and 100% RPD for solids.</p> <p>For sample results that are less than or equal to five times the QL, the criterion of plus or minus two times the QL will be applied to evaluate field duplicates.</p>	<p>No corrective action required of the laboratory since the laboratory will not know the identity of the field duplicate samples. If these criteria are not met, sample results will be evaluated on a case-by-case basis.</p>
Percent solids	<p>For solid samples, the percent solids will be determined and sample results will be corrected for percent solids.</p>	<p>Not applicable</p>	<p>Not applicable</p>
Dilutions	<p>When target analyte concentration exceed upper limit of calibration curve. When matrix interference demonstrated by lab and documented in the case narrative. Laboratory will note in the data deliverables which analytical runs were reported.</p>	<p>Not applicable</p>	<p>Not applicable.</p>
Sample Batching	<p>The laboratory will batch project samples together along with QC samples specified from the project. Non-project information will not be included in the data packages.</p>	<p>Not applicable</p>	<p>Not applicable</p>

Table 15. TOC using USEPA Method 9060, Sulfide using SM 4500 S2E, BOD using SM 5210B, COD using USEPA Method 410.4, Alkalinity using SM 2320B, TDS using SM 2540C, TSS using SM 2540D, Ferrous Iron using SM 3500B, Phosphate, Nitrate, Nitrate, Chloride and Sulfate using USEPA Method 9056, Ammonia using SM 4500 NH3G, TIC using SM 5310B, Total Phosphorus using SM 4500 PE Quality Control Requirements and Corrective Actions.

Audit (Where applicable)	Frequency	Control Limits	Corrective Action
Laboratory control limits	Generated with results for an analyte from a minimum of 20 sample analyses. The average of the sample results and the standard deviation are calculated. The internal warning limits are established at 2 times the standard deviation and the control limits are established at 3 times the standard deviation. The control limits are updated annually.	Not applicable	Not applicable
Deliverables	<ol style="list-style-type: none"> 1. CLP-like deliverables must be provided to document each audit item for easy reference and inspection. 2. An example calculation will be provided for each analysis, for each type of matrix in the data package using samples from the project. 3. Any laboratory abbreviations or notations presented in the raw data or summary information will be explained or referenced in the case narrative. 4. Final spiking concentrations will be presented in summary form. 5. Standard tracing information will be provided for one of the first data packages provided for the project or other arrangements will be made to evaluate standard tracing. 6. Cooler temperatures will be provided in the data packages. 7. Run logs will be provided in the data packages. 	Not applicable	Provide missing or additional deliverables for validation purposes.

Table 15. TOC using USEPA Method 9060, Sulfide using SM 4500 S2E, BOD using SM 5210B, COD using USEPA Method 410.4, Alkalinity using SM 2320B, TDS using SM 2540C, TSS using SM 2540D, Ferrous Iron using SM 3500B, Phosphate, Nitrate, Nitrate, Chloride and Sulfate using USEPA Method 9056, Ammonia using SM 4500 NH3G, TIC using SM 5310B, Total Phosphorus using SM 4500 PE Quality Control Requirements and Corrective Actions.

Audit (Where applicable)	Frequency	Control Limits	Corrective Action
Method and QCD requirements	The laboratory will perform the method as presented in this QCD and will adhere to the QCD requirements presented herein. Otherwise the laboratory will specifically note any procedures that differ from the method or the QCD in the data package case narrative.	Not applicable	Not applicable
<p>Note Data validation will be performed in accordance with QA/QC criteria established in these tables and the analytical methods that are currently used by the laboratory. Excursions from QA/QC criteria will be qualified based on guidance provided in this QCD. Communications with the QA Officer will be documented and included in the data packages. Source: O'Brien & Gere</p>			

TABLE 16. HEXAVALENT CHROMIUM USING USEPA METHODS 3060A/7196A

Audit	Frequency	Control Limits	Corrective Action
Holding Times	Samples must be digested and analyzed within holding time.	Aqueous samples: Analyze within 24 hours from collection. Soil samples: Analyze within 30 Days from collection. Analysis is to be performed within 24 hours of extraction.	<ol style="list-style-type: none"> 1. If holding times are exceeded for initial or any re-analyses required, notify the QAO immediately since re-sampling may be required. 2. Document corrective action in the case narrative.
Calibration	<ol style="list-style-type: none"> 1- To compensate for possible slight losses of chromium during digestion or other operations of the analysis, treat the chromium standards by the same procedure as the sample. Accordingly, pipet a chromium standard solution in measured volumes into 250-mL beakers or conical flasks to generate standard concentrations ranging from 0.5 to 5 mg/L Cr(VI) when diluted to the appropriate volume. 2- Develop the color of the standards as for the samples. 3- Transfer a suitable portion of each colored solution to a 1-cm absorption cell and measure the absorbance at 540 nm. 4- As reference, use reagent water. Correct the absorbance readings of the standards by subtracting the absorbance of a reagent blank carried through the method. 5- Construct a calibration curve by plotting corrected absorbance values against mg/L of Cr(VI). 	Correlation coefficient for first or second order curve must be greater than or equal to 0.995.	<ol style="list-style-type: none"> 1. Identify and correct problem, recalibrate and reanalyze affected samples. 2. Document corrective action - samples cannot be analyzed until calibration control limit criteria have been met.
Calibration Verification	Verify calibration with an independently prepared check standard every 15 samples.	80% to 120% of expected true value	<ol style="list-style-type: none"> 1. Identify and correct problem, recalibrate and reanalyze affected samples. 2. Document corrective action - samples cannot be analyzed until calibration control limit criteria have been met.

TABLE 16. HEXAVALENT CHROMIUM USING USEPA METHODS 3060A/7196A

Audit	Frequency	Control Limits	Corrective Action
<p>Matrix Interference Verification</p>	<p>For every sample matrix analyzed, verification is required to ensure that neither a reducing condition nor chemical interference is affecting color development. This must be accomplished by analyzing a second 10-mL aliquot of the pH-adjusted filtrate that has been spiked with Cr(VI). The amount of spike added should double the concentration found in the original aliquot. Under no circumstances should the increase be less than 30 µg Cr(VI)/liter.</p>	<p>To verify the absence of an interference, the spike recovery must be between 85% and 115%.</p>	<ol style="list-style-type: none"> 1. If the result of verification indicates a suppressive interference, the sample should be diluted and reanalyzed. 2. If the interference persists after sample dilution, contact Project QAO. Project QAO will evaluate if an alternative method (Method 7195, Co-precipitation, or Method 7197, Chelation/Extraction) should be used. (This decision may require use of an alternate laboratory to evaluate the other sample preparation methods). 3. Acidic extracts that yield recoveries of less than 85% should be retested to determine if the low spike recovery is due to the presence of residual reducing agent. This determination shall be performed by first making an aliquot of the extract alkaline (pH 8.0-8.5) using 1 N sodium hydroxide and then re-spiking and analyzing. If a spike recovery of 85-115% is obtained in the alkaline aliquot of an acidic extract that initially was found to contain less than 5 mg/L Cr(VI), it can be concluded that the analytical method has been verified.
<p>Preparation Blank Analysis</p>	<p>One for each batch of samples digested.</p>	<p>A preparation blank must be prepared and analyzed with each digestion batch, and detected Cr(VI) concentrations must be less than the method detection limit or one-tenth the regulatory limit or action level, whichever is greater.</p>	<ol style="list-style-type: none"> 1. Identify and correct problem, re-digest the entire batch and reanalyze. 2. Document corrective action - samples cannot be analyzed until blank control limit criteria have been met.

TABLE 16. HEXAVALENT CHROMIUM USING USEPA METHODS 3060A/7196A

Audit	Frequency	Control Limits	Corrective Action
Field/ Equipment Blank Analysis	Collected one per sampling equipment and after every 20 samples.	Detected Cr(VI) concentrations must be less than the method detection limit or one-tenth the regulatory limit or action level, whichever is greater.	<ol style="list-style-type: none"> 1. Investigate problem. 2. Document in case narrative.
LCS Analysis	Every 20 samples. Prepared independently from calibration standards.	Recovery must be within the certified recovery range or a recovery range of 80% to 120% (whichever applies) or the sample batch must be reanalyzed.	<ol style="list-style-type: none"> 1. Correct problem. 2. Reanalyze samples since last satisfactory LCS. 3. Document corrective action.
Pre-digestion MS Analysis	<p>Samples from the investigation must be used for MS/MSD analysis. If samples were not designated as MS/MSD samples, contact QAO upon receipt of samples at the laboratory.</p> <p>Both soluble and insoluble pre-digestion matrix spikes must be analyzed at a frequency of one each per batch of < 20 field samples. The soluble matrix spike sample is spiked with 1.0 mL of the spiking solution (equivalent to 40 mg Cr(VI)/Kg) or at twice the sample concentration, whichever is greater. The insoluble matrix spike is prepared by adding 10-20 mg of PbCrO to a separate sample aliquot. It is used to evaluate the dissolution during the digestion process. Both matrix spikes are then carried through the digestion process.</p>	An acceptance range for matrix spike recoveries is 75-125%.	<ol style="list-style-type: none"> 1. If MS recoveries are outside of control limits, contact the Project QAO. 2. The entire batch must be reanalyzed if the LCS associated with the batch is outside control limits. 3. If upon reanalysis, the matrix spike is not within the recovery limits, but the LCS is within criteria, consult Figures 1 and 2 and in Section 3.1 of the method. 4. Document corrective action.

TABLE 16. HEXAVALENT CHROMIUM USING USEPA METHODS 3060A/7196A

Audit	Frequency	Control Limits	Corrective Action
<p>Post-digestion MS Analysis</p>	<p>Samples from the investigation must be used for MS/MSD analysis. If samples were not designated as MS/MSD samples, contact QAO upon receipt of samples at the laboratory.</p> <p>A post-digestion Cr(VI) matrix spike must be analyzed per batch. The post-digestion matrix spike concentration should be equivalent to 40 mg/kg or twice the sample concentration observed in the un-spiked aliquot of the test sample, whichever is greater.</p> <p>Dilute the sample aliquot to a minimum extent, if necessary, so that the absorbance reading for both the un-spiked sample aliquot and spiked aliquot are within the initial calibration curve.</p>	<p>The post-digestion matrix spike recovery is 85-115%.</p>	<ol style="list-style-type: none"> 1. Use the corrective actions/guidance on data use specified in Section 8.5 of the method or the Method of Standard Additions (MSA) as specified in Section 8.0 of Method 7000. 2. If the MSA technique is applied post digestion and no spike is observed from the MSA, these results indicate that the matrix is incompatible with Cr(VI) and no further effort on the part of the laboratory is required. These digestates may contain soluble reducing agents for Cr(VI), such as fulvic acids.
<p>Laboratory Duplicate Analysis</p>	<p>One for each analytical batch.</p>	<p>Duplicate samples must have a Relative Percent Difference (RPD) of < 20%, if both the original and the duplicate are > four times the laboratory QL.</p> <p>A control limit of \pm the laboratory QL is used when either the original or the duplicate sample is < four times the laboratory reporting limit.</p>	<ol style="list-style-type: none"> 1. Investigate problem and reanalyze. 2. Report results. 3. Document corrective action.
<p>Field Dup. Analysis</p>	<p>Collected 1 per matrix; every 20 samples of similar matrix</p>	<p>50% RPD for aqueous samples and 100% RPD for soils.</p> <p>For sample results that are less than or equal to five times the QL, the criterion of plus or minus two times the QL will be applied to evaluate field duplicates.</p>	<p>No corrective action required of the laboratory since the laboratory will not know the identity of the field duplicate samples. If these criteria are not met, sample results will be evaluated on a case-by-case basis during the validation process.</p>

TABLE 16. HEXAVALENT CHROMIUM USING USEPA METHODS 3060A/7196A

Audit	Frequency	Control Limits	Corrective Action
Sample Batching	The laboratory will batch project samples together along with QC samples specified from the project. Non-project information will not be included in the data packages.	Not applicable	Not applicable
Dilutions	Dilute samples if they are more concentrated than the highest standard or if they fall on the plateau of a calibration curve.	Not applicable	Not applicable
Deliverables	<p>CLP-like deliverables must be provided to document each audit item for easy reference and inspection.</p> <p>An example calculation will be provided for each analysis, for each type of matrix in the data package using samples from the project. Any laboratory abbreviations or notations presented in the raw data or summary information will be explained or referenced in the case narrative.</p> <p>Final spiking concentrations will be presented in summary form.</p> <p>Standard tracing information will be provided.</p> <p>Cooler temperatures will be provided in the data packages.</p> <p>Run logs will be provided in the data packages.</p>	Not applicable	Provide missing or additional deliverables for validation purposes within 5 calendar days of the request.
Method and QCD requirements	<p>The laboratory will perform the method as presented in this QCD and will adhere to the QCD requirements presented herein.</p> <p>Otherwise the laboratory will specifically note any procedures that differ from the method or the QCD in the data package case narrative.</p>	Not applicable	Not applicable

Notes:

Data validation will be performed in accordance with QA/QC criteria established in these tables and the analytical methods. Excursions from QA/QC criteria will be qualified based on guidance provided in this QCD.

Communications with the QA Officer will be documented and included in the data packages.

Source: O'Brien & Gere

*SSD System Operation and
Maintenance Manual*

Vapor Intrusion Mitigation System Operation & Maintenance Manual

Brownfield Cleanup Program No. C360115
1-5 Holland Avenue
White Plains, NY
14206/47376

Prepared for:
One Holland Avenue Development, LLC

Prepared by:
O'Brien & Gere Engineers, Inc.

April 2014

Vapor Intrusion Mitigation System Operation & Maintenance Manual

**Brownfield Cleanup Program No. C360115
1-5 Holland Avenue
White Plains, New York**

TABLE OF CONTENTS

List of Figures	i
List of Appendices	i
1. Introduction	1
2. Mitigation System Description.....	2
2.1 Principles of System Operation.....	2
2.2 System Description	2
2.3 System Modifications	3
2.4 System Enhancements	3
3. Routine Maintenance	5
3.1 Annual Inspection.....	5
3.1.1 Fan and Electrical Inspection.....	5
3.1.2 Piping, Slab and Wall Inspection	6
3.2 System Status.....	6
4. Non-Routine Maintenance	7
4.1 General Non-Routine Maintenance	7
4.2 Non-Routine Maintenance Potentially Requiring System Re-Design.....	7
5. Recordkeeping and O&M Manual Update Requirements.....	8
5.1 Recordkeeping and O&M Manual Update Requirements	8

LIST OF FIGURES

- 1 Mitigation System Record Drawing

LIST OF APPENDICES

- A Photolog of Major System Components
- B Installation Report
- C Manufacturer’s Cut Sheets
- D Completed System Inspection Forms
- E Blank Inspection Forms

1. INTRODUCTION

The vapor intrusion mitigation system at 1-5 Holland Avenue, White Plains, New York, was installed as a result of environmental investigations, which indicated historical impacts to soil and groundwater by tetrachloroethylene (PCE). Sub-slab vapor and indoor air sampling was conducted at the property in November 2008 to evaluate vapor intrusion (VI) potential. Based on comparison of indoor air concentrations with New York State Department of Health (NYSDOH) guideline values, there was no indication that indoor air concentrations of analyzed compounds exceeded NYSDOH indoor air guideline values.

Based on comparison of the sub-slab and indoor air sample results with NYSDOH vapor intrusion sub-slab/indoor air matrices, the recommended action was to mitigate the potential for sub-slab vapors to enter the buildings. According to NYSDOH recommendations, the mitigation measures should be considered a temporary measure to address VI until the environmental contaminants can be remediated. The VI mitigation system (System) was installed in April, 2009.

The System was specifically designed to mitigate the potential for sub-slab vapor to enter the buildings at 1-5 Holland Avenue. In order for the System to operate as designed, routine inspection and maintenance activities are recommended. The remaining sections of this operation and maintenance (O&M) manual present a description of the System, routine and non-routine maintenance recommendations, as well as a summary of the most recent routine inspection. The following provides contact information to answer questions regarding your System, or to schedule routine or non-routine maintenance activities:

Operation & Maintenance Consultant

Name: O'Brien & Gere Engineers, Inc.

Address: 333 W. Washington St.
Syracuse, NY 13221

Contact: Mr. Eric Alongi

Telephone number: (585) 298-2385

2. MITIGATION SYSTEM DESCRIPTION

This section provides a description of the System installed at 1-5 Holland Avenue. As previously mentioned, the System was specifically designed for 1-5 Holland Avenue to mitigate the potential for sub-slab vapors to enter the buildings.

2.1 PRINCIPLES OF SYSTEM OPERATION

The System that's installed at 1-5 Holland Avenue operates using the principle of sub-slab depressurization (SSD), the most commonly accepted mitigation technique for VI. SSD involves the inducement of a vacuum under the structure's concrete slab where soil vapors impacted with PCE were found during the vapor intrusion sampling. Vacuum is induced by a fan, mounted on the exterior of the building, which pulls sub-slab soil vapor through polyvinyl chloride (PVC) pipe that penetrates the slab (referred to as system suction points). Appendix A contains a photo log that identifies the major components of your SSD System.

After installation, the System was commissioned to test performance, to document operating parameters and to document proper installation. Initial System commissioning documentation is presented in Appendix B. During the initial commissioning, vacuum readings were recorded for each system suction point (SSP). In addition to SSP vacuum readings, vacuum readings at communication test points (CTPs) were recorded (referred to as communication testing). CTPs are ¼" diameter holes located at various points throughout the slab and along the slab's perimeter. Conducting communication testing when the System is in operation provides information on the extent of sub-slab depressurization. Vacuum measurements at CTPs and SSPs are measured using a digital micromanometer and a U-tube manometer, respectively (See Section 2.2).

The System is designed to operate continuously for many years. Life expectancy of the System is dependent primarily on the life expectancy of the fans, which is approximately ten years; however, preventive and routine maintenance (discussed in Section 3) is expected to increase the life expectancy of the System.

2.2 SYSTEM DESCRIPTION

Overall SSD at 1-5 Holland Avenue is achieved using five separate mitigation systems. Each separate system includes a fan and two vertical SSPs, totaling five fans and ten SSPs. Effective SSD of 1-5 Holland is dependent upon the proper simultaneous operation of all five systems. The layout of these separate systems is illustrated on Figure 1. A brief summary of the five systems is as follows:

System ID	Fan Type	Associated SSPs
2A	HP-220	2A-A & 2A-B
3A	GP-501	3A-A & 3A-B
3B	GP-501	3B-A & 3B-B
4A	HS-3000	4A-A & 4A-B
4B	GP-501	4B-A & 4B-B

As can be seen in the summary above, three different fan types have been installed. The different fan types were selected based upon manufacturer specified flow rate and vacuum data. Copies of manufacturer's specifications are provided in Appendix C.

The fans and exterior electrical connections are weather-rated for outdoor installation. With the exception of the HS-3000 fan, the fans are enclosed in a cover made from acrylonitrile butadiene styrene (ABS) plastic. The ABS plastic cover is installed for aesthetic purposes only and does not provide any weather-proofing protection. The ABS plastic covers can be removed to inspect and/or replace the fans. The HS-3000 fan comes as a factory-sealed unit with the fan enclosed in a hard plastic case. Tampering with the opening to this case will break the factory-seal and void any warranties.

Electrical power for each fan is provided by adjacent junction boxes with enough available power at the time of installation. Electrical circuits that provide power to the fans have been labeled inside their respective electrical panels. Tampering with, overloading, or disabling these electrical circuits is not recommended.

System piping is constructed using schedule 40 PVC pipe. The vertical SSPs connect into horizontal header pipe that extends to the exterior of the building, where the respective fan is mounted. All interior piping is sloped to allow for proper drainage of condensation away from the fan. On the building's exterior, PVC pipe is used to route the fans exhaust above the roof edge.

Each SSP is equipped with a pressure gage (U-tube manometer) to alert occupants or owners of System malfunction. This is a plastic U-shaped tube containing red dyed oil. The red oil is an indicator of operational status. The proper way to read the U-tube manometer is as follows:

- If the oil in the manometer is level on both sides of the U, the system is not operating.
- If the oil in the manometer has unequal or different readings, the system is operating. The amount of vacuum induced in the SSP is indicated as the level of the oil in the manometer. This vacuum (measured as inches of water column) is read at the intersection of the red dye oil and the numerical value on the high side of the manometer (where the tubing from the manometer extends into the SSP).

In addition to a manometer, each SSP has been installed with a knife valve used by VI professionals to balance and/or direct vacuum beneath the slab. Tampering with, or adjusting these valves is not recommended. In the event that the manometer indicates the System is not operating, or in the event that the knife valve is inadvertently adjusted, it is recommended that you contact a VI professional at the phone number listed at the beginning of this manual, or on the sticker adhered to each SSP.

2.3 SYSTEM MODIFICATIONS

In February 2013, a horizontal SSP was added in the southeast corner of 1-5 Holland Avenue and was tied into mitigation system 4B. The horizontal SSP exits 1-5 Holland Avenue near the base of the exterior wall, and extends underneath the slab at 7-11 Holland Avenue. The horizontal SSP was installed to mitigate the potential for sub-slab vapor to enter the westernmost portion of 7-11 Holland Avenue.

Similar to vertical SSPs described above, the horizontal SSP is equipped with a knife valve to balance vacuum and a U-tube manometer to alert occupants or owners of System malfunction.

2.4 SYSTEM ENHANCEMENTS

Throughout the end of 2013 and early 2014, the 1-5 Holland Avenue buildings' use was modified; the empty buildings were equipped with multiple self-storage lockers. The lockers and associated infrastructure were installed around some of the existing System components and as a result, some System components were no longer visible and/or accessible. More specifically, seven SSPs and associated U-tube manometers were no longer readily visible and accessible.

In January 2014, an audible alarm was installed on each individual mitigation system to alert occupants or owners of a System malfunction. The installation of the alarms was warranted due to limited visibility and access to all System components.

Each alarm is equipped with an electronic pressure switch that is activated when the vacuum in the System piping is reduced. When the pressure switch is activated, the alarm emits a steady tone to alert a malfunction. Within approximately four feet of each alarm, is an electrical outlet for which the alarm is plugged into. Should an alarm alert a malfunction, the alarm can be silenced by unplugging its power supply from the adjacent electrical outlet.

Each alarm also includes an indicator light. When the alarm is receiving power and there is adequate pressure in the system piping the indicator light is green. When the alarm is powered on and pressure in the system

piping is reduced, the indicator light turns red. If the indicator light on the alarm is not lit, this indicates that the alarm has lost power. In cases other than a power outage effecting the entire building, if an alarm's indicator light is not lit, the property owner should verify that power is being supplied to the alarm's outlet. If the alarm unit is receiving power but the indicator light remains unlit, the owner should contact the VI professional at the phone number listed at the beginning of this manual, or on the sticker adhered to each SSP. It is also recommended that you contact a VI professional should an audible or indicator light alarm alert a malfunction.

In the event of a power outage to the building, each System fan will shut down; therefore, reducing the vacuum in System piping. During the power outage, the alarms will not function. When power is restored and System fans restart, the alarms may briefly sound until enough vacuum is restored in System piping. The alarms should then silence themselves and no further action should be necessary. Should an alarm continue to sound after a power outage, disconnect the alarms' power supply and contact a VI professional at the phone number listed at the beginning of this manual, or on the sticker adhered to each SSP.

3. ROUTINE MAINTENANCE

This section provides a summary of routine maintenance activities associated with the System installed at 1-5 Holland Avenue.

3.1 ANNUAL INSPECTION

It is our recommendation that annual inspections should be conducted to assess System performance and to conduct a complete visual inspection of the structure and the System's installation, both indoors and outdoors. Note that NYSDOH guidance recommends a complete System inspection every 12 to 18 months. Copies of annual System inspection forms are included in Appendix D; prior System inspections were conducted on the following dates:

- February 27 and March 6, 2012
- March 27, 2013
- January 23 and January 24, 2014

In general, items recommended for inspection include:

- Structure – Checking for changes in the structure that could affect the system's performance.
- Fan and Electrical – Recording suction point vacuums and comparison with the prior commissioned vacuums as well as inspections of electrical connections.
- Piping, Slab and Wall – Inspecting piping supports, connections, and exhaust stack. Checking for visible new cracks in walls and floors.

Copies of blank inspection forms are included in Appendix E. While there may be some items contained in the field forms that may not apply, the forms can be used to guide an individual through the inspection process. The field forms provide documentation for "as-found" conditions, which are System conditions existing at the beginning of the inspections. If changes are made to the System by the inspectors (referred to as corrective actions), then the field forms also provide documentation for "as-left" conditions, which are the System conditions at the end of the inspection after corrective actions are performed. If no corrective actions are performed then documentation of "as-left" conditions is not applicable. Further explanation of the forms are presented in the following sub-sections.

3.1.1 Fan and Electrical Inspection

The Fan and Electrical Inspection field form helps to identify the operational status of the System. As previously indicated, the System was commissioned immediately after installation. It is assumed that the strength of the SSD (*i.e.*, induced vacuum) will not change so long as the SSP vacuum readings remain the same as they were during the prior commissioning, which is either the initial commissioning or the latest re-commissioning. Therefore, System vacuums should be compared to vacuums recorded during the prior commissioning. For reference purposes, the following table presents SSP vacuum readings (in inches of water column) recorded during the most recent re-commissioning conducted on March 27, 2013:

SSP	2A-A	2A-B	3A-A	3A-B	3B-A	3B-B	4A-A	4A-B	4B-A	4B-B	4B-C
Vacuum Reading In. w.c.	-2 3/8	-2 1/4	-1 7/8	-1 3/8	-3 1/2	-3 3/8	-2 1/2	-2 1/2	-2 3/8	-2 1/4	-2 1/4

We recommend communication testing (re-commissioning) if there is a change in SSP vacuums of more than 0.25 inches of water column ("w.c."). Communication testing will provide verification that the slab is depressurized. We identify acceptable communication test results (at CTPs) as vacuum readings greater than -0.004 "w.c. The criteria requiring corrective action and/or re-commissioning is specified on the Fan and Electrical Inspection field form.

The Fan and Electrical Inspection field form provides a checklist to inspect exterior components of the System. Exterior seals around pipe penetrations, flexible couplings on the fan, and fan mounts should be inspected. In addition, the checklist provides an area to inspect electrical connections, junction boxes and System labels.

Should the results of the annual inspection require re-commissioning, we suggest that the re-commissioning be conducted by a VI professional. For re-commissioning activities, contact a VI professional at the phone number listed at the beginning of this manual, or on the sticker adhered to each SSP. The results of annual inspections should be recorded and presented to VI professionals during scheduled visits.

3.1.2 Piping, Slab and Wall Inspection

The Piping, Slab and Wall Inspection field form provides a checklist for inspection of System piping and pipe seals to the concrete slab. Smoke testing using a non-hazardous visible smoke is used to identify air leaks around pipe joints and around the pipe seal where it penetrates the concrete slab. Since the System is under negative pressure, openings in System piping or in the seal in the concrete slab will draw smoke. If identified, these openings should be sealed with an approved sealant (polyurethane caulk). A copy of the material Safety Data Sheet (MSDS) of an approved sealant is contained in Appendix C.

The Piping, Slab and Wall Inspection field form also provides a checklist to identify slab/wall cracks or openings that can short-circuit SSD. Similar to the pipe inspection, smoke testing is used to identify cracks or openings that may affect System performance. With the System in operation, cracks or opening that penetrate completely through the slab or wall may draw smoke. If identified, these cracks should be sealed as described above. If cracks or openings are too large to be sealed with caulk, concrete may be used.

3.2 SYSTEM STATUS

Prior to each annual inspection, prior inspections and records of recent system maintenance work included in Appendix D should be reviewed. Additional information on system status at the time this O&M Manual was prepared is provided below.

As previously mentioned, seven SSPs are no longer readily visible and accessible due to building modifications. Further clarification of SSP access is as follows:

SSP	Clarification
SSP 2A-A	Located behind a false wall in office area. U-tube manometer can be accessed by removing access panel installed in the wall.
SSP 2A-B	Located behind a false wall in office area. U-tube manometer can be accessed by removing access panel installed in the wall.
SSP 3A-A	Located in locker 1249
SSP 3B-A	Located in locker 1237
SSP 4B-A	Located in locker 1047
SSP 4B-B	Located in locker 1009
SSP 4B-C	Located in locker 1069

New tile was installed atop the slab where SSP 2A-B is located. The integrity of the seal around SSP 2A-B where the pipe penetrates the floor could not be tested due to the installation of the false wall. Similarly, the integrity of the seal around SSP 2A-A could not be tested for the same reason.

The fan cover on fan 4B was cracked and partially broken, likely due to falling snow and ice from the roofline. This fan cover is installed for aesthetic purposes only, the cover does not provide weatherproofing protection; therefore, the partially broken cover should not impact System performance.

4. NON-ROUTINE MAINTENANCE

This section provides a summary of typical reasons to contact a VI professional to investigate and/or repair System components. In instances where investigation or repair of System components does not occur during recommended inspection intervals, we refer to this as non-routine maintenance. In some cases, a VI professional may not be required to make repairs, however a VI professional should be consulted. A VI professional can be contacted at the phone number listed at the beginning of this manual, or on the sticker adhered to each SSP.

4.1 GENERAL NON-ROUTINE MAINTENANCE

From time to time, non-routine maintenance may be necessary to ensure System effectiveness. In general, some non-routine maintenance may be performed by someone other than a VI professional. Instances of non-routine maintenance that can be performed by the owner may include:

1. Replacement of broken pipe straps
2. Minor electrical repairs
3. Sealing of openings or cracks in the slab
4. Repair of broken System piping, both interior or exterior
5. Replacement of fan covers, exhaust caps, U-tube manometers, and/or System fans if “like-in-kind”

Most corrective actions do not affect the System’s ability to depressurize the slab. Note that corrective actions 4 and 5 do not require communication testing unless they change the SSP vacuums by greater than 0.25” w.c. from the prior commissioned vacuums (similar to annual inspections).

Should the results of the non-routine maintenance require re-commissioning, we suggest that the re-commissioning be conducted by a VI professional. For re-commissioning activities, contact a VI professional at the phone number listed at the beginning of this manual, or on the sticker adhered to each SSP.

4.2 NON-ROUTINE MAINTENANCE POTENTIALLY REQUIRING SYSTEM RE-DESIGN

As previously mentioned, the System was specifically designed for 1-5 Holland Avenue to mitigate the potential for sub-slab vapors to enter the buildings. The System design took into consideration characteristics such as heating and ventilating components (HVAC), building footprint and use, and concrete slab condition. In the event that changes are made to some or all of these characteristics, System effectiveness may be compromised resulting in a necessary System re-design. Specific instances when the need for a System re-design should be investigated are as follows:

1. When changes are made to the building’s footprint (adding to, or removing part of the building)
2. When major changes are made to occupied spaces
3. When new HVAC or combustion devices are added or replaced
4. When modifications are made to heating/ventilating systems
5. When equipment footers are added beneath the concrete slab
6. When major portions of the concrete slab are opened
7. When sump pits are added

We recommend consultation with a VI professional prior to conducting work that may require a System re-design. In some circumstances, a VI professional can work with your engineers during conceptual design phases to incorporate System modifications, if necessary, into your construction activities.

5. RECORDKEEPING AND O&M MANUAL UPDATE REQUIREMENTS

Recordkeeping and O&M manual update requirements are provided below.

5.1 RECORDKEEPING AND O&M MANUAL UPDATE REQUIREMENTS

A copy of this O&M Manual is maintained in the project files by One Holland Avenue Development and by the property owner at the 1-5 Holland Avenue building. Following each annual inspection, Appendix D of the Manual will be updated with a copy of the Completed System Inspection Field Forms and documentation of any routine or non-routine maintenance, as provided in Section 3.0 and 4.0, respectively. Following a change in site conditions, property use, or design/operation of the SSD System, the O&M Manual will updated, as necessary, and copies of the updated Manual redistributed.

*Mitigation System Record
Drawing*

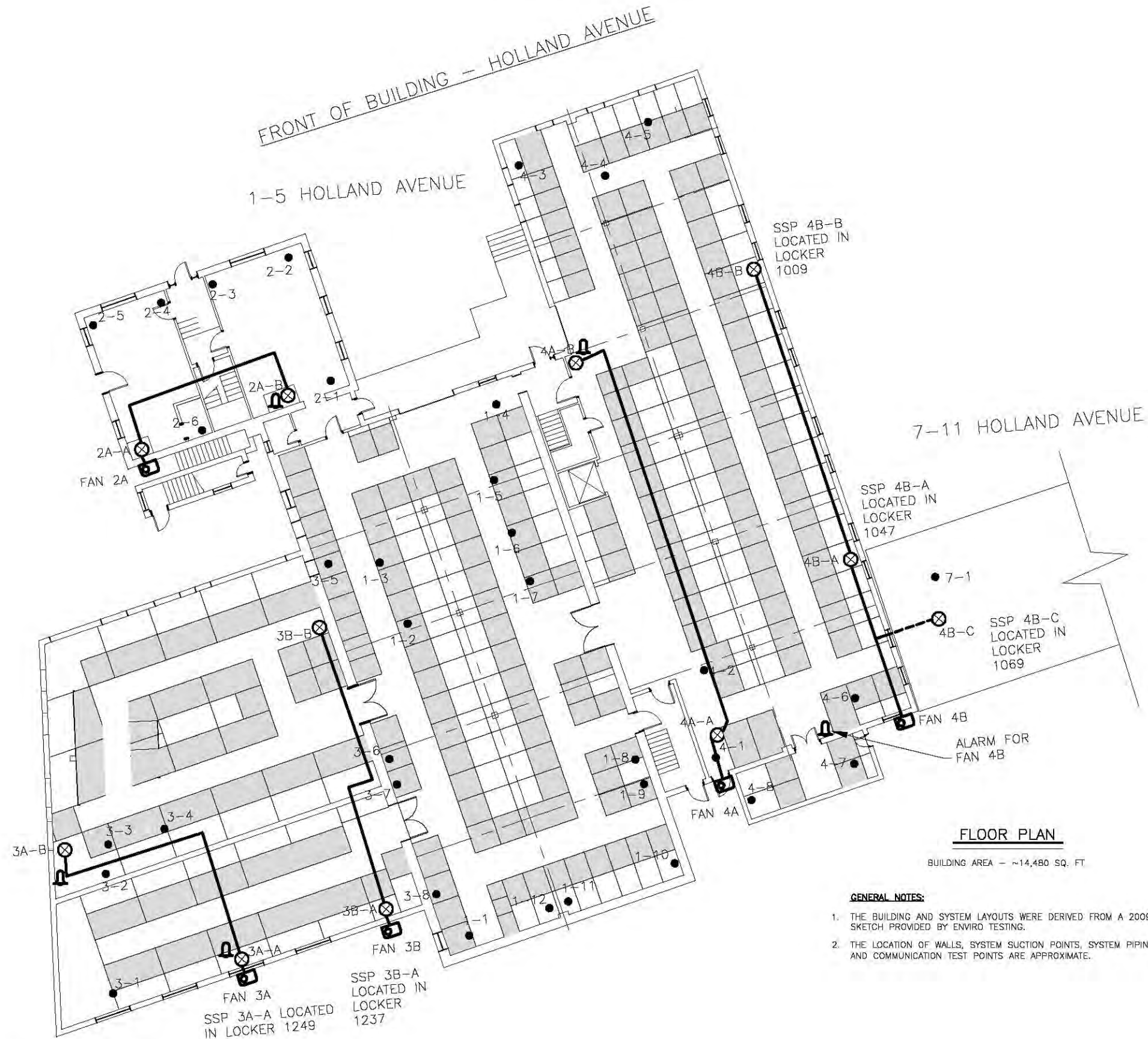

LEGEND

- EXISTING WALL
- ⊗ SYSTEM SUCTION POINT (SSP)
- COMMUNICATION TEST POINT (CTP)
- EXHAUST PIPE
- ☐ EXHAUST FAN
- HORIZONTAL SUB-SLAB SUCTION POINT
- 🔔 MITIGATION SYSTEM ALARM

FLOOR PLAN
BUILDING AREA - ~14,480 SQ. FT.

- GENERAL NOTES:**
1. THE BUILDING AND SYSTEM LAYOUTS WERE DERIVED FROM A 2009 SKETCH PROVIDED BY ENVIRO TESTING.
 2. THE LOCATION OF WALLS, SYSTEM SUCTION POINTS, SYSTEM PIPING AND COMMUNICATION TEST POINTS ARE APPROXIMATE.

IT IS A VIOLATION OF LAW FOR ANY PERSON, UNLESS ACTING UNDER THE DIRECTION OF A LICENSED ENGINEER, TO ALTER THIS DOCUMENT.

THIS DRAWING WAS PREPARED AT THE SCALE INDICATED IN THE TITLE BLOCK. INACCURACIES IN THE STATED SCALE MAY BE INTRODUCED WHEN DRAWINGS ARE REPRODUCED BY ANY MEANS. USE THE GRAPHIC SCALE BAR IN THE TITLE BLOCK TO DETERMINE THE ACTUAL SCALE OF THIS DRAWING.

IN CHARGE OF _____ EMA	NO SCALE	NO.	DATE	REVISION	INIT.	 333 W. WASHINGTON STREET SYRACUSE, NY 13221 2014 © O'Brien & Gere Engineers, Inc.	MITIGATION SYSTEM RECORD DRAWING	SUB-SLAB DEPRESSURIZATION SYSTEM 1-5 HOLLAND AVENUE WHITE PLAINS, NEW YORK	FILE NO. 14206.47376	1 OF 1
DESIGNED BY _____ CHECKED BY _____									DATE FEBRUARY 2014	
DRAWN BY _____ EMA										

*Photolog of Major
System Components*

PHOTOGRAPHIC LOG

SITE NAME: 1-5 Holland Ave.		SITE LOCATION: White Plains, NY	PROJECT NO. 47376
PHOTO NO. 1	DATE: 02/28/12		
DESCRIPTION HS-3000 fan identified as Fan 4A.			
AREA ID Rear of Building.			

CLIENT NAME: 1-5 Holland Ave.		SITE LOCATION: White Plains, NY	PROJECT NO. 47376
PHOTO NO. 2	DATE: 02/28/12		
DESCRIPTION GP-501 fan identified as Fan 4B – fan cover off.			
AREA ID Rear of Building.			

PHOTOGRAPHIC LOG

CLIENT NAME: 1-5 Holland Ave.		SITE LOCATION: White Plains, NY	PROJECT NO. 47376
PHOTO NO. 3	DATE: 2/28/12		
DESCRIPTION SSP 4B-A, balancing valve and U-tube manometer. U-tube manometer shown indicates System is inoperable.			
AREA ID Interior wall on East side of Building.			

CLIENT NAME: 1-5 Holland Ave.		SITE LOCATION: White Plains, NY	PROJECT NO. 47376
PHOTO NO. 4	DATE: 02/28/12		
DESCRIPTION SSP 3B-A, balancing valve and U-tube manometer. U-tube manometer shown indicates System is functioning.			
AREA ID Rear wall on West side of Building.			

PHOTOGRAPHIC LOG

CLIENT NAME: 1-5 Holland Ave.		SITE LOCATION: White Plains, NY	PROJECT NO. 47376
PHOTO NO. 5	DATE: 02/28/12		
DESCRIPTION Electrical panel with circuit identified.			
AREA ID Interior wall on West side of Building.			

CLIENT NAME: 1-5 Holland Ave.		SITE LOCATION: White Plains, NY	PROJECT NO. 47376
PHOTO NO. 6	DATE: 01/23/14		
DESCRIPTION SSP 2A-B behind false wall.			
AREA ID Northwest portion of Building.			

CLIENT NAME: 1-5 Holland Ave.		SITE LOCATION: White Plains, NY	PROJECT NO. 47376
PHOTO NO. 7	DATE: 01/23/14		
DESCRIPTION SSP 4B-C located in locker 1069. Horizontal penetration through wall is not visible in this photo.			
AREA ID Interior wall on East side of Building.			

CLIENT NAME: 1-5 Holland Ave.		SITE LOCATION: White Plains, NY	PROJECT NO. 47376
PHOTO NO. 8	DATE: 01/23/14		
DESCRIPTION SSP 4A-B with alarm and outlet installed on right side of SSP.			
AREA ID Centrally located along north wall.			

Installation Report



"Your Peace of Mind Is Our Business"

27 Downs Avenue
Binghamton, NY 13905
(607) 770-9098
Fax: (607) 729-5154
www.envirotesting.net

April 13, 2009

Mr. Karl Frydryk
Feintool New York
11280 Cornell Park Drive
Cincinnati, OH 45242

Re: Soil Gas Vent Installations
1-5 Holland Avenue
White Plains, NY 10603

Dear Mr. Frydryk:

Per our February 6, 2009 proposal for the above noted project, enclosed find as-built documents for the installation of sub-slab ventilation systems.

Included in this submittal are:

- A) Contractor Daily Reports describing work activities.
- B) System layout sketch and sub-slab vacuum test data for each building.
- C) Photo documentation of the project.
- D) Material warranties.

Please feel free to call me with any questions. Thank you.

Sincerely,

Richard J. Tarnowski, Vice-President

Enclosure

RJT/tms

cc: 

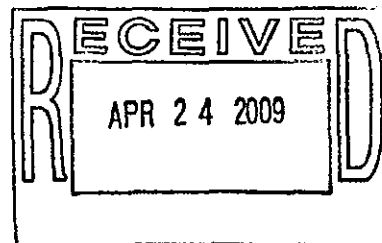

APPENDIX A

Contractor Daily Reports



Contractor's Daily Report

Project # _____
 Soil Vapor Mitigation Project _____

3/17/2009	Address: 1-5 Holland Ave., White Plains	Crew: Jim & Andrew
-----------	---	--------------------

Provide a brief description of daily work performed:

Load truck and drive to White Plains.

Manpower and Equipment

Provide a detailed list of manpower and equipment resources. The Trade field refers to type of manpower, i.e. Carpenter, Electrician, etc. The Classification field refers to qualifications, i.e. Foreman, Journeyman, Apprentice, etc.

HRS	NAME	CLASSIFICATION
3.5	Jim	Supervisor
3.5	Andrew	Laborer

QTY	EQUIPMENT
1	Van

Manpower Units: Manhours Mandays Other _____

Equipment Units: Days Hours Other _____

Events or Issues

Provide a description of any significant events or issues to report. Include quantities and units if applicable:

T & M for mobilization to project site.



Contractor's Daily Report

Project # _____
 Soil Vapor Mitigation Project _____

Date: 03/18/09	Address: 1-5 Holland Ave., White Plains	Crew: Jim & Andrew
-----------------------	--	---------------------------

Provide a brief description of daily work performed:

Drilled suction point 3A-A & 3B-A. Drilled exterior penetration for system 3A & 3B. Installed piping from exterior penetration 3A & 3B to suction points 3A-A & 3B-A with tee and gate valve.

Installed HP220 fan on system 3A and determined that a GP501 fan was needed.

Sealed wall floor joint at exterior wall with caulk.

Manpower and Equipment

Provide a detailed list of manpower and equipment resources. The Trade field refers to type of manpower, i.e. Carpenter, Electrician, etc. The Classification field refers to qualifications, i.e. Foreman, Journeyman, Apprentice, etc.

HRS	NAME	CLASSIFICATION
9	Jim	Supervisor
9	Andrew	Laborer

QTY	EQUIPMENT
1	Van

Manpower Units: Manhours Mandays Other _____

Equipment Units: Days Hours Other _____

Events or Issues

Provide a description of any significant events or issues to report. Include quantities and units if applicable:

1 Supervisor & 1 Laborer @ 1.5 Hrs each to seal wall floor joint.



Contractor's Daily Report

Project # _____
 Soil Vapor Mitigation Project _____

Date: 03/19/09	Address: 1-5 Holland Ave., White Plains	Crew: Jim & Andrew
----------------	---	--------------------

Provide a brief description of daily work performed:

Mount backer plate and GP501 for system 3A & 3B. Install all exterior pipe for system 3A & 3B.
 Install MC wire from panel to junction box at system 3A and from junction box at system 3A
 to Junction box at system 3B. Install piping from a tee at system 3A to block wall for suction point 3A-B.

Manpower and Equipment

Provide a detailed list of manpower and equipment resources. The Trade field refers to type of manpower, i.e. Carpenter, Electrician, etc. The Classification field refers to qualifications, i.e. Foreman, Journeyman, Apprentice, etc.

HRS	NAME	CLASSIFICATION
9.5	Jim	Supervisor
9.5	Andrew	Laborer

QTY	EQUIPMENT
1	Van

Manpower Units: Manhours Mandays Other _____

Equipment Units: Days Hours Other _____

Events or Issues

Provide a description of any significant events or issues to report. Include quantities and units if applicable:



Contractor's Daily Report

Project # _____
 Soil Vapor Mitigation Project _____

Date: 03/20/09	Address: 1-5 Holland Ave., White Plains	Crew: Jim & Andrew
-----------------------	--	---------------------------

Provide a brief description of daily work performed:

Installed wiring from junction box to weather proof switch mounted inside fan housing to fan 3A & 3B.
 Sealed expansion joint in northern room of building #3. Performed diagnostics to determine where to install suction point 3A-B & 3B-B.

Manpower and Equipment

Provide a detailed list of manpower and equipment resources. The Trade field refers to type of manpower, i.e. Carpenter, Electrician, etc. The Classification field refers to qualifications, i.e. Foreman, Journeyman, Apprentice, etc.

HRS	NAME	CLASSIFICATION	QTY	EQUIPMENT
9	Jim	Supervisor	1	Van
9	Andrew	Laborer		

Manpower Units: Manhours Mandays Other _____

Equipment Units: Days Hours Other _____

Events or Issues

Provide a description of any significant events or issues to report. Include quantities and units if applicable:

T & M - One (1) Supervisor & One (1) Laborer @ 1.0 Hrs. each to seal expansion joint in room 2 of building 3.

One (1) Supervisor and One (1) Laborer at 3.5 hours to travel back to Binghamton.



Contractor's Daily Report

Project # _____
 Soil Vapor Mitigation Project _____

Date: 03/25/09	Address: 1-5 Holland Ave., White Plains	Crew: Jim & Andrew
-----------------------	--	---------------------------

Provide a brief description of daily work performed:

Drilled suction points 3A-B & 3B-B. Finished all piping for system 3A. Continued installing pipe from suction point 3B-A to 3B-B. Started sealing wall floor joint in northern room of building #3 with caulk. Pick up materials.

Manpower and Equipment

Provide a detailed list of manpower and equipment resources. The Trade field refers to type of manpower, i.e. Carpenter, Electrician, etc. The Classification field refers to qualifications, i.e. Foreman, Journeyman, Apprentice, etc.

HRS	NAME	CLASSIFICATION	QTY	EQUIPMENT
10	Jim	Supervisor	1	Van
10	Andrew	Laborer		

Manpower Units: Manhours Mandays Other _____

Equipment Units: Days Hours Other _____

Events or Issues

Provide a description of any significant events or issues to report. Include quantities and units if applicable:

T & M - Return travel to project site - One (1) Supervisor and One (1) Laborer at 3.5 hours.

One (1) Laborer at 1.5 hours to seal wall floor joint with caulk.



Contractor's Daily Report

Project # _____
 Soil Vapor Mitigation Project _____

Date: 03/26/09	Address: 1-5 Holland Ave., White Plains	Crew: Jim & Andrew
-----------------------	--	---------------------------

Provide a brief description of daily work performed:

Drilled suction point in south portion in building #1. Later deemed not needed and sealed.
 Finished installing all interior piping for system 3B to suction point 3B-B. Performed diagnostics for system 3A & 3B.
 Performed vacuum testing for building #1 and determined that system needed to be installed in building #4 before building #1 is addressed. Drilled suction point #4A-A, exterior penetration for system 4A and interior penetration above suction point 4A-A. Installed piping from suction point 4A-A to interior penetration above suction point 4A-A with tee and gate valve.

Manpower and Equipment

Provide a detailed list of manpower and equipment resources. The Trade field refers to type of manpower, i.e. Carpenter, Electrician, etc. The Classification field refers to qualifications, i.e. Foreman, Journeyman, Apprentice, etc.

HRS	NAME	CLASSIFICATION
9	Jim	Supervisor
9	Andrew	Laborer

QTY	EQUIPMENT
1	Van

Manpower Units: Manhours Mandays Other _____

Equipment Units: Days Hours Other _____

Events or Issues

Provide a description of any significant events or issues to report. Include quantities and units if applicable:



Contractor's Daily Report

Project # _____
 Soil Vapor Mitigation Project _____

Date: 03/27/09	Address: 1-5 Holland Ave., White Plains	Crew: Jim & Andrew
-----------------------	--	---------------------------

Provide a brief description of daily work performed:

Installed piping from exterior penetration to tee in wall at suction point 4A-A. Installed HP220 fan and performed diagnostics. Installed HS3000 fan and performed diagnostics with better results in Building 4 and also resulted in vacuum in Building 1. Started installing piping from suction point 4A-A to suction point 4A-B. Started sealing expansion joint in Building 4 with caulk. Loaded truck and drove back to Binghamton.

Manpower and Equipment

Provide a detailed list of manpower and equipment resources. The Trade field refers to type of manpower, i.e. Carpenter, Electrician, etc. The Classification field refers to qualifications, i.e. Foreman, Journeyman, Apprentice, etc.

HRS	NAME	CLASSIFICATION	QTY	EQUIPMENT
8.5	Jim	Supervisor	1	Van
8.5	Andrew	Laborer		

Manpower Units: Manhours Mandays Other _____

Equipment Units: Days Hours Other _____

Events or Issues

Provide a description of any significant events or issues to report. Include quantities and units if applicable:

T&M - Replaced HP200 with HS3000 high suction fan. One (1) Supervisor and One (1) Laborer at 2.0 hours each.

Material used: 1 HS3000, 1 SW electrical box, 2 3" x 3" flex couplings.

One (1) Supervisor and One (1) Laborer at 3.5 hours each travel to return to Binghamton, NY.



Contractor's Daily Report

Project # _____
 Soil Vapor Mitigation Project _____

Date: 03/30/09 **Address:** 1-5 Holland Ave., White Plains **Crew:** Jim, Lat, Chris, Jon, Duke. & Andrew

Provide a brief description of daily work performed:

Finished installing pipe to suction point 4A-B. Mounted HS3000 fan and installed all exterior pipe. Installed wire from fan switch to new 4" square junction box in boiler room. Continued sealing floor cracks with caulk. Sealed most of wall/floor joint in Building #3 with Thorite masonry.

Manpower and Equipment

Provide a detailed list of manpower and equipment resources. The Trade field refers to type of manpower, i.e. Carpenter, Electrician, etc. The Classification field refers to qualifications, i.e. Foreman, Journeyman, Apprentice, etc.

HRS	NAME	CLASSIFICATION	QTY	EQUIPMENT
9.5	Jim	Supervisor	3	Van
9	Lat	Crew Chief		
7	Chris	Laborer		
7	Jon	Laborer		
9	Duke	Laborer		
9.5	Andrew	Laborer		

Manpower Units: Manhours Mandays Other _____

Equipment Units: Days Hours Other _____

Events or Issues

Provide a description of any significant events or issues to report. Include quantities and units if applicable:

T&M Sealing work - One (1) Supervisor, One (1) Crew Chief and Four (4) Laborers.
Travel to project site to begin sealing. Started sealing floor cracks and wall floor joint.
Crew Chief - 9.0 hours, Two (2) Laborers at 7.0 hours, One (1) Laborer at 9.0 hours,
One (1) Supervisor at 3.5 hours for travel only, and One (1) Laborer at 3.5 hours each for travel only.



Contractor's Daily Report

Project # _____
 Soil Vapor Mitigation Project _____

Date: 03/31/09	Address: 1-5 Holland Ave., White Plains	Crew: Jim, Andrew, Lat, Chris, Jon, & Duke
-----------------------	--	---

Provide a brief description of daily work performed:

Perform diagnostics for building #4 and determine that another fan with 2 suction points are needed. Drilled suction points 4B-A and 4B-B. Drilled exterior penetration for system 4B. Started installing pipe from exterior penetration to suction point 4B-B. Mounted backer plate and HP220 fan for system 4B. Installed and secured all exterior piping for system 4B. Wired fan to weather proof switch mounted inside fan housing and ran wire from switch to new 4" Square junction box mounted inside building. Continued sealing floor cracks with caulk. Finished sealing wall floor joints with Thorite. Finished sealing larger cracks and broken floor areas with sand mix concrete. Foam seal wood platform below electric service to broken raised concrete slab. Survey building # 2 for system install.

Manpower and Equipment

Provide a detailed list of manpower and equipment resources. The Trade field refers to type of manpower, i.e. Carpenter, Electrician, etc. The Classification field refers to qualifications, i.e. Foreman, Journeyman, Apprentice, etc:

HRS	NAME	CLASSIFICATION	QTY	EQUIPMENT
9	Jim	Supervisor	3	Van
9	Andrew	Laborer	2	Bags Thorite
9	Lat	Crew Chief	1	Bag sand mix concrete
9	Chris	Laborer	5	Cans Foam
9	Jon	Laborer	92	Geocell 3300
9	Duke	Laborer		

Manpower Units: Manhours Mandays Other _____

Equipment Units: Days Hours Other _____

Events or Issues

Provide a description of any significant events or issues to report. Include quantities and units if applicable:

T&M Sealing work.

One (1) Crew Chief (Foreman) - 9.0 hours

Three (3) Laborers - 9.0 hours each



Contractor's Daily Report

Project # _____
 Soil Vapor Mitigation Project _____

Date: 04/01/09 **Address:** 1-5 Holland Ave., White Plains **Crew:** Jim, Andrew, Lat, Chris, Jon, & Duke

Provide a brief description of daily work performed:

Finish installing all interior piping for system 4B. Drill suction points 2A-A & 2A-B. Drill exterior penetration for system 2A. Install and secure pipe from exterior penetration at system 2A to suction point 2A-A. Mount backer plate and GP501 fan for system 2A. Start installing pipe above drop ceiling from tee at suction point 2A-A to suction point 2A-B. Core drill wall penetration for pipe routing through stairway, completed all remaining sealing. Start cleaning all work areas and checking sub-slab vacuum numbers. Sealed a total of 2,150 Lf of floor cracks. Used 92 tubes of GeoCel caulk, 5 cans of foam and 3 bags of Thorite concrete.

Manpower and Equipment

Provide a detailed list of manpower and equipment resources. The Trade field refers to type of manpower, i.e. Carpenter, Electrician, etc. The Classification field refers to qualifications, i.e. Foreman, Journeyman, Apprentice, etc.

HRS	NAME	CLASSIFICATION	QTY	EQUIPMENT
9	Jim	Supervisor	3	Van
9	Andrew	Laborer		
9	Lat	Crew Chief		
8.5	Chris	Laborer		
8.5	Jon	Laborer		
8.5	Duke	Laborer		

Manpower Units: Manhours Mandays Other _____

Equipment Units: Days Hours Other _____

Events or Issues

Provide a description of any significant events or issues to report. Include quantities and units if applicable:

T&M for sealing and return trip to Binghamton office.

Three (3) Laborers at 8.5 hours each.



Contractor's Daily Report

Project # _____
 Soil Vapor Mitigation Project _____

Date: 04/02/09	Address: 1-5 Holland Ave., White Plains	Crew: Jim, Andrew & Lat
----------------	---	-------------------------

Provide a brief description of daily work performed:

Core drilled 2nd interior penetration for pipe routing through stairway. Finished all interior piping for system 2A. Installed all exterior piping for system 2A. Changed HP220 fan at system 4B to GP501. Performed diagnostics with good communication through all 4 buildings. Sealed all test holes with caulk. Cleaned all work areas, loaded trucks and drove back to Binghamton.

Manpower and Equipment

Provide a detailed list of manpower and equipment resources. The Trade field refers to type of manpower, i.e. Carpenter, Electrician, etc. The Classification field refers to qualifications, i.e. Foreman, Journeyman, Apprentice, etc.

HRS	NAME	CLASSIFICATION	QTY	EQUIPMENT
11	Jim	Supervisor	2	Van
11	Andrew	Laborer		
11	Lat	Crew Chief		

Manpower Units: Manhours Mandays Other _____
 Equipment Units: Days Hours Other _____

Events or Issues

Provide a description of any significant events or issues to report. Include quantities and units if applicable:

T&M for travel back to Binghamton office.
Two (2) Supervisor (Foreman) at 3.5 hours each.
One (1) Laborer at 3.5 hours.

APPENDIX B

System Layout Sketch And Sub-Slab Vacuum Test Data

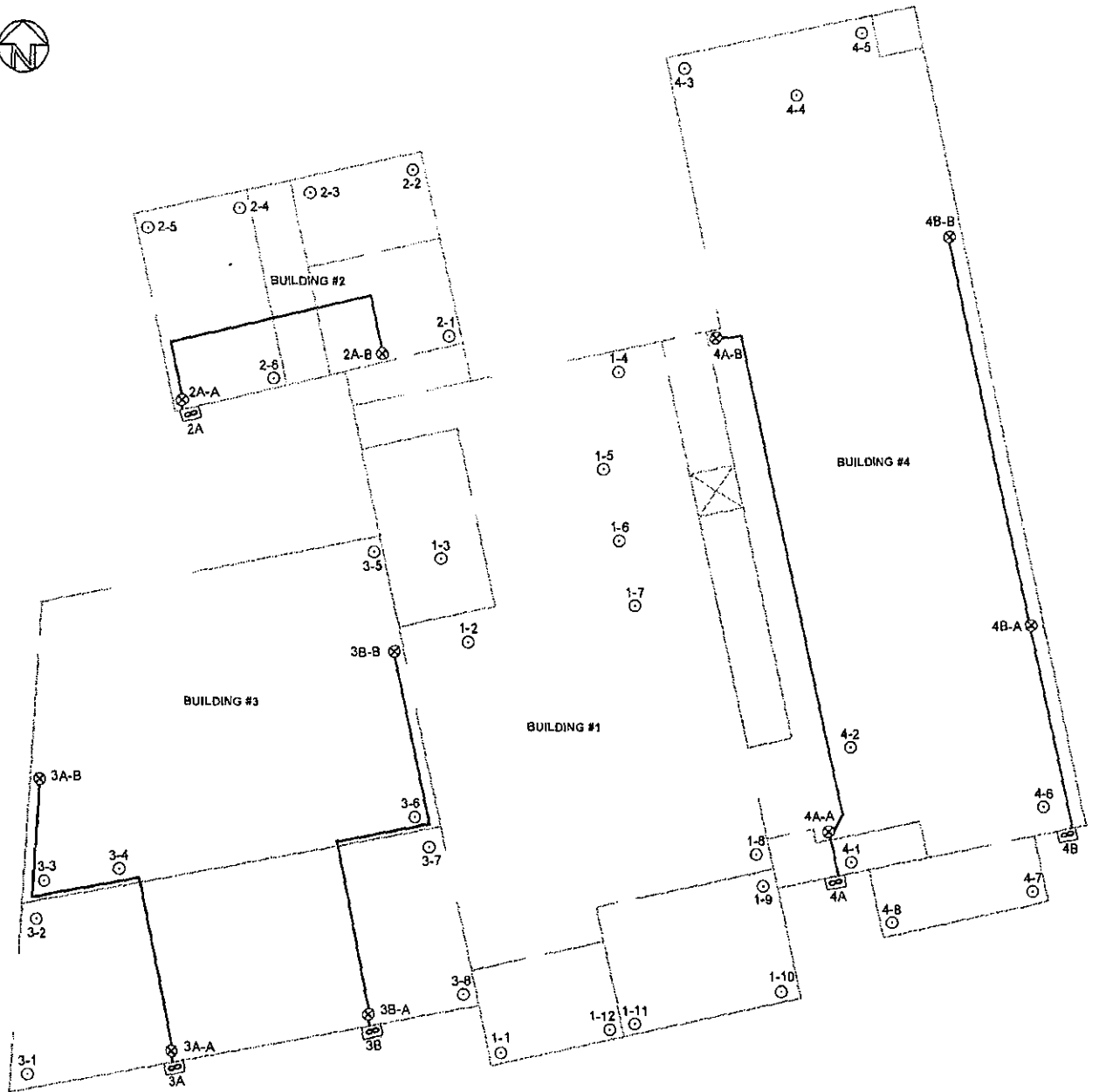

NOTE: DRAWING NOT TO SCALE.
ALL WALLS ARE APPROXIMATE,
ACTUAL LOCATIONS MAY VARY.

LOCATION: 1 - 5 HOLLAND AVENUE
WHITE PLAINS, NY 10603

DATE: MARCH 27, 2009

SYMBOLS



SUCTION POINT



COMMUNICATION TEST HOLES

PIPE ROUTE



EXHAUST FAN

**SOIL VAPOR MITIGATION PROJECT
FEINTOOL**

ENVIRO TESTING



27 DOWNS AVENUE
BINGHAMTON, NEW YORK 13905
(607) 770-9098 FAX: (607) 729-5154
WWW.ENVIROTESTING.NET

PAGE 1 OF 2

REV. DRAWN BY:
JEM

SCALE: NO SCALE

DATE: 4/14/2009

JOB: WORK SKETCH

COMMUNICATION TEST DATA

HOLE	DISTANCE	LEVEL
A	SEE PAGE 2	SEE PAGE 2
B	FOR TEST DATA	FOR TEST DATA
C		
D		

Sub-Slab Vacuum Testing After SSDS Installs
 1-5 Holland Avenue, White Plains, New York
 April 2, 2009

Building #	SSDS ID #	Suction Point ID #	U-Tube Reading (1)	Vacuum Test Hole Readings (1) (2)											
				1	2	3	4	5	6	7	8	9	10	11	12
1	None	None	None	-0.021	-0.058	-0.061	-0.008	-0.027	-0.055	-0.049	-0.023	-0.015	-0.005	-0.007	-0.006
2	2A	2A-A	2 1/4"	-0.129	-0.015	-0.009	-0.017	-0.197	-0.143	-	-	-	-	-	-
		2A-B	2 1/4"												
3	3A	3A-A	1 3/4"	-0.045	-0.538	-0.908	-0.254	-0.040	-0.088	-0.063	-0.057	-	-	-	-
		3A-B	1 3/4"												
	3B	3B-A	3 1/2"												
		3B-B	3 1/2"												
4	4A	4A-A	3 3/4"	-0.057	-0.112	-0.019	-0.006	-0.006	-0.046	-0.008	-0.008	-	-	-	-
		4A-B	3 3/4"												
	4B	4B-A	3 1/2"												
		4B-A	3 1/2"												

- (1) Readings in inches of water column
- (2) Refer to SSDS field diagram for locations of vacuum test holes

APPENDIX C

Photo Documentation



**SSDS Install Photos
1-5 Holland Avenue
White Plains, NY**

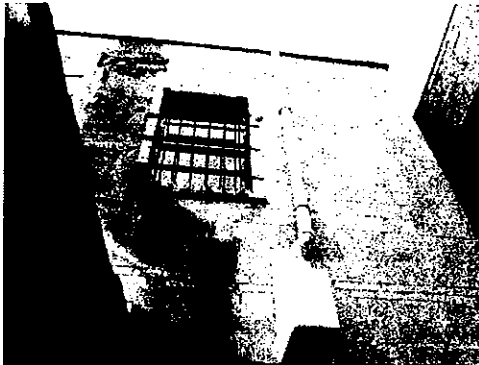

Photo 1 is a typical view of an outside mounted exhaust fan and discharge pipe for system 4B on Building #4.

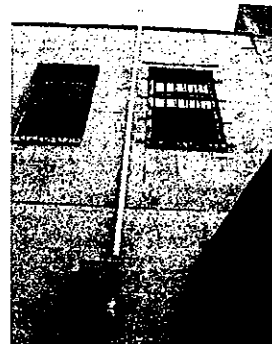

Photo 2 is an exterior view of the HS3000 high suction fan installed for system 4A in Building 4.



Photo 3 is a view showing a typical valved interior suction point (#4A-B) in Building #4.

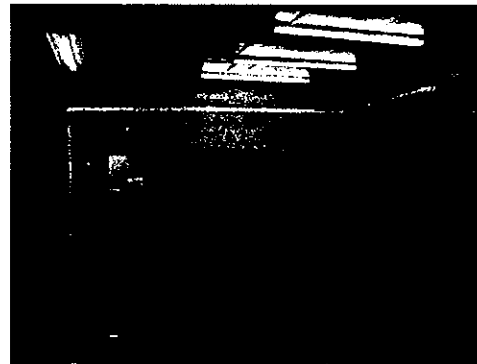

Photo 4 is a typical view of interior installed suction piping for suction point 3B-B in Building #3.



Photo 5 is an interior view of typical floor sealing performed in all four buildings.

APPENDIX D

Material Warranties

IMPORTANT INSTRUCTIONS TO INSTALLER

Inspect the HS Series Fan for shipping damage within 15 days of receipt. Notify **RadonAway** of any damages immediately. Radonaway is not responsible for damages incurred during shipping. However, for your benefit, Radonaway does insure shipments.

There are no user serviceable parts inside the fan. **Do not attempt to open.** Return unit to factory for service.

Install the HS Series Fan in accordance with all EPA standard practices, and state and local building codes and state regulations.

WARRANTY

Subject to any applicable consumer protection legislation, RadonAway warrants that the HS Series Fan (the "Fan") will be free from defects in materials and workmanship for a period of one (1) year from the date of manufacture (the "Warranty Term"). Outside the Continental United States and Canada the Warranty Term is one (1) year from the date of manufacture.

RadonAway will replace any Fan which fails due to defects in materials or workmanship. The Fan must be returned (at owner's cost) to the RadonAway factory. Proof of purchase must be supplied upon request for service under this Warranty.

This Warranty is contingent on installation of the Fan in accordance with the instructions provided. This Warranty does not apply where any repairs or alterations have been made or attempted by others, or if the unit has been abused or misused. Warranty does not include damage in shipment unless the damage is due to the negligence of RadonAway.

RadonAway is not responsible for installation, removal or delivery costs associated with this Warranty.

EXCEPT AS STATED ABOVE, THE HS SERIES FANS ARE PROVIDED WITHOUT WARRANTY OF ANY KIND, EITHER EXPRESS OR IMPLIED, INCLUDING, WITHOUT LIMITATION, IMPLIED WARRANTIES OF MERCHANTABILITY AND FITNESS FOR A PARTICULAR PURPOSE.

IN NO EVENT SHALL RADONAWAY BE LIABLE FOR ANY DIRECT, INDIRECT, SPECIAL, INCIDENTAL, OR CONSEQUENTIAL DAMAGES ARISING OUT OF, OR RELATING TO, THE FAN OR THE PERFORMANCE THEREOF. RADONAWAY'S AGGREGATE LIABILITY HEREUNDER SHALL NOT IN ANY EVENT EXCEED THE AMOUNT OF THE PURCHASE PRICE OF SAID PRODUCT. THE SOLE AND EXCLUSIVE REMEDY UNDER THIS WARRANTY SHALL BE THE REPAIR OR REPLACEMENT OF THE PRODUCT, TO THE EXTENT THE SAME DOES NOT MEET WITH RADONAWAY'S WARRANTY AS PROVIDED ABOVE.

For service under this Warranty, contact RadonAway for a Return Material Authorization (RMA) number and shipping information. No returns can be accepted without an RMA. If factory return is required, the customer assumes all shipping cost to and from factory.

RadonAway
3 Saber Way
Ward Hill, MA 01835
TEL. (978) 521-3703
FAX (978) 521-3964

Record the following information for your records:

Serial No. _____

Purchase Date _____

HS3000 fan Inst. 10/24/05 4-1005 [Signature]

IMPORTANT INSTRUCTIONS TO INSTALLER

Inspect the GPx01/XP/XR Series Fan for shipping damage within 15 days of receipt. Notify RadonAway of any damages immediately. Radonaway is not responsible for damages incurred during shipping. However, for your benefit, Radonaway does insure shipments.

There are no user serviceable parts inside the fan. Do not attempt to open. Return unit to factory for service.

Install the GPx01/XP/XR Series Fan in accordance with all EPA standard practices, and state and local building codes and state regulations.

WARRANTY

Subject to any applicable consumer protection legislation, RadonAway warrants that the GPX01/XP/XR/RP Series Fan (the "Fan") will be free from defects in materials and workmanship for a period of 90 days from the date of purchase (the "Warranty Term").

RadonAway will replace any Fan which fails due to defects in materials or workmanship. The Fan must be returned (at Owner's cost) to the RadonAway factory. Any Fan returned to the factory will be discarded unless the Owner provides specific instructions along with the Fan when it is returned regardless of whether or not the Fan is actually replaced under this warranty. Proof of purchase must be supplied upon request for service under this Warranty.

This Warranty is contingent on installation of the Fan in accordance with the instructions provided. This Warranty does not apply where any repairs or alterations have been made or attempted by others, or if the unit has been abused or misused. Warranty does not cover damage in shipment unless the damage is due to the negligence of RadonAway.

5 YEAR EXTENDED WARRANTY WITH PROFESSIONAL INSTALLATION.

RadonAway will extend the Warranty Term of the fan to 5 years from date of manufacture if the Fan is installed in a professionally designed and professionally installed radon system or installed as a replacement fan in a professionally designed and professionally installed radon system. Proof of purchase and/or proof of professional installation may be required for service under this warranty. Outside the Continental United States and Canada the extended Warranty Term is limited to one (1) year from the date of manufacture.

RadonAway is not responsible for installation, removal or delivery costs associated with this Warranty.

EXCEPT AS STATED ABOVE, THE GPx01/XP/XR/RP SERIES FANS ARE PROVIDED WITHOUT WARRANTY OF ANY KIND, EITHER EXPRESS OR IMPLIED, INCLUDING, WITHOUT LIMITATION, IMPLIED WARRANTIES OF MERCHANTABILITY AND FITNESS FOR A PARTICULAR PURPOSE.

IN NO EVENT SHALL RADONAWAY BE LIABLE FOR ANY DIRECT, INDIRECT, SPECIAL, INCIDENTAL, OR CONSEQUENTIAL DAMAGES ARISING OUT OF, OR RELATING TO, THE FAN OR THE PERFORMANCE THEREOF. RADONAWAY'S AGGREGATE LIABILITY HEREUNDER SHALL NOT IN ANY EVENT EXCEED THE AMOUNT OF THE PURCHASE PRICE OF SAID PRODUCT. THE SOLE AND EXCLUSIVE REMEDY UNDER THIS WARRANTY SHALL BE THE REPAIR OR REPLACEMENT OF THE PRODUCT, TO THE EXTENT THE SAME DOES NOT MEET WITH RADONAWAY'S WARRANTY AS PROVIDED ABOVE.

For service under this Warranty, contact RadonAway for a Return Material Authorization (RMA) number and shipping information. No returns can be accepted without an RMA. If factory return is required, the customer assumes all shipping cost to and from factory.

RadonAway
3 Saber Way
Ward Hill, MA 01835
TEL. (978) 521-3703
FAX (978) 521-3964

Record the following information for your records:

Serial No.
Purchase Date 5/15/03 4-1-03 P.H.

Manufacturer's Cut Sheets



Fantech

**Trust the
Industry
Standard!**

Improved UV resistance!

HP Series Fans for Radon Applications

Why put your reputation at stake by installing a fan you know won't perform like a Fantech? For nearly fourteen years, Fantech has manufactured quality ventilation equipment for radon applications. Fantech is the fan radon contractors have turned to in over 1,000,000 successful radon installations worldwide.

Fantech HP Series Fans Provide the Solutions to meet the challenges of radon applications:

HOUSING

- UV resistant, UL listed durable plastic
- UL Listed for use in commercial applications
- Factory sealed to prevent leakage
- Watertight electrical terminal box
- Approved for mounting in wet locations - i.e. Outdoors

MOTOR

- Totally enclosed for protection
- High efficiency EBM motorized impeller
- Automatic reset thermal overload protection
- Average life expectancy of 7-10 years under continuous load conditions

RELIABILITY

- Five Year Full Factory Warrant
- Over 1,000,000 successful radon installations worldwide

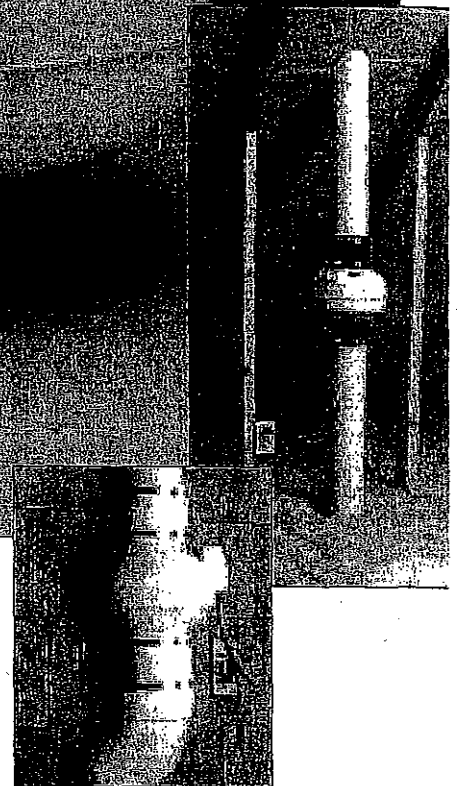
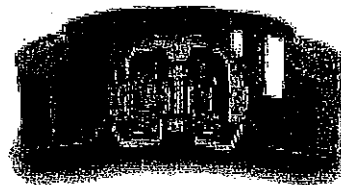



HP Series Fans are specially designed with higher pressure capabilities for radon mitigation applications

Fantech has developed the HP Series fans specifically to suit the higher pressure capability requirements needed in radon mitigation applications. Most radon mitigators who previously used the Fantech FR Series fans have switched to the new HP Series.

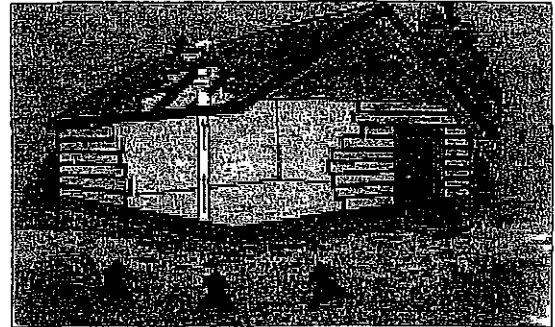

Performance Data

Fan Model	Volts	Wattage Range	Max. Amps	CFM vs. Static Pressure in Inches W.G.								Max. Ps		
				0"	0.5"	0.75"	1.0"	1.25"	1.5"	1.75"	2.0"			
HP2133	115	14-20	0.47	137	88	69	53	40	30	22	16	12	9	0.84
HP2190	115	60-85	0.78	163	126	104	81	58	35	15	-	-	-	1.93
HP175	115	44-65	0.52	137	92	71	50	37	24	15	10	7	5	1.68
HP190	115	60-85	0.78	157	123	106	89	67	45	18	1	-	-	2.01
HP220	115	85-152	1.30	144	100	78	58	37	17	102	58	37	24	2.46



Performance Curves

Fantech provides you with independently tested performance specifications.

The performance curves shown in this brochure are representative of the actual test results recorded at Texas Engineering Experiment Station/Energy Systems Lab, a recognized testing authority for HVI. Testing was done in accordance with AMCA Standard 210-85 and HVI 915 Test Procedures. Performance graphs show air flow vs. static pressure.

Use of HP Series fans in low resistance applications such as bathroom venting will result in elevated sound levels. We suggest FR Series or other Fantech fans for such applications.

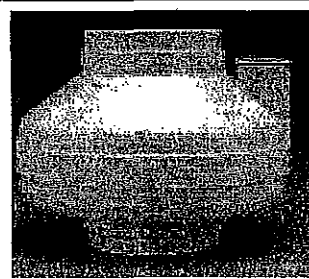

HP FEATURES INCLUDE:

- Improved UV resistant housings approved for commercial applications.
- UL Approved for Wet Locations (Outdoors)
- Sealed housings and wiring boxes to prevent Radon leakage or water penetration
- Energy efficient permanent split capacitor motors
- External wiring box



HP2133 and 2190 Radon Mitigation Fans

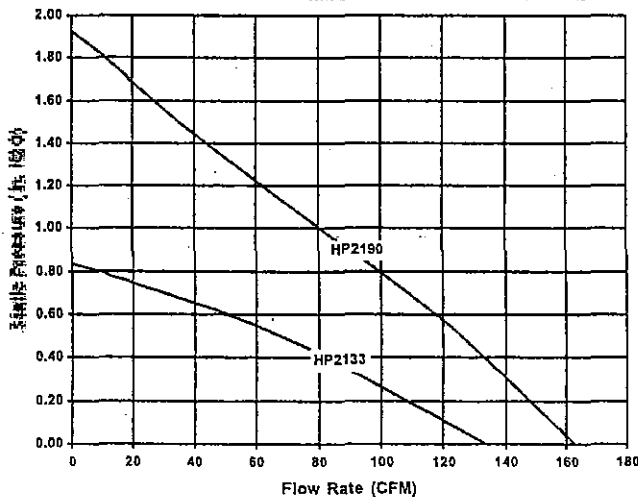

Tested with 4" ID duct and standard couplings.

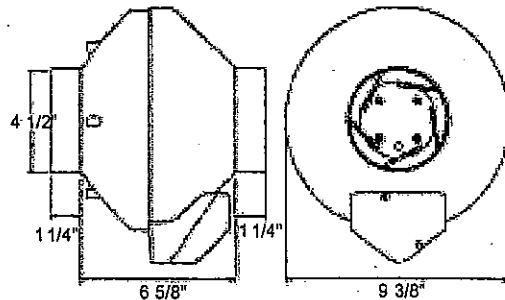

HP2133 – For applications where lower pressure and flow are needed. Record low power consumption of 14-20 watts! Often used where there is good sub slab communication and lower Radon levels.

HP2190 – Performance like the HP190 but in a smaller housing. Performance suitable for the majority of installations.

Fans are attached to PVC pipe using flexible couplings. For 4" PVC pipe use Indiana Seals #156-44, Pipeconx PCX 56-44 or equivalent. For 3" PVC pipe use Indiana Seals #156-43, Pipeconx PCX 56-43 or equivalent.

HP175 and HP190 Radon Mitigation Fans

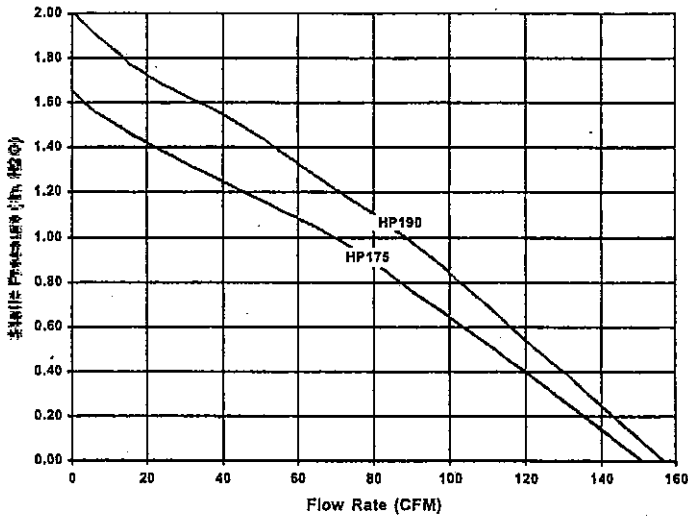

Tested with 4" ID duct and standard couplings.

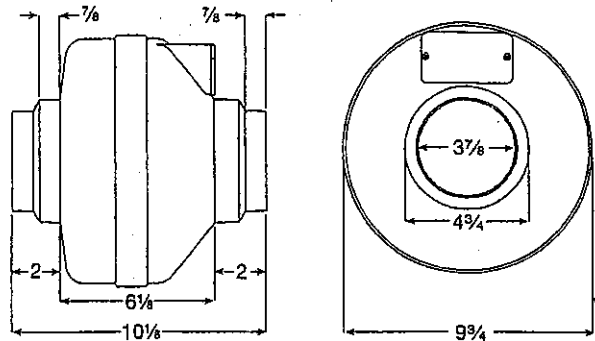
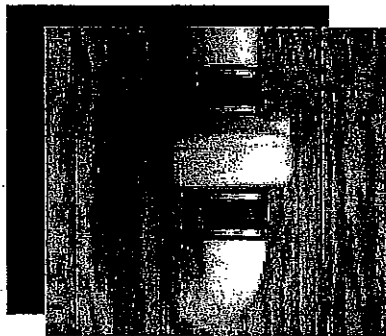

HP175 – The economical choice where slightly less air flow is needed. Often used where there is good sub slab communication and lower Radon levels.

HP190 – *The standard for Radon Mitigation.* Ideally tailored performance curve for a vast majority of your mitigations.

Fans are attached to PVC pipe using flexible couplings.
 For 4" PVC pipe use Indiana Seals #151-44, Pipeconx PCX 51-44 or equivalent.
 For 3" PVC pipe use Indiana Seals #156-43, Pipeconx PCX 56-43 or equivalent.

HP220 Radon Mitigation Fan

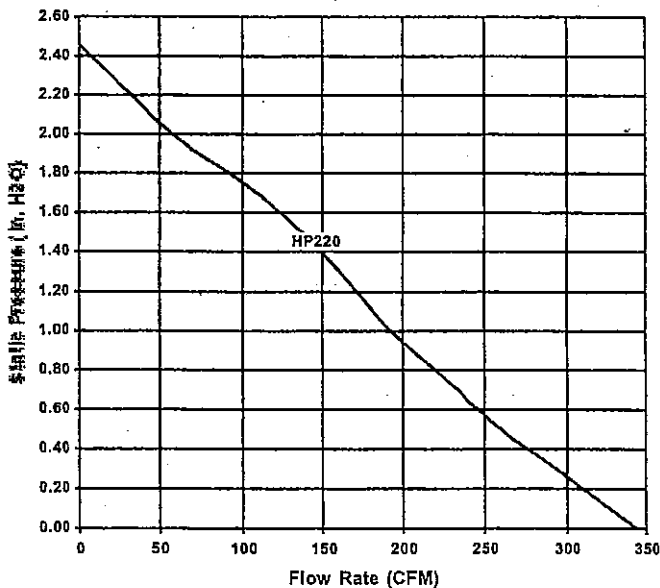

Tested with 6" ID duct and standard couplings.

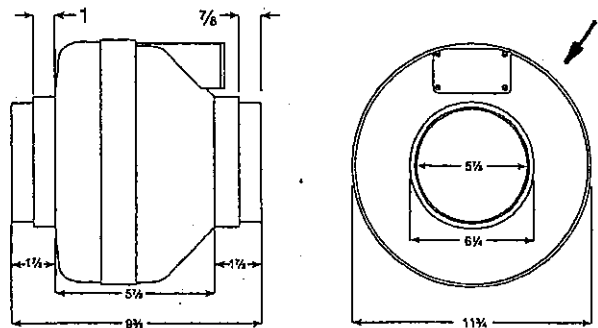

HP 220 – Excellent choice for systems with elevated radon levels, poor communication, multiple suction points and large subslab footprint. Replaces FR 175.

Fans are attached to PVC pipe using flexible couplings.
 For 4" PVC pipe use Indiana Seals #156-64, Pipeconx PCX 56-64 or equivalent.
 For 3" PVC pipe use Indiana Seals #156-63, Pipeconx PCX 56-63 or equivalent.



GPx01 Series

Designed specially for radon mitigation, GPx01 Series Fans provide a wide range of performance that makes them ideal for most subslab radon mitigation systems. Choice of model is dependant on certain building characteristics and should be made by a radon professional.



Feel free to contact us at support@radonaway.com

[View Fan Chart](#)
[Download Fan Installation Instructions \(MS-Word Format\)](#)

Click Here to go back to **PRODUCT SPECIFICATIONS** for more fan models and information or see below for detailed info about this model.

[newsletter library](#)
[fan replacement guide](#)
[epa zone map](#)
[credit application](#)

Homeowner Referral Service
 Find a Radon Professional

The following chart shows performance of **GPx01 Series** fans:

Model	*Watts	Maximum Pressure	Typical CFM vs Static Pressure WC"						
			1.0"	1.5"	2.0"	2.5"	3.0"	3.5"	4.0"
GP201	40-60	2.0" WC	82	58	5	-	-	-	-
GP301	55-90	2.6" WC	92	77	45	10	-	-	-
GP401	60-110	3.4" WC	93	82	60	40	15	-	-
→ GP501	70-140	4.2" WC	95	87	80	70	57	30	10

*Typical monthly electric cost \$2.00 - \$6.00 depending on model, electric rates & operating conditions.

- 5 - Year Warranty.
- Mounts on duct pipe or with integral flange.
- 3" diameter ducts for use with 3" or 4" Pipe.
- Rugged .125" noryl plastic housing.
- Electrical box for hard wire or plug in.
- ETL Safety Agency Listed - tested to UL Standard 507 for indoor or outdoor use. Meets all electrical code requirements.

HS SERIES INSTALLATION INSTRUCTIONS

BY

RadonAway™

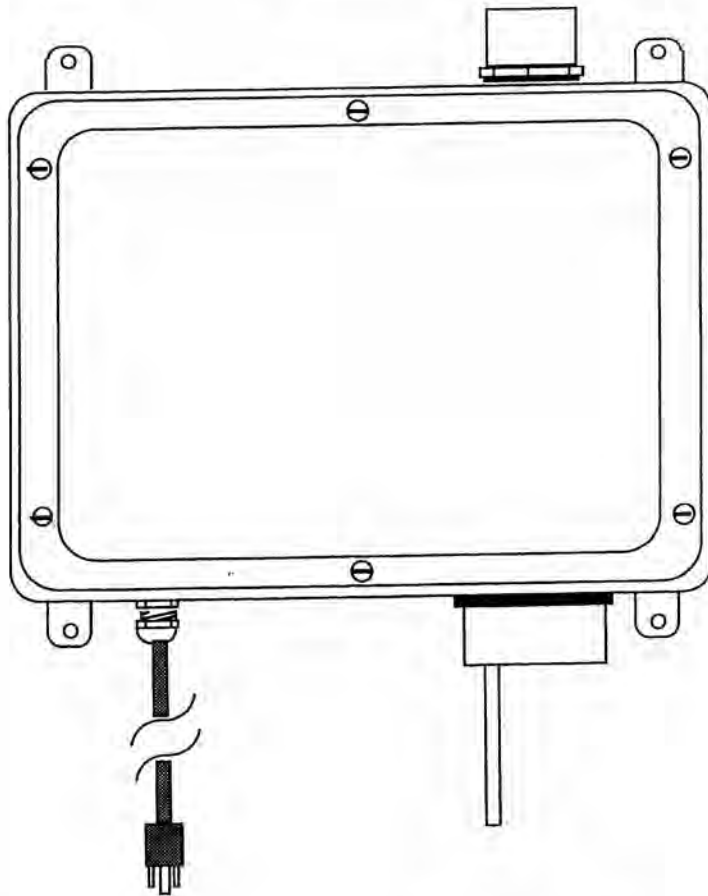
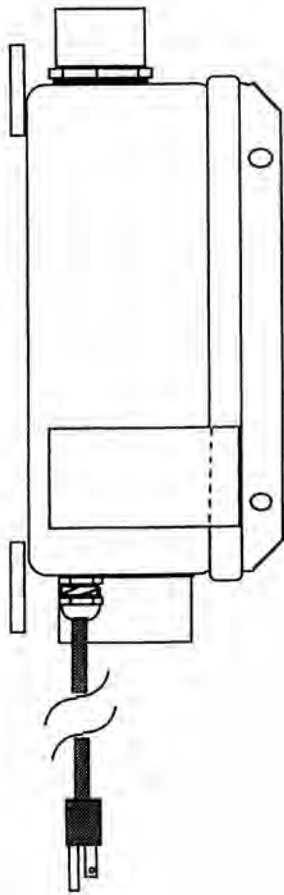

RadonAway, Inc. Ward Hill, MA.

P/N IN007 Rev F



RadonAway Ward Hill, MA.

HS Series Fan Installation Instructions

Please Read and Save These Instructions.

DO NOT CONNECT POWER SUPPLY UNTIL FAN IS COMPLETELY INSTALLED. MAKE SURE ELECTRICAL SERVICE TO FAN IS LOCKED IN "OFF" POSITION. DISCONNECT POWER BEFORE SERVICING FAN.

1. **WARNING!** Do not use fan in hazardous environments where fan electrical system could provide ignition to combustible or flammable materials.
2. **WARNING!** Do not use fan to pump explosive or corrosive gases.
3. **WARNING!** Check voltage at the fan to insure it corresponds with nameplate.
4. **WARNING!** Normal operation of this device may affect the combustion airflow needed for safe operation of fuel burning equipment. Check for possible backdraft conditions on all combustion devices after installation.
5. **NOTICE!** There are no user serviceable parts located inside the fan unit. **Do NOT attempt to open.** Return unit to the factory for service.
6. All wiring must be performed in accordance with the National Fire Protection Association's (NFPA) National Electrical Code, Standard #70"-current edition for all commercial and industrial work, and state and local building codes. All wiring must be performed by a qualified and licensed electrician..
7. **WARNING!** In the event that the fan is immersed in water, return unit to factory for service before operating.
8. **WARNING!** Do not twist or torque fan inlet or outlet piping as Leakage may result.
9. **WARNING!** Do not leave fan unit installed on system piping without electrical power for more than 48 hours. Fan failure could result from this non-operational storage.

INSTALLATION INSTRUCTIONS (Rev F)
for DynaVac High Suction Series
HS2000 p/n 23004-1
HS3000 p/n 23004-2
HS5000 p/n 23004-3

1.0 SYSTEM DESIGN CONSIDERATIONS

1.1 INTRODUCTION

The DynaVac is intended for use by trained, professional Radon mitigators. The purpose of this instruction is to provide additional guidance for the most effective use of the DynaVac. This instruction should be considered as a supplement to EPA standard practices, state and local building codes and state regulations. In the event of a conflict, those codes, practices and regulations take precedence over this instruction.

1.2 ENVIRONMENTALS

The DynaVac is designed to perform year-round in all but the harshest climates without additional concern for temperature or weather. For installations in an area of severe cold weather, please contact RadonAway for assistance. When not in operation, the DynaVac should be stored in an area where the temperature is never less than 32 degrees F. or more than 100 degrees F. The DynaVac is thermally protected such that it will shut off when the internal temperature is above 104 degrees F. Thus if the DynaVac is idle in an area where the ambient temperature exceeds this shut off, it will not restart until the internal temperature falls below 104 degrees F.

1.3 ACOUSTICS

The DynaVac, when installed properly, operates with little or no noticeable noise to the building occupants. There are, however, some considerations to be taken into account in the system design and installation. When installing the DynaVac above sleeping areas, select a location for mounting which is as far away as possible from those areas. Avoid mounting near doors, fold-down stairs or other uninsulated structures which may transmit sound. Insure a solid mounting for the DynaVac to avoid structure-borne vibration or noise.

The velocity of the outgoing air must also be considered in the overall system design. With small diameter piping, the "rushing" sound of the outlet air can be disturbing. The system design should incorporate a means to slow and quiet the outlet air. The use of the RadonAway Exhaust Muffler, p/n 24001, is strongly recommended.

1.4 GROUND WATER

Under no circumstances should water be allowed to be drawn into the inlet of the DynaVac as this may result in damage to the unit. The DynaVac should be mounted at least 5 feet above the slab penetration to minimize the risk of filling the DynaVac with water in installations with occasional high water tables.

In the event that a temporary high water table results in water at or above slab level, water will be drawn into the riser pipes thus blocking air flow to the DynaVac. The lack of cooling air will result in the DynaVac cycling on and off as the internal temperature rises above the thermal cutoff and falls upon shutoff. Should this condition arise, it is recommended that the DynaVac be disconnected until the water recedes allowing for return to normal operation.

1.5 CONDENSATION & DRAINAGE

(WARNING! : Failure to provide adequate drainage for condensation can result in system failure and damage the DynaVac).

Condensation is formed in the piping of a mitigation system when the air in the piping is chilled below its dew point. This can occur at points where the system piping goes through unheated space such as an attic, garage or outside. The system design must provide a means for water to drain back to a slab hole to remove the condensation.

The use of small diameter piping in a system increases the speed at which the air moves. The speed of the air can pull water uphill and at sufficient velocity it can actually move water vertically up the side walls of the pipe. This has the potential of creating a problem in the negative pressure (inlet) side piping. For DynaVac inlet piping, the following table provides the minimum recommended pipe diameters as well as minimum pitch under several system condition. Use this chart to size piping for a system.

Pipe Diam.	Minimum Rise per Foot of Run*		
	@ 25 CFM	@ 50 CFM	@ 100 CFM
4"	1/32 "	3/32 "	3/8 "
3"	1/8 "	3/8 "	1 1/2 "

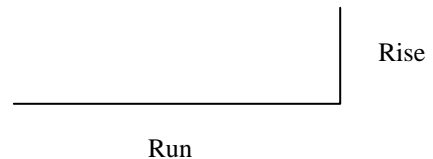

*Typical operational flow rates:

HS3000, or HS5000	20 - 40 CFM
HS2000	50 - 90 CFM

All exhaust piping should be 2" PVC.

1.6 "SYSTEM ON" INDICATOR

A properly designed system should incorporate a "System On" Indicator for affirmation of system operation. A Magnehelic pressure gauge is recommended for this purpose. The indicator should be mounted at least 5 feet above the slab penetration to minimize the risk of filling the gauge with water in installations with occasional high water tables.

1.7 SLAB COVERAGE

The DynaVac can provide coverage of well over 1000 sq. ft. per slab penetration. This will, of course, depend on the sub-slab aggregate in any particular installation and the diagnostic results. In general, sand and gravel are much looser aggregates than dirt and clay. Additional suction points can be added as required. It is recommended that a small pit (2 to 10 gallons in size) be created below the slab at each suction hole.

1.8 ELECTRICAL WIRING

The DynaVac plugs into a standard 120V outlet. All wiring must be performed in accordance with the National Fire Protection Association's (NFPA) "National Electrical Code, Standard #70"-current edition for all commercial and industrial work, and state and local building codes. All wiring must be performed by a qualified and licensed electrician.

1.8a ELECTRICAL BOX (optional)

The optional Electrical Box (p/n 20003) provides a weathertight box with switch for outdoor hardwire connection. All wiring must be performed in accordance with the National Fire Protection Association's (NFPA) "National Electrical Code, Standard #70"-current edition for all commercial and industrial work, and state and local building codes. All wiring must be performed by a qualified and licensed electrician. Outdoor installations require the use of a U.L. listed watertight conduit.

1.9 SPEED CONTROLS

Electronic speed controls can **NOT** be used on HS series units.

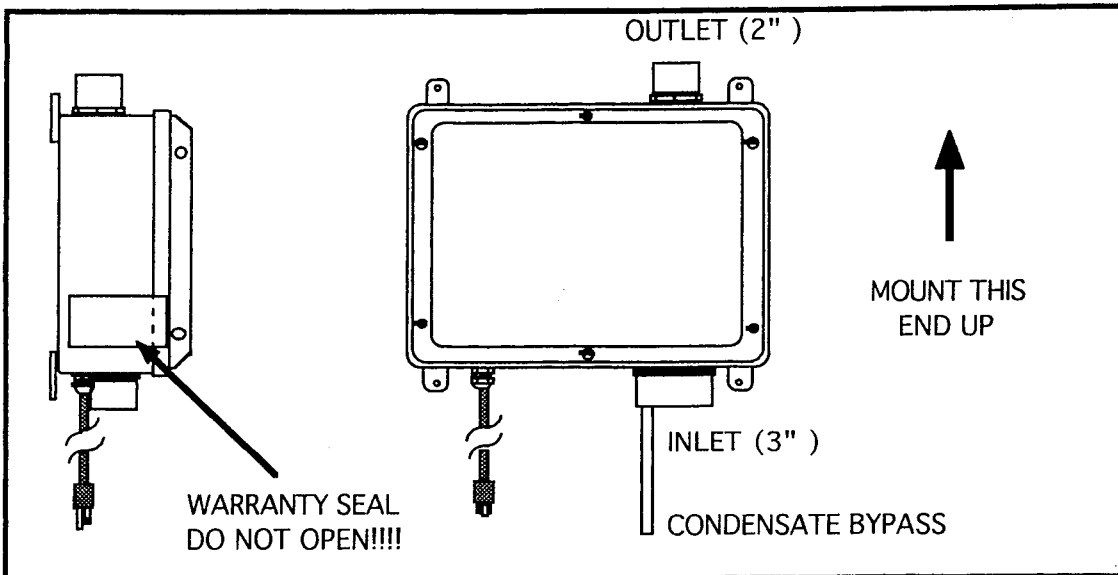

2.0 INSTALLATION

2.1 MOUNTING

Mount the DynaVac to the wall studs, or similar structure, in the selected location with (4) 1/4" x 1 1/2" lag screws (not provided). Insure the DynaVac is both plumb and level.

2.2 DUCTING CONNECTIONS

Make final ducting connection to DynaVac with flexible couplings. Insure all connections are tight. Do not twist or torque inlet and outlet piping on DynaVac or leaks may result.

2.3 VENT MUFLER INSTALLATION

Install the muffler assembly in the selected location in the outlet ducting. Solvent weld all connections. The muffler is normally installed above the roofline at the end of the vent pipe.

2.5 OPERATION CHECKS

___ Make final operation checks by verifying all connections are tight and leak-free.

___ Insure the DynaVac and all ducting is secure and vibration-free.

___ Verify system vacuum pressure with Magnehelic. Insure vacuum pressure is less than the maximum recommended as shown below:

DynaVac	HS2000	14" WC
DynaVac	HS3000	21" WC
DynaVac	HS5000	40" WC

(Above are based on sea-level operation, at higher altitudes reduce above by about 4% per 1000 Feet.)

If these are exceeded, increase number of suction points.

___ Verify Radon levels by testing to EPA protocol.

Addendum

PRODUCT SPECIFICATIONS

Model	Maximum Static Suction	Typical CFM vs Static Suction WC (Recommended Operating Range)						Power* Watts @ 115 VAC
		0"	10"	15"	20"	25"	35"	
HS2000	18"	110	72	40	-	-	-	150-270
HS3000	27"	40	33	30	23	18	-	105-195
HS5000	50"	53	47	42	38	34	24	180-320

*Power consumption varies with actual load conditions

Inlet: 3.0" PVC

Outlet: 2.0" PVC

Mounting: Brackets for vertical mount

Weight: Approximately 18 lbs.

Size: Approximately 15"W x 13"H x 8"D

Minimum recommended inlet ducting (greater diameter may always be used):

HS3000, HS5000 --- 2.0" PVC Pipe

HS2000 --- Main feeder line of 3.0" or greater PVC Pipe

Branch lines (if 3 or more) may be 2.0" PVC Pipe

Outlet ducting: 2.0" PVC

Storage temperature range: 32 - 100 degrees F.

Thermally protected

Locked rotor protection

Internal Condensate Bypass

IMPORTANT INSTRUCTIONS TO INSTALLER

Inspect the HS Series Fan for shipping damage within 15 days of receipt. Notify **RadonAway of any damages immediately**. Radonaway is not responsible for damages incurred during shipping. However, for your benefit, Radonaway does insure shipments.

There are no user serviceable parts inside the fan. **Do not attempt to open**. Return unit to factory for service.

Install the HS Series Fan in accordance with all EPA standard practices, and state and local building codes and state regulations.

WARRANTY

Subject to any applicable consumer protection legislation, RadonAway warrants that the HS Series Fan (the "Fan") will be free from defects in materials and workmanship for a period of one (1) year from the date of manufacture (the "Warranty Term"). Outside the Continental United States and Canada the Warranty Term is one (1) year from the date of manufacture.

RadonAway will replace any Fan which fails due to defects in materials or workmanship. The Fan must be returned (at owner's cost) to the RadonAway factory. Proof of purchase must be supplied upon request for service under this Warranty.

This Warranty is contingent on installation of the Fan in accordance with the instructions provided. This Warranty does not apply where any repairs or alterations have been made or attempted by others, or if the unit has been abused or misused. Warranty does not include damage in shipment unless the damage is due to the negligence of RadonAway.

RadonAway is not responsible for installation, removal or delivery costs associated with this Warranty.

EXCEPT AS STATED ABOVE, THE HS SERIES FANS ARE PROVIDED WITHOUT WARRANTY OF ANY KIND, EITHER EXPRESS OR IMPLIED, INCLUDING, WITHOUT LIMITATION, IMPLIED WARRANTIES OF MERCHANTABILITY AND FITNESS FOR A PARTICULAR PURPOSE.

IN NO EVENT SHALL RADONAWAY BE LIABLE FOR ANY DIRECT, INDIRECT, SPECIAL, INCIDENTAL, OR CONSEQUENTIAL DAMAGES ARISING OUT OF, OR RELATING TO, THE FAN OR THE PERFORMANCE THEREOF. RADONAWAY'S AGGREGATE LIABILITY HEREUNDER SHALL NOT IN ANY EVENT EXCEED THE AMOUNT OF THE PURCHASE PRICE OF SAID PRODUCT. THE SOLE AND EXCLUSIVE REMEDY UNDER THIS WARRANTY SHALL BE THE REPAIR OR REPLACEMENT OF THE PRODUCT, TO THE EXTENT THE SAME DOES NOT MEET WITH RADONAWAY'S WARRANTY AS PROVIDED ABOVE.

For service under this Warranty, contact RadonAway for a Return Material Authorization (RMA) number and shipping information. No returns can be accepted without an RMA. If factory return is required, the customer assumes all shipping cost to and from factory.

RadonAway
3 Saber Way
Ward Hill, MA 01835
TEL. (978) 521-3703
FAX (978) 521-3964

Record the following information for your records:

Serial No. _____
Purchase Date _____

MATERIAL SAFETY DATA SHEET



Date Issued: 08/03/2007
MSDS No: 68101
Date Revised: 11/12/2007
Revision No: 1

3300 Colors

1. PRODUCT AND COMPANY IDENTIFICATION

PRODUCT NAME: 3300 Colors

MANUFACTURER

Geocel Corporation
P.O. Box 398
Elkhart IN 46515-0398
Product Stewardship: 574-264-0645

24 HR. EMERGENCY TELEPHONE NUMBERS

ChemTel - 800-255-3924

2. HAZARDS IDENTIFICATION

EMERGENCY OVERVIEW

IMMEDIATE CONCERNS: This product contains materials that on exposure could cause irritation and minor residual injury even if no treatment is provided. This product is stable under normal conditions but will react slightly with water to release some heat and carbon dioxide. The reaction is not violent.

POTENTIAL HEALTH EFFECTS

EYES: May cause irritation with temporary redness and stinging and tearing.

SKIN: Skin contact may cause irritation. A component of this product is a potential skin sensitizer. Repeated skin contact may cause a persistent irritation or dermatitis.

INGESTION: Exposure is unlikely. This product can cause gastrointestinal irritation, nausea, vomiting, and diarrhea.

INHALATION: Vapors and mists from this product are respiratory irritants. Repeated inhalation may result in lung damage. Symptoms may include irritation to the eyes, nose, throat, and lungs, possibly combined with dryness of the throat, tightness of the chest, and difficulty in breathing.

TARGET ORGAN STATEMENT: The lungs may be targeted and damaged by components of the product. Skin. Eyes.

3. COMPOSITION / INFORMATION ON INGREDIENTS

Chemical Name	Wt.%	CAS	EINECS
Methylene Bisphenyl Isocyanate	0.1 - 1	000101-68-8	202-966-0
Xylenes (o-,m-,p- Isomers)	< 4	001330-20-7	215-535-7

4. FIRST AID MEASURES

EYES: Immediately flush with plenty of water for at least 15 minutes, holding eyelids open at all times. Get medical attention immediately. See Notes to Physician.

SKIN: Wash immediately with soap and water. If irritation persists, get medical attention. See Notes to Physician.

INGESTION: No harmful effect is anticipated. If ingested, get immediate medical attention. Do not induce vomiting unless instructed to do so by medical personnel. Never give anything by mouth to a victim who is unconscious or is having convulsions.

INHALATION: Remove to fresh air. Get medical attention if symptoms develop. Asthmatic-type symptoms may develop and may be immediate or delayed for up to several hours.

NOTES TO PHYSICIAN: A component of this product is a potential skin sensitizer. Treat symptomatically as for contact dermatitis. Persons with hypersensitivities to isocyanates should be removed from exposure to any isocyanates. May aggravate existing heart conditions, particularly those with abnormal heart rhythms.

5. FIRE FIGHTING MEASURES

FLASHPOINT AND METHOD: 74°C (166°F)

FLAMMABLE LIMITS: 1% to 7%

AUTOIGNITION TEMPERATURE: 496°C (924°F)

EXTINGUISHING MEDIA: Chemical type foam, CO₂ (Carbon Dioxide), Dry Chemical, Water Fog

EXPLOSION HAZARDS: Not known.

FIRE FIGHTING EQUIPMENT: Firefighters should wear full protective clothing including self contained breathing apparatus.

SENSITIVE TO STATIC DISCHARGE: Not known.

SENSITIVITY TO IMPACT: Not known.

6. ACCIDENTAL RELEASE MEASURES

SMALL SPILL: Wearing the personal protective equipment designated in Section 8, transfer material to appropriate container for disposal.

LARGE SPILL: Wearing the personal protective equipment designated in Section 8, carefully contain the spill and transfer it to the appropriate container for disposal. Ventilate well while cleanup is in process and until fumes dissipate.

ENVIRONMENTAL PRECAUTIONS

WATER SPILL: Isolate spill area. Stop discharge if safe to do so. Stop material from entering sewers or water streams. Scrape up polyurethane and deposit into appropriate containers.

LAND SPILL: Isolate spill area. Stop discharge if safe to do so. Stop material from contaminating soil. Scrape up polyurethane and deposit into appropriate containers.

7. HANDLING AND STORAGE

HANDLING: Avoid contact with skin and eyes. Wash thoroughly after handling. Use this product with adequate ventilation.

STORAGE: Keep the container tightly closed and in a cool, well-ventilated place.

COMMENTS: Attention! Follow label warnings even after container is emptied since empty containers may retain product residues. Do not reuse empty container for food, clothing, or products for human or animal consumption, or where skin contact can occur.

8. EXPOSURE CONTROLS / PERSONAL PROTECTION

EXPOSURE GUIDELINES

OSHA HAZARDOUS COMPONENTS (29 CFR1910.1200)					
		EXPOSURE LIMITS			
		OSHA PEL		ACGIH TLV	
Chemical Name		ppm	mg/m ³	ppm	mg/m ³
Methylene Bisphenyl Isocyanate	TWA	.02	0.2	0.005	0.051
Xylenes (o-,m-,p- Isomers)	TWA	100	435	100	434
	STEL			150	651

ENGINEERING CONTROLS: Use in well-ventilated area.

PERSONAL PROTECTIVE EQUIPMENT

EYES AND FACE: Wear safety glasses with side shields or goggles when handling this material.

SKIN: Wear appropriate clothing to minimize skin contact with this product.

RESPIRATORY: Not required with adequate ventilation.

COMMENTS: Wash hands thoroughly after each use, especially before eating or smoking. Good personal hygiene practices should always be followed.

9. PHYSICAL AND CHEMICAL PROPERTIES

PHYSICAL STATE: Paste

ODOR: Solvent

pH: Not Applicable

PERCENT VOLATILE: <4%

VAPOR PRESSURE: 5.1

VAPOR DENSITY: 3.7

FLASHPOINT AND METHOD: 74°C (166°F)

SOLUBILITY IN WATER: 0%

DENSITY: 11.08

(VOC): 52.400 g/l

10. STABILITY AND REACTIVITY

STABLE: Yes

HAZARDOUS POLYMERIZATION: No

CONDITIONS TO AVOID: Avoid contact with strong oxidizers and strong acids.

HAZARDOUS DECOMPOSITION PRODUCTS: If product is burned, carbon monoxide, carbon dioxide, oxides of nitrogen, amines, isocyanate-containing compounds and other unknown products may be produced.

11. TOXICOLOGICAL INFORMATION

EYE EFFECTS: Irritating to the eyes.

SKIN EFFECTS: Irritating to the skin.

CARCINOGENICITY

Notes: This product contains Methylene Diphenyl Isocyanate (MDI). MDI is not listed by the NTP, IARC or regulated by OSHA as a carcinogen.

12. ECOLOGICAL INFORMATION

ECOTOXICOLOGICAL INFORMATION: Organic solvents produce slight to moderate toxicity to aquatic life. Insufficient data exists to evaluate the effect on plants, birds or land animals.

13. DISPOSAL CONSIDERATIONS

DISPOSAL METHOD: Chemical waste generators must determine whether a discarded chemical is classified as a hazardous waste. US EPA guidelines for the classification determination are listed in 40 CFR Part 261.3. Additionally, waste generators must consult state and local hazardous waste regulations to ensure complete and accurate classification.

14. TRANSPORT INFORMATION

DOT (DEPARTMENT OF TRANSPORTATION)

OTHER SHIPPING INFORMATION: Generators must consult DOT laws and regulations to ensure the product is being transported appropriately.

COMMENTS: Not regulated as dangerous goods.

15. REGULATORY INFORMATION

UNITED STATES

SARA TITLE III (SUPERFUND AMENDMENTS AND REAUTHORIZATION ACT)

311/312 HAZARD CATEGORIES: This product poses the following physical and health hazard(s) as defined in 40

CFR Part 370 and is subject to the requirements of sections 311 and 312 of Title III of the Superfund Amendments and Reauthorization Act of 1986:

FIRE: No **PRESSURE GENERATING:** No **REACTIVITY:** No **ACUTE:** Yes **CHRONIC:** Yes

313 REPORTABLE INGREDIENTS: This product contains the following toxic chemicals subject to the reporting requirements of Section 313 of the Emergency Planning and Community Right-To-Know Act of 1986 and 40 CFR 372. CAS #: 101-68-8 MDI and CAS #: 1330-20-7 Xylene

EPCRA SECTION 313 SUPPLIER NOTIFICATION

Chemical Name	Wt. %	CAS
Xylenes (o-,m-,p- Isomers)	< 4	001330-20-7

CERCLA (COMPREHENSIVE RESPONSE, COMPENSATION, AND LIABILITY ACT)

Chemical Name	Wt. %	CERCLA RQ
Methylene Bisphenyl Isocyanate	0.1 - 1	5,000
Xylenes (o-,m-,p- Isomers)	< 4	100

TSCA (TOXIC SUBSTANCE CONTROL ACT)

Chemical Name	CAS
Methylene Bisphenyl Isocyanate	000101-68-8
Xylenes (o-,m-,p- Isomers)	001330-20-7

CALIFORNIA PROPOSITION 65: This product does not contain any chemicals on California's Proposition 65 List.

16. OTHER INFORMATION

PREPARED BY: Technical Staff

REVISION SUMMARY: Revision #: 1 This MSDS replaces the MSDS. Any changes in information are as follows: In Section 14 Comments

NFPA STORAGE CLASSIFICATION: Health 2, Flammability 2, Physical Hazard 0

HMIS RATINGS NOTES: Health 2, Flammability 2, Physical Hazard 0, PPE B

*Completed System
Inspection Forms*



System Inspection Field Form

STRUCTURE INSPECTION

Routine or Non-Routine (circle one)

Address: 1-5 HOLLAND AVE

Structure ID #: —

Performed by: EA/LR

Date: 1/23-1/24/14

Have the following items changed since the last visit?

	Yes	No
Building Foot Print		X
Basement/Slab Occupancy	X	
Heating / Ventilating Systems	X	
Basement Finish		X
Crawlspaces		X
Drains, Sumps, Floor Cracks		X
Wall Penetrations, Cracks		X
Appliances (in basement)		X
Siding		X
Are there any new buildings on the property or conversion of spaces in previously existing building?	X	
Ownership	X	

If Yes, describe in comments section below.

If Yes, write new owner name contact information below

Date of Ownership Change _____

Owner Name _____

Telephone No. _____

If any of these items have changed, a redesign may be required. Contact the maintenance supervisor for field review.

Documentation

- Were digital photographs taken of the entire system? Yes No
- Was Property Owner provided "Operational Fact Sheet"? Yes No No - has already been provided
- Was the drawing updated to show any changes? Yes No N/A
- Was a Service Call filed for items that could not be addressed during this visit? Yes No N/A

Comments

BUILDING OWNERSHIP HAS CHANGED. THE BUILDING HAS BEEN CONVERTED TO SELF STORAGE + STORAGE UNITS
HAVE BEEN BUILT ON BOTH LEVELS. HEATING/VENTILATING SYSTEMS HAVE BEEN UPDATED; HOWEVER, THEY
WERE NOT IN OPERATION DURING THIS INSPECTION.
CTP 7-1 READING WAS 0.024" W.C.



System Inspection Field Form

FAN AND ELECTRICAL

(Routine or Non-Routine (circle one))

Address: 1-5 HOLLAND AVE

Structure ID #: -

Performed by: EA/ER

Date: 1/23-1/24/14

Equipment Documentation

Manometer Reading at Fan Inlet (" w.c. vacuum)

Table with 10 columns (Fan #, 2A, 3A, 3B, 4A, 4B, etc.) and 4 rows (Fan Model, Manometer Reading (Prior Commissioned), Manometer Reading (As Found), Manometer Reading (As Left)).

Manometer Reading at Sub-Slab SSPs (" w.c. vacuum)

Note: For SSPs located in accessible crawlspaces with EPDM membrane, use the crawlspace field form to record the SSP manometer reading.

Table with 11 columns (SSP #, 2A-A, 2A-B, 3A-A, 3A-B, 3B-A, 3B-B, 4B-A, 4B-B, 4A-A, 4A-B, 4B-C) and 4 rows (Manometer Reading (Prior Commissioned), Manometer Reading (As Found), Meet Criteria?*, Manometer Reading (As Left)).

STORAGE UNIT NUMBER Fan System Inspection

- Is fan cover still present?
Each fan mounted securely?
Coupling connections secure?
Is excessive noise heard when fan is running?
Switch is locked in the ON position?
Is set point indicated on speed controller?
Has fan been in continuous operation since previous visit?
Is the pipe penetration sealed on the structure's exterior?
Is the downspout/PVC junction sufficiently sealed?
Is conduit penetration sealed on the structure's exterior?
Each fan runs when switch is ON position?
Each fan stops when switch is in OFF position?
Does the condensate line appear to be functioning correctly?
Is each fan below its maximum vacuum?

(HP220 = 2.5" w.c., GP501 = 4.25" w.c., FR-250 = 2.6" w.c., HS-5000 = 53" w.c.)
If fan vacuum is at maximum, measure velocity at each SSP (record below).

Table with 10 columns (SSP #) and 2 rows (Velocity at SSP (As Found), Velocity at SSP (As Left)).

Does the SSP velocity meet criteria (> 1 ft/min)?

Electrical System Inspection

- Are all electrical connections secure?
Each junction box closed?
Conduit/Wire properly supported?
Are audible alarm(s) present and working properly?
Are appliances affected by fan operation?

Labeling Inspection

- Correct labels applied in proper location? ***
Are labels still legible?
Is SSDS breaker identified in the electrical panel?
Commissioned value written on SSP sticker?

Comments/Corrective Action

FAN COVER 4B IS CRACKED AND SHOULD BE REPLACED.

* ALARMS HAVE BEEN INSTALLED, BUT ELECTRICIAN WAS INSTALLING OUTLETS FOR ALARMS DURING INSPECTION. OUTLET INSTALLATION WAS NOT COMPLETED BY END OF INSPECTION. ELECTRICIAN WAS TO PLUG ALARMS IN WHEN OUTLET INSTALLATION WAS COMPLETE.

* As Found conditions = before corrective action. [NA = Not Applicable]

* As Left conditions = after corrective action. [UC = Unchanged from As Found conditions]

** Criteria is met if deviation is less than or equal to 0.25"wc (for all fans with the exception of the HS-5000). For an HS-5000 fan, criteria is met if deviation is less than or equal to 10% of the prior commissioned value or less than or equal to 0.25"wc, whichever is greater.

*** Correct labels are at least one green label per floor and one white sticker at every suction point.

System Inspection Field Form
PIPING, SLAB AND WALL
Routine or Non-Routine (circle one)

 Address: 1-5 HOLLAND AVE

 Structure ID #: -

 Performed by: EA/LR

 Date: 1/23 - 1/24/14
Piping Check

	<input checked="" type="checkbox"/> Yes	<input type="checkbox"/> No	As Found	<input type="checkbox"/> Yes	<input type="checkbox"/> No	As Left	<input checked="" type="checkbox"/> UC
System suction point seals are accessible? <u>ALL BUT 2A-A+2AB</u>	<input checked="" type="checkbox"/>	<input type="checkbox"/>	<input type="checkbox"/> No	<input type="checkbox"/>	<input type="checkbox"/>	<input type="checkbox"/>	<input checked="" type="checkbox"/>
System suction points are sealed to the slab? <u>WHERE VISIBLE</u>	<input checked="" type="checkbox"/>	<input type="checkbox"/>	<input type="checkbox"/> No	<input type="checkbox"/>	<input type="checkbox"/>	<input type="checkbox"/>	<input checked="" type="checkbox"/>
Each component is installed?	<input checked="" type="checkbox"/>	<input type="checkbox"/>	<input type="checkbox"/> No	<input type="checkbox"/>	<input type="checkbox"/>	<input type="checkbox"/>	<input checked="" type="checkbox"/>
Piping system is properly supported (6'-horizontal/8'-vertical)	<input checked="" type="checkbox"/>	<input type="checkbox"/>	<input type="checkbox"/> No	<input type="checkbox"/>	<input type="checkbox"/>	<input type="checkbox"/>	<input checked="" type="checkbox"/>
Excessive noise is heard in piping joints?	<input type="checkbox"/>	<input checked="" type="checkbox"/>	<input checked="" type="checkbox"/> No	<input type="checkbox"/>	<input type="checkbox"/>	<input type="checkbox"/>	<input checked="" type="checkbox"/>
Smoke 10% of all pipe joints and/or piping modifications?	<input checked="" type="checkbox"/>	<input type="checkbox"/>	<input type="checkbox"/> No	<input type="checkbox"/>	<input type="checkbox"/>	<input type="checkbox"/>	<input checked="" type="checkbox"/>
Did smoke enter joints? **	<input type="checkbox"/>	<input checked="" type="checkbox"/>	<input checked="" type="checkbox"/> No	<input type="checkbox"/>	<input type="checkbox"/>	<input type="checkbox"/>	<input checked="" type="checkbox"/>

Floor Check

Are areas of the slab not visible (e.g. floor covering)?	<input checked="" type="checkbox"/>	<input type="checkbox"/>	<input type="checkbox"/> No	<input type="checkbox"/>	<input type="checkbox"/>	<input type="checkbox"/>	<input checked="" type="checkbox"/>
Are areas of the slab not accessible (e.g. stored items)?	<input checked="" type="checkbox"/>	<input type="checkbox"/>	<input type="checkbox"/> No	<input type="checkbox"/>	<input type="checkbox"/>	<input type="checkbox"/>	<input checked="" type="checkbox"/>
Were drawing-identified slab crack repairs/modifications smoke tested?	<input type="checkbox"/>	<input type="checkbox"/>	<input type="checkbox"/> No	<input checked="" type="checkbox"/>	<input type="checkbox"/>	<input type="checkbox"/>	<input checked="" type="checkbox"/>
Did smoke enter? **	<input type="checkbox"/>	<input type="checkbox"/>	<input type="checkbox"/> No	<input checked="" type="checkbox"/>	<input type="checkbox"/>	<input type="checkbox"/>	<input checked="" type="checkbox"/>
Are other cracks present that did not draw smoke?	<input checked="" type="checkbox"/>	<input type="checkbox"/>	<input type="checkbox"/> No	<input type="checkbox"/>	<input type="checkbox"/>	<input type="checkbox"/>	<input checked="" type="checkbox"/>
Are other cracks present that did draw smoke? **	<input type="checkbox"/>	<input checked="" type="checkbox"/>	<input checked="" type="checkbox"/> No	<input type="checkbox"/>	<input type="checkbox"/>	<input type="checkbox"/>	<input checked="" type="checkbox"/>
Were newly identified slab cracks indicated on drawing?	<input type="checkbox"/>	<input type="checkbox"/>	<input type="checkbox"/> No	<input checked="" type="checkbox"/>	<input type="checkbox"/>	<input type="checkbox"/>	<input checked="" type="checkbox"/>
Check and clean Dranjer(s)?	<input type="checkbox"/>	<input type="checkbox"/>	<input type="checkbox"/> No	<input checked="" type="checkbox"/>	<input type="checkbox"/>	<input type="checkbox"/>	<input checked="" type="checkbox"/>
Smoke Dranjer(s)?	<input type="checkbox"/>	<input type="checkbox"/>	<input type="checkbox"/> No	<input checked="" type="checkbox"/>	<input type="checkbox"/>	<input type="checkbox"/>	<input checked="" type="checkbox"/>

Wall Check

Are areas of the walls not visible (e.g. finished walls)?	<input checked="" type="checkbox"/>	<input type="checkbox"/>	<input type="checkbox"/> No	<input type="checkbox"/>	<input type="checkbox"/>	<input type="checkbox"/>	<input checked="" type="checkbox"/>
Are areas of the walls not accessible (e.g. stored items)?	<input checked="" type="checkbox"/>	<input type="checkbox"/>	<input type="checkbox"/> No	<input type="checkbox"/>	<input type="checkbox"/>	<input type="checkbox"/>	<input checked="" type="checkbox"/>
Were drawing-identified wall crack repairs/modifications smoke tested?	<input type="checkbox"/>	<input type="checkbox"/>	<input type="checkbox"/> No	<input checked="" type="checkbox"/>	<input type="checkbox"/>	<input type="checkbox"/>	<input checked="" type="checkbox"/>
Did smoke enter wall crack(s)? **	<input type="checkbox"/>	<input type="checkbox"/>	<input type="checkbox"/> No	<input checked="" type="checkbox"/>	<input type="checkbox"/>	<input type="checkbox"/>	<input checked="" type="checkbox"/>
Are other wall cracks/penetrations present that did not draw smoke?	<input checked="" type="checkbox"/>	<input type="checkbox"/>	<input type="checkbox"/> No	<input type="checkbox"/>	<input type="checkbox"/>	<input type="checkbox"/>	<input checked="" type="checkbox"/>
Are other wall cracks/penetrations present that did draw smoke? **	<input type="checkbox"/>	<input checked="" type="checkbox"/>	<input checked="" type="checkbox"/> No	<input type="checkbox"/>	<input type="checkbox"/>	<input type="checkbox"/>	<input checked="" type="checkbox"/>
Were newly identified wall cracks indicated on drawing?	<input type="checkbox"/>	<input type="checkbox"/>	<input type="checkbox"/> No	<input checked="" type="checkbox"/>	<input type="checkbox"/>	<input type="checkbox"/>	<input checked="" type="checkbox"/>
Is top course of block wall open?	<input type="checkbox"/>	<input checked="" type="checkbox"/>	<input checked="" type="checkbox"/> No	<input type="checkbox"/>	<input type="checkbox"/>	<input type="checkbox"/>	<input checked="" type="checkbox"/>
Smoke top course of block wall (open-top block only)?	<input type="checkbox"/>	<input type="checkbox"/>	<input type="checkbox"/> No	<input checked="" type="checkbox"/>	<input type="checkbox"/>	<input type="checkbox"/>	<input checked="" type="checkbox"/>
Did smoke enter top course? **	<input type="checkbox"/>	<input type="checkbox"/>	<input type="checkbox"/> No	<input checked="" type="checkbox"/>	<input type="checkbox"/>	<input type="checkbox"/>	<input checked="" type="checkbox"/>
Are utility penetrations sealed so they don't draw smoke?	<input checked="" type="checkbox"/>	<input type="checkbox"/>	<input type="checkbox"/> No	<input type="checkbox"/>	<input type="checkbox"/>	<input type="checkbox"/>	<input checked="" type="checkbox"/>

Sump Check

Have any non-approved modifications been made to sump cover?	<input type="checkbox"/>	<input type="checkbox"/>	<input checked="" type="checkbox"/>	<input type="checkbox"/>	<input type="checkbox"/>	<input type="checkbox"/>	<input checked="" type="checkbox"/>
Is sump cover structurally sound?	<input type="checkbox"/>	<input type="checkbox"/>	<input checked="" type="checkbox"/>	<input type="checkbox"/>	<input type="checkbox"/>	<input type="checkbox"/>	<input checked="" type="checkbox"/>
Verify integrity of sump cover seal?	<input type="checkbox"/>	<input type="checkbox"/>	<input checked="" type="checkbox"/>	<input type="checkbox"/>	<input type="checkbox"/>	<input type="checkbox"/>	<input checked="" type="checkbox"/>
Does sealed sump cover draw smoke? **	<input type="checkbox"/>	<input type="checkbox"/>	<input checked="" type="checkbox"/>	<input type="checkbox"/>	<input type="checkbox"/>	<input type="checkbox"/>	<input checked="" type="checkbox"/>

Exhaust Stack Check

Distance above eave	Commissioned distance: <u>SEE COMMENTS</u>	Criteria: ≥ 1 ft
Distance from nearest opening	Commissioned distance: <u>BELOW ↓</u>	Criteria: ≥ 10 ft
Distance above nearest opening	Commissioned distance: <u>↓</u>	Criteria: ≥ 2 ft
Are vertical exhaust stack supports installed every 8' maximum?	<input checked="" type="checkbox"/> Yes <input type="checkbox"/> No <input type="checkbox"/> NA	<input type="checkbox"/> Yes <input type="checkbox"/> No <input checked="" type="checkbox"/> UC
Distances from stack exhaust to openings appear to be unchanged?	<input checked="" type="checkbox"/> Yes <input type="checkbox"/> No	<input type="checkbox"/> Yes <input type="checkbox"/> No <input checked="" type="checkbox"/> UC

*** If the existing exhaust stack is modified and/or removed and replaced as part of non-routine system maintenance, complete the "Stack Modification Field Form" and attach

Comments

STACKS APPEAR TO BE GREATER THAN 1' ABOVE THE EAVE + 2' ABOVE WINDOWS. STACK 4A APPEARS TO BE TOO CLOSE TO A CHIMNEY OPENING, BUT THAT CHIMNEY MAY BE OUT OF SERVICE.

Notes:

- * As Found conditions = before corrective action. [NA = Not Applicable]
- * As Left conditions = after corrective action. [UC = Unchanged from As Found conditions]
- ** If answered YES to this question, perform corrective action and re-test.



System Inspection Field Form

CRAWLSPACE

Routine or Non-Routine (circle one)

Address: 1-5 HOLLAND AVE

Structure ID #: -

Performed by: EA/LR

Date: 1/23-1/24/14

Inaccessible Crawlspace (Ventilation) [X] NA

Table with 5 columns: As Found*, Crawlspace 1, Crawlspace 2, Crawlspace 3, Crawlspace 4. Rows include SSP#, Target Velocity (fpm), Measured Velocity (fpm), and Meets Criteria? **

Table with 5 columns: As Left*, Crawlspace 1, Crawlspace 2, Crawlspace 3, Crawlspace 4. Rows include SSP#, Target Velocity (fpm), Measured Velocity (fpm), and Meets Criteria? **

Is sampling port to Inaccessible crawl space threaded with a plug? [] Yes [] No [] Yes [] No [] UC

Accessible Crawlspace (Sub-Membrane Depressurization) [X] NA

Table with 5 columns: As Found*, Crawlspace 1, Crawlspace 2, Crawlspace 3, Crawlspace 4. Rows include SSP#, Prior Commissioned Manometer reading (" w.c.), and As found Manometer reading (" w.c.)

Table with 5 columns: As Left*, Crawlspace 1, Crawlspace 2, Crawlspace 3, Crawlspace 4. Row includes Manometer reading (" w.c.)

Accessible Crawlspace Performance Inspection

Was each membrane joint smoke tested? [] Yes [] No [] Yes [] No [] UC
Did smoke enter? *** [] Yes [] No [] Yes [] No [] UC
Was the membrane perimeter smoke tested? [] Yes [] No [] Yes [] No [] UC
Did smoke enter? *** [] Yes [] No [] Yes [] No [] UC
Is the suction point manometer(s) reading <= -1/10" w.c.?**** [] Yes [] No [] Yes [] No [] UC

Comments

Blank lines for handwritten comments.

* As Found conditions = before corrective action. [NA = Not Applicable]
* As Left conditions = after corrective action. [UC = Unchanged from As Found conditions]
** Inaccessible Crawlspace Criteria: Measured velocity >= 90% of Target Velocity (adjust if >110% of target velocity)
*** If answered YES to this question, perform corrective action and re-test.
**** If answered NO to this question, adjust valve accordingly and re-check all SSP and fan readings.



System Inspection Field Form

STRUCTURE INSPECTION

Routine or Non-Routine (circle one)

Address: 1-51 HOLLAND AVE

Structure ID #:

Performed by: EA/GK

Date: 3/27/13

Have the following items changed since the last visit?

	Yes	No
Building Foot Print	_____	<input checked="" type="checkbox"/>
Basement/Slab Occupancy	_____	<input checked="" type="checkbox"/>
Heating / Ventilating Systems	_____	<input checked="" type="checkbox"/>
Basement Finish	_____	<input checked="" type="checkbox"/>
Crawlspaces	_____	<input checked="" type="checkbox"/>
Drains, Sumps, Floor Cracks	_____	<input checked="" type="checkbox"/>
Wall Penetrations, Cracks	_____	<input checked="" type="checkbox"/>
Appliances (in basement)	_____	<input checked="" type="checkbox"/>
Siding	_____	<input checked="" type="checkbox"/>
Are there any new buildings on the property or conversion of spaces in previously existing building?	_____	<input checked="" type="checkbox"/>
<i>If Yes, describe in comments section below.</i>		
Ownership	_____	<input checked="" type="checkbox"/>

If Yes, write new owner name contact information below

Date of Ownership Change _____
 Owner Name _____
 Telephone No. _____

If any of these items have changed, a redesign may be required. Contact the maintenance supervisor for field review.

Documentation

- Were digital photographs taken of the entire system? Yes No
- Was Property Owner provided "Operational Fact Sheet"? Yes No No - has already been provided
- Was the drawing updated to show any changes? Yes No N/A
- Was a Service Call filed for items that could not be addressed during this visit? Yes No N/A

Communication Check for PMIA Sampling																
Test point Identifier	1-1	1-2	1-B	1-10	2-1	2-2	2-3	3-1	3-2	3-3	3-5	3-7	3-8	4-1	4-2	4-3
Micromanometer Reading (" w.c. vacuum)	-0.023	-0.026	-0.011	-0.005	0.164	-0.016	-0.007	-0.013	-0.064	-0.080	-0.027	-0.060	-0.025	-0.004	-0.057	-0.028
4-5 (-0.008), 4-6 (-0.009), 4-7 (-0.018), 4-8 (-0.022), 1-12 (-0.005)																

Maximum Building Depressurization simulated? Yes No

System Inspection Field Form

FAN AND ELECTRICAL

Routine or Non-Routine (circle one)

Address: 155 Holland

Structure ID #: _____

Performed by: EA/GK

Date: 3-27/13

Equipment Documentation

Manometer Reading at Fan Inlet (" w.c. vacuum)

Fan #	2A	3A	3B	4A	4B
Fan Model	HP-220	GP-501	GP-501	HS-3000	GP-501
Manometer Reading (Prior Commissioned)	-2 ³ / ₈	-1 ⁷ / ₈	-3 ¹ / ₄	-2 ¹ / ₂	-3 ¹ / ₂
Manometer Reading (As Found)	-2 ¹ / ₄	-1 ³ / ₄	-3 ¹ / ₄	-2 ¹ / ₂	-2 ³ / ₈
Manometer Reading (As Left)	-2 ¹ / ₄	-1 ³ / ₄	-3 ¹ / ₄	-2 ¹ / ₂	-2 ³ / ₈

Manometer Reading at Sub-Slab SSPs (" w.c. vacuum)

Note: For SSPs located in accessible crawlspaces with EPDM membrane, use the crawlspace field form to record the SSP manometer reading.

SSP #	2A-A	2A-B	3A-A	3A-B	3B-A	3B-B	4B-A	4B-B	4A-A	4A-B	4B-C
Manometer Reading (Prior Commissioned)	-2 ³ / ₈	-2 ¹ / ₄	-1 ⁷ / ₈	-1 ¹ / ₂	-3 ¹ / ₂	-3 ¹ / ₂	-3 ¹ / ₂	-3 ¹ / ₂	-2 ⁵ / ₈	-2 ⁵ / ₈	-2 ¹ / ₄
Manometer Reading (As Found)	-2 ³ / ₈	-2 ¹ / ₄	-1 ⁷ / ₈	-1 ³ / ₈	-3 ¹ / ₂	-3 ³ / ₈	-2 ³ / ₈	-2 ¹ / ₄	-2 ¹ / ₂	-2 ¹ / ₂	-2 ¹ / ₄
Meet Criteria?*	Yes	Yes	Yes	Yes	Yes	Yes	No	No	Yes	Yes	Yes
Manometer Reading (As Left)	-2 ³ / ₈	-2 ¹ / ₄	-1 ⁷ / ₈	-1 ³ / ₈	-3 ¹ / ₂	-3 ³ / ₈	-2 ³ / ₈	-2 ¹ / ₄	-2 ¹ / ₂	-2 ¹ / ₂	-2 ¹ / ₄

Fan System Inspection

- | | As Found | | As Left | |
|--|---|--|---|--|
| Is fan cover still present? | <input checked="" type="checkbox"/> Yes | <input type="checkbox"/> No <input type="checkbox"/> NA | <input type="checkbox"/> Yes <input type="checkbox"/> No | <input checked="" type="checkbox"/> UC |
| Each fan mounted securely? | <input checked="" type="checkbox"/> Yes | <input type="checkbox"/> No | <input type="checkbox"/> Yes <input type="checkbox"/> No | <input checked="" type="checkbox"/> UC |
| Coupling connections secure? | <input checked="" type="checkbox"/> Yes | <input type="checkbox"/> No | <input type="checkbox"/> Yes <input type="checkbox"/> No | <input checked="" type="checkbox"/> UC |
| Is excessive noise heard when fan is running? | <input type="checkbox"/> Yes | <input checked="" type="checkbox"/> No | <input type="checkbox"/> Yes <input type="checkbox"/> No | <input checked="" type="checkbox"/> UC |
| Switch is locked in the ON position? | <input type="checkbox"/> Yes | <input checked="" type="checkbox"/> No | <input type="checkbox"/> Yes <input type="checkbox"/> No | <input checked="" type="checkbox"/> UC |
| Is set point indicated on speed controller? | <input type="checkbox"/> Yes | <input type="checkbox"/> No <input checked="" type="checkbox"/> NA | <input type="checkbox"/> Yes <input type="checkbox"/> No | <input checked="" type="checkbox"/> UC |
| Has fan been in continuous operation since previous visit? | <input checked="" type="checkbox"/> Yes | <input type="checkbox"/> No | <input type="checkbox"/> Yes <input type="checkbox"/> No | <input checked="" type="checkbox"/> UC |
| Is the pipe penetration sealed on the structure's exterior? | <input type="checkbox"/> Yes | <input checked="" type="checkbox"/> No <input type="checkbox"/> NA | <input checked="" type="checkbox"/> Yes <input type="checkbox"/> No | <input checked="" type="checkbox"/> UC FAN 4A |
| Is the downspout/PVC junction sufficiently sealed? | <input type="checkbox"/> Yes | <input type="checkbox"/> No <input checked="" type="checkbox"/> NA | <input type="checkbox"/> Yes <input type="checkbox"/> No | <input checked="" type="checkbox"/> UC |
| Is conduit penetration sealed on the structure's exterior? | <input checked="" type="checkbox"/> Yes | <input type="checkbox"/> No <input type="checkbox"/> NA | <input type="checkbox"/> Yes <input type="checkbox"/> No | <input checked="" type="checkbox"/> UC |
| Each fan runs when switch is ON position? | <input checked="" type="checkbox"/> Yes | <input type="checkbox"/> No | <input type="checkbox"/> Yes <input type="checkbox"/> No | <input checked="" type="checkbox"/> UC |
| Each fan stops when switch is in OFF position? | <input checked="" type="checkbox"/> Yes | <input type="checkbox"/> No | <input type="checkbox"/> Yes <input type="checkbox"/> No | <input checked="" type="checkbox"/> UC |
| Does the condensate line appear to be functioning correctly? | <input checked="" type="checkbox"/> Yes | <input type="checkbox"/> No | <input type="checkbox"/> Yes <input type="checkbox"/> No | <input checked="" type="checkbox"/> UC |
| Is each fan below its maximum vacuum? | <input checked="" type="checkbox"/> Yes | <input type="checkbox"/> No | <input type="checkbox"/> Yes <input type="checkbox"/> No | <input checked="" type="checkbox"/> UC |

(HP220 = 2.5" w.c., GP501 = 4.25" w.c., FR-250 = 2.6" w.c., HS-5000 = 53" w.c.)

If fan vacuum is at maximum, measure velocity at each SSP (record below).

SSP #					
Velocity at SSP (As Found)					
Velocity at SSP (As Left)					

Does the SSP velocity meet criteria (> 1 ft/min)? Yes No NA Yes No UC

Electrical System Inspection

- | | | | | | |
|--|---|--|------------------------------|-----------------------------|--|
| Are all electrical connections secure? | <input checked="" type="checkbox"/> Yes | <input type="checkbox"/> No | <input type="checkbox"/> Yes | <input type="checkbox"/> No | <input checked="" type="checkbox"/> UC |
| Each junction box closed? | <input checked="" type="checkbox"/> Yes | <input type="checkbox"/> No | <input type="checkbox"/> Yes | <input type="checkbox"/> No | <input checked="" type="checkbox"/> UC |
| Conduit/Wire properly supported? | <input checked="" type="checkbox"/> Yes | <input type="checkbox"/> No | <input type="checkbox"/> Yes | <input type="checkbox"/> No | <input checked="" type="checkbox"/> UC |
| Are audible alarm(s) present and working properly? | <input type="checkbox"/> Yes | <input type="checkbox"/> No <input checked="" type="checkbox"/> NA | <input type="checkbox"/> Yes | <input type="checkbox"/> No | <input checked="" type="checkbox"/> UC |
| Are appliances affected by fan operation? | <input type="checkbox"/> Yes | <input checked="" type="checkbox"/> No | <input type="checkbox"/> Yes | <input type="checkbox"/> No | <input checked="" type="checkbox"/> UC |

Labeling Inspection

- | | | | | | |
|---|---|--|------------------------------|-----------------------------|--|
| Correct labels applied in proper location? *** | <input checked="" type="checkbox"/> Yes | <input type="checkbox"/> No | <input type="checkbox"/> Yes | <input type="checkbox"/> No | <input checked="" type="checkbox"/> UC |
| Are labels still legible? | <input checked="" type="checkbox"/> Yes | <input type="checkbox"/> No | <input type="checkbox"/> Yes | <input type="checkbox"/> No | <input checked="" type="checkbox"/> UC |
| Is SSSD breaker identified in the electrical panel? | <input checked="" type="checkbox"/> Yes | <input type="checkbox"/> No | <input type="checkbox"/> Yes | <input type="checkbox"/> No | <input checked="" type="checkbox"/> UC |
| Commissioned value written on SSP sticker? | <input type="checkbox"/> Yes | <input checked="" type="checkbox"/> No | <input type="checkbox"/> Yes | <input type="checkbox"/> No | <input checked="" type="checkbox"/> UC |

Comments/Corrective Action

THE SEAL AROUND THE PIPE PENETRATION FOR FAN 4A WAS SEALED DURING THIS VISIT.

* As Found conditions = before corrective action. [NA = Not Applicable]

** As Left conditions = after corrective action. [UC = Unchanged from As Found conditions]

*** Criteria is met if deviation is less than or equal to 0.25" w.c. (for all fans with the exception of the HS-5000). For an HS-5000 fan, criteria is met if deviation is less than or equal to 10% of the prior commissioned value or less than or equal to 0.25" w.c., whichever is greater.

If deviation exceeds criteria (0.25" w.c. or 10% of prior commissioned value, as applicable), conduct communication testing and document on Re-Commissioning Field Form.

*** Correct labels are at least one green label per floor and one white sticker at every suction point.

System Inspection Field Form
PIPING, SLAB AND WALL

Routine or Non-Routine (circle one)

 Address: 1-5 HOLLAND AVE
 Performed by: EA/GIL

 Structure ID #:
 Date: 3/27/13
Piping Check

	<input checked="" type="checkbox"/> Yes	<input type="checkbox"/> No	<input checked="" type="checkbox"/> As Found	<input type="checkbox"/> Yes	<input type="checkbox"/> No	<input checked="" type="checkbox"/> As Left
System suction point seals are accessible?	<input checked="" type="checkbox"/>	<input type="checkbox"/>	<input type="checkbox"/>	<input type="checkbox"/>	<input type="checkbox"/>	<input checked="" type="checkbox"/>
System suction points are sealed to the slab?	<input checked="" type="checkbox"/>	<input type="checkbox"/>	<input type="checkbox"/>	<input type="checkbox"/>	<input type="checkbox"/>	<input checked="" type="checkbox"/>
Each component is installed?	<input checked="" type="checkbox"/>	<input type="checkbox"/>	<input type="checkbox"/>	<input type="checkbox"/>	<input type="checkbox"/>	<input checked="" type="checkbox"/>
Piping system is properly supported (6'-horizontal/8'-vertical)	<input checked="" type="checkbox"/>	<input type="checkbox"/>	<input type="checkbox"/>	<input type="checkbox"/>	<input type="checkbox"/>	<input checked="" type="checkbox"/>
Excessive noise is heard in piping joints?	<input type="checkbox"/>	<input checked="" type="checkbox"/>	<input type="checkbox"/>	<input type="checkbox"/>	<input type="checkbox"/>	<input checked="" type="checkbox"/>
Smoke 10% of all pipe joints and/or piping modifications?	<input checked="" type="checkbox"/>	<input type="checkbox"/>	<input type="checkbox"/>	<input type="checkbox"/>	<input type="checkbox"/>	<input checked="" type="checkbox"/>
Did smoke enter joints? **	<input type="checkbox"/>	<input checked="" type="checkbox"/>	<input type="checkbox"/>	<input type="checkbox"/>	<input type="checkbox"/>	<input checked="" type="checkbox"/>

Floor Check

	<input checked="" type="checkbox"/> Yes	<input type="checkbox"/> No	<input checked="" type="checkbox"/> As Found	<input type="checkbox"/> Yes	<input type="checkbox"/> No	<input checked="" type="checkbox"/> As Left
Are areas of the slab not visible (e.g. floor covering)?	<input checked="" type="checkbox"/>	<input type="checkbox"/>	<input type="checkbox"/>	<input type="checkbox"/>	<input type="checkbox"/>	<input checked="" type="checkbox"/>
Are areas of the slab not accessible (e.g. stored items)?	<input type="checkbox"/>	<input checked="" type="checkbox"/>	<input type="checkbox"/>	<input type="checkbox"/>	<input type="checkbox"/>	<input checked="" type="checkbox"/>
Were drawing-identified slab crack repairs/modifications smoke tested?	<input type="checkbox"/>	<input type="checkbox"/>	<input checked="" type="checkbox"/> NA	<input type="checkbox"/>	<input type="checkbox"/>	<input checked="" type="checkbox"/>
Did smoke enter? **	<input type="checkbox"/>	<input type="checkbox"/>	<input checked="" type="checkbox"/> NA	<input type="checkbox"/>	<input type="checkbox"/>	<input checked="" type="checkbox"/>
Are other cracks present that did not draw smoke?	<input checked="" type="checkbox"/>	<input type="checkbox"/>	<input type="checkbox"/> NA	<input type="checkbox"/>	<input type="checkbox"/>	<input checked="" type="checkbox"/>
Are other cracks present that did draw smoke? **	<input type="checkbox"/>	<input checked="" type="checkbox"/>	<input type="checkbox"/> NA	<input type="checkbox"/>	<input type="checkbox"/>	<input checked="" type="checkbox"/>
Were newly identified slab cracks indicated on drawing?	<input type="checkbox"/>	<input type="checkbox"/>	<input checked="" type="checkbox"/> NA	<input type="checkbox"/>	<input type="checkbox"/>	<input checked="" type="checkbox"/>
Check and clean Dranjer(s)?	<input type="checkbox"/>	<input type="checkbox"/>	<input checked="" type="checkbox"/> NA	<input type="checkbox"/>	<input type="checkbox"/>	<input checked="" type="checkbox"/>
Smoke Dranjer(s)?	<input type="checkbox"/>	<input type="checkbox"/>	<input checked="" type="checkbox"/> NA	<input type="checkbox"/>	<input type="checkbox"/>	<input checked="" type="checkbox"/>

Wall Check

	<input checked="" type="checkbox"/> Yes	<input type="checkbox"/> No	<input checked="" type="checkbox"/> As Found	<input type="checkbox"/> Yes	<input type="checkbox"/> No	<input checked="" type="checkbox"/> As Left
Are areas of the walls not visible (e.g. finished walls)?	<input checked="" type="checkbox"/>	<input type="checkbox"/>	<input type="checkbox"/>	<input type="checkbox"/>	<input type="checkbox"/>	<input checked="" type="checkbox"/>
Are areas of the walls not accessible (e.g. stored items)?	<input type="checkbox"/>	<input checked="" type="checkbox"/>	<input type="checkbox"/>	<input type="checkbox"/>	<input type="checkbox"/>	<input checked="" type="checkbox"/>
Were drawing-identified wall crack repairs/modifications smoke tested?	<input type="checkbox"/>	<input type="checkbox"/>	<input checked="" type="checkbox"/> NA	<input type="checkbox"/>	<input type="checkbox"/>	<input checked="" type="checkbox"/>
Did smoke enter wall crack(s)? **	<input checked="" type="checkbox"/>	<input type="checkbox"/>	<input checked="" type="checkbox"/> NA	<input type="checkbox"/>	<input type="checkbox"/>	<input checked="" type="checkbox"/>
Are other wall cracks/penetrations present that did not draw smoke?	<input checked="" type="checkbox"/>	<input type="checkbox"/>	<input type="checkbox"/> NA	<input type="checkbox"/>	<input type="checkbox"/>	<input checked="" type="checkbox"/>
Are other wall cracks/penetrations present that did draw smoke? **	<input type="checkbox"/>	<input checked="" type="checkbox"/>	<input type="checkbox"/> NA	<input type="checkbox"/>	<input type="checkbox"/>	<input checked="" type="checkbox"/>
Were newly identified wall cracks indicated on drawing?	<input type="checkbox"/>	<input type="checkbox"/>	<input checked="" type="checkbox"/> NA	<input type="checkbox"/>	<input type="checkbox"/>	<input checked="" type="checkbox"/>
Is top course of block wall open?	<input type="checkbox"/>	<input checked="" type="checkbox"/>	<input type="checkbox"/> NA	<input type="checkbox"/>	<input type="checkbox"/>	<input checked="" type="checkbox"/>
Smoke top course of block wall (open-top block only)?	<input type="checkbox"/>	<input type="checkbox"/>	<input checked="" type="checkbox"/> NA	<input type="checkbox"/>	<input type="checkbox"/>	<input checked="" type="checkbox"/>
Did smoke enter top course? **	<input checked="" type="checkbox"/>	<input type="checkbox"/>	<input checked="" type="checkbox"/> NA	<input type="checkbox"/>	<input type="checkbox"/>	<input checked="" type="checkbox"/>
Are utility penetrations sealed so they don't draw smoke?	<input checked="" type="checkbox"/>	<input type="checkbox"/>	<input type="checkbox"/>	<input type="checkbox"/>	<input type="checkbox"/>	<input checked="" type="checkbox"/>

Sump Check

	<input type="checkbox"/> Yes	<input type="checkbox"/> No	<input checked="" type="checkbox"/> As Found	<input type="checkbox"/> Yes	<input type="checkbox"/> No	<input checked="" type="checkbox"/> As Left
Have any non-approved modifications been made to sump cover?	<input type="checkbox"/>	<input type="checkbox"/>	<input checked="" type="checkbox"/> NA	<input type="checkbox"/>	<input type="checkbox"/>	<input checked="" type="checkbox"/>
Is sump cover structurally sound?	<input type="checkbox"/>	<input type="checkbox"/>	<input checked="" type="checkbox"/> NA	<input type="checkbox"/>	<input type="checkbox"/>	<input checked="" type="checkbox"/>
Verify integrity of sump cover seal?	<input type="checkbox"/>	<input type="checkbox"/>	<input checked="" type="checkbox"/> NA	<input type="checkbox"/>	<input type="checkbox"/>	<input checked="" type="checkbox"/>
Does sealed sump cover draw smoke? **	<input type="checkbox"/>	<input type="checkbox"/>	<input checked="" type="checkbox"/> NA	<input type="checkbox"/>	<input type="checkbox"/>	<input checked="" type="checkbox"/>

Exhaust Stack Check

Distance above eave	Commissioned distance: <u>SEE</u>	Criteria: ≥ 1 ft
Distance from nearest opening	Commissioned distance: <u>COMMENTS</u>	Criteria: ≥ 10 ft
Distance above nearest opening	Commissioned distance: <u>BELOW</u>	Criteria: ≥ 2 ft
Are vertical exhaust stack supports installed every 8' maximum?	<input checked="" type="checkbox"/> Yes <input type="checkbox"/> No <input type="checkbox"/> NA	<input type="checkbox"/> Yes <input type="checkbox"/> No <input checked="" type="checkbox"/> UC
Distances from stack exhaust to openings appear to be unchanged?	<input checked="" type="checkbox"/> Yes <input type="checkbox"/> No	<input type="checkbox"/> Yes <input type="checkbox"/> No <input checked="" type="checkbox"/> UC

*** If the existing exhaust stack is modified and/or removed and replaced as part of non-routine system maintenance, complete the "Stack Modification Field Form" and attach

Comments

ALL STACKS APPEAR TO BE AT LEAST 1' ABOVE THE EAVE + 2' ABOVE WINDOWS. STACK 4A SHOULD BE MUVED APPROXIMATELY 3' WEST. THE EXHAUST OPENING APPEARS TO BE TOO CLOSE TO THE CHIMNEY.

Notes:

- * As Found conditions = before corrective action. [NA = Not Applicable]
- * As Left conditions = after corrective action. [UC = Unchanged from As Found conditions]
- ** If answered YES to this question, perform corrective action and re-test.



System Inspection Field Form

CRAWLSPACE

Routine or Non-Routine (circle one)

Address: 1-5 HOLLAND

Structure ID #: _____

Performed by: EA/GIL

Date: 3/27/13

Inaccessible Crawlspace (Ventilation) NA

Table with 5 columns: As Found*, Crawlspace 1, Crawlspace 2, Crawlspace 3, Crawlspace 4. Rows include SSP#, Target Velocity (fpm), Measured Velocity (fpm), and Meets Criteria? **

Table with 5 columns: As Left*, Crawlspace 1, Crawlspace 2, Crawlspace 3, Crawlspace 4. Rows include SSP#, Target Velocity (fpm), Measured Velocity (fpm), and Meets Criteria? **

Is sampling port to Inaccessible crawl space threaded with a plug? Yes No Yes No UC

Accessible Crawlspace (Sub-Membrane Depressurization) NA

Table with 5 columns: As Found*, Crawlspace 1, Crawlspace 2, Crawlspace 3, Crawlspace 4. Rows include SSP#, Prior Commissioned Manometer reading (" w.c.), and As found Manometer reading (" w.c.)

Table with 5 columns: As Left*, Crawlspace 1, Crawlspace 2, Crawlspace 3, Crawlspace 4. Row includes Manometer reading (" w.c.)

Accessible Crawlspace Performance Inspection

Was each membrane joint smoke tested? Yes No Yes No UC
Did smoke enter? *** Yes No Yes No UC
Was the membrane perimeter smoke tested? Yes No Yes No UC
Did smoke enter? *** Yes No Yes No UC
Is the suction point manometer(s) reading <= -1/10" w.c.?**** Yes No Yes No UC

Comments

* As Found conditions = before corrective action. [NA = Not Applicable]
* As Left conditions = after corrective action. [UC = Unchanged from As Found conditions]
** Inaccessible Crawlspace Criteria: Measured velocity >= 90% of Target Velocity (adjust if >110% of target velocity)
*** If answered YES to this question, perform corrective action and re-test.
**** If answered NO to this question, adjust valve accordingly and re-check all SSP and fan readings.



System Inspection Field Form

STRUCTURE INSPECTION

Routine or Non-Routine (circle one)

Address: 1 HOLLAND AVE

Structure ID #: —

Performed by: EMA/GPK/MAR

Date: 2/27/12 + 3/6/12

Have the following items changed since the last visit?

	Yes	No
Building Foot Print		X
Basement/Slab Occupancy	X	
Heating / Ventilating Systems		X
Basement Finish	X	
Crawlspaces		X
Drains, Sumps, Floor Cracks		X
Wall Penetrations, Cracks		X
Appliances (in basement)		X
Siding		X
Are there any new buildings on the property or conversion of spaces in previously existing building?		X
Ownership		X

If Yes, describe in comments section below.

If Yes, write new owner name contact information below

Date of Ownership Change
Owner Name
Telephone No.

If any of these items have changed, a redesign may be required. Contact the maintenance supervisor for field review.

Documentation

- Were digital photographs taken of the entire system?
Was Property Owner provided "Operational Fact Sheet"?
Was the drawing updated to show any changes?
Was a Service Call filed for items that could not be addressed during this visit?

Comments

BUILDING #3 IS OCCUPIED BY AN AUTOMOTIVE DETAILING COMPANY. THE CONCRETE FLOORS IN BUILDINGS 1+2 WERE RECENTLY REPAINTED, NEW TILE WAS ADDED IN THE NORTHWEST SECTION OF BUILDING 2

System Inspection Field Form

FAN AND ELECTRICAL

Routine or Non-Routine (circle one)

Address: 1 HOLLAND AVE

Structure ID #: _____

Performed by: EMA/GPK/MAR

Date: 2/27/12 + 3/6/12

Equipment Documentation

Manometer Reading at Fan Inlet (" w.c. vacuum)

Fan #	2A	3A	3B	4A	4B
Fan Model	HP-220	GP-501	GP-501	HS-3000	GP-501
Manometer Reading (Prior Commissioned)	NR	NR	NR	NR	NR
Manometer Reading (As Found)	-2 ³ / ₈	-1 ⁷ / ₈	-3 ¹ / ₄	0	0
Manometer Reading (As Left)	-2 ³ / ₈	-1 ⁷ / ₈	-3 ¹ / ₄	-2 ¹ / ₂	-3 ¹ / ₂

Manometer Reading at Sub-Slab SSPs (" w.c. vacuum)

Note: For SSPs located in accessible crawlspaces with EPDM membrane, use the crawlspace field form to record the SSP manometer reading.

SSP #	2A-A	2A-B	3A-A	3A-B	3B-A	3B-B	4B-A	4B-B	4A-A	4A-B
Manometer Reading (Prior Commissioned)	-2 ¹ / ₄	-2 ¹ / ₄	-1 ³ / ₄	-1 ³ / ₄	-3 ¹ / ₂	-3 ¹ / ₂	-3 ¹ / ₂	-3 ¹ / ₂	-3 ³ / ₄	-3 ³ / ₄
Manometer Reading (As Found)	-2 ³ / ₈	-2 ¹ / ₄	-1 ⁷ / ₈	-1 ¹ / ₂	-3 ¹ / ₂	-3 ¹ / ₂	0	0	0	0
Meet Criteria?*	N	Y	Y	Y	Y	Y	N	N	N	N
Manometer Reading (As Left)	-2 ³ / ₈	-2 ¹ / ₄	-1 ⁷ / ₈	-1 ¹ / ₂	-3 ¹ / ₂	-3 ¹ / ₂	-3 ¹ / ₂	-3 ¹ / ₂	-2 ⁵ / ₈	-2 ⁵ / ₈

Fan System Inspection

As Found

As Left

- Is fan cover still present? Yes No NA Yes No UC
- Each fan mounted securely? Yes No NA Yes No UC
- Coupling connections secure? Yes No NA Yes No UC
- Is excessive noise heard when fan is running? Yes No NA Yes No UC
- Switch is locked in the ON position? Yes No NA Yes No UC
- Is set point indicated on speed controller? Yes No NA Yes No UC
- Has fan been in continuous operation since previous visit? Yes No NA Yes No UC
- Is the pipe penetration sealed on the structure's exterior? Yes No NA Yes No UC
- Is the downspout/PVC junction sufficiently sealed? Yes No NA Yes No UC
- Is conduit penetration sealed on the structure's exterior? Yes No NA Yes No UC
- Each fan runs when switch is ON position? Yes No NA Yes No UC
- Each fan stops when switch is in OFF position? Yes No NA Yes No UC
- Does the condensate line appear to be functioning correctly? Yes No NA Yes No UC
- Is each fan below its maximum vacuum? Yes No NA Yes No UC

(HP220 = 2.5" w.c., GP501 = 4.25" w.c., FR-250 = 2.6" w.c., HS-5000 = 53" w.c.)

If fan vacuum is at maximum, measure velocity at each SSP (record below).

SSP #							
Velocity at SSP (As Found)							
Velocity at SSP (As Left)							

Does the SSP velocity meet criteria (> 1 ft/min)? Yes No NA Yes No UC

Electrical System Inspection

- Are all electrical connections secure? Yes No NA Yes No UC
- Each junction box closed? Yes No NA Yes No UC
- Conduit/Wire properly supported? Yes No NA Yes No UC
- Are audible alarm(s) present and working properly? Yes No NA Yes No UC
- Are appliances affected by fan operation? Yes No NA Yes No UC

Labeling Inspection

- Correct labels applied in proper location? *** Yes No NA Yes No UC
- Are labels still legible? Yes No NA Yes No UC
- Is SSDS breaker identified in the electrical panel? Yes No NA Yes No UC
- Commissioned value written on SSP sticker? Yes No NA Yes No UC

Comments/Corrective Action

FANS 4A+4B WERE OFF. FAN 4B WAS RESTARTED (BREAKER TURNED OFF). FAN 4A WAS REPLACED

* As Found conditions = before corrective action. [NA = Not Applicable]

** As Left conditions = after corrective action. [UC = Unchanged from As Found conditions]

*** Criteria is met if deviation is less than or equal to 0.25"wc (for all fans with the exception of the HS-5000). For an HS-5000 fan, criteria is met if deviation is less than or equal to 10% of the prior commissioned value or less than or equal to 0.25"wc, whichever is greater. If deviation exceeds criteria (0.25"wc or 10% of prior commissioned value, as applicable), conduct communication testing and document on Re-Commissioning Field Form.

*** Correct labels are at least one green label per floor and one white sticker at every suction point.



System Inspection Field Form

PIPING, SLAB AND WALL

Routine or Non-Routine (circle one)

Address: 1 HOLLAND AVE
Performed by: EWA/GPK/MAR

Structure ID #:
Date: 2/27/12 + 3/6/12

Piping Check

System suction point seals are accessible?
System suction points are sealed to the slab?
Each component is installed?
Piping system is properly supported (6'-horizontal/8'-vertical)
Excessive noise is heard in piping joints?
Smoke 10% of all pipe joints and/or piping modifications?
Did smoke enter joints? **

Floor Check

Are areas of the slab not visible (e.g. floor covering)?
Are areas of the slab not accessible (e.g. stored items)?
Were drawing-identified slab crack repairs/modifications smoke tested?
Did smoke enter? **
Are other cracks present that did not draw smoke?
Are other cracks present that did draw smoke? **
Were newly identified slab cracks indicated on drawing?
Check and clean Dranjer(s)?
Smoke Dranjer(s)?

Wall Check

Are areas of the walls not visible (e.g. finished walls)?
Are areas of the walls not accessible (e.g. stored items)?
Were drawing-identified wall crack repairs/modifications smoke tested?
Did smoke enter wall crack(s)? **
Are other wall cracks/penetrations present that did not draw smoke?
Are other wall cracks/penetrations present that did draw smoke? **
Were newly identified wall cracks indicated on drawing?
Is top course of block wall open?
Smoke top course of block wall (open-top block only)?
Did smoke enter top course? **
Are utility penetrations sealed so they don't draw smoke?

Sump Check

Have any non-approved modifications been made to sump cover?
Is sump cover structurally sound?
Verify integrity of sump cover seal?
Does sealed sump cover draw smoke? **

Exhaust Stack Check

Distance above eave
Distance from nearest opening
Distance above nearest opening
Are vertical exhaust stack supports installed every 8' maximum?
Distances from stack exhaust to openings appear to be unchanged?

*** If the existing exhaust stack is modified and/or removed and replaced as part of non-routine system maintenance, complete the "Stack Modification Field Form" and attach

Comments

All stacks appear to be at least 1' above the eave + 2' above windows. Stack 4A should be moved approximately 3' west. The exhaust opening appears to be too close to the chimney

Notes:

- * As Found conditions = before corrective action. [NA = Not Applicable]
* As Left conditions = after corrective action. [UC = Unchanged from As Found conditions]
** If answered YES to this question, perform corrective action and re-test.



System Inspection Field Form

CRAWLSPACE

Routine or Non-Routine (circle one)

Address: 1 HOLLAND AVE

Structure ID #: 7

Performed by: EWA/GPK/MAN

Date: 2/27/12 + 3/6/12

Inaccessible Crawlspace (Ventilation) [X] NA

Table with 5 columns: As Found*, Crawlspace 1, Crawlspace 2, Crawlspace 3, Crawlspace 4. Rows: SSP#, Target Velocity (fpm), Measured Velocity (fpm), Meets Criteria? **

Table with 5 columns: As Left*, Crawlspace 1, Crawlspace 2, Crawlspace 3, Crawlspace 4. Rows: SSP#, Target Velocity (fpm), Measured Velocity (fpm), Meets Criteria? **

Is sampling port to Inaccessible crawl space threaded with a plug? [] Yes [] No [] Yes [] No [] UC

Accessible Crawlspace (Sub-Membrane Depressurization) [X] NA

Table with 5 columns: As Found*, Crawlspace 1, Crawlspace 2, Crawlspace 3, Crawlspace 4. Rows: SSP#, Prior Commissioned Manometer reading (" w.c.), As found Manometer reading (" w.c.)

Table with 5 columns: As Left*, Crawlspace 1, Crawlspace 2, Crawlspace 3, Crawlspace 4. Rows: SSP#, Manometer reading (" w.c.)

Accessible Crawlspace Performance Inspection

- Was each membrane joint smoke tested? [] Yes [] No [] Yes [] No [] UC
Did smoke enter? *** [] Yes [] No [] Yes [] No [] UC
Was the membrane perimeter smoke tested? [] Yes [] No [] Yes [] No [] UC
Did smoke enter? *** [] Yes [] No [] Yes [] No [] UC
Is the suction point manometer(s) reading <= -1/10" w.c.?**** [] Yes [] No [] Yes [] No [] UC

Comments

Three horizontal lines for handwritten comments.

* As Found conditions = before corrective action. [NA = Not Applicable]
* As Left conditions = after corrective action. [UC = Unchanged from As Found conditions]
** Inaccessible Crawlspace Criteria: Measured velocity >= 90% of Target Velocity (adjust if >110% of target velocity)
*** If answered YES to this question, perform corrective action and re-test.
**** If answered NO to this question, adjust valve accordingly and re-check all SSP and fan readings.

Re-Commissioning Field Form

TEST DATA AND BACKDRAFT

Routine or Non-Routine (circle one)

Address: 1 Hollands Ave

Structure ID #:

Performed by: EM/GR/MAR

Date: 2/27/12 + 3/6/12

Manometer Reading at Fan Inlet (" w.c. vacuum)

	2A	3A	3B	4A	4B
Prior commissioning:	OR	OR	OR	OR	OR
As found:	-2 ³ / ₈	-1 ⁷ / ₈	-3 ¹ / ₄	0	0
As left:	-2 ³ / ₈	-1 ⁷ / ₈	-3 ¹ / ₄	-2 ¹ / ₂	-3 ¹ / ₂

Fan Model:

- 2A- HP-220
- 3A- GP-501
- 3B- GP-501
- 4A- HS-3000
- 4B- GP-501

Manometer Reading at All SSPs (" w.c. vacuum)

SSP#	2A-B	2A-A	3A-A	3A-B	3B-A	3B-B	4A-A	4A-B	4B-A	4B-B
Manometer Reading (Commissioned)	-2 ¹ / ₄	-2 ¹ / ₄	-1 ³ / ₄	-1 ³ / ₄	-3 ¹ / ₂	-3 ¹ / ₂	-3 ³ / ₄	-3 ³ / ₄	-3 ¹ / ₂	-3 ¹ / ₂
Manometer Reading (As Found)	-2 ³ / ₈	-2 ¹ / ₄	-1 ¹ / ₈	-1 ¹ / ₂	-3 ¹ / ₂	-3 ¹ / ₂	0	0	0	0
Manometer Reading (As Left)	-2 ³ / ₈	-2 ¹ / ₄	-1 ⁷ / ₈	-1 ¹ / ₂	-3 ¹ / ₂	-3 ¹ / ₂	-2 ⁵ / ₈	-2 ⁵ / ₈	-3 ¹ / ₂	-3 ¹ / ₂

Velocity at SSP (As Found)										
Target Velocity (fpm)										
Meets Criteria? **					NA					
Velocity at SSP (As Left)										

Is each fan below its maximum vacuum? Yes No
 (HP220 = 2.5" w.c., GP501 = 4.25" w.c., FR-250 = 2.6" w.c., HS-5000 = 53" w.c.)

If fan vacuum is at maximum, measure velocity at each SSP (record above).

Valves and Manometers are installed in proper location? Yes No NA

Communication Test

As Found*

Test point Identifier	1-1	1-2	1-3	1-B	1-D	1-12	2-1	2-2	2-3	3-1	3-2	3-3	3-5	3-7	3-8	4-1	4-2	4-3	4-5	4-6	4-7	4-8
Micromanometer Reading (" w.c. vacuum)	0.000	0.000	0.000	0.000	0.000	0.000	0.000	0.000	0.000	0.000	0.000	0.000	0.000	0.000	0.000	0.000	0.000	0.000	0.000	0.000	0.000	0.000
Does smoke enter?	N/A	N/A	N/A	N/A	N/A	N/A	N/A	N/A	N/A	N/A	N/A	N/A	N/A	N/A	N/A	N/A	N/A	N/A	N/A	N/A	N/A	N/A

As Left*

Test point Identifier	1-1	1-2	1-3	1-B	1-D	1-12	2-1	2-2	2-3	3-1	3-2	3-3	3-5	3-7	3-8	4-1	4-2	4-3	4-5	4-6	4-7	4-8
Micromanometer Reading (" w.c. vacuum)	0.000	0.000	0.000	0.000	0.000	0.000	0.000	0.000	0.000	0.000	0.000	0.000	0.000	0.000	0.000	0.000	0.000	0.000	0.000	0.000	0.000	0.000
Does smoke enter?	N/A	N/A	N/A	N/A	N/A	N/A	N/A	N/A	N/A	N/A	N/A	N/A	N/A	N/A	N/A	N/A	N/A	N/A	N/A	N/A	N/A	N/A

- All fans in operation during final communication test? Yes No
- Maximum Building Depressurization simulated? Yes No
- All valves set prior to re-commissioning comm. test? Yes No N/A
- Vacuum ≥ 0.004" w.c. observed at each test point? Yes No N/A
- Was there precipitation during the previous 24 hours? Yes No
- What was the apparent wind speed? Calm Light Strong
- Each test point tested? Yes No N/A
- Each test point sealed after testing? Yes No

* As Found conditions = before corrective action. [NA = Not Applicable]

* As Left conditions = after corrective action. [UC = Unchanged from As Found conditions]

** If fan vacuum is at maximum, SSP velocity criteria is met if velocity is >1 ft/min

** Inaccessible Crawlspace Criteria: Measured velocity ≥ 90% of Target Velocity (adjust if >110% of target velocity)

Re-Commissioning Field Form

TEST DATA AND BACKDRAFT

Routine or Non-Routine (circle one)

Address: 11 HALANDS AVE

Structure ID #: _____

Performed by: EMM/GRK/MAR

Date: 2/27/12 + 3/6/12

Backdraft Test

- Was backdraft test performed? Yes No
- Windows closed? Yes No
- Venting appliances on (e.g. bathroom fan)? Yes No
- Doors closed? Yes No
- Combustion sources on? Yes No

- On what combustion appliances was a backdraft test performed?
- Hot Water Heater
 - Dryer
 - Fireplace (damper closed)
 - Furnace / Boiler
 - Fireplace (damper opened)
- Other: _____

Was any combustion appliance not operable and could not be tested? Yes No UNKNOWN
 (If yes, explain) _____

Is there is a backdraft on any appliance? Yes No UNKNOWN
 (If yes, explain)** _____

Was a previous backdraft condition present during any previous visit? Yes No NA UNKNOWN

*Do not operate whole house fan during backdraft test.
 ** If backdraft exists, shut down SSD system. Backdraft will need to be corrected prior to re-energizing system.
 ** If backdraft exists, please notify the property owner. Owner was notified on: (date) _____

Red-line Drawing (Non-routine System Modifications)

- Piping redlines complete? Yes No NA
- Each switch and electrical tie in are identified? Yes No NA
- Cracks/penetrations are identified? Yes No NA
- As-built notes are complete? Yes No NA
- New ventilation devices identified? Yes No NA
- Was stack modified? Yes No NA

** Complete Stack Modification Field Form

Comments
HEAT UNITS MOUNTED AT CEILING LEVEL AND COULD NOT BE ACCESSED

VI MITIGATION SYSTEM SERVICE CALL

Date of Call/Request: 2-27/12

Call/Request Received by:

Address: 1-5 HOLLAND AVE. WHITE PLAINS NY

E. Alongi

Name of Resident: _____

Telephone Number: _____

Description of Work Requested: HS-3000 FAN FOUND INOPERABLE DURING ROUTINE INSPECTION.
REPLACE FAN WITH "LIKE-N-KIND" + CHECK SSP READINGS

Manpower Required to Complete (Circle all that apply): Install Team O&M Team
 Electrician Asbestos Sub. Other

Scheduled Date & Time of Work: 3/6/12 9AM

Description of Work Completed: REPLACED HS-3000 FAN WITH "LIKE-N-KIND" MODEL + CHECKED
SSP READINGS. VACUUM AT ACCESSIBLE CTP'S WAS CHECKED. THOUGH SSP VALUES ASSOCIATED
WITH THE NEW FAN DIFFERED BY MORE THAN 0.25" W.C FROM IC/OC VALVES, VACUUM
AT ACCESSIBLE CTP'S MET CRITERIA

System Re-Commissioning Needed: Yes No

System Re-Commissioning Completed: Yes No N/A

Follow-up Work to be Scheduled: NA

Scheduled Date & Time of Follow-up Work: NA

Follow-up Work Completed: Yes No

System Re-Commissioning Needed: Yes No

System Re-Commissioning Completed: Yes No N/A

Blank Inspection Forms



System Inspection Field Form

FAN AND ELECTRICAL

Routine or Non-Routine (circle one)

Address: _____

Structure ID #: _____

Performed by: _____

Date: _____

Equipment Documentation

Manometer Reading at Sub-Slab SSPs (" w.c. vacuum)

Note: For SSPs located in accessible crawlspaces with EPDM membrane, use the crawlspace field form to record the SSP manometer reading.

SSP #							
Manometer Reading (Prior Commissioned)							
Manometer Reading (As Found)							
Meet Criteria?*							
Manometer Reading (As Left)							

Fan System Inspection

As Found

As Left

- Is fan cover still present? Yes No NA Yes No UC
 - Each fan mounted securely? Yes No Yes No UC
 - Coupling connections secure? Yes No Yes No UC
 - Is excessive noise heard when fan is running? Yes No Yes No UC
 - Switch is locked in the ON position? Yes No Yes No UC
 - Is set point indicated on speed controller? Yes No NA Yes No UC
 - Has fan been in continuous operation since previous visit? Yes No Yes No UC
 - Is the pipe penetration sealed on the structure's exterior? Yes No NA Yes No UC
 - Is the downspout/PVC junction sufficiently sealed? Yes No NA Yes No UC
 - Is conduit penetration sealed on the structure's exterior? Yes No NA Yes No UC
 - Each fan runs when switch is ON position? Yes No Yes No UC
 - Each fan stops when switch is in OFF position? Yes No Yes No UC
 - Does the condensate line appear to be functioning correctly? Yes No Yes No UC
 - Is each fan below its maximum vacuum? Yes No Yes No UC
- (HP220 = 2.5" w.c., GP501 = 4.25" w.c., FR-250 = 2.6" w.c., HS-5000 = 53" w.c.)

Electrical System Inspection

- Are all electrical connections secure? Yes No Yes No UC
- Each junction box closed? Yes No Yes No UC
- Conduit/Wire properly supported? Yes No Yes No UC
- Are audible alarm(s) present and working properly? Yes No NA Yes No UC
- Are appliances affected by fan operation? Yes No Yes No UC

Labeling Inspection

- Correct labels applied in proper location? *** Yes No Yes No UC
- Are labels still legible? Yes No Yes No UC
- Is SSSD breaker identified in the electrical panel? Yes No Yes No UC
- Commissioned value written on SSP sticker? Yes No Yes No UC revised June

Comments/Corrective Action

* As Found conditions = before corrective action. [NA = Not Applicable]

* As Left conditions = after corrective action. [UC = Unchanged from As Found conditions]

** Criteria is met if deviation is less than or equal to 0.25"wc (for all fans with the exception of the HS-5000). For an HS-5000 fan, criteria is met if deviation is less than or equal to 10% of the prior commissioned value or less than or equal to 0.25"wc, whichever is greater. If deviation exceeds criteria (0.25"wc or 10% of prior commissioned value, as applicable), conduct communication testing and document on Re-Commissioning Field Form.

*** Correct labels are at least one green label per floor and one white sticker at every suction point.



System Inspection Field Form

PIPING, SLAB AND WALL

Routine or Non-Routine (circle one)

Address: _____

Structure ID #: _____

Performed by: _____

Date: _____

Piping Check

	<u>As Found</u>			<u>As Left</u>		
System suction point seals are accessible?	<input type="checkbox"/> Yes	<input type="checkbox"/> No		<input type="checkbox"/> Yes	<input type="checkbox"/> No	<input type="checkbox"/> UC
System suction points are sealed to the slab?	<input type="checkbox"/> Yes	<input type="checkbox"/> No		<input type="checkbox"/> Yes	<input type="checkbox"/> No	<input type="checkbox"/> UC
Each component is installed?	<input type="checkbox"/> Yes	<input type="checkbox"/> No		<input type="checkbox"/> Yes	<input type="checkbox"/> No	<input type="checkbox"/> UC
Piping system is properly supported (6'-horizontal/8'-vertical)	<input type="checkbox"/> Yes	<input type="checkbox"/> No		<input type="checkbox"/> Yes	<input type="checkbox"/> No	<input type="checkbox"/> UC
Excessive noise is heard in piping joints?	<input type="checkbox"/> Yes	<input type="checkbox"/> No		<input type="checkbox"/> Yes	<input type="checkbox"/> No	<input type="checkbox"/> UC
Smoke 10% of all pipe joints and/or piping modifications?	<input type="checkbox"/> Yes	<input type="checkbox"/> No		<input type="checkbox"/> Yes	<input type="checkbox"/> No	<input type="checkbox"/> UC
Did smoke enter joints? **	<input type="checkbox"/> Yes	<input type="checkbox"/> No		<input type="checkbox"/> Yes	<input type="checkbox"/> No	<input type="checkbox"/> UC

Floor Check

Are areas of the slab not visible (e.g. floor covering)?	<input type="checkbox"/> Yes	<input type="checkbox"/> No		<input type="checkbox"/> Yes	<input type="checkbox"/> No	<input type="checkbox"/> UC
Are areas of the slab not accessible (e.g. stored items)?	<input type="checkbox"/> Yes	<input type="checkbox"/> No		<input type="checkbox"/> Yes	<input type="checkbox"/> No	<input type="checkbox"/> UC
Were drawing-identified slab crack repairs/modifications smoke tested?	<input type="checkbox"/> Yes	<input type="checkbox"/> No	<input type="checkbox"/> NA	<input type="checkbox"/> Yes	<input type="checkbox"/> No	<input type="checkbox"/> UC
Did smoke enter? **	<input type="checkbox"/> Yes	<input type="checkbox"/> No	<input type="checkbox"/> NA	<input type="checkbox"/> Yes	<input type="checkbox"/> No	<input type="checkbox"/> UC
Are other cracks present that did not draw smoke?	<input type="checkbox"/> Yes	<input type="checkbox"/> No	<input type="checkbox"/> NA	<input type="checkbox"/> Yes	<input type="checkbox"/> No	<input type="checkbox"/> UC
Are other cracks present that did draw smoke?***	<input type="checkbox"/> Yes	<input type="checkbox"/> No	<input type="checkbox"/> NA	<input type="checkbox"/> Yes	<input type="checkbox"/> No	<input type="checkbox"/> UC
Were newly identified slab cracks indicated on drawing?	<input type="checkbox"/> Yes	<input type="checkbox"/> No	<input type="checkbox"/> NA	<input type="checkbox"/> Yes	<input type="checkbox"/> No	<input type="checkbox"/> UC
Check and clean Dranjer(s)?	<input type="checkbox"/> Yes	<input type="checkbox"/> No	<input type="checkbox"/> NA	<input type="checkbox"/> Yes	<input type="checkbox"/> No	<input type="checkbox"/> UC
Smoke Dranjer(s)?	<input type="checkbox"/> Yes	<input type="checkbox"/> No	<input type="checkbox"/> NA	<input type="checkbox"/> Yes	<input type="checkbox"/> No	<input type="checkbox"/> UC

Wall Check

Are areas of the walls not visible (e.g. finished walls)?	<input type="checkbox"/> Yes	<input type="checkbox"/> No		<input type="checkbox"/> Yes	<input type="checkbox"/> No	<input type="checkbox"/> UC
Are areas of the walls not accessible (e.g. stored items)?	<input type="checkbox"/> Yes	<input type="checkbox"/> No		<input type="checkbox"/> Yes	<input type="checkbox"/> No	<input type="checkbox"/> UC
Were drawing-identified wall crack repairs/modifications smoke tested?	<input type="checkbox"/> Yes	<input type="checkbox"/> No	<input type="checkbox"/> NA	<input type="checkbox"/> Yes	<input type="checkbox"/> No	<input type="checkbox"/> UC
Did smoke enter wall crack(s)? **	<input type="checkbox"/> Yes	<input type="checkbox"/> No	<input type="checkbox"/> NA	<input type="checkbox"/> Yes	<input type="checkbox"/> No	<input type="checkbox"/> UC
Are other wall cracks/penetrations present that did not draw smoke?	<input type="checkbox"/> Yes	<input type="checkbox"/> No	<input type="checkbox"/> NA	<input type="checkbox"/> Yes	<input type="checkbox"/> No	<input type="checkbox"/> UC
Are other wall cracks/penetrations present that did draw smoke?***	<input type="checkbox"/> Yes	<input type="checkbox"/> No	<input type="checkbox"/> NA	<input type="checkbox"/> Yes	<input type="checkbox"/> No	<input type="checkbox"/> UC
Were newly identified wall cracks indicated on drawing?	<input type="checkbox"/> Yes	<input type="checkbox"/> No	<input type="checkbox"/> NA	<input type="checkbox"/> Yes	<input type="checkbox"/> No	<input type="checkbox"/> UC
Is top course of block wall open?	<input type="checkbox"/> Yes	<input type="checkbox"/> No	<input type="checkbox"/> NA	<input type="checkbox"/> Yes	<input type="checkbox"/> No	<input type="checkbox"/> UC
Smoke top course of block wall (open-top block only)?	<input type="checkbox"/> Yes	<input type="checkbox"/> No	<input type="checkbox"/> NA	<input type="checkbox"/> Yes	<input type="checkbox"/> No	<input type="checkbox"/> UC
Did smoke enter top course? **	<input type="checkbox"/> Yes	<input type="checkbox"/> No	<input type="checkbox"/> NA	<input type="checkbox"/> Yes	<input type="checkbox"/> No	<input type="checkbox"/> UC
Are utility penetrations sealed so they don't draw smoke?	<input type="checkbox"/> Yes	<input type="checkbox"/> No		<input type="checkbox"/> Yes	<input type="checkbox"/> No	<input type="checkbox"/> UC

Exhaust Stack Check

Distance above eave	Commissioned distance: _____	Criteria: ≥ 1 ft
Distance from nearest opening	Commissioned distance: _____	Criteria: ≥ 10 ft
Distance above nearest opening	Commissioned distance: _____	Criteria: ≥ 2 ft
Are vertical exhaust stack supports installed every 8' maximum?	<input type="checkbox"/> Yes <input type="checkbox"/> No <input type="checkbox"/> NA	<input type="checkbox"/> Yes <input type="checkbox"/> No <input type="checkbox"/> UC
Distances from stack exhaust to openings appear to be unchanged?	<input type="checkbox"/> Yes <input type="checkbox"/> No	<input type="checkbox"/> Yes <input type="checkbox"/> No <input type="checkbox"/> UC

*** If the existing exhaust stack is modified and/or removed and replaced as part of non-routine system maintenance, complete the "Stack Modification Field Form" and attach

Comments

Notes:

* As Found conditions = before corrective action. [NA = Not Applicable]

* As Left conditions = after corrective action. [UC = Unchanged from As Found conditions]

** If answered YES to this question, perform corrective action and re-test.

360° Engineering and Project Delivery Solutions

All materials printed on recycled paper. 

