BROWNFIELD CLEANUP PROGRAM

APPENDIX B EXCAVATION WORK PLAN

TECUMSEH PHASE II BUSINESS PARK
NYSDEC SITE NUMBERS: C915198 through C915198L
LACKAWANNA, NEW YORK

December 2013
Revised July 2021

0071-012-322

Prepared By:



TurnKey Environmental Restoration, LLC
2558 Hamburg Turnpike, Suite 300
Buffalo, NY 14218
(716) 856-0635

**EXCAVATION WORK PLAN
TECUMSEH PHASE II BUSINESS PARK**

Table of Contents

1.0	INTRODUCTION.....	1
1.1	Purpose and Scope	1
1.2	Notification	1
2.0	SCREENING, SEGREGATION AND STOCKPILING	3
2.1	Soil Screening and Segregation Methods	3
2.2	Stockpile Methods	4
3.0	EXCAVATION, TRANSPORT, DISPOSAL, AND REUSE	5
3.1	Materials Excavation and Load Out	5
3.2	Material Transport Off-Site	5
3.3	Materials Disposal Off-Site	6
3.4	Materials Reuse On-Site	7
3.4.1	<i>Soil/Fill</i>	7
3.4.2	<i>Petroleum-Impacted Soil/Fill</i>	7
3.4.3	<i>Debris</i>	8
3.4.4	<i>Slag</i>	8
3.5	Fluids Management.....	9
4.0	BACKFILL AND RESTORATION.....	10
4.1	Cover Materials.....	10
4.2	Backfill from Off-Site Sources	10
4.3	Backfill from On-Site Sources.....	12
5.0	MONITORING AND INSPECTIONS	13
5.1	Stormwater Pollution Prevention.....	13
5.2	Contingency Plan.....	14
5.3	Community Air Monitoring Plan.....	14
5.3.1	<i>Organic Vapor Community Air Monitoring</i>	15
5.3.2	<i>Explosive Vapor Community Air Monitoring</i>	16
5.3.3	<i>Airborne Particulate Community Air Monitoring</i>	16
5.3.4	<i>Special Requirements</i>	17
5.4	Odor Control Plan.....	17
5.5	Dust Control Plan.....	18
5.6	Other Nuisances	19
6.0	REFERENCES	20

**EXCAVATION WORK PLAN
TECUMSEH PHASE II BUSINESS PARK**

Table of Contents

LIST OF TABLES

Table B-1	Criteria for Imported Soils
-----------	-----------------------------

LIST OF FIGURES

Figure 1	Site Location and Vicinity Map
Figure 2	Site Delineation Map

APPENDICES

Appendix B-1	SPDES General Permit GP-0-20-001 and NOI
Appendix B-2	Erosion and Sediment Controls
Appendix B-3	NYSDOH's Generic Community Air Monitoring Plan Fugitive Dust and Particulate Monitoring

1.0 INTRODUCTION

1.1 Purpose and Scope

This document is a required element of the remedial program for the New York State Brownfield Cleanup Program (BCP) Sites within and collectively comprising the property referred to as the “Tecumseh Phase II Business Park,” located in City of Lackawanna, Erie County, New York (hereinafter referred to as the “Controlled Property” under the New York State (NYS) Brownfield Cleanup Program (BCP) administered by New York State Department of Environmental Conservation (NYSDEC). The Controlled Property is comprised of an approximate 141-acre area bounded by the Tecumseh Phase I and IA Business Parks to the north; the South Buffalo Railroad Company to the south; Tecumseh Phase III Business Park and South Return Water Trench (SRWT) to the west; and Route 5 to the east (see Figures 1 and 2). As shown on Figure 2, the Controlled Property collectively includes Sites II-1 through II-12 (C915198 through C915198L).

This Excavation Work Plan (EWP) has been prepared by TurnKey Environmental Restoration, LLC (TurnKey) in accordance with NYSDEC Program Policy DER-10 (Ref. 1). An Interim EWP was followed during all ground intrusive activities conducted during site preparation work (e.g., excavation for utility lines, grading work performed in advance of cover placement, etc.) as remedial measures proceeded toward final cleanup and issuance of the Certificate of Completion (COC). In accordance with DER-10 Section 6.1(b)2, the Interim EWP was modified for post-remedial use and has been incorporated into this Excavation Work Plan component of the SMP.

1.2 Notification

At least 15 days prior to the start of any activity that is anticipated to encounter remaining contamination, the Site Owner or their representative will notify the NYSDEC. Currently, this notification will be made to:

Mr. Andrew Zwack
Assistant Engineer
NYSDEC – Region 9
270 Michigan Avenue
Buffalo, NY 14203-2999

This notification will include:

- Depth of work to be performed; location of work; and areal extent.
- A detailed description of plans for re-grading, intrusive elements, or utilities to be installed below the soil cover; estimated volumes of contaminated soil to be excavated; and any work that may impact an existing engineering control. Appropriate locations for staging and stockpiling of non-impacted and impacted (if encountered) soil/fill materials will also be identified.
- A summary of environmental conditions anticipated in the work areas, including the nature and concentration levels of contaminants of concern, potential presence of grossly contaminated media, and plans for any pre-construction sampling.
- A schedule for the work, detailing the start and completion of all intrusive work.
- A summary of the applicable components of this EWP.
- A statement that the work will be performed in compliance with this EWP and 29CFR 1910.120.
- A copy of the contractor's health and safety plan, in electronic format, if it differs from the Health and Safety Plan (HASP).
- Identification of disposal facilities for potential waste streams.
- Identification of sources of any anticipated backfill, along with all required analytical testing results.

2.0 SCREENING, SEGREGATION AND STOCKPILING

Requirements for screening, segregation, and stockpiling of excavated soil/fill materials are presented below. As further discussed in Section 3.0, all soil and fill excavated from the Site is to be treated as regulated contaminated material regardless of field evidence of impact. If any such material is removed from the Site it must be transported by a licensed hauler and either treated or disposed at a permitted facility in accordance with all local, State (including 6NYCRR Part 360) and Federal regulations or reused, with NYSDEC pre-approval subject to a 6NYCRR Part 360 Beneficial Use Determination (BUD), at another regulated cleanup site having an Environmental Easement and Site Management Plan.

2.1 Soil Screening and Segregation Methods

Visual, olfactory, and/or instrument (photoionization detector or equivalent)-based, soil screening will be performed by a qualified environmental professional (QEP), as defined by NYSDEC in DER-10 Section 1.3(b)49, or a person under their supervision, during all intrusive activities, as necessary. Additionally, slag encountered will be further field-screened by an experienced technician using a Ludlum Model 2221 Ratemeter/Scaler with a sodium iodide scintillator (2x2 meter) or equivalent for gamma radiation due to its potential to contain technologically enhanced naturally occurring radioactive material (TENORM). Slag screening and TENORM evaluation are further discussed in Section 3.4.4.

Non-impacted soil/fill may be replaced in the excavation or reused on-site in accordance with Section 3.4. If field evidence of potentially impacted soil/fill is encountered during intrusive work, the NYSDEC Project Manager will be contacted, and the contractor will be directed to stockpile the material on polyethylene sheeting in an accessible location near the impacted area. The location of staged materials will be coordinated with the Site Owner but will remain within the same Site as the source to avoid administrative issues associated with import/export of these materials among differing BCP Sites. Field evidence of impact is defined as having readily identifiable visual or olfactory signs of contamination, including product, tars, or elevated photoionization detector (PID) readings (i.e., sustained readings >5 parts per million; ppm). All impacted soil/fill removal work will be directed by an experienced QEP. Removal and stockpiling will continue until visually impacted soil/fill is removed from the limits of the planned excavation or NYSDEC agrees that no further removal of soil/fill is required. If the impact extends beyond the proposed limits of the

excavation the Site Owner will be consulted and a plan for delineation and remediation of the remaining impacted material will be developed.

2.2 Stockpile Methods

Excavated soil/fill will be segregated, based on field screening and its status at the time of the excavation work, into material that can be reused as cover (i.e., if cover soil or NYSDEC approved-slag has been placed), non-impacted material that can be returned to the subsurface, and impacted material that requires treatment or off-site disposal. A continuous berm and/or silt fence will be placed around soil/fill stockpiles. Hay bales will be used as needed near catch basins, surface waters, and other discharge points. Stockpiles will be covered with appropriately anchored tarps or poly sheeting. Stockpiles will be routinely inspected at a minimum once each week and after every storm event. Damaged tarp covers will be promptly replaced.

Results of inspections will be recorded in a logbook, maintained with the Site Owner or Owner's representative, and made available for inspection by NYSDEC.

3.0 EXCAVATION, TRANSPORT, DISPOSAL, AND REUSE

3.1 Materials Excavation and Load Out

A QEP, or person under their supervision, will monitor all intrusive work and the excavation and load-out of all excavated material. The Site Owner and its contractors are responsible for safe execution of all intrusive and other work performed under this EWP; however, any entity performing intrusive work on the Site is required to abide by the requirements identified herein. The QEP will investigate the presence of utilities and easements on the Site and determine whether they pose a risk or impediment to the planned work under this EWP.

Loaded vehicles leaving the Site will be appropriately lined, tarped, securely covered, manifested, and placarded in accordance with appropriate Federal, State (NYSDOT), local, and all other applicable transportation requirements.

Locations where vehicles enter or exit the Site shall be inspected daily for evidence of off-site soil tracking. The QEP will be responsible for ensuring that all egress points for truck and equipment transport from the Site are clean of dirt and other materials derived from the Site during intrusive excavation activities. If truck tires will be in contact with impacted materials and/or ground conditions result in mud carryout on vehicles a truck wash will be operated on-site. Truck wash waters will be collected and disposed off-site in an appropriate manner. Cleaning of the adjacent streets will be performed as needed to maintain a clean condition with respect to Site-derived materials.

3.2 Material Transport Off-Site

All transport of materials will be performed by licensed haulers in accordance with appropriate local, State, and Federal regulations, including 6NYCRR Part 364. Haulers will be appropriately licensed and trucks properly placarded.

Material transported by trucks exiting the Site will be secured with tight-fitting covers; loose-fitting canvas-type truck covers are prohibited. If loads contain wet material capable of producing free liquid, truck liners will be used.

Truck transport routes will be pre-determined for wastes designated as hazardous and requiring off-site transport to a secure landfill (RCRA Subtitle C facility) or other RCRA-permitted Treatment Storage and Disposal Facility (TSDF).

All trucks loaded with Site materials will exit the vicinity of the Site using only NYSDEC-approved truck routes. The route will consider (a) limiting transport through residential areas and past sensitive sites; (b) use of city mapped truck routes; (c) prohibiting off-site queuing of trucks entering the facility; (d) limiting total distance to major highways; (e) promoting safety in access to highways; and (f) overall safety in transport. If an alternate RCRA Subtitle C facility or TSDF is employed the corresponding truck transport route shall be provided to the NYSDEC for approval.

Trucks will be prohibited from stopping and idling in the neighborhood outside the Site. Egress points for truck and equipment transport from the Site will be kept clean of dirt and other materials. Queuing of trucks will be performed on-site to minimize off-site disturbance; off-site queuing will be prohibited.

3.3 Materials Disposal Off-Site

All soil/fill/solid waste excavated and removed from the Site will be considered contaminated, regulated material to be transported and treated or disposed at a permitted facility in accordance with all local, State (including 6NYCRR Part 360), and Federal regulations. If alternate off-site disposal of soil/fill from this Site is proposed (e.g., at another regulated brownfield site), a formal request with an associated plan will be made to the NYSDEC. Unregulated off-site management of materials from this Site will not occur without formal NYSDEC approval.

Off-site disposal locations for excavated soils will be identified in the pre-excavation notification. This will include estimated quantities and a breakdown by class of disposal facility (i.e., hazardous waste facility, solid waste landfill, permitted petroleum treatment facility, C/D recycling facility, etc.), if appropriate. The disposal documentation submitted to NYSDEC will include: a summary of disposal quantities, waste profiles, test results, facility acceptance letters, manifests, bills of lading, and facility receipts.

Non-hazardous historic fill and contaminated soils taken off-site will be handled, at minimum, as a municipal solid waste per 6NYCRR Part 360-1.2. Material that does not meet Track 1 unrestricted SCOs is prohibited from being taken to a New York State recycling facility (6NYCRR Part 360-16 Registration Facility).

3.4 Materials Reuse On-Site

3.4.1 Soil/Fill

On-site reuse of soil/fill material is acceptable provided that the material does not exhibit visual or olfactory evidence of contamination and PID measurements of the atmosphere at the soil/fill interface do not exceed 5 ppm above background. The QEP will ensure that procedures defined for materials reuse are followed and that unacceptable material does not remain on-site. On-site material, including historic fill, that is acceptable for re-use on-site will be placed below the engineered cover demarcation layer or impervious surface (if in place at the time of excavation), and will not be reused within a cover soil layer, within landscaping berms, or as backfill for subsurface utility lines.

3.4.2 Petroleum-Impacted Soil/Fill

Petroleum-impacted soil/fill suitable for on-site bioremediation (e.g., materials impacted by non-tarry petroleum hydrocarbons) may be transported, with NYSDEC approval, to a designated portion of the Tecumseh property (specifically one of the Business Parks) for biotreatment. Qualitative assessment of treatment performance will be made based on field assessment of visual and olfactory conditions, with the goal of eliminating gross impacts. Once the soil/fill is considered treated, confirmatory samples will be collected at a frequency of no less than one per 1,000 cubic yards of treated soil/fill. The samples will be analyzed for USEPA Target Compound List (TCL) volatile organic compounds (VOCs) and base-neutral semi-volatile organic compounds (SVOCs) and compared to SCOs to be determined within an action-specific soil biotreatment work plan subject to NYSDEC approval. Once the samples meet these SCOs, the treated soil/fill will be removed and preferably transferred back to the original excavated Site as subgrade material; bioremediated soils will not be considered suitable for use as cover soil. No bioremediated soil/fill will be transported off-site unless deemed necessary due to poor treatment response. In such instance the material will be disposed, with NYSDEC approval, in accordance with Section 3.3.

3.4.3 Debris

Any demolition material proposed for reuse on-site will be sampled for asbestos and the results will be reported to the NYSDEC for acceptance. Concrete crushing or processing on-site will not be performed without prior NYSDEC approval. Organic matter (wood, roots, stumps, etc.) or other solid waste derived from clearing and grubbing of the Site will not be reused on-site without prior NYSDEC approval.

3.4.4 Slag

Slag proposed for reuse on-site will be field screened with a 2x2 meter or equivalent for gamma radiation via test pad. If field-screening measurements are 1.5 times background for the Controlled Property, the slag will be stockpiled and evaluated for TENORM. Background levels for the Controlled Property are approximately 5,000 counts per minute (cpm). Therefore, slag measurements below 7,500 cpm will not require further evaluation for reuse. Screening levels above 7,500 cpm will require submission of an action-specific work plan to address additional screening, sampling, analysis, and handling of elevated radiological material. NYSDEC and NYSDOH will be notified of any screening level exceedances.

Test pads will be constructed on an approximately 5-foot by 5-foot by 1-inch thick steel plate. Slag proposed for reuse will be used to create test pads to evaluate the slag. One test pad will be constructed for every 250 cubic yards of slag proposed for reuse unless a different frequency is approved by NYSDEC.

Slag will be placed on the steel plate in an approximate 6- to 8-inch thick lift. The 5-foot by 5-foot slag placement area will be screened with the 2x2 meter to identify location with the “highest” count rate based on the screening. A 1-minute count measurement will be collected from the highest screening location. If the results are less than 7,500 cpm, no further evaluation is required. If the measurement is greater than 7,500 cpm, a slag sample will be collected from the highest screening location and analyzed for Radium-226 via EPA Method 901.1M (21-day ingrowth). The results of the analysis will be provided to the Department and the decision to reuse the slag and/or its final disposition will be made in consultation with and pursuant to approval by the Department. Slag containing Radium-226 concentrations greater than 5 picocurie per gram will not be allowable for use as backfill or cover on any portion of the Site.

3.5 Fluids Management

All liquids to be removed from the Site, including excavation dewatering and truck wash water, will be verified to be visually free of any product, non-aqueous phase liquid, odor, or other visual indications of impact. In such instance it may be acceptable to discharge such water back to subgrade with prior NYSDEC approval. Generated water exhibiting signs of impact will not be recharged back to the land surface or subsurface of the Site unless treated to render it acceptable for discharge as approved by the NYSDEC.

Water generated during large-scale construction activities proposed for discharge to surface waters (i.e., a local pond, stream, or river) will require a NY State Pollutant Discharge Elimination System (SPDES) permit.

4.0 BACKFILL AND RESTORATION

4.1 Cover Materials

A minimum of 12 inches of NYSDEC-approved cover material (e.g., vegetated soil, stone, or Beneficial Use Determination [BUD]-approved steel slag with NYSDEC approval), where appropriate, will be placed over any unpaved areas of the Site as a component of the final remedy. The upper 6 inches of any soil cover must be of suitable quality to support vegetation. In general, this would be well-graded topsoil with a pH of 5.5 to 7.6, a minimum organic content of 2.5%, and a soluble salt content not greater than 500 ppm. Vegetation must be comprised of grasses or other plantings sufficiently dense to prevent wind and surface water erosion. All imported cover must also meet the criteria identified in Section 4.2.

After the completion of soil removal and any other invasive activities, the cover system will be restored in a manner that complies with the Site Management Plan (SMP) and Final Engineering Report (FER). The demarcation layer will be replaced to provide a visual reference to the top of the remaining in-place material. A change in the type of cover system that existed prior to the excavation (e.g., a soil cover is replaced by asphalt) constitutes a modification of the cover element of the remedy, and a figure showing the modified surface will be included in the subsequent Periodic Review Report (PRR) and in any updates to the SMP.

4.2 Backfill from Off-Site Sources

The criteria under which off-site material may be imported for use as backfill are presented below.

- **Off-Site Soil/Fill:** Off-site soil/fill may be used as backfill provided it originates from: 1) an NYSDEC-approved borrow site; or 2) a known source having no evidence of disposal or releases of hazardous substances, hazardous, toxic, or radioactive wastes, or petroleum. In both instances the imported soil must be tested and demonstrated to meet the criteria shown on Table B-1 in accordance with Appendix 5 of DER-10. In addition, no off-site materials meeting the definition of a solid waste as defined in 6 NYCRR, Part 360-1.2 (a) shall be used as backfill. The criteria presented in Table B-1 represent the lesser of the Commercial Soil Cleanup Objectives (SCOs) or levels protective of groundwater quality as published in 6NYCRR Part 375-6.7(d)(c) and 375-6.8.

- **Other Off-Site Material:** Certain material may be imported as backfill, without chemical testing, provided it contains less than 10% (by weight) material that would pass through a size 80 sieve: 1) Rock or stone, consisting of virgin material from a permitted mine or quarry; 2) steel slag under BUD #555-9-15 with NYSDEC approval; 3) Recycled concrete, brick, or asphalt from a NYSDEC-registered or permitted C&D debris processing facility (as specified in Section 360-16.1 of 6 NYCRR Part 360) that conforms to Section 304 of the New York State Department of Transportation Standard Specifications Construction and Materials Volume 1 (2002). As stated in Section 360-16.4(b)(2), the facility may only accept recognizable, uncontaminated, non-pulverized C&D debris or C&D debris from other authorized C&D processing facilities. According to Section 360-16.2(c), “uncontaminated” means C&D debris that is not mixed or commingled with other solid waste at the point of generation, processing, or disposal, and that is not contaminated with spills of a petroleum product, hazardous waste, or industrial waste.

As indicated above, off-site borrow soils shall be tested to assure conformance with the criteria identified on Table B-1. A tiered approach based on the volume of impacted soil/fill being excavated will be used to determine the frequency of characterization sampling in accordance with DER-10 or as pre-approved by the NYSDEC.

Grab samples will be collected for VOC analysis. For all other required analyses, a minimum of four grab samples will be collected to form a single composite sample. Approximately equal aliquots of the grab samples will be composited in the field using a stainless-steel trowel and bowl. The trowel and bowl shall be decontaminated with a non-phosphate detergent (e.g., Alconox®) and potable water wash solution followed by a distilled water rinse between sampling locations. The soil/fill samples will be analyzed for USEPA Target Compound List (TCL) VOCs, TCL SVOCs, pesticides, PCBs, as well as select metals¹ and cyanide in accordance with USEPA SW-846 Methodology by a NYSDOH ELAP-certified laboratory. Additionally, soil/fill samples will be tested for per- and polyfluoroalkyl substances (PFAS) in accordance with the Department’s latest protocols². Analytical results will be compared to Table B-1 criteria and provided to the NYSDEC as part of the approval process and reported in the PRR. Analytical results must be maintained

¹ Metals shall include those regulated under 6NYCRR Part 375-6.8, which presently include: Arsenic; Barium; Beryllium; Cadmium; Chromium (total and hexavalent forms); Copper; Lead; Manganese; Mercury; Nickel; Selenium; Silver; and Zinc.

² “Sampling, Analysis, and Assessment of Per- And Polyfluoroalkyl Substances (PFAS) Under NYSDEC’s Part 375 Remedial Programs.” January 2021.

on file for review in support of the periodic Institutional and Engineering Control (IC/EC) certification required as part of the final SMP.

Soils that meet 'exempt' fill requirements under 6 NYCRR Part 360, but do not meet backfill or cover soil objectives for this Site, will not be imported onto the Site without prior approval by NYSDEC. Solid waste will not be imported onto the Site.

All materials proposed for import onto the Site will be approved by the QEP and in compliance with the provisions of this EWP prior to receipt at the Site. A Request to Import/Reuse Fill or Soil form³ will be prepared and submitted to the NYSDEC project manager allowing a minimum of 5 business days for review.

Trucks entering the Site with imported soils will be securely covered with tight fitting covers. Imported soils will be stockpiled separately from excavated materials and covered to prevent dust releases.

4.3 Backfill from On-Site Sources

On-site soil/fill may be used as subgrade backfill beneath existing approved cover provided it does not exhibit field evidence of impact. Soil/fill that is bioremediated on-site, or within another designated and approved area within the Tecumseh Business Parks, may be similarly used as subgrade backfill provided it meets the treatment criteria discussed in Section 3.4.2. Slag may be used as subgrade backfill provided it meets the field screening criteria discussed in Section 3.4.4. Backfill material will be compacted with the excavator/backhoe bucket in maximum 2-foot lifts to minimize settling.

³ <http://www.dec.ny.gov/regulations/67386.html>

5.0 MONITORING AND INSPECTIONS

5.1 Stormwater Pollution Prevention

If construction activities disturb more than 1 acre of land, the Federal Water Pollution Control Act (as amended, 33 U.S.C. 1251 et. seq.) and the New York State Environmental Conservation Law (Article 17, Titles 7 and 8, and Article 70) would apply.

With some exceptions, operators of construction activities and property development that will result in the disturbance of 1 or more acres of land must obtain coverage under SPDES General Permit for Stormwater Discharges from Construction Activity (GP-0-20-001, expires 01/28/25) prior to the commencement of soil disturbance. (In the case of a remediation site, such as the Controlled Property, soil disturbances associated with remedial activities are exempt from State-issued permits; however, functional equivalent approvals, mitigation and compliance measures are required). Also requiring a permit are construction activities disturbing less than 1 acre if they are part of a larger common plan of development or sale with a planned disturbance of equal to or greater than 1 acre, or activities that are designated by the NYSDEC. The NYSDEC can require a permit for construction activities disturbing less than 1 acre based on the potential for contribution to a violation of a water quality standard or for significant contribution of pollutants to waters of the United States.

To obtain coverage under the General Permit, the operator of a construction activity must file a completed Notice of Intent (NOI) with the NYSDEC. Submitting a NOI is an affirmation that a Stormwater Pollution Prevention Plan (SWPPP) has been prepared for the site and will be implemented prior to the commencement of construction activities. Coverage under the General Permit will begin either 5 or 60 business days after receipt of a completed NOI by the NYSDEC. Appendix B-1 includes the NOI application form and SPDES General Permit GP-0-20-001.

For smaller disturbances not subject to SPDES General Permit requirements, erosion controls must be installed as necessary to mitigate impacted stormwater and sediment runoff. These controls (which may include silt fencing around stockpiles, berms, and hay bale checks) will be required in areas of disturbance proximate to surface water bodies and drainage structures and will also be required if disturbances occur in areas where the surrounding slag/fill is not sufficiently permeable to allow re-infiltration. Erosion and

sediment controls shall be installed in accordance with the standards and specifications presented in Appendix B-2.

The controls will be installed and inspected once a week and after every storm event. All necessary repairs shall be made immediately. Accumulated sediments will be removed as required to keep the controls functional. All undercutting or erosion of the silt fence toe anchor shall be repaired immediately with appropriate backfill materials. Manufacturer's recommendations will be followed for replacing silt fencing damaged due to weathering. Where discharge locations or points are accessible, they shall be inspected to ascertain whether erosion control measures are effective in preventing significant impacts to receiving waters. Results of inspections will be recorded in a logbook, maintained by the Site Owner or Owner's representative, and made available for inspection by NYSDEC.

5.2 Contingency Plan

If underground tanks or other previously unidentified contaminant sources are found during intrusive activities, excavation activities will be suspended until sufficient equipment is mobilized to address the condition.

Sampling will be performed on product, sediment, and surrounding soils as necessary to determine the nature of the material and proper disposal method. Chemical analysis will be performed for a comprehensive list of analytes (RCRA metals, TCL VOCs, SVOCs, and PCBs, and cyanide), unless the Site history and previous sampling results provide a sufficient justification to limit the list of analytes. In this case, a reduced list of analytes will be proposed to the NYSDEC for approval.

Identification of unknown or unexpected contaminated media identified by screening during intrusive activities will be promptly communicated by phone to NYSDEC's Project Manager. Reportable quantities of petroleum product will also be reported to the NYSDEC spills hotline.

5.3 Community Air Monitoring Plan

As detailed in Appendix B-3, the following criteria shall also be adhered to during intrusive activities for the protection of the nearby community.

5.3.1 Organic Vapor Community Air Monitoring:

Community air monitoring will be performed at the downwind perimeter of the exclusion zone on a continuous basis during intrusive activities performed outdoors that may be reasonably expected to potentially release organic vapors, or when sustained readings are detected in the work zone (i.e., proximate to the source of the intrusive activity). Otherwise, the monitoring will be performed on an hourly basis. A photoionization detector (PID), or other equipment suitable to the types of contaminants known or suspected to be present, capable of calculating 15-minute running average concentrations will be used. All air monitoring equipment will be calibrated at least daily, and an upwind concentration will be taken at least daily to establish background conditions. The 15-minute average concentrations will be compared to the levels specified below.

- If the 15-minute ambient air concentration of organic vapors at the downwind perimeter of the exclusion zone exceeds 5 ppm above background, work activities will be halted and monitoring continued. If the organic vapor decreases (per instantaneous readings) below 5 ppm over background, work activities can resume with continued monitoring.
- If the ambient air concentration of organic vapors at the downwind perimeter of the exclusion zone persists at levels above 5 ppm over background but less than 25 ppm, activities must be halted, the source of vapors identified, corrective actions to abate the emissions taken, and monitoring continued. After these steps, work activities can resume provided that: the organic vapor level 200 feet downwind of the exclusion zone or half the distance to the nearest off-site potential receptor or residential or commercial structure, whichever is less (but in no case less than 20 feet), is below 5 ppm over background for the 15-minute average.
- If the organic vapor level is above 25 ppm at the perimeter of the exclusion zone, work activities must be shut down and the following activities will be performed:
 - All Emergency Response Contacts as listed in the HASP (Ref. 2) and the Emergency Response Plan (an appendix to the HASP) will be advised.
 - The local police authorities will immediately be contacted by the Site Health and Safety Officer and advised of the situation.
 - Air monitoring will be continued at ½ the distance from the exclusion zone to the nearest receptor.

All readings will be recorded and will be available for NYSDEC and NYSDOH personnel to review.

5.3.2 Explosive Vapor Community Air Monitoring

Explosive vapor community air monitoring will be performed at the downwind perimeter of the site on a continuous basis whenever sustained atmospheric concentrations of greater than 10% of the LEL are recorded in the exclusion zone. If sustained atmospheric concentrations of greater than 10% LEL are recorded at the downwind site perimeter, the local Fire Department will be contacted.

5.3.3 Airborne Particulate Community Air Monitoring

Respirable (PM-10) particulate monitoring will be performed on a continuous basis at the upwind and downwind perimeter of the exclusion zone. The monitoring will be performed using real-time monitoring equipment capable of measuring PM-10 and integrating over a period of 15-minutes for comparison to the airborne particulate action levels. The equipment will be equipped with an audible alarm to indicate exceedance of the action level. In addition, fugitive dust migration will be visually assessed during all work activities. All readings will be recorded and will be available for NYSDEC and NYSDOH review. Readings will be interpreted as follows:

- If the downwind PM-10 particulate level is 100 micrograms per cubic meter (ug/m^3) greater than the background (upwind perimeter) reading for the 15-minute period or if airborne dust is observed leaving the work area, then dust suppression techniques must be employed. Work may continue with dust suppression provided that the downwind PM-10 particulate levels do not exceed $150 \text{ ug}/\text{m}^3$ above the upwind level and that visible dust is not migrating from the work area.

If after implementation of dust suppression techniques, downwind PM-10 levels are greater than $150 \text{ ug}/\text{m}^3$ above the upwind level, work activities must be stopped, and dust suppression controls re-evaluated. Work can resume provided that supplemental dust suppression measures and/or other controls are successful in reducing the downwind PM-10 particulate concentration to within $150 \text{ ug}/\text{m}^3$ of the upwind level and in preventing visible dust migration.

Air sampling stations will be located based on generally prevailing wind conditions. These locations will be adjusted on a daily or more frequent basis based on actual wind directions to provide an upwind and at least two downwind monitoring stations.

Exceedances of action levels listed in the CAMP will be reported to NYSDEC and NYSDOH Project Managers.

5.3.4 Special Requirements

Ground intrusive activities within 20 feet of occupied structures or potential receptors (e.g., public roadways, sidewalks, etc.) should consider the following:

- Continuous monitoring locations should reflect the nearest potentially exposed individuals and vapor pathways (openings, conduits, vents, etc.).
- Take background readings in the occupied spaces prior to commencement of planned work.
- Consider use of engineering controls such as vapor/dust barriers, exhaust fans, or other controls to create negative air pressure within the work area.
- The planned work should be implemented during hours when building occupancy is at a minimum.

5.4 Odor Control Plan

The purpose of this odor control plan is to control emissions of nuisance odors off-site. Specific odor control methods to be used on a routine basis are described below. If nuisance odors are identified at the Site boundary, or if odor complaints are received, work will be halted, and the source of odors will be identified and corrected. Work will not resume until all nuisance odors have been abated. NYSDEC and NYSDOH will be notified of all odor events and of any other complaints about the project. Implementation of all odor controls, including the halt of work, is the responsibility of the associated Site Owner, and any measures that are implemented will be documented.

All necessary means will be employed to prevent on- and off-site nuisances. At a minimum, these measures will include: (a) limiting the area of open excavations and size of soil stockpiles; (b) shrouding open excavations with tarps and other covers; and (c) using foams to cover exposed odorous soils. If odors develop and cannot be otherwise controlled, additional means to eliminate odor nuisances will include: (d) direct load-out of soils to trucks for off-site disposal; (e) use of chemical odorants in spray or misting systems; and (f) use of staff to monitor odors in surrounding neighborhoods.

If nuisance odors develop during intrusive work that cannot be corrected, or where the control of nuisance odors cannot otherwise be achieved due to on-site conditions or

proximity to sensitive receptors, odor control will be achieved by sheltering the excavation and handling areas in a temporary containment structure equipped with appropriate air venting/filtering systems.

5.5 Dust Control Plan

Particulate monitoring will be performed along the downwind perimeter of the Site during subgrade excavation, grading, and handling activities in accordance with the requirements for community air monitoring at remediation sites as established by the NYSDOH and NYSDEC. Accordingly, it follows procedures and practices outlined under DER-10 Appendix 1A (NYSDOH's Generic Community Air Monitoring Plan) and Appendix 1B (Fugitive Dust and Particulate Monitoring) both included as Appendix B-3. Dust suppression techniques will be employed as necessary to mitigate fugitive dust from non-vegetated or disturbed soil/fill during post-remediation construction and redevelopment.

A dust suppression plan that addresses dust management during intrusive on-site work will include, at a minimum, the items listed below:

- Dust suppression will be achieved by using a dedicated on-site water truck for road wetting. The truck will be equipped with a water cannon capable of spraying water directly onto off-road areas including excavations and stockpiles.
- Clearing and grubbing of larger sites will be done in stages to limit the area of exposed, unvegetated soils vulnerable to dust production.
- Gravel will be used on roadways to provide a clean and dust-free road surface.
- On-site roads will be limited in total area to minimize the area required for water truck sprinkling.
- Hauling materials in properly tarped containers or vehicles.
- Restricting vehicle speeds on-site.
- Covering or proof-rolling excavated areas and materials after excavation activity ceases.
- Reducing the excavation size and/or number of excavations.

All reasonable attempts will be made to keep visible and/or fugitive dust to a minimum.

5.6 Other Nuisances

A plan will be developed and used by the contractor for all remedial work to ensure compliance with local noise control ordinances. At a minimum, this shall include limiting construction to typical daylight work hours.

6.0 REFERENCES

1. New York State Department of Environmental Conservation. *DEC Program Policy DER-10/Technical Guidance for Site Investigation and Remediation*. May 3, 2010.
2. TurnKey Environmental Restoration, LLC in affiliation with Benchmark Environmental Engineering & Science, PLLC, *Site-Wide Health and Safety Plan (HASP)*. *Tecumseh Redevelopment Site, Lackawanna, NY*. April 2010.

TABLES



TABLE B-1

CRITERIA FOR IMPORTED SOILS

**Site Management Plan
Tecumseh Phase II Business Park
Lackawanna, New York**

Parameter	Cover Soil Criteria¹
Volatile Organic Compounds (mg/kg)	
1,1,1-Trichloroethane	0.68
1,1-Dichloroethane	0.27
1,1-Dichloroethene	0.33
1,2-Dichlorobenzene	1.1
1,2-Dichloroethane	0.02
1,2-Dichloroethene(cis)	0.25
1,2-Dichloroethene(trans)	0.19
1,3-Dichlorobenzene	2.4
1,4-Dichlorobenzene	1.8
1,4-Dioxane	0.1
Acetone	0.05
Benzene	0.06
Butylbenzene	12
Carbon tetrachloride	0.76
Chlorobenzene	1.1
Chloroform	0.37
Ethylbenzene	1
Hexachlorobenzene	3.2
Methyl ethyl ketone	0.12
Methyl tert-butyl ether	0.93
Methylene chloride	0.05
Propylbenzene-n	3.9
Sec-Butylbenzene	11
Tert-Butylbenzene	5.9
Tetrachloroethene	1.3
Toluene	0.7
Trichloroethene	0.47



TABLE B-1

CRITERIA FOR IMPORTED SOILS

**Site Management Plan
Tecumseh Phase II Business Park
Lackawanna, New York**

Parameter	Cover Soil Criteria¹
Volatile Organic Compounds (mg/kg)	
Trimethylbenzene-1,2,4	3.6
Trimethylbenzene-1,3,5	8.4
Vinyl chloride	0.02
Xylene (mixed)	1.6
Semi-Volatile Organic Compounds (mg/kg)	
Acenaphthene	98
Acenaphthylene	107
Anthracene	500
Benzo(a)anthracene	1
Benzo(a)pyrene	1
Benzo(b)fluoranthene	1.7
Benzo(g,h,i)perylene	500
Benzo(k)fluoranthene	1.7
Chrysene	1
Dibenz(a,h)anthracene	0.56
Fluoranthene	500
Fluorene	386
Indeno(1,2,3-cd)pyrene	5.6
m-Cresol(s)	0.33
Naphthalene	12
o-Cresol(s)	0.33
p-Cresol(s)	0.33
Pentachlorophenol	0.8
Phenanthrene	500
Phenol	0.33
Pyrene	500



TABLE B-1

CRITERIA FOR IMPORTED SOILS

**Site Management Plan
Tecumseh Phase II Business Park
Lackawanna, New York**

Parameter	Cover Soil Criteria¹
Metals (mg/kg)	
Arsenic	16
Barium	400
Beryllium	47
Cadmium	7.5
Chromium, Hexavalent ²	19
Chromium, Trivalent ²	1500
Copper	270
Cyanide	27
Lead	450
Manganese	2000
Mercury (total)	0.73
Nickel	130
Selenium	4
Silver	8.3
Zinc	2480
PCBs/Pesticides (mg/kg)	
2,4,5-TP Acid (Silvex)	3.8
4,4'-DDE	17
4,4'-DDT	47
4,4'-DDD	14
Aldrin	0.19
Alpha-BHC	0.02
Beta-BHC	0.09
Chlordane (alpha)	2.9
Delta-BHC	0.25
Dibenzofuran	210
Dieldrin	0.1
Endosulfan I	102



TABLE B-1

CRITERIA FOR IMPORTED SOILS

**Site Management Plan
Tecumseh Phase II Business Park
Lackawanna, New York**

Parameter	Cover Soil Criteria ¹
PCBs/Pesticides (mg/kg)	
Endosulfan II	102
Endosulfan sulfate	200
Endrin	0.06
Heptachlor	0.38
Lindane	0.1
Polychlorinated biphenyls	1
Per- and Polyfluoroalkyl Substances (ug/kg)	
Perfluorooctanoic acid (PFOA)	1.1
Perfluorooctanesulfonic acid (PFOS)	3.7

Notes:

- ¹ Soil criteria are lesser of concentrations protective of groundwater or commercial health-based soil cleanup objectives per 6 NYCRR 375-6.8(b).
- ² The SCO for Hexavalent or Trivalent Chromium is considered to be met if the analysis for the total species of this contaminant is below the specific SCO for Hexavalent Chromium.

FIGURES

FIGURE 1



DeLORME
 © 2002 DeLorme, 3-D TopoQuads®. Data copyright of content owner.
 www.delorme.com



2558 HAMBURG TURNPIKE
 SUITE 300
 BUFFALO, NY 14218
 (716) 856-0635

SITE LOCATION AND VICINITY MAP
 SITE MANAGEMENT PLAN
 PHASE II BUSINESS PARK
 LACKAWANNA, NEW YORK

PROJECT NO.: 0071-012-322

DATE: JULY 2012

DRAFTED BY: HAA

P:\CD\Turnkey\Turnkey Remediation\Shared\Concept Plan\CD\Phase II\Phase II Remediation Management Plan\Appendix B\Figure 2_Site Delineation Map.dwg, 2/27/2021 2:46:17 PM

PLAN VIEW:
 SCALE 1" = 2000'

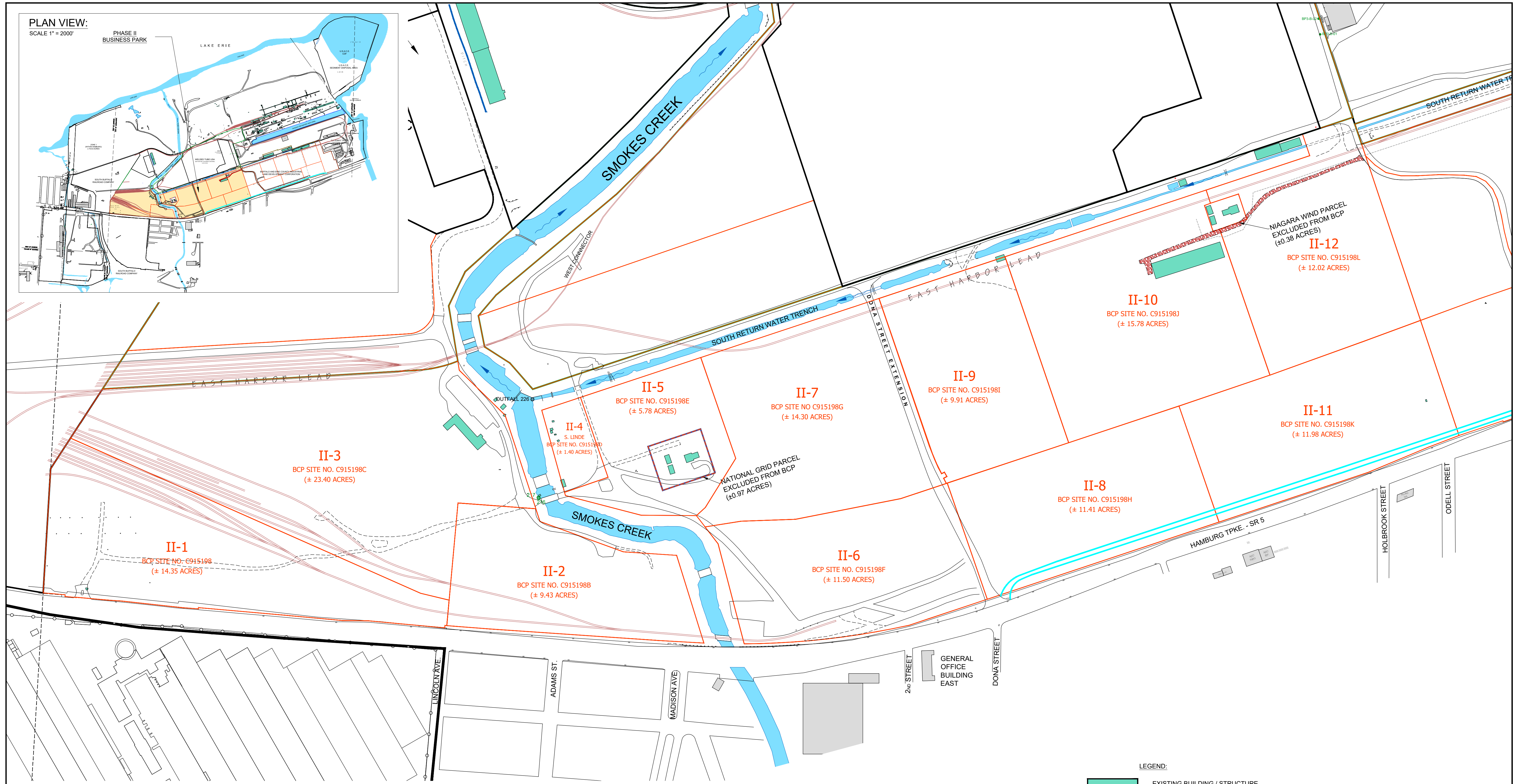
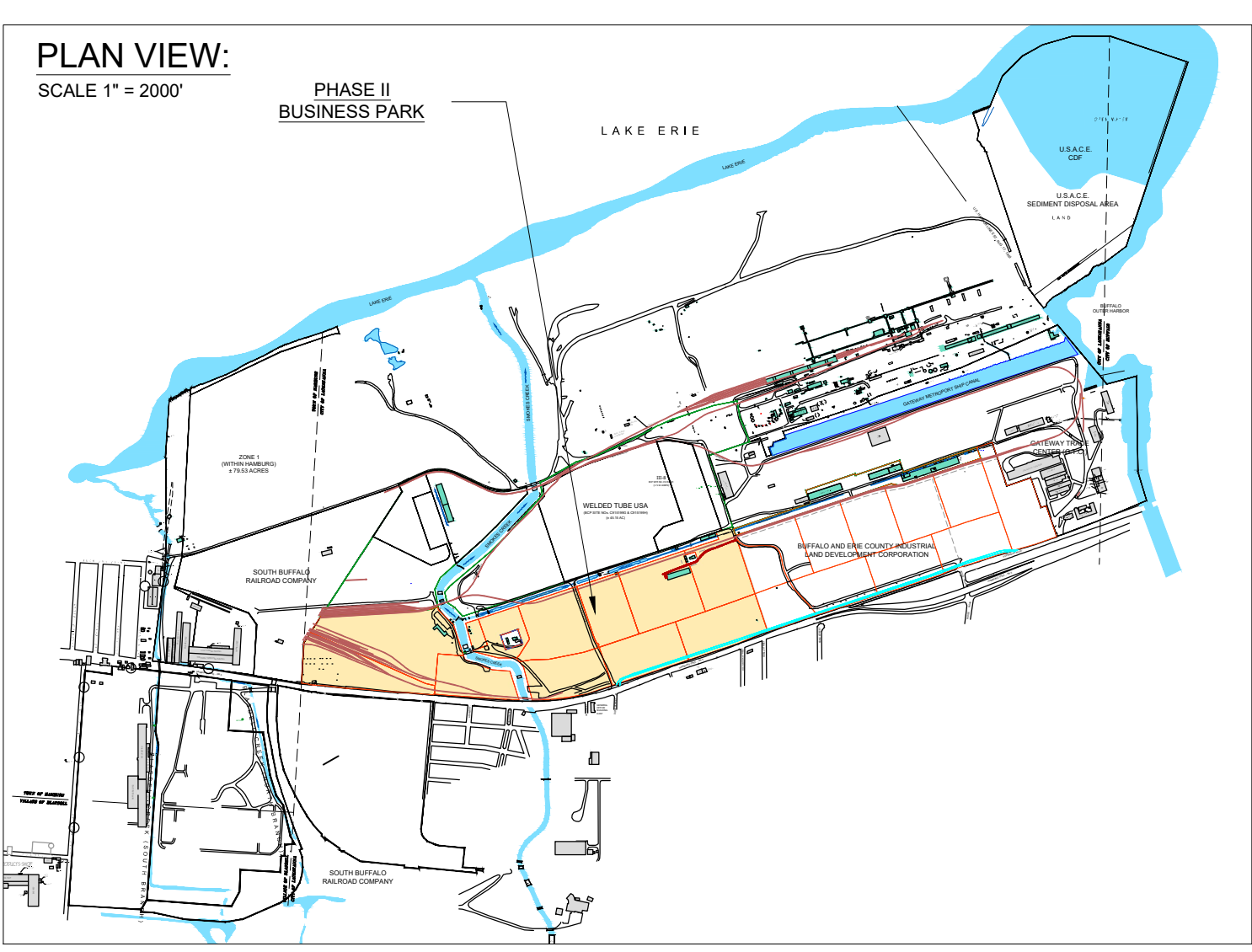

- LEGEND:**
- EXISTING BUILDING / STRUCTURE
 - PHASE II BUSINESS PARK BOUNDARY (+/- 141.26 ACRES)
 - RAILROAD TRACK

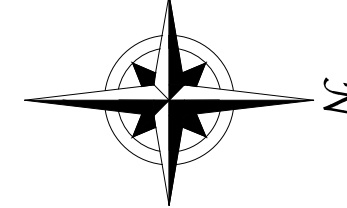

SCALE: 1 INCH = 200 FEET
 SCALE IN FEET
 (approximate)

Parcel Identification	BCP Site No.	Area (Acres)
II-1	C915198	14.35
II-2	C915198B	9.43
II-3	C915198C	23.40
II-4	C915198D	1.40
II-5	C915198E	5.78
II-6	C915198F	11.50
II-7	C915198G	14.30
II-8	C915198H	11.41
II-9	C915198I	9.91
II-10	C915198J	15.78
II-11	C915198K	11.98
II-12	C915198L	12.02
Total Area Phase II Business Park		141.26

255B HAMBURG TURNPIKE
 SUITE 100
 LACKAWANNA, NY 14218
 (716) 856-0635
 JOB NO.: 0071-012-322

REVISIONS	
NO.	DATE

NO.	BY	DATE	REMARKS

DRAWN BY: RFL
 DATE: JUNE 2021
 CHECKED BY: LR
 APPROVED BY: THF

 DISCLAIMER: BENCHMARK RES, PLLC, IMPORTANT: THIS DRAWING PRINT IS LOANED FOR MUTUAL ASSISTANCE AND AS SUCH IS SUBJECT TO BENCHMARK'S POLICY OF CONFIDENTIALITY. IT IS NOT TO BE DISCLOSED OR REPRODUCED IN ANY MANNER WITHOUT THE WRITTEN CONSENT OF BENCHMARK RES, PLLC.

SITE DELINEATION MAP
 SITE MANAGEMENT PLAN
 PHASE II BUSINESS PARK
 LACKAWANNA, NEW YORK
 TECUMSEH REDEVELOPMENT INC.

FIGURE 2

APPENDIX B-1

SPDES GENERAL PERMIT GP-0-20-001 NOTICE OF INTENT



Department of
Environmental
Conservation

NEW YORK STATE
DEPARTMENT OF ENVIRONMENTAL CONSERVATION

SPDES GENERAL PERMIT
FOR STORMWATER DISCHARGES

From

CONSTRUCTION ACTIVITY

Permit No. GP- 0-20-001

Issued Pursuant to Article 17, Titles 7, 8 and Article 70
of the Environmental Conservation Law

Effective Date: January 29, 2020

Expiration Date: January 28, 2025

John J. Ferguson

Chief Permit Administrator

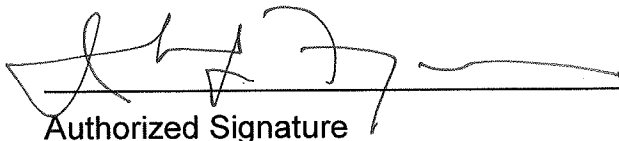

Authorized Signature

1-23-20

Date

Address: NYS DEC
Division of Environmental Permits
625 Broadway, 4th Floor
Albany, N.Y. 12233-1750

PREFACE

Pursuant to Section 402 of the Clean Water Act (“CWA”), stormwater *discharges* from certain *construction activities* are unlawful unless they are authorized by a *National Pollutant Discharge Elimination System (“NPDES”)* permit or by a state permit program. New York administers the approved State Pollutant Discharge Elimination System (SPDES) program with permits issued in accordance with the New York State Environmental Conservation Law (ECL) Article 17, Titles 7, 8 and Article 70.

An *owner or operator* of a *construction activity* that is eligible for coverage under this permit must obtain coverage prior to the *commencement of construction activity*. Activities that fit the definition of “*construction activity*”, as defined under 40 CFR 122.26(b)(14)(x), (15)(i), and (15)(ii), constitute construction of a *point source* and therefore, pursuant to ECL section 17-0505 and 17-0701, the *owner or operator* must have coverage under a SPDES permit prior to *commencing construction activity*. The *owner or operator* cannot wait until there is an actual *discharge* from the *construction site* to obtain permit coverage.

***Note: The italicized words/phrases within this permit are defined in Appendix A.**

**NEW YORK STATE DEPARTMENT OF ENVIRONMENTAL CONSERVATION
SPDES GENERAL PERMIT FOR STORMWATER DISCHARGES FROM
CONSTRUCTION ACTIVITIES**

Table of Contents

Part 1. PERMIT COVERAGE AND LIMITATIONS	1
A. Permit Application	1
B. Effluent Limitations Applicable to Discharges from Construction Activities	1
C. Post-construction Stormwater Management Practice Requirements	4
D. Maintaining Water Quality	8
E. Eligibility Under This General Permit.....	9
F. Activities Which Are Ineligible for Coverage Under This General Permit	9
Part II. PERMIT COVERAGE	12
A. How to Obtain Coverage	12
B. Notice of Intent (NOI) Submittal	13
C. Permit Authorization	13
D. General Requirements For Owners or Operators With Permit Coverage	15
E. Permit Coverage for Discharges Authorized Under GP-0-15-002.....	17
F. Change of Owner or Operator	17
Part III. STORMWATER POLLUTION PREVENTION PLAN (SWPPP).....	18
A. General SWPPP Requirements	18
B. Required SWPPP Contents	20
C. Required SWPPP Components by Project Type.....	24
Part IV. INSPECTION AND MAINTENANCE REQUIREMENTS	24
A. General Construction Site Inspection and Maintenance Requirements	24
B. Contractor Maintenance Inspection Requirements	24
C. Qualified Inspector Inspection Requirements	25
Part V. TERMINATION OF PERMIT COVERAGE	29
A. Termination of Permit Coverage	29
Part VI. REPORTING AND RETENTION RECORDS	31
A. Record Retention	31
B. Addresses	31
Part VII. STANDARD PERMIT CONDITIONS.....	31
A. Duty to Comply.....	31
B. Continuation of the Expired General Permit.....	32
C. Enforcement.....	32
D. Need to Halt or Reduce Activity Not a Defense.....	32
E. Duty to Mitigate	33
F. Duty to Provide Information.....	33
G. Other Information	33
H. Signatory Requirements.....	33
I. Property Rights	35
J. Severability.....	35

K.	Requirement to Obtain Coverage Under an Alternative Permit.....	35
L.	Proper Operation and Maintenance	36
M.	Inspection and Entry	36
N.	Permit Actions	37
O.	Definitions	37
P.	Re-Opener Clause	37
Q.	Penalties for Falsification of Forms and Reports.....	37
R.	Other Permits	38
APPENDIX A – Acronyms and Definitions		39
	Acronyms.....	39
	Definitions.....	40
APPENDIX B – Required SWPPP Components by Project Type		48
	Table 1.....	48
	Table 2.....	50
APPENDIX C – Watersheds Requiring Enhanced Phosphorus Removal.....		52
APPENDIX D – Watersheds with Lower Disturbance Threshold		58
APPENDIX E – 303(d) Segments Impaired by Construction Related Pollutant(s)		59
APPENDIX F – List of NYS DEC Regional Offices		65

Part 1. PERMIT COVERAGE AND LIMITATIONS

A. Permit Application

This permit authorizes stormwater *discharges to surface waters of the State* from the following *construction activities* identified within 40 CFR Parts 122.26(b)(14)(x), 122.26(b)(15)(i) and 122.26(b)(15)(ii), provided all of the eligibility provisions of this permit are met:

1. *Construction activities* involving soil disturbances of one (1) or more acres; including disturbances of less than one acre that are part of a *larger common plan of development or sale* that will ultimately disturb one or more acres of land; excluding *routine maintenance activity* that is performed to maintain the original line and grade, hydraulic capacity or original purpose of a facility;
2. *Construction activities* involving soil disturbances of less than one (1) acre where the Department has determined that a *SPDES* permit is required for stormwater *discharges* based on the potential for contribution to a violation of a *water quality standard* or for significant contribution of *pollutants to surface waters of the State*.
3. *Construction activities* located in the watershed(s) identified in Appendix D that involve soil disturbances between five thousand (5,000) square feet and one (1) acre of land.

B. Effluent Limitations Applicable to Discharges from Construction Activities

Discharges authorized by this permit must achieve, at a minimum, the effluent limitations in Part I.B.1. (a) – (f) of this permit. These limitations represent the degree of effluent reduction attainable by the application of best practicable technology currently available.

1. Erosion and Sediment Control Requirements - The *owner or operator* must select, design, install, implement and maintain control measures to *minimize the discharge of pollutants* and prevent a violation of the *water quality standards*. The selection, design, installation, implementation, and maintenance of these control measures must meet the non-numeric effluent limitations in Part I.B.1.(a) – (f) of this permit and be in accordance with the New York State Standards and Specifications for Erosion and Sediment Control, dated November 2016, using sound engineering judgment. Where control measures are not designed in conformance with the design criteria included in the technical standard, the *owner or operator* must include in the *Stormwater Pollution Prevention Plan* (“SWPPP”) the reason(s) for the

deviation or alternative design and provide information which demonstrates that the deviation or alternative design is *equivalent* to the technical standard.

- a. **Erosion and Sediment Controls.** Design, install and maintain effective erosion and sediment controls to *minimize* the *discharge of pollutants* and prevent a violation of the *water quality standards*. At a minimum, such controls must be designed, installed and maintained to:
- (i) *Minimize* soil erosion through application of runoff control and soil stabilization control measure to *minimize pollutant discharges*;
 - (ii) Control stormwater *discharges*, including both peak flowrates and total stormwater volume, to *minimize* channel and *streambank* erosion and scour in the immediate vicinity of the *discharge* points;
 - (iii) *Minimize* the amount of soil exposed during *construction activity*;
 - (iv) *Minimize* the disturbance of *steep slopes*;
 - (v) *Minimize* sediment *discharges* from the site;
 - (vi) Provide and maintain *natural buffers* around surface waters, direct stormwater to vegetated areas and maximize stormwater infiltration to reduce *pollutant discharges*, unless *infeasible*;
 - (vii) *Minimize* soil compaction. Minimizing soil compaction is not required where the intended function of a specific area of the site dictates that it be compacted;
 - (viii) Unless *infeasible*, preserve a sufficient amount of topsoil to complete soil restoration and establish a uniform, dense vegetative cover; and
 - (ix) *Minimize* dust. On areas of exposed soil, *minimize* dust through the appropriate application of water or other dust suppression techniques to control the generation of pollutants that could be discharged from the site.
- b. **Soil Stabilization.** In areas where soil disturbance activity has temporarily or permanently ceased, the application of soil stabilization measures must be initiated by the end of the next business day and completed within fourteen (14) days from the date the current soil disturbance activity ceased. For construction sites that *directly discharge* to one of the 303(d) segments

listed in Appendix E or is located in one of the watersheds listed in Appendix C, the application of soil stabilization measures must be initiated by the end of the next business day and completed within seven (7) days from the date the current soil disturbance activity ceased. See Appendix A for definition of *Temporarily Ceased*.

- c. **Dewatering.** *Discharges* from *dewatering* activities, including *discharges* from *dewatering* of trenches and excavations, must be managed by appropriate control measures.

- d. **Pollution Prevention Measures.** Design, install, implement, and maintain effective pollution prevention measures to *minimize* the *discharge* of *pollutants* and prevent a violation of the *water quality standards*. At a minimum, such measures must be designed, installed, implemented and maintained to:
 - (i) *Minimize* the *discharge* of *pollutants* from equipment and vehicle washing, wheel wash water, and other wash waters. This applies to washing operations that use clean water only. Soaps, detergents and solvents cannot be used;

 - (ii) *Minimize* the exposure of building materials, building products, construction wastes, trash, landscape materials, fertilizers, pesticides, herbicides, detergents, sanitary waste, hazardous and toxic waste, and other materials present on the site to precipitation and to stormwater. Minimization of exposure is not required in cases where the exposure to precipitation and to stormwater will not result in a *discharge* of *pollutants*, or where exposure of a specific material or product poses little risk of stormwater contamination (such as final products and materials intended for outdoor use) ; and

 - (iii) Prevent the *discharge* of *pollutants* from spills and leaks and implement chemical spill and leak prevention and response procedures.

- e. **Prohibited Discharges.** The following *discharges* are prohibited:
 - (i) Wastewater from washout of concrete;

 - (ii) Wastewater from washout and cleanout of stucco, paint, form release oils, curing compounds and other construction materials;

- (iii) Fuels, oils, or other *pollutants* used in vehicle and equipment operation and maintenance;
 - (iv) Soaps or solvents used in vehicle and equipment washing; and
 - (v) Toxic or hazardous substances from a spill or other release.
- f. Surface Outlets. When discharging from basins and impoundments, the outlets shall be designed, constructed and maintained in such a manner that sediment does not leave the basin or impoundment and that erosion at or below the outlet does not occur.

C. Post-construction Stormwater Management Practice Requirements

1. The *owner or operator* of a *construction activity* that requires post-construction stormwater management practices pursuant to Part III.C. of this permit must select, design, install, and maintain the practices to meet the *performance criteria* in the New York State Stormwater Management Design Manual (“Design Manual”), dated January 2015, using sound engineering judgment. Where post-construction stormwater management practices (“SMPs”) are not designed in conformance with the *performance criteria* in the Design Manual, the *owner or operator* must include in the SWPPP the reason(s) for the deviation or alternative design and provide information which demonstrates that the deviation or alternative design is *equivalent* to the technical standard.
2. The *owner or operator* of a *construction activity* that requires post-construction stormwater management practices pursuant to Part III.C. of this permit must design the practices to meet the applicable *sizing criteria* in Part I.C.2.a., b., c. or d. of this permit.

a. Sizing Criteria for New Development

- (i) Runoff Reduction Volume (“RRv”): Reduce the total Water Quality Volume (“WQv”) by application of RR techniques and standard SMPs with RRv capacity. The total WQv shall be calculated in accordance with the criteria in Section 4.2 of the Design Manual.
- (ii) Minimum RRv and Treatment of Remaining Total WQv: Construction activities that cannot meet the criteria in Part I.C.2.a.(i) of this permit due to site limitations shall direct runoff from all newly constructed impervious areas to a RR technique or standard SMP with RRv capacity unless infeasible. The specific site limitations that prevent the reduction of 100% of the WQv shall be documented in the SWPPP.

For each impervious area that is not directed to a RR technique or standard SMP with RRv capacity, the SWPPP must include documentation which demonstrates that all options were considered and for each option explains why it is considered infeasible.

In no case shall the runoff reduction achieved from the newly constructed impervious areas be less than the Minimum RRv as calculated using the criteria in Section 4.3 of the Design Manual.

The remaining portion of the total WQv that cannot be reduced shall be treated by application of standard SMPs.

- (iii) Channel Protection Volume (“Cpv”): Provide 24 hour extended detention of the post-developed 1-year, 24-hour storm event; remaining after runoff reduction. The Cpv requirement does not apply when:
 - (1) Reduction of the entire Cpv is achieved by application of runoff reduction techniques or infiltration systems, or
 - (2) The site discharges directly to tidal waters, or fifth order or larger streams.

- (iv) *Overbank* Flood Control Criteria (“Qp”): Requires storage to attenuate the post-development 10-year, 24-hour peak discharge rate (Qp) to predevelopment rates. The Qp requirement does not apply when:
 - (1) the site discharges directly to tidal waters or fifth order or larger streams, or
 - (2) A downstream analysis reveals that *overbank* control is not required.

- (v) Extreme Flood Control Criteria (“Qf”): Requires storage to attenuate the post-development 100-year, 24-hour peak discharge rate (Qf) to predevelopment rates. The Qf requirement does not apply when:
 - (1) the site discharges directly to tidal waters or fifth order or larger streams, or
 - (2) A downstream analysis reveals that *overbank* control is not required.

b. Sizing Criteria for New Development in Enhanced Phosphorus Removal Watershed

- (i) Runoff Reduction Volume (RRv): Reduce the total Water Quality Volume (WQv) by application of RR techniques and standard SMPs with RRv capacity. The total WQv is the runoff volume from the 1-year, 24 hour design storm over the post-developed watershed and shall be

calculated in accordance with the criteria in Section 10.3 of the Design Manual.

- (ii) Minimum RRv and Treatment of Remaining Total WQv: *Construction activities* that cannot meet the criteria in Part I.C.2.b.(i) of this permit due to *site limitations* shall direct runoff from all newly constructed *impervious areas* to a RR technique or standard SMP with RRv capacity unless *infeasible*. The specific *site limitations* that prevent the reduction of 100% of the WQv shall be documented in the SWPPP. For each *impervious area* that is not directed to a RR technique or standard SMP with RRv capacity, the SWPPP must include documentation which demonstrates that all options were considered and for each option explains why it is considered *infeasible*.

In no case shall the runoff reduction achieved from the newly constructed *impervious areas* be less than the Minimum RRv as calculated using the criteria in Section 10.3 of the Design Manual. The remaining portion of the total WQv that cannot be reduced shall be treated by application of standard SMPs.

- (iii) Channel Protection Volume (Cpv): Provide 24 hour extended detention of the post-developed 1-year, 24-hour storm event; remaining after runoff reduction. The Cpv requirement does not apply when:
 - (1) Reduction of the entire Cpv is achieved by application of runoff reduction techniques or infiltration systems, or
 - (2) The site *discharges* directly to tidal waters, or fifth order or larger streams.
- (iv) *Overbank* Flood Control Criteria (Qp): Requires storage to attenuate the post-development 10-year, 24-hour peak *discharge* rate (Qp) to predevelopment rates. The Qp requirement does not apply when:
 - (1) the site *discharges* directly to tidal waters or fifth order or larger streams, or
 - (2) A downstream analysis reveals that *overbank* control is not required.
- (v) Extreme Flood Control Criteria (Qf): Requires storage to attenuate the post-development 100-year, 24-hour peak *discharge* rate (Qf) to predevelopment rates. The Qf requirement does not apply when:
 - (1) the site *discharges* directly to tidal waters or fifth order or larger streams, or
 - (2) A downstream analysis reveals that *overbank* control is not required.

c. Sizing Criteria for Redevelopment Activity

- (i) Water Quality Volume (WQv): The WQv treatment objective for *redevelopment activity* shall be addressed by one of the following options. *Redevelopment activities* located in an Enhanced Phosphorus Removal Watershed (see Part III.B.3. and Appendix C of this permit) shall calculate the WQv in accordance with Section 10.3 of the Design Manual. All other *redevelopment activities* shall calculate the WQv in accordance with Section 4.2 of the Design Manual.
- (1) Reduce the existing *impervious cover* by a minimum of 25% of the total disturbed, *impervious area*. The Soil Restoration criteria in Section 5.1.6 of the Design Manual must be applied to all newly created pervious areas, or
 - (2) Capture and treat a minimum of 25% of the WQv from the disturbed, *impervious area* by the application of standard SMPs; or reduce 25% of the WQv from the disturbed, *impervious area* by the application of RR techniques or standard SMPs with RRv capacity., or
 - (3) Capture and treat a minimum of 75% of the WQv from the disturbed, *impervious area* as well as any additional runoff from tributary areas by application of the alternative practices discussed in Sections 9.3 and 9.4 of the Design Manual., or
 - (4) Application of a combination of 1, 2 and 3 above that provide a weighted average of at least two of the above methods. Application of this method shall be in accordance with the criteria in Section 9.2.1(B) (IV) of the Design Manual.

If there is an existing post-construction stormwater management practice located on the site that captures and treats runoff from the *impervious area* that is being disturbed, the WQv treatment option selected must, at a minimum, provide treatment equal to the treatment that was being provided by the existing practice(s) if that treatment is greater than the treatment required by options 1 – 4 above.

- (ii) Channel Protection Volume (Cpv): Not required if there are no changes to hydrology that increase the *discharge* rate from the project site.
- (iii) *Overbank* Flood Control Criteria (Qp): Not required if there are no changes to hydrology that increase the *discharge* rate from the project site.
- (iv) Extreme Flood Control Criteria (Qf): Not required if there are no changes to hydrology that increase the *discharge* rate from the project site

d. Sizing Criteria for Combination of Redevelopment Activity and New Development

Construction projects that include both New Development and Redevelopment Activity shall provide post-construction stormwater management controls that meet the sizing criteria calculated as an aggregate of the Sizing Criteria in Part I.C.2.a. or b. of this permit for the New Development portion of the project and Part I.C.2.c of this permit for Redevelopment Activity portion of the project.

D. Maintaining Water Quality

The Department expects that compliance with the conditions of this permit will control *discharges* necessary to meet applicable *water quality standards*. It shall be a violation of the *ECL* for any discharge to either cause or contribute to a violation of *water quality standards* as contained in Parts 700 through 705 of Title 6 of the Official Compilation of Codes, Rules and Regulations of the State of New York, such as:

1. There shall be no increase in turbidity that will cause a substantial visible contrast to natural conditions;
2. There shall be no increase in suspended, colloidal or settleable solids that will cause deposition or impair the waters for their best usages; and
3. There shall be no residue from oil and floating substances, nor visible oil film, nor globules of grease.

If there is evidence indicating that the stormwater *discharges* authorized by this permit are causing, have the reasonable potential to cause, or are contributing to a violation of the *water quality standards*; the *owner or operator* must take appropriate corrective action in accordance with Part IV.C.5. of this general permit and document in accordance with Part IV.C.4. of this general permit. To address the *water quality standard* violation the *owner or operator* may need to provide additional information, include and implement appropriate controls in the SWPPP to correct the problem, or obtain an individual SPDES permit.

If there is evidence indicating that despite compliance with the terms and conditions of this general permit it is demonstrated that the stormwater *discharges* authorized by this permit are causing or contributing to a violation of *water quality standards*, or if the Department determines that a modification of the permit is necessary to prevent a violation of *water quality standards*, the authorized *discharges* will no longer be eligible for coverage under this permit. The Department may require the *owner or operator* to obtain an individual SPDES permit to continue discharging.

E. Eligibility Under This General Permit

1. This permit may authorize all *discharges* of stormwater from *construction activity* to *surface waters of the State* and *groundwaters* except for ineligible *discharges* identified under subparagraph F. of this Part.
2. Except for non-stormwater *discharges* explicitly listed in the next paragraph, this permit only authorizes stormwater *discharges*; including stormwater runoff, snowmelt runoff, and surface runoff and drainage, from *construction activities*.
3. Notwithstanding paragraphs E.1 and E.2 above, the following non-stormwater discharges are authorized by this permit: those listed in 6 NYCRR 750-1.2(a)(29)(vi), with the following exception: “Discharges from firefighting activities are authorized only when the firefighting activities are emergencies/unplanned”; waters to which other components have not been added that are used to control dust in accordance with the SWPPP; and uncontaminated *discharges* from *construction site* de-watering operations. All non-stormwater discharges must be identified in the SWPPP. Under all circumstances, the *owner or operator* must still comply with *water quality standards* in Part I.D of this permit.
4. The *owner or operator* must maintain permit eligibility to *discharge* under this permit. Any *discharges* that are not compliant with the eligibility conditions of this permit are not authorized by the permit and the *owner or operator* must either apply for a separate permit to cover those ineligible *discharges* or take steps necessary to make the *discharge* eligible for coverage.

F. Activities Which Are Ineligible for Coverage Under This General Permit

All of the following are **not** authorized by this permit:

1. *Discharges* after *construction activities* have been completed and the site has undergone *final stabilization*;
2. *Discharges* that are mixed with sources of non-stormwater other than those expressly authorized under subsection E.3. of this Part and identified in the SWPPP required by this permit;
3. *Discharges* that are required to obtain an individual SPDES permit or another SPDES general permit pursuant to Part VII.K. of this permit;
4. *Construction activities* or *discharges* from *construction activities* that may adversely affect an *endangered or threatened species* unless the *owner or*

operator has obtained a permit issued pursuant to 6 NYCRR Part 182 for the project or the Department has issued a letter of non-jurisdiction for the project. All documentation necessary to demonstrate eligibility shall be maintained on site in accordance with Part II.D.2 of this permit;

5. *Discharges* which either cause or contribute to a violation of *water quality standards* adopted pursuant to the *ECL* and its accompanying regulations;
6. *Construction activities* for residential, commercial and institutional projects:
 - a. Where the *discharges* from the *construction activities* are tributary to waters of the state classified as AA or AA-s; and
 - b. Which are undertaken on land with no existing *impervious cover*; and
 - c. Which disturb one (1) or more acres of land designated on the current United States Department of Agriculture (“USDA”) Soil Survey as Soil Slope Phase “D”, (provided the map unit name is inclusive of slopes greater than 25%), or Soil Slope Phase “E” or “F” (regardless of the map unit name), or a combination of the three designations.
7. *Construction activities* for linear transportation projects and linear utility projects:
 - a. Where the *discharges* from the *construction activities* are tributary to waters of the state classified as AA or AA-s; and
 - b. Which are undertaken on land with no existing *impervious cover*; and
 - c. Which disturb two (2) or more acres of land designated on the current USDA Soil Survey as Soil Slope Phase “D” (provided the map unit name is inclusive of slopes greater than 25%), or Soil Slope Phase “E” or “F” (regardless of the map unit name), or a combination of the three designations.

8. *Construction activities* that have the potential to affect an *historic property*, unless there is documentation that such impacts have been resolved. The following documentation necessary to demonstrate eligibility with this requirement shall be maintained on site in accordance with Part II.D.2 of this permit and made available to the Department in accordance with Part VII.F of this permit:
- a. Documentation that the *construction activity* is not within an archeologically sensitive area indicated on the sensitivity map, and that the *construction activity* is not located on or immediately adjacent to a property listed or determined to be eligible for listing on the National or State Registers of Historic Places, and that there is no new permanent building on the *construction site* within the following distances from a building, structure, or object that is more than 50 years old, or if there is such a new permanent building on the *construction site* within those parameters that NYS Office of Parks, Recreation and Historic Preservation (OPRHP), a Historic Preservation Commission of a Certified Local Government, or a qualified preservation professional has determined that the building, structure, or object more than 50 years old is not historically/archeologically significant.
 - 1-5 acres of disturbance - 20 feet
 - 5-20 acres of disturbance - 50 feet
 - 20+ acres of disturbance - 100 feet, or
 - b. DEC consultation form sent to OPRHP, and copied to the NYS DEC Agency Historic Preservation Officer (APO), and
 - (i) the State Environmental Quality Review (SEQR) Environmental Assessment Form (EAF) with a negative declaration or the Findings Statement, with documentation of OPRHP's agreement with the resolution; or
 - (ii) documentation from OPRHP that the *construction activity* will result in No Impact; or
 - (iii) documentation from OPRHP providing a determination of No Adverse Impact; or
 - (iv) a Letter of Resolution signed by the owner/operator, OPRHP and the DEC APO which allows for this *construction activity* to be eligible for coverage under the general permit in terms of the State Historic Preservation Act (SHPA); or
 - c. Documentation of satisfactory compliance with Section 106 of the National Historic Preservation Act for a coterminous project area:

- (i) No Affect
- (ii) No Adverse Affect
- (iii) Executed Memorandum of Agreement, or

d. Documentation that:

- (i) SHPA Section 14.09 has been completed by NYS DEC or another state agency.
9. *Discharges from construction activities* that are subject to an existing SPDES individual or general permit where a SPDES permit for *construction activity* has been terminated or denied; or where the *owner or operator* has failed to renew an expired individual permit.

Part II. PERMIT COVERAGE

A. How to Obtain Coverage

1. An *owner or operator* of a *construction activity* that is not subject to the requirements of a regulated, traditional land use control MS4 must first prepare a SWPPP in accordance with all applicable requirements of this permit and then submit a completed Notice of Intent (NOI) to the Department to be authorized to discharge under this permit.
2. An *owner or operator* of a *construction activity* that is subject to the requirements of a *regulated, traditional land use control MS4* must first prepare a SWPPP in accordance with all applicable requirements of this permit and then have the SWPPP reviewed and accepted by the *regulated, traditional land use control MS4* prior to submitting the NOI to the Department. The *owner or operator* shall have the “MS4 SWPPP Acceptance” form signed in accordance with Part VII.H., and then submit that form along with a completed NOI to the Department.
3. The requirement for an *owner or operator* to have its SWPPP reviewed and accepted by the *regulated, traditional land use control MS4* prior to submitting the NOI to the Department does not apply to an *owner or operator* that is obtaining permit coverage in accordance with the requirements in Part II.F. (Change of Owner or Operator) or where the *owner or operator* of the *construction activity* is the *regulated, traditional land use control MS4* . This exemption does not apply to *construction activities* subject to the New York City Administrative Code.

B. Notice of Intent (NOI) Submittal

1. Prior to December 21, 2020, an owner or operator shall use either the electronic (eNOI) or paper version of the NOI that the Department prepared. Both versions of the NOI are located on the Department's website (<http://www.dec.ny.gov/>). The paper version of the NOI shall be signed in accordance with Part VII.H. of this permit and submitted to the following address:

**NOTICE OF INTENT
NYS DEC, Bureau of Water Permits
625 Broadway, 4th Floor
Albany, New York 12233-3505**

2. Beginning December 21, 2020 and in accordance with EPA's 2015 NPDES Electronic Reporting Rule (40 CFR Part 127), the *owner or operator* must submit the NOI electronically using the *Department's* online NOI.
3. The *owner or operator* shall have the SWPPP preparer sign the "SWPPP Preparer Certification" statement on the NOI prior to submitting the form to the Department.
4. As of the date the NOI is submitted to the Department, the *owner or operator* shall make the NOI and SWPPP available for review and copying in accordance with the requirements in Part VII.F. of this permit.

C. Permit Authorization

1. An *owner or operator* shall not *commence construction activity* until their authorization to *discharge* under this permit goes into effect.
2. Authorization to *discharge* under this permit will be effective when the *owner or operator* has satisfied all of the following criteria:
 - a. project review pursuant to the State Environmental Quality Review Act ("SEQRA") have been satisfied, when SEQRA is applicable. See the Department's website (<http://www.dec.ny.gov/>) for more information,
 - b. where required, all necessary Department permits subject to the *Uniform Procedures Act* ("UPA") (see 6 NYCRR Part 621), or the equivalent from another New York State agency, have been obtained, unless otherwise notified by the Department pursuant to 6 NYCRR 621.3(a)(4). *Owners or operators* of *construction activities* that are required to obtain *UPA* permits

must submit a preliminary SWPPP to the appropriate DEC Permit Administrator at the Regional Office listed in Appendix F at the time all other necessary *UPA* permit applications are submitted. The preliminary SWPPP must include sufficient information to demonstrate that the *construction activity* qualifies for authorization under this permit,

- c. the final SWPPP has been prepared, and
 - d. a complete NOI has been submitted to the Department in accordance with the requirements of this permit.
3. An *owner or operator* that has satisfied the requirements of Part II.C.2 above will be authorized to *discharge* stormwater from their *construction activity* in accordance with the following schedule:
- a. For *construction activities* that are not subject to the requirements of a *regulated, traditional land use control MS4*:
 - (i) Five (5) business days from the date the Department receives a complete electronic version of the NOI (eNOI) for *construction activities* with a SWPPP that has been prepared in conformance with the design criteria in the technical standard referenced in Part III.B.1 and the *performance criteria* in the technical standard referenced in Parts III.B., 2 or 3, for *construction activities* that require post-construction stormwater management practices pursuant to Part III.C.; or
 - (ii) Sixty (60) business days from the date the Department receives a complete NOI (electronic or paper version) for *construction activities* with a SWPPP that has not been prepared in conformance with the design criteria in technical standard referenced in Part III.B.1. or, for *construction activities* that require post-construction stormwater management practices pursuant to Part III.C., the *performance criteria* in the technical standard referenced in Parts III.B., 2 or 3, or;
 - (iii) Ten (10) business days from the date the Department receives a complete paper version of the NOI for *construction activities* with a SWPPP that has been prepared in conformance with the design criteria in the technical standard referenced in Part III.B.1 and the *performance criteria* in the technical standard referenced in Parts III.B., 2 or 3, for *construction activities* that require post-construction stormwater management practices pursuant to Part III.C.

- b. For *construction activities* that are subject to the requirements of a *regulated, traditional land use control MS4*:
 - (i) Five (5) business days from the date the Department receives both a complete electronic version of the NOI (eNOI) and signed “MS4 SWPPP Acceptance” form, or
 - (ii) Ten (10) business days from the date the Department receives both a complete paper version of the NOI and signed “MS4 SWPPP Acceptance” form.
4. Coverage under this permit authorizes stormwater *discharges* from only those areas of disturbance that are identified in the NOI. If an *owner or operator* wishes to have stormwater *discharges* from future or additional areas of disturbance authorized, they must submit a new NOI that addresses that phase of the development, unless otherwise notified by the Department. The *owner or operator* shall not *commence construction activity* on the future or additional areas until their authorization to *discharge* under this permit goes into effect in accordance with Part II.C. of this permit.

D. General Requirements For Owners or Operators With Permit Coverage

1. The *owner or operator* shall ensure that the provisions of the SWPPP are implemented from the *commencement of construction activity* until all areas of disturbance have achieved *final stabilization* and the Notice of Termination (“NOT”) has been submitted to the Department in accordance with Part V. of this permit. This includes any changes made to the SWPPP pursuant to Part III.A.4. of this permit.
2. The *owner or operator* shall maintain a copy of the General Permit (GP-0-20-001), NOI, *NOI Acknowledgment Letter*, SWPPP, MS4 SWPPP Acceptance form, inspection reports, responsible contractor’s or subcontractor’s certification statement (see Part III.A.6.), and all documentation necessary to demonstrate eligibility with this permit at the *construction site* until all disturbed areas have achieved *final stabilization* and the NOT has been submitted to the Department. The documents must be maintained in a secure location, such as a job trailer, on-site construction office, or mailbox with lock. The secure location must be accessible during normal business hours to an individual performing a compliance inspection.
3. The *owner or operator of a construction activity* shall not disturb greater than five (5) acres of soil at any one time without prior written authorization from the Department or, in areas under the jurisdiction of a *regulated, traditional land*

- use control MS4, the regulated, traditional land use control MS4* (provided the *regulated, traditional land use control MS4* is not the *owner or operator* of the *construction activity*). At a minimum, the *owner or operator* must comply with the following requirements in order to be authorized to disturb greater than five (5) acres of soil at any one time:
- a. The *owner or operator* shall have a *qualified inspector* conduct **at least** two (2) site inspections in accordance with Part IV.C. of this permit every seven (7) calendar days, for as long as greater than five (5) acres of soil remain disturbed. The two (2) inspections shall be separated by a minimum of two (2) full calendar days.
 - b. In areas where soil disturbance activity has temporarily or permanently ceased, the application of soil stabilization measures must be initiated by the end of the next business day and completed within seven (7) days from the date the current soil disturbance activity ceased. The soil stabilization measures selected shall be in conformance with the technical standard, New York State Standards and Specifications for Erosion and Sediment Control, dated November 2016.
 - c. The *owner or operator* shall prepare a phasing plan that defines maximum disturbed area per phase and shows required cuts and fills.
 - d. The *owner or operator* shall install any additional site-specific practices needed to protect water quality.
 - e. The *owner or operator* shall include the requirements above in their SWPPP.
4. In accordance with statute, regulations, and the terms and conditions of this permit, the Department may suspend or revoke an *owner's or operator's* coverage under this permit at any time if the Department determines that the SWPPP does not meet the permit requirements or consistent with Part VII.K..
 5. Upon a finding of significant non-compliance with the practices described in the SWPPP or violation of this permit, the Department may order an immediate stop to all activity at the site until the non-compliance is remedied. The stop work order shall be in writing, describe the non-compliance in detail, and be sent to the *owner or operator*.
 6. For *construction activities* that are subject to the requirements of a *regulated, traditional land use control MS4*, the *owner or operator* shall notify the

regulated, traditional land use control MS4 in writing of any planned amendments or modifications to the post-construction stormwater management practice component of the SWPPP required by Part III.A. 4. and 5. of this permit. Unless otherwise notified by the *regulated, traditional land use control MS4*, the *owner or operator* shall have the SWPPP amendments or modifications reviewed and accepted by the *regulated, traditional land use control MS4* prior to commencing construction of the post-construction stormwater management practice.

E. Permit Coverage for Discharges Authorized Under GP-0-15-002

1. Upon renewal of SPDES General Permit for Stormwater Discharges from *Construction Activity* (Permit No. GP-0-15-002), an *owner or operator* of a *construction activity* with coverage under GP-0-15-002, as of the effective date of GP- 0-20-001, shall be authorized to *discharge* in accordance with GP- 0-20-001, unless otherwise notified by the Department.

An *owner or operator* may continue to implement the technical/design components of the post-construction stormwater management controls provided that such design was done in conformance with the technical standards in place at the time of initial project authorization. However, they must comply with the other, non-design provisions of GP-0-20-001.

F. Change of Owner or Operator

1. When property ownership changes or when there is a change in operational control over the construction plans and specifications, the original *owner or operator* must notify the new *owner or operator*, in writing, of the requirement to obtain permit coverage by submitting a NOI with the Department. For *construction activities* subject to the requirements of a *regulated, traditional land use control MS4*, the original *owner or operator* must also notify the MS4, in writing, of the change in ownership at least 30 calendar days prior to the change in ownership.
2. Once the new *owner or operator* obtains permit coverage, the original *owner or operator* shall then submit a completed NOT with the name and permit identification number of the new *owner or operator* to the Department at the address in Part II.B.1. of this permit. If the original *owner or operator* maintains ownership of a portion of the *construction activity* and will disturb soil, they must maintain their coverage under the permit.
3. Permit coverage for the new *owner or operator* will be effective as of the date the Department receives a complete NOI, provided the original *owner or*

operator was not subject to a sixty (60) business day authorization period that has not expired as of the date the Department receives the NOI from the new *owner or operator*.

Part III. STORMWATER POLLUTION PREVENTION PLAN (SWPPP)

A. General SWPPP Requirements

1. A SWPPP shall be prepared and implemented by the *owner or operator* of each *construction activity* covered by this permit. The SWPPP must document the selection, design, installation, implementation and maintenance of the control measures and practices that will be used to meet the effluent limitations in Part I.B. of this permit and where applicable, the post-construction stormwater management practice requirements in Part I.C. of this permit. The SWPPP shall be prepared prior to the submittal of the NOI. The NOI shall be submitted to the Department prior to the *commencement of construction activity*. A copy of the completed, final NOI shall be included in the SWPPP.
2. The SWPPP shall describe the erosion and sediment control practices and where required, post-construction stormwater management practices that will be used and/or constructed to reduce the *pollutants* in stormwater *discharges* and to assure compliance with the terms and conditions of this permit. In addition, the SWPPP shall identify potential sources of pollution which may reasonably be expected to affect the quality of stormwater *discharges*.
3. All SWPPPs that require the post-construction stormwater management practice component shall be prepared by a *qualified professional* that is knowledgeable in the principles and practices of stormwater management and treatment.
4. The *owner or operator* must keep the SWPPP current so that it at all times accurately documents the erosion and sediment controls practices that are being used or will be used during construction, and all post-construction stormwater management practices that will be constructed on the site. At a minimum, the *owner or operator* shall amend the SWPPP, including construction drawings:
 - a. whenever the current provisions prove to be ineffective in minimizing *pollutants* in stormwater *discharges* from the site;

- b. whenever there is a change in design, construction, or operation at the *construction site* that has or could have an effect on the *discharge* of *pollutants*;
 - c. to address issues or deficiencies identified during an inspection by the *qualified inspector*, the Department or other regulatory authority; and
 - d. to document the final construction conditions.
5. The Department may notify the *owner or operator* at any time that the SWPPP does not meet one or more of the minimum requirements of this permit. The notification shall be in writing and identify the provisions of the SWPPP that require modification. Within fourteen (14) calendar days of such notification, or as otherwise indicated by the Department, the *owner or operator* shall make the required changes to the SWPPP and submit written notification to the Department that the changes have been made. If the *owner or operator* does not respond to the Department's comments in the specified time frame, the Department may suspend the *owner's or operator's* coverage under this permit or require the *owner or operator* to obtain coverage under an individual SPDES permit in accordance with Part II.D.4. of this permit.
6. Prior to the *commencement of construction activity*, the *owner or operator* must identify the contractor(s) and subcontractor(s) that will be responsible for installing, constructing, repairing, replacing, inspecting and maintaining the erosion and sediment control practices included in the SWPPP; and the contractor(s) and subcontractor(s) that will be responsible for constructing the post-construction stormwater management practices included in the SWPPP. The *owner or operator* shall have each of the contractors and subcontractors identify at least one person from their company that will be responsible for implementation of the SWPPP. This person shall be known as the *trained contractor*. The *owner or operator* shall ensure that at least one *trained contractor* is on site on a daily basis when soil disturbance activities are being performed.

The *owner or operator* shall have each of the contractors and subcontractors identified above sign a copy of the following certification statement below before they commence any *construction activity*:

"I hereby certify under penalty of law that I understand and agree to comply with the terms and conditions of the SWPPP and agree to implement any corrective actions identified by the *qualified inspector* during a site inspection. I also understand that the *owner or operator* must comply with

the terms and conditions of the most current version of the New York State Pollutant Discharge Elimination System ("SPDES") general permit for stormwater *discharges* from *construction activities* and that it is unlawful for any person to cause or contribute to a violation of *water quality standards*. Furthermore, I am aware that there are significant penalties for submitting false information, that I do not believe to be true, including the possibility of fine and imprisonment for knowing violations"

In addition to providing the certification statement above, the certification page must also identify the specific elements of the SWPPP that each contractor and subcontractor will be responsible for and include the name and title of the person providing the signature; the name and title of the *trained contractor* responsible for SWPPP implementation; the name, address and telephone number of the contracting firm; the address (or other identifying description) of the site; and the date the certification statement is signed. The *owner or operator* shall attach the certification statement(s) to the copy of the SWPPP that is maintained at the *construction site*. If new or additional contractors are hired to implement measures identified in the SWPPP after construction has commenced, they must also sign the certification statement and provide the information listed above.

7. For projects where the Department requests a copy of the SWPPP or inspection reports, the *owner or operator* shall submit the documents in both electronic (PDF only) and paper format within five (5) business days, unless otherwise notified by the Department.

B. Required SWPPP Contents

1. Erosion and sediment control component - All SWPPPs prepared pursuant to this permit shall include erosion and sediment control practices designed in conformance with the technical standard, New York State Standards and Specifications for Erosion and Sediment Control, dated November 2016. Where erosion and sediment control practices are not designed in conformance with the design criteria included in the technical standard, the *owner or operator* must demonstrate *equivalence* to the technical standard. At a minimum, the erosion and sediment control component of the SWPPP shall include the following:
 - a. Background information about the scope of the project, including the location, type and size of project

- b. A site map/construction drawing(s) for the project, including a general location map. At a minimum, the site map shall show the total site area; all improvements; areas of disturbance; areas that will not be disturbed; existing vegetation; on-site and adjacent off-site surface water(s); floodplain/floodway boundaries; wetlands and drainage patterns that could be affected by the *construction activity*; existing and final contours ; locations of different soil types with boundaries; material, waste, borrow or equipment storage areas located on adjacent properties; and location(s) of the stormwater *discharge(s)*;
- c. A description of the soil(s) present at the site, including an identification of the Hydrologic Soil Group (HSG);
- d. A construction phasing plan and sequence of operations describing the intended order of *construction activities*, including clearing and grubbing, excavation and grading, utility and infrastructure installation and any other activity at the site that results in soil disturbance;
- e. A description of the minimum erosion and sediment control practices to be installed or implemented for each *construction activity* that will result in soil disturbance. Include a schedule that identifies the timing of initial placement or implementation of each erosion and sediment control practice and the minimum time frames that each practice should remain in place or be implemented;
- f. A temporary and permanent soil stabilization plan that meets the requirements of this general permit and the technical standard, New York State Standards and Specifications for Erosion and Sediment Control, dated November 2016, for each stage of the project, including initial land clearing and grubbing to project completion and achievement of *final stabilization*;
- g. A site map/construction drawing(s) showing the specific location(s), size(s), and length(s) of each erosion and sediment control practice;
- h. The dimensions, material specifications, installation details, and operation and maintenance requirements for all erosion and sediment control practices. Include the location and sizing of any temporary sediment basins and structural practices that will be used to divert flows from exposed soils;
- i. A maintenance inspection schedule for the contractor(s) identified in Part III.A.6. of this permit, to ensure continuous and effective operation of the erosion and sediment control practices. The maintenance inspection

schedule shall be in accordance with the requirements in the technical standard, New York State Standards and Specifications for Erosion and Sediment Control, dated November 2016;

- j. A description of the pollution prevention measures that will be used to control litter, construction chemicals and construction debris from becoming a *pollutant* source in the stormwater *discharges*;
 - k. A description and location of any stormwater *discharges* associated with industrial activity other than construction at the site, including, but not limited to, stormwater *discharges* from asphalt plants and concrete plants located on the *construction site*; and
 - l. Identification of any elements of the design that are not in conformance with the design criteria in the technical standard, New York State Standards and Specifications for Erosion and Sediment Control, dated November 2016. Include the reason for the deviation or alternative design and provide information which demonstrates that the deviation or alternative design is *equivalent* to the technical standard.
2. Post-construction stormwater management practice component – The *owner or operator* of any construction project identified in Table 2 of Appendix B as needing post-construction stormwater management practices shall prepare a SWPPP that includes practices designed in conformance with the applicable *sizing criteria* in Part I.C.2.a., c. or d. of this permit and the *performance criteria* in the technical standard, New York State Stormwater Management Design Manual dated January 2015

Where post-construction stormwater management practices are not designed in conformance with the *performance criteria* in the technical standard, the *owner or operator* must include in the SWPPP the reason(s) for the deviation or alternative design and provide information which demonstrates that the deviation or alternative design is *equivalent* to the technical standard.

The post-construction stormwater management practice component of the SWPPP shall include the following:

- a. Identification of all post-construction stormwater management practices to be constructed as part of the project. Include the dimensions, material specifications and installation details for each post-construction stormwater management practice;

- b. A site map/construction drawing(s) showing the specific location and size of each post-construction stormwater management practice;
- c. A Stormwater Modeling and Analysis Report that includes:
 - (i) Map(s) showing pre-development conditions, including watershed/subcatchments boundaries, flow paths/routing, and design points;
 - (ii) Map(s) showing post-development conditions, including watershed/subcatchments boundaries, flow paths/routing, design points and post-construction stormwater management practices;
 - (iii) Results of stormwater modeling (i.e. hydrology and hydraulic analysis) for the required storm events. Include supporting calculations (model runs), methodology, and a summary table that compares pre and post-development runoff rates and volumes for the different storm events;
 - (iv) Summary table, with supporting calculations, which demonstrates that each post-construction stormwater management practice has been designed in conformance with the *sizing criteria* included in the Design Manual;
 - (v) Identification of any *sizing criteria* that is not required based on the requirements included in Part I.C. of this permit; and
 - (vi) Identification of any elements of the design that are not in conformance with the *performance criteria* in the Design Manual. Include the reason(s) for the deviation or alternative design and provide information which demonstrates that the deviation or alternative design is *equivalent* to the Design Manual;
- d. Soil testing results and locations (test pits, borings);
- e. Infiltration test results, when required; and
- f. An operations and maintenance plan that includes inspection and maintenance schedules and actions to ensure continuous and effective operation of each post-construction stormwater management practice. The plan shall identify the entity that will be responsible for the long term operation and maintenance of each practice.

3. Enhanced Phosphorus Removal Standards - All construction projects identified in Table 2 of Appendix B that are located in the watersheds identified in Appendix C shall prepare a SWPPP that includes post-construction stormwater management practices designed in conformance with the applicable *sizing criteria* in Part I.C.2. b., c. or d. of this permit and the *performance criteria*, Enhanced Phosphorus Removal Standards included in the Design Manual. At a minimum, the post-construction stormwater management practice component of the SWPPP shall include items 2.a - 2.f. above.

C. Required SWPPP Components by Project Type

Unless otherwise notified by the Department, *owners or operators of construction activities* identified in Table 1 of Appendix B are required to prepare a SWPPP that only includes erosion and sediment control practices designed in conformance with Part III.B.1 of this permit. *Owners or operators of the construction activities* identified in Table 2 of Appendix B shall prepare a SWPPP that also includes post-construction stormwater management practices designed in conformance with Part III.B.2 or 3 of this permit.

Part IV. INSPECTION AND MAINTENANCE REQUIREMENTS

A. General Construction Site Inspection and Maintenance Requirements

1. The *owner or operator* must ensure that all erosion and sediment control practices (including pollution prevention measures) and all post-construction stormwater management practices identified in the SWPPP are inspected and maintained in accordance with Part IV.B. and C. of this permit.
2. The terms of this permit shall not be construed to prohibit the State of New York from exercising any authority pursuant to the ECL, common law or federal law, or prohibit New York State from taking any measures, whether civil or criminal, to prevent violations of the laws of the State of New York or protect the public health and safety and/or the environment.

B. Contractor Maintenance Inspection Requirements

1. The *owner or operator* of each *construction activity* identified in Tables 1 and 2 of Appendix B shall have a *trained contractor* inspect the erosion and sediment control practices and pollution prevention measures being implemented within the active work area daily to ensure that they are being maintained in effective operating condition at all times. If deficiencies are identified, the contractor shall

begin implementing corrective actions within one business day and shall complete the corrective actions in a reasonable time frame.

2. For construction sites where soil disturbance activities have been temporarily suspended (e.g. winter shutdown) and *temporary stabilization* measures have been applied to all disturbed areas, the *trained contractor* can stop conducting the maintenance inspections. The *trained contractor* shall begin conducting the maintenance inspections in accordance with Part IV.B.1. of this permit as soon as soil disturbance activities resume.
3. For construction sites where soil disturbance activities have been shut down with partial project completion, the *trained contractor* can stop conducting the maintenance inspections if all areas disturbed as of the project shutdown date have achieved *final stabilization* and all post-construction stormwater management practices required for the completed portion of the project have been constructed in conformance with the SWPPP and are operational.

C. Qualified Inspector Inspection Requirements

The *owner or operator* shall have a *qualified inspector* conduct site inspections in conformance with the following requirements:

[Note: The *trained contractor* identified in Part III.A.6. and IV.B. of this permit **cannot** conduct the *qualified inspector* site inspections unless they meet the *qualified inspector* qualifications included in Appendix A. In order to perform these inspections, the *trained contractor* would have to be a:

- licensed Professional Engineer,
 - Certified Professional in Erosion and Sediment Control (CPESC),
 - New York State Erosion and Sediment Control Certificate Program holder
 - Registered Landscape Architect, or
 - someone working under the direct supervision of, and at the same company as, the licensed Professional Engineer or Registered Landscape Architect, provided they have received four (4) hours of Department endorsed training in proper erosion and sediment control principles from a Soil and Water Conservation District, or other Department endorsed entity].
1. A *qualified inspector* shall conduct site inspections for all *construction activities* identified in Tables 1 and 2 of Appendix B, with the exception of:
 - a. the construction of a single family residential subdivision with 25% or less *impervious cover* at total site build-out that involves a soil disturbance of one (1) or more acres of land but less than five (5) acres and is not located

in one of the watersheds listed in Appendix C and not directly discharging to one of the 303(d) segments listed in Appendix E;

- b. the construction of a single family home that involves a soil disturbance of one (1) or more acres of land but less than five (5) acres and is not located in one of the watersheds listed in Appendix C and not directly discharging to one of the 303(d) segments listed in Appendix E;
 - c. construction on agricultural property that involves a soil disturbance of one (1) or more acres of land but less than five (5) acres; and
 - d. *construction activities* located in the watersheds identified in Appendix D that involve soil disturbances between five thousand (5,000) square feet and one (1) acre of land.
2. Unless otherwise notified by the Department, the *qualified inspector* shall conduct site inspections in accordance with the following timetable:
- a. For construction sites where soil disturbance activities are on-going, the *qualified inspector* shall conduct a site inspection at least once every seven (7) calendar days.
 - b. For construction sites where soil disturbance activities are on-going and the *owner or operator* has received authorization in accordance with Part II.D.3 to disturb greater than five (5) acres of soil at any one time, the *qualified inspector* shall conduct at least two (2) site inspections every seven (7) calendar days. The two (2) inspections shall be separated by a minimum of two (2) full calendar days.
 - c. For construction sites where soil disturbance activities have been temporarily suspended (e.g. winter shutdown) and *temporary stabilization* measures have been applied to all disturbed areas, the *qualified inspector* shall conduct a site inspection at least once every thirty (30) calendar days. The *owner or operator* shall notify the DOW Water (SPDES) Program contact at the Regional Office (see contact information in Appendix F) or, in areas under the jurisdiction of a *regulated, traditional land use control MS4*, the *regulated, traditional land use control MS4* (provided the *regulated, traditional land use control MS4* is not the *owner or operator* of the *construction activity*) in writing prior to reducing the frequency of inspections.

- d. For construction sites where soil disturbance activities have been shut down with partial project completion, the *qualified inspector* can stop conducting inspections if all areas disturbed as of the project shutdown date have achieved *final stabilization* and all post-construction stormwater management practices required for the completed portion of the project have been constructed in conformance with the SWPPP and are operational. The *owner or operator* shall notify the DOW Water (SPDES) Program contact at the Regional Office (see contact information in Appendix F) or, in areas under the jurisdiction of a *regulated, traditional land use control MS4*, the *regulated, traditional land use control MS4* (provided the *regulated, traditional land use control MS4* is not the *owner or operator* of the *construction activity*) in writing prior to the shutdown. If soil disturbance activities are not resumed within 2 years from the date of shutdown, the *owner or operator* shall have the *qualified inspector* perform a final inspection and certify that all disturbed areas have achieved *final stabilization*, and all temporary, structural erosion and sediment control measures have been removed; and that all post-construction stormwater management practices have been constructed in conformance with the SWPPP by signing the “*Final Stabilization*” and “*Post-Construction Stormwater Management Practice*” certification statements on the NOT. The *owner or operator* shall then submit the completed NOT form to the address in Part II.B.1 of this permit.
 - e. For construction sites that directly *discharge* to one of the 303(d) segments listed in Appendix E or is located in one of the watersheds listed in Appendix C, the *qualified inspector* shall conduct at least two (2) site inspections every seven (7) calendar days. The two (2) inspections shall be separated by a minimum of two (2) full calendar days.
3. At a minimum, the *qualified inspector* shall inspect all erosion and sediment control practices and pollution prevention measures to ensure integrity and effectiveness, all post-construction stormwater management practices under construction to ensure that they are constructed in conformance with the SWPPP, all areas of disturbance that have not achieved *final stabilization*, all points of *discharge* to natural surface waterbodies located within, or immediately adjacent to, the property boundaries of the *construction site*, and all points of *discharge* from the *construction site*.
 4. The *qualified inspector* shall prepare an inspection report subsequent to each and every inspection. At a minimum, the inspection report shall include and/or address the following:

- a. Date and time of inspection;
- b. Name and title of person(s) performing inspection;
- c. A description of the weather and soil conditions (e.g. dry, wet, saturated) at the time of the inspection;
- d. A description of the condition of the runoff at all points of *discharge* from the *construction site*. This shall include identification of any *discharges* of sediment from the *construction site*. Include *discharges* from conveyance systems (i.e. pipes, culverts, ditches, etc.) and overland flow;
- e. A description of the condition of all natural surface waterbodies located within, or immediately adjacent to, the property boundaries of the *construction site* which receive runoff from disturbed areas. This shall include identification of any *discharges* of sediment to the surface waterbody;
- f. Identification of all erosion and sediment control practices and pollution prevention measures that need repair or maintenance;
- g. Identification of all erosion and sediment control practices and pollution prevention measures that were not installed properly or are not functioning as designed and need to be reinstalled or replaced;
- h. Description and sketch of areas with active soil disturbance activity, areas that have been disturbed but are inactive at the time of the inspection, and areas that have been stabilized (temporary and/or final) since the last inspection;
- i. Current phase of construction of all post-construction stormwater management practices and identification of all construction that is not in conformance with the SWPPP and technical standards;
- j. Corrective action(s) that must be taken to install, repair, replace or maintain erosion and sediment control practices and pollution prevention measures; and to correct deficiencies identified with the construction of the post-construction stormwater management practice(s);
- k. Identification and status of all corrective actions that were required by previous inspection; and

- I. Digital photographs, with date stamp, that clearly show the condition of all practices that have been identified as needing corrective actions. The *qualified inspector* shall attach paper color copies of the digital photographs to the inspection report being maintained onsite within seven (7) calendar days of the date of the inspection. The *qualified inspector* shall also take digital photographs, with date stamp, that clearly show the condition of the practice(s) after the corrective action has been completed. The *qualified inspector* shall attach paper color copies of the digital photographs to the inspection report that documents the completion of the corrective action work within seven (7) calendar days of that inspection.
5. Within one business day of the completion of an inspection, the *qualified inspector* shall notify the *owner or operator* and appropriate contractor or subcontractor identified in Part III.A.6. of this permit of any corrective actions that need to be taken. The contractor or subcontractor shall begin implementing the corrective actions within one business day of this notification and shall complete the corrective actions in a reasonable time frame.
6. All inspection reports shall be signed by the *qualified inspector*. Pursuant to Part II.D.2. of this permit, the inspection reports shall be maintained on site with the SWPPP.

Part V. TERMINATION OF PERMIT COVERAGE

A. Termination of Permit Coverage

1. An *owner or operator* that is eligible to terminate coverage under this permit must submit a completed NOT form to the address in Part II.B.1 of this permit. The NOT form shall be one which is associated with this permit, signed in accordance with Part VII.H of this permit.
2. An *owner or operator* may terminate coverage when one or more the following conditions have been met:
 - a. Total project completion - All *construction activity* identified in the SWPPP has been completed; and all areas of disturbance have achieved *final stabilization*; and all temporary, structural erosion and sediment control measures have been removed; and all post-construction stormwater management practices have been constructed in conformance with the SWPPP and are operational;

- b. Planned shutdown with partial project completion - All soil disturbance activities have ceased; and all areas disturbed as of the project shutdown date have achieved *final stabilization*; and all temporary, structural erosion and sediment control measures have been removed; and all post-construction stormwater management practices required for the completed portion of the project have been constructed in conformance with the SWPPP and are operational;
 - c. A new *owner or operator* has obtained coverage under this permit in accordance with Part II.F. of this permit.
 - d. The *owner or operator* obtains coverage under an alternative SPDES general permit or an individual SPDES permit.
3. For *construction activities* meeting subdivision 2a. or 2b. of this Part, the *owner or operator* shall have the *qualified inspector* perform a final site inspection prior to submitting the NOT. The *qualified inspector* shall, by signing the “*Final Stabilization*” and “*Post-Construction Stormwater Management Practice certification statements*” on the NOT, certify that all the requirements in Part V.A.2.a. or b. of this permit have been achieved.
4. For *construction activities* that are subject to the requirements of a *regulated, traditional land use control MS4* and meet subdivision 2a. or 2b. of this Part, the *owner or operator* shall have the *regulated, traditional land use control MS4* sign the “*MS4 Acceptance*” statement on the NOT in accordance with the requirements in Part VII.H. of this permit. The *regulated, traditional land use control MS4* official, by signing this statement, has determined that it is acceptable for the *owner or operator* to submit the NOT in accordance with the requirements of this Part. The *regulated, traditional land use control MS4* can make this determination by performing a final site inspection themselves or by accepting the *qualified inspector’s* final site inspection certification(s) required in Part V.A.3. of this permit.
5. For *construction activities* that require post-construction stormwater management practices and meet subdivision 2a. of this Part, the *owner or operator* must, prior to submitting the NOT, ensure one of the following:
 - a. the post-construction stormwater management practice(s) and any right-of-way(s) needed to maintain such practice(s) have been deeded to the municipality in which the practice(s) is located,

- b. an executed maintenance agreement is in place with the municipality that will maintain the post-construction stormwater management practice(s),
- c. for post-construction stormwater management practices that are privately owned, the *owner or operator* has a mechanism in place that requires operation and maintenance of the practice(s) in accordance with the operation and maintenance plan, such as a deed covenant in the *owner or operator's* deed of record,
- d. for post-construction stormwater management practices that are owned by a public or private institution (e.g. school, university, hospital), government agency or authority, or public utility; the *owner or operator* has policy and procedures in place that ensures operation and maintenance of the practices in accordance with the operation and maintenance plan.

Part VI. REPORTING AND RETENTION RECORDS

A. Record Retention

The *owner or operator* shall retain a copy of the NOI, NOI Acknowledgment Letter, SWPPP, MS4 SWPPP Acceptance form and any inspection reports that were prepared in conjunction with this permit for a period of at least five (5) years from the date that the Department receives a complete NOT submitted in accordance with Part V. of this general permit.

B. Addresses

With the exception of the NOI, NOT, and MS4 SWPPP Acceptance form (which must be submitted to the address referenced in Part II.B.1 of this permit), all written correspondence requested by the Department, including individual permit applications, shall be sent to the address of the appropriate DOW Water (SPDES) Program contact at the Regional Office listed in Appendix F.

Part VII. STANDARD PERMIT CONDITIONS

A. Duty to Comply

The *owner or operator* must comply with all conditions of this permit. All contractors and subcontractors associated with the project must comply with the terms of the SWPPP. Any non-compliance with this permit constitutes a violation of the Clean Water

Act (CWA) and the ECL and is grounds for an enforcement action against the *owner or operator* and/or the contractor/subcontractor; permit revocation, suspension or modification; or denial of a permit renewal application. Upon a finding of significant non-compliance with this permit or the applicable SWPPP, the Department may order an immediate stop to all *construction activity* at the site until the non-compliance is remedied. The stop work order shall be in writing, shall describe the non-compliance in detail, and shall be sent to the *owner or operator*.

If any human remains or archaeological remains are encountered during excavation, the *owner or operator* must immediately cease, or cause to cease, all *construction activity* in the area of the remains and notify the appropriate Regional Water Engineer (RWE). *Construction activity* shall not resume until written permission to do so has been received from the RWE.

B. Continuation of the Expired General Permit

This permit expires five (5) years from the effective date. If a new general permit is not issued prior to the expiration of this general permit, an *owner or operator* with coverage under this permit may continue to operate and *discharge* in accordance with the terms and conditions of this general permit, if it is extended pursuant to the State Administrative Procedure Act and 6 NYCRR Part 621, until a new general permit is issued.

C. Enforcement

Failure of the *owner or operator*, its contractors, subcontractors, agents and/or assigns to strictly adhere to any of the permit requirements contained herein shall constitute a violation of this permit. There are substantial criminal, civil, and administrative penalties associated with violating the provisions of this permit. Fines of up to \$37,500 per day for each violation and imprisonment for up to fifteen (15) years may be assessed depending upon the nature and degree of the offense.

D. Need to Halt or Reduce Activity Not a Defense

It shall not be a defense for an *owner or operator* in an enforcement action that it would have been necessary to halt or reduce the *construction activity* in order to maintain compliance with the conditions of this permit.

E. Duty to Mitigate

The *owner or operator* and its contractors and subcontractors shall take all reasonable steps to *minimize* or prevent any *discharge* in violation of this permit which has a reasonable likelihood of adversely affecting human health or the environment.

F. Duty to Provide Information

The *owner or operator* shall furnish to the Department, within a reasonable specified time period of a written request, all documentation necessary to demonstrate eligibility and any information to determine compliance with this permit or to determine whether cause exists for modifying or revoking this permit, or suspending or denying coverage under this permit, in accordance with the terms and conditions of this permit. The NOI, SWPPP and inspection reports required by this permit are public documents that the *owner or operator* must make available for review and copying by any person within five (5) business days of the *owner or operator* receiving a written request by any such person to review these documents. Copying of documents will be done at the requester's expense.

G. Other Information

When the *owner or operator* becomes aware that they failed to submit any relevant facts, or submitted incorrect information in the NOI or in any of the documents required by this permit, or have made substantive revisions to the SWPPP (e.g. the scope of the project changes significantly, the type of post-construction stormwater management practice(s) changes, there is a reduction in the sizing of the post-construction stormwater management practice, or there is an increase in the disturbance area or *impervious area*), which were not reflected in the original NOI submitted to the Department, they shall promptly submit such facts or information to the Department using the contact information in Part II.A. of this permit. Failure of the *owner or operator* to correct or supplement any relevant facts within five (5) business days of becoming aware of the deficiency shall constitute a violation of this permit.

H. Signatory Requirements

1. All NOIs and NOTs shall be signed as follows:
 - a. For a corporation these forms shall be signed by a responsible corporate officer. For the purpose of this section, a responsible corporate officer means:

- (i) a president, secretary, treasurer, or vice-president of the corporation in charge of a principal business function, or any other person who performs similar policy or decision-making functions for the corporation; or
 - (ii) the manager of one or more manufacturing, production or operating facilities, provided the manager is authorized to make management decisions which govern the operation of the regulated facility including having the explicit or implicit duty of making major capital investment recommendations, and initiating and directing other comprehensive measures to assure long term environmental compliance with environmental laws and regulations; the manager can ensure that the necessary systems are established or actions taken to gather complete and accurate information for permit application requirements; and where authority to sign documents has been assigned or delegated to the manager in accordance with corporate procedures;
 - b. For a partnership or sole proprietorship these forms shall be signed by a general partner or the proprietor, respectively; or
 - c. For a municipality, State, Federal, or other public agency these forms shall be signed by either a principal executive officer or ranking elected official. For purposes of this section, a principal executive officer of a Federal agency includes:
 - (i) the chief executive officer of the agency, or
 - (ii) a senior executive officer having responsibility for the overall operations of a principal geographic unit of the agency (e.g., Regional Administrators of EPA).
2. The SWPPP and other information requested by the Department shall be signed by a person described in Part VII.H.1. of this permit or by a duly authorized representative of that person. A person is a duly authorized representative only if:
- a. The authorization is made in writing by a person described in Part VII.H.1. of this permit;
 - b. The authorization specifies either an individual or a position having responsibility for the overall operation of the regulated facility or activity, such as the position of plant manager, operator of a well or a well field,

superintendent, position of *equivalent* responsibility, or an individual or position having overall responsibility for environmental matters for the company. (A duly authorized representative may thus be either a named individual or any individual occupying a named position) and,

- c. The written authorization shall include the name, title and signature of the authorized representative and be attached to the SWPPP.
3. All inspection reports shall be signed by the *qualified inspector* that performs the inspection.
4. The MS4 SWPPP Acceptance form shall be signed by the principal executive officer or ranking elected official from the *regulated, traditional land use control MS4*, or by a duly authorized representative of that person.

It shall constitute a permit violation if an incorrect and/or improper signatory authorizes any required forms, SWPPP and/or inspection reports.

I. Property Rights

The issuance of this permit does not convey any property rights of any sort, nor any exclusive privileges, nor does it authorize any injury to private property nor any invasion of personal rights, nor any infringement of Federal, State or local laws or regulations. *Owners or operators* must obtain any applicable conveyances, easements, licenses and/or access to real property prior to *commencing construction activity*.

J. Severability

The provisions of this permit are severable, and if any provision of this permit, or the application of any provision of this permit to any circumstance, is held invalid, the application of such provision to other circumstances, and the remainder of this permit shall not be affected thereby.

K. Requirement to Obtain Coverage Under an Alternative Permit

1. The Department may require any owner or operator authorized by this permit to apply for and/or obtain either an individual SPDES permit or another SPDES general permit. When the Department requires any discharger authorized by a general permit to apply for an individual SPDES permit, it shall notify the discharger in writing that a permit application is required. This notice shall

include a brief statement of the reasons for this decision, an application form, a statement setting a time frame for the owner or operator to file the application for an individual SPDES permit, and a deadline, not sooner than 180 days from owner or operator receipt of the notification letter, whereby the authorization to discharge under this general permit shall be terminated. Applications must be submitted to the appropriate Permit Administrator at the Regional Office. The Department may grant additional time upon demonstration, to the satisfaction of the Department, that additional time to apply for an alternative authorization is necessary or where the Department has not provided a permit determination in accordance with Part 621 of this Title.

2. When an individual SPDES permit is issued to a discharger authorized to *discharge* under a general SPDES permit for the same *discharge(s)*, the general permit authorization for outfalls authorized under the individual SPDES permit is automatically terminated on the effective date of the individual permit unless termination is earlier in accordance with 6 NYCRR Part 750.

L. Proper Operation and Maintenance

The *owner or operator* shall at all times properly operate and maintain all facilities and systems of treatment and control (and related appurtenances) which are installed or used by the *owner or operator* to achieve compliance with the conditions of this permit and with the requirements of the SWPPP.

M. Inspection and Entry

The *owner or operator* shall allow an authorized representative of the Department, EPA, applicable county health department, or, in the case of a *construction site* which *discharges* through an *MS4*, an authorized representative of the *MS4* receiving the discharge, upon the presentation of credentials and other documents as may be required by law, to:

1. Enter upon the owner's or operator's premises where a regulated facility or activity is located or conducted or where records must be kept under the conditions of this permit;
2. Have access to and copy at reasonable times, any records that must be kept under the conditions of this permit; and

3. Inspect at reasonable times any facilities or equipment (including monitoring and control equipment), practices or operations regulated or required by this permit.
4. Sample or monitor at reasonable times, for purposes of assuring permit compliance or as otherwise authorized by the Act or ECL, any substances or parameters at any location.

N. Permit Actions

This permit may, at any time, be modified, suspended, revoked, or renewed by the Department in accordance with 6 NYCRR Part 621. The filing of a request by the *owner or operator* for a permit modification, revocation and reissuance, termination, a notification of planned changes or anticipated noncompliance does not limit, diminish and/or stay compliance with any terms of this permit.

O. Definitions

Definitions of key terms are included in Appendix A of this permit.

P. Re-Opener Clause

1. If there is evidence indicating potential or realized impacts on water quality due to any stormwater discharge associated with construction activity covered by this permit, the owner or operator of such discharge may be required to obtain an individual permit or alternative general permit in accordance with Part VII.K. of this permit or the permit may be modified to include different limitations and/or requirements.
2. Any Department initiated permit modification, suspension or revocation will be conducted in accordance with 6 NYCRR Part 621, 6 NYCRR 750-1.18, and 6 NYCRR 750-1.20.

Q. Penalties for Falsification of Forms and Reports

In accordance with 6NYCRR Part 750-2.4 and 750-2.5, any person who knowingly makes any false material statement, representation, or certification in any application, record, report or other document filed or required to be maintained under this permit, including reports of compliance or noncompliance shall, upon conviction, be punished in accordance with ECL §71-1933 and or Articles 175 and 210 of the New York State Penal Law.

R. Other Permits

Nothing in this permit relieves the *owner or operator* from a requirement to obtain any other permits required by law.

APPENDIX A – Acronyms and Definitions

Acronyms

APO – Agency Preservation Officer

BMP – Best Management Practice

CPESC – Certified Professional in Erosion and Sediment Control

Cpv – Channel Protection Volume

CWA – Clean Water Act (or the Federal Water Pollution Control Act, 33 U.S.C. §1251 et seq)

DOW – Division of Water

EAF – Environmental Assessment Form

ECL - Environmental Conservation Law

EPA – U. S. Environmental Protection Agency

HSG – Hydrologic Soil Group

MS4 – Municipal Separate Storm Sewer System

NOI – Notice of Intent

NOT – Notice of Termination

NPDES – National Pollutant Discharge Elimination System

OPRHP – Office of Parks, Recreation and Historic Places

Qf – Extreme Flood

Qp – Overbank Flood

RRv – Runoff Reduction Volume

RWE – Regional Water Engineer

SEQR – State Environmental Quality Review

SEQRA - State Environmental Quality Review Act

SHPA – State Historic Preservation Act

SPDES – State Pollutant Discharge Elimination System

SWPPP – Stormwater Pollution Prevention Plan

TMDL – Total Maximum Daily Load

UPA – Uniform Procedures Act

USDA – United States Department of Agriculture

WQv – Water Quality Volume

Definitions

All definitions in this section are solely for the purposes of this permit.

Agricultural Building – a structure designed and constructed to house farm implements, hay, grain, poultry, livestock or other horticultural products; excluding any structure designed, constructed or used, in whole or in part, for human habitation, as a place of employment where agricultural products are processed, treated or packaged, or as a place used by the public.

Agricultural Property – means the land for construction of a barn, *agricultural building*, silo, stockyard, pen or other structural practices identified in Table II in the “Agricultural Management Practices Catalog for Nonpoint Source Pollution in New York State” prepared by the Department in cooperation with agencies of New York Nonpoint Source Coordinating Committee (dated June 2007).

Alter Hydrology from Pre to Post-Development Conditions - means the post-development peak flow rate(s) has increased by more than 5% of the pre-developed condition for the design storm of interest (e.g. 10 yr and 100 yr).

Combined Sewer - means a sewer that is designed to collect and convey both “sewage” and “stormwater”.

Commence (Commencement of) Construction Activities - means the initial disturbance of soils associated with clearing, grading or excavation activities; or other construction related activities that disturb or expose soils such as demolition, stockpiling of fill material, and the initial installation of erosion and sediment control practices required in the SWPPP. See definition for “*Construction Activity(ies)*” also.

Construction Activity(ies) - means any clearing, grading, excavation, filling, demolition or stockpiling activities that result in soil disturbance. Clearing activities can include, but are not limited to, logging equipment operation, the cutting and skidding of trees, stump removal and/or brush root removal. Construction activity does not include routine maintenance that is performed to maintain the original line and grade, hydraulic capacity, or original purpose of a facility.

Construction Site – means the land area where *construction activity(ies)* will occur. See definition for “*Commence (Commencement of) Construction Activities*” and “*Larger Common Plan of Development or Sale*” also.

Dewatering – means the act of draining rainwater and/or groundwater from building foundations, vaults or excavations/trenches.

Direct Discharge (to a specific surface waterbody) - means that runoff flows from a *construction site* by overland flow and the first point of discharge is the specific surface waterbody, or runoff flows from a *construction site* to a separate storm sewer system

and the first point of discharge from the separate storm sewer system is the specific surface waterbody.

Discharge(s) - means any addition of any pollutant to waters of the State through an outlet or *point source*.

Embankment – means an earthen or rock slope that supports a road/highway.

Endangered or Threatened Species – see 6 NYCRR Part 182 of the Department’s rules and regulations for definition of terms and requirements.

Environmental Conservation Law (ECL) - means chapter 43-B of the Consolidated Laws of the State of New York, entitled the Environmental Conservation Law.

Equivalent (Equivalence) – means that the practice or measure meets all the performance, longevity, maintenance, and safety objectives of the technical standard and will provide an equal or greater degree of water quality protection.

Final Stabilization - means that all soil disturbance activities have ceased and a uniform, perennial vegetative cover with a density of eighty (80) percent over the entire pervious surface has been established; or other equivalent stabilization measures, such as permanent landscape mulches, rock rip-rap or washed/crushed stone have been applied on all disturbed areas that are not covered by permanent structures, concrete or pavement.

General SPDES permit - means a SPDES permit issued pursuant to 6 NYCRR Part 750-1.21 and Section 70-0117 of the ECL authorizing a category of discharges.

Groundwater(s) - means waters in the saturated zone. The saturated zone is a subsurface zone in which all the interstices are filled with water under pressure greater than that of the atmosphere. Although the zone may contain gas-filled interstices or interstices filled with fluids other than water, it is still considered saturated.

Historic Property – means any building, structure, site, object or district that is listed on the State or National Registers of Historic Places or is determined to be eligible for listing on the State or National Registers of Historic Places.

Impervious Area (Cover) - means all impermeable surfaces that cannot effectively infiltrate rainfall. This includes paved, concrete and gravel surfaces (i.e. parking lots, driveways, roads, runways and sidewalks); building rooftops and miscellaneous impermeable structures such as patios, pools, and sheds.

Infeasible – means not technologically possible, or not economically practicable and achievable in light of best industry practices.

Larger Common Plan of Development or Sale - means a contiguous area where multiple separate and distinct *construction activities* are occurring, or will occur, under one plan. The term “plan” in “larger common plan of development or sale” is broadly defined as any announcement or piece of documentation (including a sign, public notice or hearing, marketing plan, advertisement, drawing, permit application, State Environmental Quality Review Act (SEQRA) environmental assessment form or other documents, zoning request, computer design, etc.) or physical demarcation (including boundary signs, lot stakes, surveyor markings, etc.) indicating that *construction activities* may occur on a specific plot.

For discrete construction projects that are located within a larger common plan of development or sale that are at least 1/4 mile apart, each project can be treated as a separate plan of development or sale provided any interconnecting road, pipeline or utility project that is part of the same “common plan” is not concurrently being disturbed.

Minimize – means reduce and/or eliminate to the extent achievable using control measures (including best management practices) that are technologically available and economically practicable and achievable in light of best industry practices.

Municipal Separate Storm Sewer (MS4) - a conveyance or system of conveyances (including roads with drainage systems, municipal streets, catch basins, curbs, gutters, ditches, man-made channels, or storm drains):

- (i) Owned or operated by a State, city, town, borough, county, parish, district, association, or other public body (created by or pursuant to State law) having jurisdiction over disposal of sewage, industrial wastes, stormwater, or other wastes, including special districts under State law such as a sewer district, flood control district or drainage district, or similar entity, or an Indian tribe or an authorized Indian tribal organization, or a designated and approved management agency under section 208 of the CWA that discharges to surface waters of the State;
- (ii) Designed or used for collecting or conveying stormwater;
- (iii) Which is not a *combined sewer*, and
- (iv) Which is not part of a Publicly Owned Treatment Works (POTW) as defined at 40 CFR 122.2.

National Pollutant Discharge Elimination System (NPDES) - means the national system for the issuance of wastewater and stormwater permits under the Federal Water Pollution Control Act (Clean Water Act).

Natural Buffer –means an undisturbed area with natural cover running along a surface water (e.g. wetland, stream, river, lake, etc.).

New Development – means any land disturbance that does not meet the definition of Redevelopment Activity included in this appendix.

New York State Erosion and Sediment Control Certificate Program – a certificate program that establishes and maintains a process to identify and recognize individuals who are capable of developing, designing, inspecting and maintaining erosion and sediment control plans on projects that disturb soils in New York State. The certificate program is administered by the New York State Conservation District Employees Association.

NOI Acknowledgment Letter - means the letter that the Department sends to an owner or operator to acknowledge the Department's receipt and acceptance of a complete Notice of Intent. This letter documents the owner's or operator's authorization to discharge in accordance with the general permit for stormwater discharges from *construction activity*.

Nonpoint Source - means any source of water pollution or pollutants which is not a discrete conveyance or *point source* permitted pursuant to Title 7 or 8 of Article 17 of the Environmental Conservation Law (see ECL Section 17-1403).

Overbank –means flow events that exceed the capacity of the stream channel and spill out into the adjacent floodplain.

Owner or Operator - means the person, persons or legal entity which owns or leases the property on which the *construction activity* is occurring; an entity that has operational control over the construction plans and specifications, including the ability to make modifications to the plans and specifications; and/or an entity that has day-to-day operational control of those activities at a project that are necessary to ensure compliance with the permit conditions.

Performance Criteria – means the design criteria listed under the “Required Elements” sections in Chapters 5, 6 and 10 of the technical standard, New York State Stormwater Management Design Manual, dated January 2015. It does not include the Sizing Criteria (i.e. WQv, RRv, Cpv, Qp and Qf) in Part I.C.2. of the permit.

Point Source - means any discernible, confined and discrete conveyance, including but not limited to any pipe, ditch, channel, tunnel, conduit, well, discrete fissure, container, rolling stock, concentrated animal feeding operation, vessel or other floating craft, or landfill leachate collection system from which *pollutants* are or may be discharged.

Pollutant - means dredged spoil, filter backwash, solid waste, incinerator residue, sewage, garbage, sewage sludge, munitions, chemical wastes, biological materials, radioactive materials, heat, wrecked or discarded equipment, rock, sand and industrial, municipal, agricultural waste and ballast discharged into water; which may cause or might reasonably be expected to cause pollution of the waters of the state in contravention of the standards or guidance values adopted as provided in 6 NYCRR Parts 700 et seq .

Qualified Inspector - means a person that is knowledgeable in the principles and practices of erosion and sediment control, such as a licensed Professional Engineer, Certified Professional in Erosion and Sediment Control (CPESC), Registered Landscape Architect, New York State Erosion and Sediment Control Certificate Program holder or other Department endorsed individual(s).

It can also mean someone working under the direct supervision of, and at the same company as, the licensed Professional Engineer or Registered Landscape Architect, provided that person has training in the principles and practices of erosion and sediment control. Training in the principles and practices of erosion and sediment control means that the individual working under the direct supervision of the licensed Professional Engineer or Registered Landscape Architect has received four (4) hours of Department endorsed training in proper erosion and sediment control principles from a Soil and Water Conservation District, or other Department endorsed entity. After receiving the initial training, the individual working under the direct supervision of the licensed Professional Engineer or Registered Landscape Architect shall receive four (4) hours of training every three (3) years.

It can also mean a person that meets the *Qualified Professional* qualifications in addition to the *Qualified Inspector* qualifications.

Note: Inspections of any post-construction stormwater management practices that include structural components, such as a dam for an impoundment, shall be performed by a licensed Professional Engineer.

Qualified Professional - means a person that is knowledgeable in the principles and practices of stormwater management and treatment, such as a licensed Professional Engineer, Registered Landscape Architect or other Department endorsed individual(s). Individuals preparing SWPPPs that require the post-construction stormwater management practice component must have an understanding of the principles of hydrology, water quality management practice design, water quantity control design, and, in many cases, the principles of hydraulics. All components of the SWPPP that involve the practice of engineering, as defined by the NYS Education Law (see Article 145), shall be prepared by, or under the direct supervision of, a professional engineer licensed to practice in the State of New York.

Redevelopment Activity(ies) – means the disturbance and reconstruction of existing impervious area, including impervious areas that were removed from a project site within five (5) years of preliminary project plan submission to the local government (i.e. site plan, subdivision, etc.).

Regulated, Traditional Land Use Control MS4 - means a city, town or village with land use control authority that is authorized to discharge under New York State DEC's

SPDES General Permit For Stormwater Discharges from Municipal Separate Stormwater Sewer Systems (MS4s) or the City of New York's Individual SPDES Permit for their Municipal Separate Storm Sewer Systems (NY-0287890).

Routine Maintenance Activity - means *construction activity* that is performed to maintain the original line and grade, hydraulic capacity, or original purpose of a facility, including, but not limited to:

- Re-grading of gravel roads or parking lots,
- Cleaning and shaping of existing roadside ditches and culverts that maintains the approximate original line and grade, and hydraulic capacity of the ditch,
- Cleaning and shaping of existing roadside ditches that does not maintain the approximate original grade, hydraulic capacity and purpose of the ditch if the changes to the line and grade, hydraulic capacity or purpose of the ditch are installed to improve water quality and quantity controls (e.g. installing grass lined ditch),
- Placement of aggregate shoulder backing that stabilizes the transition between the road shoulder and the ditch or *embankment*,
- Full depth milling and filling of existing asphalt pavements, replacement of concrete pavement slabs, and similar work that does not expose soil or disturb the bottom six (6) inches of subbase material,
- Long-term use of equipment storage areas at or near highway maintenance facilities,
- Removal of sediment from the edge of the highway to restore a previously existing sheet-flow drainage connection from the highway surface to the highway ditch or *embankment*,
- Existing use of Canal Corp owned upland disposal sites for the canal, and
- Replacement of curbs, gutters, sidewalks and guide rail posts.

Site limitations – means site conditions that prevent the use of an infiltration technique and or infiltration of the total WQv. Typical site limitations include: seasonal high groundwater, shallow depth to bedrock, and soils with an infiltration rate less than 0.5 inches/hour. The existence of site limitations shall be confirmed and documented using actual field testing (i.e. test pits, soil borings, and infiltration test) or using information from the most current United States Department of Agriculture (USDA) Soil Survey for the County where the project is located.

Sizing Criteria – means the criteria included in Part I.C.2 of the permit that are used to size post-construction stormwater management control practices. The criteria include; Water Quality Volume (WQv), Runoff Reduction Volume (RRv), Channel Protection Volume (Cpv), *Overbank Flood* (Qp), and *Extreme Flood* (Qf).

State Pollutant Discharge Elimination System (SPDES) - means the system established pursuant to Article 17 of the ECL and 6 NYCRR Part 750 for issuance of permits authorizing discharges to the waters of the state.

Steep Slope – means land area designated on the current United States Department of Agriculture (“USDA”) Soil Survey as Soil Slope Phase “D”, (provided the map unit name is inclusive of slopes greater than 25%) , or Soil Slope Phase E or F, (regardless of the map unit name), or a combination of the three designations.

Streambank – as used in this permit, means the terrain alongside the bed of a creek or stream. The bank consists of the sides of the channel, between which the flow is confined.

Stormwater Pollution Prevention Plan (SWPPP) – means a project specific report, including construction drawings, that among other things: describes the construction activity(ies), identifies the potential sources of pollution at the *construction site*; describes and shows the stormwater controls that will be used to control the pollutants (i.e. erosion and sediment controls; for many projects, includes post-construction stormwater management controls); and identifies procedures the *owner or operator* will implement to comply with the terms and conditions of the permit. See Part III of the permit for a complete description of the information that must be included in the SWPPP.

Surface Waters of the State - shall be construed to include lakes, bays, sounds, ponds, impounding reservoirs, springs, rivers, streams, creeks, estuaries, marshes, inlets, canals, the Atlantic ocean within the territorial seas of the state of New York and all other bodies of surface water, natural or artificial, inland or coastal, fresh or salt, public or private (except those private waters that do not combine or effect a junction with natural surface waters), which are wholly or partially within or bordering the state or within its jurisdiction. Waters of the state are further defined in 6 NYCRR Parts 800 to 941.

Temporarily Ceased – means that an existing disturbed area will not be disturbed again within 14 calendar days of the previous soil disturbance.

Temporary Stabilization - means that exposed soil has been covered with material(s) as set forth in the technical standard, New York Standards and Specifications for Erosion and Sediment Control, to prevent the exposed soil from eroding. The materials can include, but are not limited to, mulch, seed and mulch, and erosion control mats (e.g. jute twisted yarn, excelsior wood fiber mats).

Total Maximum Daily Loads (TMDLs) - A TMDL is the sum of the allowable loads of a single pollutant from all contributing point and *nonpoint sources*. It is a calculation of the maximum amount of a pollutant that a waterbody can receive on a daily basis and still meet *water quality standards*, and an allocation of that amount to the pollutant's sources. A TMDL stipulates wasteload allocations (WLAs) for *point source* discharges, load allocations (LAs) for *nonpoint sources*, and a margin of safety (MOS).

Trained Contractor - means an employee from the contracting (construction) company, identified in Part III.A.6., that has received four (4) hours of Department endorsed

training in proper erosion and sediment control principles from a Soil and Water Conservation District, or other Department endorsed entity. After receiving the initial training, the *trained contractor* shall receive four (4) hours of training every three (3) years.

It can also mean an employee from the contracting (construction) company, identified in Part III.A.6., that meets the *qualified inspector* qualifications (e.g. licensed Professional Engineer, Certified Professional in Erosion and Sediment Control (CPESC), Registered Landscape Architect, New York State Erosion and Sediment Control Certificate Program holder, or someone working under the direct supervision of, and at the same company as, the licensed Professional Engineer or Registered Landscape Architect, provided they have received four (4) hours of Department endorsed training in proper erosion and sediment control principles from a Soil and Water Conservation District, or other Department endorsed entity).

The *trained contractor* is responsible for the day to day implementation of the SWPPP.

Uniform Procedures Act (UPA) Permit - means a permit required under 6 NYCRR Part 621 of the Environmental Conservation Law (ECL), Article 70.

Water Quality Standard - means such measures of purity or quality for any waters in relation to their reasonable and necessary use as promulgated in 6 NYCRR Part 700 et seq.

APPENDIX B – Required SWPPP Components by Project Type

Table 1
Construction Activities that Require the Preparation of a SWPPP That Only Includes Erosion and Sediment Controls

<p>The following construction activities that involve soil disturbances of one (1) or more acres of land, but less than five (5) acres:</p> <ul style="list-style-type: none">• Single family home <u>not</u> located in one of the watersheds listed in Appendix C or <u>not directly discharging</u> to one of the 303(d) segments listed in Appendix E• Single family residential subdivisions with 25% or less impervious cover at total site build-out and <u>not</u> located in one of the watersheds listed in Appendix C and <u>not</u> directly discharging to one of the 303(d) segments listed in Appendix E• Construction of a barn or other <i>agricultural building</i>, silo, stock yard or pen.
<p>The following construction activities that involve soil disturbances between five thousand (5000) square feet and one (1) acre of land:</p> <p>All construction activities located in the watersheds identified in Appendix D that involve soil disturbances between five thousand (5,000) square feet and one (1) acre of land.</p>
<p>The following construction activities that involve soil disturbances of one (1) or more acres of land:</p> <ul style="list-style-type: none">• Installation of underground, linear utilities; such as gas lines, fiber-optic cable, cable TV, electric, telephone, sewer mains, and water mains• Environmental enhancement projects, such as wetland mitigation projects, stormwater retrofits and stream restoration projects• Pond construction• Linear bike paths running through areas with vegetative cover, including bike paths surfaced with an impervious cover• Cross-country ski trails and walking/hiking trails• Sidewalk, bike path or walking path projects, surfaced with an impervious cover, that are not part of residential, commercial or institutional development;• Sidewalk, bike path or walking path projects, surfaced with an impervious cover, that include incidental shoulder or curb work along an existing highway to support construction of the sidewalk, bike path or walking path.• Slope stabilization projects• Slope flattening that changes the grade of the site, but does not significantly change the runoff characteristics

Table 1 (Continued) CONSTRUCTION ACTIVITIES THAT REQUIRE THE PREPARATION OF A SWPPP THAT ONLY INCLUDES EROSION AND SEDIMENT CONTROLS

The following construction activities that involve soil disturbances of one (1) or more acres of land:

- Spoil areas that will be covered with vegetation
- Vegetated open space projects (i.e. recreational parks, lawns, meadows, fields, downhill ski trails) excluding projects that *alter hydrology from pre to post development* conditions,
- Athletic fields (natural grass) that do not include the construction or reconstruction of *impervious area* and do not *alter hydrology from pre to post development* conditions
- Demolition project where vegetation will be established, and no redevelopment is planned
- Overhead electric transmission line project that does not include the construction of permanent access roads or parking areas surfaced with *impervious cover*
- Structural practices as identified in Table II in the “Agricultural Management Practices Catalog for Nonpoint Source Pollution in New York State”, excluding projects that involve soil disturbances of greater than five acres and construction activities that include the construction or reconstruction of impervious area
- Temporary access roads, median crossovers, detour roads, lanes, or other temporary impervious areas that will be restored to pre-construction conditions once the construction activity is complete

Table 2
CONSTRUCTION ACTIVITIES THAT REQUIRE THE PREPARATION OF A SWPPP THAT INCLUDES
POST-CONSTRUCTION STORMWATER MANAGEMENT PRACTICES

The following construction activities that involve soil disturbances of one (1) or more acres of land:

- Single family home located in one of the watersheds listed in Appendix C or *directly discharging* to one of the 303(d) segments listed in Appendix E
- Single family home that disturbs five (5) or more acres of land
- Single family residential subdivisions located in one of the watersheds listed in Appendix C or *directly discharging* to one of the 303(d) segments listed in Appendix E
- Single family residential subdivisions that involve soil disturbances of between one (1) and five (5) acres of land with greater than 25% impervious cover at total site build-out
- Single family residential subdivisions that involve soil disturbances of five (5) or more acres of land, and single family residential subdivisions that involve soil disturbances of less than five (5) acres that are part of a larger common plan of development or sale that will ultimately disturb five or more acres of land
- Multi-family residential developments; includes duplexes, townhomes, condominiums, senior housing complexes, apartment complexes, and mobile home parks
- Airports
- Amusement parks
- Breweries, cideries, and wineries, including establishments constructed on agricultural land
- Campgrounds
- Cemeteries that include the construction or reconstruction of impervious area (>5% of disturbed area) or *alter the hydrology from pre to post development* conditions
- Commercial developments
- Churches and other places of worship
- Construction of a barn or other *agricultural building* (e.g. silo) and structural practices as identified in Table II in the "Agricultural Management Practices Catalog for Nonpoint Source Pollution in New York State" that include the construction or reconstruction of *impervious area*, excluding projects that involve soil disturbances of less than five acres.
- Golf courses
- Institutional development; includes hospitals, prisons, schools and colleges
- Industrial facilities; includes industrial parks
- Landfills
- Municipal facilities; includes highway garages, transfer stations, office buildings, POTW's, water treatment plants, and water storage tanks
- Office complexes
- Playgrounds that include the construction or reconstruction of impervious area
- Sports complexes
- Racetracks; includes racetracks with earthen (dirt) surface
- Road construction or reconstruction, including roads constructed as part of the construction activities listed in Table 1

Table 2 (Continued)

CONSTRUCTION ACTIVITIES THAT REQUIRE THE PREPARATION OF A SWPPP THAT INCLUDES POST-CONSTRUCTION STORMWATER MANAGEMENT PRACTICES

The following construction activities that involve soil disturbances of one (1) or more acres of land:

- Parking lot construction or reconstruction, including parking lots constructed as part of the construction activities listed in Table 1
- Athletic fields (natural grass) that include the construction or reconstruction of impervious area (>5% of disturbed area) or *alter the hydrology from pre to post development* conditions
- Athletic fields with artificial turf
- Permanent access roads, parking areas, substations, compressor stations and well drilling pads, surfaced with *impervious cover*, and constructed as part of an over-head electric transmission line project, wind-power project, cell tower project, oil or gas well drilling project, sewer or water main project or other linear utility project
- Sidewalk, bike path or walking path projects, surfaced with an impervious cover, that are part of a residential, commercial or institutional development
- Sidewalk, bike path or walking path projects, surfaced with an impervious cover, that are part of a highway construction or reconstruction project
- All other construction activities that include the construction or reconstruction of *impervious area* or *alter the hydrology from pre to post development* conditions, and are not listed in Table 1

APPENDIX C – Watersheds Requiring Enhanced Phosphorus Removal

Watersheds where *owners or operators* of construction activities identified in Table 2 of Appendix B must prepare a SWPPP that includes post-construction stormwater management practices designed in conformance with the Enhanced Phosphorus Removal Standards included in the technical standard, New York State Stormwater Management Design Manual (“Design Manual”).

- Entire New York City Watershed located east of the Hudson River - Figure 1
- Onondaga Lake Watershed - Figure 2
- Greenwood Lake Watershed -Figure 3
- Oscawana Lake Watershed – Figure 4
- Kinderhook Lake Watershed – Figure 5

Figure 1 - New York City Watershed East of the Hudson

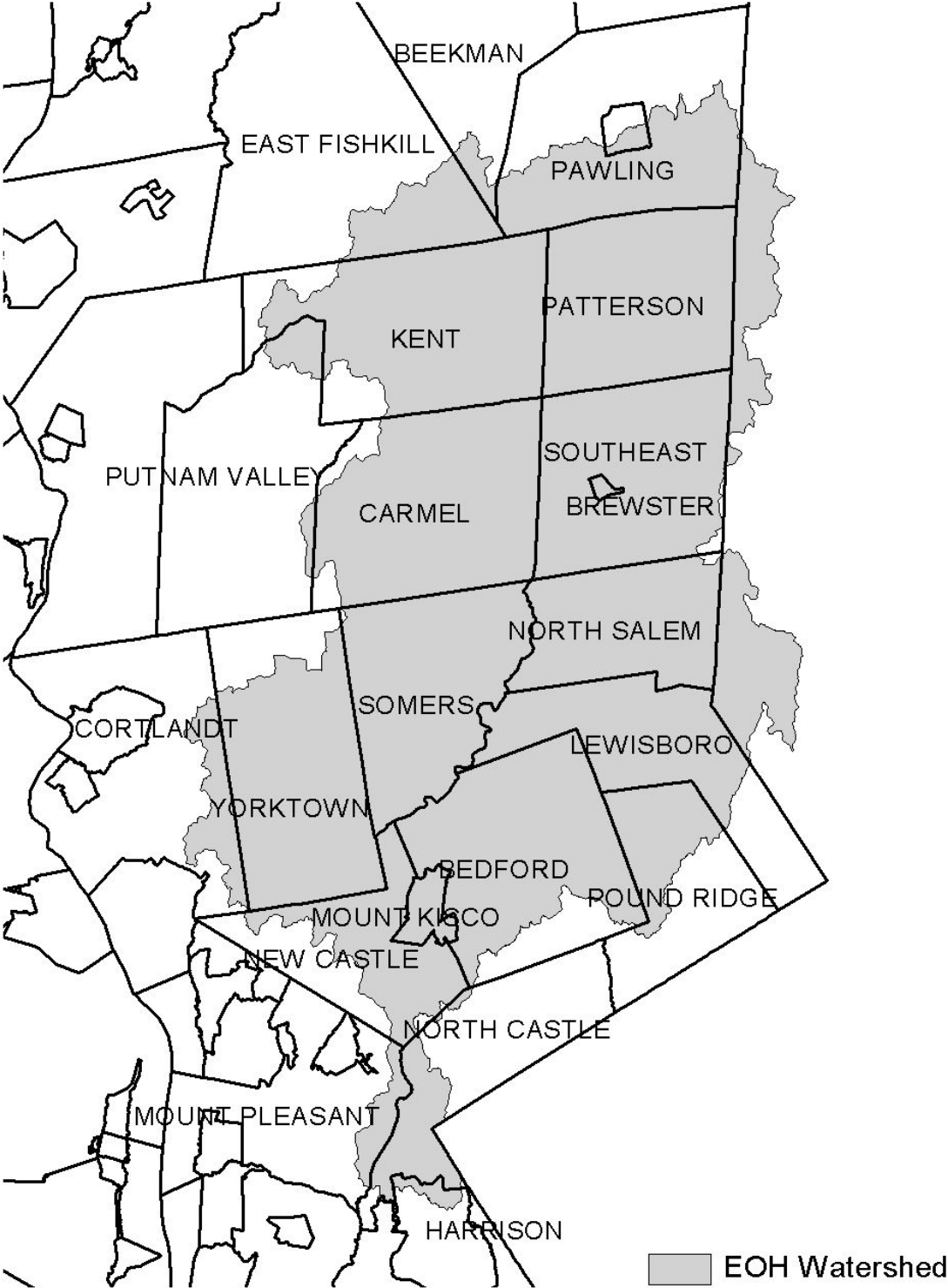

Figure 2 - Onondaga Lake Watershed



Figure 3 - Greenwood Lake Watershed



Figure 4 - Oscawana Lake Watershed

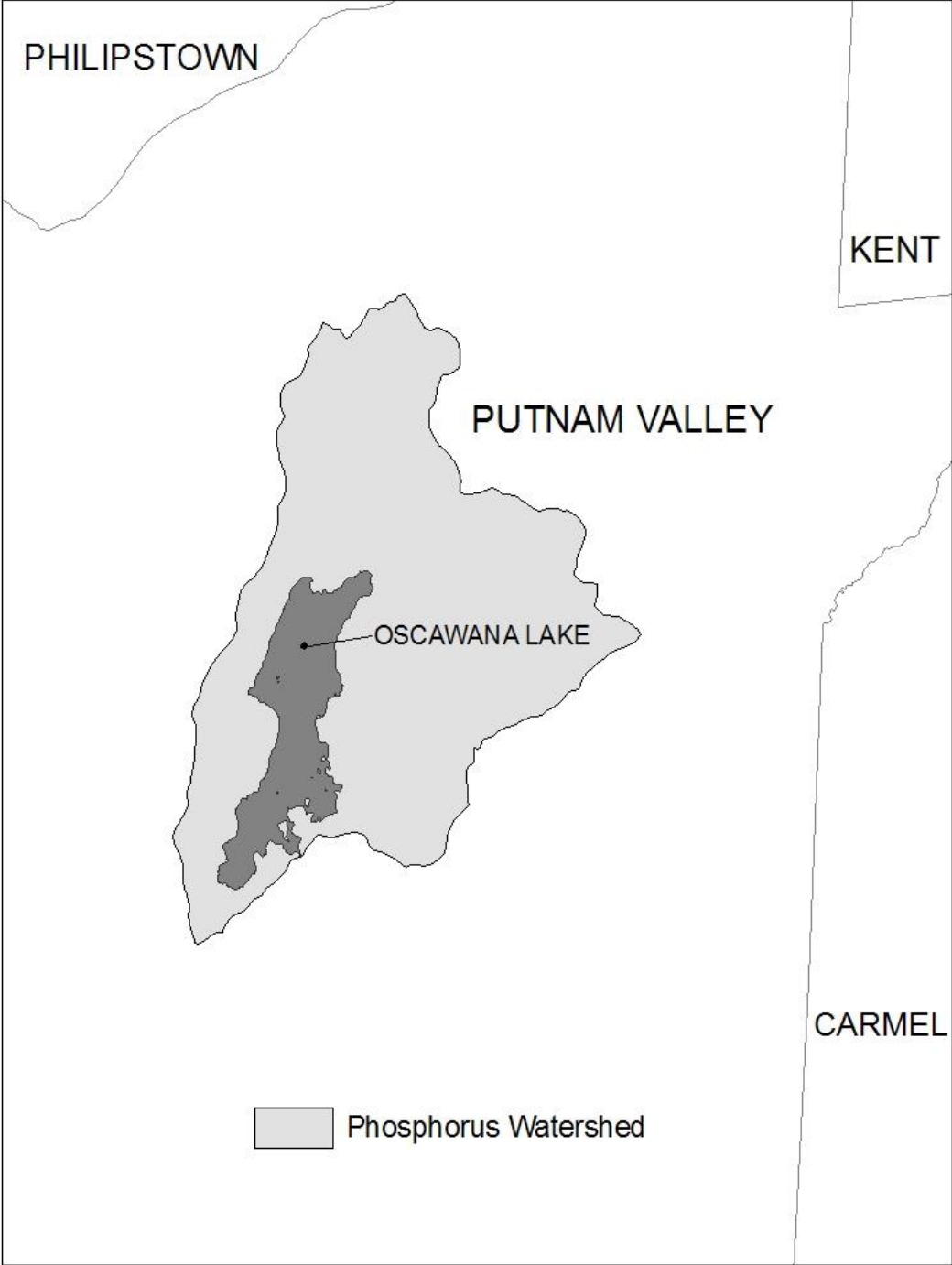
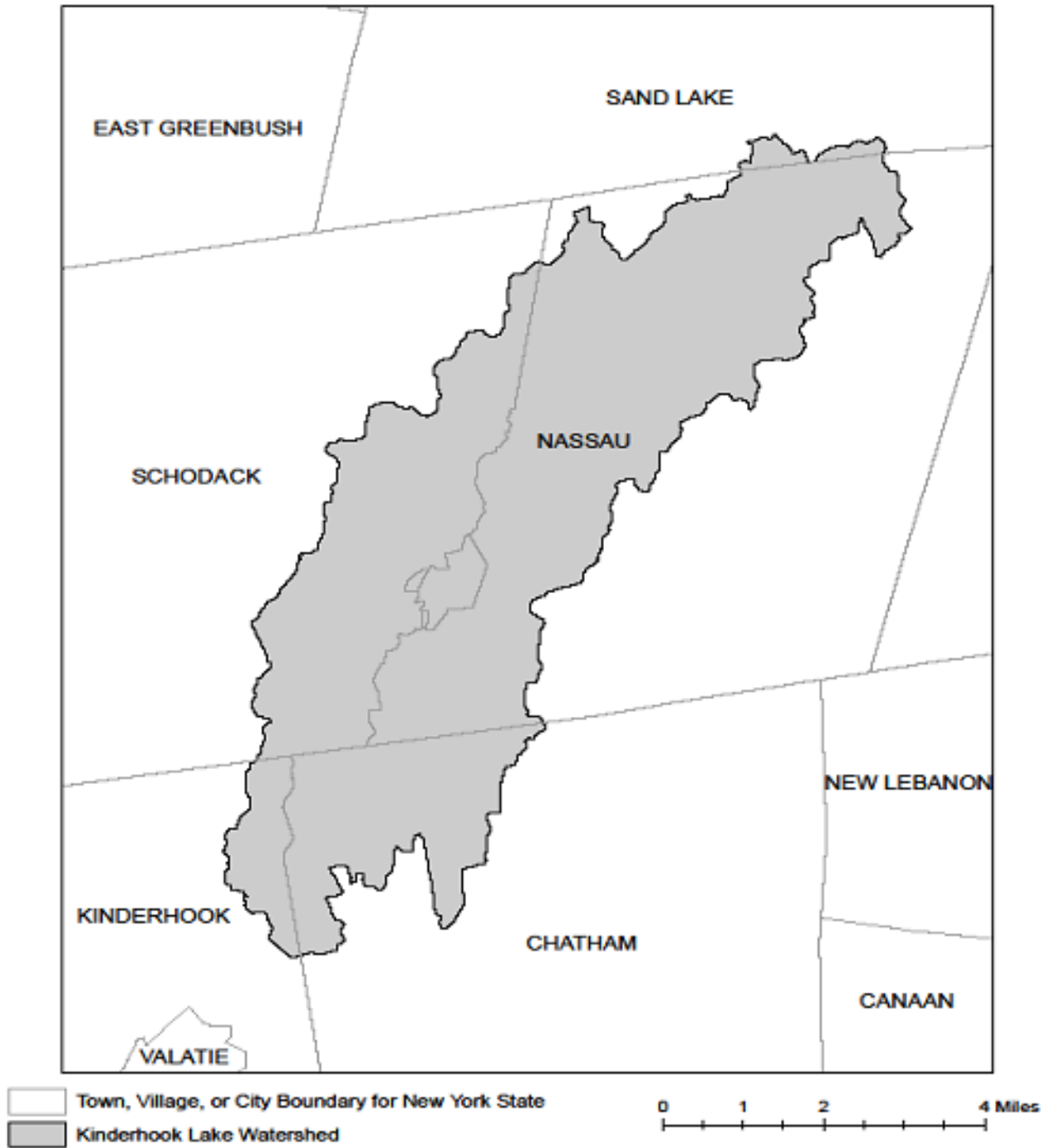

Figure 5 - Kinderhook Lake Watershed



APPENDIX D – Watersheds with Lower Disturbance Threshold

Watersheds where *owners or operators* of construction activities that involve soil disturbances between five thousand (5000) square feet and one (1) acre of land must obtain coverage under this permit.

Entire New York City Watershed that is located east of the Hudson River - See Figure 1 in Appendix C

APPENDIX E – 303(d) Segments Impaired by Construction Related Pollutant(s)

List of 303(d) segments impaired by pollutants related to *construction activity* (e.g. silt, sediment or nutrients). The list was developed using "The Final New York State 2016 Section 303(d) List of Impaired Waters Requiring a TMDL/Other Strategy" dated November 2016. *Owners or operators* of single family home and single family residential subdivisions with 25% or less total impervious cover at total site build-out that involve soil disturbances of one or more acres of land, but less than 5 acres, and *directly discharge* to one of the listed segments below shall prepare a SWPPP that includes post-construction stormwater management practices designed in conformance with the New York State Stormwater Management Design Manual ("Design Manual"), dated January 2015.

COUNTY	WATERBODY	POLLUTANT
Albany	Ann Lee (Shakers) Pond, Stump Pond	Nutrients
Albany	Basic Creek Reservoir	Nutrients
Allegany	Amity Lake, Saunders Pond	Nutrients
Bronx	Long Island Sound, Bronx	Nutrients
Bronx	Van Cortlandt Lake	Nutrients
Broome	Fly Pond, Deer Lake, Sky Lake	Nutrients
Broome	Minor Tribs to Lower Susquehanna (north)	Nutrients
Broome	Whitney Point Lake/Reservoir	Nutrients
Cattaraugus	Allegheny River/Reservoir	Nutrients
Cattaraugus	Beaver (Alma) Lake	Nutrients
Cattaraugus	Case Lake	Nutrients
Cattaraugus	Linlyco/Club Pond	Nutrients
Cayuga	Duck Lake	Nutrients
Cayuga	Little Sodus Bay	Nutrients
Chautauqua	Bear Lake	Nutrients
Chautauqua	Chadakoin River and tribs	Nutrients
Chautauqua	Chautauqua Lake, North	Nutrients
Chautauqua	Chautauqua Lake, South	Nutrients
Chautauqua	Findley Lake	Nutrients
Chautauqua	Hulburt/Clymer Pond	Nutrients
Clinton	Great Chazy River, Lower, Main Stem	Silt/Sediment
Clinton	Lake Champlain, Main Lake, Middle	Nutrients
Clinton	Lake Champlain, Main Lake, North	Nutrients
Columbia	Kinderhook Lake	Nutrients
Columbia	Robinson Pond	Nutrients
Cortland	Dean Pond	Nutrients

303(d) Segments Impaired by Construction Related Pollutant(s)

Dutchess	Fall Kill and tribs	Nutrients
Dutchess	Hillside Lake	Nutrients
Dutchess	Wappingers Lake	Nutrients
Dutchess	Wappingers Lake	Silt/Sediment
Erie	Beeman Creek and tribs	Nutrients
Erie	Ellicott Creek, Lower, and tribs	Silt/Sediment
Erie	Ellicott Creek, Lower, and tribs	Nutrients
Erie	Green Lake	Nutrients
Erie	Little Sister Creek, Lower, and tribs	Nutrients
Erie	Murder Creek, Lower, and tribs	Nutrients
Erie	Rush Creek and tribs	Nutrients
Erie	Scajaquada Creek, Lower, and tribs	Nutrients
Erie	Scajaquada Creek, Middle, and tribs	Nutrients
Erie	Scajaquada Creek, Upper, and tribs	Nutrients
Erie	South Branch Smoke Cr, Lower, and tribs	Silt/Sediment
Erie	South Branch Smoke Cr, Lower, and tribs	Nutrients
Essex	Lake Champlain, Main Lake, South	Nutrients
Essex	Lake Champlain, South Lake	Nutrients
Essex	Willsboro Bay	Nutrients
Genesee	Bigelow Creek and tribs	Nutrients
Genesee	Black Creek, Middle, and minor tribs	Nutrients
Genesee	Black Creek, Upper, and minor tribs	Nutrients
Genesee	Bowen Brook and tribs	Nutrients
Genesee	LeRoy Reservoir	Nutrients
Genesee	Oak Orchard Cr, Upper, and tribs	Nutrients
Genesee	Tonawanda Creek, Middle, Main Stem	Nutrients
Greene	Schoharie Reservoir	Silt/Sediment
Greene	Sleepy Hollow Lake	Silt/Sediment
Herkimer	Steele Creek tribs	Silt/Sediment
Herkimer	Steele Creek tribs	Nutrients
Jefferson	Moon Lake	Nutrients
Kings	Hendrix Creek	Nutrients
Kings	Prospect Park Lake	Nutrients
Lewis	Mill Creek/South Branch, and tribs	Nutrients
Livingston	Christie Creek and tribs	Nutrients
Livingston	Conesus Lake	Nutrients
Livingston	Mill Creek and minor tribs	Silt/Sediment
Monroe	Black Creek, Lower, and minor tribs	Nutrients
Monroe	Buck Pond	Nutrients
Monroe	Cranberry Pond	Nutrients

303(d) Segments Impaired by Construction Related Pollutant(s)

Monroe	Lake Ontario Shoreline, Western	Nutrients
Monroe	Long Pond	Nutrients
Monroe	Mill Creek and tribs	Nutrients
Monroe	Mill Creek/Blue Pond Outlet and tribs	Nutrients
Monroe	Minor Tribs to Irondequoit Bay	Nutrients
Monroe	Rochester Embayment - East	Nutrients
Monroe	Rochester Embayment - West	Nutrients
Monroe	Shipbuilders Creek and tribs	Nutrients
Monroe	Thomas Creek/White Brook and tribs	Nutrients
Nassau	Beaver Lake	Nutrients
Nassau	Camaans Pond	Nutrients
Nassau	East Meadow Brook, Upper, and tribs	Silt/Sediment
Nassau	East Rockaway Channel	Nutrients
Nassau	Grant Park Pond	Nutrients
Nassau	Hempstead Bay	Nutrients
Nassau	Hempstead Lake	Nutrients
Nassau	Hewlett Bay	Nutrients
Nassau	Hog Island Channel	Nutrients
Nassau	Long Island Sound, Nassau County Waters	Nutrients
Nassau	Massapequa Creek and tribs	Nutrients
Nassau	Milburn/Parsonage Creeks, Upp, and tribs	Nutrients
Nassau	Reynolds Channel, west	Nutrients
Nassau	Tidal Tribs to Hempstead Bay	Nutrients
Nassau	Tribs (fresh) to East Bay	Nutrients
Nassau	Tribs (fresh) to East Bay	Silt/Sediment
Nassau	Tribs to Smith/Halls Ponds	Nutrients
Nassau	Woodmere Channel	Nutrients
New York	Harlem Meer	Nutrients
New York	The Lake in Central Park	Nutrients
Niagara	Bergholtz Creek and tribs	Nutrients
Niagara	Hyde Park Lake	Nutrients
Niagara	Lake Ontario Shoreline, Western	Nutrients
Niagara	Lake Ontario Shoreline, Western	Nutrients
Oneida	Ballou, Nail Creeks and tribs	Nutrients
Onondaga	Harbor Brook, Lower, and tribs	Nutrients
Onondaga	Ley Creek and tribs	Nutrients
Onondaga	Minor Tribs to Onondaga Lake	Nutrients
Onondaga	Ninemile Creek, Lower, and tribs	Nutrients
Onondaga	Onondaga Creek, Lower, and tribs	Nutrients
Onondaga	Onondaga Creek, Middle, and tribs	Nutrients

303(d) Segments Impaired by Construction Related Pollutant(s)

Onondaga	Onondaga Lake, northern end	Nutrients
Onondaga	Onondaga Lake, southern end	Nutrients
Ontario	Great Brook and minor tribs	Silt/Sediment
Ontario	Great Brook and minor tribs	Nutrients
Ontario	Hemlock Lake Outlet and minor tribs	Nutrients
Ontario	Honeoye Lake	Nutrients
Orange	Greenwood Lake	Nutrients
Orange	Monhagen Brook and tribs	Nutrients
Orange	Orange Lake	Nutrients
Orleans	Lake Ontario Shoreline, Western	Nutrients
Orleans	Lake Ontario Shoreline, Western	Nutrients
Oswego	Lake Neatahwanta	Nutrients
Oswego	Pleasant Lake	Nutrients
Putnam	Bog Brook Reservoir	Nutrients
Putnam	Boyd Corners Reservoir	Nutrients
Putnam	Croton Falls Reservoir	Nutrients
Putnam	Diverting Reservoir	Nutrients
Putnam	East Branch Reservoir	Nutrients
Putnam	Lake Carmel	Nutrients
Putnam	Middle Branch Reservoir	Nutrients
Putnam	Oscawana Lake	Nutrients
Putnam	Palmer Lake	Nutrients
Putnam	West Branch Reservoir	Nutrients
Queens	Bergen Basin	Nutrients
Queens	Flushing Creek/Bay	Nutrients
Queens	Jamaica Bay, Eastern, and tribs (Queens)	Nutrients
Queens	Kissena Lake	Nutrients
Queens	Meadow Lake	Nutrients
Queens	Willow Lake	Nutrients
Rensselaer	Nassau Lake	Nutrients
Rensselaer	Snyders Lake	Nutrients
Richmond	Grasmere Lake/Bradys Pond	Nutrients
Rockland	Congers Lake, Swartout Lake	Nutrients
Rockland	Rockland Lake	Nutrients
Saratoga	Ballston Lake	Nutrients
Saratoga	Dwaas Kill and tribs	Silt/Sediment
Saratoga	Dwaas Kill and tribs	Nutrients
Saratoga	Lake Lonely	Nutrients
Saratoga	Round Lake	Nutrients
Saratoga	Tribs to Lake Lonely	Nutrients

303(d) Segments Impaired by Construction Related Pollutant(s)

Schenectady	Collins Lake	Nutrients
Schenectady	Duane Lake	Nutrients
Schenectady	Mariaville Lake	Nutrients
Schoharie	Engleville Pond	Nutrients
Schoharie	Summit Lake	Nutrients
Seneca	Reeder Creek and tribs	Nutrients
St.Lawrence	Black Lake Outlet/Black Lake	Nutrients
St.Lawrence	Fish Creek and minor tribs	Nutrients
Steuben	Smith Pond	Nutrients
Suffolk	Agawam Lake	Nutrients
Suffolk	Big/Little Fresh Ponds	Nutrients
Suffolk	Canaan Lake	Silt/Sediment
Suffolk	Canaan Lake	Nutrients
Suffolk	Flanders Bay, West/Lower Sawmill Creek	Nutrients
Suffolk	Fresh Pond	Nutrients
Suffolk	Great South Bay, East	Nutrients
Suffolk	Great South Bay, Middle	Nutrients
Suffolk	Great South Bay, West	Nutrients
Suffolk	Lake Ronkonkoma	Nutrients
Suffolk	Long Island Sound, Suffolk County, West	Nutrients
Suffolk	Mattituck (Marratooka) Pond	Nutrients
Suffolk	Meetinghouse/Terrys Creeks and tribs	Nutrients
Suffolk	Mill and Seven Ponds	Nutrients
Suffolk	Millers Pond	Nutrients
Suffolk	Moriches Bay, East	Nutrients
Suffolk	Moriches Bay, West	Nutrients
Suffolk	Peconic River, Lower, and tidal tribs	Nutrients
Suffolk	Quantuck Bay	Nutrients
Suffolk	Shinnecock Bay and Inlet	Nutrients
Suffolk	Tidal tribs to West Moriches Bay	Nutrients
Sullivan	Bodine, Montgomery Lakes	Nutrients
Sullivan	Davies Lake	Nutrients
Sullivan	Evens Lake	Nutrients
Sullivan	Pleasure Lake	Nutrients
Tompkins	Cayuga Lake, Southern End	Nutrients
Tompkins	Cayuga Lake, Southern End	Silt/Sediment
Tompkins	Owasco Inlet, Upper, and tribs	Nutrients
Ulster	Ashokan Reservoir	Silt/Sediment
Ulster	Esopus Creek, Upper, and minor tribs	Silt/Sediment
Warren	Hague Brook and tribs	Silt/Sediment

303(d) Segments Impaired by Construction Related Pollutant(s)

Warren	Huddle/Finkle Brooks and tribs	Silt/Sediment
Warren	Indian Brook and tribs	Silt/Sediment
Warren	Lake George	Silt/Sediment
Warren	Tribs to L.George, Village of L George	Silt/Sediment
Washington	Cossayuna Lake	Nutrients
Washington	Lake Champlain, South Bay	Nutrients
Washington	Tribs to L.George, East Shore	Silt/Sediment
Washington	Wood Cr/Champlain Canal and minor tribs	Nutrients
Wayne	Port Bay	Nutrients
Westchester	Amawalk Reservoir	Nutrients
Westchester	Blind Brook, Upper, and tribs	Silt/Sediment
Westchester	Cross River Reservoir	Nutrients
Westchester	Lake Katonah	Nutrients
Westchester	Lake Lincolndale	Nutrients
Westchester	Lake Meahagh	Nutrients
Westchester	Lake Mohegan	Nutrients
Westchester	Lake Shenorock	Nutrients
Westchester	Long Island Sound, Westchester (East)	Nutrients
Westchester	Mamaroneck River, Lower	Silt/Sediment
Westchester	Mamaroneck River, Upper, and minor tribs	Silt/Sediment
Westchester	Muscoot/Upper New Croton Reservoir	Nutrients
Westchester	New Croton Reservoir	Nutrients
Westchester	Peach Lake	Nutrients
Westchester	Reservoir No.1 (Lake Isle)	Nutrients
Westchester	Saw Mill River, Lower, and tribs	Nutrients
Westchester	Saw Mill River, Middle, and tribs	Nutrients
Westchester	Sheldrake River and tribs	Silt/Sediment
Westchester	Sheldrake River and tribs	Nutrients
Westchester	Silver Lake	Nutrients
Westchester	Teatown Lake	Nutrients
Westchester	Titicus Reservoir	Nutrients
Westchester	Truesdale Lake	Nutrients
Westchester	Wallace Pond	Nutrients
Wyoming	Java Lake	Nutrients
Wyoming	Silver Lake	Nutrients

APPENDIX F – List of NYS DEC Regional Offices

<u>Region</u>	<u>COVERING THE FOLLOWING COUNTIES:</u>	<u>DIVISION OF ENVIRONMENTAL PERMITS (DEP) PERMIT ADMINISTRATORS</u>	<u>DIVISION OF WATER (DOW) WATER (SPDES) PROGRAM</u>
1	NASSAU AND SUFFOLK	50 CIRCLE ROAD STONY BROOK, NY 11790 TEL. (631) 444-0365	50 CIRCLE ROAD STONY BROOK, NY 11790-3409 TEL. (631) 444-0405
2	BRONX, KINGS, NEW YORK, QUEENS AND RICHMOND	1 HUNTERS POINT PLAZA, 47-40 21ST ST. LONG ISLAND CITY, NY 11101-5407 TEL. (718) 482-4997	1 HUNTERS POINT PLAZA, 47-40 21ST ST. LONG ISLAND CITY, NY 11101-5407 TEL. (718) 482-4933
3	DUTCHESS, ORANGE, PUTNAM, ROCKLAND, SULLIVAN, ULSTER AND WESTCHESTER	21 SOUTH PUTT CORNERS ROAD NEW PALTZ, NY 12561-1696 TEL. (845) 256-3059	100 HILLSIDE AVENUE, SUITE 1W WHITE PLAINS, NY 10603 TEL. (914) 428 - 2505
4	ALBANY, COLUMBIA, DELAWARE, GREENE, MONTGOMERY, OTSEGO, RENSSELAER, SCHENECTADY AND SCHOHARIE	1150 NORTH WESTCOTT ROAD SCHENECTADY, NY 12306-2014 TEL. (518) 357-2069	1130 NORTH WESTCOTT ROAD SCHENECTADY, NY 12306-2014 TEL. (518) 357-2045
5	CLINTON, ESSEX, FRANKLIN, FULTON, HAMILTON, SARATOGA, WARREN AND WASHINGTON	1115 STATE ROUTE 86, Po Box 296 RAY BROOK, NY 12977-0296 TEL. (518) 897-1234	232 GOLF COURSE ROAD WARRENSBURG, NY 12885-1172 TEL. (518) 623-1200
6	HERKIMER, JEFFERSON, LEWIS, ONEIDA AND ST. LAWRENCE	STATE OFFICE BUILDING 317 WASHINGTON STREET WATERTOWN, NY 13601-3787 TEL. (315) 785-2245	STATE OFFICE BUILDING 207 GENESEE STREET UTICA, NY 13501-2885 TEL. (315) 793-2554
7	BROOME, CAYUGA, CHENANGO, CORTLAND, MADISON, ONONDAGA, OSWEGO, TIOGA AND TOMPKINS	615 ERIE BLVD. WEST SYRACUSE, NY 13204-2400 TEL. (315) 426-7438	615 ERIE BLVD. WEST SYRACUSE, NY 13204-2400 TEL. (315) 426-7500
8	CHEMUNG, GENESEE, LIVINGSTON, MONROE, ONTARIO, ORLEANS, SCHUYLER, SENECA, STEUBEN, WAYNE AND YATES	6274 EAST AVON-LIMA ROADAVON, NY 14414-9519 TEL. (585) 226-2466	6274 EAST AVON-LIMA RD. AVON, NY 14414-9519 TEL. (585) 226-2466
9	ALLEGANY, CATTARAUGUS, CHAUTAUQUA, ERIE, NIAGARA AND WYOMING	270 MICHIGAN AVENUE BUFFALO, NY 14203-2999 TEL. (716) 851-7165	270 MICHIGAN AVENUE BUFFALO, NY 14203-2999 TEL. (716) 851-7070

NOTICE OF INTENT

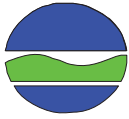

**New York State Department of Environmental Conservation
Division of Water
625 Broadway, 4th Floor
Albany, New York 12233-3505**

NYR
(For DEC use only)

Stormwater Discharges Associated with Construction Activity Under State Pollutant Discharge Elimination System (SPDES) General Permit # GP-0-20-001
All sections must be completed unless otherwise noted. Failure to complete all items may result in this form being returned to you, thereby delaying your coverage under this General Permit. Applicants must read and understand the conditions of the permit and prepare a Stormwater Pollution Prevention Plan prior to submitting this NOI. Applicants are responsible for identifying and obtaining other DEC permits that may be required.

- IMPORTANT -
RETURN THIS FORM TO THE ADDRESS ABOVE
OWNER/OPERATOR MUST SIGN FORM

Owner/Operator Information

Owner/Operator (Company Name/Private Owner Name/Municipality Name)

Owner/Operator Contact Person Last Name (NOT CONSULTANT)

Owner/Operator Contact Person First Name

Owner/Operator Mailing Address

City

State Zip -

Phone (Owner/Operator) - - Fax (Owner/Operator) - -

Email (Owner/Operator)

FED TAX ID - (not required for individuals)

3. Select the predominant land use for both pre and post development conditions.
SELECT ONLY ONE CHOICE FOR EACH

**Pre-Development
Existing Land Use**

- FOREST
- PASTURE/OPEN LAND
- CULTIVATED LAND
- SINGLE FAMILY HOME
- SINGLE FAMILY SUBDIVISION
- TOWN HOME RESIDENTIAL
- MULTIFAMILY RESIDENTIAL
- INSTITUTIONAL/SCHOOL
- INDUSTRIAL
- COMMERCIAL
- ROAD/HIGHWAY
- RECREATIONAL/SPORTS FIELD
- BIKE PATH/TRAIL
- LINEAR UTILITY
- PARKING LOT
- OTHER

--	--	--	--	--	--	--	--	--	--	--	--	--	--	--	--	--	--	--	--

**Post-Development
Future Land Use**

- SINGLE FAMILY HOME
- SINGLE FAMILY SUBDIVISION
- TOWN HOME RESIDENTIAL
- MULTIFAMILY RESIDENTIAL
- INSTITUTIONAL/SCHOOL
- INDUSTRIAL
- COMMERCIAL
- MUNICIPAL
- ROAD/HIGHWAY
- RECREATIONAL/SPORTS FIELD
- BIKE PATH/TRAIL
- LINEAR UTILITY (water, sewer, gas, etc.)
- PARKING LOT
- CLEARING/GRADING ONLY
- DEMOLITION, NO REDEVELOPMENT
- WELL DRILLING ACTIVITY *(Oil, Gas, etc.)
- OTHER

Number of Lots

--	--	--

--	--	--	--	--	--	--	--	--	--	--	--	--	--	--	--	--	--	--	--

***Note:** for gas well drilling, non-high volume hydraulic fractured wells only

4. In accordance with the larger common plan of development or sale, enter the total project site area; the total area to be disturbed; existing impervious area to be disturbed (for redevelopment activities); and the future impervious area constructed within the disturbed area. (Round to the nearest tenth of an acre.)

Total Site Area	Total Area To Be Disturbed	Existing Impervious Area To Be Disturbed	Future Impervious Area Within Disturbed Area																
<table border="1" style="width: 60px; height: 25px;"> <tr> <td style="width: 20px;"> </td><td style="width: 20px;"> </td><td style="width: 20px;"> </td><td style="width: 20px;"> </td> </tr> </table>					<table border="1" style="width: 60px; height: 25px;"> <tr> <td style="width: 20px;"> </td><td style="width: 20px;"> </td><td style="width: 20px;"> </td><td style="width: 20px;"> </td> </tr> </table>					<table border="1" style="width: 60px; height: 25px;"> <tr> <td style="width: 20px;"> </td><td style="width: 20px;"> </td><td style="width: 20px;"> </td><td style="width: 20px;"> </td> </tr> </table>					<table border="1" style="width: 60px; height: 25px;"> <tr> <td style="width: 20px;"> </td><td style="width: 20px;"> </td><td style="width: 20px;"> </td><td style="width: 20px;"> </td> </tr> </table>				

5. Do you plan to disturb more than 5 acres of soil at any one time? Yes No

6. Indicate the percentage of each Hydrologic Soil Group(HSG) at the site.

A	B	C	D												
<table border="1" style="width: 40px; height: 25px;"><tr><td> </td><td> </td><td> </td></tr></table> %				<table border="1" style="width: 40px; height: 25px;"><tr><td> </td><td> </td><td> </td></tr></table> %				<table border="1" style="width: 40px; height: 25px;"><tr><td> </td><td> </td><td> </td></tr></table> %				<table border="1" style="width: 40px; height: 25px;"><tr><td> </td><td> </td><td> </td></tr></table> %			

7. Is this a phased project? Yes No

8. Enter the planned start and end dates of the disturbance activities.

Start Date	End Date																													
<table border="1" style="width: 40px; height: 25px;"><tr><td> </td><td> </td><td> </td><td> </td></tr></table> / <table border="1" style="width: 40px; height: 25px;"><tr><td> </td><td> </td><td> </td><td> </td></tr></table> / <table border="1" style="width: 40px; height: 25px;"><tr><td> </td><td> </td><td> </td><td> </td><td> </td><td> </td></tr></table>															-	<table border="1" style="width: 40px; height: 25px;"><tr><td> </td><td> </td><td> </td><td> </td></tr></table> / <table border="1" style="width: 40px; height: 25px;"><tr><td> </td><td> </td><td> </td><td> </td></tr></table> / <table border="1" style="width: 40px; height: 25px;"><tr><td> </td><td> </td><td> </td><td> </td><td> </td><td> </td></tr></table>														

9. Identify the nearest surface waterbody(ies) to which construction site runoff will discharge.

Name
[Grid for name entry]

9a. Type of waterbody identified in Question 9?

- Wetland / State Jurisdiction On Site (Answer 9b)
Wetland / State Jurisdiction Off Site
Wetland / Federal Jurisdiction On Site (Answer 9b)
Wetland / Federal Jurisdiction Off Site
Stream / Creek On Site
Stream / Creek Off Site
River On Site
River Off Site
Lake On Site
Lake Off Site
Other Type On Site
Other Type Off Site

9b. How was the wetland identified?

- Regulatory Map
Delineated by Consultant
Delineated by Army Corps of Engineers
Other (identify)

[Grid for identifying other type]

[Grid for identifying other method]

10. Has the surface waterbody(ies) in question 9 been identified as a 303(d) segment in Appendix E of GP-0-20-001? Yes No

11. Is this project located in one of the Watersheds identified in Appendix C of GP-0-20-001? Yes No

12. Is the project located in one of the watershed areas associated with AA and AA-S classified waters? Yes No
If no, skip question 13.

13. Does this construction activity disturb land with no existing impervious cover and where the Soil Slope Phase is identified as an E or F on the USDA Soil Survey? Yes No
If Yes, what is the acreage to be disturbed?
[Grid for acreage entry]

14. Will the project disturb soils within a State regulated wetland or the protected 100 foot adjacent area? Yes No

15. Does the site runoff enter a separate storm sewer system (including roadside drains, swales, ditches, culverts, etc)? Yes No Unknown

16. What is the name of the municipality/entity that owns the separate storm sewer system?

Two rows of empty grid boxes for text entry.

17. Does any runoff from the site enter a sewer classified as a Combined Sewer? Yes No Unknown

18. Will future use of this site be an agricultural property as defined by the NYS Agriculture and Markets Law? Yes No

19. Is this property owned by a state authority, state agency, federal government or local government? Yes No

20. Is this a remediation project being done under a Department approved work plan? (i.e. CERCLA, RCRA, Voluntary Cleanup Agreement, etc.) Yes No

21. Has the required Erosion and Sediment Control component of the SWPPP been developed in conformance with the current NYS Standards and Specifications for Erosion and Sediment Control (aka Blue Book)? Yes No

22. Does this construction activity require the development of a SWPPP that includes the post-construction stormwater management practice component (i.e. Runoff Reduction, Water Quality and Quantity Control practices/techniques)? Yes No
If No, skip questions 23 and 27-39.

23. Has the post-construction stormwater management practice component of the SWPPP been developed in conformance with the current NYS Stormwater Management Design Manual? Yes No

Post-construction Stormwater Management Practice (SMP) Requirements

Important: Completion of Questions 27-39 is not required if response to Question 22 is No.

27. Identify all site planning practices that were used to prepare the final site plan/layout for the project.

- Preservation of Undisturbed Areas
- Preservation of Buffers
- Reduction of Clearing and Grading
- Locating Development in Less Sensitive Areas
- Roadway Reduction
- Sidewalk Reduction
- Driveway Reduction
- Cul-de-sac Reduction
- Building Footprint Reduction
- Parking Reduction

27a. Indicate which of the following soil restoration criteria was used to address the requirements in Section 5.1.6("Soil Restoration") of the Design Manual (2010 version).

- All disturbed areas will be restored in accordance with the Soil Restoration requirements in Table 5.3 of the Design Manual (see page 5-22).
- Compacted areas were considered as impervious cover when calculating the **WQv Required**, and the compacted areas were assigned a post-construction Hydrologic Soil Group (HSG) designation that is one level less permeable than existing conditions for the hydrology analysis.

28. Provide the total Water Quality Volume (WQv) required for this project (based on final site plan/layout).

Total WQv Required

. acre-feet

29. Identify the RR techniques (Area Reduction), RR techniques (Volume Reduction) and Standard SMPs with RRv Capacity in Table 1 (See Page 9) that were used to reduce the Total WQv Required (#28).

Also, provide in Table 1 the total impervious area that contributes runoff to each technique/practice selected. For the Area Reduction Techniques, provide the total contributing area (includes pervious area) and, if applicable, the total impervious area that contributes runoff to the technique/practice.

Note: Redevelopment projects shall use Tables 1 and 2 to identify the SMPs used to treat and/or reduce the WQv required. If runoff reduction techniques will not be used to reduce the required WQv, skip to question 33a after identifying the SMPs.

Table 1 - Runoff Reduction (RR) Techniques and Standard Stormwater Management Practices (SMPs)

<u>RR Techniques (Area Reduction)</u>	<u>Total Contributing Area (acres)</u>		<u>Total Contributing Impervious Area(acres)</u>	
<input type="radio"/> Conservation of Natural Areas (RR-1) ...	<input type="text"/>	<input type="text"/>	and/or	<input type="text"/>
<input type="radio"/> Sheetflow to Riparian Buffers/Filters Strips (RR-2)	<input type="text"/>	<input type="text"/>	and/or	<input type="text"/>
<input type="radio"/> Tree Planting/Tree Pit (RR-3)	<input type="text"/>	<input type="text"/>	and/or	<input type="text"/>
<input type="radio"/> Disconnection of Rooftop Runoff (RR-4)..	<input type="text"/>	<input type="text"/>	and/or	<input type="text"/>
<u>RR Techniques (Volume Reduction)</u>				
<input type="radio"/> Vegetated Swale (RR-5)				
<input type="radio"/> Rain Garden (RR-6)				
<input type="radio"/> Stormwater Planter (RR-7)				
<input type="radio"/> Rain Barrel/Cistern (RR-8)				
<input type="radio"/> Porous Pavement (RR-9)				
<input type="radio"/> Green Roof (RR-10)				
<u>Standard SMPs with RRv Capacity</u>				
<input type="radio"/> Infiltration Trench (I-1)				
<input type="radio"/> Infiltration Basin (I-2)				
<input type="radio"/> Dry Well (I-3)				
<input type="radio"/> Underground Infiltration System (I-4)				
<input type="radio"/> Bioretention (F-5)				
<input type="radio"/> Dry Swale (O-1)				
<u>Standard SMPs</u>				
<input type="radio"/> Micropool Extended Detention (P-1)				
<input type="radio"/> Wet Pond (P-2)				
<input type="radio"/> Wet Extended Detention (P-3)				
<input type="radio"/> Multiple Pond System (P-4)				
<input type="radio"/> Pocket Pond (P-5)				
<input type="radio"/> Surface Sand Filter (F-1)				
<input type="radio"/> Underground Sand Filter (F-2)				
<input type="radio"/> Perimeter Sand Filter (F-3)				
<input type="radio"/> Organic Filter (F-4)				
<input type="radio"/> Shallow Wetland (W-1)				
<input type="radio"/> Extended Detention Wetland (W-2)				
<input type="radio"/> Pond/Wetland System (W-3)				
<input type="radio"/> Pocket Wetland (W-4)				
<input type="radio"/> Wet Swale (O-2)				

**Table 2 - Alternative SMPs
(DO NOT INCLUDE PRACTICES BEING
USED FOR PRETREATMENT ONLY)**

<u>Alternative SMP</u>	<u>Total Contributing Impervious Area(acres)</u>								
<input type="radio"/> Hydrodynamic									
<input type="radio"/> Wet Vault									
<input type="radio"/> Media Filter									
<input type="radio"/> Other <input type="text"/>									

Provide the name and manufacturer of the Alternative SMPs (i.e. proprietary practice(s)) being used for WQv treatment.

Name

Manufacturer

Note: Redevelopment projects which do not use RR techniques, shall use questions 28, 29, 33 and 33a to provide SMPs used, total WQv required and total WQv provided for the project.

30. Indicate the Total RRv provided by the RR techniques (Area/Volume Reduction) and Standard SMPs with RRv capacity identified in question 29.

Total RRv provided

. acre-feet

31. Is the Total RRv provided (#30) greater than or equal to the total WQv required (#28).

Yes No

If Yes, go to question 36.
If No, go to question 32.

32. Provide the Minimum RRv required based on HSG.
[Minimum RRv Required = (P)(0.95)(Ai)/12, Ai=(S)(Aic)]

Minimum RRv Required

. acre-feet

32a. Is the Total RRv provided (#30) greater than or equal to the Minimum RRv Required (#32)?

Yes No

If Yes, go to question 33.

Note: Use the space provided in question #39 to summarize the specific site limitations and justification for not reducing 100% of WQv required (#28). A detailed evaluation of the specific site limitations and justification for not reducing 100% of the WQv required (#28) must also be included in the SWPPP.

If No, sizing criteria has not been met, so NOI can not be processed. SWPPP preparer must modify design to meet sizing criteria.

33. Identify the Standard SMPs in Table 1 and, if applicable, the Alternative SMPs in Table 2 that were used to treat the remaining total WQv(=Total WQv Required in 28 - Total RRv Provided in 30).

Also, provide in Table 1 and 2 the total impervious area that contributes runoff to each practice selected.

Note: Use Tables 1 and 2 to identify the SMPs used on Redevelopment projects.

33a. Indicate the Total WQv provided (i.e. WQv treated) by the SMPs identified in question #33 and Standard SMPs with RRv Capacity identified in question 29.

WQv Provided
 . **acre-feet**

Note: For the standard SMPs with RRv capacity, the WQv provided by each practice = the WQv calculated using the contributing drainage area to the practice - RRv provided by the practice. (See Table 3.5 in Design Manual)

34. Provide the sum of the Total RRv provided (#30) and the WQv provided (#33a). .

35. Is the sum of the RRv provided (#30) and the WQv provided (#33a) greater than or equal to the total WQv required (#28)? **Yes** **No**

If Yes, go to question 36.

If No, sizing criteria has not been met, so NOI can not be processed. SWPPP preparer must modify design to meet sizing criteria.

36. Provide the total Channel Protection Storage Volume (CPv) required and provided or select waiver (36a), if applicable.

CPv Required . **acre-feet** **CPv Provided** . **acre-feet**

36a. The need to provide channel protection has been waived because:

- Site discharges directly to tidal waters or a fifth order or larger stream.
- Reduction of the total CPv is achieved on site through runoff reduction techniques or infiltration systems.

37. Provide the Overbank Flood (Qp) and Extreme Flood (Qf) control criteria or select waiver (37a), if applicable.

Total Overbank Flood Control Criteria (Qp)

Pre-Development . **CFS** **Post-development** . **CFS**

Total Extreme Flood Control Criteria (Qf)

Pre-Development . **CFS** **Post-development** . **CFS**

37a. The need to meet the Qp and Qf criteria has been waived because:

- Site discharges directly to tidal waters or a fifth order or larger stream.
- Downstream analysis reveals that the Qp and Qf controls are not required

38. Has a long term Operation and Maintenance Plan for the post-construction stormwater management practice(s) been developed? Yes No

If Yes, Identify the entity responsible for the long term Operation and Maintenance

39. Use this space to summarize the specific site limitations and justification for not reducing 100% of WQv required(#28). (See question 32a) This space can also be used for other pertinent project information.

40. Identify other DEC permits, existing and new, that are required for this project/facility.

- Air Pollution Control
- Coastal Erosion
- Hazardous Waste
- Long Island Wells
- Mined Land Reclamation
- Solid Waste
- Navigable Waters Protection / Article 15
- Water Quality Certificate
- Dam Safety
- Water Supply
- Freshwater Wetlands/Article 24
- Tidal Wetlands
- Wild, Scenic and Recreational Rivers
- Stream Bed or Bank Protection / Article 15
- Endangered or Threatened Species(Incidental Take Permit)
- Individual SPDES
- SPDES Multi-Sector GP

N	Y	R					
---	---	---	--	--	--	--	--
- Other

--	--	--	--	--	--	--	--	--	--	--	--	--	--	--	--	--	--	--	--	--	--	--	--	--	--	--	--	--	--	--	--	--	--	--	--	--	--	--	--
- None

41.	Does this project require a US Army Corps of Engineers Wetland Permit? If Yes, Indicate Size of Impact. <table border="1" style="display: inline-table; border-collapse: collapse;"><tr><td style="width: 20px; height: 15px;"></td><td style="width: 20px;"></td><td style="width: 20px;"></td><td style="width: 20px;"></td><td style="width: 20px;"></td><td style="width: 20px;"></td><td style="width: 20px;"></td><td style="width: 20px;"></td><td style="width: 20px;"></td><td style="width: 20px;"></td><td style="width: 20px;"></td></tr></table>												<input type="radio"/> Yes <input type="radio"/> No

42. Is this project subject to the requirements of a regulated, traditional land use control MS4?
(If No, skip question 43) **Yes** **No**

43.	Has the "MS4 SWPPP Acceptance" form been signed by the principal executive officer or ranking elected official and submitted along with this NOI?	<input type="radio"/> Yes <input type="radio"/> No
-----	---	--

44. If this NOI is being submitted for the purpose of continuing or transferring coverage under a general permit for stormwater runoff from construction activities, please indicate the former SPDES number assigned.

N	Y	R								
---	---	---	--	--	--	--	--	--	--	--

Owner/Operator Certification

I have read or been advised of the permit conditions and believe that I understand them. I also understand that, under the terms of the permit, there may be reporting requirements. I hereby certify that this document and the corresponding documents were prepared under my direction or supervision. I am aware that there are significant penalties for submitting false information, including the possibility of fine and imprisonment for knowing violations. I further understand that coverage under the general permit will be identified in the acknowledgment that I will receive as a result of submitting this NOI and can be as long as sixty (60) business days as provided for in the general permit. I also understand that, by submitting this NOI, I am acknowledging that the SWPPP has been developed and will be implemented as the first element of construction, and agreeing to comply with all the terms and conditions of the general permit for which this NOI is being submitted.

Print First Name

--	--	--	--	--	--	--	--	--	--	--	--	--	--	--	--	--	--	--	--	--	--	--

MI

--

Print Last Name

--	--	--	--	--	--	--	--	--	--	--	--	--	--	--	--	--	--	--	--	--	--	--

Owner/Operator Signature

--	--	--	--	--	--	--	--	--	--	--	--	--	--	--	--	--	--	--	--	--	--	--

Date

			/			/				
--	--	--	---	--	--	---	--	--	--	--

APPENDIX B-2

EROSION AND SEDIMENT CONTROLS

SECTION 5 SEDIMENT CONTROL

CONTENTS

	<u>Page</u>
List of Tables and Figures	
Scope and Discussion	5.1
Chemical Treatment	5.1
Buffer Filter Strip	5.3
Cofferdam Structure	5.5
Compost Filter Sock	5.7
Dewatering Device	5.10
Geotextile Filter Bag	5.16
Rock Dam	5.17
Sediment Basin	5.19
Sediment Dike	5.42
Sediment Tank - Portable	5.44
Sediment Trap	5.46
Silt Fence	5.54
Storm Drain Inlet Protection	5.57
Straw Bale Dike	5.63
Turbidity Curtain	5.65

Section prepared by:

Donald W. Lake Jr., P.E., CPESC, CPSWQ
Former Engineering Specialist
New York State Soil & Water Conservation Committee

Adjunct Assistant Professor
State University of New York, College of Environmental
Science and Forestry

List of Tables and Figures

<u>Table</u>	<u>Title</u>	<u>Page</u>
5.1	Compost Sock Fabric Minimum Specifications Table	5.8
5.2	Compost Standards Table.....	5.8

<u>Figure</u>	<u>Title</u>	<u>Page</u>
5.1	Buffer Filter Strip	5.4
5.2	Compost Filter Sock.....	5.9
5.3	Skimmer Orifice Design Chart.....	5.11
5.4	Skimmer Dewatering Device.....	5.12
5.5	Riser Pipe Dewatering Device.....	5.14
5.6	Riser Pipe Dewatering Device Construction Notes.....	5.15
5.7	Rock Dam.....	5.18
5.8	Pipe Spillway Design	5.26
5.9	Sediment Basin	5.27
5.10	Riser Inflow Chart	5.28
5.11	Pipe Flow Chart; “n” = 0.025	5.29
5.12	Pipe Flow Chart; “n” = 0.013	5.30
5.13	Concentric Trash Rack and Anti-Vortex Device	5.31
5.14	Concentric Trash Rack and Anti-Vortex Device Table	5.32
5.15	Riser Base Detail	5.33
5.16	Anti-Seep Collar Design	5.34
5.17	Anti-Seep Collar Design Charts	5.35
5.18	Anti-Seep Collar	5.36
5.19	Design Data for Earth Spillways	5.37
5.20	Design Table for Vegetated Earth Spillways in Erosion Resistant Soils.....	5.38
5.21	Design Table for Vegetated Spillways Excavated in Very Erodible Soils	5.39
5.22	Sediment Basin Baffle Details	5.41
5.23	Sediment Dike	5.43
5.24	Portable Sediment Tank	5.45
5.25	Pipe Outlet Sediment Trap: ST-I	5.49
5.26	Pipe Outlet Sediment Trap: ST-1 - Construction Specifications	5.50
5.27	Stone Outlet Sediment Trap: ST-II	5.51
5.28	Compost Sock Sediment Trap: ST-III.....	5.52
5.29	Optional Sediment Trap Dewatering Devices	5.53
5.30	Reinforced Silt Fence	5.56
5.31	Excavated Drop Inlet Protection	5.60
5.32	Fabric Drop Inlet Protection	5.61
5.33	Stone & Block Drop Inlet Protection	5.62
5.34	Straw Bale Dike	5.64
5.35	Turbidity Curtain	5.66

SEDIMENT CONTROL

Scope and Discussion

Sediment control is the second component in the site management plan after erosion control. Primary emphasis should be placed on erosion control first which combines runoff control and soil stabilization to minimize soil erosion. Sediment control practices are then integrated into the plan to further reduce the migration of eroded soil both on and off site.

The majority of sediment control practices utilize settling to capture sediment within a storage volume where it can be contained and managed. These practices include sediment basins, sediment traps and dikes, rock dams, water structures, silt fence, turbidity curtains, straw bale dikes, and portable settling tanks. There is also a group of practices that rely on both filtering and settling to capture sediment. These practices include storm drain inlet protection structures, geotextile filter bags, compost tubes, and buffer filter strips. In addition, the use of chemical polymer substances is a process that may, with NYSDEC approval, be used on sites where disturbed clay soils remain in suspension.

It is important that these sediment control practices be designed, constructed and installed in accordance with the criteria contained in these standards. For these practices to effectively remove sediment from turbid water, the volumes, dimensions, and appropriate attributes of these individual practices must be maintained. This includes the calculated relationships of dimensions to respective drainage areas, length to width ratios, and frequency of inspection and maintenance.

Note: Performing activities within or adjacent to wetlands, streams and waterbodies may require permits from the New York State Department of Environmental Conservation (NYSDEC) pursuant to Article 15 (Protection of Waters), Article 24 (Freshwater Wetlands) and Article 25 (Tidal Wetlands) of the Environmental Conservation Law (ECL). Project owners should contact NYSDEC's Regional Division of Environmental Permits early in the site planning process to discuss the requirements for meeting permit issuance standards. Following the New York State Standards and Specifications for Erosion and Sediment Control may not ensure compliance with the above referenced sections of the ECL.

To assist with the success of these sediment control practices, apply the following concepts for the practice design and location:

1. Keep the clean water clean by diverting runoff from

upslope areas away from disturbed areas.

2. Employ natural vegetative buffers or artificial mats to assist in sediment capture in sheet flow areas.
3. Control concentrated flow to minimize additional erosion that could overwhelm a practice.
4. Stabilize all sediment control systems as soon as they are installed so they do not contribute sediment to site runoff.
5. Remove all practices after use and stabilize the regraded areas immediately.

Sediment accumulated in the sediment control practices must be removed when the sediment has filled the designated storage volume for the practice. The material must be disposed of in a manner that stabilizes it on the construction site. These details, as well as the frequency of inspection, sequences of installation and removal, and an inspection checklist shall be included in the Stormwater Pollution Prevention Plan for the site.

Chemical Treatment

Precipitation of sediment is enhanced with the use of specific chemical flocculants that can be applied to a sediment basin in liquid, powder, or solid form. Flocculants include polyacrylimide, aluminum sulfate (alum), and polyaluminum chloride.



Polymer flocculation shall only be used for dispersive soil-water mixtures that do not respond to normal settling times when allowed to set in sediment traps and basins, i.e. less than 7 days. Controlled application takes place in a sediment basin or trap with anionic polyelectrolytes in the form of liquid, powder, or solid form, such as polyacrylimide, aluminum sulfate, chitosan lactate, or chitosan acetate. Cationic polyelectrolytes have a greater toxicity to fish and other aquatic organisms than anionic

polyelectrolytes because they bind to the gills of fish resulting in respiratory failure (Pitt 2003).

Chemical treatment shall not be substituted for proper planning, phasing, sequencing, and the design of appropriate erosion and sediment control practices.



No polymer application shall take place without written approval from NYSDEC.

Field tests must be conducted on the proposed site at the design basin locations with the tributary soils to establish polymer dosing rates and verify settling performance.

Treated water discharged from sediment basins with polymer treatment will be tested to determine that any residual polymer meets the standards set by NYSDEC. Polymer flocculation systems require daily inspection.

STANDARD AND SPECIFICATIONS FOR BUFFER FILTER STRIP



Land Slope (%)	Minimum Filter Strip Width (ft.)
≤10	50
20	60
30	85
40	105
50	125
60	145
70	165

Definition & Scope

A **temporary/permanent** well vegetated grassed area below a disturbed area that can be used to remove sediment from runoff prior to it reaching surface waters or other designated areas of concern, such as parking lots and road pavement.

Condition Where Practice Applies

This practice is effective when the flow is in the form of sheet flow and the vegetative cover is established prior to disturbance. Surface water must be protected from sediment-laden runoff until buffer filter strip vegetation is established, and then the proposed disturbance can be undertaken. This practice is effective when the flow is in the form of sheet flow (maximum of 150 feet).

Design Criteria

1. The vegetation should be a well established perennial grass. Wooded and brushy areas are not acceptable for purposes of sediment removal.
2. The minimum buffer filter strip width for stream protection shall be in accordance with the following table:

3. The minimum buffer filter strip width to protect paved areas during construction is 20 feet.

Maintenance

If at any time the width of the buffer filter strip has been reduced by sediment deposition to half its original width or concentrated flow has developed, suitable additional practices should be installed. The erosion and sediment control plan shall include these details.

Figure 5.1
Buffer Filter Strip

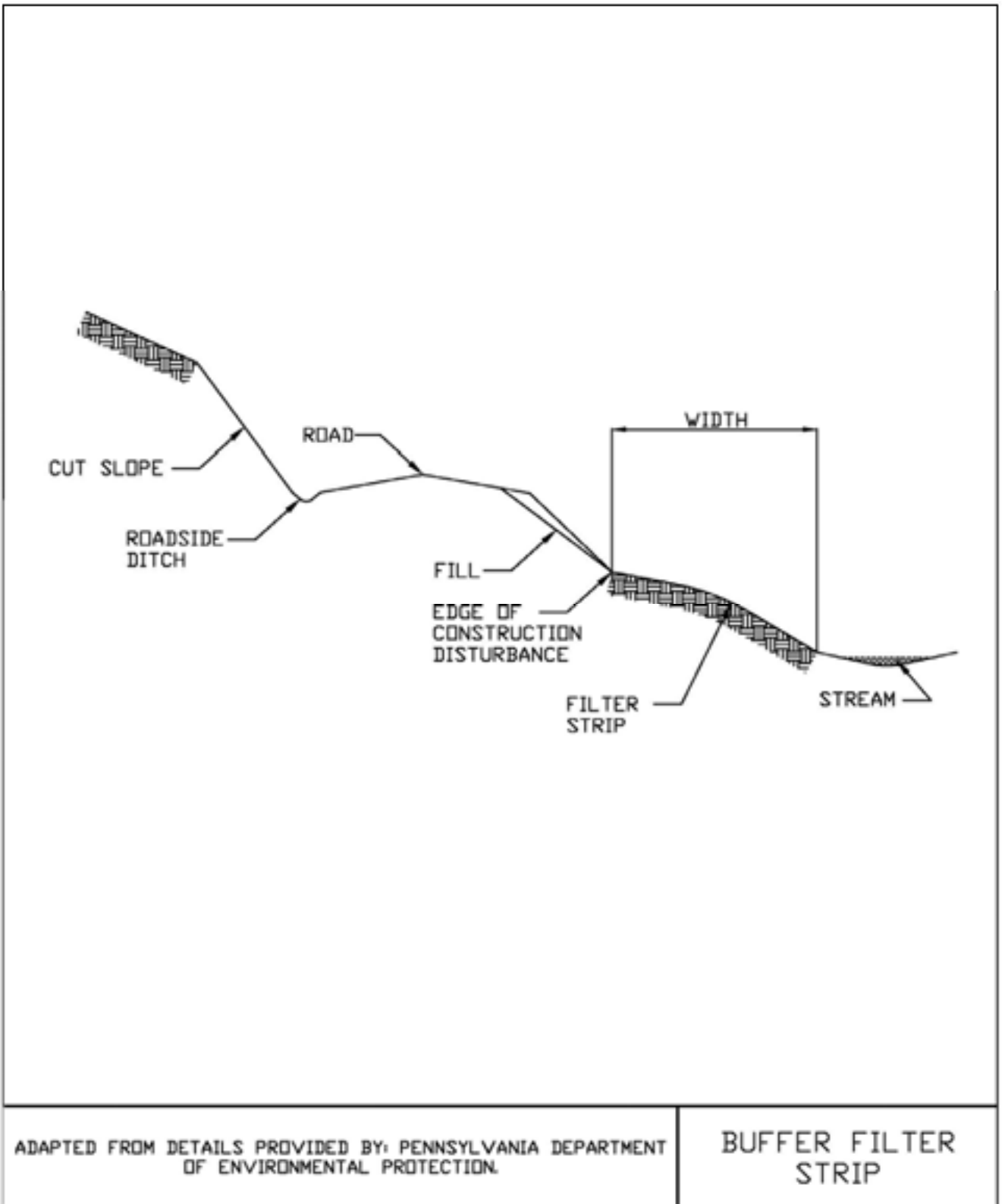

STANDARD AND SPECIFICATIONS FOR COFFERDAM STRUCTURES



Definition & Scope

A **temporary** barrier placed at a worksite to prevent water from flooding the work area so that construction can take place without discharging sediment into the water resource.

Condition Where Practice Applies

Temporary coffer dams are used to separate streams, rivers, lakes, and other sources of surface water from adjacent locations where soil disturbances are undertaken to complete construction. These barriers can be constructed of manufactured components such as geotextile/plastic tubes filled with water, portable dams formed by metal framing with a geo-membrane, or conventionally constructed earth and stone dike systems.

Design Criteria

The maximum height for this application is 10 feet. No construction activity shall commence in the area of the cofferdam until it is completed and stabilized.

Water Filled Structures

1. These structures shall be sized and installed according to the manufacturers recommendations.
2. Adequate freeboard must be provided to prevent flotation during high water events and periods of below freezing temperatures.
3. The foundation shall be prepared to provide full bottom contact prior to filling.
4. An interior dewatering system shall be designed within

the work area to manage seepage.

5. The ends of the water structures shall be anchored on the stream banks or shorelines at an elevation at least above the top of the structure.

Structural Component Dams

1. These structures shall be sized and installed in accordance with the manufacturers recommendations.
2. The foundation area for the placement of the structural steel framing and the impervious fabric membrane shall be as directed by the manufacturer or by qualified personnel.
3. Dewatering the interior of the coffer dam will be done in a manner that does not disturb the foundation area of the structural frame.
4. A minimum of 2 feet of freeboard shall be provided above the expected high water elevation.

Earthen Cofferdams

1. The earthen coffer dam shall be constructed of fill material that will preclude the transmission of water through the dam, or contain an impermeable core.
2. The minimum top width shall be 8 feet with 2:1 side slopes, and compacted in 9 inch lifts with a minimum of 4 passes of construction equipment.
3. The outside slope shall be covered with a 1 foot layer of rock riprap over a graded stone bedding or geotextile to prevent erosion of soil material into water. An alternative method is to cover the outside slope with an anchored plastic cover with a minimum thickness of 20 mil.
4. Interior work will be conducted in a manner that will not disturb or undermine the earthen coffer dam or its foundation.

Inspection and Maintenance

1. All cofferdams will be inspected daily to assure proper performance and stability as vibration from construction equipment can cause disturbance of the structures.
2. Particular attention should be given to the foundation support system at perimeter of structural component dams. Any undermined or settled areas shall be restored immediately.

3. Any holes, leaks, or torn areas in the geo-membranes or fabric shall be repaired immediately.
4. Any shifting, movement, or settling of the coffer dam shall be addressed immediately to protect workers in the construction area.
5. Inspect the interior dewatering system and ensure that the system is discharging clean water, or is being pumped to appropriate sediment control facility prior to returning to the water resource.
6. Repair or replace any loss of rock riprap or fill that may occur and assure the top of the coffer dam is level without any low spots due to settling.
7. Upon completion of the construction work, remove all excess material, accumulated sediment and debris from the work area, and remove the cofferdam in accordance with the site stabilization plan.

STANDARD AND SPECIFICATIONS FOR COMPOST FILTER SOCK



Definition & Scope

A **temporary** sediment control practice composed of a degradable geotextile mesh tube filled with compost filter media to filter sediment and other pollutants associated with construction activity to prevent their migration offsite.

Condition Where Practice Applies

Compost filter socks can be used in many construction site applications where erosion will occur in the form of sheet erosion and there is no concentration of water flowing to the sock. In areas with steep slopes and/or rocky terrain, soil conditions must be such that good continuous contact between the sock and the soil is maintained throughout its length. For use on impervious surfaces such as road pavement or parking areas, proper anchorage must be provided to prevent shifting of the sock or separation of the contact between the sock and the pavement. Compost filter socks are utilized both at the site perimeter as well as within the construction areas. These socks may be filled after placement by blowing compost into the tube pneumatically, or filled at a staging location and moved into its designed location.

Design Criteria

1. Compost filter socks will be placed on the contour with both terminal ends of the sock extended 8 feet upslope at a 45 degree angle to prevent bypass flow.
2. Diameters designed for use shall be 12" – 32" except

that 8" diameter socks may be used for residential lots to control areas less than 0.25 acres.

3. The flat dimension of the sock shall be at least 1.5 times the nominal diameter.
4. The **Maximum Slope Length** (in feet) above a compost filter sock shall not exceed the following limits:

Dia. (in.)	Slope %						
	2	5	10	20	25	33	50
8	225*	200	100	50	20	—	—
12	250	225	125	65	50	40	25
18	275	250	150	70	55	45	30
24	350	275	200	130	100	60	35
32	450	325	275	150	120	75	50

* Length in feet



5. The compost infill shall be well decomposed (matured at least 3 months), weed-free, organic matter. It shall be aerobically composted, possess no objectionable odors, and contain less than 1%, by dry weight, of man-made foreign matter. The physical parameters of the compost shall meet the standards listed in Table 5.2 - Compost Standards Table. **Note: All biosolids compost produced in New York State (or approved for importation) must meet NYS DEC's 6 NYCRR Part 360 (Solid Waste Management Facilities) requirements. The Part 360 requirements are equal to or more stringent than 40 CFR Part 503 which ensure safe standards for pathogen reduction and heavy metals content. When using compost filter socks adjacent to surface water, the compost should have a low nutrient value.**
6. The compost filter sock fabric material shall meet the

7. Compost filter socks shall be anchored in earth with 2” x 2” wooden stakes driven 12” into the soil on 10 foot centers on the centerline of the sock. On uneven terrain, effective ground contact can be enhanced by the placement of a fillet of filter media on the disturbed area side of the compost sock.
8. All specific construction details and material specifications shall appear on the erosion and sediment control constructions drawings when compost filter socks are included in the plan.
3. Socks shall be inspected weekly and after each runoff event. Damaged socks shall be repaired in the manner required by the manufacturer or replaced within 24 hours of inspection notification.
4. Biodegradable filter socks shall be replaced after 6 months; photodegradable filter socks after 1 year. Polypropylene socks shall be replaced according to the manufacturer’s recommendations.
5. Upon stabilization of the area contributory to the sock, stakes shall be removed. The sock may be left in place and vegetated or removed in accordance with the stabilization plan. For removal the mesh can be cut and the compost spread as an additional mulch to act as a soil supplement.

Maintenance

1. Traffic shall not be permitted to cross filter socks.
2. Accumulated sediment shall be removed when it reaches half the above ground height of the sock and disposed of in accordance with the plan.

Table 5.1 - Compost Sock Fabric Minimum Specifications Table

Material Type	3 mil HDPE	5 mil HDPE	5 mil HDPE	Multi-Filament Polypropylene (MFPP)	Heavy Duty Multi-Filament Polypropylene (HDMFPP)
Material Characteristics	Photodegradable	Photodegradable	Biodegradable	Photodegradable	Photodegradable
Sock Diameters	12” 18”	12” 18” 24” 32”	12” 18” 24” 32”	12” 18” 24” 32”	12” 18” 24” 32”
Mesh Opening	3/8”	3/8”	3/8”	3/8”	1/8”
Tensile Strength		26 psi	26 psi	44 psi	202 psi
Ultraviolet Stability % Original Strength (ASTM G-155)	23% at 1000 hr.	23% at 1000 hr.		100% at 1000 hr.	100% at 1000 hr.
Minimum Functional Longevity	6 months	9 months	6 months	1 year	2 years

Table 5.2 - Compost Standards Table

Organic matter content	25% - 100% (dry weight)
Organic portion	Fibrous and elongated
pH	6.0 – 8.0
Moisture content	30% - 60%
Particle size	100% passing a 1” screen and 10 - 50% passing a 3/8” screen
Soluble salt concentration	5.0 dS/m (mmhos/cm) maximum

Figure 5.2
Compost Filter Sock

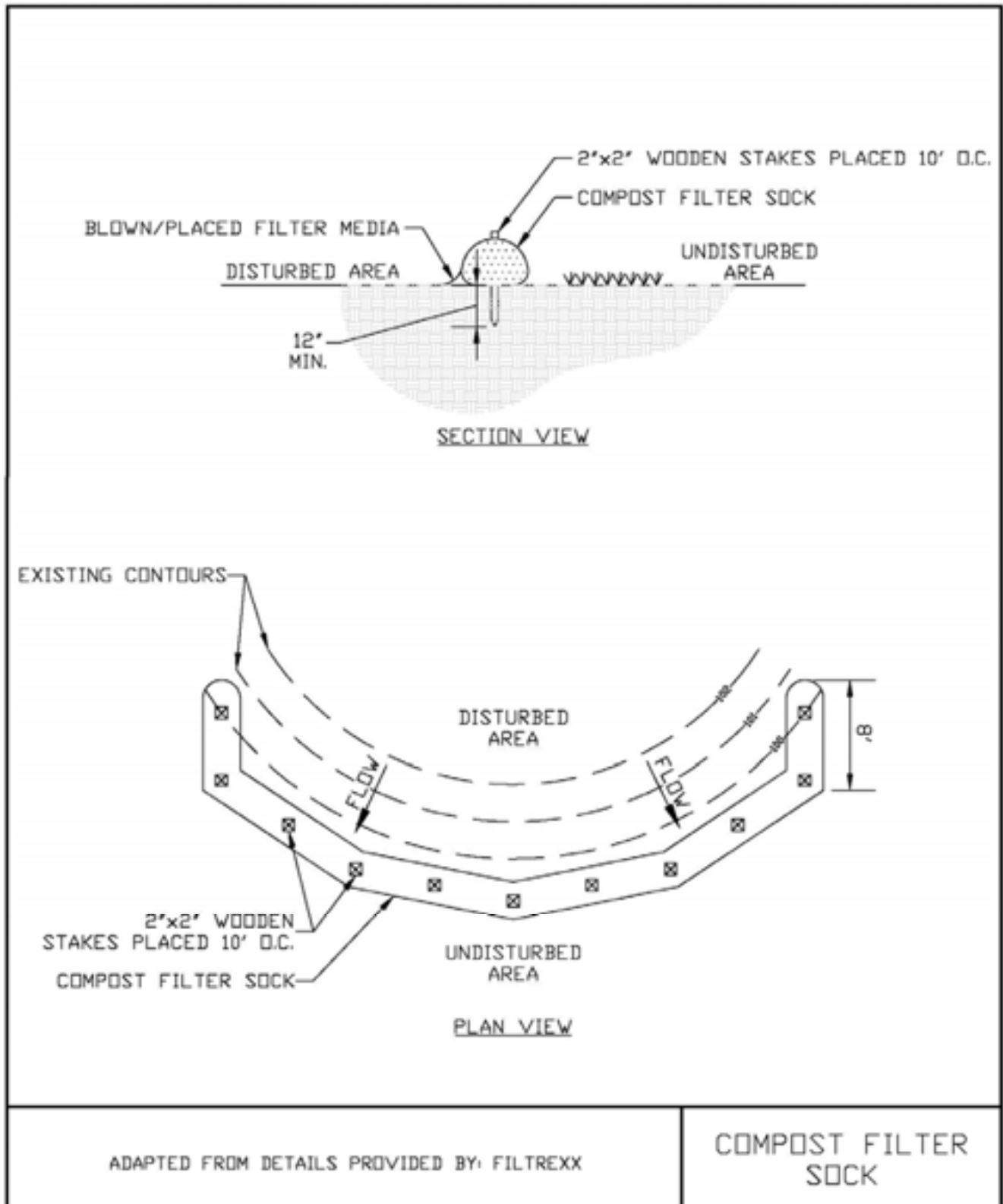

STANDARD AND SPECIFICATIONS FOR DEWATERING DEVICE



Definition & Scope

An appurtenance to a sediment trapping structure such as a basin or trap that allows sediment laden water to pond allowing sediment to settle out while removing relatively clean water to a suitable, stable outlet.

Condition Where Practice Applies

Dewatering devices are appropriate where the discharge from a trap or basin will be by gravity flow through a riser and pipe outlet system. The skimmer dewatering device is the preferred option. A fixed pipe dewatering device, configured as a perforated vertical riser surrounded by filter fabric and stone material is an alternate option for small structures.

Design Criteria

Skimmer Device

1. Skimmers must be designed so as to float just beneath the water surface to remove the least sediment laden water effectively.
2. Skimmer shall be constructed with a 4 foot long flexible pipe elbow to allow for vertical movement of the skimmer for its designated range of operation.
3. The designer will provide a table that shows all required dimensions for the skimmer. An example of this table is shown in Figure 5.4 on page 5.12. See design example in Appendix B.
4. The skimmer will be provided with vertical travel guides and a resting stone pad set at the appropriate design elevation.

5. The orifice plate will be at the “T” intersection of the perforated skimmer section with the non-perforated extension arm.

Riser-Pipe Device

1. The riser-pipe device is constructed as a fixed rigid structure with a larger diameter pipe as the vertical riser connected to a smaller diameter horizontal pipe barrel.
2. The joint of these two conduits will be anchored by means of a concrete block or welded steel plate to prevent flotation.
3. The riser will be perforated above the bottom of the dewatering zone elevation and wrapped with a geotextile filter fabric to filter out sediment.
4. The filter fabric shall be covered with stone graded as NYSDOT #1, #2, or a blend of both, to protect the fabric from deterioration.
5. An orifice plate shall be placed in the riser at the bottom of the dewatering zone elevation to control the dewatering rate.

Dewatering Drawdown

As a minimum, sediment traps and basins should have their temporary storage dewatered over a 48 hour period to maximize sediment retention. If the soils disturbed within the drainage area will have 60% - 80% fines the settling time should be increased to 4 days. Soils containing greater than 80% fines will need longer settling times but in no case longer than 7 days to maintain the hydraulic performance of the basin for recurring runoff events.

1. Skimmer orifices may be sized by using the design chart shown in Figure 5.3 on page 5.11.
2. Riser-pipe orifice sizes may be approximated by the following formula:

$$A_0 = \frac{A_s \times 2h^{0.5}}{T \times C_d \times 20,428}$$

Where:

A_0 = Areas of the dewatering orifice (ft²)

A_s = Surface area of the basin/trap (ft²)

h = head of water above the orifice (ft)

C_d = 0.6 (contraction coefficient of an orifice)

T = Detention time needed to dewater basin (48 hours minimum)

Therefore, the minimum A_o formula for 48 hrs. reduces to:

$$A_o = \frac{A_r \times 2h^{0.5}}{588,326}$$

Material Specifications

1. Skimmer Devices - These devices shall be constructed with Schedule 40 PVC pipe with diameters of 4 to 6 inches. The flexible arm shall be equal diameter of non-perforated, corrugated, plastic tubing.
2. Riser-pipe Devices - These devices shall be constructed of Schedule 40 PVC if plastic pipe is used or galvanized corrugated steel or aluminum pipe. The minimum diameter shall be 6 inches if the device is used in conjunction with another permanent riser. All perforations will be at the interior of the corrugations.

Maintenance

1. Dewatering devices shall be inspected weekly and after each runoff event.
2. Filter fabric or media will be replaced as needed.
3. Any malfunctioning skimmer or its components shall be repaired or replaced within 24 hours of inspection notification.
4. Sediment shall be removed from the system when it reaches the level marked in a sediment cleanout stake or the top of the skimmer landing area.
5. The structure shall only be removed when the tributary area has been properly stabilized.

Figure 5.3 - Skimmer Orifice Design Chart

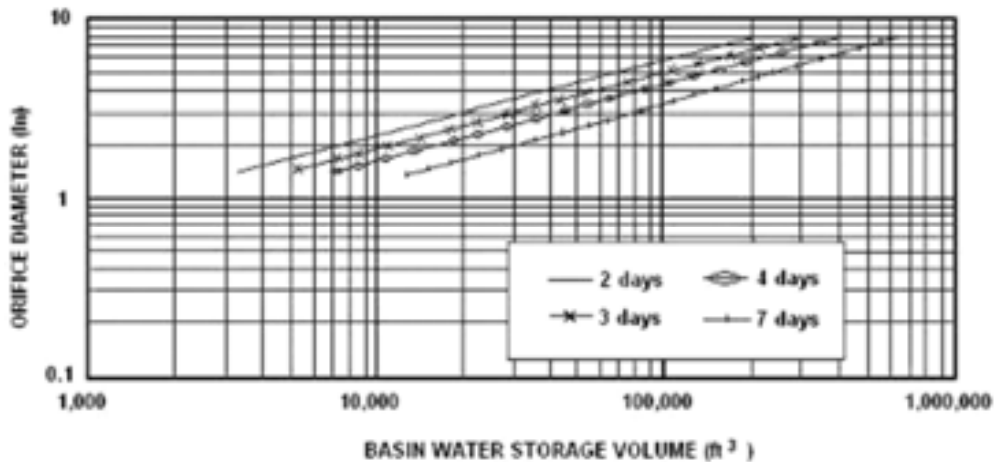

* Figure adapted from Penn State Agricultural and Biological Fact Sheet F-253

Notes:

1. Figure 5.3 is for use in designing the orifice plate for the skimmer shown in Figure 5.4. It assumes 3" to 5" head (depending upon the size of the skimmer). The required head for use of Figure 5.3 varies as follows: For a skimmer with a dewatering tube $\leq 2 \frac{1}{2}$ " diameter, use a 2" head. For a 3" diameter tube, use a 2.5" head; 4" tube, use 3.3" head, 5" tube use 4" head, and 6" diameter tube use 5" head.
2. Find the vertical line representing the basin's dewatering zone volume. At the intersection of the vertical line with the desired dewatering time, read horizontally to the left to find the required skimmer orifice diameter.

Figure 5.4
Skimmer Dewatering Device

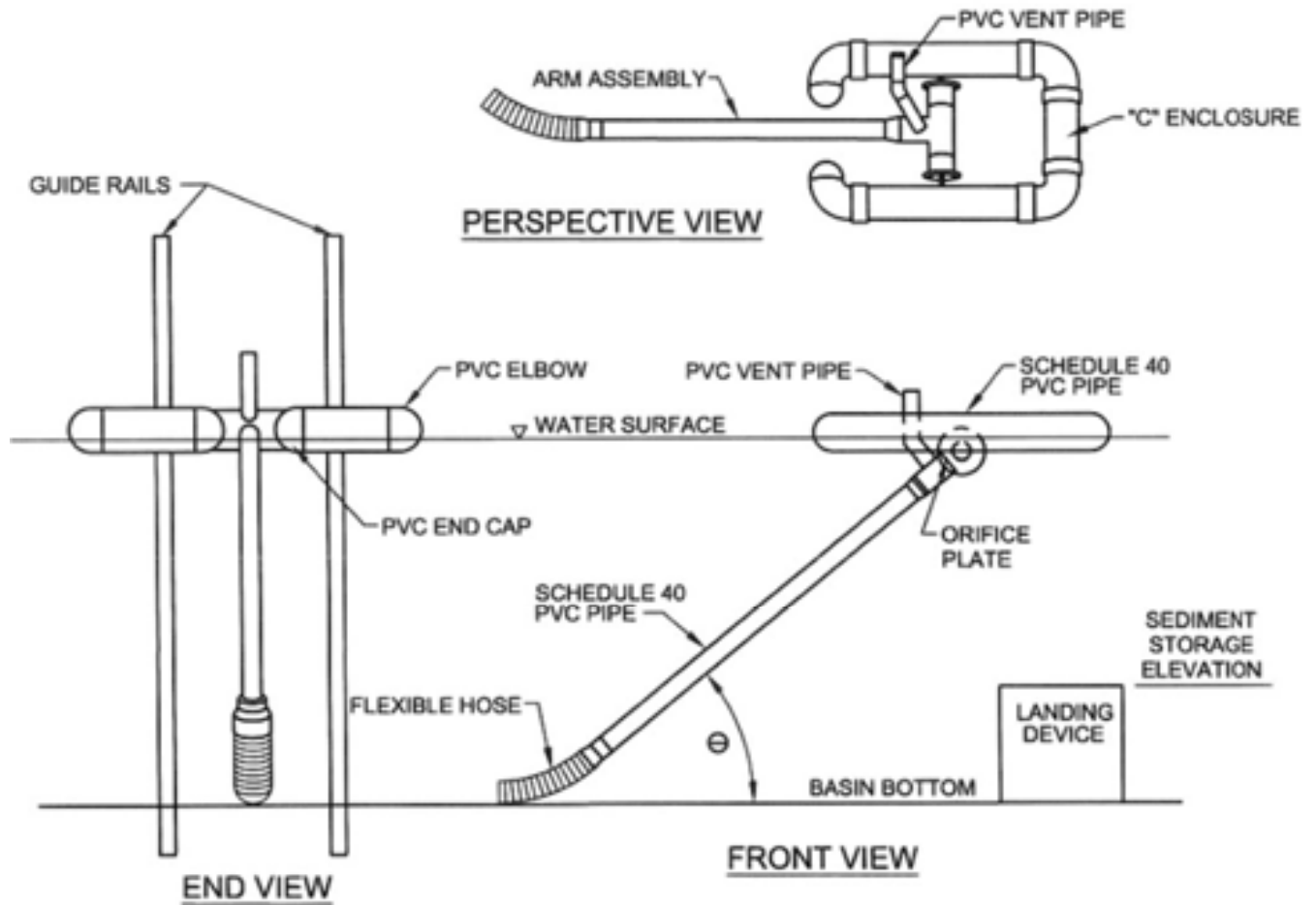

* Figure adapted from Penn State Agricultural and Biological Fact Sheet F-253

Basin No.	Water Surface Elevation (ft.)	Arm Length* (ft.)	Arm Dia. (in.)	Orifice Size** (in.)	Top of Landing Device Elevation (ft.)	Flexible Hose Length (in.)	Flexible Hose Attachment Elevation (ft.)

* Minimum Arm length = Full design storage depth x 1.414 (for 45 degree angle)
 ** Must be equal to or less than arm diameter

Skimmer Construction Notes

1. Pipe flotation section shall be solvent welded to ensure an airtight assembly. The contractor is required to conduct a test to check for leaks prior to installation.
2. Skimmer section shall have 12 rows of 1/2" diameter holes, 1 1/4" on center. If additional filtration is necessary, the filtering media shall consist of a Type GD-II geotextile fabric wrapped around the perforated portion of the skimmer and attached with plastic snap ties, bands, etc.
3. Flexible pipe shall be inserted into solid pipe and fastened with 2 #8 wood screws.
4. At a minimum, the structure shall be inspected after each rain and repairs made as needed. If vandalism is a problem, more frequent inspection may be necessary.
5. Construction operations shall be carried out in such a manner that erosion and water pollution are minimized.
6. The structure shall only be removed when the contributing drainage area has been properly stabilized.

Materials

(Note: materials for a 4" diameter arm assembly)

1. Solid Pipe - 4" Schedule 40 PVC
2. Perforated Pipe - 4" Schedule 40 PVC
3. 90° Tee (1 each) - 4" Schedule 40 PVC
4. 90° Elbow (4 each) - 4" Schedule 40 PVC
5. Cap (2 each) - 4" Schedule 40 PVC, solid
6. Flexible pipe - 4" Corrugated Plastic Tubing (non-perforated)

Figure 5.5
Riser Pipe Dewatering Device

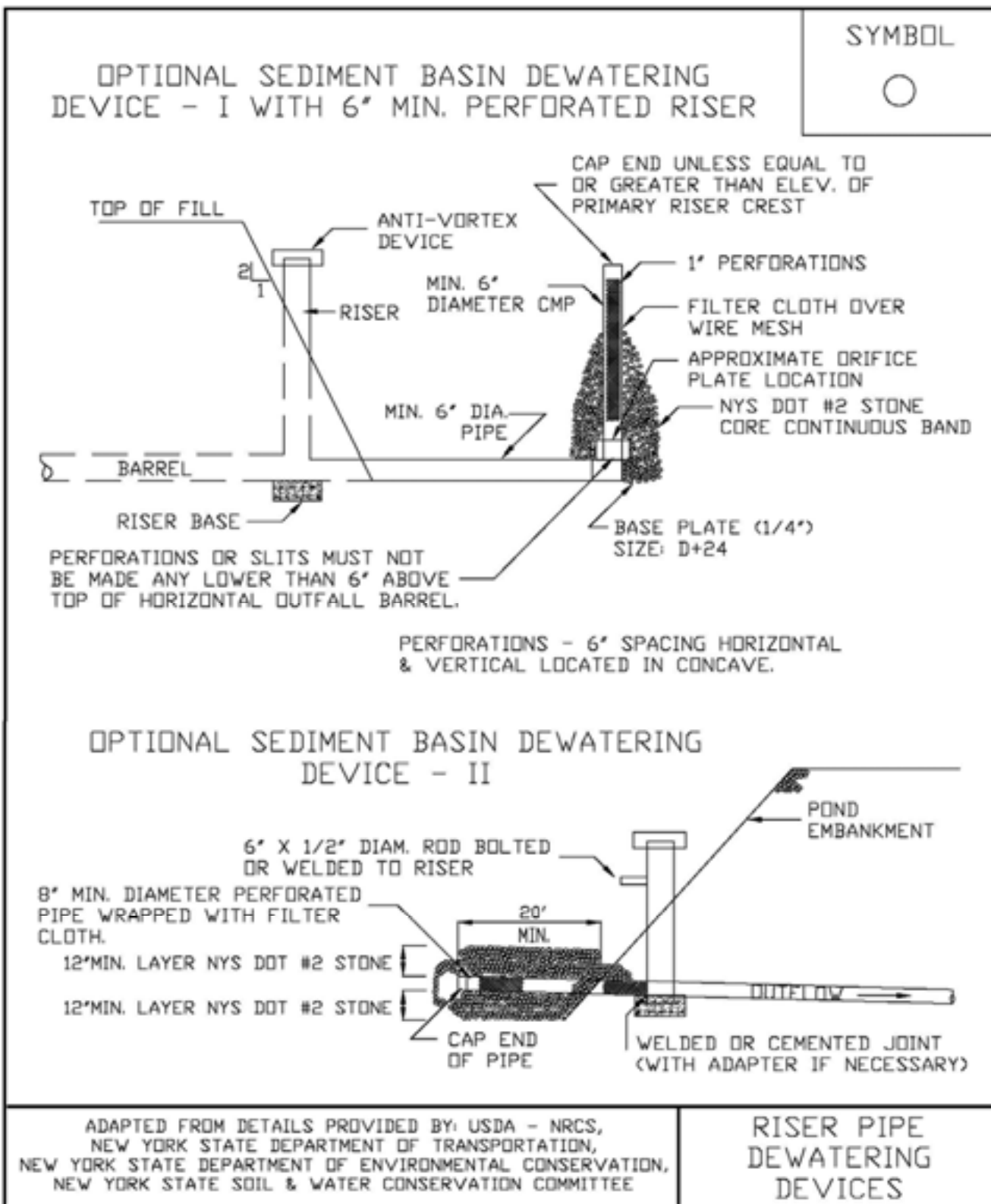

Figure 5.6

Riser Pipe Dewatering Device Construction Notes

Riser Pipe Construction Notes

1. Standpipe and connector pipe shall be a minimum of 6 inches diameter.
2. Metal pipe may be galvanized steel or aluminum; plastic pipe may be Schedule 40 PVC or HDPP.
3. Construction operations shall be carried out in such a manner that erosion and water pollution are minimized.
4. The structure shall only be removed when the contributing drainage area has been properly stabilized.
5. All pipe connections shall be watertight. The lower portion of the standpipe, at a point above the barrel connection, shall be fitted with an internal orifice plate sized to release the volume of the basin no sooner than 48 hours.
6. The top 2/3 of the standpipe shall be perforated with 1 inch diameter hole or slit spaced 6 inches vertically and horizontally and placed in the concave portion of the pipe. No holes will be allowed within 6 inches of the horizontal connector pipe.
7. The riser shall be wrapped with a Type GD-II geotextile fabric. The fabric shall extend 6 inches above the highest hole and 6" below the lowest hole. Where ends of fabric come together, they shall be overlapped, folded and stapled to prevent bypass.
8. Straps or connecting bands shall be used to hold the fabric and wire mesh (as needed) in place. They shall be placed at the top and bottom of the cloth.
9. The standpipe shall be anchored with either concrete base or steel plate base to prevent flotation. Concrete bases shall be 12 inches thick with the standpipe embedded nine inches. Steel plate bases will be 1/4 inch minimum thickness attached to the standpipe by a continuous weld around the bottom to form a watertight connection. The plate shall have 2.5 feet of stone, gravel or tamped earth placed on it.
10. The perforated standpipe shall be surrounded by NYSDOT #1 or #2 stone or a blend of both to protect the filter fabric.

STANDARD AND SPECIFICATIONS FOR GEOTEXTILE FILTER BAG



Definition & Scope

A **temporary** portable device through which sediment laden water is pumped to trap and retain sediment prior to its discharge to drainageways or off-site.

Condition Where Practice Applies

On sites where space is limited such as urban construction or linear projects (e.g. roads and utility work) where rights-of-way are limited and larger de-silting practices are impractical.

Design Criteria

1. Location - The portable filter bag should be located to minimize interference with construction activities and pedestrian traffic. It should also be placed in a location that is vegetated, relatively level, and provides for ease of access by heavy equipment, cleanout, disposal of trapped sediment, and proper release of filtered water.

The filter bag shall also be placed at least 50 feet from all wetlands, streams or other surface waters.

2. Size - Geotextile filter bag shall be sized in accordance with the manufacturers recommendations based on the pump discharge rate.

Materials and Installation

1. The geotextile material will have the following attributes:

Minimum Grab Tensile Strength	200 lbs.
Minimum Grab Tensile Elongation	50 %
Minimum Trapezoid Tear Strength	80 lbs.
Mullen Burst Strength	380 psi
Minimum Puncture Strength	130 lbs
Apparent Opening Size	40 - 80 US sieve
Minimum UV Resistance	70%
Minimum Flow Thru Rate	70 gpm/sq ft

2. The bag shall be sewn with a double needle machine using high strength thread, double stitched "Joe" type capable of minimum roll strength of 100 lbs/inch (ASTM D4884).
3. The geotextile filter bag shall have an opening large enough to accommodate a 4 inch diameter discharge hose with an attached strap to tie off the bag to the hose to prevent back flow.
4. The geotextile shall be placed on a gravel bed 2 inches thick, a straw mat 4 inches thick, or a vegetated filter strip to allow water to flow out of the bag in all directions.

Maintenance

1. The geotextile filter bag is considered full when remaining bag flow area has been reduced by 75%. At this point, it should be replaced with a new bag.
2. Disposal may be accomplished by removing the bag to an appropriate designated upland area, cut open, remove the geotextile for disposal, and spread sediment contents and seeded and mulched according to the vegetative plan.

STANDARD AND SPECIFICATIONS FOR ROCK DAM



Definition & Scope

A rock embankment located to capture and retain sediment on the construction site and prevent sedimentation in offsite water bodies.

Conditions Where Practice Applies

The rock dam may be used instead of the standard sediment basin with barrel and riser. The rock dam is preferred when it is difficult to construct a stable, earthen embankment and rock materials are readily available. The site should be accessible for periodic sediment removal. This rock dam shall not be located in a perennial stream. The top of the dam will serve as the overflow outlet. The inside of the dam will be faced with smaller stone to reduce the rate of seepage so a sediment pool forms during runoff events.

Design Criteria

Drainage Area: The drainage area for this off stream structure is limited to 50 acres.

Location: The location of the dam should:

- provide a large area to trap sediment
- intercept runoff from disturbed areas
- be accessible to remove sediment
- not interfere with construction activities

Storage Volume: The storage volume behind the dam shall be at least 3,600 cubic feet per acre of drainage area to the dam. This volume is measured one foot below the crest of the dam.

Dam Section:

Top Width	5 feet minimum @ crest
Side Slopes	2:1 upstream slope 3:1 downstream slope
Height	6' max to spillway crest

Length of Crest: The crest length should be designed to carry the 10 yr. peak runoff with a maximum flow depth of 1 foot and 1 foot of freeboard.

Rock at the abutments should extend at least 2 feet above the spillway and be at least 2 feet thick. These rock abutments should extend at least one foot above the downstream slope to prevent abutment scour. A rock apron at least 1.5 feet thick should extend downstream from the toe of the dam a distance equal to the height of the dam to protect the outlet area from scour.

Rock Fill: The rock fill should be well graded, hard, erosion resistant stone with a minimum d_{50} size of 9 inches. A “key trench” lined with geotextile filter fabric should be installed in the soil foundation under the rock fill. The filter fabric must extend from the key trench to the downstream edge of the apron and abutments to prevent soil movement and piping under the dam.

The upstream face of the dam should be covered with a fine washed gravel (NYS-DOT #1 or #1A gravel, crushed stone or equal) a minimum 3 feet thick to reduce the drainage rate.

Trapping Efficiency: To obtain maximum trapping efficiency, design for a long detention period. Usually a minimum of eight (8) hours before the basin is completely drained. Maximize the length of travel of sediment laden water from the inlet to the drain for a minimum length to width ratio of 2 to 1 or greater. Achieve a surface area equal to 0.01 acres per cfs (inflow) based on the 10-year storm. See Figure 5.7 on page 5.18 for details.

Maintenance

Check the basin area after each rainfall event. Remove sediment and restore original volume when sediment accumulates to one-half the design volume. Check the structure for erosion, piping, and rock displacement after each significant event and replace immediately.

Remove the structure and any sediment immediately after the construction area has been permanently stabilized. All water should be removed from the basin prior to the removal of the rock dam. Sediment should be placed in designated disposal areas and not allowed to flow into streams or drainage ways during structure removal.

**Figure 5.7
Rock Dam**

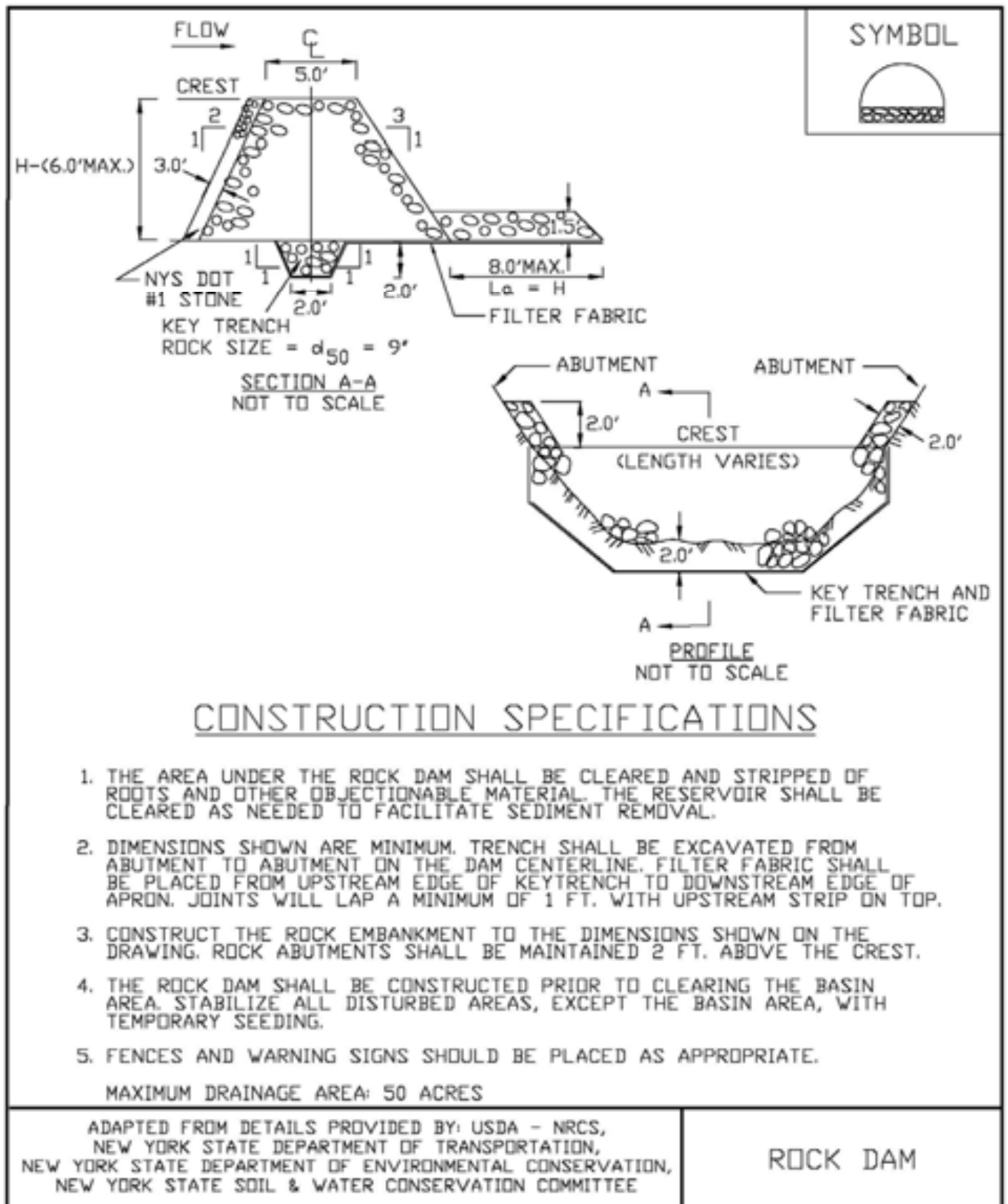

STANDARD AND SPECIFICATIONS FOR SEDIMENT BASIN



Definition & Scope

A **temporary** basin with a barrier or dam constructed across a drainage way or at other suitable locations to intercept sediment-laden runoff and reduce the amount of sediment leaving the disturbed area in order to protect drainageways, properties, and rights-of-way below the sediment basin.

Conditions Where Practice Applies

A sediment basin is appropriate where physical site conditions or land ownership restrictions preclude the installation of other control measures to adequately control runoff, erosion, and sedimentation. However, it is required that other erosion control measures be used with the sediment basin. The basin may be used below construction operations which expose critical areas to soil erosion. The basin shall be maintained until the disturbed area is protected against erosion by permanent stabilization.

This standard applies to the installation of temporary sediment basins on sites where: (a) failure of the structure would not result in loss of life, damage to homes or buildings, or interruption of use or service of public roads or utilities; (b) the drainage area does not exceed 50 acres; and (c) the basin is to be removed within 36 months after the beginning of construction of the basin.

Permanent (to function more than 36 months) sediment basins, or structures that temporarily function as a sediment basin but are intended for use as a permanent pool shall be classified as **permanent** structures and shall conform to criteria appropriate for permanent structures. These structures shall be designed and constructed to conform to NRCS Standard And Specification No. 378 for Ponds in the National Handbook of Conservation Practices and the New York State Department of Environmental Conservation, "Guidelines for the Design of Dams."

Design Criteria

Compliance with Laws and Regulations

Design and construction shall comply with state and local laws, ordinances, rules and regulations, including permits.

Location - Maximum Drainage Area = 50 acres

The sediment basin should be located to obtain the maximum storage benefit from the terrain and for ease of cleanout of the trapped sediment. It should be located to minimize interference with construction activities and construction of utilities. Whenever possible, sediment basins should be located so that storm drains may outfall or be diverted into the basin. **Do not locate basins in perennial streams.**

Size and Shape of the Basin

The sediment basin will contain two separate zones. The lowest zone is the sediment storage zone. This zone is sized for a volume equal to 1,000 cubic feet per disturbed acre over the course of the life of the project, contributing to the basin as measured from the bottom of the basin to the bottom of the dewatering zone. It shall have a minimum depth of 1 foot. Layered above this zone is the dewatering zone. This zone is sized for a minimum volume equal to 3,600 cubic feet per each acre draining to the basin. This volume is temporarily stored between the sediment storage zone and the crest of the principal spillway. This zone should be a minimum of 3 feet deep. See Figures 5.8 and 5.9 on pages 5.26 and 5.27. This 3,600 cubic feet per acre is equivalent to one inch of sediment per acre of drainage area. The entire drainage area is used for this computation, rather than the disturbed area above, to maximize trapping efficiency. The length to width ratio shall be 2:1 or greater, where length is the distance between the inlet and outlet. A wedge shape shall be used with the inlet located at the narrow end. See Figure 5.22 on page 5.41.

Surface Area

Research studies (Barfield and Clar 1985; Pitt, 2003) indicate that the following relationship between surface area and peak inflow rate gives a trapping efficiency of 75% for silt loam soils, and greater than 90% for loamy sand soils:

$$A = 0.01 Q_p \text{ or, } A = 0.015x \text{ D.A. (whichever is greater)}$$

where,

A = the basin surface area, acres, measured at the service spillway crest; and

Q_p = the peak inflow rate for the design storm. (The minimum design storm will be a 10 year, 24 hour storm under construction conditions).

D.A. = contributing drainage area.

Sediment basins shall be cleaned out when the sediment storage zone volume described above is reduced by 50 percent, except in no case shall the sediment level be permitted to build up higher than one foot below the bottom of the dewatering zone. At this elevation, cleanout shall be performed to restore the original design volume to the sediment storage zone.

The elevation corresponding to the maximum allowable sediment level shall be determined and shall be stated in the design data as a distance below the top of the riser and shall be clearly marked on the riser.

The basin dimensions necessary to obtain the required basin volume as stated above shall be clearly shown on the plans to facilitate plan review, construction, and inspection.

Spillway Design

Runoff shall be computed by standard accepted hydrologic methods noted previously in this book of standards. **Runoff computations shall be based upon the worst soil cover conditions expected to prevail in the contributing drainage area during the anticipated effective life of the structure.** The combined capacities of the principal and emergency spillway shall be sufficient to pass the peak rate of runoff from a ten (10) year frequency, 24 hour duration storm.

1. Principal spillway: A spillway consisting of a vertical pipe or box type riser joined (watertight connection) to a pipe (barrel) which shall extend through the embankment and outlet beyond the downstream toe of the fill. The minimum capacity of the principal spillway shall be 0.2 cfs per acre of drainage area when the water surface is at the emergency spillway crest elevation. For those basins with no emergency spillway, the principal spillway shall have the capacity to handle the peak flow from a ten-year frequency rainfall event. The minimum size of the barrel shall be 8 inches in diameter. See Figures 5.10, 5.11 and 5.12 on pages 5.28, 5.29, and 5.30 for principal spillway sizes and capacities.

- A. Crest elevation: When used in combination with an emergency spillway, the crest elevation of the riser shall be a minimum one foot below the elevation of the control section of the emergency spillway.

- B. Watertight riser and barrel assembly: The riser and all pipe connections shall be completely watertight except for the inlet opening at the top, or a dewatering opening. There shall not be other holes, leaks, rips, or perforations in the structure.

- C. Dewatering the basin:

- 1) Preferred Method- The preferred method for dewatering sediment basins is by using surface skimmers to decant the cleaner top surface water from the basin as the sediment settles out. See Dewatering Device Standard, page 5.10.

- 2) Alternative Method- A fixed vertical riser pipe configured with perforations and filter fabric with a cone of pea gravel or small crushed stone is an alternative option for use. See Figure 5.5 on page 5.14.

The sediment basin dewatering system shall be designed to release the dewatering zone volume between 2 to 7 days in watersheds not impaired by sediment, and 4-7 days in sediment impaired watersheds (check the NYSDEC Waterbody Inventory/Priority Waterbody List - <http://www.dec.ny.gov/chemical/36730.html>, to see if your site is in an impaired watershed). The design performance range will depend on the percent of silt and clay in the soils tributary to the basin. If the performance of the basin does not meet water quality objectives after 7 days, chemical treatment may be necessary.

- D. Anti-vortex device and trash rack:

An anti-vortex device and trash rack shall be securely installed on top of the riser and shall be the concentric type as shown in Figure 5.13 and 5.14 on pages 5.31 and 5.32.

- E. Base:

The riser shall have a base attached with a watertight connection and shall have sufficient weight to prevent flotation of the riser. Two approved bases for risers ten feet or less in height are: 1) a concrete base 18 in. thick with the riser embedded 9 in. in the base, and 2) a ¼" minimum thickness steel plate attached to the riser by a continuous weld around the circumference of the riser to form a watertight connection. The plate shall have 2.5 feet of stone, gravel, or compacted earth placed on it to prevent flotation. In either case, each side of the square base shall be twice the riser diameter.

For risers greater than ten feet high, computations

shall be made to design a base which will prevent flotation. The minimum factor of safety shall be 1.20 (Downward forces = 1.20 x upward forces). See Figure 5.15 on page 5.33 for details.

F. Anti-Seep Collars: Anti-seep collars shall be installed around all conduits through earth fills of impoundment structures according to the following criteria:

1) Collars shall be placed to increase the seepage length along the conduit by a minimum of 15 percent of the pipe length located within the saturation zone.

2) Collar spacing shall be between 5 and 14 times the vertical projection of each collar.

3) All collars shall be placed within the saturation zone.

4) The assumed normal saturation zone (phreatic line) shall be determined by projecting a line at a slope of 4 horizontal to 1 vertical from the point where the normal water (riser crest) elevation touches the upstream slope of the fill to a point where this line intersects the invert of the pipe conduit. All fill located within this line may be assumed as saturated.

$$2(N)(P) = 1.15(L_s) \quad N = (0.075)(L_s) / P$$

When anti-seep collars are used, the equation for revised seepage length becomes:

Where: L_s = Saturated length is length, in feet, of pipe between riser and intersection of phreatic line and pipe invert.

N = number of anti-seep collars.

P = vertical projection of collar from pipe, in feet.

5) All anti-seep collars and their connections shall be watertight. See Figures 5.16 and 5.17 on pages 5.34 and 5.35 for anti-seep collar design and Figure 5.18 on page 5.36 for construction details. Seepage diaphragms may be used in lieu of anti-seep collars. They shall be designed in accordance to USDA NRCS Pond Standard 378.

G. Outlet: An outlet shall be provided, including a means of conveying the discharge in an erosion free manner to an existing stable channel. Where

discharge occurs at the property line, drainage easements will be obtained in accordance with local ordinances. Adequate notes and references will be shown on the erosion and sediment control plan.

Protection against scour at the discharge end of the pipe spillway shall be provided. Measures may include basin, riprap, revetment, excavated plunge pools, or other approved methods. See Standard and Specification for Rock Outlet Protection, Section 3, page 3.39.

2. Emergency Spillways: The entire flow area of the emergency spillway shall be constructed in undisturbed ground (not fill). The emergency spillway cross-section shall be trapezoidal with a minimum bottom width of eight feet. This spillway channel shall have a straight control section of at least 20 feet in length; and a straight outlet section for a minimum distance equal to 25 feet.

A. Capacity: The minimum capacity of the emergency spillway shall be that required to pass the peak rate of runoff from the 10 year 24-hour frequency storm, less any reduction due to flow in the pipe spillway. Emergency spillway dimensions may be determined by using the method described in Figure 5.19 on page 5.37 and the Design Tables in Figures 5.20 and 5.21 on pages 5.38 and 5.39.

B. Velocities: The velocity of flow in the exit channel shall not exceed 5 feet per second for vegetated channels. For channels with erosion protection other than vegetation, velocities shall be within the non-erosive range for the type of protection used.

C. Erosion Protection: Erosion protection shall be provided for by vegetation as prescribed in this publication or by other suitable means such as riprap, asphalt or concrete.

D. Freeboard: Freeboard is the difference between the design high water elevation in the emergency spillway and the top of the settled embankment. If there is no emergency spillway, it is the difference between the water surface elevation required to pass the design flow through the pipe and the top of the settled embankment. Freeboard shall be at least one foot.

Embankment Cross-Section

1. The maximum height of dam = 15 feet (measured from the low point of original ground at the downstream toe to the top of the dam).
2. Minimum top width of dam = 10 feet.

3. Side slopes shall be 2.5 to 1 or flatter.

Entrance of Runoff into Basin

Points of entrance of surface runoff into excavated sediment basins shall be protected to prevent erosion. Considerable care should be given to the major points of inflow into basins. In many cases the difference in elevation of the inflow and the bottom of the basin is considerable, thus creating a potential for severe gulying and sediment generation. Often a riprap drop at major points of inflow would eliminate gulying and sediment generation.

Diversions, grade stabilization structures or other water control devices shall be installed as necessary to ensure direction of runoff and protect points of entry into the basin. Points of entry should be located so as to ensure maximum travel distance of entering runoff to point of exit (the riser) from the basin.

Disposal

The sediment basin plans shall indicate the method (s) of disposing of the sediment removed from the basin. The sediment shall be placed in such a manner that it will not erode from the site. The sediment shall not be deposited downstream from the basin, adjacent to a stream or floodplain. Disposal sites will be covered by an approved sediment control plan.

The sediment basins plans shall also show the method of disposing of the sediment basin after the drainage area is stabilized, and shall include the stabilization of the sediment basin site. Water contained within the storage areas shall be removed from the basin by pumping, cutting the top of the riser, or other appropriate method prior to removing or breaching the embankment. **Sediment shall not be allowed to flush into a stream or drainageway.**

Chemical Treatment

Precipitation of sediment is enhanced with the use of specific chemical flocculants that can be applied to the sediment basin in liquid, powder, or solid form. Flocculants include anionic polyelectrolytes such as polyacrylimides, aluminum sulfate (alum), polyaluminum chloride and chitosan. Cationic polyelectrolytes have a greater toxicity to fish and other aquatic organisms than anionic polyelectrolytes because they bind to the gills of fish resulting in respiratory failure (Pitt, 2003).

Chemical treatment shall not be substituted for proper erosion and sediment control. To reduce the need for flocculants, proper controls include planning, phasing, sequencing and practice design in accordance to NY Standards. **Chemical applications shall not be applied without written approval from the NYSDEC.**

Safety

Sediment basins are attractive to children and can be very dangerous. Local ordinances and regulations must be adhered to regarding health and safety. The developer or owner shall check with local building officials on applicable safety requirements. If fencing of sediment basins is required, the location of and type of fence shall be shown on the plans.

Construction Specifications

Site Preparation

Areas under the embankment shall be cleared, grubbed, and stripped of topsoil to remove trees, vegetation, roots, or other objectionable material. In order to facilitate cleanout and restoration, the pool area (measured at the top of the pipe spillway) will be cleared of all brush, trees, and other objectionable materials.

Cutoff-Trench

A cutoff trench shall be excavated along the centerline of earth fill embankments. The minimum depth shall be two feet. The cutoff trench shall extend up both abutments to the riser crest elevation. The minimum bottom width shall be four feet, but wide enough to permit operation of excavation and compaction equipment. The side slopes shall be no steeper than 1:1. Compaction requirements shall be the same as those for embankment. The trench shall be de-watered during the back-filling/compaction operations.

Embankment

The fill material shall be taken from approved areas shown on the plans. It shall be clean mineral soil free of roots, woody vegetation, oversized stones, rocks, or other objectionable material. Relatively pervious materials such as sand or gravel (Unified Soil Classes GW, GP, SW & SP) shall not be placed in the embankment. Areas on which fill is to be placed shall be scarified prior to placement of fill. The fill material shall contain sufficient moisture so that it can be formed by hand into a ball without crumbling. If water can be squeezed out of a ball, it is too wet for proper compaction. Fill material shall be placed in six to eight-inch thick continuous layers over the entire length of the fill. Compaction shall be obtained by routing and hauling the construction equipment over the fill so that the entire surface of each layer of the fill is traversed by at least one

wheel or tread track of the equipment or by the use of a compactor. The embankment shall be constructed to an elevation 10 percent higher than the design height to allow for settlement.

Pipe Spillway

The riser shall be securely attached to the barrel or barrel stub by welding the full circumference making a watertight structural connection. The barrel stub must be attached to the riser at the same percent (angle) of grade as the outlet conduit. The connection between the riser and the riser base shall be watertight. All connections between barrel sections must be achieved by approved watertight bank assemblies. The barrel and riser shall be placed on a firm, smooth foundation of impervious soil. Pervious materials such as sand, gravel, or crushed stone shall not be used as backfill around the pipe or anti-seep collars. The fill material around the pipe spillway shall be placed in four-inch layers and compacted under and around the pipe to at least the same density as the adjacent embankment.

A minimum depth of two feet of hand compacted backfill shall be placed over the pipe spillway before crossing it with construction equipment. Steel base plates on risers shall have at least 2 ½ feet of compacted earth, stone, or gravel placed over it to prevent flotation.

Emergency Spillway

The emergency spillway shall be installed in undisturbed ground. The achievement of planned elevations, grades, design width, entrance and exit channel slopes are critical to the successful operation of the emergency spillway and must be constructed within a tolerance of +/- 0.2 feet.

Vegetative Treatment

Stabilize the embankment and emergency spillway in accordance with the appropriate vegetative standard and specification immediately following construction. In no case shall the embankment remain unstabilized for more than three (3) days.

Erosion and Pollution Control

Construction operations shall be carried out in such a manner that erosion and water pollution will be minimized. State and local laws shall be complied with concerning pollution abatement.

Safety

State and local requirements shall be met concerning fencing and signs, warning the public of hazards of soft sediment and floodwater.

Maintenance

1. Repair all damages caused by soil erosion and construction equipment at or before the end of each working day.
2. Sediment shall be removed from the basin when it reaches the specified depth for cleanout noted on the plans which will not exceed 50% of the capacity of the sediment storage zone. This sediment shall be placed in such a manner that it will not erode from the site. The sediment shall not be deposited downstream from the embankment, adjacent to a stream or floodplain.

Final Disposal

When temporary structures have served their intended purpose and the contributing drainage area has been properly stabilized, the embankment and resulting sediment deposits are to be leveled or otherwise disposed of in accordance with the approved sediment control plan. The proposed use of a sediment basin site will often dictate final disposition of the basin and any sediment contained therein. If the site is scheduled for future construction, then the basin material and trapped sediments must be removed, safely disposed of, and backfilled with a structural fill. When the basin area is to remain open space, the pond may be pumped dry, graded, and backfilled.

Information to be Submitted

Sediment basin designs and construction plans submitted for review to a local municipality, New York State DEC, New York City DEP, Soil and Water Conservation District, or other agency shall include the following:

1. Specific location of the basin.
2. Plan view of the storage basin and emergency spillway, showing existing and proposed contours.
3. Cross section of dam, principal spillway, emergency spillway, and profile of emergency spillway.
4. Details of pipe connections, riser to pipe connections, riser base, anti-seep control, trash rack cleanout elevation, and anti-vortex device.
5. Runoff calculations for 1 and 10-year frequency storms, if required.
6. Storage Computations
 - A. Zones total required
 - B. Zones total Available
 - C. Elevation of sediment at which cleanout shall be required; also stated as a distance from the riser

TEMPORARY SEDIMENT BASIN DESIGN DATA SHEET

Computed by _____ Date _____ Checked by _____ Date _____
Project _____ Basin # _____
Location _____ Total Area draining to basin (≤ 50 Ac.) _____ Acres

BASIN SIZE DESIGN

1. Sediment storage zone volume = 1,000 cu. ft. x number of disturbed acres = _____ cu. ft., Top of Zone Elev. _____
2. Dewatering zone volume = 3,600 cu. ft. x number of drainage area acres = _____ cu. ft., Top of Zone Elev. _____
3. Length to width ratio = _____
4. A. Cleanout at 50% of sediment storage zone volume, Elev. _____
B. Distance below top of riser _____ feet
5. Minimum surface area is larger of $0.01 Q_{(10)}$ _____ or, $0.015 DA$ = _____ use _____ acres

DESIGN OF SPILLWAYS & ELEVATIONS

Runoff

6. $Q_{p(10)}$ = _____ cfs (Attach runoff computation sheets)

Pipe Spillway (Q_{ps})

7. Min. pipe spillway cap., $Q_{ps} = 0.2 \times$ _____ Drainage Area, acres = _____ cfs
Note: If there is no emergency spillway, then required $Q_{ps} = Q_{p(10)} =$ _____ cfs.
8. H, head = _____ ft. Barrel length = _____ ft
9. Barrel: Diam. _____ inches; $Q_{ps} = (Q)$ _____ x (cor.fac.) _____ = _____ cfs.
10. Riser: Diam. _____ inches; Length _____ ft.; h = _____ ft. Crest Elev. _____
11. Trash Rack: Diameter = _____ inches; H, height = _____ inches

Emergency Spillway Design

12. Emergency Spillway Flow, $Q_{es} = Q_p - Q_{ps} =$ _____ - _____ = _____ cfs.
13. Width _____ ft.; H_p _____ ft. Crest elevation _____; Design High Water Elev. _____
Entrance channel slope _____ % ; Top of Dam Elev. _____
Exit channel slope _____ %

ANTI-SEEP COLLAR/SEEPAGE DIAPHRAGM DESIGN

Collars:

14. $y =$ _____ ft.; $z =$ _____ :1; pipe slope = _____ %, $L_s =$ _____ ft.
Use _____ collars, _____ - _____ inches square; projection = _____ ft.

Diaphragms:

_____ width _____ ft. height _____ ft.

DEWATERING ORIFICE SIZING

(Determined from the Dewatering Device Standard)

15. Dewatering orifice diameter = _____ inches. Skimmer ____ or Riser ____ (check one)
16. Design dewatering time _____ days (Min. 2 days required)

TEMPORARY SEDIMENT BASIN DESIGN DATA SHEET

INSTRUCTIONS FOR USE OF FORM

1. Minimum required sediment storage zone volume is 1,000 cubic feet per acre from each disturbed acre within the total drainage area. Minimum required dewatering zone volume is 3,600 cubic feet per total area draining to the basin.
2. The volume of a naturally shaped basin (no excavation in basin) may be approximated by the formula $V = (0.4)(A)(d)$, where V is in cubic feet, A is the surface area of the basin, in square feet, and d is the maximum depth of the basin, in feet. Volume may be computed from contour information or other suitable methods.
3. If volume of basin is not adequate for required storage, excavate to obtain the required zone volumes.
4. The minimum surface area of the basin pool at the storage volume elevation will be the larger of the two elevations shown.
5. Use of the NRCC hydrologic data at www.precip.net with an appropriate hydrologic model, is the preferred process for runoff computation. Runoff curve numbers will be computed for the drainage area that reflects the maximum construction condition.
6. Required minimum discharge from pipe spillway equals 0.2 cfs/ac. times total drainage area. (This is equivalent to a uniform runoff of 5 in. per 24 hours). The pipe shall be designed to carry Q_p if site conditions preclude installation of an emergency spillway to protect the structure.
7. Determine value of "H" from field conditions; "H" is the interval between the centerline of the outlet pipe and the emergency spillway crest, or if there is no emergency spillway, to the design high water.
8. See Pipe Flow Charts, Figures 5.11 and 5.12 on pages 5.29 and 5.30.
9. See Riser Inflow Curves, Figure 5.10 on page 5.28.
10. Compute the orifice size required to dewater the basin over a minimum 48 hour period. See the Dewatering Device Standard on page 5.10.
11. See Trash Rack and Anti-Vortex Device Design, Figures 5.13 and 5.14 on pages 5.31 and 5.32.
12. Compute Q_{es} by subtracting actual flow carried by the pipe spillway from the total inflow, Q_p .
13. Use appropriate tables to obtain values of H_p , bottom width, and actual Q_{es} . If no emergency spillway is to be used, so state, giving reason (s).
14. See Anti-Seep Collar / Seepage Diaphragm Design (see figures 5.16, 5.17 and 5.18 on pages 5.34, 5.35 and 5.36).
15. Fill in design elevations. The emergency spillway crest must be set no closer to riser crest than value of h , which causes pipe spillway to carry the minimum, required Q . Therefore, the elevation difference between spillways shall be equal to the value of h , or one foot, whichever is greater. Design high water is the elevation of the emergency spillway crest plus the value of H_p , or if there is no emergency spillway, it is the elevation of the riser crest plus h required to handle the 10-year storm. Minimum top of dam elevation requires 1.0 ft. of freeboard above design high water.

To use charts for pipe spillway design:

1. Enter chart, Figures 5.11 or 5.12 on pages 5.29 and 5.30 with H and required discharge.
2. Find diameter of pipe conduit that provides equal or greater discharge
3. Enter chart, Figure 5.10 on page 5.28 with actual pipe discharge. Read across to select smallest riser that provides discharge within weir flow portion of rating curve. Read down to find corresponding h required. This h must be 1 foot or less.

**Figure 5.8
Pipe Spillway Design**

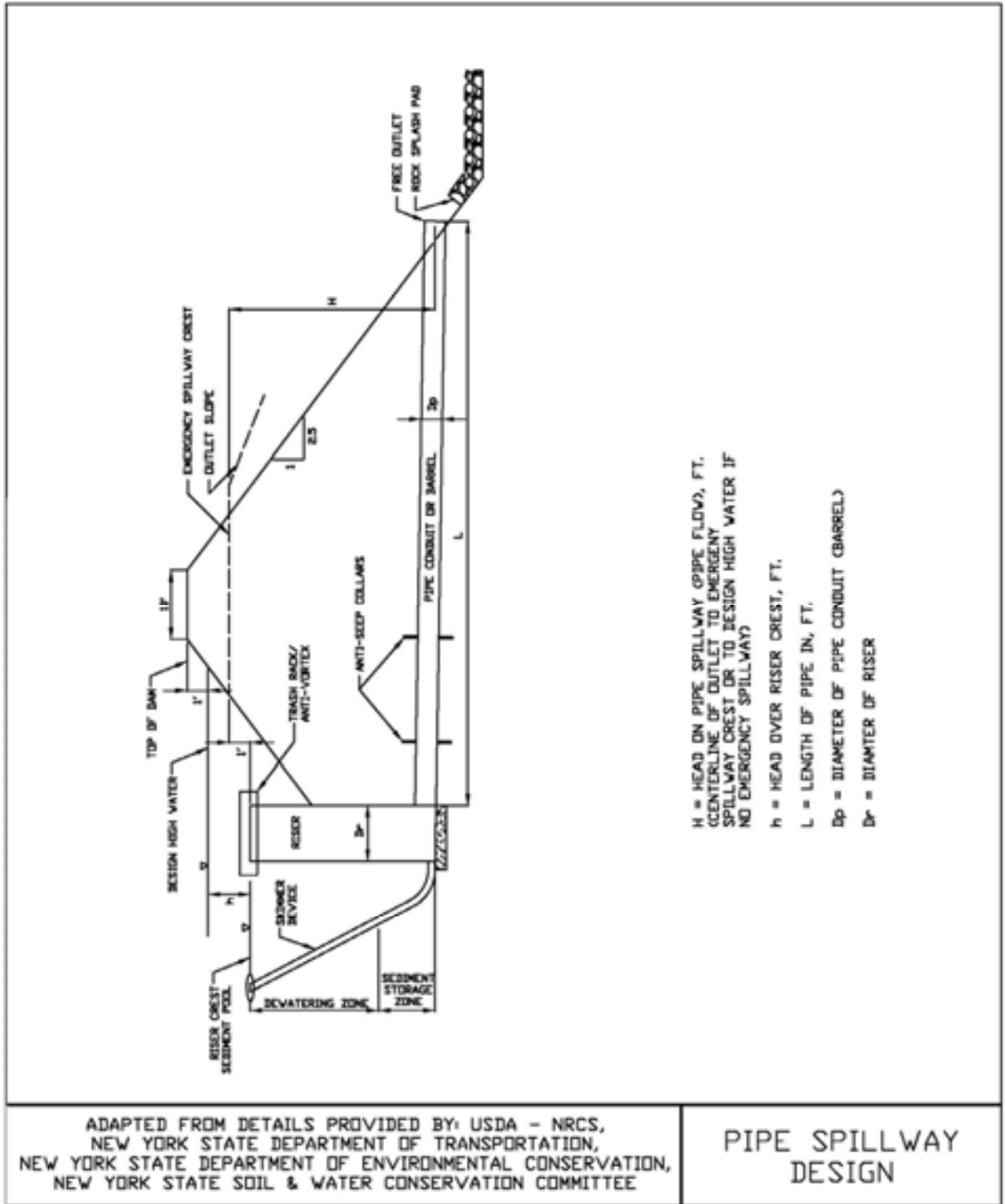

Figure 5.9
Sediment Basin

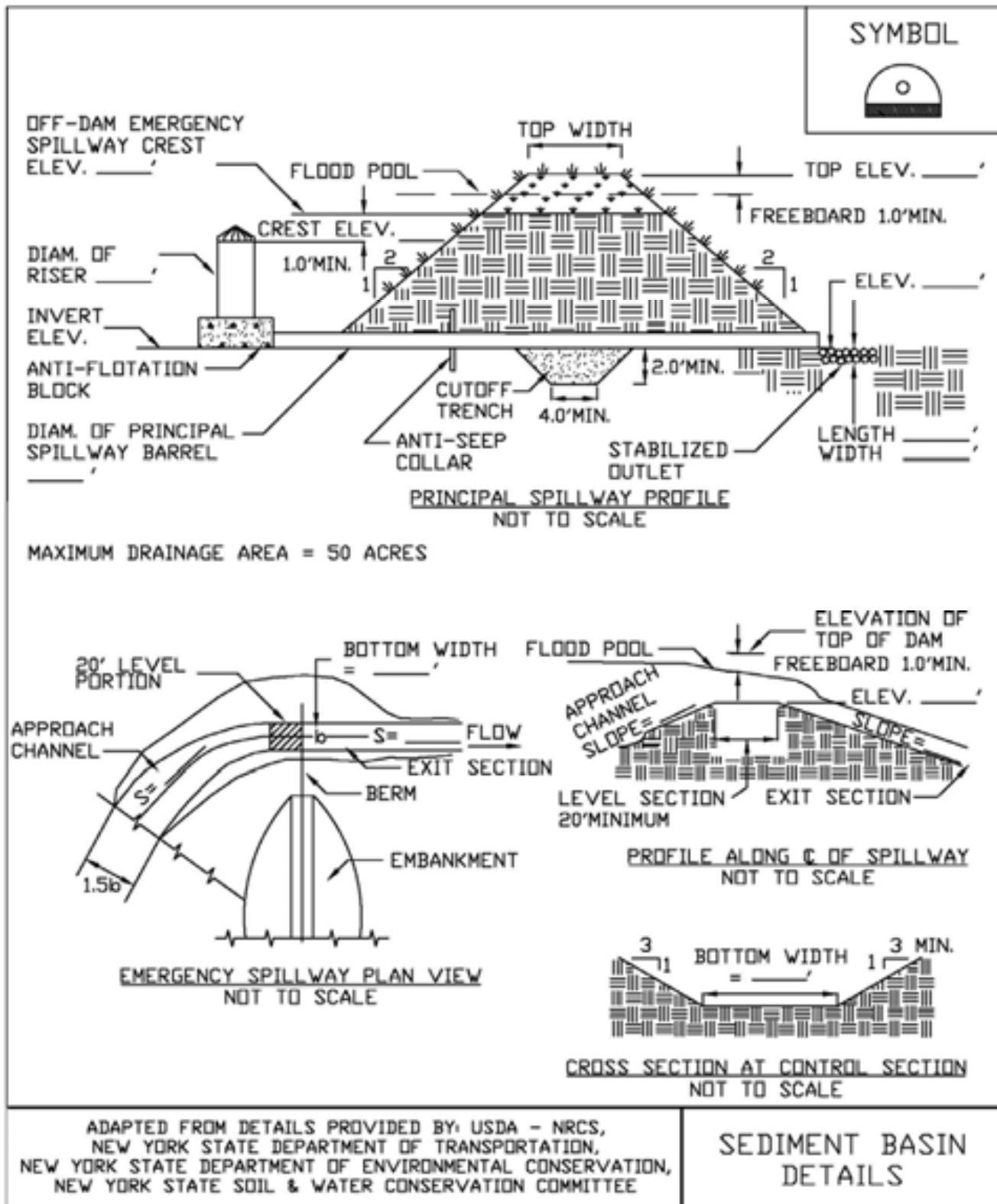

Figure 5.10
Riser Inflow Chart (USDA - NRCS)

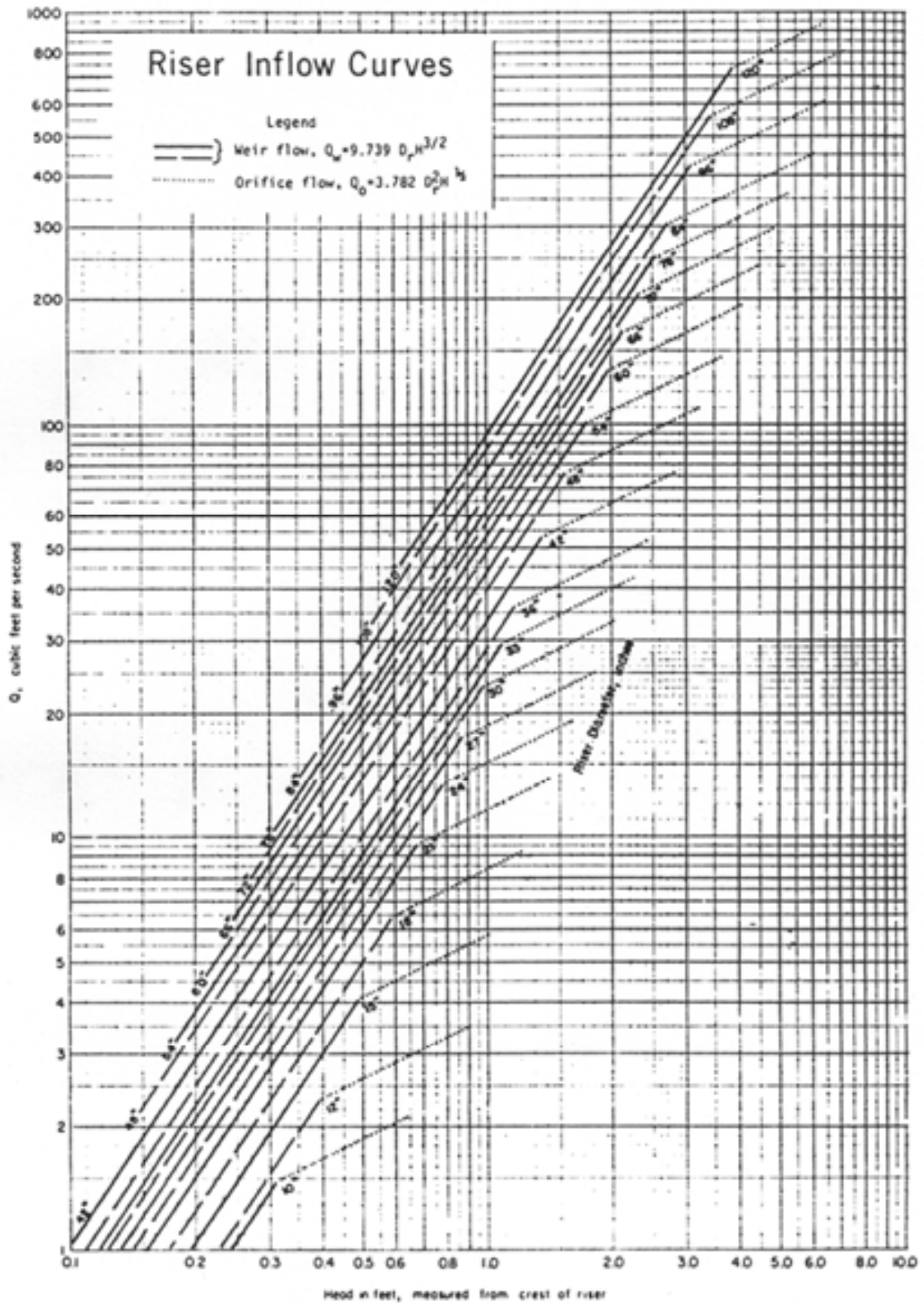

Figure 5.11 Pipe Flow Chart; “n” = 0.025 (USDA - NRCS)

PIPE FLOW CHART n = 0.025
FOR CORRUGATED METAL PIPE INLET $K_b = K_a + K_p = 1.0$ AND 70 FEET OF CORRUGATED METAL PIPE CONDUIT (Full flow assumed)
 Note: correction factors for pipe lengths other than 70 feet
 diameter of pipe in inches

R, in	Correction Factors For Other Pipe Lengths																				
	6"	8"	10"	12"	15"	18"	21"	24"	30"	36"	42"	48"	54"	60"	66"	72"	78"	84"	90"	96"	102"
1	0.33	0.70	1.25	1.90	2.48	3.47	7.99	11.0	18.8	28.8	41.1	55.7	72.6	91.8	113	137	163	191	222	255	290
2	0.47	0.99	1.76	2.80	4.92	7.74	11.3	15.6	26.6	40.8	58.2	78.8	103	130	160	196	231	271	314	360	410
3	0.58	1.22	2.16	3.43	6.02	9.48	13.8	19.1	32.6	49.9	71.2	96.5	126	159	196	237	282	331	384	441	502
4	0.67	1.40	2.49	3.97	6.96	10.9	16.0	22.1	37.6	57.7	82.3	111	145	184	226	274	326	383	444	510	580
5	0.74	1.57	2.79	4.43	7.78	12.2	17.9	24.7	42.1	64.5	92.0	125	162	205	253	306	365	428	496	570	648
6	0.82	1.72	3.05	4.86	8.52	13.4	19.6	27.0	46.1	70.6	101	136	178	225	277	336	399	469	544	624	710
7	0.88	1.86	3.20	5.25	9.20	14.5	21.1	29.2	49.8	76.3	109	147	192	243	300	362	431	506	587	674	767
8	0.94	1.99	3.53	5.61	9.84	15.5	22.6	31.2	53.2	81.5	116	158	205	260	320	388	461	541	628	721	820
9	1.00	2.11	3.74	5.95	10.4	16.4	24.0	33.1	56.4	86.5	123	167	218	275	340	411	489	574	666	764	870
10	1.05	2.22	3.94	6.27	11.0	17.3	25.3	34.9	59.5	91.2	130	176	230	290	358	433	516	605	702	806	917
11	1.10	2.33	4.13	6.50	11.5	18.2	26.5	36.6	62.4	95.6	136	185	241	304	376	454	541	635	736	845	962
12	1.15	2.43	4.22	6.87	12.1	19.0	27.7	38.2	65.2	99.9	142	193	252	318	392	475	565	663	769	883	1004
13	1.20	2.53	4.49	7.15	12.6	19.7	28.8	39.8	67.8	104	148	201	262	331	408	494	588	690	800	919	1045
14	1.25	2.63	4.66	7.42	13.0	20.5	29.9	41.3	70.4	108	154	208	272	343	424	513	610	716	830	953	1085
15	1.29	2.72	4.83	7.68	13.5	21.2	30.9	42.8	72.8	112	159	216	281	355	439	531	631	741	860	987	1123
16	1.33	2.81	4.99	7.93	13.9	21.9	32.0	44.2	75.2	115	165	223	290	367	453	548	652	765	888	1019	1160
17	1.37	2.90	5.14	8.18	14.3	22.6	32.9	45.5	77.5	119	170	230	299	378	467	565	672	789	915	1051	1195
18	1.41	2.98	5.29	8.41	14.8	23.2	33.9	46.8	79.8	120	174	236	308	389	480	581	692	812	942	1081	1230
19	1.45	3.06	5.43	8.64	15.2	23.9	34.8	48.1	82.0	126	179	243	316	400	494	597	711	834	967	1111	1264
20	1.49	3.14	5.57	8.87	15.6	24.5	35.7	49.4	84.1	129	184	249	325	410	506	613	729	856	993	1139	1297
21	1.53	3.22	5.73	9.09	15.9	25.1	36.6	50.6	86.2	132	188	255	333	421	519	628	747	877	1017	1168	1329
22	1.56	3.29	5.85	9.30	16.3	25.7	37.5	51.8	88.2	135	193	261	341	430	531	643	765	898	1041	1195	1360
23	1.60	3.37	5.98	9.51	16.7	26.2	38.3	53.0	90.2	138	197	267	348	440	543	657	782	918	1064	1222	1390
24	1.63	3.44	6.13	9.72	17.0	26.8	39.1	54.1	92.1	141	201	273	356	450	555	671	799	937	1087	1248	1420
25	1.66	3.51	6.23	9.92	17.4	27.4	39.9	55.2	94.0	144	206	279	363	459	566	685	815	957	1110	1274	1450
26	1.70	3.58	6.36	10.1	17.7	27.9	40.7	56.3	95.9	147	210	284	370	468	577	699	831	976	1132	1299	1478
27	1.73	3.65	6.48	10.3	18.1	28.4	41.5	57.4	97.7	150	214	290	377	477	588	712	847	994	1153	1324	1507
28	1.76	3.72	6.60	10.5	18.4	29.0	42.3	58.4	99.5	153	218	295	384	486	599	725	863	1013	1174	1348	1534
29	1.79	3.78	6.73	10.7	18.7	29.5	43.0	59.5	101	155	222	300	391	494	610	738	878	1030	1195	1372	1561
30	1.82	3.85	6.83	10.9	19.1	30.0	43.7	60.5	103	158	225	305	398	503	620	750	893	1048	1216	1396	1588

Figure 5.12
Pipe Flow Chart; “n” = 0.013 (USDA - NRCS)

PIPE FLOW CHART n = 0.013
 FOR REINFORCED CONCRETE PIPE INLET $K_w = K_b + K_d = 1.00$ AND 70 FEET OF REINFORCED CONCRETE PIPE CONDUIT (full flow assumed)
 Note correction factors for pipe lengths other than 70 feet
 diameter of pipe in inches

H, in feet	13"	15"	18"	21"	24"	30"	36"	42"	48"	54"	60"	66"	72"	78"	84"	90"	96"	102"
1	3.22	5.44	8.29	11.8	15.9	26.0	38.6	53.8	71.4	91.5	114	139	167	197	229	264	302	347
2	4.55	7.69	11.7	16.7	22.5	36.8	54.6	76.0	101	129	161	197	236	278	324	374	427	483
3	5.57	9.42	14.4	20.4	27.5	45.0	66.9	93.1	124	159	198	241	289	341	397	458	523	592
4	6.43	10.9	16.6	23.5	31.8	52.0	77.3	108	143	183	228	278	334	394	459	529	604	683
5	7.19	12.2	18.5	26.3	35.5	58.1	86.4	120	160	205	255	311	373	440	513	591	675	764
6	7.88	13.3	20.3	28.8	38.9	63.7	94.6	132	175	224	280	341	409	482	562	647	739	837
7	8.51	14.4	21.9	31.1	42.0	68.8	102	142	189	242	302	368	441	521	607	699	798	904
8	9.10	15.4	23.5	33.3	44.9	73.5	109	152	202	259	323	394	472	557	645	740	854	966
9	9.65	16.3	24.9	35.3	47.7	78.0	116	161	214	275	342	418	500	588	680	783	905	1025
10	10.2	17.2	26.2	37.2	50.2	82.2	122	170	226	289	361	440	527	622	725	836	954	1080
11	10.7	18.0	27.5	39.0	52.7	86.2	128	178	237	304	379	462	553	653	761	877	1001	1133
12	11.1	18.9	28.7	40.8	55.0	90.1	134	186	247	317	395	482	578	682	794	916	1045	1184
13	11.6	19.6	29.9	42.4	57.3	93.7	139	194	257	330	411	502	601	710	827	953	1088	1232
14	12.0	20.4	31.0	44.1	59.4	97.3	145	201	267	342	427	521	624	736	858	989	1129	1278
15	12.5	21.1	32.1	45.6	61.5	101	150	208	277	354	442	539	646	762	888	1024	1169	1323
16	12.9	21.8	33.2	47.1	63.5	104	155	215	286	366	457	557	667	787	917	1057	1207	1367
17	13.3	22.4	34.2	48.5	65.5	107	159	222	294	377	471	574	688	812	946	1090	1244	1409
18	13.7	23.1	35.2	49.9	67.4	110	164	228	303	388	484	591	708	835	973	1121	1280	1450
19	14.0	23.7	36.1	51.3	69.2	113	168	234	311	399	497	607	727	858	1000	1152	1315	1489
20	14.4	24.3	37.1	52.6	71.0	116	173	240	319	409	510	623	746	880	1026	1182	1350	1528
21	14.7	24.9	38.0	53.9	72.8	119	177	246	327	419	523	638	764	902	1051	1211	1383	1566
22	15.1	25.5	38.9	55.2	74.5	122	181	252	335	429	535	653	782	923	1076	1240	1415	1603
23	15.4	26.1	39.8	56.5	76.2	125	186	258	342	439	547	668	800	944	1100	1260	1447	1639
24	15.8	26.7	40.6	57.7	77.8	127	189	263	350	448	559	682	817	964	1123	1295	1478	1674
25	16.1	27.2	41.5	58.9	79.4	130	193	269	357	458	571	696	834	984	1147	1322	1509	1708
26	16.4	27.7	42.3	60.0	81.0	133	197	274	364	467	582	710	850	1004	1169	1340	1539	1742
27	16.7	28.3	43.1	61.2	82.5	135	201	279	371	476	593	723	867	1023	1182	1373	1568	1775
28	17.0	28.8	43.9	62.3	84.1	138	204	285	378	484	604	737	883	1041	1214	1399	1597	1808
29	17.3	29.3	44.7	63.4	85.5	140	208	290	384	493	615	750	898	1060	1235	1423	1625	1840
30	17.6	29.8	45.4	64.5	87.0	142	212	294	391	501	625	763	913	1078	1256	1440	1653	1871

L, in feet	1.24	1.28	1.32	1.36	1.40	1.44	1.48	1.52	1.56	1.60	1.64	1.68	1.72	1.76	1.80	1.84	1.88	1.92	1.96
20	1.30	1.24	1.21	1.18	1.15	1.12	1.10	1.08	1.07	1.06	1.05	1.04	1.04	1.03	1.03	1.02	1.02	1.02	1.02
30	1.22	1.18	1.15	1.13	1.12	1.09	1.08	1.06	1.05	1.04	1.03	1.03	1.02	1.02	1.02	1.02	1.02	1.02	1.02
40	1.15	1.13	1.11	1.10	1.08	1.07	1.05	1.04	1.03	1.03	1.02	1.02	1.02	1.02	1.02	1.02	1.02	1.02	1.02
50	1.09	1.08	1.07	1.06	1.05	1.04	1.04	1.03	1.03	1.02	1.02	1.02	1.02	1.02	1.02	1.02	1.02	1.02	1.02
60	1.04	1.04	1.03	1.03	1.03	1.02	1.02	1.02	1.01	1.01	1.01	1.01	1.01	1.01	1.01	1.01	1.01	1.01	1.01
70	1.00	1.00	1.00	1.00	1.00	1.00	1.00	1.00	1.00	1.00	1.00	1.00	1.00	1.00	1.00	1.00	1.00	1.00	1.00
80	0.96	0.97	0.97	0.97	0.98	0.98	0.98	0.99	0.99	0.99	0.99	0.99	0.99	0.99	0.99	0.99	0.99	0.99	0.99
90	0.93	0.94	0.94	0.95	0.95	0.96	0.96	0.97	0.98	0.98	0.98	0.98	0.98	0.98	0.98	0.98	0.98	0.98	0.98
100	0.90	0.91	0.92	0.93	0.93	0.95	0.95	0.96	0.97	0.97	0.97	0.98	0.98	0.98	0.98	0.98	0.98	0.98	0.98
120	0.84	0.86	0.87	0.89	0.90	0.91	0.93	0.94	0.94	0.95	0.96	0.96	0.96	0.96	0.96	0.96	0.96	0.96	0.96
140	0.80	0.82	0.83	0.85	0.86	0.88	0.90	0.91	0.92	0.93	0.94	0.94	0.95	0.95	0.95	0.95	0.95	0.95	0.95
160	0.76	0.78	0.80	0.82	0.83	0.86	0.88	0.89	0.90	0.91	0.92	0.93	0.94	0.94	0.94	0.94	0.94	0.94	0.94

Correction Factors For Other Pipe Lengths

Figure 5.13
Concentric Trash Rack and Anti-Vortex Device (USDA - NRCS)

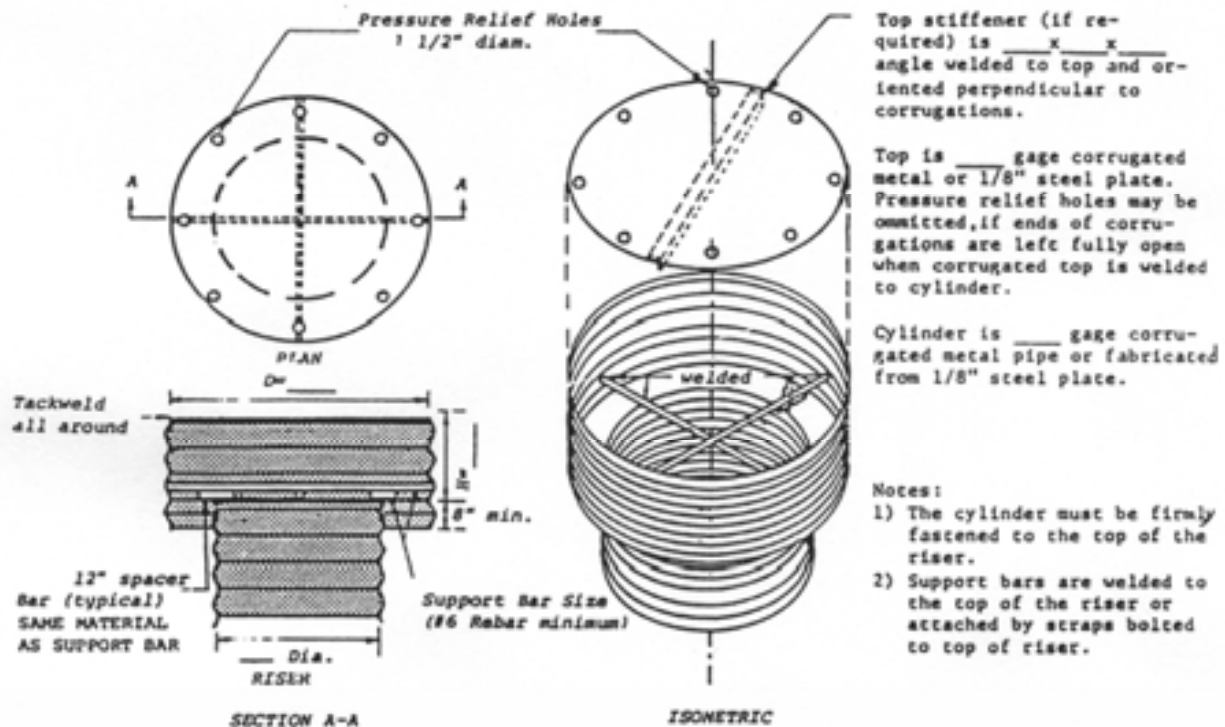

CONCENTRIC TRASH RACK AND ANTI-VORTEX DEVICE
 (not to scale)

Figure 5.14
Concentric Trash Rack and Anti-Vortex Device Design Table
 (USDA - NRCS)

Riser Diam. (in.)	Cylinder Diam. (in.)	Thick. Gage	H. (in.)	Minimum Size Support Bar	Minimum Top	
					Thickness	Stiffener
12	18	16	6	#6 Rebar	16 ga.	—
15	21	16	7	#6 Rebar	16 ga.	—
18	27	16	8	#6 Rebar	16 ga.	—
21	30	16	11	#6 Rebar	16 ga.	—
24	36	16	13	#6 Rebar	14 ga.	—
27	42	16	15	#6 Rebar	14 ga.	—
36	54	14	17	#8 Rebar	12 ga.	—
42	60	14	19	#8 Rebar	12 ga.	—
48	72	12	21	1 1/4" pipe or 1 1/4x1 1/4x1/4 angle	10 ga.	—
54	78	12	25	See 48" Riser	10 ga.	—
60	90	12	29	1 1/2" pipe or 1 1/2x1 1/2x1/2 angle	8 ga.	—
66	96	10	33	2" pipe or 2x2x3/16 angle	8 ga. w/stiffener	2x2x1/4 angle
72	102	10	36	—See 66" Riser—		2 1/2x2 1/2x1/4 angle
78	114	10	39	2 1/2" pipe or 2x2x1/4 angle	See 72" Riser	See 72" Riser
84	120	10	42	2 1/2" pipe or 2 1/2x2 1/2x1/4 angle	See 72" Riser	2 1/2x 2 1/2x 5/16 angle

Note: The criteria for sizing the cylinder is that the area between the inside of the cylinder and the outside of the riser is equal to or greater than the area inside the riser. Therefore, the above table is invalid for use with concrete pipe risers.

Figure 5.15
Riser Base Details

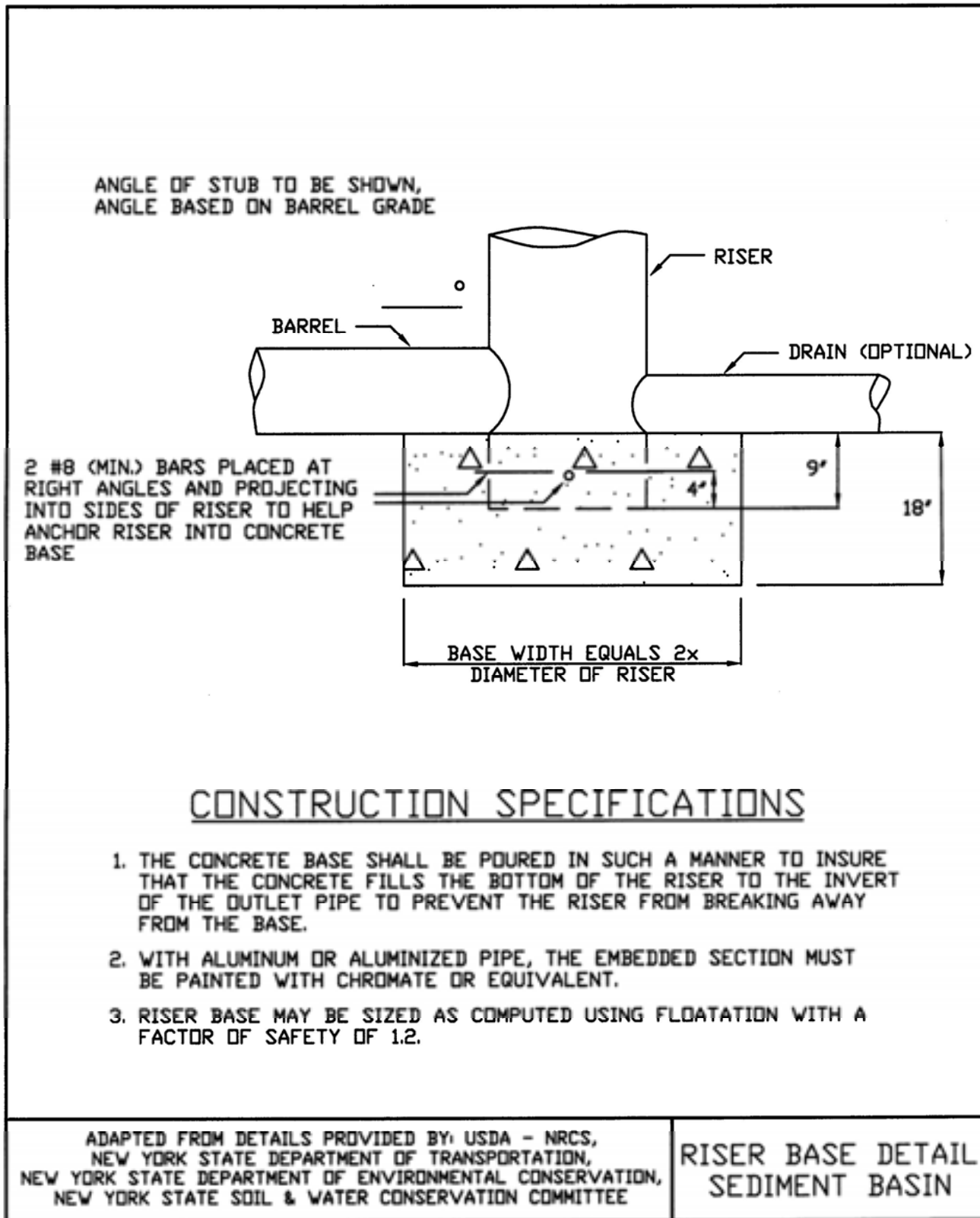

Figure 5.16 Anti-Seep Collar Design

This procedure provides the anti-seep collar dimensions for only temporary sediment basins to increase the seepage length by 15% for various pipe slopes, embankment slopes and riser heights.

The first step in designing anti-seep collars is to determine the length of pipe within the saturated zone of the embankment. This can be done graphically or by the following equation, assuming that the upstream slope of the embankment intersects the invert of the pipe at its upstream end. (See embankment-invert intersection on the drawing below:

$$L_s = y (z + 4) \left[1 + \frac{\text{pipe slope}}{0.25 - \text{pipe slope}} \right]$$

Where: L_s = length of pipe in the saturated zone (ft.)

y = distance in feet from upstream invert of pipe to highest normal water level expected to occur during the life of the structure, usually the top of the riser.

z = slope of upstream embankment as a ratio of z ft. horizontal to one ft. vertical.

pipe slope = slope of pipe in feet per foot.

This procedure is based on the approximation of the phreatic line as shown in the drawing below:

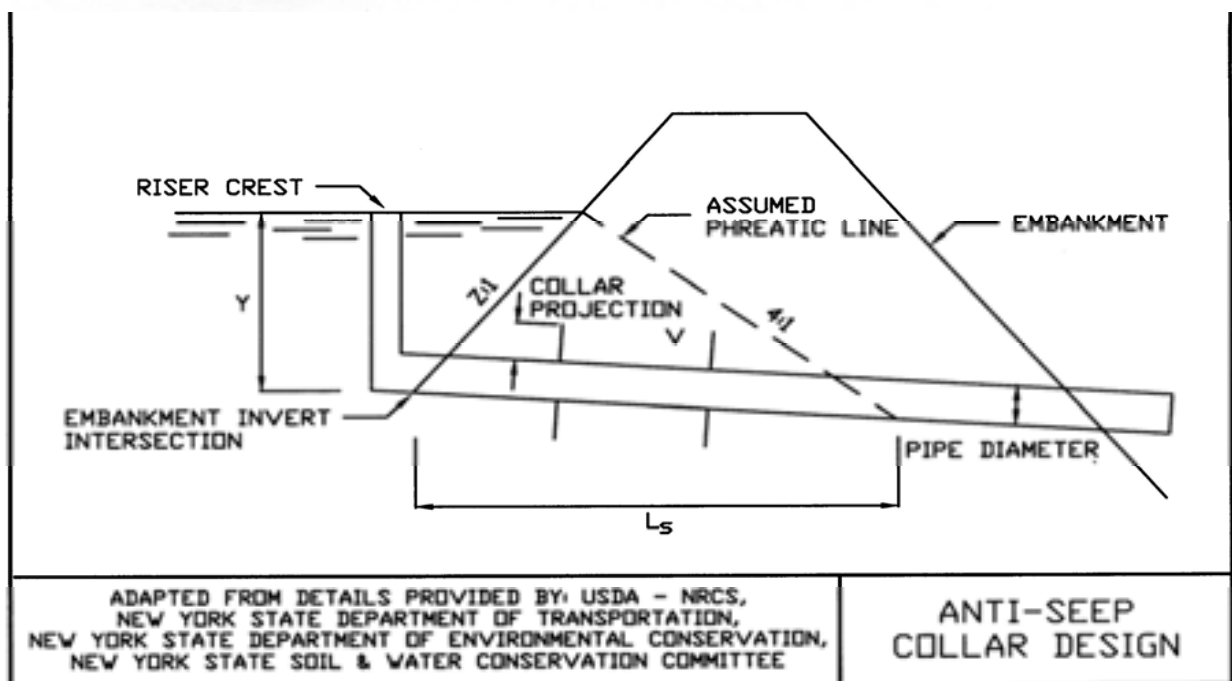

Figure 5.17
Anti-Seep Collar Design Charts (USDA - NRCS)

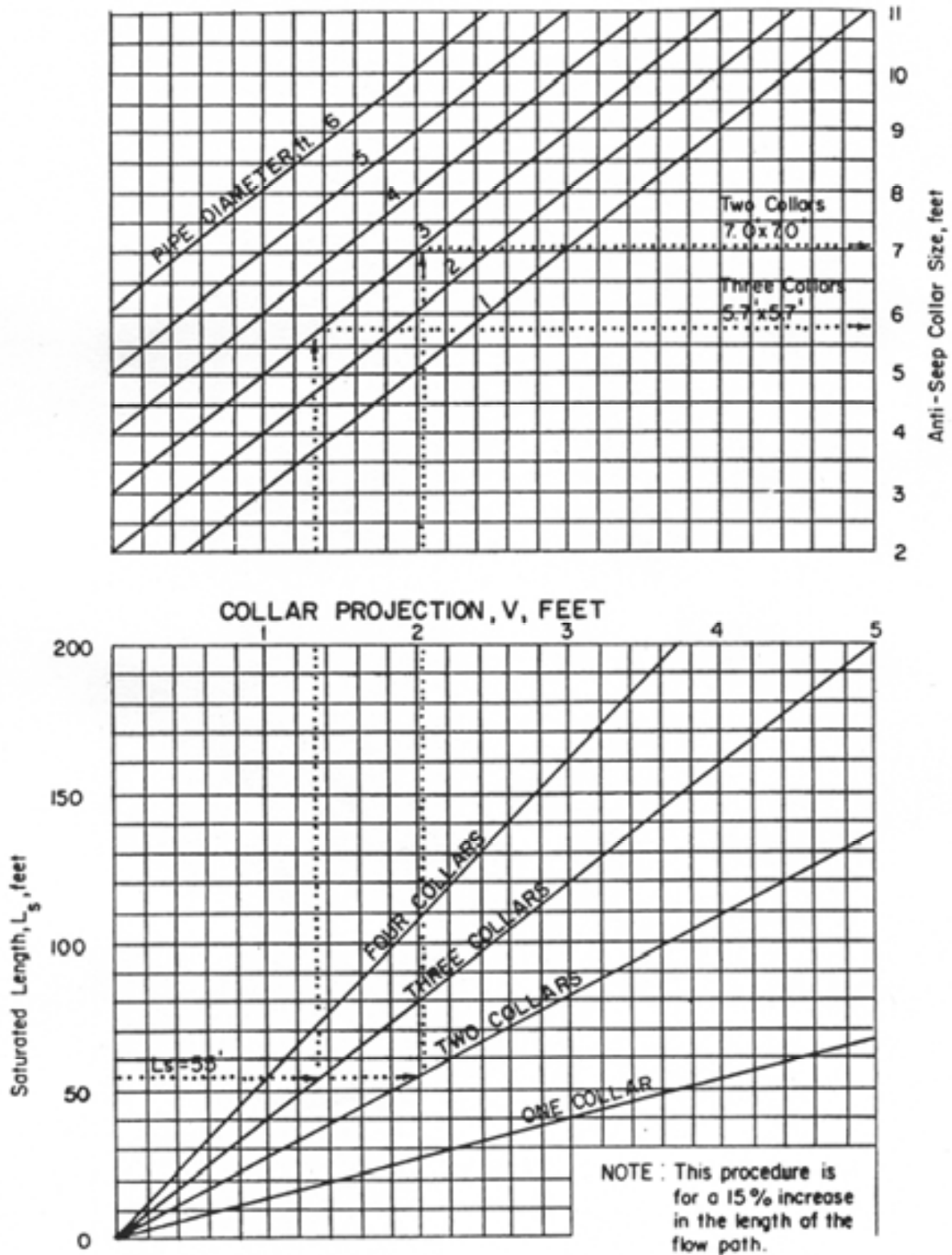

Figure 5.18
Anti-Seep Collar

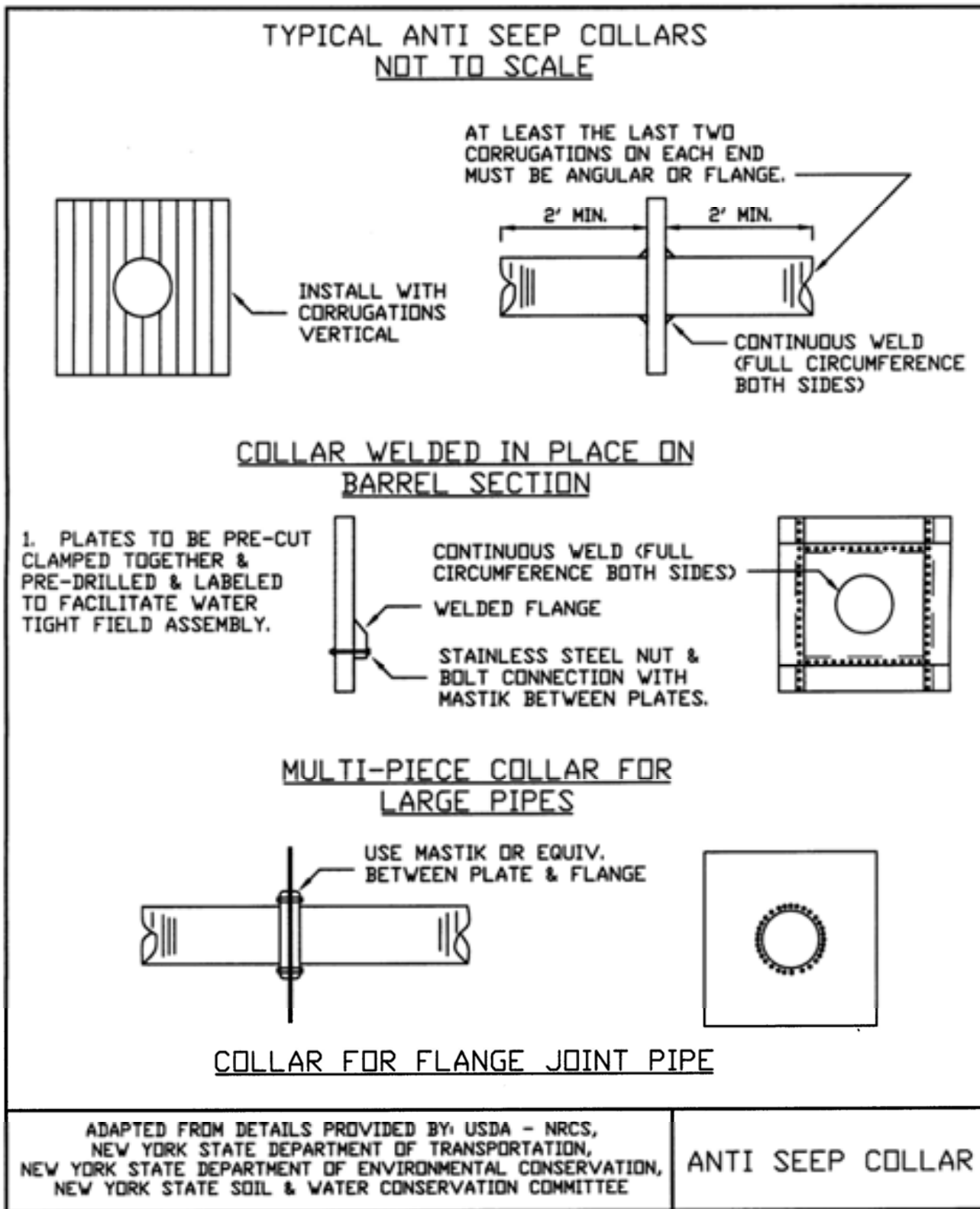

Figure 5.19
Design Data for Earth Spillways

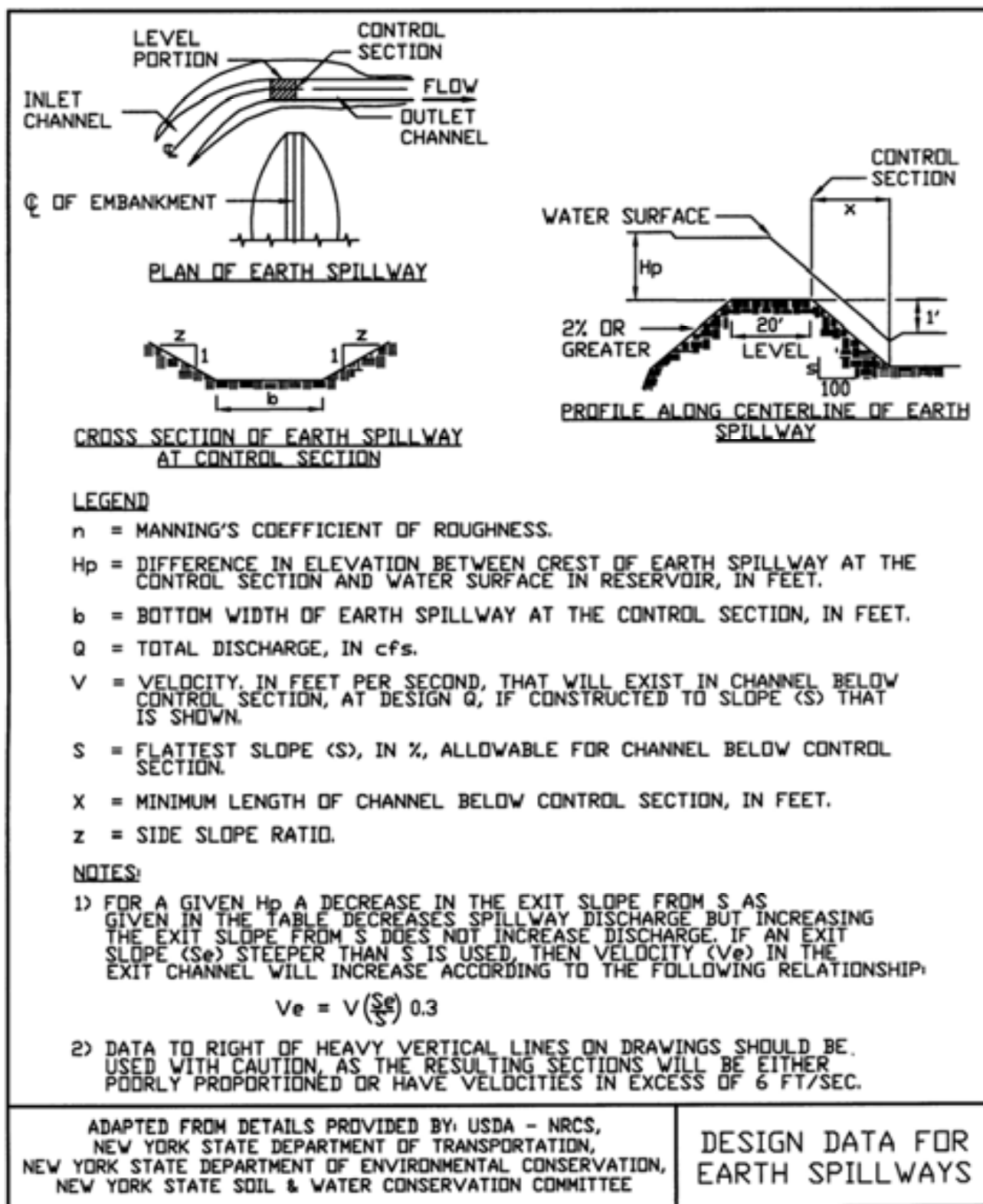

Figure 5.20
Design Table for Vegetated Earth Spillways in
Erosion Resistant Soils, K=0.1 - 0.35, Side Slopes = 3:1

Discharge Q CFS	Slope Range		Bottom Width Feet	Stage Feet	Discharge Q CFS	Slope Range		Bottom Width Feet	Stage Feet
	Minimum Percent	Maximum Percent				Minimum Percent	Maximum Percent		
15	3.3	12.2	8	.83	80	2.8	5.2	24	1.24
	3.5	18.2	12	.89		2.8	5.9	28	1.14
20	3.1	8.9	8	.97	90	2.9	7.0	32	1.06
	3.2	13.0	12	.81		2.5	2.6	12	1.84
25	3.3	17.3	16	.70	2.5	3.1	16	1.61	
	2.9	7.1	8	1.09	2.6	3.8	20	1.45	
	3.2	9.9	12	.91	2.7	4.5	24	1.32	
30	3.3	13.2	16	.79	2.8	5.3	28	1.22	
	3.3	17.2	20	.70	2.8	6.1	32	1.14	
	2.9	6.0	8	1.20	2.5	2.8	16	1.71	
35	3.0	8.2	12	1.01	2.6	3.3	20	1.54	
	3.0	10.7	16	.88	2.6	4.0	24	1.41	
	3.3	13.8	20	.78	2.7	4.8	28	1.30	
40	2.8	5.1	8	1.30	2.7	5.3	32	1.21	
	2.9	6.9	12	1.10	2.8	6.1	36	1.13	
	3.1	9.0	16	.94	2.5	2.8	20	1.71	
45	3.1	11.3	20	.85	2.6	3.2	24	1.56	
	3.2	14.1	24	.77	2.7	3.8	28	1.44	
	2.7	4.5	8	1.40	2.7	4.2	32	1.34	
50	2.9	6.0	12	1.18	2.7	4.8	36	1.28	
	2.9	7.6	16	1.03	2.5	2.7	24	1.71	
	3.1	9.7	20	.91	2.5	3.2	28	1.58	
55	3.1	11.9	24	.83	2.6	3.6	32	1.47	
	2.6	4.1	8	1.49	2.6	4.0	36	1.38	
	2.8	5.3	12	1.25	2.7	4.5	40	1.30	
60	2.9	6.7	16	1.09	2.7	4.5	40	1.30	
	3.0	8.4	20	.98	2.5	2.7	28	1.70	
	3.0	10.4	24	.89	2.5	3.1	32	1.58	
65	2.7	3.7	8	1.57	2.6	3.4	36	1.49	
	2.8	4.7	12	1.33	2.6	3.8	40	1.40	
	2.8	6.0	16	1.16	2.7	4.3	44	1.33	
70	2.9	7.3	20	1.03	2.4	2.7	32	1.72	
	3.1	9.0	24	.94	2.4	3.0	36	1.60	
	2.6	3.1	8	1.73	2.5	3.4	40	1.51	
75	2.7	3.9	12	1.47	2.6	3.7	44	1.43	
	2.7	4.8	16	1.28	2.5	2.7	36	1.70	
	2.9	5.9	20	1.15	2.5	2.9	40	1.60	
80	2.9	7.3	24	1.05	2.5	3.3	44	1.52	
	3.0	8.6	28	.97	2.6	3.6	48	1.45	
	2.5	2.8	8	1.88	2.4	2.6	40	1.70	
85	2.6	3.3	12	1.60	2.5	2.9	44	1.61	
	2.6	4.1	16	1.40	2.5	3.2	48	1.53	
	2.7	5.0	20	1.26	2.5	2.6	44	1.70	
90	2.8	6.1	24	1.15	2.5	2.9	48	1.62	
	2.9	7.0	28	1.05	2.6	3.2	52	1.54	
	2.5	2.9	12	1.72	2.4	2.6	48	1.70	
95	2.6	3.6	16	1.51	2.5	2.9	52	1.62	
	2.7	4.3	20	1.35	2.4	2.6	52	1.70	
					2.5	2.6	56	1.69	

Figure 5.21
Design Table for Vegetated Earth Spillways in
Very Erodible Soils, K = 0.36 - 0.80, Side Slopes = 3:1
 (USDA - NRCS)

Discharge Q CFS	Slope Range		Bottom Width Feet	Stage Feet
	Minimum Percent	Maximum Percent		
10	3.5	4.7	8	.68
15	3.4	4.4	12	.69
	3.4	5.9	16	.80
20	3.3	3.3	12	.80
	3.3	4.1	16	.70
	3.5	5.3	20	.62
25	3.3	3.3	16	.79
	3.3	4.0	20	.70
	3.5	4.9	24	.64
30	3.3	3.3	20	.78
	3.3	4.0	24	.71
	3.4	4.7	28	.65
	3.4	5.5	32	.61
35	3.2	3.2	24	.77
	3.3	3.9	28	.71
	3.5	4.6	32	.66
	3.5	5.2	36	.62
40	3.3	3.3	28	.76
	3.4	3.8	32	.71
	3.4	4.4	36	.67
	3.4	5.0	40	.64
45	3.3	3.3	32	.76
	3.4	3.8	36	.71
	3.4	4.3	40	.67
	3.4	4.8	44	.64
50	3.3	3.3	36	.75
	3.3	3.8	40	.71
	3.3	4.3	44	.68
60	3.2	3.2	44	.75
	3.2	3.7	48	.72
70	3.3	3.3	52	.75
80	3.1	3.1	56	.78

Procedure for Determining or Altering Sediment Basin Shape

As specified in the Standard and Specification, the pool area at the elevation of the crest of the principal spillway shall have a length to width ratio of at least 2.0 to 1. The purpose of this requirement is to minimize the “short circuiting” effect of the sediment laden inflow to the riser and thereby increase the effectiveness of the sediment basin. The purpose of this procedure is to prescribe the parameters, procedures, and methods of determining and modifying the shape of the basin.

The length of the flow path (L) is the distance from the point of inflow to the riser (outflow point). The point of inflow is the point that the stream enters the normal pool (pool level at the riser crest elevation). The pool area (A) is the area of the normal pool. The effective width (W_e) is found by the equation:

$$W_e = A/L \text{ and } L:W \text{ ratio} = L/W_e$$

In the event there is more than one inflow point, any inflow point that conveys more than 30 percent of the total peak inflow rate shall meet the length to width ratio criteria.

The required basin shape may be obtained by proper site selection, by excavation, or by constructing a baffle in the basin. The purpose of the baffle is to increase the effective flow length from the inflow point to the riser. Baffles (see Figure 5.22 on following page) shall be placed midway between the inflow point around the end of the baffle to the outflow point. Then:

$$W_e = A/L_e \text{ and } L:W \text{ ratio} = L_e/W_e$$

Three examples are shown on the following page. Note that for the special case in example C the water is allowed to go around both ends of the baffle and the effective length, $L_e = L_1 + L_2$. Otherwise, the length to width ratio computations are the same as shown above. This special case procedure for computing L_e is allowable only when the two flow paths are equal, i.e., when $L_1 = L_2$. A baffle detail is also shown in Figure 5.22 on page 5.41.

Figure 5.22 Sediment Basin Baffle Details (USDA - NRCS)

Examples: Plan Views - not to scale

A.

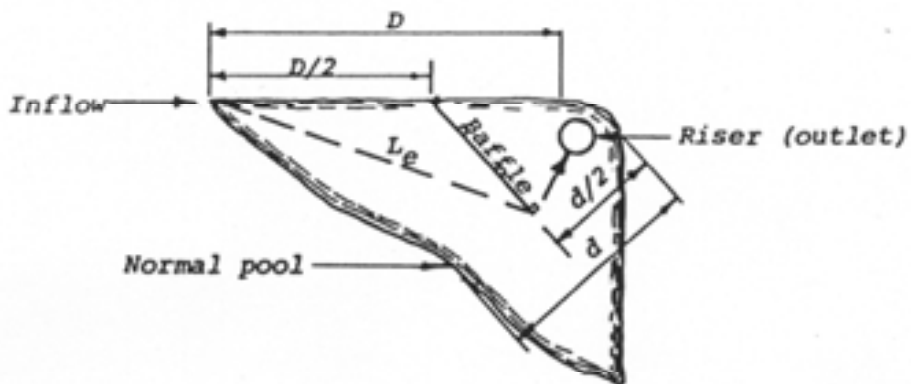

L_e = Total distance from the point of inflow around the baffle to the riser.

B.

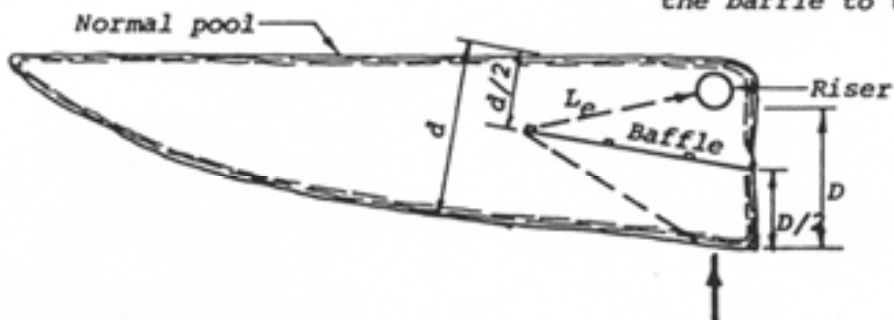

C.

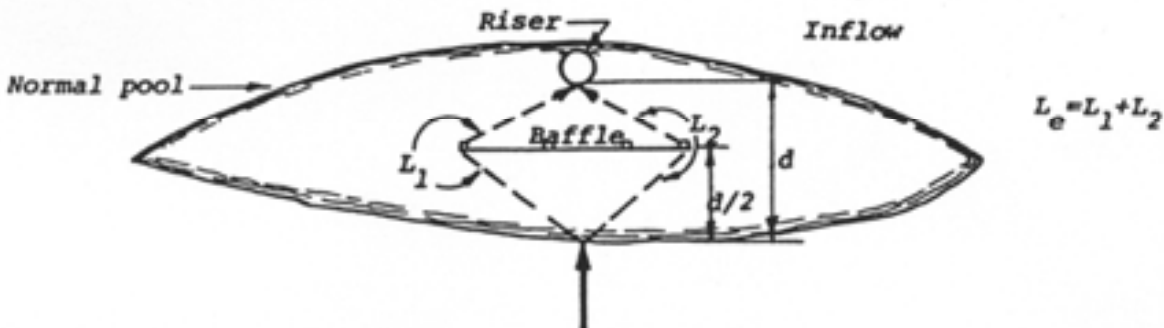

Baffle Detail

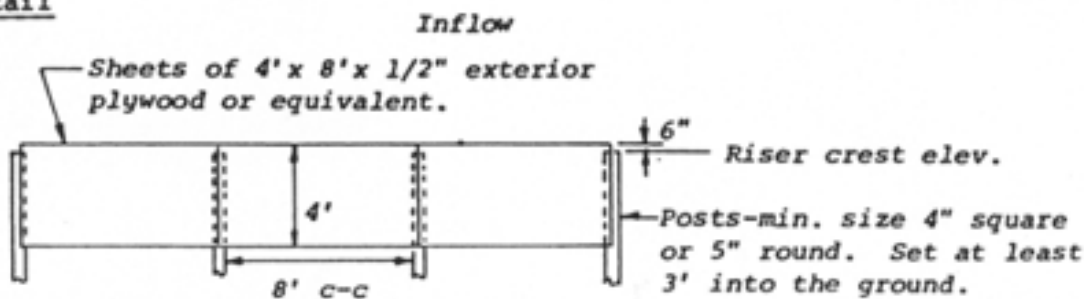

STANDARD AND SPECIFICATIONS FOR SEDIMENT DIKE



Definition & Scope

A **temporary** earth dike with an excavated trench on the upslope toe placed across a slope to capture sediment laden flow from small disturbed drainage areas and allowing sediment to settle out by ponding.

Condition Where Practice Applies

This practice can be used on slopes and in areas where it is difficult to place and maintain silt fence. This practice acts as a smaller sediment trap for linear type applications. This practice will handle sheet and rill erosion for small tributary areas.

Design Criteria

1. The earth dike will be a maximum of 2 feet high with a 2 foot top width and 2:1 side slopes.
2. All earth fill will be placed on a stripped foundation, contain no stumps or woody material, and be compacted with the weight of the excavator bucket.
3. The interior capture trench will be a minimum 1.5 feet deep, 2 feet wide, with 1:1 side slopes and with a near level bottom. In areas where linear slopes exceed 4% the sediment dike system shall be segmented to maintain capture volume and ponding.
4. The system shall be used with a minimum 5 foot vegetated buffer on the down slope toe of the dike or an artificial buffer of erosion control matting.
5. The maximum ponding depth behind the dike shall be 1/2 the height of the constructed dike at its lowest elevation.

6. The ends of the dike system shall terminate with a 90° return of NYS DOT #1A crushed stone to filter any excess flow.
7. The maximum drainage area tributary to this practice shall not exceed 0.5 acres per 100 feet of dike, for slopes less than 10%. For slopes greater than 10%, the drainage area shall be 0.25 acres per 100 feet of dike.
8. The earthen dike shall be seeded and mulched to prevent erosion using an annual rye grass mixture at a rate of 1 lb. per 1,000 square feet.

Maintenance

1. No traffic will be allowed on the dike.
2. Dike system will be inspected weekly and after each runoff event.
3. Sediment in the system will be removed when the interior trench has filled to 75% capacity.
4. Sediment will be disposed of on-site as specified in the Erosion and Sediment Control Plan.
5. Upon stabilization of the tributary drainage area, the trench will be filled, excess dike fill removed, and the area graded and stabilized in accordance with the Erosion and Sediment Control Plan.

**Figure 5.23
Sediment Dike**

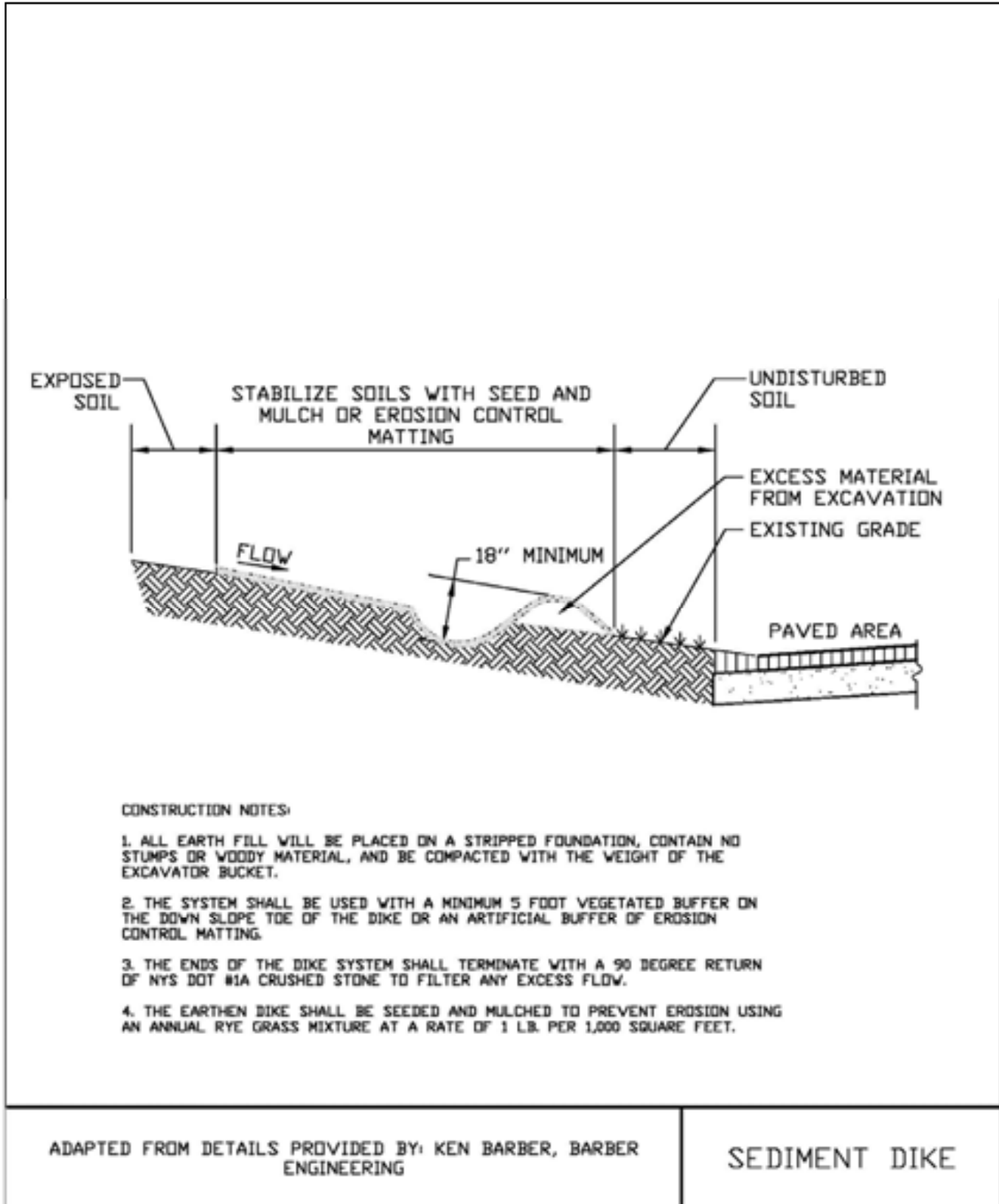

STANDARD AND SPECIFICATIONS FOR SEDIMENT TANK - PORTABLE



Definition & Scope

A sediment tank is a compartmented tank or vessel container to which sediment laden water is pumped to trap and retain the sediment prior to releasing the water to drainage-ways, and rights-of-way below the sediment tank site.

Conditions Where Practice Applies

A sediment tank is to be used on sites where excavations are deep, and space is limited, such as urban construction, where direct discharge of sediment laden water to stream and storm drainage systems is to be avoided.

Design Criteria

Location

The sediment tank shall be located for ease of clean-out and disposal of the trapped sediment, and to minimize the interference with construction activities and pedestrian traffic.

Tank Size

The following formula should be used in determining the storage volume of the sediment tank; pump discharge (G.P.M.) x 16 = Cubic Foot Storage.

An example of a typical sediment tank is shown on Figure 5.24 on page 5.45. Other container designs can be used if the storage volume is adequate and approval is obtained from the local approving agency. Commercially manufactured tanks are also available.

**Figure 5.24
Portable Sediment Tank**

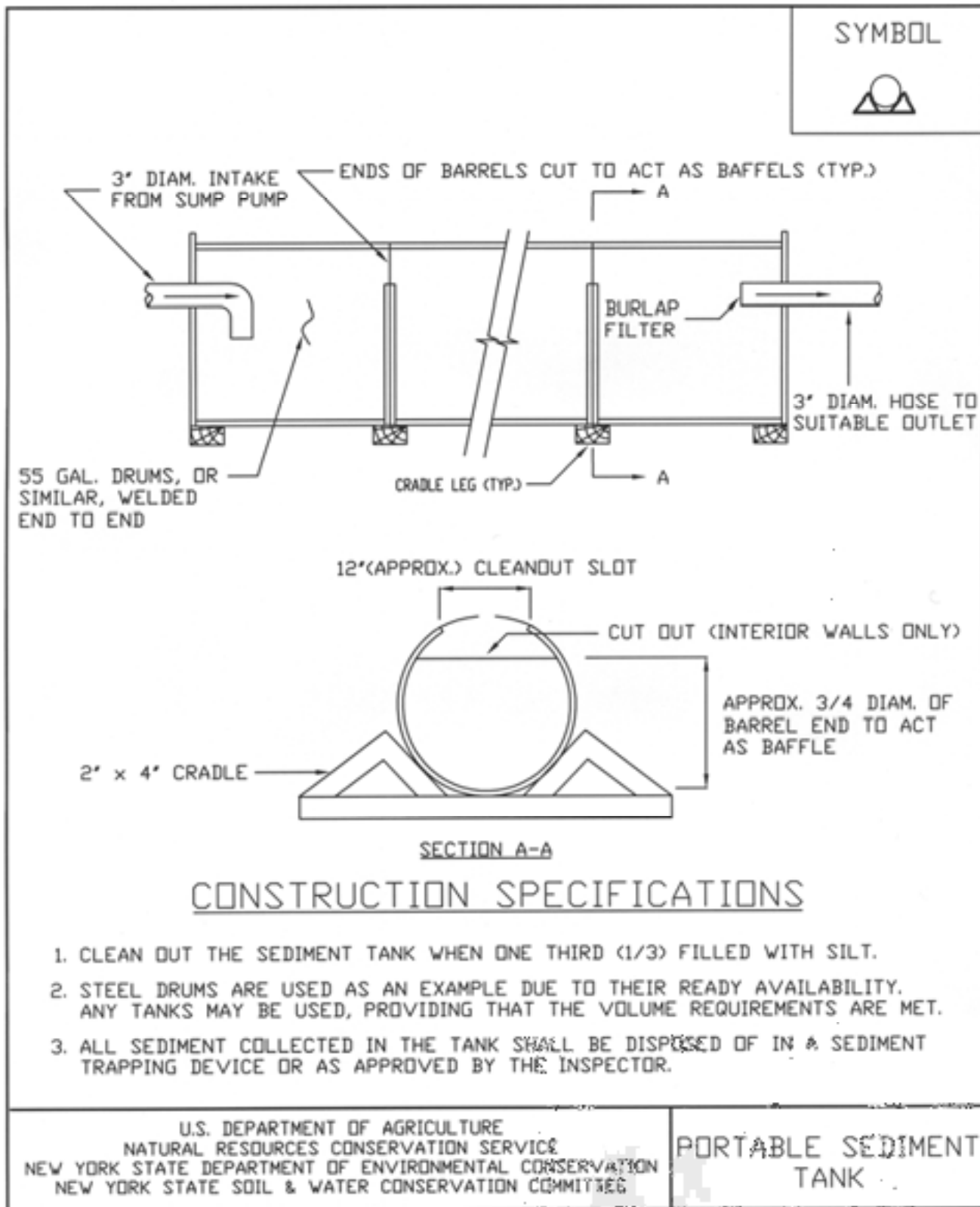

STANDARD AND SPECIFICATIONS FOR SEDIMENT TRAP



Definition & Scope

A **temporary** sediment control device formed by excavation and/or embankment to intercept sediment-laden runoff and trap the sediment in order to protect drainageways, properties, and rights-of-way below the sediment trap from sedimentation.

Conditions Where Practice Applies

A sediment trap is usually installed in a drainageway, at a storm drain inlet, or other points of collection from a disturbed area for one construction season.

Sediment traps should be used to artificially break up the natural drainage area into smaller sections where a larger device (sediment basin) would be less effective.

Design Criteria

If the drainage area to the proposed trap location exceeds 5 acres, or the trap is in place beyond one construction season, or any of the additional design criteria presented here cannot be met, a full Sediment Basin must be used. See Standard and Specification for Sediment Basin on page 5.19.

Drainage Area

The maximum drainage area for all sediment traps shall be 5 acres.

Location

Sediment traps shall be located so that they can be installed prior to grading or filling in the drainage area they are to protect. Traps must **not be located any closer than 20 feet** from a proposed building foundation if the trap is to func-

tion during building construction. Locate traps to obtain maximum storage benefit from the terrain and for ease of cleanout and disposal of the trapped sediment.

Trap Size

The volume of a sediment trap as measured at the elevation of the crest of the outlet shall be at least 3,600 cubic feet per acre of drainage area. A minimum length to width ratio of 2:1 should be provided. The volume of a constructed trap shall be calculated using standard mathematical procedures. The volume of a natural sediment trap may be approximated by the equation: Volume (cu.ft.) = 0.4 x surface area (sq.ft.) x maximum depth (ft.).

Trap Cleanout

Sediment shall be removed and the trap restored to the original dimensions when the sediment has accumulated to $\frac{1}{2}$ of the design depth of traps I-II, and $\frac{1}{3}$ the depth for trap III. Sediment removed from the trap shall be deposited in a protected area and in such a manner that it will not erode.

Embankment

All earth embankments for sediment traps shall not exceed five (5) feet in height as measured at the low point of the original ground along the centerline of the embankment. Embankments shall have a minimum four (4) foot wide top and side slopes of 2:1 or flatter. The embankment shall be compacted by traversing with equipment while it is being constructed. The embankment shall be stabilized with seed and mulch as soon as it is completed

The elevation of the top of any dike directing water to any sediment trap will equal or exceed the maximum height of the outlet structure along the entire length of the trap.

Excavation

All excavation operations shall be carried out in such a manner that erosion and water pollution shall be minimal. Excavated portions of sediment traps shall have 1:1 or flatter slopes.

Outlet

The outlet shall be designed, constructed, and maintained in such a manner that sediment does not leave the trap and that erosion at or below the outlet does not occur.

Sediment traps must outlet onto stabilized (preferable undisturbed) ground, into a watercourse, stabilized channel, or into a storm drain system. Distance between inlet and outlet should be maximized to the longest length practicable.

All traps must be seeded and mulched immediately after construction.

Trap Details Needed on Erosion and Sediment Control Plans

Each trap shall be delineated on the plans in such a manner that it will not be confused with any other features. Each trap on a plan shall indicate all the information necessary to properly construct and maintain the structure. If the drawings are such that this information cannot be delineated on the drawings, then a table shall be developed. If a table is developed, then each trap on a plan shall have a number and the numbers shall be consecutive.

The following information shall be shown for each trap in a summary table format on the plans.

1. Trap number
2. Type of trap
3. Drainage area
4. Storage required
5. Storage provided (if applicable)
6. Outlet length or pipe sizes
7. Storage depth below outlet or cleanout elevation
8. Embankment height and elevation (if applicable)

Type of Sediment Traps

There are three (3) specific types of sediment traps which vary according to their function, location, or drainage area.

- I. Pipe Outlet Sediment Trap
- II. Stone Outlet Sediment Trap
- III. Compost Filter Sock Sediment Trap

I. Pipe Outlet Sediment Trap

A Pipe Outlet Sediment Trap consists of a trap formed by embankment or excavation. The outlet for the trap is through a perforated riser and a pipe through the embankment. The outlet pipe and riser shall be made of steel, corrugated metal or other suitable material. The top of the embankment shall be at least 1 ½ feet above the crest of the riser. The preferred method of dewatering the sediment trap is by surface skimmer. See Dewatering Device Standard, page 5.10. If the riser alone is used for dewatering, the top 2/3 of the riser shall be perforated with one (1) inch nominal diameter holes or slits spaced six (6) inches vertically and horizontally placed in the concave portion of the corrugated pipe.

No holes or slits will be allowed within six (6) inches of the top of the horizontal barrel. All pipe connections shall be watertight. The riser shall be wrapped with ½ to ¼ inch hardware cloth wire then wrapped with filter cloth with a sieve size between #40-80 and secured with strapping or connecting band at the top and bottom of the cloth. The

cloth shall cover an area at least six (6) inches above the highest hole and six (6) inches below the lowest hole. The top of the riser pipe shall not be covered with filter cloth. The riser shall have a base with sufficient weight to prevent flotation of the riser. Two approved bases are:

1. A concrete base 12 in. thick with the riser embedded 9 in. into the concrete base, or
2. One quarter inch, minimum, thick steel plate attached to the riser by a continuous weld around the circumference of the riser to form a watertight connection. The plate shall have 2.5 feet of stone, gravel, or earth placed on it to prevent flotation. In either case, each side of the square base measurement shall be the riser diameter plus 24 inches.

Pipe outlet sediment traps shall be limited to a five (5) acre maximum drainage area. Pipe outlet sediment trap is interchangeable in the field with stone outlet provided that these sediment traps are constructed in accordance with the detail and specifications for that trap.

Select pipe diameter from the following table:
See details for Pipe Outlet Sediment Trap ST-I in Figure 5.25 and 5.26 on pages 5.49 and 5.50.

Optional sediment trap dewatering devices are shown on Figure 5.29 on Page 5.53.

Minimum Sizes

Barrel Diameter¹ (in.)	Riser Diameter¹ (in.)	Maximum Drainage Area (ac.)
12	15	1
15	18	2
18	21	3
21	24	4
21	27	5
¹ Barrel diameter may be same size as riser diameter		



II. Stone Outlet Sediment Trap

A Stone Outlet Sediment Trap consists of a trap formed by an embankment or excavation. The outlet of this trap is over a stone section placed on level ground. The minimum length (feet) of the outlet shall be equal to four (4) times the drainage area (acres).

Required storage shall be 3,600 cubic feet per acre of drainage area.

The outlet crest (top of stone in weir section) shall be level, at least one (1) foot below top of embankment and no more than one (1) foot above ground beneath the outlet. Stone used in the outlet shall be small riprap (4 in. x 8 in.). To provide more efficient trapping effect, a layer of filter cloth should be embedded one (1) foot back into the upstream face of the outlet stone or a one (1) foot thick layer of two (2) inch or finer aggregate shall be placed on the upstream face of the outlet.

Stone Outlet Sediment Traps may be interchangeable in the field with pipe outlet sediment traps provided they are constructed in accordance with the detail and specifications for those traps. Stone outlet sediment traps shall be limited to a five (5) acre maximum drainage area.

See details for Stone Outlet Sediment Trap ST-II in Figure 5.27 on page 5.51



III. Compost Sock Sediment Trap

A compost sock sediment trap consists of a trap formed by creating an enclosure of geotextile mesh tubes filled with a compost filter media. These traps are used in locations where there is no opportunity to direct runoff into larger traps or well vegetated areas. This could occur at site entrances and access points or in tight areas due to construction boundary limits.

Surface runoff can be directed to the trap with standard conveyance practices. Groundwater or surface ponding in low areas can be pumped into the compost sock sediment trap with appropriate energy dissipation at the pump outlet to prevent scour.

Design criteria for Compost Sock Sediment Trap

1. The maximum drainage area tributary to the trap shall be 5 acres.
2. The minimum settled height above ground shall be 2.0 feet formed by staking 3 compost filter socks in a pyramid as shown in Figure 5.28 on page 5.52.
3. The storage volume provided in the compost sock sediment trap shall be 3,600 cubic feet per tributary drainage acre.
4. If necessary, additional storage area can be created by excavating a sump 1 foot deep beginning at least 5 feet away from the inside sock.
5. All compost filter sock materials, mesh, and compost, will meet the material specifications listed in the Compost Filter Sock standard. No spillway is required.
6. Compost filter sock sediment traps shall be inspected weekly and after every rainfall event. Sediment shall be removed when it reaches one third, 1/3, the height of the trap.
7. The maximum limit of use for a compost sock sediment trap is one (1) year. The existing trap shall be replaced if there is a need for a trap beyond that time limit.
8. Upon completion of the work, the compost sock sediment trap shall be removed. The compost within the socks may be used during cleanup as a vegetative growth medium in accordance with the site stabilization plan.



**Figure 5.25
Pipe Outlet Sediment Trap: ST-I**

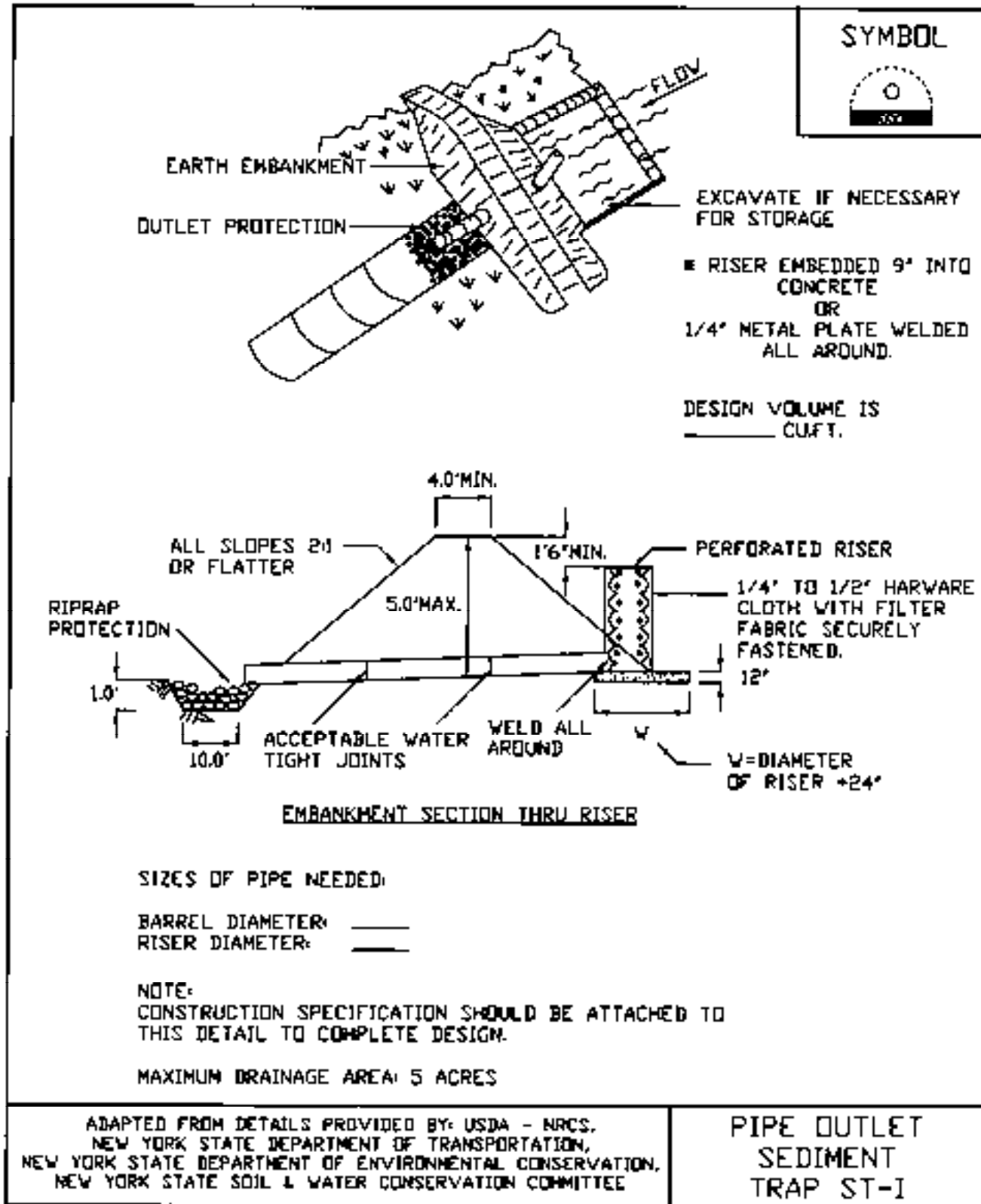

**Figure 5.26
Pipe Outlet Sediment Trap: ST-I - Construction Specifications**

<h2 style="margin: 0;">CONSTRUCTION SPECIFICATIONS</h2>	<p>SYMBOL</p> 
<ol style="list-style-type: none"> 1. AREA UNDER EMBANKMENT SHALL BE CLEARED, GRUBBED AND STRIPPED OF ANY VEGETATION AND ROOT MAT. THE POOL AREA SHALL BE CLEARED. 2. THE FILL MATERIAL FOR THE EMBANKMENT SHALL BE FREE OF ROOTS OR OTHER WOODY VEGETATION AS WELL AS OVER-SIZED STONES, ROCKS, ORGANIC MATERIAL, OR OTHER OBJECTIONABLE MATERIAL. THE EMBANKMENT SHALL BE COMPACTED BY TRAVERSING WITH EQUIPMENT WHILE IT IS BEING CONSTRUCTED. 3. VOLUME OF SEDIMENT STORAGE SHALL BE 3600 CUBIC FEET PER ACRE OF CONTRIBUTORY DRAINAGE. 4. SEDIMENT SHALL BE REMOVED AND TRAP RESTORED TO ITS ORIGINAL DIMENSIONS WHEN THE SEDIMENT HAS ACCUMULATED TO 1/2 THE DESIGN DEPTH OF THE TRAP. REMOVED SEDIMENT SHALL BE DEPOSITED IN A SUITABLE AREA AND STABILIZED. 5. THE STRUCTURE SHALL BE INSPECTED AFTER EACH RAIN AND REPAIRS MADE AS NEEDED. 6. CONSTRUCTION OPERATIONS SHALL BE CARRIED OUT IN SUCH A MANNER THAT EROSION AND SEDIMENT ARE CONTROLLED. 7. THE STRUCTURE SHALL BE REMOVED AND AREA STABILIZED WHEN THE DRAINAGE AREA HAS BEEN PROPERLY STABILIZED. 8. ALL FILL SLOPES SHALL BE 2:1 OR FLATTER; CUT SLOPES 1:1 OR FLATTER. 9. ALL PIPE CONNECTIONS SHALL BE WATERTIGHT. 10. THE TOP 2/3 OF THE RISER SHALL BE PERFORATED WITH ONE (1) INCH DIAMETER HOLES OR SLITS SPACED SIX (6) INCHES VERTICALLY AND HORIZONTALLY AND PLACED IN THE CONCAVE PORTION OF PIPE. NO HOLES WILL BE ALLOWED WITHIN SIX (6) INCHES OF THE HORIZONTAL BARREL. 11. THE RISER SHALL BE WRAPPED WITH 1/4 TO 1/2 INCH HARDWARE CLOTH WIRE THEN WRAPPED WITH FILTER CLOTH (HAVING AN EQUIVALENT SIEVE SIZE OF 40-80). THE FILTER CLOTH SHALL EXTEND SIX (6) INCHES ABOVE THE HIGHEST HOLE AND SIX (6) INCHES BELOW THE LOWEST HOLE. WHERE ENDS OF THE FILTER CLOTH COME TOGETHER, THEY SHALL BE OVER-LAPPED, FOLDED AND STAPLED TO PREVENT BYPASS. 12. STRAPS OR CONNECTING BANDS SHALL BE USED TO HOLD THE FILTER CLOTH AND WIRE FABRIC IN PLACE. THEY SHALL BE PLACED AT THE TOP AND BOTTOM OF THE CLOTH. 13. FILL MATERIAL AROUND THE PIPE SPILLWAY SHALL BE HAND COMPACTED IN FOUR (4) INCH LAYERS. A MINIMUM OF TWO (2) FEET OF HAND COMPACTED BACKFILL SHALL BE PLACED OVER THE PIPE SPILLWAY BEFORE CROSSING IT WITH CONSTRUCTION EQUIPMENT. 14. THE RISER SHALL BE ANCHORED WITH EITHER A CONCRETE BASE OR STEEL PLATE BASE TO PREVENT FLOTATION. FOR CONCRETE BASE THE DEPTH SHALL BE TWELVE (12) INCHES WITH THE RISER EMBEDDED NINE (9) INCHES. A 1/4 INCH MINIMUM THICKNESS STEEL PLATE SHALL BE ATTACHED TO THE RISER BY A CONTINUOUS WELD AROUND THE BOTTOM TO FORM A WATERTIGHT CONNECTION AND THEN PLACE TWO (2) FEET OF STONE, GRAVEL, OR TAMPED EARTH ON THE PLATE. 	
<p>ADAPTED FROM DETAILS PROVIDED BY: USDA - NRCS, NEW YORK STATE DEPARTMENT OF TRANSPORTATION, NEW YORK STATE DEPARTMENT OF ENVIRONMENTAL CONSERVATION, NEW YORK STATE SOIL & WATER CONSERVATION COMMITTEE</p>	<p>PIPE OUTLET SEDIMENT TRAP ST-I</p>

Figure 5.27
Stone Outlet Sediment Trap: ST-II

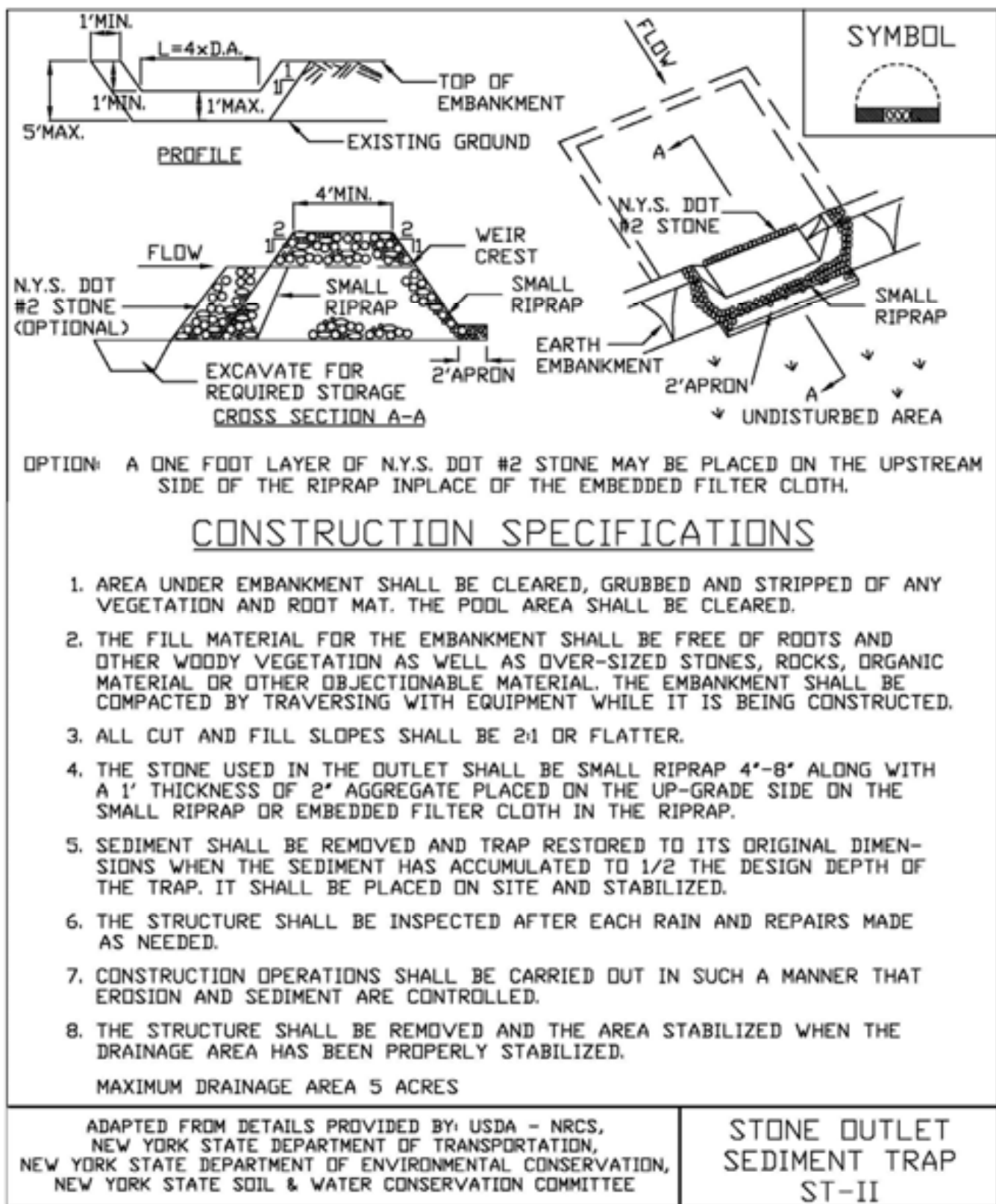
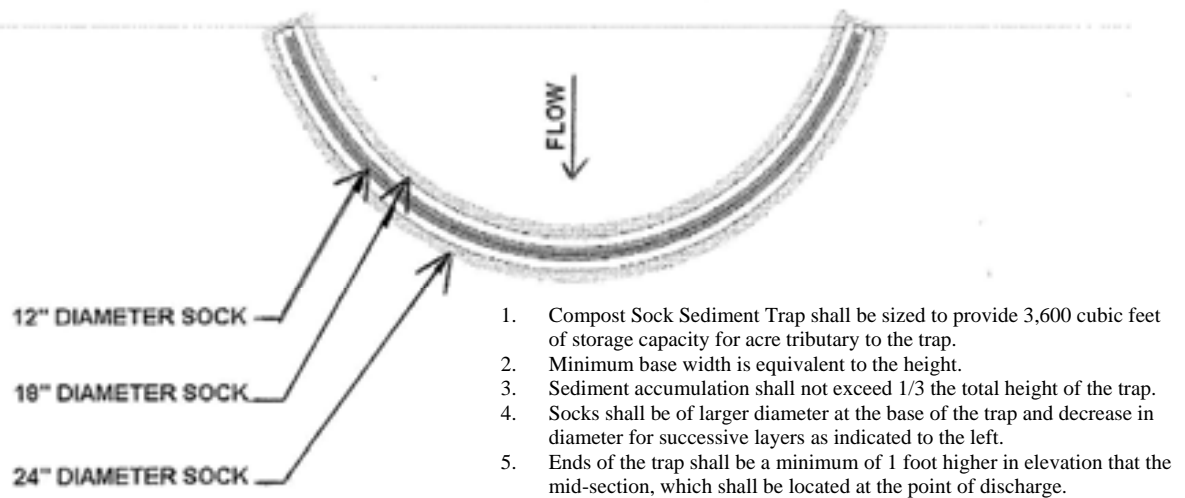
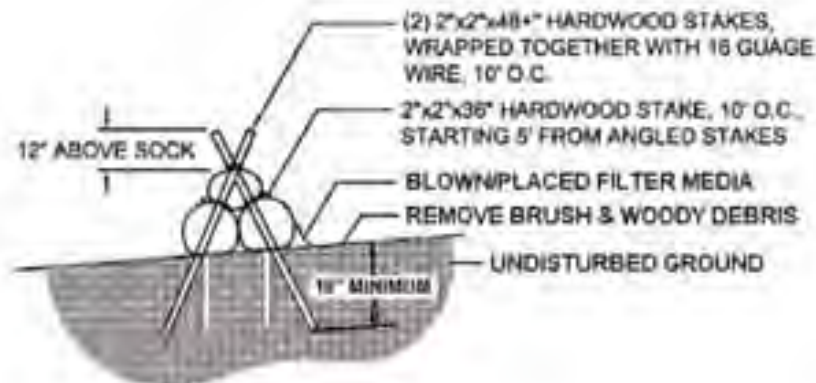

Figure 5.28 Compost Filter Sock Sediment Trap: ST-III

Plan View



Staking Detail



* Figures adapted from Filtrex

Specifications:

1. Sock infill and filter media material shall meet the standards of Table 5.1 on page 5.8 . Compost shall meet the compost filter sock standard of Table 5.2 on page 5.8.
2. Compost sock sediment traps shall not exceed three socks in height and shall be stacked in pyramidal form as shown above. Minimum trap height is one 24 inch diameter sock. Additional storage may be provided by means of an excavated sump 12 inches deep extending 1 to 3 feet upslope of the socks along the lower side of the trap.
3. Compost sock sediment traps shall provide 3,600 cubic feet storage capacity with 12 inches of freeboard for each tributary drainage acreage. (See manufacturer for anticipated settlement.)
4. The maximum tributary drainage area is 5.0 acres. Since compost socks are "flow-through," no spillway is required.
5. Compost sock sediment traps shall be inspected weekly and after each runoff event. Sediment shall be removed when it reaches 1/3 the height of the socks.
6. Photodegradable and biodegradable socks shall not be used for more than 1 year.

Figure 5.29
Optional Sediment Trap Dewatering Devices
for Traps with <5 Acres Drainage Area

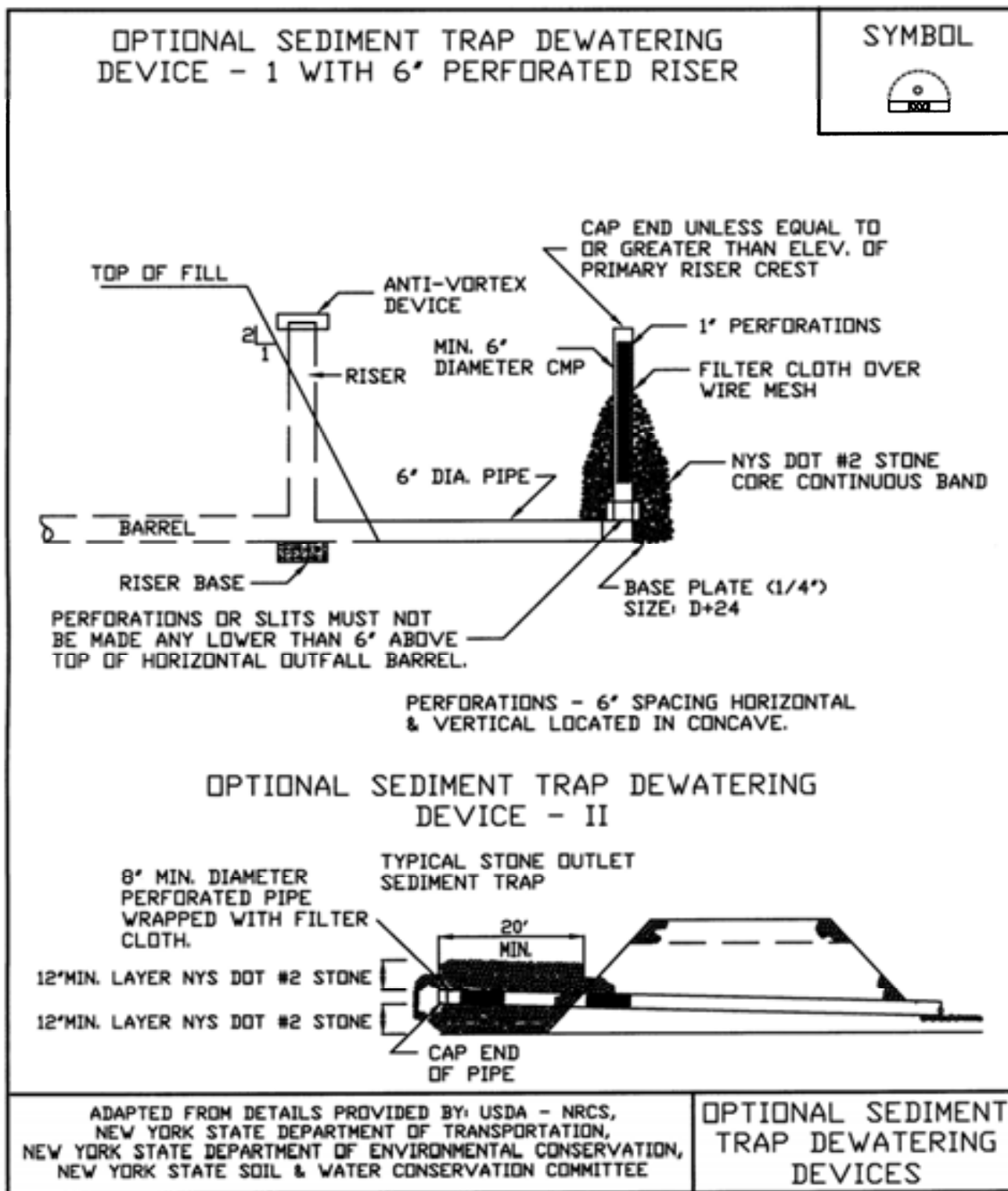

STANDARD AND SPECIFICATIONS FOR SILT FENCE



Definition & Scope

A **temporary** barrier of geotextile fabric installed on the contours across a slope used to intercept sediment laden runoff from small drainage areas of disturbed soil by temporarily ponding the sediment laden runoff allowing settling to occur. The maximum period of use is limited by the ultraviolet stability of the fabric (approximately one year).

Conditions Where Practice Applies

A silt fence may be used subject to the following conditions:

1. Maximum allowable slope length and fence length will not exceed the limits shown in the Design Criteria for the specific type of silt fence used ; and
2. Maximum ponding depth of 1.5 feet behind the fence; and
3. Erosion would occur in the form of sheet erosion; and
4. There is no concentration of water flowing to the barrier; and
5. Soil conditions allow for proper keying of fabric, or other anchorage, to prevent blowouts.

Design Criteria

1. Design computations are not required for installations of 1 month or less. Longer installation periods should be designed for expected runoff.
2. All silt fences shall be placed as close to the disturbed area as possible, but at least 10 feet from the toe of a slope steeper than 3H:1V, to allow for maintenance and

roll down. The area beyond the fence must be undisturbed or stabilized.

3. The type of silt fence specified for each location on the plan shall not exceed the maximum slope length and maximum fence length requirements shown in the following table:

		Slope Length/Fence Length (ft.)		
Slope	Steepness	Standard	Reinforced	Super
<2%	< 50:1	300/1500	N/A	N/A
2-10%	50:1 to 10:1	125/1000	250/2000	300/2500
10-20%	10:1 to 5:1	100/750	150/1000	200/1000
20-33%	5:1 to 3:1	60/500	80/750	100/1000
33-50%	3:1 to 2:1	40/250	70/350	100/500
>50%	> 2:1	20/125	30/175	50/250

Standard Silt Fence (SF) is fabric rolls stapled to wooden stakes driven 16 inches in the ground.
Reinforced Silt Fence (RSF) is fabric placed against welded wire fabric with anchored steel posts driven 16 inches in the ground.
Super Silt Fence (SSF) is fabric placed against chain link fence as support backing with posts driven 3 feet in the ground.

4. Silt fence shall be removed as soon as the disturbed area has achieved final stabilization.

The silt fence shall be installed in accordance with the appropriate details. Where ends of filter cloth come together, they shall be overlapped, folded and stapled to prevent sediment bypass. Butt joints are not acceptable. A detail of the silt fence shall be shown on the plan. See Figure 5.30 on page 5.56 for Reinforced Silt Fence as an example of details to be provided.

Criteria for Silt Fence Materials

1. Silt Fence Fabric: The fabric shall meet the following specifications unless otherwise approved by the appropriate erosion and sediment control plan approval authority. Such approval shall not constitute statewide acceptance.

Fabric Properties	Minimum Acceptable Value	Test Method
Grab Tensile Strength (lbs)	110	ASTM D 4632
Elongation at Failure (%)	20	ASTM D 4632
Mullen Burst Strength (PSI)	300	ASTM D 3786
Puncture Strength (lbs)	60	ASTM D 4833
Minimum Trapezoidal Tear Strength (lbs)	50	ASTM D 4533
Flow Through Rate (gal/min/sf)	25	ASTM D 4491
Equivalent Opening Size	40-80	US Std Sieve ASTM D 4751
Minimum UV Residual (%)	70	ASTM D 4355

Super Silt Fence



2. Fence Posts (for fabricated units): The length shall be a minimum of 36 inches long. Wood posts will be of sound quality hardwood with a minimum cross sectional area of 3.5 square inches. Steel posts will be standard T and U section weighing not less than 1.00 pound per linear foot. Posts for super silt fence shall be standard chain link fence posts.
3. Wire Fence for reinforced silt fence: Wire fencing shall be a minimum 14 gage with a maximum 6 in. mesh opening, or as approved.
4. Prefabricated silt fence is acceptable as long as all material specifications are met.

Reinforced Silt Fence



**Figure 5.30
Reinforced Silt Fence**

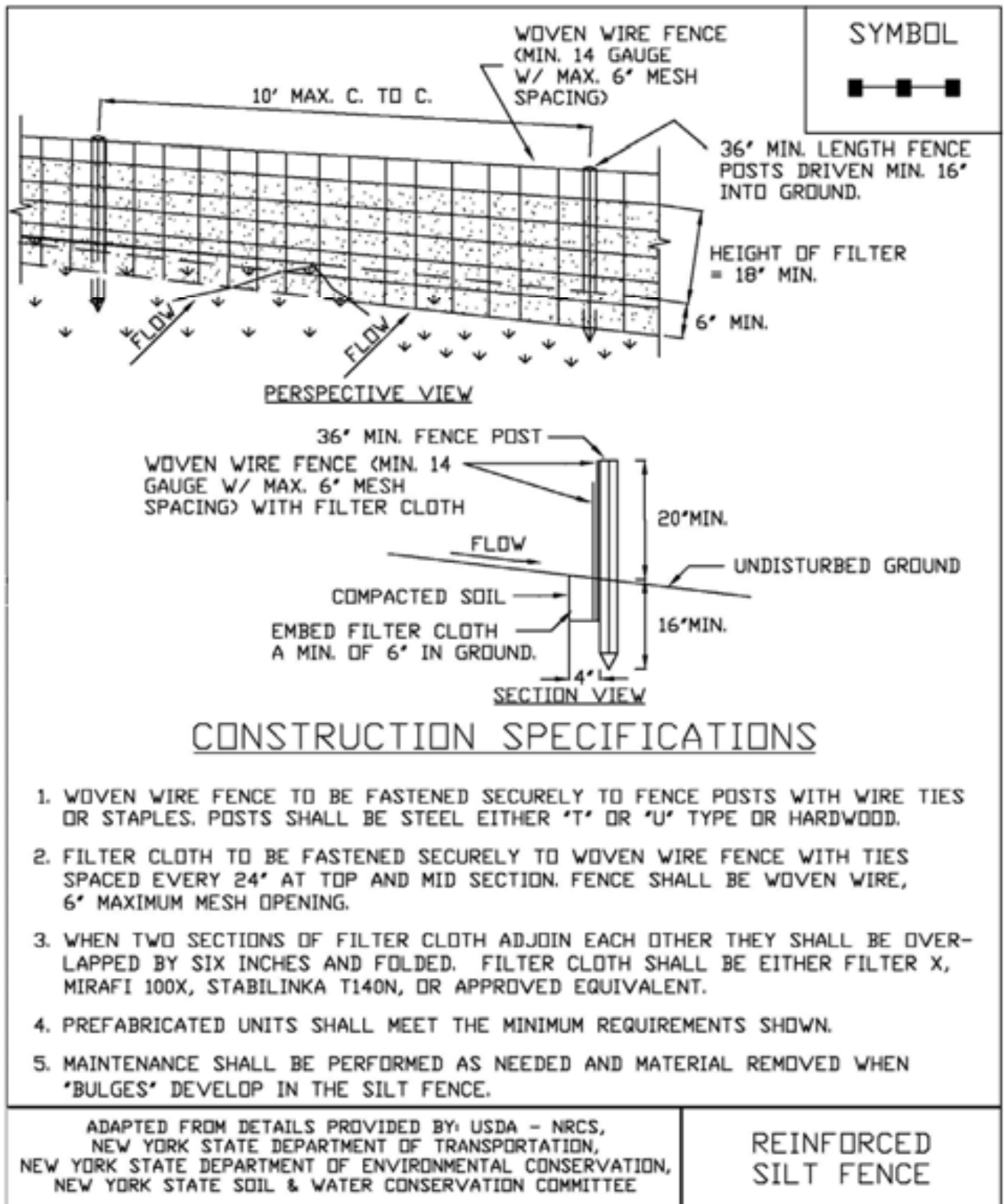

STANDARD AND SPECIFICATIONS FOR STORM DRAIN INLET PROTECTION



Definition & Scope

A **temporary** barrier with low permeability, installed around inlets in the form of a fence, berm or excavation around an opening, detaining water and thereby reducing the sediment content of sediment laden water by settling thus preventing heavily sediment laden water from entering a storm drain system.

Conditions Where Practice Applies

This practice shall be used where the drainage area to an inlet is disturbed, it is not possible to temporarily divert the storm drain outfall into a trapping device, and watertight blocking of inlets is not advisable. **It is not to be used in place of sediment trapping devices.** This practice shall be used with an upstream buffer strip if placed at a storm drain inlet on a paved surface. It may be used in conjunction with storm drain diversion to help prevent siltation of pipes installed with low slope angle.

Types of Storm Drain Inlet Practices

There are five (5) specific types of storm drain inlet protection practices that vary according to their function, location, drainage area, and availability of materials:

- I. Excavated Drop Inlet Protection
- II. Fabric Drop Inlet Protection
- III. Stone & Block Drop Inlet Protection
- IV. Paved Surface Inlet Protection
- V. Manufactured Insert Inlet Protection

Design Criteria

Drainage Area – The drainage area for storm drain inlets shall not exceed one acre. Erosion control/temporary stabilization measures must be implemented on the disturbed

drainage area tributary to the inlet. The crest elevations of these practices shall provide storage and minimize bypass flow.

Type I – Excavated Drop Inlet Protection

This practice is generally used during initial overlot grading after the storm drain trunk line is installed.

Limit the drainage area to the inlet device to 1 acre. Excavated side slopes shall be no steeper than 2:1. The minimum depth shall be 1 foot and the maximum depth 2 feet as measured from the crest of the inlet structure. Shape the excavated basin to fit conditions with the longest dimension oriented toward the longest inflow area to provide maximum trap efficiency. The capacity of the excavated basin should be established to contain 900 cubic feet per acre of disturbed area. Weep holes, protected by fabric and stone, should be provided for draining the temporary pool.

Inspect and clean the excavated basin after every storm. Sediment should be removed when 50 percent of the storage volume is achieved. This material should be incorporated into the site in a stabilized manner.

Type II – Fabric Drop Inlet Protection



This practice is generally used during final elevation grading phases after the storm drain system is completed.

Limit the drainage area to 1 acre per inlet device. Land area slope immediately surrounding this device should not exceed 1 percent. The maximum height of the fabric above the inlet crest shall not exceed 1.5 feet unless reinforced.

The top of the barrier should be maintained to allow overflow to drop into the drop inlet and not bypass the inlet to

unprotected lower areas. Support stakes for fabric shall be a minimum of 3 feet long, spaced a maximum 3 feet apart. They should be driven close to the inlet so any overflow drops into the inlet and not on the unprotected soil. Improved performance and sediment storage volume can be obtained by excavating the area.

Inspect the fabric barrier after each rain event and make repairs as needed. Remove sediment from the pool area as necessary with care not to undercut or damage the filter fabric. Upon stabilization of the drainage area, remove all materials and unstable sediment and dispose of properly. Bring the adjacent area of the drop inlet to grade, smooth and compact and stabilize in the appropriate manner to the site.

Type III – Stone and Block Drop Inlet Protection

This practice is generally used during the initial and intermediate overlot grading of a construction site.

Limit the drainage area to 1 acre at the drop inlet. The stone barrier should have a minimum height of 1 foot and a maximum height of 2 feet. Do not use mortar. The height should be limited to prevent excess ponding and bypass flow.

Recess the first course of blocks at least 2 inches below the crest opening of the storm drain for lateral support. Subsequent courses can be supported laterally if needed by placing a 2x4 inch wood stud through the block openings perpendicular to the course. The bottom row should have a few blocks oriented so flow can drain through the block to dewater the basin area.

The stone should be placed just below the top of the blocks on slopes of 2:1 or flatter. Place hardware cloth of wire mesh with ½ inch openings over all block openings to hold stone in place.

As an optional design, the concrete blocks may be omitted and the entire structure constructed of stone, ringing the outlet (“doughnut”). The stone should be kept at a 3:1 slope toward the inlet to keep it from being washed into the inlet. A level area 1 foot wide and four inches below the crest will further prevent wash. Stone on the slope toward the inlet should be at least 3 inches in size for stability and 1 inch or smaller away from the inlet to control flow rate. The elevation of the top of the stone crest must be maintained 6 inches lower than the ground elevation down slope from the inlet to ensure that all storm flows pass over the stone into the storm drain and not past the structure. Temporary diking should be used as necessary to prevent bypass flow.

The barrier should be inspected after each rain event and repairs made where needed. Remove sediment as necessary to provide for accurate storage volume for subsequent rains. Upon stabilization of contributing drainage area, remove all

materials and any unstable soil and dispose of properly.

Bring the disturbed area to proper grade, smooth, compact and stabilize in a manner appropriate to the site.

Type IV – Paved Surface Inlet Protection



This practice is generally used after pavement construction has been done while final grading and soil stabilization is occurring. These practices should be used with upstream buffer strips in linear construction applications, and with temporary surface stabilization for overlot areas, to reduce the sediment load at the practice. This practice includes sand bags, compost filter socks, geo-tubes filled with ballast, and manufactured surface barriers. Pea gravel can also be used in conjunction with these practices to improve performance. When the inlet is not at a low point, and is offset from the pavement or gutter line, protection should be selected and installed so that flows are not diverted around the inlet.



The drainage area should be limited to 1 acre at the drain inlet. All practices will be placed at the inlet perimeter or beyond to maximize the flow capacity of the inlet. Practices shall be weighted, braced, tied, or otherwise anchored to prevent movement or shifting of location on paved surfaces. Traffic safety shall be integrated with the use of this practice. All practices should be marked with traffic safety cones as appropriate. Structure height shall not cause flooding or by-pass flow that would cause additional erosion.

The structure should be inspected after every storm event. Any sediment should be removed and disposed of on the site. Any broken or damaged components should be replaced. Check all materials for proper anchorage and secure as necessary.

Type V - Manufactured Insert Inlet Protection



The drainage area shall be limited to 1 acre at the drain inlet. All inserts will be installed and anchored in accordance with the manufacturers recommendations and design details. The fabric portion of the structure will equal or exceed the performance standard for the silt fence fabric. The inserts will be installed to preserve a minimum of 50 percent of the open, unobstructed design flow area of the storm drain inlet opening to maintain capacity for storm events.

**Figure 5.31
Excavated Drop Inlet Protection**

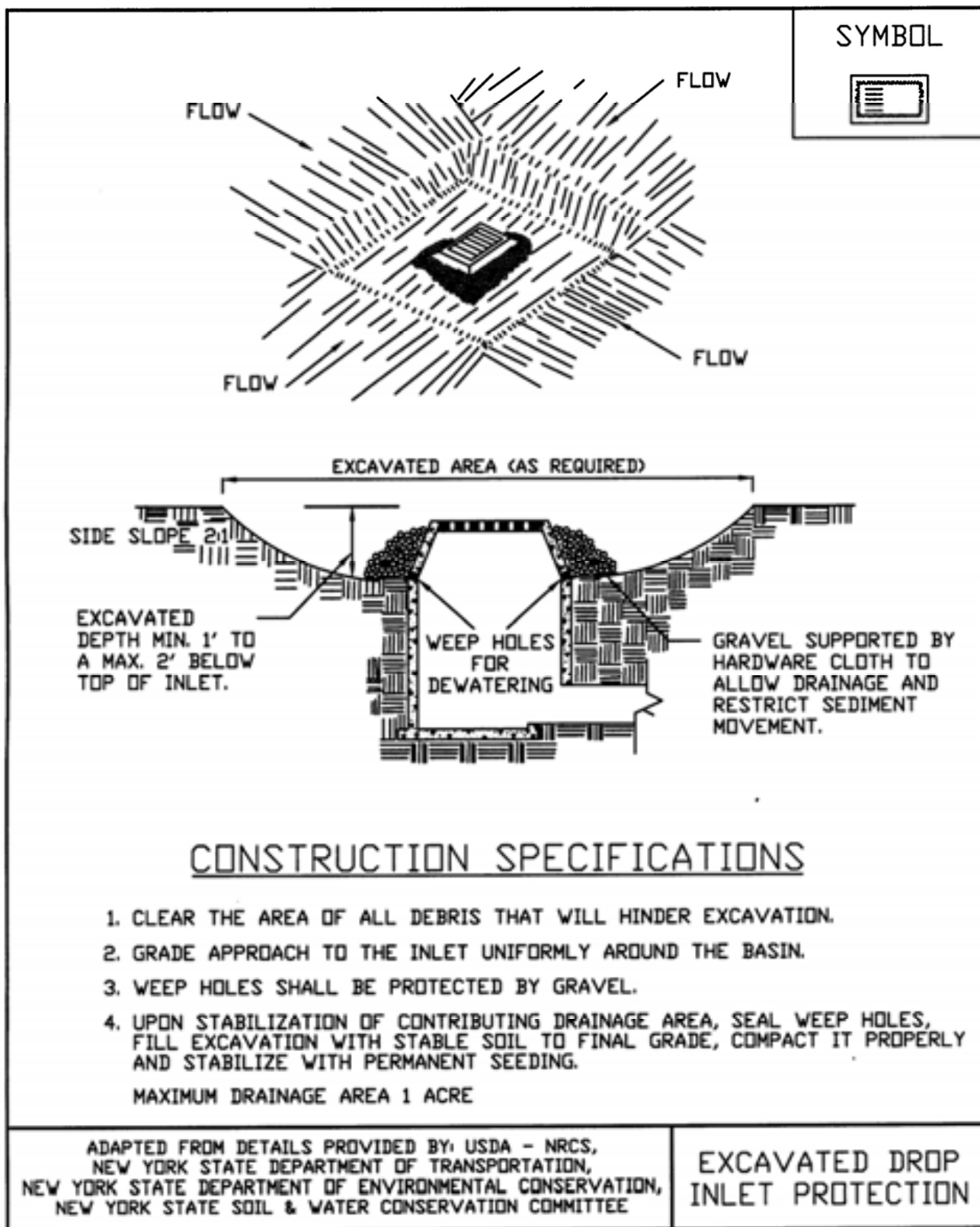

**Figure 5.32
Fabric Drop Inlet Protection**

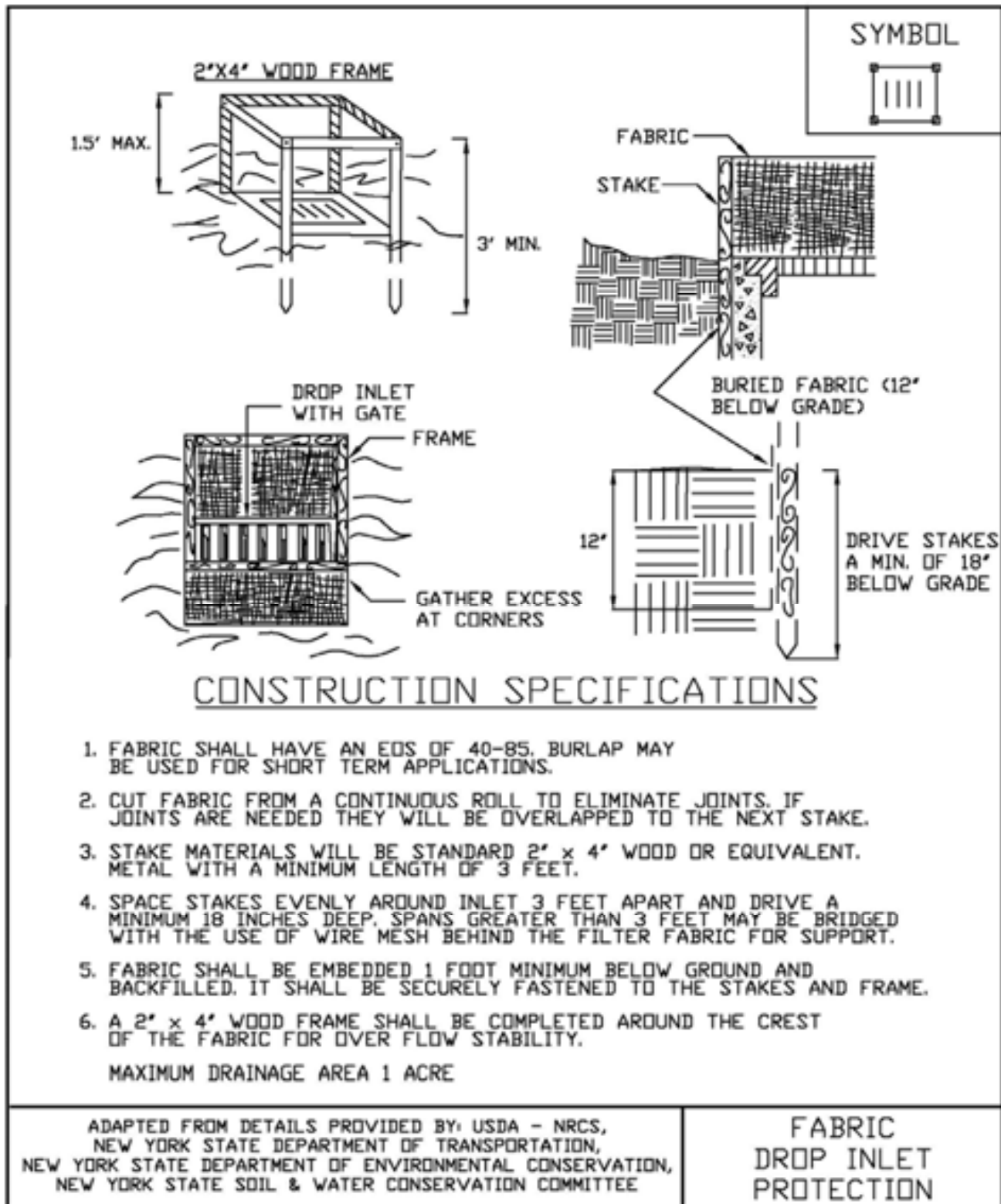
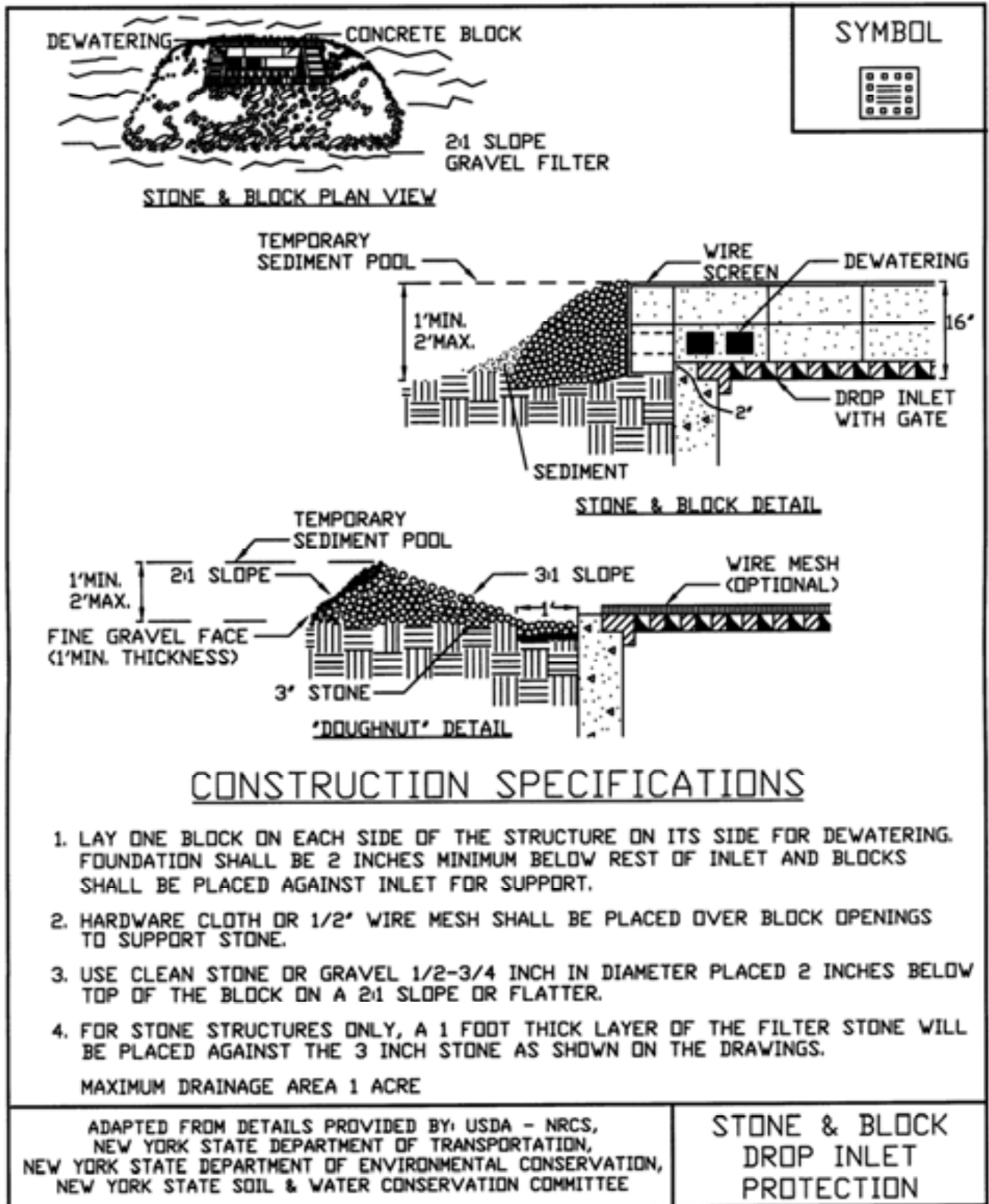

Figure 5.33
Stone & Block Drop Inlet Protection



STANDARD AND SPECIFICATIONS FOR STRAW BALE DIKE



quarter of an acre per 100 feet of dike and the length of slope above the dike shall be less than 100 feet.

Design Criteria

The above table is adequate, in general, for a one-inch rain-fall event. Larger storms could cause failure of this practice. Use of this practice in sensitive areas for longer than one month should be specifically designed to store expected runoff. All bales shall be placed on the contour with cut edge of bale adhering to the ground. See Figure 5.34 on page 5.64 for details.

Definition & Scope

A **temporary** barrier of straw, or similar material, used to intercept sediment laden runoff from small drainage areas of disturbed soil to reduce runoff velocity and effect deposition of the transported sediment load. Straw bale dikes have an estimated design life of three (3) months.

Condition Where Practice Applies

The straw bale dike is used where:

1. No other practice is feasible.
2. There is no concentration of water in a channel or other drainage way above the barrier.
3. Erosion would occur in the form of sheet erosion.
4. Length of slope above the straw bale dike does not exceed the following limits with the bale placed 10 feet from the toe of the slope:

Constructed Slope	Percent Slope	Slope Length (ft.)
2:1	50	25
3:1	33	50
4:1	25	75

Where slope gradient changes through the drainage area, steepness refers to the steepest slope section contributing to the straw bale dike.

The practice may also be used for a single family lot if the slope is less than 15 percent. The contributing drainage areas in this instance shall be less than one

**Figure 5.34
Straw Bale Dike**

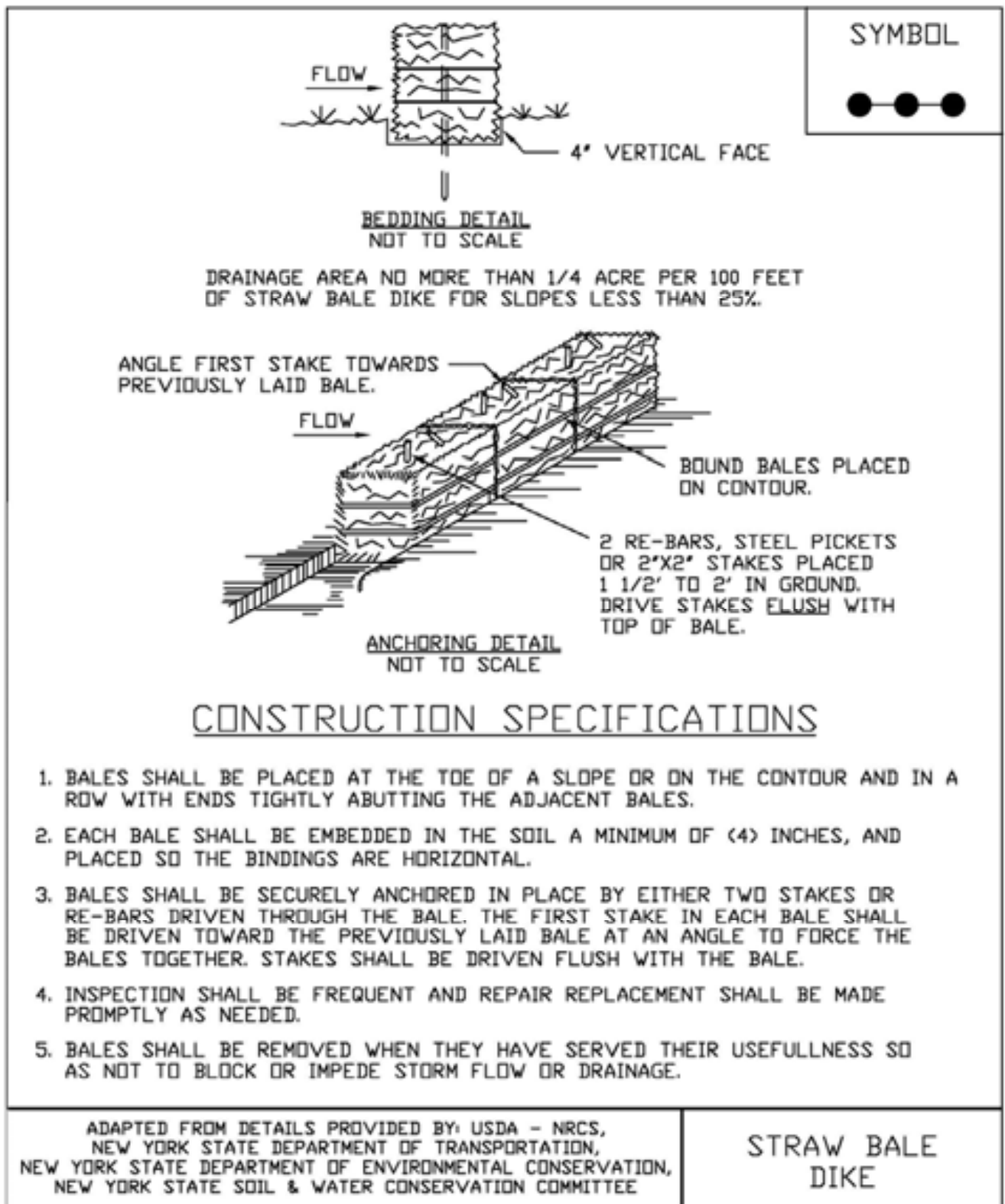

STANDARD AND SPECIFICATIONS FOR TURBIDITY CURTAIN



Definition & Scope

A **temporary** flexible, impenetrable barrier used to trap sediment in water bodies. This curtain is weighted at the bottom to achieve closure while supported at the top through a flotation system and used to prevent the migration of silt from a work site in a water environment into the larger body of water. Top bar float has to support weight of curtain material. Bottom anchor has to be flexible so that it will lie along the contour of the water body bottom.

Condition Where Practice Applies

A turbidity curtain is generally used when construction activity occurs within a waterbody or along its shoreline and is of short duration, generally less than one month. Curtains are used in calm water surfaces and not in areas of flowing water. **Turbidity curtains are not to be used across flowing watercourses.**

Design Criteria

The turbidity curtain shall be located beyond the lateral limits of the construction site and firmly anchored in place. The alignment should be set as close to the work area as possible but not so close as to be disturbed by applicable construction equipment. The height of the curtain shall be 20 percent greater than the depth of the water to allow for water level fluctuations. The area that the turbidity curtain protects shall not contain large culverts or drainage areas that if flows occur behind the curtain would cause a breach or lost contact at the bottom surface.

If water depths at the design alignment are minimal, the toe can be anchored in place by staking.

See Figure 5.35 on page 5.66.

Construction Specifications

The area of proposed installation of the curtain shall be inspected for obstacles and impediments that could damage the curtain or impair its effectiveness to retain sediment. All materials shall be removed so they cannot enter the waterbody. Shallow installations can be made by securing the curtain by staking rather than using a flotation system. Supplemental anchors of the turbidity curtain toe shall be used, as needed, depending on water surface disturbances such as boats and wave action by winds.

Maintenance

The turbidity curtain shall be inspected daily and repaired or replaced immediately. It is not normally necessary to remove sediment deposited behind the curtain; but, when necessary, removal is usually done by hand prior to removal of the barrier. All removed silt is stabilized away from the waterbody. The barrier shall be removed by carefully pulling it toward the construction site to minimize the release of attached sediment. Any floating construction or natural debris shall be immediately removed to prevent damage to the curtain. If the curtain is oriented in a manner that faces the prevailing winds, frequent checks of the anchorage shall be made.

**Figure 5.35
Turbidity Curtain**

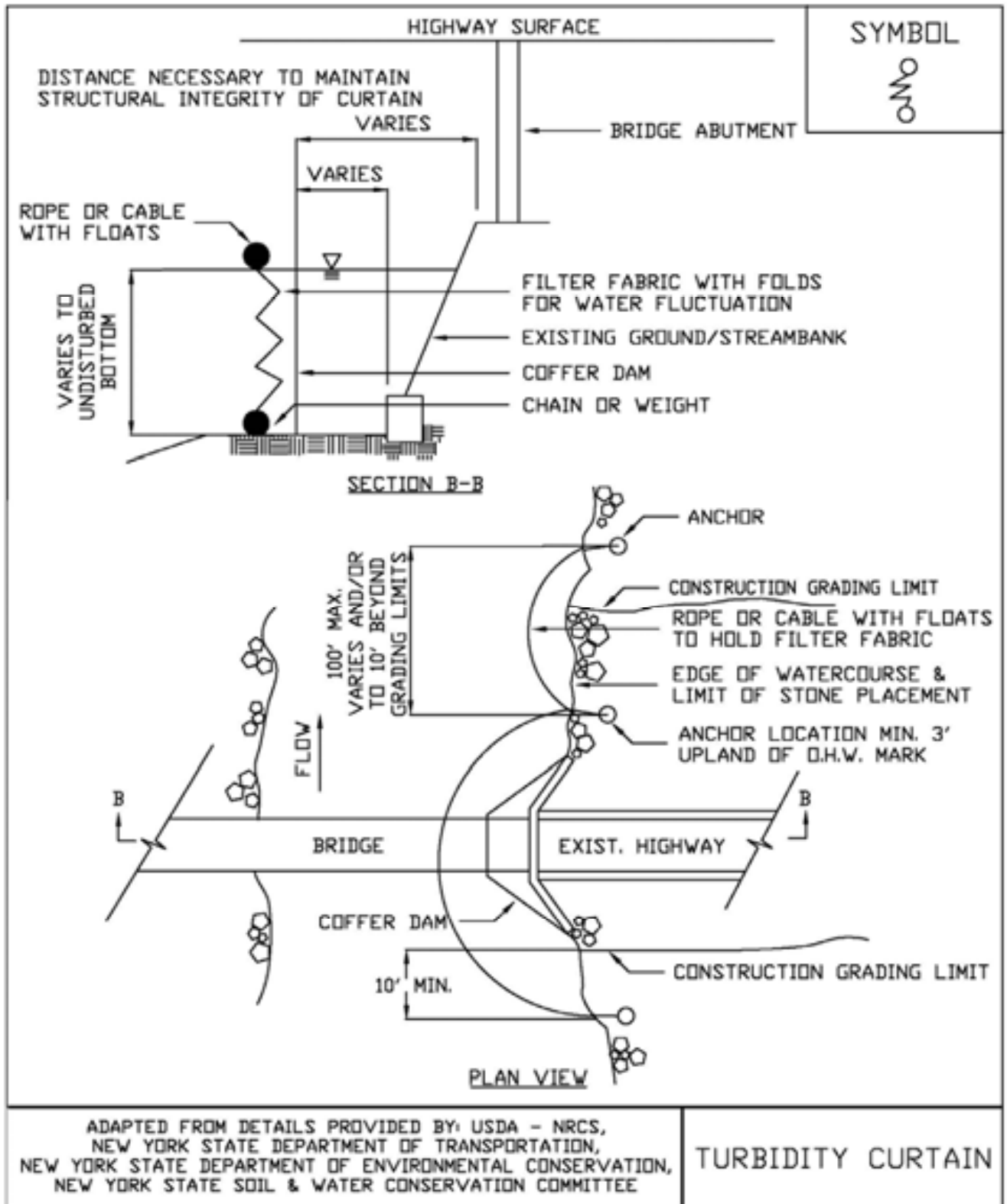

APPENDIX B-3

NYSDOH'S GENERIC COMMUNITY AIR MONITORING PLAN FUGITIVE DUST AND PARTICULATE MONITORING

Appendix 1A

New York State Department of Health Generic Community Air Monitoring Plan

Overview

A Community Air Monitoring Plan (CAMP) requires real-time monitoring for volatile organic compounds (VOCs) and particulates (i.e., dust) at the downwind perimeter of each designated work area when certain activities are in progress at contaminated sites. The CAMP is not intended for use in establishing action levels for worker respiratory protection. Rather, its intent is to provide a measure of protection for the downwind community (i.e., off-site receptors including residences and businesses and on-site workers not directly involved with the subject work activities) from potential airborne contaminant releases as a direct result of investigative and remedial work activities. The action levels specified herein require increased monitoring, corrective actions to abate emissions, and/or work shutdown. Additionally, the CAMP helps to confirm that work activities did not spread contamination off-site through the air.

The generic CAMP presented below will be sufficient to cover many, if not most, sites. Specific requirements should be reviewed for each situation in consultation with NYSDOH to ensure proper applicability. In some cases, a separate site-specific CAMP or supplement may be required. Depending upon the nature of contamination, chemical-specific monitoring with appropriately-sensitive methods may be required. Depending upon the proximity of potentially exposed individuals, more stringent monitoring or response levels than those presented below may be required. Special requirements will be necessary for work within 20 feet of potentially exposed individuals or structures and for indoor work with co-located residences or facilities. These requirements should be determined in consultation with NYSDOH.

Reliance on the CAMP should not preclude simple, common-sense measures to keep VOCs, dust, and odors at a minimum around the work areas.

Community Air Monitoring Plan

Depending upon the nature of known or potential contaminants at each site, real-time air monitoring for VOCs and/or particulate levels at the perimeter of the exclusion zone or work area will be necessary. Most sites will involve VOC and particulate monitoring; sites known to be contaminated with heavy metals alone may only require particulate monitoring. If radiological contamination is a concern, additional monitoring requirements may be necessary per consultation with appropriate DEC/NYSDOH staff.

Continuous monitoring will be required for all ground intrusive activities and during the demolition of contaminated or potentially contaminated structures. Ground intrusive activities include, but are not limited to, soil/waste excavation and handling, test pitting or trenching, and the installation of soil borings or monitoring wells.

Periodic monitoring for VOCs will be required during non-intrusive activities such as the collection of soil and sediment samples or the collection of groundwater samples from existing monitoring wells. "Periodic" monitoring during sample collection might reasonably consist of taking a reading upon arrival at a sample location, monitoring while opening a well cap or

overturning soil, monitoring during well baling/purging, and taking a reading prior to leaving a sample location. In some instances, depending upon the proximity of potentially exposed individuals, continuous monitoring may be required during sampling activities. Examples of such situations include groundwater sampling at wells on the curb of a busy urban street, in the midst of a public park, or adjacent to a school or residence.

VOC Monitoring, Response Levels, and Actions

Volatile organic compounds (VOCs) must be monitored at the downwind perimeter of the immediate work area (i.e., the exclusion zone) on a continuous basis or as otherwise specified. Upwind concentrations should be measured at the start of each workday and periodically thereafter to establish background conditions, particularly if wind direction changes. The monitoring work should be performed using equipment appropriate to measure the types of contaminants known or suspected to be present. The equipment should be calibrated at least daily for the contaminant(s) of concern or for an appropriate surrogate. The equipment should be capable of calculating 15-minute running average concentrations, which will be compared to the levels specified below.

1. If the ambient air concentration of total organic vapors at the downwind perimeter of the work area or exclusion zone exceeds 5 parts per million (ppm) above background for the 15-minute average, work activities must be temporarily halted and monitoring continued. If the total organic vapor level readily decreases (per instantaneous readings) below 5 ppm over background, work activities can resume with continued monitoring.

2. If total organic vapor levels at the downwind perimeter of the work area or exclusion zone persist at levels in excess of 5 ppm over background but less than 25 ppm, work activities must be halted, the source of vapors identified, corrective actions taken to abate emissions, and monitoring continued. After these steps, work activities can resume provided that the total organic vapor level 200 feet downwind of the exclusion zone or half the distance to the nearest potential receptor or residential/commercial structure, whichever is less - but in no case less than 20 feet, is below 5 ppm over background for the 15-minute average.

3. If the organic vapor level is above 25 ppm at the perimeter of the work area, activities must be shutdown.

4. All 15-minute readings must be recorded and be available for State (DEC and NYSDOH) personnel to review. Instantaneous readings, if any, used for decision purposes should also be recorded.

Particulate Monitoring, Response Levels, and Actions

Particulate concentrations should be monitored continuously at the upwind and downwind perimeters of the exclusion zone at temporary particulate monitoring stations. The particulate monitoring should be performed using real-time monitoring equipment capable of measuring particulate matter less than 10 micrometers in size (PM-10) and capable of integrating over a period of 15 minutes (or less) for comparison to the airborne particulate action level. The equipment must be equipped with an audible alarm to indicate exceedance of the action level. In addition, fugitive dust migration should be visually assessed during all work activities.

1. If the downwind PM-10 particulate level is 100 micrograms per cubic meter (mcg/m^3) greater than background (upwind perimeter) for the 15-minute period or if airborne dust is observed leaving the work area, then dust suppression techniques must be employed. Work may continue with dust suppression techniques provided that downwind PM-10 particulate levels do not exceed $150 \text{ mcg}/\text{m}^3$ above the upwind level and provided that no visible dust is migrating from the work area.

2. If, after implementation of dust suppression techniques, downwind PM-10 particulate levels are greater than $150 \text{ mcg}/\text{m}^3$ above the upwind level, work must be stopped and a re-evaluation of activities initiated. Work can resume provided that dust suppression measures and other controls are successful in reducing the downwind PM-10 particulate concentration to within $150 \text{ mcg}/\text{m}^3$ of the upwind level and in preventing visible dust migration.

3. All readings must be recorded and be available for State (DEC and NYSDOH) and County Health personnel to review.

December 2009

Appendix 1B

Fugitive Dust and Particulate Monitoring

A program for suppressing fugitive dust and particulate matter monitoring at hazardous waste sites is a responsibility on the remedial party performing the work. These procedures must be incorporated into appropriate intrusive work plans. The following fugitive dust suppression and particulate monitoring program should be employed at sites during construction and other intrusive activities which warrant its use:

1. Reasonable fugitive dust suppression techniques must be employed during all site activities which may generate fugitive dust.
2. Particulate monitoring must be employed during the handling of waste or contaminated soil or when activities on site may generate fugitive dust from exposed waste or contaminated soil. Remedial activities may also include the excavation, grading, or placement of clean fill. These control measures should not be considered necessary for these activities.
3. Particulate monitoring must be performed using real-time particulate monitors and shall monitor particulate matter less than ten microns (PM10) with the following minimum performance standards:
 - (a) Objects to be measured: Dust, mists or aerosols;
 - (b) Measurement Ranges: 0.001 to 400 mg/m³ (1 to 400,000 :ug/m³);
 - (c) Precision (2-sigma) at constant temperature: +/- 10 :g/m³ for one second averaging; and +/- 1.5 g/m³ for sixty second averaging;
 - (d) Accuracy: +/- 5% of reading +/- precision (Referred to gravimetric calibration with SAE fine test dust (mmd= 2 to 3 :m, g= 2.5, as aerosolized);
 - (e) Resolution: 0.1% of reading or 1g/m³, whichever is larger;
 - (f) Particle Size Range of Maximum Response: 0.1-10;
 - (g) Total Number of Data Points in Memory: 10,000;
 - (h) Logged Data: Each data point with average concentration, time/date and data point number
 - (i) Run Summary: overall average, maximum concentrations, time/date of maximum, total number of logged points, start time/date, total elapsed time (run duration), STEL concentration and time/date occurrence, averaging (logging) period, calibration factor, and tag number;
 - (j) Alarm Averaging Time (user selectable): real-time (1-60 seconds) or STEL (15 minutes), alarms required;
 - (k) Operating Time: 48 hours (fully charged NiCd battery); continuously with charger;
 - (l) Operating Temperature: -10 to 50° C (14 to 122° F);
 - (m) Particulate levels will be monitored upwind and immediately downwind at the working site and integrated over a period not to exceed 15 minutes.
4. In order to ensure the validity of the fugitive dust measurements performed, there must be appropriate Quality Assurance/Quality Control (QA/QC). It is the responsibility of the remedial party to adequately supplement QA/QC Plans to include the following critical features: periodic instrument calibration, operator training, daily instrument performance (span) checks, and a record keeping plan.
5. The action level will be established at 150 ug/m³ (15 minutes average). While conservative,

this short-term interval will provide a real-time assessment of on-site air quality to assure both health and safety. If particulate levels are detected in excess of 150 ug/m³, the upwind background level must be confirmed immediately. If the working site particulate measurement is greater than 100 ug/m³ above the background level, additional dust suppression techniques must be implemented to reduce the generation of fugitive dust and corrective action taken to protect site personnel and reduce the potential for contaminant migration. Corrective measures may include increasing the level of personal protection for on-site personnel and implementing additional dust suppression techniques (see paragraph 7). Should the action level of 150 ug/m³ continue to be exceeded work must stop and DER must be notified as provided in the site design or remedial work plan. The notification shall include a description of the control measures implemented to prevent further exceedances.

6. It must be recognized that the generation of dust from waste or contaminated soil that migrates off-site, has the potential for transporting contaminants off-site. There may be situations when dust is being generated and leaving the site and the monitoring equipment does not measure PM₁₀ at or above the action level. Since this situation has the potential to allow for the migration of contaminants off-site, it is unacceptable. While it is not practical to quantify total suspended particulates on a real-time basis, it is appropriate to rely on visual observation. If dust is observed leaving the working site, additional dust suppression techniques must be employed. Activities that have a high dusting potential--such as solidification and treatment involving materials like kiln dust and lime--will require the need for special measures to be considered.

7. The following techniques have been shown to be effective for the controlling of the generation and migration of dust during construction activities:

- (a) Applying water on haul roads;
- (b) Wetting equipment and excavation faces;
- (c) Spraying water on buckets during excavation and dumping;
- (d) Hauling materials in properly tarped or watertight containers;
- (e) Restricting vehicle speeds to 10 mph;
- (f) Covering excavated areas and material after excavation activity ceases; and
- (g) Reducing the excavation size and/or number of excavations.

Experience has shown that the chance of exceeding the 150ug/m³ action level is remote when the above-mentioned techniques are used. When techniques involving water application are used, care must be taken not to use excess water, which can result in unacceptably wet conditions. Using atomizing sprays will prevent overly wet conditions, conserve water, and provide an effective means of suppressing the fugitive dust.

8. The evaluation of weather conditions is necessary for proper fugitive dust control. When extreme wind conditions make dust control ineffective, as a last resort remedial actions may need to be suspended. There may be situations that require fugitive dust suppression and particulate monitoring requirements with action levels more stringent than those provided above. Under some circumstances, the contaminant concentration and/or toxicity may require additional monitoring to protect site personnel and the public. Additional integrated sampling and chemical analysis of the dust may also be in order. This must be evaluated when a health and safety plan is developed and when appropriate suppression and monitoring requirements are established for protection of health and the environment.