

**REMEDIAL ACTION SELECTION REPORT
FOR THE PRODUCT RECOVERY
INTERIM REMEDIAL MEASURE IN THE
EASTERN TANK YARD AREA**

**Buffalo Terminal
625 Elk Street
Buffalo, New York**

January 5, 2005

Prepared for:

EXXONMOBIL OIL CORPORATION
1001 Wampanpag Trail
Riverside, Rhode Island, 02915

Prepared by:

REMEDIAL ENGINEERING, P.C.
209 Shafter Street
Islandia, New York 11749

and

ROUX ASSOCIATES, INC.
209 Shafter Street
Islandia, New York 11749

TABLE OF CONTENTS

DISCLOSURE STATEMENT	vi
1.0 INTRODUCTION	1
2.0 SITE SETTING AND HISTORY	4
2.1 Eastern Tank Yard Area.....	4
2.1.1 Former and Current Structures.....	4
2.2 Waste Handling Areas.....	5
2.3 Spills/Releases	6
2.4 Environmental Remediation History in the ETYA	7
2.4.1 Well Point System.....	7
2.4.3 Installation and Maintenance of the Booms Around the Seepage Areas Adjacent to the ETYA	7
2.4.4 Separate-Phase Product Recovery	8
3.0 SUMMARY OF ENVIRONMENTAL CONDITIONS	9
3.1 Previous Investigations	9
3.2 Topography	10
3.3 Geology and Hydrogeology.....	10
3.4 Environmental Quality.....	11
3.4.1 Separate-Phase Product.....	11
3.4.2 Soil Quality.....	12
3.4.3 Sediment Quality	13
3.4.4 Groundwater Quality	14
3.4.5 Field Observations Along the Buffalo River Bank Adjacent to the ETYA.....	15
4.0 REMEDIAL GOALS, SCGS AND REMEDIAL ACTION OBJECTIVES	17
4.1 Remedial Goals.....	17
4.2 Standards, Criteria and Guidance	17
4.3 Remedial Action Objectives	18
5.0 FIELD TESTS OF POTENTIAL TECHNOLOGIES	20
5.1 Long Term Product-Only Recovery Testing.....	20
5.2 Aquifer Testing of Groundwater Recovery for Containment and Product Recovery Enhancement	21
5.2.1 RW-8R Pump Test Results.....	21
5.2.2 ETYA Separate-Phase Product Volume Estimate	22
5.3 VER and ChemOx Pilot Test Objectives	22
5.3.1 Health and Safety/Contingency Plan	23
5.4 Vacuum Enhanced Extraction Pilot Test.....	23
5.4.2 Overview of VER as a Remedial Technology.....	23
5.4.3 Pilot-Scale VER System	24
5.4.4 VER Pilot Test Well and Monitoring Wells.....	25
5.4.4.1 Pilot Test Wells	25
5.4.4.2 Monitoring Wells	26
5.4.5 Implementation of the Pilot Study.....	27
5.4.5.1 Short Duration Testing.....	29

TABLE OF CONTENTS

(Continued)

5.4.5.2	Extended Duration Testing.....	29
5.4.6	Results and Data Evaluation	30
5.4.6.1	Pilot Test Results	30
5.4.6.2	Data Evaluation.....	34
5.5	Chemical Oxidation Pilot Test (ChemOx).....	36
5.5.1	Overview Advanced Oxidation System.....	37
5.5.2	Ozone and Hydrogen Peroxide	37
5.5.3	Injection Wells/Monitoring Wells	39
5.5.4	System Equipment	40
5.5.5	Control Panel	41
5.5.6	Above Grade Piping.....	41
5.5.7	Pilot Test Monitoring.....	42
5.5.7.1	Daily Monitoring	42
5.5.7.2	Weekly Monitoring.....	42
5.5.7.3	Membrane Interface Probe.....	43
5.5.8	Advanced Oxidation System Pre-Startup	44
5.5.9	Advanced Oxidation System Startup.....	45
5.5.9.1	System Start-Up: Day One.....	46
5.5.9.2	System Start-Up: Day Two.....	46
5.5.9.3	System Start-Up: Day Three.....	47
5.5.9.4	System Start-Up: Day Four and Day Five	47
5.5.9.5	Evaluation of System Startup Data	48
5.5.9.6	Long Term System Operation.....	49
5.5.10	Data Evaluation and Results of the ChemOx Pilot Test	50
5.5.10.1	MIP Data	50
5.5.10.2	Groundwater Quality	52
5.5.10.3	Water Table Rise, Product Thickness, Physical Changes in Product, Product Recovery and Product Analysis.....	53
5.5.10.4	DO and ORP	56
5.5.10.5	Temperature Rise, Carbon Monoxide, PID and LEL Measurements.....	57
5.5.10.6	Soil Analysis	58
5.6	Field Test Conclusions.....	58
5.6.1	Product-Only Recovery	59
5.6.2	Groundwater Recovery for Containment and Product Recovery Enhancement	59
5.6.3	VER Pilot Test.....	60
5.6.4	ChemOx Pilot Test.....	60
6.0	RECOMMENDED REMEDY	62
6.1	Description of Selected Remedy/Conceptual Design	62
6.1.1	Proposed ChemOx Injection Point Spacing and Construction	63
6.1.2	Proposed Mobile ChemOx Injection Units and Above Grade Piping	64
6.1.3	Proposed Monitoring Network	65

TABLE OF CONTENTS

(Continued)

6.1.3.1 Existing and Proposed Monitoring Wells.....	65
6.1.3.2 Proposed MIP Boring Locations.....	66
6.1.4 Proposed ChemOx System Phased Operation Sequence.....	66
6.2 Rationale for Selection.....	67
6.2.1 Overall Protection of Human Health and the Environment.....	68
6.2.2 Compliance with Remedial Goals, SCGs, and RAOs	68
6.2.3 Long-Term Effectiveness and Permanence	69
6.2.4 Reduction in Toxicity, Mobility or Volume through Treatment	70
6.2.5 Short-Term Effectiveness	70
6.2.6 Implementability	71
6.2.7 Cost	72
6.2.8 Compatibility with Land Use.....	72
6.3 Operation, Maintenance and Monitoring.....	73
6.3.1 Operation and Maintenance	73
6.3.2 Monitoring	74
6.4 IRM Work Plan.....	79
6.5 Proposed Schedule.....	79
7.0 REFERENCES	82

TABLES

1. Storage Tank History for ETYA
2. Summary of Spills/Releases in the ETYA
3. Summary of Water-Level, Separate-Phase Product Thickness Gauging and Separate-Phase Product Bailing Data from ETYA Wells
4. Summary of Offgas Vapor Quality Data Collected during VER Pilot Test
5. Summary of Extracted Groundwater Quality Data Collected during VER Pilot Test
6. Summary of Volatile Organic Compounds Detected in Groundwater Samples during ChemOx Pilot Test
7. Summary of Semivolatile Organic Compounds Detected in Groundwater Samples during ChemOx Pilot Test
8. Summary of Volatile Organic Compounds Detected in Separate-Phase Product - ChemOx Pilot Test
9. Summary of Semivolatile Organic Compounds Detected in Separate-Phase Product - ChemOx Pilot Test
10. Summary of Soil Sample Results from SB-194 and MW-28

FIGURES

1. Site Location Map, ExxonMobil Buffalo Terminal, Buffalo, New York
2. Geographic Areas of the Buffalo Terminal
3. Generalized Hydrogeologic Cross-Sections

TABLE OF CONTENTS

(Continued)

4. Process and Instrumentation Diagram for VER Pilot Test System
5. Pilot Test Well and Typical Monitoring Well Detail for Vacuum Enhanced Recovery Pilot Test
6. Process and Instrumentation Diagram for ChemOx Pilot Test
7. Well Construction Detail
8. Summary of Total Volatile Organic Compounds (VOCs) and Semivolatile Organic Compounds (SVOCs) for CO-1
9. Summary of Total Volatile Organic Compounds (VOCs) and Semivolatile Organic Compounds (SVOCs) for CO-2
10. Summary of Total Volatile Organic Compounds (VOCs) and Semivolatile Organic Compounds (SVOCs) for CO-3
11. Summary of Total Volatile Organic Compounds (VOCs) and Semivolatile Organic Compounds (SVOCs) for CO-4
12. Summary of Total Volatile Organic Compounds (VOCs) and Semivolatile Organic Compounds (SVOCs) for CO-5
13. Summary of Total Volatile Organic Compounds (VOCs) and Semivolatile Organic Compounds (SVOCs) for VERMW-1
14. Summary of Total Volatile Organic Compounds (VOCs) and Semivolatile Organic Compounds (SVOCs) for VERMW-2
15. Summary of Total Volatile Organic Compounds (VOCs) and Semivolatile Organic Compounds (SVOCs) for RW-8R
16. Summary of Total Volatile Organic Compounds (VOCs) and Semivolatile Organic Compounds (SVOCs) for MW-3URS
17. Summary of Total Volatile Organic Compounds (VOCs), Dissolved Oxygen (DO), Temperature and Oxidation Reduction Potential (ORP) for CO-1
18. Summary of Total Volatile Organic Compounds (VOCs), Dissolved Oxygen (DO), Temperature and Oxidation Reduction Potential (ORP) for CO-2
19. Summary of Total Volatile Organic Compounds (VOCs), Dissolved Oxygen (DO), Temperature and Oxidation Reduction Potential (ORP) for CO-3
20. Summary of Total Volatile Organic Compounds (VOCs), Dissolved Oxygen (DO), Temperature and Oxidation Reduction Potential (ORP) for CO-4
21. Summary of Total Volatile Organic Compounds (VOCs), Dissolved Oxygen (DO), Temperature and Oxidation Reduction Potential (ORP) for CO-5
22. Summary of Total Volatile Organic Compounds (VOCs), Dissolved Oxygen (DO), Temperature and Oxidation Reduction Potential (ORP) for VERMW-1
23. Summary of Total Volatile Organic Compounds (VOCs), Dissolved Oxygen (DO), Temperature and Oxidation Reduction Potential (ORP) for VERMW-2
24. Proposed Chemical Oxidation (ChemOx) System IRM and Monitoring Network Layout
25. Generalized Hydrogeologic Cross Section G-G' Through the Proposed IRM Area

TABLE OF CONTENTS

(Continued)

APPENDICES

- A. Hydrographs for Selected Wells
- B. Separate-Phase Product Analysis Results for ETYA Wells
- C. Well Construction Logs
- D. VER Pilot Test Data and Graphs
- E. ChemOx Pilot Test Data and Graphs

PLATES

- 1. Vacuum Enhanced Recovery and Chemical Oxidation Pilot Test Area Layout and Monitoring Well Network
- 2. Generalized Hydrogeologic Cross Sections D-D', E-E' and F-F' with Baseline Water Table Elevation and Product Thickness Data (April 7, 2004)
- 3. Generalized Hydrogeologic Cross Sections D-D', E-E' and F-F' with Highest and Lowest Water Table Elevations and Corresponding Separate Phase Product Thickness
- 4. Generalized Hydrogeologic Cross Sections D-D', E-E' and F-F' with Water Table Elevations Corresponding to Thickest Observed Apparent Product Thickness

DISCLOSURE STATEMENT

All professional engineering services rendered in preparation of this document have been performed for Roux Associates, Inc. by Remedial Engineering, P.C., a professional corporation qualified to perform such services in the State of New York.

1.0 INTRODUCTION

Roux Associates, Inc. and Remedial Engineering, P.C. (collectively referred to herein as Roux Associates), have prepared this Remedial Action Selection Report (RAS) for the Product Recovery Interim Remedial Measure (IRM) in the Eastern Tank Yard Area (ETYA) on behalf of ExxonMobil Oil Corporation (ExxonMobil) to describe the proposed interim remedial measure to address an area of separate-phase product at the ExxonMobil Buffalo Terminal (Site) located at 625 Elk Street, Buffalo, New York (Figure 1). The Site has been divided into nine geographic areas, which have been defined for the purpose of assessing environmental conditions and reporting the results of area-specific activities (Figure 2). The area of separate-phase product to be addressed in this RAS report is in the ETYA.

The RAS report has been prepared in accordance with the requirements of Section 4 of the NYSDEC "Draft DER-10 Technical Guidance for Site Investigation and Remediation (DER-10)," dated December 25, 2002 (NYSDEC 2002) for a long term spill response.

This RAS has been developed based upon the results of previous Site investigations, including the Site Facility Investigation Completion conducted from July through October 1999, the Separate-Phase Product Investigation for the Eastern Tank Yard Area conducted in April 2001, the Site Investigation Completion conducted from August 2001 through February 2002 and the Evaluation of Aquifer Characteristics conducted from June 2002 through August 2002.

As part of the remedial action selection process, field tests of four technologies were performed to evaluate potential remedial technologies for the site. The field-testing included the following:

- Long-term separate-phase product-only recovery testing, consisting of manual bailing of product and automated product-only pumping using a solar powered pumping system, has been implemented in the target area since 2001. The results of the ongoing product recovery are described below.
- Aquifer testing to evaluate the potential for containing and recovering groundwater, controlling the migration of separate-phase product and enhancing separate-phase product recovery through groundwater recovery was conducted in June and August 2002. The work was conducted in accordance with the work plan for the Evaluation of Aquifer Characteristics, dated May 2, 2002 (Roux Associates, 2002) and the results are described briefly below and in detail in the report entitled Evaluation of Aquifer Characteristics, dated March 24, 2003 (Roux Associates, 2003a).

- A Vacuum Enhanced Recovery (VER) pilot test was performed from October 21 through 23, 2003 in accordance with the approved Vacuum Enhanced Recovery Pilot Test Work Plan (VER Work Plan) dated September 15, 2003 (Roux Associates, 2003b). The results of the pilot testing are described in detail below.
- A Chemical Oxidation (ChemOx) Pilot test was performed from April 7, 2004 (baseline) to June 22, 2004 in accordance with the approved Chemical Oxidation Pilot Test Work Plan for the Easter Tank Yard Area (ChemOx Work Plan) prepared by Groundwater and Environmental Services, Inc. (GES), dated January 7, 2004 (GES 2004). The results of the pilot testing are described in detail below.

The purpose of the field testing was to evaluate the effectiveness of these technologies as a remedial alternative for recovery of separate-phase product as an IRM from the plume located south of Tank 176 in the ETYA and establish design parameters for the selected technology. Based upon the results of the field testing, ChemOx has been selected as the IRM for this area of the Site since it was determined to be capable of meeting the remedial goals and remedial action objectives (RAOs) described in Section 4.0. Therefore, a conceptual design and evaluation of ChemOx in accordance with the following criteria presented in Section 4.4 of the DER-10 is presented in Section 6.0 of this report:

- Overall protection of health and the environment;
- Compliance with Standards, Criteria and Guidance (SCGs);
- Long-term effectiveness and permanence;
- Reduction of toxicity, mobility or volume with treatment;
- Short-term effectiveness;
- Implementability; and
- Cost

Product only pumping/manual bailing of product, groundwater recovery and VER, as described below proved incapable of meeting remedial goals and RAOs for the target area and were therefore not evaluated further.

The remainder of this RAS report is organized as follows:

- Section 2.0 provides a summary of the history of the ETYA, including ownership, past and present operations (i.e., buildings, tanks, etc) and spills or releases;

- Section 3.0 provides a summary of environmental conditions based upon the results of previous investigations;
- Section 4.0 identifies remedial goals and remedial action objectives;
- Section 5.0 describes field tests performed:
- Section 6.0 provides a conceptual design of the IRM and the rationale for selection; and
- Section 7.0 presents references.

Included with the RAS are the following appendices:

- Appendix A: Hydrographs for Selected Wells
- Appendix B: Historical Separate-Phase Product Analysis Results for ETYA Wells
- Appendix C: Well Construction Logs
- Appendix D: VER Pilot Test Data and Graphs
- Appendix E: ChemOx Pilot Test Data and Graphs

2.0 SITE SETTING AND HISTORY

The historical information presented in this Section was obtained from the document entitled “History of Operations at Buffalo Terminal” (Roux Associates, 2000). Historically, the major Site refinery and terminal operations occurred south of Elk Street in an area of approximately 89 acres. The petroleum refining operations at the Site began during 1880. The majority of the Site was purchased by Standard Oil Company of New York (SOCONY), ExxonMobil's predecessor, in 1892. In May 1981, the Site terminated all refinery operations. The Site continued as a distribution terminal, receiving product via a pipeline and barge. Throughout the Site's history, the areal extent of property owned by ExxonMobil changed as portions of property were acquired or sold for various reasons. The area within the current ExxonMobil property boundary is 78.3 acres.

2.1 Eastern Tank Yard Area

The ETYA is located between the eastern side of the Erie Lackawanna Railroad Company (formerly D.L.&W.R.R.) rail tracks and the bank of the Buffalo River. Prior to the straightening of the Buffalo River between 1914 and 1917, the river's course ran in a generally north to south direction through the ETYA, parallel to the D.L.&W.R.R. tracks. The river was filled in, relocated to the east, and rerouted to continue in a west-southwesterly direction. A small parcel of land that existed prior to the rerouting between the D.L.&W.R.R. tracks and the original river was owned by SOCONY. This parcel of land was relinquished by SOCONY to the City of Buffalo on July 8, 1915. The City of Buffalo reportedly utilized the land between the D.L.&W.R.R. tracks and the rerouted river channel for disposal of municipal waste between the years 1921 and 1951. ExxonMobil purchased the parcel of land in 1951. The ETYA currently encompasses 15.3 acres.

2.1.1 Former and Current Structures

The City of Buffalo reportedly utilized the land between the D.L.&W.R.R. tracks and the rerouted river channel for disposal of municipal waste between the years 1921 and 1951. In 1953, two aboveground storage tanks (Tanks 175 and 176), each with 70,000-barrel capacities, were constructed in the ETYA. The details concerning these storage tanks are provided in Table 1. To the southwest of the storage tanks, four propane tanks and a propane loading rack were constructed between 1958 and 1966. According to discussions with former and/or current

ExxonMobil employees, the propane loading rack was never utilized. The propane tanks and loading rack were removed in 1988.

Three product pipelines are present within the ETYA (Plate 1). Two of the pipelines are owned by ExxonMobil, one is abandoned in place and the other is currently active. ExxonMobil's pipeline enters the ETYA at the northeast boundary. The abandoned portion crosses through the length of the ETYA in a south/southwesterly direction and continues into the STYA along the bulkhead immediately adjacent to the Buffalo River. According to a drawing of the pipeline, the depth of burial within the ETYA is approximately 4 ft. According to this drawing, the pipeline was purged of product and abandoned in place.

The active portion of the ExxonMobil pipeline follows the fence line in a northerly direction. The pipeline remains buried until it comes above grade along the northern border of the ETYA. The aboveground portion of the pipeline continues to follow the fence line until it crosses underneath the former Erie-Lackawanna Railroad and into the Southern Tank Yard Area (STYA) at the location of the access road between the ETYA and the STYA.

Lakehead Pipeline Company, Inc. (Lakehead) owns the third product pipeline. The approximate location of this pipeline is shown on Plate 1. This pipeline enters the ETYA at a location near the ExxonMobil pipeline, then it generally runs in a west/southwesterly direction south of the containment berm for Tanks 175 and 176 to a point approximately 200 ft beyond the tanks where it turns northwest and enters the STYA. Information provided to ExxonMobil by Lakehead indicates that the line was removed from active service in 1982 when the product was purged and the line was filled with nitrogen.

2.2 Waste Handling Areas

ExxonMobil also used the ETYA for disposal purposes. According to company records, the waste disposed in the ETYA included storage tank bottom material, spent cracking and reforming catalysts, oil/water separator material, slop oil solids, demolition debris, and asphalt-containing soil. ExxonMobil reportedly used this area for disposal between the years 1952 and 1974. Plate 1 shows disposal locations of wastes disposed in the ETYA as reported in the company records. In addition, a review of available aerial photographs indicates that the area southwest of

the tanks was a possible disposal location. Following several subsurface investigations, the disposal area within the ETYA was re-classified in 1988 by the NYSDEC from a New York State Registry of Inactive Hazardous Waste Disposal Sites Class 2a site (indicating that additional information is needed to accurately categorize the site) to a Class 3 site. This Class 3 classification indicates that the area does not pose a significant threat to the public or environment.

2.3 Spills/Releases

Two spills were documented to have occurred in this area (Table 2). The following releases have supporting documentation in the form of ExxonMobil records and NYSDEC Spill Report Forms.

- On August 28, 1989, approximately 6,500 gallons of unleaded gasoline were released. This incident was reported to NYSDEC and assigned Spill No. 8905279. It was also reported to the City of Buffalo Fire Department. The incident occurred when Tank 176 was overfilled due to incorrect safe fill and high alarm settings being used. The area was barricaded and approximately 2,800 gallons of product were removed with a vacuum truck. In addition, the safe fill and high level alarm settings were corrected. Subsequently, monitoring wells were installed and monitored for the presence of product. The containment berm for this tank and Tank 175 were lined during the storage tank realignment project completed in 1991.
- On October 4, 2000, a sheen and seepage area was identified along the Buffalo River Bank adjacent to the ETYA during the installation of MW-28. The NYSDEC was notified on that date and assigned Spill No. 0075417. In response, ExxonMobil installed a sorbent boom around two areas where impacts were observed (total length of approximately 300 ft). The booms were inspected and maintained daily until December 18, 2000 to prevent any adverse impacts to the Buffalo River from this area. The booms were destroyed on December 18, 2000 due to significant ice accumulation and movement in the river. Through March 2001, it was not possible to install permanent booms due to ice conditions in the river. Sorbent booms were installed along the riverbank around the seepage areas on March 16, 2001 and have been maintained since. Permanent slick-bar booms were installed around the areas of seepage in May 2001 (see Plate 1 for locations). The seepage areas have been inspected regularly since October 2000. These inspections include a description of the area of seepage noting any differences in the appearance of the area (i.e., presence or absence of sheen and its location if present). The inspections also note the position of the boom and any adjustments required. The inspection results are presented in the site monitoring reports issued to NYSDEC on a quarterly basis. Recently, the boomed area has been expanded based on additional sheen observed outside the boomed areas in June 2003, as discussed in Section 2.5.3.

2.4 Environmental Remediation History in the ETYA

The environmental remediation efforts on the ETYA include operation of the eastern leg of the well point system (WPS), treatment of extracted water, separate-phase product recovery (automated recovery and manual bailing) and installation and maintenance of booms around the seepage area south of the ETYA.

2.4.1 Well Point System

Two groundwater extraction systems are currently operating at the Site, the well point system and the dual-phase recovery system. The groundwater recovered by these systems is treated by the Site's Water Treatment System, installed in the Remediation Building in the Former Refinery Area (FRA) and operational since 1993. Treated water is discharged to the Buffalo Sewer Authority (BSA) municipal sewer system. The well point system extends into the ETYA.. The dual phase product recovery systems are not located in the ETYA, and therefore they are not discussed.

Total fluids pulled from the WPS are pumped directly into the piping system and transmitted to the Site's Water Treatment System.

The Site's Water Treatment System was installed and operational by 1993. The Water Treatment System is located in the Remediation Building in the Former Refinery Area (FRA). The treatment system handles all extracted groundwater, as well as storm water not associated with the lined active tank farm drainage system, prior to discharge to the BSA sewer system.

Following treatment and flow monitoring by an ultrasonic flow meter, water is discharged to the BSA outfall. Recovered separate phase product is pumped to a storage tank and disposed of offsite.

2.4.3 Installation and Maintenance of the Booms Around the Seepage Areas Adjacent to the ETYA

A sheen and seepage area along the Buffalo River bank adjacent to the ETYA were first observed on October 4, 2000 during the installation of monitoring well MW-28. The NYSDEC was notified on that date and assigned Spill No. 0075417. In response, ExxonMobil installed a sorbent boom around two areas (shown on Plate 1) where impacts were observed. The booms

were inspected and maintained daily until December 18, 2000 to prevent any adverse impacts to the Buffalo River from this area. The booms were destroyed on December 18, 2000 due to significant ice accumulation and movement in the river.

Through March 2001, it was not possible to install permanent booms due to ice conditions in the river. Sorbent booms were installed along the riverbank around the seepage areas on March 16, 2001 and have been maintained since. Permanent slick-bar booms were installed around the areas of seepage in May 2001 (see Plate 1 for locations).

On June 4, 2003, the shoreline of the Buffalo River was inspected by the NYSDEC. Areas of sheen were observed outside the currently boomed areas to the south and west of the southernmost boom. On June 6, 2003, approximately 120 feet of temporary absorbent booms were placed on the Buffalo River along the south end of the southern containment boom. On June 19 and 20, 2003, the absorbent booms were replaced with permanent booms and attached to the south end of the existing southern containment boom, therefore converting it into a single containment boom measuring 375 feet long. The northern containment boom remains intact.

The seepage areas have been inspected regularly since October 2000. These inspections include a description of the area of seepage noting any differences in the appearance of the area (i.e., presence or absence of sheen and its location if present). The inspections also note the position of the boom and any adjustments required.

2.4.4 Separate-Phase Product Recovery

Separate-phase product recovery is ongoing in the ETYA. Product recovery efforts in the ETYA have included automated product recovery using a solar powered product only pumping system and manual bailing. Product recovery from selected wells has been conducted in order to provide additional data on the recoverability of product and evaluate the appropriateness of the technology for the target area. The results of the long-term separate phase product recovery efforts in the ETYA are described in detail in Section 5.0.

3.0 SUMMARY OF ENVIRONMENTAL CONDITIONS

Data regarding environmental conditions at the Site, and particularly the ETYA were obtained from a review of the results of previous investigations and the ongoing monitoring program at the Site. The following sections include:

- a listing and brief description of previous investigations completed; and
- a summary of the environmental quality based on previous investigations, including soil quality, groundwater quality, separate-phase product occurrence and sediment quality.

3.1 Previous Investigations

The following is a summary of the previous investigations conducted in the ETYA:

- Phase I Investigation at the ETYA (former Disposal Area), conducted by Recra Research, Inc. in 1983 (Recra Research, 1983);
- Phase II investigation at the ETYA (former Disposal Area), conducted by URS Company, Inc. in 1986 (URS, 1986) and follow-up sampling for the Phase II investigation in the ETYA conducted in the fall of 1986, spring of 1987 and March 1988;
- Installation of five monitoring wells (B-1MW, B-2MW and B-4MW through B-6MW) in various areas of the Site and performance of water-level and product thickness measurements in these new wells, by Empire Soils Investigations, Inc. in July 1989 (ESI, 1989a);
- Installation of two monitoring wells (W-1 and W-2) in the ETYA and performance of water-level and product thickness measurements in these new wells, by Empire Soils Investigations, Inc. in October 1989 (ESI, 1989b);
- Installation of 25 monitoring piezometers (P-1 through P-25) in the ETYA and performance of water-level and product thickness measurements in these new piezometers, by Empire Soils Investigations, Inc. in April 1990 (ESI, 1990);
- Site Facility Investigation (SFI), conducted by Groundwater & Environmental Services, Inc. (GES) from June through August 1998 (Roux Associates, 1998);
- SFI Completion, conducted by GES and Roux Associates from July through October 1999 (Roux Associates, 1999);
- Field inspection of approximately 1,000 feet of shoreline along the Buffalo River by representatives of ExxonMobil, NYSDEC and Roux Associates on October 26, 2000;
- Installation of MW-28 in the ETYA on October 4, 2000 and installation of soil borings, collection of soil samples, installation of monitoring wells and collection of sediment samples conducted by GES and Roux Associates between December 2000 and April 2001 summarized in the Separate-Phase Product Investigation Report for the Eastern Tank Yard Area (Roux Associates 2001);

- Site Investigation Completion, conducted by GES from August 2001 through February 2002 (Roux Associates, 2002); and
- Evaluation of Aquifer Characteristics conducted by GES and Roux Associates, Inc. from June 2002 through August 2002 (Roux Associates, 2003).

3.2 Topography

The topography in the ETYA is generally flat, with a steeply sloped embankment to the Buffalo River. The ground surface elevation drops by approximately 22 to 25 feet in a horizontal span of approximately 25 to 30 feet from the top of the embankment to the river level. The Buffalo River shoreline can usually be accessed by a narrow strip of level ground at the base of the embankment. At times, high water elevations in the Buffalo River prevent access to the shoreline.

3.3 Geology and Hydrogeology

In general, the geology of the entire ETYA is influenced by the former disposal activities that were conducted in this area and re-routing of the Buffalo River. Four unconsolidated deposits exist in the area under consideration. The first is a fill layer that consists of black cinders, concrete, brick, glass, wood, silt, gravel, sand and slag that is consistent with the historical disposal activities. This layer varies in thickness from 7 to 23 feet. The second unit consists of sands; silt (sandy silt to clayey silts); and silts and clays. The thickness of this layer is between 0 and 20 feet throughout the area of interest. The third layer is predominantly comprised of sand and gravel and ranges in thickness from 4 to 11 feet. Underlying the sand and gravel layer is a clay layer. Bedrock was not encountered in any of the wells installed in the ETYA. Three generalized hydrogeologic cross sections are presented on Figure 3. The cross section lines are shown on Plate 1. Additional, more detailed cross sections of the pilot test area are described in Section 5.0 below.

Depth to depth to groundwater across the entire ETYA ranges from approximately 6 to 31 feet below grade. In the pilot test area, the depth to groundwater ranges from approximately 24 to 31 feet below grade. The influence of the eastern leg of the WPS can be seen in monitoring wells in the STYA and the southwest portion of the ETYA. A groundwater divide, caused by the operation of the eastern leg of the WPS, exists in the southwestern portion of the ETYA. The

groundwater flow direction east of the divide is generally southeast toward the Buffalo River. The groundwater flow direction west of the divide, in the southwestern portion of the ETYA, is generally west toward the WPS.

3.4 Environmental Quality

The following sections present a brief summary of the data generated during prior investigations regarding the occurrence of separate-phase product, soil, sediment and groundwater quality in the ETYA.

3.4.1 Separate-Phase Product

The historical and current extent of separate-phase product within monitoring wells is shown on Plate 1 south of Tank 176. The results of the long term gauging program from June 2003 through June 2004 for wells in the ETYA are shown in Table 3. Hydrographs showing water-table elevation and thickness of product with time, as well as thickness of product and gallons of product bailed with time, for selected wells with separate-phase product in the ETYA (LF-1S, LF-3, LF-6, MW-28, VERMW-3 and VERMW-4) are presented in Appendix A. Separate-phase product has not been recorded in MW-3URS since July 1998, however, historical data indicates that product was present at this location. In addition to existing wells that currently have measurable separate-phase product present, separate-phase product (light golden colored product that could be squeezed out of the recovered soil) was noted at or near the water table interface during the completion of borings/wells SB-82 and SB-84 during December 2000. However, none of the wells installed in December 2000 have indicated the presence of measurable separate-phase product during ongoing water/product level gauging and/or groundwater sampling. In addition, no volatile organic compounds (VOCs) or semivolatile organic compounds (SVOCs) were detected in the groundwater samples collected from these wells in January 2001. Above the water table, heavier black product (still capable of being squeezed from the recovered soil) was observed at SB-82 (7 to 9 feet below land surface[bls]) and SB-84 (5 to 9 ft bls). Finally, thick black tar-like material, which was relatively solid, was observed above the water table at SB-79 (5 to 7 ft bls), SB-80 (7 to 9 ft bls), SB-81 (15-17 ft bls), SB-82 (11 to 11.5, 15 to 17 and 18.5 to 19 ft bls) and SB-85 (5 to 7 ft bls).

Samples of separate-phase product were collected and analyzed from four wells in this portion of the ETYA (P-15, MW-3URS, LF-1S and MW-28). Appendix B presents the results of the laboratory analyses performed on these samples. The results from MW-28 and LF-1S indicate that the separate-phase product at these locations is comprised entirely of severely biodegraded diesel fuels. The results from P-15 indicate that the product is comprised of 80 percent diesel range hydrocarbons and 20 percent gasoline range hydrocarbons. Finally, the results from MW-3URS, in which separate-phase product has not been observed since 1998, indicate that the product was comprised of 85 percent diesel range organics and 15 percent gasoline range organics.

Long-term product recovery since 2001 is described in Section 5.0.

3.4.2 Soil Quality

The summary of soil quality includes comparisons of the Site data collected to the NYSDEC soil quality criteria, described below.

Soil Quality Criteria

Soil quality data from previous investigations has been compared to NYSDEC soil quality criteria. This type of comparison enables identification of areas that may pose a potential risk under a residential land use scenario, as well as those areas that may have potential to impact groundwater at concentrations exceeding drinking water standards. The soil quality data generated during previous investigations have been evaluated against the criteria presented in the following NYSDEC documents:

- NYSDEC Recommended Soil Cleanup Objectives (RSCOs) presented in the “Division of Hazardous Waste Remediation. Division Technical and Administrative Guidance Memorandum (TAGM) 4046: Determination of Soil Cleanup Objectives and Cleanup Levels” (NYSDEC 1994).
- NYSDEC revised soil cleanup criteria tables for TAGM 4046 for gasoline and fuel oil contaminated soil dated August 22, 2001 (NYSDEC 2001).

The samples collected during the previous investigations in the ETYA indicate that several VOCs, SVOCs and metals exceeded NYSDEC RSCOs. In general, the results of previous investigations indicate that soil quality in the ETYA has been impacted by historical activities.

Impacts due to diesel range constituents (SVOCs and total petroleum hydrocarbons-diesel range organics [TPH-DRO]) are more widespread with generally higher concentrations and concentrations of more compounds exceeding RSCOs than impacts due to gasoline constituents (VOCs and TPH-gasoline range organics [TPH-GRO]). Limited impacts due to gasoline range constituents were observed within the product plume and in the west/southwest portion of the ETYA.

3.4.3 Sediment Quality

Sediment quality data collected from the area adjacent to the ETYA during previous investigations have indicated the presence of VOCs, SVOCs and metals.

The results of a Phase II investigation of the ETYA (formerly referred to as the Buffalo Terminal Disposal Site) conducted in 1985 (URS, 1986) indicated that the sediment adjacent the ETYA was impacted by metals, VOCs and SVOCs. The locations of the two sediment samples collected during the Phase II investigation are shown on Plate 1. The investigation concluded that the impact to sediment could, at least in part, be attributed to non-ExxonMobil source(s). As a result of the Phase II investigation and additional sampling, the NYSDEC concluded that the Buffalo Terminal Disposal Site does not present a significant threat to human health and environment.

In addition, on a regional scale, historical sediment quality data was collected and evaluated by the United States Environmental Protection Agency (USEPA) during the period of 1981-1994 as part of several studies. This data indicates that the sediment both upstream and downstream from the Terminal is impacted by industrial activities. The impact upstream was demonstrated to be as great or greater than that found adjacent to the Terminal (USEPA 1984 and 1994).

The analytical results from sediment samples collected from the Buffalo River shoreline in April 2001 confirm field observations of petroleum-related impacts made during the October 2000 shoreline inspection and during the April 2001 sediment sampling program. Where odor, staining, sheen and/or separate-phase product were observed, the analytical results indicated the presence of petroleum-related constituents.

Laboratory results indicate that sediment quality in the 1,000-foot segment of Buffalo River shoreline inspected in October 2000 has been impacted by diesel range and gasoline range constituents. Impacts related to diesel fuel constituents (SVOCs and TPH-DRO) are more widespread with higher concentrations than impacts due to gasoline constituents (VOCs and TPH-GRO). This information is consistent with the analytical results of product samples collected from ETYA wells that indicate the product is primarily comprised of diesel fuel and diesel range hydrocarbons. The highest impacts from gasoline constituents were observed within the boomed areas at locations where product/iron staining and/or product seepage were observed during the October 2000 inspection of the shoreline and during the April 2001 sampling program.

The distribution of petroleum-related impacts along the shoreline is consistent with the possibility that impacts may be transported along the riverbank by the actions of currents and wind in either direction.

3.4.4 Groundwater Quality

The summary of groundwater quality include comparisons of the Site data collected to the NYSDEC groundwater criteria, described below.

Groundwater Criteria

In the discussions of previous investigations that follow, the groundwater data collected during these investigations is compared to the NYSDEC Ambient Water Quality Standards and Guidance values (AWQSGVs) for Class GA groundwater presented in the Division of Water Technical and Operational Guidance Series (TOGS 1.1.1) "Ambient Water Quality Standards and Guidance Values and Groundwater Effluent Limitations" (NYSDEC, 1998) as amended in April 2000.

Many wells in the ETYA have been sampled during the previous investigations and the quarterly groundwater sampling rounds conducted since January 2001. The results of the groundwater sampling confirmed the conclusions drawn from previous investigations, that concentrations of VOCs and SVOCs in groundwater are generally low in the ETYA and that NYSDEC AWQSGVs are exceeded only in localized areas (in the southwest portion of the ETYA and in the vicinity of

the separate-phase product plume). Metals concentrations exceeding AWQSGVs were distributed throughout the area.

3.4.5 Field Observations Along the Buffalo River Bank Adjacent to the ETYA

On October 26, 2000, representatives from ExxonMobil, NYSDEC and Roux Associates inspected the Buffalo River shoreline for evidence of sheen and product seepage. Approximately 1,000 feet of shoreline was inspected, as indicated on Plate 1 (the width of the shoreline area inspected is exaggerated for clarity). Plate 1 shows the locations of sorbent booms that are maintained daily by ExxonMobil. The following observations were made during the inspection. The locations of the items listed below are shown on Plate 1.

- The area where product seepage and the greatest product/iron staining was observed along the river bank is shown within the limits of the northeastern boomed area. The product seepage was observed just above the river level on October 26, 2000 (570.76 feet above mean sea level [amsl]) and the product/iron staining extended two to five feet into the river.
- Two areas where significant product/iron staining and sheen were observed and are shown within the southwestern boomed area. The product/iron staining extended several feet into the river.
- Two areas where product staining was observed within the embankment adjacent to the river are shown near the northeast boomed area. These areas were observed at an approximate elevation of 573 feet amsl to 574 feet amsl (approximately 2 to 3 feet above the river level on October 26, 2000).
- Three areas adjacent to the Buffalo River bank where an asphalt material was observed within the embankment are shown. The asphalt material was observed at an elevation of approximately 577 to 578 feet amsl (approximately 6 to 7 feet above the river level on October 26, 2000).
- An area where an asphalt/tar-like material was observed on the ground surface is shown to the northeast of monitoring well MW-4URS.
- An area where drum remnants were observed within the embankment is shown. The drum remnants were observed at an approximate elevation of 581 to 586 feet amsl (approximately 10 to 15 feet above the river level).

On June 4, 2003, the shoreline of the Buffalo River was inspected by the NYSDEC. Areas of sheen were observed outside the currently boomed areas to the south and west of the southernmost boom. Boom placement in these areas is discussed in Section 2.5.3.

The shoreline continues to be inspected regularly. The results of the inspections for the latest quarterly inspection (second quarter of 2003) are summarized below. Depending upon the conditions of wind, flow in the river and elevation of the river, the presence and appearance of sheen within and outside the two boomed areas adjacent to the ETYA changes frequently.

- When present, sheen was generally observed within the two boomed areas.

Sheen was observed outside the containment boom (s) on the following dates:

- On April 23, 2003, sheen was observed between the northern and southern containment booms. On May 27, 2003, spots of sheen were observed outside the booms along the Buffalo River.
- On May 28, 2003, light sheen was observed outside the southern containment boom.
- On June 5 and 10, 2003 sheen was observed outside the southern containment boom.
- On June 19 and 20, 2003, sheen was observed in various locations as the new southern boom was being pulled and replaced.

4.0 REMEDIAL GOALS, SCGS AND REMEDIAL ACTION OBJECTIVES

This section describes the remedial goals and remedial action objectives (RAOs) for the proposed remediation of the separate-phase product plume in the ETYA located south of Tank 176 as an IRM. Also included is a description of applicable Standards, Criteria and Guidance applicable to the remediation.

4.1 Remedial Goals

As described in the DER-10, the remedial goal of an IRM for this portion of the Site will be the restoration of the target area (separate-phase product plume area) to pre-disposal/pre-release conditions, to the extent feasible. The proposed remedy will eliminate or mitigate significant threats to public health and the environment presented by the contaminants within the target area of the ETYA. The remedial goal also includes removing the source of contamination in the target area (i.e., the separate-phase product) to the extent feasible.

4.2 Standards, Criteria and Guidance

SCGs are promulgated requirements (“standards” and “criteria”) and non-promulgated guidance (“guidance”) that govern activities that may affect the environment and are used by the DER at various stages in the investigation and remediation of a site. SCGs incorporate both the Comprehensive Environmental Response, Compensation, and Liability Act of 1980, as amended by Superfund Amendments and Reauthorization Act of 1986 (CERCLA) concept of “applicable or relevant and appropriate requirements” (ARARs) and EPA’s “to be considered” (TBCs) category of non-enforceable criteria or guidance. SCGs applicable to the target area in the ETYA are as follows:

Citation	Title	Regulatory Agency
Soil		
TAGM-4046	Determination of Soil Cleanup Objectives and Cleanup Levels	NYSDEC
Ground Water/ Surface Water		
40 CFR Part 131	Water Quality Criteria	EPA
40 CFR Part 141.11-16	Maximum Contaminant Levels	EPA
40 CFR Part 141.50-52	Maximum Contaminant Level Goals	EPA

Citation	Title	Regulatory Agency
6 New York Code of Rules and Regulations (NYCRR) Part 608	Use and Protection of Waters	NYSDEC
6 NYCRR Part 700-705	Surface Water and Ground Water Classification Standards	NYSDEC
Technical Operational Guidance Series (TOGS) 1.1.1	Ambient Water Quality Standards and Guidance Values	NYSDEC
Air		
40 CFR Part 50	National Ambient Air Quality Standards	EPA
40 CFR Part 60	Standards for Performance of New Stationary Sources	EPA
40 CFR Part 61	National Emissions Standards for Hazardous Air Pollutants	EPA
Air Guide No. 1	Guideline for the Control of Toxic Ambient Air Contaminants	NYSDEC
6 NYCRR Part 212	General Process Emission Sources	NYSDEC
6 NYCRR Part 257	Air Quality Standards	NYSDEC

4.3 Remedial Action Objectives

The RAOs for the ETYA separate-phase product plume area have been established for the protection of public health and the environment and are developed based on the SCGs, described above.

As specified in Draft DER-10, Section 4.1(c), remedial action objectives (RAOs) are to be established by:

1. identifying all contaminants exceeding applicable SCGs and the environmental media impacted by the contaminants;
2. identifying applicable SCGs taking into consideration the current and, where applicable, future land use for the Site;
3. identifying all actual or potential public health and/or environmental exposures resulting from contaminants in environmental media at, or impacted by, the Site; and
4. identifying any site-specific cleanup levels developed pursuant to Draft DER-10, Section 3.10.3(e).

The prior Site investigations have identified the contaminants exceeding RSCOs and Class GA AWQSG values and environmental media impacted by the contaminants. It is understood that

NYSDEC is in the process of developing additional generic soil standards that will be applicable to sites where the current and reasonably anticipated future land will be commercial or industrial. Therefore, given the current and anticipated land use at the Site, ExxonMobil will re-evaluate the existing soil quality data relative to these new standards once they have been developed.

As outlined in DER-10, Appendix 4B, the primary RAO for public health protection at the Site is to eliminate potential exposure pathways by preventing humans from contacting, ingesting or inhaling contaminated environmental media. In addition, the following RAOs will be applicable to the ETYA IRM for environmental protection:

- removal of the source of groundwater or surface water contamination, including free product and grossly contaminated soil, to the extent technically and practicably feasible;
- preventing migration of contamination that would result in groundwater, surface water or sediment contamination; and
- preventing impacts to biota from ingestion/direct contact with surface water and sediments causing toxicity and impacts from bioaccumulation through the marine or aquatic food chain.

5.0 FIELD TESTS OF POTENTIAL TECHNOLOGIES

The following section describes the field tests that were performed in the ETYA in order to evaluate potential remedial technologies. Four technologies were field-tested in the target area:

- Long-term separate-phase product-only recovery testing.
- Aquifer testing of groundwater recovery for containing and recovering groundwater, controlling the migration of separate-phase product and enhancing separate-phase product recovery
- VER pilot testing
- ChemOx pilot testing

The results of the on-going product recovery testing and the aquifer testing for groundwater recovery are discussed briefly below. The procedures and results of the VER and ChemOx pilot tests are described in detail below.

5.1 Long Term Product-Only Recovery Testing

Separate-phase product recovery is ongoing in the ETYA. Product recovery efforts in the ETYA have included automated product recovery using a solar powered product only pumping system and manual bailing. Product recovery from selected wells has been conducted in order to provide additional data on the recoverability of product and evaluate the appropriateness of the technology for the target area. Between February 2000 and June 2004, approximately 227 gallons of separate-phase product have been recovered from wells in the ETYA (81 gallons of that amount was recovered during the ChemOx pilot test study from monitoring wells MW-28 (32 gallons from the solar powered pump), LF-6 (13 gallons from manual bailing), LF-1S (5 gallons from manual bailing) and the newly installed well VERMW-3 (31 gallons from manual bailing). Manual bailing of product was initiated in February 2000. Approximately 55 gallons of product have been manually bailed from ETYA wells (LF-1S, LF-3, LF-6, MW-28 and P-15) between February 2000 and June 2004. In addition, 49 gallons of product have been recovered from LF-6, LF-1S and VERMW-3 during the ChemOx pilot study between April and June 2004 as described above. The solar powered product only pump has been operated in MW-28 since April 2001, except from July 17 through August 6, 2002, when it was moved to LF-6. A total of 123 gallons of separate phase product have been recovered using the solar powered product only pumping system through June 2004 (119 gallons from MW-28 and 4 gallons from LF-6).

Though included in the totals above, separate-phase product recovery related to the VER and ChemOx pilot tests is described below.

5.2 Aquifer Testing of Groundwater Recovery for Containment and Product Recovery Enhancement

The purpose of the evaluation of aquifer characteristics was to develop the data necessary to determine if groundwater pumping in the ETYA would be capable of protecting the Buffalo River by containing and recovering groundwater, controlling the migration of separate-phase product and enhancing separate-phase product recovery.

The field activities performed at the ETYA to accomplish the objectives for the evaluation of aquifer characteristics, included the following:

- Installed one test borehole (TB-3);
- Performed sieve analyses for soil samples collected during the installation of the test borehole;
- Collected Shelby tubes of soil samples collected during the installation of the test borehole;
- Installed and developed one recovery well (RW-8 subsequently replaced by RW-8R);
- Collected fluid elevation measurements in existing and newly-installed wells over a period of time to determine static conditions;
- Performed step-drawdown tests (RW-8 and RW-8R); and
- Performed constant-rate pumping tests (RW-8 and RW-8R).

Monitoring well data from the RW-8R pump test were not analyzable due to hydraulic interference from the Buffalo River. However, the early-time data from the recovery well RW-8R was analyzed to estimate hydraulic conductivity in the ETYA, as discussed below.

5.2.1 RW-8R Pump Test Results

RW-8R was pumped for approximately 10.3 hours at an average rate of 11.0 gallons per minute (gpm). The maximum drawdown observed in the pumping well was 10.35 feet. Due to the lack of a barrier between the groundwater and surface water (i.e., bulkhead), the hydraulic influence of the Buffalo River in the ETYA masked any drawdown effects in the monitoring wells from the

pumping at RW-8R. However, early drawdown data from the pumping well were not affected by fluctuations in the Buffalo River. Once drawdown in the pumping well stabilized (after 35 minutes), the influence of the Buffalo River was evident. Based on the analysis of the early drawdown data in RW-8R, the hydraulic conductivity was estimated to be approximately 7.7 feet per day (ft/d); consistent with the silty matrix encountered during drilling in the ETYA.

5.2.2 ETYA Separate-Phase Product Volume Estimate

Roux Associates performed the multi-phase modeling task using BIOSLURP™ (Resource & Systems International, 2002). The horizontal and vertical extents of the ETYA plume determined during this and past investigations were used to provide the basis for creation of a multi-phase flow model of the plume.

BIOSLURP™ is a two-dimensional (2-D) finite-element computer model that can simulate three-phase (water, oil, and gas) flow and multi-dissolved phase transport in groundwater. BIOSLURP™ can be used to simulate the extent of separate-phase product and dissolved phases in groundwater, and vapor phases in soil gas. The initial separate-phase plume volume for the ETYA plume was estimated from the multi-phase model as follows:

Once the multi-phase model was considered calibrated and sensitivity analyses were performed on the model input parameters, it was run to determine the volume of product within the ETYA plume. Using static monitoring well gauging data as the initial conditions for the model, the total volume of free-product was determined to be approximately 1,900 gallons within the ETYA plume. This volume is based upon average fluid properties from the samples collected from various locations within the plume.

5.3 VER and ChemOx Pilot Test Objectives

The objectives of the pilot testing were to evaluate VER and ChemOx and determine what technology may be the most appropriate remedial option for the separate-phase product plume in the ETYA. The results of the pilot testing have been used to evaluate VER and ChemOx in accordance with Section 4 of the Draft DER-10 Technical Guidance, select the remedy for the site and develop an appropriate site-specific design to be used for full scale implementation of the selected technology, as discussed further in Section 6.0.

The VER Work Plan and ChemOx Work Plan detail the technologies used, pilot test objectives and data to be collected.

5.3.1 Health and Safety/Contingency Plan

GES has prepared a site-specific health and safety plan (HASP) for work to be completed at the ExxonMobil Buffalo Terminal. The HASP was reviewed and signed by all GES personnel and others performing work at the site. All GES personnel and subcontractors have successfully completed 40-hour OSHA and annual 8-hour refresher training in accordance with 29 CFR 1910.120. A copy of the HASP was present during all on-site activities. All pilot test activities were conducted in accordance with the HASP. In addition, prior to initiating field activities, GES held health and safety review meetings to discuss planned activities and health and safety requirements.

5.4 Vacuum Enhanced Extraction Pilot Test

The following describes the objectives for the VER pilot test conducted in the ETYA, provides a description of the VER technology, describes the procedures and provides the results of the VER pilot test for the ETYA.

The key design parameters evaluated through the performance of pilot test included:

- effective radius of influence (EROI),
- effective vacuums;
- effective drop-tube depths to recover product and minimize groundwater extraction;
- extraction rates for product, water and vapor; and
- concentrations of constituents of concern in extracted water and vapor.

5.4.2 Overview of VER as a Remedial Technology

Vacuum-enhanced product recovery involves applying a vacuum to a recovery well to extract product in the liquid and vapor phase, along with relatively low quantities of groundwater, through a common “drop tube” (with variable depth) installed in the recovery well. The depth to water in the pilot test area ranges from approximately 24 to 31 feet below land surface. The practical limit for lifting water/product from a recovery well using a vacuum pump is

approximately 25 feet. Therefore, the pilot area is near or above this practical limit if the goal of the system were to extract groundwater/product only. However, the combination of water/product entrained with air can be lifted from deeper depths. The pilot test determined the feasibility of this approach for the target area in the ETYA, as described below. In addition to the active recovery process described above, VER increases the airflow through the soil, which, in turn, stimulates aerobic biodegradation processes to remediate residual materials in the unsaturated zone. The application of this technology in this area of the site is also complicated by the fact that the water table has been observed to fluctuate throughout the day, in response to fluctuations in the Buffalo River. The magnitude of the fluctuations is up to half a foot in monitoring wells in the target area.

5.4.3 Pilot-Scale VER System

The pilot test activities were performed using the Groundwater and Environmental Services, Inc. (GES) Data Acquisition and Processing Laboratory (DAPL). The DAPL unit is a self-contained platform that provides computerized on-site real-time data acquisition and processing evaluation. The DAPL unit is fully equipped with pumps, sensors, and hardware needed to perform soil vapor extraction, total phase extraction, air sparging, and various groundwater and free-product recovery tests. Onboard sensors monitor and continuously log all system operating conditions and field responses, including vacuum/pressure responses, vapor and liquid flow rates, and groundwater levels. The onboard computer manages and integrates the incoming data and performs real-time calculations and analyses to allow for immediate evaluation of test conditions. This allowed for flexibility in customizing the test to site conditions. The pilot-scale VER system consists of extraction pipe and hose; vacuum, pressure, temperature and flow indicators; rotary vane vacuum pump; an oil/water separator. Recovered groundwater was transferred from the oil/water separator to a water collection drum, then pumped to a frac tank for temporary containment and finally transferred from the frac tank to the on-site water treatment system prior to discharge. Separate-phase product was not extracted during the pilot test.

A 5 horsepower Rietschle VFT-100 rotary vane vacuum pump was used to extract separate-phase product, groundwater and soil gas. The vacuum was applied to the well using a PVC drop tube. The test well was sealed using a compression well seal. The vacuum pump operated at a

minimum air flow rate of 20 standard cubic feet per minute (scfm) at a vacuum of approximately 25.5 inches of mercury.

The extracted soil vapor was discharged through the vapor discharge stack. A process and instrumentation diagram of the pilot system is presented in Figure 4. Flow, vacuum, temperature and pressure gauges were used to monitor flow rates and system performance during the testing.

5.4.4 VER Pilot Test Well and Monitoring Wells

In order to develop the necessary data to evaluate VER, a network of wells were used, consisting of a pilot test well and groundwater/vapor monitoring wells.

5.4.4.1 Pilot Test Wells

For the selection of the pilot test well location in the target area, the preference was made for an existing monitoring well, LF-6, since its location and free product accumulation was representative of the target area as a whole. LF-6 was selected based on the significant thickness of free product historically present in the well, in addition to suitable well construction. The well is constructed of 4-inch diameter, 20 slot, polyvinyl chloride (PVC) screen extending from 16 to 36 feet below land surface.

In addition to testing at LF-6, short term testing occurred at VERMW-2 and LF-3. The testing was used to support or negate the data collected at LF-6. A copy of the well logs for wells in the pilot test area is provided in Appendix C.

Prior to initiating pilot testing activities, LF-6 was re-developed to ensure hydraulic connection with the surrounding aquifer. The well was developed by surging and pumping until the monitoring well produced sediment-clear water, to the extent possible, and a good hydraulic connection was established between the well screen and the aquifer. Well development water was transferred to the onsite water treatment system for treatment prior to discharge.

The well head was temporarily modified (from conventional monitoring well construction) prior to testing. The modifications included the installation of a well seal and a 1.5-inch diameter variable depth drop tube. A detail of the VER test well is shown in Figure 5.

5.4.4.2 Monitoring Wells

The monitoring network inside and outside the 40 foot x 40 foot pilot test area for the VER pilot testing was comprised of a combination of five existing monitoring wells and four newly installed 2-inch diameter wells that surround the test well in various directions in order to access the homogeneity of the subsurface. The monitoring well network is shown on Plate 1. The existing wells were used surrounding the pilot test well at distances ranging from 43 and 60 feet. The existing wells that were used include RW-8R (43 feet from LF-6), LF-1S (57 feet from LF-6), MW-3URS (45 feet from LF-6), MW-28 (45 feet from LF-6) and LF-3 (57 feet from LF-6). Four, two-inch PVC groundwater/vapor monitoring wells were installed closer to the pilot test well on October 8 and 9, 2003. Two of the monitoring wells (VERMW-1 and VERMW-2) were installed in a straight line between the pilot test well and RW-8R spaced at 20 and 10-foot intervals from the test well, respectively. The third 2-inch monitoring well (VERMW-3) was located between the pilot test well and MW-28, approximately 10 feet from the test well. The fourth 2-inch monitoring well (VERMW-4) was located approximately 15 feet to the northwest of the test well. This monitoring well network enabled assessment of the subsurface vacuum response, groundwater elevation changes and free product thickness changes during the pilot test. Logs for the newly installed and existing wells are included in Appendix C.

The 2-inch monitoring wells were installed using a hollow stem auger rig. In accordance with ExxonMobil ground disturbance protocols, the 0 to 5 foot interval was cleared using a hand auger and post hole digger. Soil samples were collected continuously from 15 feet below grade to the bottom of the boring, approximately 35 ft bls. The supervising technical staff inspected soil samples and recorded applicable lithologic characteristics. In addition, all soil samples were visually inspected for evidence of separate-phase product (i.e., separate-phase product sheen, odors, staining, etc.) and screened for organic vapors with a PID.

Each well consisted of 20-slot screen extending from five feet above the water table to 15 feet below the water table. The annular space between the well and borehole was filled with #1 sand to 1 foot above the top of the screen and a two-foot bentonite seal was placed above the sand pack. The remainder of the annulus was grouted within 2 feet of land surface and finished with a concrete cap. The concrete cap was sloped to divert precipitation away from the well. Each

monitoring well was finished approximately 2 feet above grade and fitted with a 5 foot steel casing.

Following installation, each new well was developed to ensure hydraulic connection with the surrounding aquifer. The wells were developed by surging and pumping until each monitoring well produced sediment-clear water, to the extent possible, and a good hydraulic connection was established between the well screen and the aquifer. Well development water was transferred to the onsite water treatment system for treatment prior to discharge.

Each well was surveyed for horizontal and vertical coordinates relative to the New York State Plane Coordinate System by a surveyor licensed in the State of New York after completion. Both ground surface and top of casing (i.e., measuring point) elevations were determined for each well. Horizontal coordinates were accurate to ± 0.1 feet and vertical coordinates were accurate to ± 0.01 feet.

All of the monitoring wells were fitted with a removable expansion plug to allow water level and free product thickness measurements, and valve to allow pressure response to be measured with a hand-held Magnehelic gauge. Continuous-logging pressure transducers were installed in monitoring wells VERMW-1 thru VERMW-4, MW-28, and MW3-URS to monitor water levels. Product thickness in monitoring wells with transducers installed was gauged manually. Manual water and product level measurements were also made in the monitoring wells LF-1S, LF-3 and RW-8R. A schematic of a typical monitoring well is shown in Figure 5.

A data logger was also installed in the Buffalo River to record river level fluctuations since the river has been observed in previous investigations to fluctuate on the order of 2 feet during the course of the day. A cyclical pattern to the river level fluctuations has also been observed, however the cause of the cyclical pattern was not determined. However, due to a malfunction of the data logger in the river, the data obtained was not usable.

5.4.5 Implementation of the Pilot Study

The VER pilot study was implemented as follows:

- installed electrical power to the pilot test area;

- installed two-inch monitoring wells and modified existing wells;
- completed system setup and conducted pre-pilot baseline testing at the pilot test well and monitoring wells;
- conducted a short duration (1 to 2 hours per test configuration) VER pilot testing to determine optimum operating parameters; and
- conducted an extended VER pilot test.

The VER pilot test was conducted to evaluate subsurface flow characteristics, evaluate pneumatic performance of VER and evaluate free product levels and recovery.

To assist in this evaluation, several measurements were recorded during the pilot study and compared to pre-pilot baseline testing measurements. The following pre-pilot baseline testing measurements were recorded before the testing was begun:

- static vacuum pressure readings at the pilot test well and monitoring wells;
- Buffalo River water levels; and
- water level and free-product thickness measurements at the pilot test well and monitoring wells.

During the pilot testing, the following system operating parameters were recorded in addition to the above items:

- total air flow rate at the rotary vane pump;
- temperature and pressure at the rotary vane pump;
- free product recovery in the free product holding tank;
- water flow at the oil/water separator transfer pump;
- effluent air concentrations using a flame ionization detector (FID);
- applied vacuum at the vacuum pump, pilot test well and monitoring wells;
- Buffalo River water levels; and
- water level and free-product thickness measurements in the monitoring wells.

5.4.5.1 Short Duration Testing

The first and second days of the pilot testing was used to perform several short duration tests at LF-6, LF-3 and VERMW-2 to determine the optimum system configuration for the extended duration testing. Following collection of the pre-pilot baseline testing, short duration testing included the following:

- Operation with the drop tube set just above the static free product/water interface.
- Operation with drop tube set higher above the static free product/water interface.
- Operation with the drop tube set below the free product/water interface.
- Operation at a nominal vacuum and flow rate sufficient to recover liquids (free product and water) from the well.
- Operation at the maximum vacuum/flow rate the well can yield (if different from the initial setting).
- Testing the system with a submersible groundwater recovery pump operating at low flow rates to create a localized cone of depression to assist in drawing product toward the well.

Each system configuration was operated for approximately 1-2 hours, or until steady state conditions were obtained. Water level and vacuum response measurements were collected by the data logger at the monitoring wells to monitor changes in conditions during testing. Manual measurements of water level and separate-phase product thickness were collected at selected wells during the testing. The results of the short duration testing were evaluated in the field to determine any changes to operating parameters or system configuration that may be required. The extended duration test was initiated immediately following the completion of the short duration testing and evaluation of results.

5.4.5.2 Extended Duration Testing

Immediately following the completion of the short duration testing, the system was operated at LF-6 continuously in the optimal testing configuration for a one-day period.

Upon initiation of the extended duration testing, water level, vacuum response and free product thickness measurements were collected at the monitoring wells to monitor changes in conditions during testing. In addition, system operating parameters were also recorded at this same interval. An effluent extracted vapor sample was collected concurrently and analyzed for benzene,

toluene, ethylbenzene and xylenes (BTEX), methyl tertiary butyl ether (MTBE) and TPH Fraction (C1-C4, C5-C10) by USEPA Method TO-3. The results are presented in Table 4. At the end of the long term test, a sample of the effluent groundwater was collected and analyzed for:

- NYSDEC STARS Memo #1 VOCs by USEPA Method 8260 (due to laboratory capacity limitation at the time of sampling, Method 8260 was run in lieu of Method 8021 described in the work plan);
- NYSDEC STARS Memo #1 SVOCs by USEPA Method 8270;
- lead, ferrous iron, manganese, magnesium and calcium by USEPA Method 6010;
- total Suspended Solids by USEPA Method 160.2;
- total dissolved solids
- total organic carbon by USEPA Method 415.1;
- oil and grease by USEPA Method 1664;
- total hardness;
- alkalinity by USEPA Method 310.1; and
- pH using a field meter.

The results are presented in Table 5.

5.4.6 Results and Data Evaluation

Data collected by the DAPL unit data loggers, as well as data collected manually during the pilot test, are presented in Appendix D. Also included in Appendix D are graphs of the pressure and water level data collected by the data loggers (changes in test conditions are noted on each graph). Graphs of water table and product thickness data collected manually during the pilot test.

5.4.6.1 Pilot Test Results

The short-term pilot test was completed on October 21 and 22, 2003 at LF-6, VERMW-2 and LF-3.

Day 1 Short Term LF-6 Pilot Test (Test 1)

The initial test started at LF-6 on October 21, 2003. All measurements are based upon data collected from the data logger, or other calibrated field instruments.

Prior to startup, the well seal adapter, pressure transducer and drop tube were installed in LF-6. The vacuum hose was connected from the inlet of the blower manifold to the well seal adapter. The initial drop tube depth was set 2 inches above the water table interface. The rotary vane vacuum pump was warmed up, and a measurement of 19 inches of mercury (inches Hg) was reached at the blower inlet. The vacuum applied to the drop tube (straw vacuum) reached 3.69 inches Hg. The drop tube was lowered below the initial water table by 0.5 ft, (26.65 ft below top of casing [TOC]) and approximately 13 inches Hg was maintained at the drop tube for 15 minutes. Vacuum at the wellhead was maintained at about 0.26 inches Hg. Vacuum responses of 0.05 and 0.12 inches of water were observed at VERMW-3 and VERMW-4, respectively. No other relevant vacuum or groundwater elevation changes occurred at any monitoring well. No measurable volume of groundwater or product was extracted during the 15minute test. The drop tube was then removed and vacuum was applied directly to the wellhead. Vacuum at the wellhead was maintained at about 3.00 inches Hg.

Day 1 Short Term VERMW-2 and LF-3 Wellhead Tests (Test 1)

The well seal adapter was removed from LF-6, and moved to VERMW-2. The wellhead was tested to determine if vacuum could be maintained, maximum achievable vacuum was 3.10 inches Hg. The testing setup was then moved to LF-3 to check wellhead vacuum. The wellhead vacuum was tested, and a vacuum of 13.80 inches Hg was maintained on the wellhead. No relevant vacuum or groundwater elevation changes occurred at any monitoring well. No measurable volume of groundwater or product was extracted during the tests.

Day 1 Short Term LF-6 and LF-3 VER Test with Packer

Based upon the observations made during the first attempt to test LF-6, the well casing of LF-6 was resealed with bentonite and packer was added to the drop tube, to reduce the chance of short-circuiting through the sand pack. The drop tube was installed at the water table interface and packer was installed at 20 ft below TOC, to maximize the vacuum within the well screen. An average vacuum of 14.10 inches Hg could be reached at the drop tube. The average vacuum on the wellhead was 0.30 inches of water. No relevant vacuum or groundwater elevation changes occurred at any monitoring well. No measurable volume of groundwater or product was recovered during the 70-minute test.

The test was moved to LF-3, with the drop tube and packer setup. LF-3 was comparable to LF-6 since it contained product, is a 4-inch diameter well and screen interval was similar. The drop tube was installed at the water table interface (26.11 ft below TOC) and packer was installed at approximately 20 ft below TOC (28.8 ft from top of adapter) in order to maximize the vacuum within the well screen. After 20 minutes of operation the drop tube was raised 3.5 ft from the original level. The vacuum at the drop tube ranged from less than 1.0 inch Hg to 13.8 inches Hg. The wellhead vacuum also varied, with vacuum ranging from 0.35 inches Hg to 5.76 inches Hg. The range in vacuum is attributed to the extraction of groundwater. Higher vacuums at the drop tube indicated active groundwater recovery, lower vacuum indicated vapor recovery only. The vacuum fluctuation occurred only once during a short period of time and did not appear to be related to change in drop tube depth. No relevant vacuum or groundwater elevation changes occurred at the monitoring wells. A total of 15 gallons of water and no measurable volume of product were recovered during the 60 minute test.

Day 2 Short Term LF-6 Test with Packer (Test 2)

Testing was conducted at LF-6 with the drop tube set 1.11 ft above the water table (26.04 below TOC) on October 22, 2003. A maximum vacuum of 9 inches Hg at the drop tube and 1.61 inches Hg at the wellhead was observed. No relevant vacuum or groundwater elevation changes occurred at any monitoring well. A total of 213 gallons of water was recovered and no measurable volume of product was recovered during the 110-minute test. The approximate air flow rate was 35 scfm and FID response was 3,000 parts per million (ppm) at the discharge outlet.

The drop tube was raised 0.5 ft without any change in vacuum. Groundwater extraction rate appeared to be reduced. The drop tube was raised again 0.5 ft. No relevant vacuum or groundwater elevation changes occurred at any monitoring well. A total of 80 gallons of water and no measurable volume of product was recovered during the 130-minute test. The air flow rate ranged from 38 to 42 scfm and FID response ranged from 3,000 to 4,000 ppm at the discharge outlet.

The drop tube was then lowered to the water table interface (27.25 ft below TOC). The vacuum increased to 8 inches Hg at the drop tube and 0.6 inches Hg at the wellhead. No relevant vacuum

or groundwater elevation changes occurred at any monitoring well. A total of 48 gallons of water and no measurable volume of product was recovered during the 45 minute test. The air flow rate was 30 scfm and FID response was 1,100 ppm at the discharge of the outlet.

The drop tube was then lowered 0.5 ft below the water table interface (27.15 ft below TOC). The drop tube and wellhead vacuum remained unchanged. No relevant vacuum or groundwater elevation changes occurred at any monitoring well. There was no measurable volume of groundwater or product recovered during the 15-minute test.

Day 2 Short Term LF-6 Test with Packer and Groundwater Pump

A pneumatic pump was installed in LF-6 with a drop tube on October 22, 2003. The pneumatic pump intake was set at 27 ft below TOC. The drop tube was set at 25.3 ft below TOC. The vacuum was approximately 2.94 inches Hg at the drop tube and 2.10 inches Hg at the wellhead. Nominal vacuum response was noted at VERMW-4 and VERMW-2, at 0.05 inches of water. No relevant groundwater elevation changes occurred at the monitoring wells. Groundwater was pumped at an estimated rate of 5 gpm, with a total of 150 gallon of water recovered. Due to an oversight actual groundwater rate and total was not recorded. There was no measurable volume of product recovered during the 30-minute test.

The pump was removed from the well and the long-term test using VER at LF-6 was initiated.

Day 2 and Day 3 Long Term Test at LF-6 (Test 3)

The long-term VER test was started at LF-6 using a drop tube and packer on October 22, 2003 and continued through October 23, 2003. Groundwater was measured at 27.5 ft below TOC. The drop tube was set at 26 ft below TOC. Static levels were reset for the transducers. Approximately 7 minutes into the test the drop was raised 1 ft to 25 ft below TOC, to minimize recovery of groundwater. Data collected after the first 7 minutes of operation is described herein. The vacuum ranged from 4.0 to 5.6 inches Hg at the drop tube and from 1.3 to 2.10 inches Hg at the wellhead. Vacuum response was noted at VERMW-2 and VERMW-4 at 0.08 inches of water and 0.10 inches of water, respectively. No relevant groundwater level response was observed. The test ran without change to drop tube depth or other adjustments. There was no measurable volume of groundwater or product recovered during the 16 hour test. The air flow rate was

approximately 44 scfm and FID response ranged from 4,100 to 5,300 ppm at the discharge outlet.

5.4.6.2 Data Evaluation

Analytical Results

Vapor sample analysis from the test (Table 4) showed predominant hydrocarbon concentration of C1 through C4. However, low concentrations of Benzene, MTBE and C4-C10 hydrocarbons were also observed in the analysis. All parameters tested met the applicable NYSDEC DAR-1 (NYSDEC July 2000 update) Short Term and Annual Guidance Concentrations (AGC and SGC).

Groundwater was not removed during the long-term test under normal operating condition. The groundwater was removed by lowering the drop tube into the water and sampled in a port located in the water/vapor knock out tank.

Extracted groundwater data (Table 5) showed low concentrations of VOCs. The only SVOCs detected were flourene and phenanthrene.

The analysis of groundwater for metals showed slightly elevated levels of calcium and magnesium and significant levels of ferrous iron. The levels of iron in the groundwater are believed to be significant enough to allow a Fenton's like reaction (an iron catalyzed chemical oxidation reaction with peroxide that generates hydroxyl radicals) to occur upon injection of peroxide into the subsurface, as discussed in Section 5.3. This process, if occurring, would be an additional enhancement to the action of the ozone and peroxide in producing hydroxyl radicals.

Noteworthy results of other analytes indicated elevated level of dissolved solids and low levels of total organic carbon and Oil and Grease.

Data Evaluation - Short Term Tests

The short-term tests were completed to determine the most appropriate vacuum, flow, and drop tube depth at the extraction well in order to recover the highest volume of product and have the greatest effective radius of influence during operation of the long-term test. The vacuum

measured at monitoring wells would denote the ability to effectively draw from an area surrounding the extraction well.

Unfortunately short term testing did not yield any measurable product. Therefore long term testing was based upon ability to create the greatest effective radius of influence by inducing the highest vacuum at wellhead and drop tube of the extraction well.

The operation of the various short term tests indicated that vacuum at the wellhead could not be maintained at LF-6 and VERMW-2. The addition of a packer to the drop tube did not significantly change the observed vacuum. Unlike LF-6 and VERMW-2, the short test at LF-3 indicated that vacuum could be sustained at the wellhead. However, when utilizing a drop tube and packer no additional vacuum could be achieved at the wellhead. LF-6 and LF-3 yielded practically the same vacuum at the wellhead, 0.36 inches Hg compared to 0.56 inches Hg. The vacuum at the drop tube did vary considerably over the various short-term tests, though higher vacuum at the pilot test well can be attributed predominately to groundwater recovery. Sustained higher vacuums at the drop tube indicated active groundwater recovery, lower vacuum indicated vapor recovery only. As the vacuum response was highly variable during the short-term test, no optimum drop tube depth could be determined.

The addition of a groundwater recovery pump at LF-6 yielded slightly better vacuum measurements. The addition of the pump provided a maximum increase of 1.0 inch Hg compared to the pre-pump installation results. Vacuum response was observed at monitoring wells VERMW-2 and VERMW-4 were noted, though at nominal levels. However, the use of a pump to remove water negated the primary benefit of VER. The sustained pumping rate of 5 gpm was too high relative to the potential vacuum enhancement achieved to consider its application feasible and cost effective. Additionally, it is difficult to ascertain if the additional vacuum at the wellhead and pneumatic response at the monitoring wells directly correlate with the use of the pump, since during the long term test at LF-6, similar vacuum response was achieved.

The short term pilot resulted in extraction of a total volume of 506 gallons of groundwater. Hydrocarbon recovery was primary through the vapor phase. There was no separate-phase product recovered during the test.

Data Evaluation - Long Term Pilot Test LF-6

The long-term pilot test at LF-6 showed similar results as the shorter term tests. The vacuum at the wellhead was maintained between 1.5 to 2.0 inches Hg. The vacuum at the drop tube remained level between 5 to 6 inches Hg, indicating recovery of vapor only. The immediate vacuum response at VERMW-2 and VERMW-4, validate a radius of influence of approximately 20 ft. However, the lack of a perceptible rise in the water table at these locations showed the inability of the applied vacuum to bring about a rise in the water table. Separate-phase product thickness did increase at LF-1S and MW-28 during the pilot test. However, it is difficult to determine if these increases were due to the operation of the VER system.

No groundwater or separate-phase product was recovered during the long-term pilot test. Hydrocarbon recovery was primarily through the vapor phase.

It should be noted that during the operation of both the short term and long term tests, the effect of the Buffalo River fluctuations is evident in all graphs of the water level data recorded by the data loggers. The cyclical fluctuations can be seen in all test wells. No relevant groundwater elevation fluctuations could be attributed to the operation of the VER pilot system, unless they were masked by the fluctuations caused by the river. Since the data logger installed in the river malfunctioned, a direct comparison of Buffalo River data to the pilot test data at monitoring wells cannot be made.

5.5 Chemical Oxidation Pilot Test (ChemOx)

The chemical oxidation pilot test event was implemented in the same area as the VER pilot test (Plate 1) from April 7, 2004 (baseline) to June 22, 2004. The following describes the ChemOx technology, and provides the description of procedures and results of the ChemOx pilot test for the ETYA.

5.5.1 Overview Advanced Oxidation System

The chemical oxidation system uses oxygen, air, ozone, and hydrogen peroxide injected into groundwater to break down petroleum compounds into water and carbon dioxide. This advanced oxidation process is routinely used in municipal water supply treatment to treat drinking water prior to distribution.

The advanced oxidation system is a safe and effective remedial approach that can destroy separate-phase product and significantly improve groundwater quality. The ozone and hydrogen peroxide that is injected into the groundwater is quickly broken down to water, oxygen, and carbon dioxide, so there are no harmful effects of the treatment system. Ozone will only be present in groundwater in the close vicinity of each on-site injection point.

Chemical oxidation has been proven to be an effective remedial technology for the oxidation of organic contaminants, including gasoline, diesel, and fuel-related compounds, in subsurface soils and groundwater. Chemical oxidation utilizes ozone, hydrogen peroxide, and hydroxyl radicals (OH•) to effectively and efficiently break down organic contaminants into naturally-occurring compounds. In addition to directly oxidizing organic contaminants, the chemical oxidation system will enhance the aerobic bioremediation process by significantly enhancing dissolved oxygen concentrations in the vicinity of the injection points. Increased dissolved oxygen concentrations will promote bioremediation within the surrounding separate-phase product plume. The in-situ chemical oxidation process is well documented for producing hydroxyl radicals by the reaction of hydrogen peroxide and ferrous iron (known as Fenton's reagent). Based upon the ferrous iron concentrations observed in the extracted water sample collected during the VER pilot test, described above, it is believed that sufficient ferrous iron may be present in the groundwater to produce a Fenton's like reaction with the addition of hydrogen peroxide. This process, if occurring, would be an additional enhancement to the action of the ozone and peroxide in producing hydroxyl radicals.

5.5.2 Ozone and Hydrogen Peroxide

Ozone treatment is used frequently for the disinfection of drinking water and is also becoming the industry standard for disinfecting bottled water. Ozone is a gas with a life in water that lasts only for minutes. Oxygen is converted to ozone through the addition of a third atom. As ozone

passes through groundwater, the third atom detaches and destroys impurities in the water. Some ozone will react with hydrogen peroxide to develop hydroxyl radicals, which quickly break down hydrocarbon compounds in groundwater to water and carbon dioxide.

Since ozone will break down quickly, ozone generated by the on-site remediation equipment is pumped directly into the groundwater. The residue in the water is pure oxygen, which quickly dissipates in a few minutes. Any excess dissolved ozone which is not needed for treatment, reverts to simple oxygen in just minutes. Ozone concentrations decrease significantly by the time the ozone reaches the vadose zone.

Hydrogen peroxide (H_2O_2) is a naturally occurring water-like liquid that has many practical applications both inside and outside the home. Hydrogen peroxide is made up of two hydrogen atoms and two oxygen atoms. It looks like water (H_2O) in appearance, but the extra oxygen molecule makes this natural water additive an effective oxidizer. It is formed in nature by the simple action of sunlight on water. The Material Safety Data Sheet (MSDSs) included in Appendix E provide information regarding the chemical constituents and safety.

The area that was addressed during the pilot test is approximately 40 feet by 40 feet and located within the existing separate-phase product plume (Plate 1) of the ETYA. In the year prior to the pilot testing, separate-phase product thickness in existing well LF-6 ranged from non-detect to 1.77 feet and averaged 0.3 feet. At the pilot test monitoring wells installed in October 2003 (VERMW-1 through VERMW-4), the following separate-phase product observations were made prior to the ChemOx pilot test:

- measurable product was not observed at VERMW-1, 2 or 3, however, a sheen was observed periodically prior to the ChemOx pilot test; and
- at VERMW-4, free product thickness ranged from non-detect to 0.67 feet (during the baseline gauging round on April 7, 2004).

Product thickness changes observed during the pilot test are described below. The gasoline and diesel compounds present in the impacted area have relatively high reaction rate constants with the hydroxyl radical and are readily susceptible to breakdown through this process.

5.5.3 Injection Wells/Monitoring Wells

As part of the chemical oxidation delivery system, injection wells (CO-1 thru CO-5) were installed in the pilot study area (Plate 1). GES contracted SJB Services of Lancaster, NY to install injection wells via a hollow stem auger rig. Each set of injection wells were constructed to deliver the hydrogen peroxide and ozone to the subsurface. In addition, monitoring wells VERMW-1 through VERMW-4, (installed as part of the VER pilot test) were used for monitoring. The monitoring wells were used for monitoring headspace and groundwater during the pilot test. Based on the lithology, nested injection wells were spaced 15 to 20 feet apart to provide an effective injection well network. Monitoring well spacing allowed for monitoring of the vadose and saturated zones from the effects of chemical oxidation.

GES installed 10 injection wells (2 nested wells per boring in CO-1 thru CO-5) from October 7 through October 17, 2003. In order to ensure compatibility with the chemicals to be injected, the injection wells were constructed of stainless steel. Each “nested” location included two injection wells constructed by installing two $\frac{1}{2}$ -inch diameter stainless steel risers (one riser pipe for oxygen/ozone and one riser pipe for hydrogen peroxide) into a six-inch diameter borehole. Each borehole was advanced to approximately 30 to 35 ft bls. All wells were installed above the clay interval (denoting the base of the water table aquifer).

Each hydrogen peroxide and ozone injection well was completed with a two foot long by $\frac{1}{2}$ inch diameter section of stainless steel well screen (diffuser), installed at the end of the casing into saturated soil. The ozone diffuser was installed at the bottom of the nested injection well boring, approximately 28-30 ft bls for CO-1, CO-2 and CO-4 and 30-32 ft bls for CO-3 and CO-5. Sand pack was placed surrounding the diffuser and to a depth of one foot above the top of the diffuser. A bentonite seal (minimum of one half foot thick) was placed above the sand pack surrounding the ozone diffuser to prevent short-circuiting. An additional half foot of sand was added above the bentonite, prior to placement of the hydrogen peroxide point. The hydrogen peroxide injection well was then installed at approximately 24-26 ft bls for CO-1, CO-2 and CO-4 and 26-28 ft bls for CO-3 and CO-5. Sand pack was placed surrounding the well screen and to a depth of two feet above the top of the screen. A bentonite seal (minimum of one foot thick) was placed above the sand pack to prevent short-circuiting. Following the installation of both the diffuser

and the well casing, each borehole was filled with concrete grout and completed with a protective, access vault, mounted flush to grade.

As described in Section 5.2, GES contracted SJB Service to install four monitoring wells (VERMW-1 thru VERMW-4) throughout the injection area to monitor the effects of the chemical oxidation event and to provide groundwater and headspace monitoring within the test area. The monitoring wells are constructed using 2-inch PVC screen and casing. Each monitoring well was completed with a protective, stickup.

Following well installation activities, each well was developed by the drilling subcontractor. Development was accomplished through a surge and purge approach, utilizing a surge block and an electric submersible pump.

5.5.4 System Equipment

The ChemOx system is housed in a 16-foot trailer. The trailer includes the air/ozone and hydrogen peroxide injection systems with individual controls for each well. A process and instrumentation diagram depicting the oxidation system is included as Figure 6.

The ozone components include an air compressor, pressure swing adsorption unit, and ozone generator. The air compressor and pressure swing adsorption unit are utilized to generate oxygen and are commonly used with oxygen/ozone generators. This approach was selected because it is regarded to be safer than the alternative method of storing oxygen tanks at the site. The air produced by the compressor is directed into a pressure swing adsorption unit that adsorbs the nitrogen naturally present in the air stream, resulting in an oxygen-rich air stream to feed the ozone generator. The nitrogen adsorption unit periodically exhausts small volumes of nitrogen back into the atmosphere. A flow indicator monitors the flow of the oxygen stream. A low flow alarm will cause the air compressor to shut down to avoid a leak in the system or malfunctioning oxygen generation equipment. The flow is also transmitted to a flow controller, which operates a solenoid valve to ensure a constant flow is delivered to the ozone generator. Downstream of the flow indicator is a pressure indicator with a high pressure alarm and pressure relief valve.

As a safety precaution, the trailer is equipped with an exhaust fan with a run light. If at any time the exhaust fan is inoperable due to electrical malfunction the light will shut off, alerting the technician there is a potential for encountering ozone vapors, so proper precautions can be taken. Additionally the cabinet that houses the valves for the ozone is exhausted to the atmosphere through an ozone destruction media. If an ozone leak is detected (via inline ozone detector), the ozone detector would shut down the system and any ozone in the atmosphere would be destroyed prior to being vented from the trailer.

The hydrogen peroxide system includes a holding tank and injection pump. The holding tank is double-walled and was used to store the solution of 35% hydrogen peroxide. A high and low pressure alarm was in place on the hydrogen peroxide injection line in order to shut down the pump under high pressure or low pressure conditions.

5.5.5 Control Panel

The advanced oxidation system includes a programmable logic controller (PLC) to control the operation of the oxygen, ozone, air, and hydrogen peroxide injection system. The PLC is used to ensure that injection flow rates at each point are controlled and to pulse the operation of the system to cycle injection wells and flows.

5.5.6 Above Grade Piping

The injection wells were connected to the remediation system trailer, via an above grade piping network. Piping for the advanced oxidation system included individual Teflon tubes to each oxygen/ozone injection well (Figure 7) and High Density Polyethylene (HDPE) lines for hydrogen peroxide delivery (1/2" diameter lines). The Teflon and HDPE lines were sleeved within plastic piping for physical protection.

Piping was connected to the top of each injection well. Since the ozone lines are individually controlled from the equipment compound/trailer, the Teflon tubing was connected directly to the stainless steel injection point via a compression fitting. The individual hydrogen peroxide lines were connected directly to the stainless steel injection points. A check valve was installed at each hydrogen peroxide well.

5.5.7 Pilot Test Monitoring

In order to document initial conditions and evaluate the effectiveness of the technology, the following parameters were monitored daily or weekly before (baseline), during and after the pilot test as described further in this section.

5.5.7.1 Daily Monitoring

- Ambient air measurements in the pilot test area: LEL, VOCs and ozone.
- System: Pressure (psi) and Flow (gph).
- Monitoring wells (VERMW-1, VERMW-2, VERMW-3, VERMW-4, and LF-6).
 - Headspace: VOCs, ozone, carbon dioxide, oxygen, carbon monoxide.
 - Groundwater data: pH, temperature, ORP, dissolved oxygen (DO), conductivity, turbidity, percentage hydrogen peroxide.
 - Pressure measurements.
- Monitoring wells (VERMW-1, VERMW-2, VERMW-3, VERMW-4, LF-6, LF-3, RW-8R, LF-1S, MW-3URS, and MW-28)
 - Liquid levels and Total Depth (TD).

5.5.7.2 Weekly Monitoring

- CO injection wells (1 thru 5) and monitoring wells LF-3, RW-8R, LF-1S, MW-3URS, and MW-28.
 - Groundwater data: pH, temperature, ORP, DO, conductivity, turbidity, and percentage hydrogen peroxide.
 - Groundwater sampling for VOCs and SVOCs in wells without separate-phase product weekly between May 11, 2004 and June 1, 2004 and at the conclusion of the test on June 22, 2004.

Groundwater was analyzed for NYSDEC STARS List VOCs and SVOCs by Method 8260 and 8270, respectively. As a note, method 8260 was run in lieu of the method 8021 analysis specified in the ChemOx Work Plan due to limited capacity of the lab to run the method 8021 at the time of sampling.

Please note groundwater chemistry data was performed utilizing low-flow sampling techniques (i.e. bladder pump and flow-through cell), as described in the ChemOx Work Plan. A Geotech

Interface Probe was used to measure liquid levels prior to, daily during the pilot test and at the completion of the test.

The baseline groundwater data was collected from the following wells inside and outside the pilot test area, VERMW-1 thru VEWMW-3, LF-3, LF-1S, RW-8R, and MW-3URS, on April 7, 2004. Separate-phase product thickness measurements collected on April 7, 2004 showed separate-phase product at LF-6, MW-28 and VERMW-4.

During the course of the pilot test, GES noted observations of physical change in product and groundwater at many of the monitoring wells, most notably the characteristics of the product and the presence or absence of sheen in groundwater. In addition, the testing of certain groundwater chemistry was completed to evaluate the potential of the system to produce hazardous subsurface conditions during operation. Injection of oxidizers into the subsurface and having those oxidizers mix, creating hydroxyl radicals, can result in highly exothermic reactions and potentially explosive conditions. Measurements were collected for temperature and pH in order to evaluate the potential for these reactions and to modify injection rates or other system operating parameters if these conditions were encountered. Data collected during the course of the pilot test is presented in Appendix E.

5.5.7.3 Membrane Interface Probe

GES utilized a Membrane Interface Probe (MIP) on October 23, 2003, to collect qualitative baseline total VOC data (Appendix E), prior to the start of the pilot test and again on June 23, 2004, one day after completion of the pilot test.

The MIP is a percussion-tolerant VOC sensor that can continuously log volatile organics that diffuse through a semi-permeable membrane. Using a carrier gas, the VOCs are brought to the surface through tubing, which is connected to a laboratory grade Photo-ionization Detector (PID), Flame Ionization Detector (FID), and Electron Capture Detector (ECD) for immediate screening. All three of these detectors are mounted in a Hewlett Packard 5890 Series II Gas Chromatograph cabinet.

As the operator advances the MIP sensor into the subsurface a log is displayed onscreen by the field computer. This log provides information about VOCs in the subsurface using either the PID or FID or any combination of detectors. The real time log also provides a depth/speed graph, electrical log of the formation, and temperature log of the heated sensor onscreen. For this project, the FID and PID were used.

The data provided is a scan of the subsurface, measured in micro-volts. The higher micro-volts equate to higher VOC concentrations. Generally, the micro- volts translate into a qualitative measurement of the VOCs present in the soil. Since there is no direct correlation between analytical data (measured in parts per million [ppm]) and the micro-voltage measurements at the boring locations, VOC distribution was solely based on micro-voltage measurements before and after the completion of the Chemical Oxidation pilot test. The use of the MIP provided measurements in the study area that showed the effectiveness of the pilot test in conjunction with measurements of dissolved phase VOCs and SVOCs and product thickness measurements, as discussed further below.

5.5.8 Advanced Oxidation System Pre-Startup

Prior to the startup, baseline information was acquired to determine the flow rates and associated pressures for the individual air/ozone and peroxide injection systems.

The air/ozone injection pressure and flow rate was determined by running air only into each of the injection wells, CO-1 through CO-5. Based upon this data the flow rate of ozone was calculated and air/ozone flow with coinciding pressure measurements was acquired. After the information was collected, the data was graphed, and flow curves were developed. It was determined that three steps, 2.6 scfm, 5.1 scfm and 7.6 scfm of air/ozone could be injected during the startup test.

In order to determine the maximum flow rate of peroxide, a liquid flow test was completed. A graduated cylinder was filled with a known volume of water, the peroxide pump was turned on and timed until the cylinder was empty. This was completed three times and averaged. It was determined, based upon the data collected, a maximum of 4.2 gallons an hour could be pumped from the peroxide portion of the system.

5.5.9 Advanced Oxidation System Startup

A step-wise approach was taken in order to gradually reach maximum injection rates and concentrations, allowing time between steps to perform monitoring. System start-up occurred over a five-day period. The goal was to determine the appropriate air/ozone and peroxide system flow rates and coinciding pressures that would have the greatest influence within the pilot study area.

Several measurements were collected to verify the radius of influence, including the change in pressure gradient, dissolved oxygen in groundwater and oxygen in headspace measurements. Also noted was any sign of bubbling at the particular monitoring well. The measurements used are indirect interpretations of the physical processes in the subsurface. GES used standard industrial practices as described herein to collect the monitoring data.

Two pieces of data sought, but not used, included ozone in headspace and groundwater rise. Ozone was not detected at any location during the pilot test. This can be explained primarily by two factors:

- One is the highly soluble nature of ozone. Ozone readily dissolves into the groundwater.
- The second is that ozone as an oxidizer breaks down after encountering hydrocarbons. Thus, after the reaction, the only remaining daughter compound is oxygen.

The rise in water table from air injection was too difficult to discern from the normal rise and fall of groundwater due to changes in the Buffalo River.

Air and/or air/ozone was injected into the formation at one CO location at a time: A magnehelic gauge (inches of water) was attached via friction fit connection to the top of the monitoring well. As air entered the aquifer through the CO point, pressure changes were measured at the monitoring well. In general a rise of 0.10 inches water at an individual well denotes flow is occurring in the subsurface at and near the well location. An increase in headspace oxygen and an increase in DO are other factors that support the interpreted radius of influence. The higher the rise from baseline the greater the influence. In general all parameters monitored supported evidence of influence.

The following method was used to define the area of influence of peroxide during injection and the volume of peroxide each point could accept. The area of influence was determined by measuring peroxide concentration at monitoring wells, using peroxide colorimetric strips and dissolved oxygen, using a DO meter. The range of the strip was 0.05 to 3.0 ppm (the higher the reading the higher the peroxide concentration). Additionally, increased DO measurements (from baseline) would support the reading of the peroxide strip, however this method is indirect and the observed percentage rise in peroxide did not match the percentage rise in DO. Maximum flow measurements were determined by increasing the flow from the pump and checking backpressure at the pump during operation. Elevated backpressure measurements would indicate a reduced flow rate. Flow rate was determined by measuring the volume peroxide pumped per unit time.

5.5.9.1 System Start-Up: Day One

During the first day of system start-up, completed on April 13, 2004 ozone, oxygen and air were injected into well CO-4 for a period of approximately four hours. The flow from the ozone system was comprised of 90% ozone and 10% oxygen, at approximately 0.6 scfm. This ozone/oxygen mixture was combined with air in a stepped approach until a maximum air flow rate was achieved. The maximum rate reached was 7 scfm of air (from the sparge compressors) resulting in a total system flow of 7.6 scfm. The test was stepped in the following increments; 2.6 scfm, 5.1 scfm and 7.6 scfm. The duration of each test varied, in general each step of the test lasted approximately 60 minutes. Surrounding wells were monitored for radius of influence data, including pressure gradients, oxygen and ozone concentrations in the headspace, water table mounding, and dissolved oxygen concentrations.

5.5.9.2 System Start-Up: Day Two

The second day of start-up, completed on April 15, 2004 involved the injection of hydrogen peroxide into multiple wells for a period of six hours. During the test, a 35% solution was injected at a rate of 4.2 gallons per hour using a metering pump. The injection wells included CO-2, CO-3, CO-4 and CO-5. CO-1 peroxide point was inoperable during the test. After further inspection of CO-1, it was determined that there was a blockage in the casing of the peroxide point. Attempts to clear the blockage were unsuccessful, therefore CO-1 was inactivated for the

duration of the pilot test. After six hours of injection, the surrounding wells were monitored for dissolved oxygen with a D.O. meter and %H₂O₂ in groundwater using indicating paper.

5.5.9.3 System Start-Up: Day Three

Based upon the information collected during Day 1 and Day 2, additional testing was completed on April 16, 2004 on individual CO air/ozone injection wells. The testing included operating the air/ozone injection at CO-1 thru CO-5, each for 15 minutes at a flow rate of 7.6 scfm. During the operation, effective radius of influence was obtained by measuring pressure gradient and oxygen and ozone headspace concentrations. Upon completion of the testing, the PLC was programmed to configure the injection at two wells, injecting air/ozone and peroxide simultaneously. The test included injection of air/ozone at 7.6 scfm and injection of peroxide at 4.2 gal/hr into CO-4 and CO-5 for approximately 3.5 hrs.

5.5.9.4 System Start-Up: Day Four and Day Five

After reviewing the first three days of data, additional information was sought on April 22 and 23, 2004 to determine the lowest flow and pressure that would achieve influence within the pilot study area. An initial pressure of 25 psi and a flow rate of 4 scfm of air were selected at the center injection location, CO-4. Midway during the test, ozone was added to the air stream at a rate of 0.7 scfm for a total flow rate of 4.7 scfm.

Measurements were taken of pressure gradient and headspace oxygen at monitoring wells VERMW-1 thru VERMW-5 and LF-6

The pressure gradient measurements were all above 0.10 inches water, within the boundaries of CO-1, CO-2, CO-3 and CO-5. Additionally, headspace oxygen increased at all monitored wells in comparison to baseline (Appendix E). On Day 5 a similar approach was taken with the total system flow was 4.6 scfm (0.7 scfm of ozone and 3.9 scfm of air). The pressure gradient and oxygen headspace were collected, with the addition of DO measurements collected at VERMW-1 through VERMW-3. The DO data indicated positive influence in the study area, with DO increasing at location VERMW-1 and VERMW-2, with VERMW-3 comparable to baseline.

5.5.9.5 Evaluation of System Startup Data

The data collected over the first 5 days is evaluated below and provided the information needed to operate the long term pilot test.

System Startup Day 1

The first day of testing provided the general radius of influence data for air/ozone. Air/ozone was injected into CO-4 at varying flow and pressure: 7.6 scfm/60 psi, 5.1 scfm/35 psi and 2.6 scfm/12 psi. Initial operation at 60 psi and 7.6 scfm showed pressure influence above 0.10 inches water at locations MW-3URS and LF-1S (over 100 ft away from the target area), indicating operating pressure and coinciding flow was too high and air/ozone influence would extend beyond the pilot study area. Similar concerns occurred when operating at 35 psi with coinciding flow of 5.1 scfm. The flow of 2.6 scfm/ 12 psi affected the area of the pilot test, but did not show the rise in the pressure gradient at all locations. The data indicated that flow rate between 2.6 and 5.1 scfm and a pressure between 12 and 35 psi would have the pressure influence and DO increases within the planned study area.

System Startup Day 2

The second day of testing was completed to check the radius of influence of injected hydrogen peroxide and verify flow rates at each CO well. The results indicated hydrogen peroxide influenced a location 20 ft away from the injection area and further concluded that all wells could support the highest flow rate of 4.2 gph with exception to CO-1, which was inoperable.

System Startup Day 3

The testing completed on Day 3 included the maximum flow rate of the air/ozone system at CO-1 thru CO-5. The testing was done to verify multiple points could be operated at the same time and to determine the radius of influence from each individual wellpoint and combined wellpoints. Testing showed multiple points could not be operated at the same time, as the flow required surpassed the output of the system. The monitoring data showed that points CO-4 and CO-5 caused the greatest rise in pressure gradients at monitoring wells within the pilot study area. Also of note, CO-3 had the lowest rise in pressure gradient at monitoring wells in the study area (see Appendix E).

Additional testing included the operation of CO-4 and CO-5 using the maximum injection rate of air/ozone and peroxide at these two locations. Measurements of all headspace and groundwater chemistry parameters were conducted. The headspace readings showed increases in LEL, PID and oxygen. Furthermore, groundwater chemistry indicated an oxidized environment as ORP was positive and DO readings increased at VERMW-1 and VERMW-2. Rise in groundwater temperature was 5 degrees C from baseline and pH showed no discernable changes.

System Startup Day 4 and 5

The system was operated to determine headspace oxygen changes within the study area when operating at a total system flow of 4.6 scfm (0.7 scfm of ozone and 3.9 scfm of air). The pressure gradient measurements were all above 0.10 inches water, within the boundaries of CO-1, CO-2, CO-3 and CO-5. Additionally, headspace oxygen increased at all monitored wells in comparison to baseline. On Day 5, the total system flow was the same as on Day 4 (4.6 scfm with 0.7 scfm of ozone and 3.9 scfm of air). The same measurements were collected as Day 4 with the addition of DO measurements collected at VERMW-1 through VERMW-3. The pressure gradient and oxygen headspace data were similar to that collected during Day 4. The DO data indicated positive influence in the study area, with DO increasing at location VERMW-1 thru VERMW-3 in comparison to baseline.

5.5.9.6 Long Term System Operation

Based upon operational concerns during the first 5 days, it was determined that a few minor modifications would be needed for full-scale startup. The modifications included a run light to determine proper ventilation fan operation and a telemetry line to provide off-site operational status.

The full-scale system was started on April 28, 2004, 5 days after the final testing was completed. The system was programmed to operate on CO-2 through CO-4, with a peroxide pump rate of 4.2 gph and air/ozone rate of 4.6 scfm.

The system was operated 24 hours per day for 52 days, excluding six days of downtime for system repairs (system was down from May 2 through May 6, 2004 and from mid-day June 7 through mid-day June 8, 2004).

The systems configuration remained the same throughout the pilot test with the exception of a decreased flow rate of hydrogen peroxide over the weekend. From Saturday to Monday morning the peroxide flow rate was decreased to 3.2 gal/hr to ensure there was enough peroxide to last through the weekend, without the need to fill the peroxide holding tank. Throughout the 46 days of operation, radius of influence data was evaluated, and no changes to the operational parameters were required.

5.5.10 Data Evaluation and Results of the ChemOx Pilot Test

The following is an evaluation of the pilot test results and analytical data collected.

5.5.10.1 MIP Data

Generalized hydrogeologic cross-sections (D-D', E'E' and F-F') of the 40 foot x 40 foot pilot test area are presented on Plates 2 through 4. The cross sections shown on each plate are the same, except that each shows a different set of water table and apparent separate-phase product thickness data, as follows:

- Plate 2 shows water level and separate-phase product data from the baseline round on April 7, 2004;
- Plate 3 shows the highest water table elevations observed at each well with the corresponding apparent product thickness data (the highest water table elevations were observed on different dates, but are shown on one cross section); and
- Plate 4 shows the thickest apparent separate-phase product observed during the pilot test and the corresponding water table elevations (thickest product accumulations were observed on different dates during the test, but are shown on one set of cross sections).

On the cross-sections, next to each MIP location, graphs of the baseline (Event 1, October 2003) and post pilot (Event 2, June 2004) test MIP FID data are shown. Data from Event 1 is shown in blue and data from Event 2 is shown in red. The scale of the FID in microvolts (uV) is shown above. In addition, graphs of all MIP data collected are presented in Appendix E. On all of the graphs, the MIP response during the one or both events was a flat line after a certain depth due to the range and attenuation settings of the PID and/or FID detectors setting being too low. For example, at MIP1 during Event 2 when the response of the detectors went out of range of the setting on the data logger, the flat line appeared, indicating the response from the detectors were all above the set range (1.2×10^6).

The data indicates mass removal of VOCs at all locations. However, the MIP data at MIP1 and MIP3 show more favorable results than the data from MIP2 location. Specifically, the data from MIP1 and MIP3 show micro-voltage measurements that are lower, by 10^5 to 10^6 , compared to baseline. The microvoltage decreases at MIP1 and MIP3 extended from approximately 13 feet (at MIP3) and 15 feet below grade (at MIP1) to a depth of 25 ft below grade at both locations. MIP2 results showed a decrease from 19 to 22 ft only and decreases were of a smaller magnitude. The less favorable results at MIP2 compared to MIP1 and MIP3 are attributed to the location of MIP2 near CO-1, which was inoperable during the pilot test.

In general, there appears to be no difference in microvoltage (uV) measurements at depths below 25 feet below grade at any location, compared to the initial data. However, due to a lower limit of the PID and FID response, which was preset on the data logger during the second event (described further below), the higher peaks of the FID and PID responses do not appear after 25 ft bls, therefore it makes it impossible to compare directly to baseline. As shown on Plates 2 through 4, the most significant mass removal of VOCs occurred from approximately the middle to the top of the peroxide injection point upwards. This indicates that the action of the hydrogen peroxide in conjunction with the ozone is responsible for the majority of mass reductions, not the ozone alone. Mass removals occurred both in the saturated and unsaturated zone as shown on the cross sections.

Explanation of Inconsistencies in the MIP Logs between First and Second Events

At MIP 1 during Event 2, the range and attenuation settings of the FID were slightly lower than during the first event, though in the same order of magnitude, therefore the flat line appeared prior to reaching the initial peak setting of 1.8×10^6 at only 1×10^6 .

At MIP 2 during Event 2, the range and attenuation settings of the PID were lower than during the first event. Therefore the flat line appeared at 1.1×10^6 rather than 2.5×10^6 , the range of the first event. The apparent total VOC reductions (i.e., lower values in the second event than the first) were not due to the remediation.

At MIP 2 during Event 2, the range and attenuation settings of the FID were lower than during the first event. Therefore the flat line appeared at 8×10^5 rather than 1.4×10^6 , the range of the

first event. The apparent total VOC reductions (i.e., lower values in the second event than the first) were not due to the remediation.

At MIP 3, during Event 2, the range and attenuation settings of the FID were lower than during the first event. Therefore the flat line appeared at 8.6×10^5 rather than 1.4×10^6 , the range of the first event. The PID settings were the same for both events. It should be noted that saturation of the detectors and equipment occurred at approx 27 ft bls, therefore the supervising staff had the test stopped, to ensure time for the detectors to clear prior to moving to MIP 2.

5.5.10.2 Groundwater Quality

The general analysis of groundwater data indicates a decrease in VOCs and SVOCs from the start of the long-term pilot test in comparison to baseline analytical data collected on April 7, 2004. VOC and SVOC data with time for wells within and outside the pilot test area are presented in Tables 6 and 7, respectively and in graphical form in Figures 8 through 16 for CO-1 through CO-5, VERMW-1, VERMW-2, RW-8R and MW-3URS, respectively. The groundwater concentrations of VOCs and SVOCs observed in CO-1, CO-2, CO-4, CO-5, VERMW-1 and VERMW-3 diminished and remained below baseline concentrations with some fluctuations during the course of the test (except for SVOCs at CO-2 which were non detect throughout the test except for an anomalous concentration of 35.8 ppb on June 1, 2004).

The exception to the general decreasing groundwater concentration trends in the pilot test area wells is CO-3. At this location, after the initial sampling (after baseline), a slight decrease in concentrations occurred, followed by a continuously increasing trend in VOC concentrations. This may be attributed the location of this well at the upgradient portion of the study area where the influx of more highly contaminated groundwater from untreated areas influenced the results.

Concentrations of VOCs and SVOCs in wells outside the pilot test area (MW-3URS and MW-8R) fluctuated during the pilot test. Concentrations of VOCs and SVOCs in these wells were lower at the conclusion of the test than during the baseline round, however, based upon their locations upgradient (MW-8R) and side-gradient (MW-3URS) of the pilot test area, it is difficult to attribute reductions to the ChemOx pilot test.

The analysis of groundwater for metals showed slightly elevated levels of calcium and magnesium and significant levels of ferrous iron. The levels of iron in the groundwater are believed to be significant enough to allow a Fenton's like reaction (iron catalyzed peroxide reaction) to occur upon injection of peroxide into the subsurface, without the addition of an iron catalyst. This process, if occurring, would be an additional enhancement to the action of the ozone and peroxide in producing hydroxyl radicals.

5.5.10.3 Water Table Rise, Product Thickness, Physical Changes in Product, Product Recovery and Product Analysis

The generalized hydrogeologic cross-sections presented on Plates 2 through 4 show the range of water table and product thicknesses observed in the pilot test area during the course of the pilot test. In addition, hydrographs of wells within and outside the pilot test area are presented in Appendix E. All wells within the pilot test area boundaries experienced a rise in water table elevations following startup. The average rise in water table elevation in CO-1 through CO-5 during the course of the pilot ranged from 0.6 feet at CO-5 to 1.2 feet at CO-3. The average rise in water table elevation in VERMW-1 through VERMW-4 during the course of the pilot ranged from 0.6 feet at VERMW-3 to 4.8 feet at VERMW-2. The average water table rise at LF-6 was 0.67 feet.

Product recovery efforts within and outside the pilot study area occurred at LF-6, MW-28, and VERMW-3, as described further below.

VERMW-3

VERMW-3 initially had no separate-phase product present. The maximum apparent product thickness observed at this location during the pilot test was 5.79 feet on June 4, 2004. Total product recovery at this well during the test was 31.2 gallons through manual bailing.

In addition to product recovery, product in this well also showed physical changes during the test as described in detail at VERMW-4 below.

VERMW-4

The initial product level at VERMW-4 during the pre-pilot baseline round on April 7, 2004 was 0.67 feet. Product was measured at VERMW-4 until June 3, 2004 at thicknesses varying

between 0.01 feet (on several dates) and 3.45 feet on May 27, 2004. Product was not observed in this well after June 3, 2004. Product level changes may be attributed to groundwater fluctuation during the test and not solely to the effect of the ChemOx system operation. The water level increased significantly during the pilot test as shown on the VERMW-4 ChemOx pilot test hydrograph presented in Appendix E. The water level rose from the baseline elevation of 571.71 ft msl to the highest level of 577.41 ft msl at the conclusion of the test. This water table elevation change could have submerged product beneath the water table. Gauging data collected on November 18, 2004 indicated that the water level in this well has returned to near pre-pilot baseline levels (571.01 ft msl) and that no product is present. This recent data indicates that product within this well was remediated.

The product at VERMW-4 (and at VERMW-3, LF-6 and MW-28) showed an interesting transformation in appearance and observed product viscosity. The product which was originally similar in appearance to #4 fuel oil during the startup test showed apparent change into a “black machine like oil” substance with a measurable layer of material with a “cork like” appearance forming above (with a grease like feel) and finally to a foam appearance above this.

Saponification of hydrocarbons may be the cause of the physical changes seen at VERMW-4 and other wells. The breakdown (saponification) of longer chain hydrocarbons, to more soluble shorter chain hydrocarbons is a typical result of Chemical Oxidation (USEPA 2004). The cork like substance may be due to the reaction of various cycloalkanes (or cycloparrafins) present in the product.

LF-6, MW-28 and VERMW-3 underwent a similar transformation as the product at VERMW-4, with exception that the process appeared to take more time.

LF-6

LF-6 had an initial product thickness of 0.11 ft. Product remained in LF-6 throughout the test, and was frequently bailed. Based upon review of available hydrographs from LF-6, it appears that a higher groundwater table generally contributed to higher apparent product thickness. Historically, with some exceptions, product thickness appeared greatest during times of a high water table. However, product thickness appeared at its highest level (3.83 feet) on May 11,

2004 during the pilot test when compared to historical hydrograph data (Appendix A). This initial product increase may be due to a combination of the rising water table and the action of the ChemOx process, as described further below. Towards the end of the pilot test, the water table continued to rise to its highest level in this well since it was installed, at which time the product levels decreased. As shown on the hydrograph, as the water table rose past approximately 527.6 feet amsl, the product thickness generally decreased. This decrease may be due to a combination of manual bailing of product and submerging of the product layer below the water table as it rose.

Product recovery during a single bailing event (3.5 gallons on May 12, 2004) was one of the highest recorded. The total volume of product recovered during the three month pilot was 12.6 gallons which was more than half the total amount of product recovered between February 2000 and March 2004 (22.9 gallons).

In addition to product recovery, the product also showed a physical change during the test as described in detail at VERMW-4 (above).

MW-28

MW-28 also showed an increase in recovered product volume in comparison to historical product recovery over similar periods of time. Product recovery using the spill buster was 32 gallons during the three-month test. The highest recorded over any other similar period of time. In comparison, the total product recovered from April 2001 when the pump was installed and March 2004 was 87 gallons.

In addition to product recovery, the product also showed a physical change during the test as described in detail at VERMW-4 (above).

Total Product Recovered

The total volume of product removed from the target area of the ETYA was 80.8 gallons, which exceeded the volume of product removed during any other period since bailing and automated recovery began in this area. In comparison, between February 2000 and March 2004, approximately 142.5 gallons of separate-phase product has been recovered from wells in the

ETYA. The gain in product can be attributed to the disassociation of the product from the soil pores and soil surface resulting from the action of the ChemOx pilot test. The disassociation may be a combination of physical and chemical processes due to elevated temperature, physical agitation from the movement of air, and saponification (breaking down of longer chain hydrocarbons) from the action of the hydroxyl radical reaction with the hydrocarbons or release of surfactants by the propagation of aerobic bacteria (Kosaric 2001).

Product Analysis

Separate-phase product samples were collected on June 21, 2004 at the end of the ChemOx pilot test and analyzed for concentrations of VOCs and SVOCs by Methods 8260 and 8270, respectively. Samples were collected from two wells outside the 40 foot x 40 foot pilot test area (LF-1S and MW-28) and two wells within the pilot test area (LF-6 and VERMW-3). The analytical results are presented on Tables 8 and 9 for VOCs and SVOCs, respectively. The compounds and concentrations present in the samples from LF-1S and MW-28 (outside the pilot test area) are similar to each other. The compounds and concentrations present in the samples from LF-6 and VERMW-3 (inside the pilot test area) are also similar to each other. Since samples for these parameters were not collected prior to the ChemOx pilot test, a direct comparison of concentrations at individual wells before and after the test cannot be made. However, the available sample results do indicate that the average total VOC concentrations in the product within the pilot area are nearly 90 percent lower than the total VOC concentrations in the product outside the pilot test area. Similarly, the average total SVOC concentrations in the product within the pilot test area are nearly 50 percent lower than the total SVOC concentrations in the product outside the pilot test area. This data indicates that the ChemOx system reduced the concentrations of these contaminants in the separate-phase product.

5.5.10.4 DO and ORP

Concentrations of DO and ORP in groundwater with time are presented on Figures 17 through 23, along with VOC and SVOC data for CO-1 through CO-5, VERMW-1 and VERMW-2, respectively. Initial measurements of DO and ORP at all locations (CO-1 through CO-5, VERMW-1 and VERMW-2) were typical of a hydrocarbon contaminant plume with low DO measurements and negative ORP, indicating a reduced state. At CO-1, CO-2 and CO-5, the DO and ORP increased significantly immediately after startup of the ChemOx pilot test indicating

the change from reducing conditions to oxidizing conditions. At these locations, the DO and ORP were variable at each location, but remained above initial conditions, indicating sustained oxidizing conditions. At CO-3 and CO-4, the DO and ORP initially increased at the start of the test indicating the change from reducing to oxidizing conditions, however between June 1, 2004 and June 22, 2004, the DO decreased and the ORP reverted back to negative, indicating return to reducing conditions. At VERMW-1 and VERMW-2, after the initial start of the long-term test, DO and ORP increased, indicating oxidizing conditions, until approximately June 2, 2004, when the ORP and DO reverted back to pre-start up conditions. At these locations, after June 2, 2004, the DO and ORP fluctuated in the low (DO) and negative (ORP) ranges until the system was shutdown on 22 June 2004. The explanation for the change back to reducing conditions at several locations cannot be explained since system-operating conditions were similar to the beginning of the test.

Based upon DO and ORP concentrations in groundwater and increased oxygen in the headspace, an aerobic environment was apparent. In addition, carbon dioxide readings increased somewhat during the pilot test indicating the aerobic respiration was occurring. However, quantification of the rate of biodegradation and the mass reduction of hydrocarbons attributable to bioremediation would be difficult and is beyond the scope of the pilot test. Long chain hydrocarbons are easily bio-remediated. Typically, bio-degradation is enhanced at the perimeter of the injection locations, where higher temperatures do not negatively affect the bacteria colonies.

5.5.10.5 Temperature Rise, Carbon Monoxide, PID and LEL Measurements

Temperature rise is indicative of the exothermic reaction occurring at the CO points. Both increased carbon monoxide and elevated PID/LEL measurements are indicators of volatilization of VOCs and SVOCs. The unknown rate of volatilization makes it difficult to ascertain mass removal, but the general increase in concentrations of these headspace parameters coincided with the ChemOx operation. The initial increases of and eventual asymptotic levels of CO (as the VOC source is depleted) are indicative of mass transfer of hydrocarbons from the absorbed to air.

Initial temperatures in the pilot area ranged from 9.76 degrees C at CO-5 to 11.19 degrees C at VERMW-2. As expected, temperatures during the test were highest at the operable CO points

and ranged from 22.95 (at CO-3 on June 22, 2004) to 29.34 degrees C (at CO-2 on June 1, 2004) indicating that exothermic reactions were occurring. As a note, the temperature data was collected from the CO points several hours after system shutdown due to the inability to access the CO points during operation. Therefore, it is unknown how high the temperature may have reached during operation. However, based upon the data collected several hours after shutdown, higher temperatures at the CO points are expected during operation. At the inoperable CO point (CO-1) and the monitoring points VERMW-1 and VERMW-2, temperatures ranged from 15.65 to 17.64 degrees C, indicating a rise in water temperatures throughout the pilot test area. The initial mass transfer (indicated by elevated CO, PID and LEL) may be attributed to the volatilization of pentane compounds, which have a boiling point of 36 degrees C or other gasoline compounds that start with a boiling point of 20 degrees C.

Although the ChemOx process produces an exothermic reaction in the subsurface, as described above and evidenced by temperature increases in groundwater throughout the pilot test area, monitoring data indicated the process did not produce subsurface conditions that would pose a threat to human health (i.e., explosive conditions, harmful vapors, excessive temperatures, etc).

5.5.10.6 Soil Analysis

Analysis of VOCs and SVOCs (STARS list compounds) was completed at one soil boring (SB-194) within the study area, as shown on Plate 1. The data is presented in Table 10. The sample was collected at the soil/ water interface. Boring logs from previous investigations indicate that borings completed within this area prior to the ChemOx pilot test had apparent product. The results after ChemOx treatment did not indicate product. In addition, the closest well MW-28, where analytical results from soil samples are available, indicates a significant decrease in VOC and SVOC mass when compared to SB-194. Results of the soil samples at SB-194 are below RSCOs for all VOC and SVOC compounds.

5.6 Field Test Conclusions

Based upon the data presented above for the testing of the four technologies conducted in the separate-phase product plume in the ETYA, the following conclusions have been drawn regarding the potential applicability of these technologies to this area of the site.

5.6.1 Product-Only Recovery

The results of the long-term product only recovery testing has shown that product only pumping alone is not a viable option for achieving the RAOs for the target area. Specifically, it does not protect the Buffalo River. Product only recovery through manual bailing and/or automated pumping does successfully remove the product that accumulates in the wells in the target area, however since it is a passive operation, the product must make it's way into the well to be recovered and a single well influences only a small portion of the target area. Multiple wells and pumping systems, as well as long operational periods, would be required to achieve large scale recovery across the target area, which is impractical. Product-only recovery will continue to be employed to recover available product and increase recovery rates when used in combination with technologies that have been shown to increase product thicknesses in target area wells (i.e., ChemOx).

5.6.2 Groundwater Recovery for Containment and Product Recovery Enhancement

Based upon the results of the aquifer testing, groundwater recovery for containment and product recovery enhancement is not a feasible technology for the target area. Measurable water table drawdown was not observed in any of the surrounding monitoring wells during the pump testing at RW-8R, indicating a negligible zone of influence caused by the pumping well. Water level fluctuations were observed in all monitoring wells that were correlated directly to Buffalo River level changes. In addition, water table fluctuations corresponding to changes in Buffalo River levels were evident in the pumping well during the entire test period, indicating that even under pumping conditions, the influence of the river was not completely overcome. Though not calculated during the aquifer testing, a significant portion of the extracted groundwater volume was likely Buffalo River water. Due to the significant influence of the Buffalo River on the ability to extract groundwater and to effect drawdown in the area surrounding the pumping well, groundwater recovery is not a viable option to meet the RAOs for the target area. The excessive volumes of groundwater/river water that would need to be recovered and treated in order to provide containment and product recovery enhancement would be cost prohibitive compared to other options.

5.6.3 VER Pilot Test

The primary intent of the VER pilot test was to verify the effectiveness of VER at several different operating conditions based on the constraints of the site and equipment. The various tests were completed with all equipment operating within the expected ranges and without any test delays due equipment or instrument malfunction. The test succeeded in acknowledging the limitations of the technology. The operation of the VER test showed the difficulties with utilizing the technology in an aquifer with a high permeability, a water table depth close to limitation of the technology and in close proximity to the Buffalo River.

Unfortunately, adjustments to the drop tube depth, operating at various recovery wells, addition of packer and the installation of a pneumatic pump did not succeed in generating a higher vacuum on the well and thus extracting/entraining separate-phase product. The lithology of the target area with a combination of fine to medium sands with some silt and clay, and the overlying fill, with ash, glass, brick and concrete allowed the applied vacuum to dissipate easily in the formation. The available equipment could not overcome the rate of vacuum dissipation.

The inability to maintain a high vacuum and observe significant influence at the wellhead or monitoring wells showed that the application of vacuum to entrain product would prove difficult without substantial expense. The only substantial hydrocarbon recovery was completed through the removal of vapor phase hydrocarbons.

Based upon these results, VER did not meet the RAOs for the remediation of the target area, is not considered feasible for implementation in this area of the Site and will not be evaluated further in the RAS report.

5.6.4 ChemOx Pilot Test

The ChemOx Pilot test was successful in reducing petroleum related contaminant concentrations in soil, groundwater and separate phase product (the primary RAOs for the remediation). It also contributed to reducing product thicknesses in some wells within the pilot test area (either directly or through making addition product available for manual recovery) and in changing the physical properties and appearance of the product indicating breakdown of the product was occurring. Based upon the data collected during the test, it is likely that several physical,

chemical and biological processes are occurring during the ChemOx process. However, achieving full understanding of the actual physical/chemical/biological processes responsible for these changes was beyond the scope of the pilot test.

ChemOx has been selected for implementation in the ETYA separate-phase product plume area based upon the pilot test results. A description of the proposed full-scale remedy for the target area, as well as the rationale for selection including evaluation of the selected remedy against the eight criteria presented in the DER-10 are presented in Section 6.0. It was clear from the pilot test data that some modifications to the design of the pilot test injection points would be required to optimize system performance (i.e., deeper peroxide injection points are required, spacing of the injection points could be increased based on radius of influence data). These changes are discussed in Section 6.0, along with a conceptual layout of a full-scale ChemOx system for the target area.

6.0 RECOMMENDED REMEDY

The following is a detailed description of the selected remedy (ChemOx) and the rationale for its selection. Also included is a description of the IRM Work Plan that will be prepared to provide additional details of the proposed system.

6.1 Description of Selected Remedy/Conceptual Design

The proposed implementation of ChemOx as an IRM in the target area in the ETYA will consist of installation of a network of 25 new ChemOx injection points and operation of one or more mobile injection units (similar to the pilot test injection unit) in a phased approach in ChemOx “Cells” of five injection points each across the site. Phased installation of the injection points is anticipated (i.e., the points in Cells 1 and 2 will be installed initially). Data generated during the long term operation of these cells may be used to reduce or increase the number of injection points to be installed in the remaining cells.

Construction of all equipment within the mobile injection units, as well as the above ground piping, will be consistent with the pilot test configuration. Proposed full-scale ChemOx injection point construction and spacing is discussed further below. Monitoring of the progress of the remediation will be through a network of newly installed and existing groundwater monitoring wells and MIP borings, with confirmatory soil borings collected at select locations. Construction of the proposed monitoring wells will be similar to the “VERMW” series wells installed for the pilot testing, as described above. Operation, Maintenance and Monitoring of the proposed ChemOx system is discussed below. The proposed locations of ChemOx injection points, existing and proposed monitoring wells and MIP borings is presented on Figure 24. As evident in Figure 24, initially all ChemOx injection points and monitoring wells will be located outside the bermed area, downgradient of the Tank 176. This is to verify the long-term use of the technology prior to entrance into the ongoing active operations within the berm. Five MIP borings (Figure 24) will be installed initially within the bermed area to evaluate current conditions and to determine the appropriate need for ChemOx within the tank berm. During the monitoring phase of the ChemOx cells located outside the tank berm, the steps necessary to address impacts that may exist beneath the tank berm will be evaluated.

6.1.1 Proposed ChemOx Injection Point Spacing and Construction

Proposed Injection Point Spacing

Based upon the results of the pilot testing, a radius of influence of approximately 20 feet per injection point can reasonably be expected. Therefore, in order to provide overlapping coverage of the target area, the proposed ChemOx injection points are spaced at approximately 30 feet apart, except nearest to the Buffalo River bank, which are spaced slightly closer (24 to 28 feet apart). This slightly closer spacing is intended to provide additional treatment of this critical area. If, during long-term operation, particularly in the first two cells, it is determined that there are portions of the target area that are not receiving adequate coverage, additional ChemOx injection points will be installed in future cells. Conversely, if it is determined that certain portions of the area could be adequately covered by fewer injection points, fewer points may be installed.

Proposed ChemOx Injection Point Construction

A cross section running generally west to east through the proposed ChemOx IRM area is presented as Figure 25. The cross section line is shown on Figure 24. The cross section shows the proposed configuration of the ChemOx injection points throughout this portion of the ChemOx IRM target area. Based upon the results of the ChemOx pilot test MIP borings, the mass removal of hydrocarbons from the subsurface occurred at and above the elevation of the top/midpoint of the hydrogen peroxide injection point. It has been surmised that this is the zone at which the cone of influence created by the ozone rising from the ozone injection point meets the cone of influence created by the peroxide dispersed from the peroxide injection point. At all injection point locations, the peroxide injection screen was located within the second layer of unconsolidated deposits consisting of sands; silt (sandy silt to clayey silts); and silts and clays located directly below the first layer of unconsolidated deposits comprised of fill. At all locations except CO-1 (which was inoperable during the pilot test), the ozone injection point was located within the third layer of unconsolidated deposits comprised primarily of sand and gravel. The water table, separate-phase product and associated smear zone of residual product throughout the target area are located within the two upper geologic layers. Therefore, they comprise the critical zone for treatment by the proposed ChemOx system. The proposed ChemOx injection point will include two screens, as follows:

- One two foot air/ozone injection point located just above the clay layer at approximately 33 to 35 feet below grade (actual depths will vary throughout the site and will be determined based on encountering the clay layer);
- One two foot hydrogen peroxide injection point located at the bottom of the second layer of unconsolidated deposits (sands; silt [sandy silt to clayey silts]; and silts and clays), (depths will vary throughout the target area and will be determined based on the depth of the air/ozone injection point).

This proposed ozone injection point configuration is deeper than that used during the pilot test and is therefore expected to provide a wider cone of influence of ozone. The proposed configuration of the peroxide injection point is a few feet deeper than the pilot test peroxide injection points. This configuration is intended to maximize the treatment provided in the vicinity of the water table/product table interface and smear zone, while still providing additional treatment of a portion of the deeper contamination that was indicated by the pilot test MIP borings. Due to these differences in construction from the pilot test wells, the existing ChemOx wells are not intended to be used during long-term operation, unless additional coverage of this area is required.

The two screens will be separated by a six-inch (minimum) bentonite seal. The methods of installation and materials of construction are the same as described above in Section 5.3.3.

6.1.2 Proposed Mobile ChemOx Injection Units and Above Grade Piping

The proposed mobile ChemOx injection unit(s) and above grade piping will be identical to the equipment used during the pilot test. Descriptions of the equipment are presented in Section 5.3.3 through 5.3.5 of this report. The use of one mobile injection unit is currently planned for the full-scale ChemOx system. The unit will be stationed in a centralized location in order to maximize the number of cells that can be treated without moving the unit, to the extent possible. The unit will be moved, as necessary, to facilitate ease of operation and reduce downtime for relocation. . If it is determined during the initial phases of operation that injecting within two cells simultaneously would be beneficial and cost effective to speed the remediation timeframe, an additional mobile injection unit will be brought on-site.

6.1.3 Proposed Monitoring Network

The monitoring network for the full scale ChemOx system will include existing and proposed CO wells, existing and proposed monitoring wells and MIP borings. This monitoring network will be used to assess the progress of the remediation, evaluate temporary shut downs of ChemOx cells, monitor for rebound after shutdown to determine if additional operation is required and to ultimately justify permanent shutdown of the system. Location of the proposed monitoring network is shown on Figure 24. Confirmatory soil borings will also be performed at select locations in the vicinity of MIP borings (locations will be selected based on monitoring data and are not shown on the figure)

6.1.3.1 Existing and Proposed Monitoring Wells

In order to monitor water levels and separate-phase product thickness, groundwater quality and groundwater chemistry parameters (DO, ORP, etc), each ChemOx cell will have at least two monitoring wells (new and/or existing). In addition the air/ozone injection point at each nested CO well will also be monitored for these parameters. Parameters to be monitored and proposed monitoring schedules are described in Section 6.2. The construction of the monitoring wells will be the same as the “VER” wells described in Section 5.2.4.2 of this report. The proposed monitoring well network in each ChemOx cell is listed below.

ChemOx Cell 1

- Existing wells: LF-3, RW-8R, CO-3 and CO-5
- Proposed monitoring wells: None
- Proposed CO wells (air/ozone point to be sampled): Five proposed CO wells

ChemOx Cell 2

- Existing wells: P-15 and LF-1S
- Proposed monitoring wells: None
- Proposed CO wells (air/ozone point to be sampled): Five proposed CO wells

ChemOx Cell 3

- Existing well: LF-4
- Proposed monitoring wells: One monitoring well

- Proposed CO wells (air/ozone point to be sampled): Five proposed CO wells

ChemOx Cell 4

- Existing wells: VERMW-2, VERMW-3, VERMW-4, MW-28, LF-6, CO-1, CO-2 and CO-4
- Proposed monitoring wells: None
- Proposed CO wells (air/ozone point to be sampled): Five proposed CO wells

ChemOx Cell 5

- Existing wells: MW-3URS
- Proposed monitoring wells: Two monitoring wells
- Proposed CO wells (air/ozone point to be sampled): Five proposed CO wells

6.1.3.2 Proposed MIP Boring Locations

In order to provide a qualitative assessment of total VOCs in the subsurface prior to, during and after long-term operation of the ChemOx system, MIP borings will be completed within each ChemOx Cell. The locations of proposed MIP borings in the first two cells are shown on Figure 24. As shown, initially, three borings within Cells 1 and 2 will be installed. The number of MIP borings required for monitoring remedial progress in the other cells will be determined based on the performance of the first two cells. The MIP borings will be advanced to the approximate depth of the clay layer that forms the base of the aquifer in the target area (approximately 35 feet below grade, which will vary slightly throughout the area).

In addition, during the baseline MIP round, five MIP borings will be completed within the Tank 176 tank berm, as shown on Figure 24. These borings will be used to evaluate current conditions and the potential need for ChemOx within the tank berm. During the monitoring phase of the ChemOx cells located outside the tank berm, steps necessary to address impacts that may exist beneath the tank berm will be evaluated.

6.1.4 Proposed ChemOx System Phased Operation Sequence

Each ChemOx Cell covers an area of between 3,100 square feet (ChemOx Cell 3) and 3,900 square feet (ChemOx Cell 5). The proposed operation sequence will be to operate one cell at a time, starting with ChemOx Cell 1, for approximately two months (plus approximately two

weeks for receipt of groundwater quality data) and monitor conditions as described below. Once this initial operating period is completed, the injection will be initiated in the next cell for a two month period (plus or minus) and so on. If it is determined during the initial phases of operation that injecting within two cells simultaneously would be beneficial and cost effective to speed the remediation timeframe, an additional mobile injection unit will be brought on-site. In addition, if it is determined that pulsing of the system to allow water levels in the area to return to normal conditions may be beneficial to separate-phase product recovery efforts (i.e., if continuous operation is believed to have submerged product), consideration will be given to turning the system off periodically during operation in each cell. This determination will be made after evaluation of long-term water-level data during operation.

The injection sequencing, air/ozone and peroxide flow rates are expected to be similar to those used during the long-term pilot test. However, in order to confirm optimum injection rates and injection sequencing within each cell, a two day startup and testing period, with more intense monitoring and varying of operational parameters, will be conducted prior to long-term operation.

6.2 Rationale for Selection

The data collected during the field tests have been used to evaluate ChemOx based on the following seven evaluation criteria presented in Section 4.1 of the Draft DER-10 Technical Guidance:

- Overall protection of health and the environment;
- Compliance with Standards, Criteria and Guidance (SCGs);
- Long-term effectiveness and permanence;
- Reduction of toxicity, mobility or volume with treatment;
- Short-term effectiveness;
- Implementability; and
- Cost.

Also included as part of balancing criteria for this Site, although not part of current NYSDEC guidance, is consideration of the remedial alternatives' compatibility with planned land use.

Consideration of future Site use is consistent with federal and New York State programs to redevelop contaminated sites.

Each of the criteria is described below, along with an evaluation of the proposed ChemOx IRM against the criteria.

6.2.1 Overall Protection of Human Health and the Environment

Description of Criteria

Protection of human health and the environment is evaluated on the basis of estimated reductions in both human and environmental exposure to contaminants for the selected remedy. The evaluation focuses on whether the alternative achieves adequate protection, and how Site risks are eliminated, reduced, or controlled through treatment, engineering, or institutional controls.

Evaluation of Proposed Remedy

The proposed ChemOx IRM system will be protective of human health and the environment by reducing the concentrations of petroleum-related hydrocarbons in groundwater, soil and separate-phase product, as evidenced by the pilot test data for each of these media. In addition, operation of the ChemOx system will enhance separate-phase product recovery efforts by making more product available for manual and/or automated recovery efforts, as evidenced by the increase in product recovery during the pilot test. The potential for human and environmental exposure to the petroleum-related contaminants in the remediation target area will be reduced as the source of contamination (i.e., separate-phase product) is recovered and/or degraded and the concentrations of contaminants in groundwater discharging to the river are reduced.

6.2.2 Compliance with Remedial Goals, SCGs, and RAOs

Description of Criteria

Applicable federal and NYSDEC SCGs are identified for this Site are referenced in Section 4.2 of this document. Ideally, the selected remedial alternative for the Site would meet these SCGs; however, the selected alternative may be considered adequately protective without fully meeting the SCGs. Remedial goals and RAOs are presented in Section 4.3. The selected remedy

presented in this report achieves the significant remedial goals and RAOs based on its selection for implementation at the Site.

Evaluation of Proposed Remedy

Pilot test data indicates that implementation of ChemOx in the pilot area has the potential to remediate concentrations of petroleum-related compounds in soil and groundwater to SCGs. For example, concentrations of VOCs and SVOCs in groundwater at several monitoring wells within the pilot test area were reduced below applicable SCGs (NYSDEC AWQSGVs). Similarly, the soil sample from SB-194 indicated that concentrations were below NYSDEC RSCOs. Even if SCGs are not met within a reasonable operating timeframe due to the practical limitations of the technology, significant reductions of contaminant concentrations are expected, which meet the RAOs for the site.

6.2.3 Long-Term Effectiveness and Permanence

Description of Criteria

This criteria evaluates the long-term effectiveness of the remedy after implementation. If wastes or treated residuals remain on-site after the selected remedy has been implemented, the following items are evaluated:

- The magnitude of the remaining risks (i.e. will there be any significant threats, exposure pathways, or risks to the community and environment from the remaining wastes or treated residuals);
- The adequacy of the engineering and institutional controls intended to limit the risk;
- The reliability of these controls; and
- The ability of the remedy to continue to meet RAOs in the future.

Evaluation of Proposed Remedy

The monitoring plan for the proposed remedy will evaluate the long-term effectiveness of the remediation. The ChemOx process is expected to provide a long-term solution for the target area by treating petroleum-related contaminant concentrations in soil, groundwater and separate-phase product through multiple physical, chemical and biological processes and by enhancing recovery of separate-phase product. Therefore, if contamination does remain in the target area after implementation of the remedy, due to practical limitations of the technology, concentrations

of contaminants will be significantly reduced from present conditions. In addition, the zoning and planned future use of the Site includes continued use as a petroleum distribution terminal.

6.2.4 Reduction in Toxicity, Mobility or Volume through Treatment

Description of Criteria

Reduction in toxicity, mobility and volume of contaminants is evaluated on the basis of the estimated quantity of contamination treated, contained or destroyed, together with the estimated quantity of waste materials produced by the remediation process itself. Remedies that permanently and significantly reduce the toxicity, mobility, or volume of the wastes at the site are considered preferable.

Evaluation of Proposed Remedy

As demonstrated during the pilot test, ChemOx was successful in reducing the concentrations of petroleum-related hydrocarbons in groundwater, soil and separate-phase product. In addition, operation of the ChemOx system will enhance separate-phase product recovery efforts by making more product available for manual and/or automated recovery efforts, as evidenced by the increase in product recovery during the pilot test. The ChemOx process destroys contaminants in the various Site media (soil, groundwater and separate-phase product) through chemical (oxidation) and biological processes (aerobic bioremediation) without producing significant byproducts (some carbon monoxide is produced). The process also enhances separate-phase product recovery through physical transformations and/or changes in water table elevations that make additional product available for manual and/or automated recovery. The byproduct of this recovery process is waste petroleum that is temporarily stored onsite and ultimately disposed off-site. It is expected that several hundred gallons of separate-phase product may be recovered during the remediation.

6.2.5 Short-Term Effectiveness

Description of Criteria

Evaluation of short-term impacts and effectiveness of the selected remedy examines health and environmental risks likely to exist during the implementation of the selected remedial remedy. Principal factors for consideration include the expediency with which the alternative can be completed, potential impacts on the nearby community and on-site workers during construction,

and mitigation measures for short-term risks required during the necessary implementation period.

Evaluation of Proposed Remedy

The health and environmental risks associated with implementation of ChemOx in the target area are minimal. The total remediation process is expected to take between one and two years of active operation (phased across the target area as described below), followed by two years of long-term monitoring. With the health and safety precautions and procedures developed during the pilot test operation, the system can be operated safely and without adverse impacts to human health and the environment. Although the ChemOx process produces an exothermic reaction in the subsurface, monitoring data collected during the pilot test indicated the process did not produce subsurface conditions that would pose a threat to human health (i.e., explosive conditions, harmful vapors, excessive temperatures, etc). Continued monitoring of conditions in the subsurface to assess for health and safety concerns will be conducted during full scale operation.

6.2.6 Implementability

Description of Criteria

Evaluation of implementability examines the difficulty associated with the installation and/or operation of the alternative and the proven or perceived reliability with which the alternative can achieve system performance goals. The evaluation must examine the potential need for future remedial action, the level of oversight required by regulatory agencies, and the availability of certain technology resources required by the selected remedial alternative.

Evaluation of Proposed Remedy

The materials, equipment and personnel associated with the implementation of ChemOx are commercially available and have been proven effective and reliable for remediation of the media of concern at the Site under similar circumstances, as evidenced by the success of the pilot test in the target area. In general, the components of the remediation system can be easily constructed, maintained and operated.

6.2.7 Cost

Description of Criteria

The cost evaluation presented in this document estimates the construction and equipment, and operation and maintenance (O&M) costs, including monitoring costs, associated with the selected remedial action alternative. For cost estimating purposes, a 2-year period of operation for the entire target area and followed by 2 years of monitoring was assumed.

Evaluation of Proposed Remedy

The estimated construction and equipment costs and long-term operation, maintenance and monitoring costs for two years (approximate annual cost of \$270,000 per year) associated with the full-scale remedy are estimated as follows:

• Construction and Equipment Cost	\$560,000
• O&M Cost	\$540,000
Total Cost	<hr/> \$1,100,000

For cost estimating purposes, a two-year period of operation followed by a two year period of monitoring was assumed throughout this document.

6.2.8 Compatibility with Land Use

Description of Criteria

This criteria evaluates the compatibility of the various elements of the selected remedy with the planned future use of the Site as a petroleum storage and distribution facility.

Evaluation of Proposed Remedy

The proposed ChemOx system is compatible with the proposed continued use of the Site as a petroleum distribution terminal. As described above, initially all ChemOx injection points and monitoring wells will be located outside the bermed area, downgradient of the Tank 176. This is to verify the long-term use of the technology prior to entrance into the ongoing active operations within the berm. Five MIP borings (Figure 24) will be installed initially within the bermed area to evaluate current conditions and to determine the appropriate need for ChemOx within the tank

berm. During the monitoring phase of the ChemOx cells located outside the tank berm, the steps necessary to address impacts that may exist beneath the tank berm will be evaluated.

6.3 Operation, Maintenance and Monitoring

The following describes the general operation, maintenance and monitoring (O,M&M) procedures that will be implemented during full scale operation of the proposed ChemOx system. A more detailed description of these procedures will be provided in a stand alone O,M&M plan to be prepared in accordance with the DER-10. The O,M&M plan will be in place prior to initiation of full-scale operation.

6.3.1 Operation and Maintenance

The ChemOx mobile system is a fully automated unit, requiring minimal maintenance. Typical operational and preventative maintenance activities for the system are detailed below.

Weekly

- Inspect coolant level, inspect and clean chiller pump strainer;
- Inspect/clean coolant filter;
- Check peroxide tank for gassing (bubble formation);
- Inspect for gas, water leaks;
- Check/refill peroxide tank;
- Check peroxide pump tube for uneven ware;
- Check oxygen filter;
- Check / replace container ventilation intake filter;
- Verify operation of drain valves / clean elements;
- Transfer peroxide from 55-gallon drum or larger storage tank to trailer holding tank.

Monthly

- Check compressor intake filter;
- Check pressure swing adsorber intake filters; and
- Change injection compressor intake filters.

Quarterly

- Calibrate hydrogen peroxide pump;
- Calibrate ozone generator performance;
- Flush coolant heat exchanger;
- Lubricate chiller pump motor; and
- Clean cooling coils (dry air).

Semi-annually

- Check tension of V-Belts;
- Change A/B rings/valves (at 4000 operating hours); and
- Change peroxide pump tube.

Annually

- Check all safety relief valves;
- Inspect/tighten low voltage wiring terminations; and
- Inspect/tighten power wiring terminations.

6.3.2 Monitoring

The following is the proposed monitoring schedule for the full-scale ChemOx system. Monitoring will be conducted in the monitoring network described above for each operating ChemOx cell. At this time, operation of one cell at a time is proposed, however, this may be modified if operation of more than one cell is determined to be feasible and cost effective. The monitoring parameters described in this section will be monitored as required and may be modified based upon information gathered during the full scale system operation.

Injection System Monitoring

Throughout long-term operation, the following parameters will be recorded on a daily basis:

- Record the following operating data on log sheet;
 - System operational (Y/N)
 - Volume of Peroxide within storage tanks (gallons)
 - Run time of hydrogen peroxide pump (hours)

- Run time Injection Air Compressor A (hours)
- Run time Injection Air Compressor B (hours)
- Runtime of ozone generator (hours)
- Runtime of main air compressor (hours)
- Current Operation of Air Compressor A (Y/N)
- Current Operation of Air Compressor B (Y/N)
- Current Operation of Peroxide Pump (Y/N)
- Peroxide Pump Setting –Signal Percentage (%)
- Ozone Generator Current Operation – Power Percentage (%)
- Oxygen Flow (scfh) to ozone generator
- Oxygen Pressure (PSI) to ozone generator
- Ozone Pressure (PSI) prior to pressure control
- Ozone Pressure (PSI) after pressure control
- Injection Air Pressure (PSI)
- Injection Air Pressure (PSI)
- Injection Air Pressure (PSI)
- Hydrogen Peroxide Pressure (PSI) prior to control valve
- Hydrogen Peroxide Pressure (PSI) after control valve
- Chiller Temperature

Modifications to operating parameters will be made, as necessary, based upon the data collected.

In addition, as required, peroxide will be transferred from 55-gallon drum (or larger tank if applicable) to trailer holding tank via drum pump.

Ambient air measurements in the IRM area for VOCs will also be conducted. Periodic measurements of ambient ozone, particularly during startup, will also be conducted.

Baseline Groundwater Sampling within the Target Area and Each ChemOx Cell

A round of baseline groundwater samples will be collected from all monitoring wells in the target area (all five cells) prior to startup of the first cell. Samples will be analyzed for VOCs and SVOCs by USEPA methods 8021 and 8270, respectively. This round of sampling will serve as the baseline for the entire target area to assess the progress of the full scale remediation. If all wells throughout the target area are not yet installed at the time operation at the first cell is due to be initiated, all available wells will be sampled.

In addition, prior to initiation of operation in each subsequent cell, the monitoring wells will be sampled for VOCs and SVOCs to evaluate if any reductions from the baseline occurred that could be attributed to operation of adjacent cells. This may indicate that fewer ChemOx injection points need to be operated within a particular area to achieve RAOs.

First Two Days – Startup and Testing

The following parameters will be monitored at CO wells and monitoring wells ,as required, to evaluate radius of influence until optimum operating parameters are established. For the first two days of operation, the following parameters will be collected daily:

- Headspace: VOCs, oxygen, carbon monoxide, LEL.
- Groundwater data: temperature, ORP, dissolved oxygen (DO), carbon dioxide.
- Pressure measurements.
- Liquid levels (water and product).

Monitoring wells within adjacent ChemOx cells will be monitored for groundwater chemistry parameters during the two days of operation in each ChemOx cell to determine the extent of influence from the operating cell(s).

Long-Term Operation - Weekly Monitoring

CO injection wells and monitoring wells within each operating ChemOx Cell will be monitored for the following parameters on a weekly basis during long-term operation.

- Headspace: VOCs.
- Groundwater data: temperature, ORP, DO, carbon dioxide.

Periodic carbon monoxide and LEL readings may also be collected based upon the results of the first two days of monitoring.

Long-Term Operation - Monthly Monitoring

Groundwater quality for VOCs and SVOCs will be sampled at CO injection wells and monitoring wells within each cell each month during long-term operation.

As described above, the first phase of operation is expected to be approximately two months at each ChemOx cell (plus additional time to receive the groundwater quality results). Data from the operation of a particular cell may be used to adjust the timeframes of operation for the remaining cells.

Long-Term Operation - Membrane Interface Probe Borings

After the initial two months of operation, or based on other indications that a shorter timeframe may be appropriate (i.e., elimination of separate phase product, remediated groundwater, etc) MIP borings will be conducted at each of the locations completed during the baseline round in the active cell(s). This data will provide a qualitative assessment of the total VOCs in the subsurface after the initial operation phase, compared with the baseline data. This data, coupled with the groundwater quality data will be used to evaluate the potential for temporary shutdown a particular ChemOx Cell.

It should be noted, that MIP borings will be completed at select locations within active cells following any additional operational periods in order to continue to assess the progress of the remediation.

Temporary Shutdown

If the following criteria are met for a ChemOx Cell, it will be temporarily shut down:

- Groundwater quality data from the first two rounds of sampling indicate that significant reductions of VOCs and SVOCs have been achieved.
- VOC/SVOC removals in groundwater have reached asymptotic levels.
- MIP borings indicate significant total VOC removals.

- Separate-phase product has been reduced and/or is undergoing the apparent transformations in appearance/consistency observed during the pilot test.

Operation in the next ChemOx Cell will then commence (following baseline groundwater sampling in that cell).

If the groundwater quality, MIP data and separate-phase product do not indicate significant remediation has occurred, operation in this ChemOx Cell will continue. Monitoring during any additional operation period will be the same as described above.

Monitoring for Rebound and Additional Operation

If a ChemOx Cell met the criteria for temporary shutdown, groundwater quality within the monitoring wells in that cell will be sampled to assess if rebound of VOC and SVOC concentrations is occurring. In addition, water level and separate-phase product thickness measurements will be conducted to evaluate changes in thickness and appearance. These are the parameters that will be monitored to evaluate the progress of the remediation within the target area. The sampling frequency will depend upon field conditions encountered and the data will be used to determine if continued operation is required.

Groundwater quality samples will be collected after temporary shutdown. If concentrations of VOCs and/or SVOCs increase significantly or if separate phase product thickness increases, this cell will undergo an additional operating period. Monitoring during this additional operation period will be the same as described above.

If, after several consecutive operating periods, the concentrations of VOCs and SVOCs in groundwater continue to rebound, VOCs in the subsurface based on MIP borings do not indicate significant reductions, and separate-phase product has not been remediated, it will be assumed that operation of the ChemOx system within this cell has met the practical limit of its remediation potential. At this time, if conditions within a particular cell still warrant additional remediation, modifications to the ChemOx system will be considered and/or alternative treatment methods will be evaluated.

Long-Term Monitoring for System Decommissioning

For cells that meet the temporary shutdown criteria (following the initial or subsequent treatment periods), and that do not experience rebound (following the initial or subsequent treatment periods), the following monitoring will be conducted:

- Sample groundwater for VOCs and SVOCs
- Monitor water levels and separate phase product thickness
- Conduct MIP borings at select locations
- Sample soil at select locations in the vicinity of MIP borings, with analysis for VOCs and SVOCs by USEPA methods 8021 and 8270, respectively.

These are the parameters that will be monitored to evaluate the completion of the remediation within the target area. The sampling frequency will depend upon field conditions encountered and the data will be used to determine if continued operation is required. If conditions remain consistent with the temporary shutdown criteria, indicating that the remediation has been successful in meeting RAOs, monitoring will be discontinued on a cell-by-cell basis. Once this long term monitoring has been completed in all cells, indicating that RAOs have been met for the target area, the system will be decommissioned (i.e., piping removed and wells abandoned).

6.4 IRM Work Plan

The IRM work plan will describe the specifics regarding design and implementation of the proposed full-scale ChemOx system. It will provide additional details of system components, will describe system installation and will provide additional details regarding procedures for system decommissioning. It will follow the general report format provided in the DER-10 guidance for a remedial action work plan since the complexity of the system does not warrant full design plans and specifications.

6.5 Proposed Schedule

Preparation of the IRM work plan is currently underway. The IRM work plan will be submitted to NYSDEC for review and approval upon acceptance of this RAS . Installation of ChemOx injection points, monitoring wells, MIP borings and above ground piping is anticipated to be initiated during the first quarter of 2005, weather permitting. If practical, once all wells and equipment within individual ChemOx cells are completed, operation will begin within that cell.

Based upon this proposed approach, startup of the first ChemOx cell is anticipated during the second quarter of 2005.

Respectfully submitted,

ROUX ASSOCIATES, INC.

Wendy Shen 

Wendy Shen
Project Engineer

REMEDIAL ENGINEERING, P.C.

Noelle M. Clarke

Noelle M. Clarke, P.E.
Principal Engineer



7.0 REFERENCES

- Empire Soils Investigations, Inc. 1989a. Ground Water Monitoring Well Installation Water Level Measurements and Free Product Thickness Measurements. September 13, 1989.
- Empire Soils Investigations, Inc. 1989b. Ground Water Monitoring Well Installation Tank No. 176, Mobil Oil Refinery and Yard. December 1989.
- Empire Soils Investigations, Inc. 1990. Drive Point Piezometer Installation Tank No. 176. May 1990.
- Kosaric, Naim. 2001. Biosurfactants and Their Application for Soil Bioremediation. November 2001.
- New York State Department of Environmental Conservation, 1994. Division of Hazardous Waste Remediation. Division Technical and Administrative Guidance Memorandum: Determination of Soil Cleanup Objectives and Cleaning Levels, January 24, 1994.
- New York State Department of Environmental Conservation, 1998. Division of Water Technical and Operational Guidance Series No. 1.1.1 Ambient Water Quality Standards and Guidance Values and Groundwater Effluent Limitations, June, 1998.
- New York State Department of Environmental Conservation, 2000. April 2000 Addendum to June 1998 Division of Water Technical and Operational Guidance Series No 1.1.1 Ambient Water Quality Standards and Guidance Values and Groundwater Effluent Limitations, April, 2000.
- New York State Department of Environmental Conservation, 2000. Division of Air Resources, Guidelines for the Control of Toxic Ambient Air Contaminants (DAR-1), July 2000.
- New York State Department of Environmental Conservation, 2000. Division of Environmental Remediation, Draft Technical Guidance for Site Investigation and Remediation (DER-10), December 2002.
- New York State Department of Environmental Conservation, 2001. Revised Soil Cleanup Tables for TAGM 4046 for Gasoline and Fuel Oil Contaminated Soils, August, 2001.
- Recra Research, Inc. Mobil Oil Corporation-NYS Superfund Phase I Summary Report. September 6, 1983.
- Roux Associates, Inc. 1998. Site Facility Investigation Report, Mobil Buffalo Terminal, November 25, 1998.
- Roux Associates, Inc. 1999. Site Facility Investigation Completion Report, Mobil Buffalo Terminal, December 14, 1999.
- Roux Associates, Inc. 2000. History of Operations at Buffalo Terminal, April 26, 2000.

Roux Associates, Inc. 2001. Separate-Phase Product Investigation Report for the Eastern Tank Yard Area, June 28, 2001.

Roux Associates, Inc. 2002b. Site Investigation Completion Report, Volumes I through IV, March 12, 2002.

Roux Associates, 2002d. Work Plan for the Evaluation of Aquifer Characteristic, May 2, 2002.

Roux Associates, Inc. 2003b. Evaluation of Aquifer Characteristic, March 24, 2003

Roux Associates, Inc. 2003e. Vacuum Enhanced Recovery Pilot Test Work Plan, September 15, 2003.

URS Company, Inc. 1986. Phase II Investigation Report, Buffalo Terminal Disposal Site, City of Buffalo, Erie County, New York, NYS ID#915040. March 1986.

USEPA 1984. Buffalo New York Area Sediment Survey (BASS). United States Environmental Protection Agency, Great Lakes National Program Office. April 1984.

USEPA 1994. Assessment and Remediation of Contaminated Sediments (ARCS) Program. Pollutant Loadings to the Buffalo River Area of Concern from Inactive Hazardous Waste Sites. United States Environmental Protection Agency, Great Lakes National Program Office. May 1994.

USEPA 2004. How to Evaluate Alternative Cleanup Technologies for Underground Storage Tank Sites: A Guide for Corrective Action Plan Reviewers. (EPA 510-B-94-003; EPA 510-B-95-007; and EPA 510-R-04-002). May 2004.

Table 1. Storage Tank History for ETYA, ExxonMobil Oil Corporation, Buffalo, New York

Tank No	Size				Capacity (BBL)		Year Built	Removed	Duplicate Tank Designation Notes	Location	Product Stored	Roof Type	Shell
	Length	Width	Diameter (Feet)	Height (Feet)	Gross	Available							
Eastern Tank Yard Area													
175			130	32	68,548	63,366	1953	Existing		ETYA (Former Disposal Area)	TCC Charge/ No. 6 Fuel Oil and Cutter, No.2 Fuel Oil	Cone	Welded
176			130	30	68,548	63,366	1953	Existing		ETYA (Former Disposal Area)	TCC Charge/ No. 6 Fuel Oil and Cutter, Unleaded Gasoline	Cone	Welded
F213	46	10					1977 map	1987 map		ETYA (Former Disposal Area)	Liquefied Petroleum Gas		
F214	46	10					1977 map	1987 map		ETYA (Former Disposal Area)	Liquefied Petroleum Gas		
F215	46	10					1977 map	1987 map		ETYA (Former Disposal Area)	Liquefied Petroleum Gas		
F216	46	10					1977 map	1987 map		ETYA (Former Disposal Area)	Liquefied Petroleum Gas		

Notes:

1. Where blanks entries exist, information from the existing documentation was not available.
2. For Construction dates, an entry referencing a map or aerial photo indicates the map/aerial photo that the tank first appeared.
3. For Removal Dates, an entry referencing a map or aerial photo indicates the first map/aerial photo that the tank does not appear on.
4. Not all 1917 tanks are listed.

Table 2. Summary of Spills/Releases in the ETYA, ExxonMobil Oil Corporation, Buffalo, New York

Date of Incident	Quantity	Product	Cause/Source of Spill	Geographic Area	Media Affected	Agency Notified	Action Taken/Comments	Source	Date Spill Closed by NYSDEC
EASTERN TANK YARD AREA (ETYA - Former Disposal Area)									
8/28/1989	6500 gallons	Unleaded gasoline	Overfill from Mobil pipeline at Tank 176 due to incorrect safe fill and high alarm heights used.	ETYA	Soil	NYSDEC - #8905279 Albany & Buffalo Buffalo Fire Department	Area was barricaded; approximately 2800 gallons of product was removed with a vacuum truck; safe fill and alarm heights on tank were revised, monitoring wells installed. The containment berm for this tank and Tank 175 were lined during the	Mobil Files/ NYSDEC Spills	6/11/1991
10/4/2000	Unknown	Unknown Petroleum Product	Sheen observed along the Buffalo River shoreline adjacent to the ETYA.	ETYA	Buffalo River	NRC NYSDEC - #0075417	Installed and maintained sorbent boom since 10/4/00. Spill report from notes that this spill was closed on 10/18/00 and would be incorporated into spill No. 8808982	Mobil Files/ NYSDEC Spills	10/18/2000
SPILLS FOR WHICH THE AREA OF OCCURRENCE COULD NOT BE DETERMINED FROM AVAILABLE INFORMATION (UNKNOWN)									
7/17/1987	1 gallon	Gasoline	Gasoline found in trench excavation. (No other information)	Unknown	Unknown	NYSDEC - #8703102	Recovered one gallon.	NYSDEC Spills	8/4/1987
9/7/1989	Unknown	#2 Fuel Oil	Underground tanks failed tightness test.	Unknown	Unknown	NYSDEC - #8905567	Unknown	NYSDEC Spills	11/20/1989
2/2/1990	<1 gallon	Gasoline	Product pipeline test failure	Unknown	Unknown	NYSDEC - #8910543	Product was removed from the pipeline; location of the leak was to be located. Follow-up action by NYSDEC to be made under spill # 8808982.	NYSDEC Spills	12/7/1990
5/18/1991	15-20 gallons	Caustic	Contractor cut 3-inch pipe in pipe rack with a shear with (believed to be) caustic remaining in the pipeline	Unknown	Unknown	NYSDEC - #9101954	Drained the pipe and cleaned area; NYSDEC Spill Report Form noted no further action required.	Mobil Files/ NYSDEC Spills	5/20/1991
7/12/1990	50 gallons	Diesel Fuel	Equipment failure in the diked area (No additional information)	Unknown	Soil	NYSDEC - #9004061	NYSDEC Spill Report Form indicates spill was cleaned up by Mobil.	NYSDEC Spills	7/12/1990
3/24/1992	25 gallons	#6 Fuel Oil	Pipeline severed during construction	Unknown	Soil	NYSDEC - #9113037	Impacted soil removed and placed in the biotreatment cell, no further action required.	NYSDEC Spills	4/3/1992
3/27/1992	50 gallons	Unknown Petroleum Product	Contractor cutting up old piping released residual oil trapped in piping	Unknown	Soil	NYSDEC - #9113176	Spill cleaned up and debris placed in biotreatment cell.	NYSDEC Spills	3/31/1992
7/31/1992	15 gallons	Mixed Product	Oil/water separator overflowed due to rain	Unknown	Soil	NYSDEC - #9205006	Impacted soil removed and placed in the biotreatment cell.	NYSDEC Spills	8/3/1992
9/20/1992	10 gallons	Gasoline	Pressure valve malfunction	Unknown	Soil	NYSDEC - #9207108	Spill cleaned up, no further action required.	NYSDEC Spills	9/21/1992
10/22/1992	5 gallons	Jet Fuel	During demolition, jet fuel leaked from an out of service line	Unknown	Soil	NYSDEC - #9208484	Pipe was blanked; absorbent pads placed; impacted soil removed and placed in the biotreatment cell. No further action	NYSDEC Spills	10/23/1992
3/1/1993	Unknown	Petroleum Product	4,000 cubic yards of contaminated soil (Source not specified)	Unknown	Soil	NYSDEC - #9314328	NYSDEC Spill Report Form noted no further action required.	NYSDEC Spills	3/8/1994
6/23/1993	20 gallons	Unknown Petroleum Product	Unknown	Unknown	Soil/Stone	NYSDEC - #9303750	Soil and stone were excavated and placed in biotreatment cell, no further action required.	NYSDEC Spills	7/23/1993
7/5/1993	40 gallons	Gasoline	Equipment failure	Unknown	Soil/Stone	NYSDEC - #9304257	Impacted soil removed and replaced with new stone; repairs were made, no further action required.	NYSDEC Spills	7/23/1993
1/17/1995	10 gallons	Petroleum Product	Sewer backup due to storm water and runoff	Unknown	Sewer	NYSDEC - #9413823	One cubic yard of soil removed and placed in biotreatment cell; auto dialer installed in the event of high alarm at storm sewer lift	Mobil Files/ NYSDEC Spills	5/15/1995
5/18/1999	30	Diesel Fuel	Product Spill from a tractor trailer onto the road and in the parking lot.	Unknown	Sewer	NYSDEC - #9901860	Speedy-dri applied; contractor cleaned up debris; disposal records provided to NYSDEC; no further action required.	Mobil Files/ NYSDEC Spills	6/7/1999

**Table 3. Summary of Water-Level, Product Thickness and Product Bailing Data in the ETYA
Buffalo Terminal, ExxonMobil Oil Corporation, Buffalo, New York**

B-6MW	06/25/03	596.35		24.64		0.8	571.71		
B-6MW	07/22/03	596.35		24.81		0.8	571.54		
B-6MW	07/23/03	596.35		24.81		0.8	571.54		
B-6MW	08/27/03	596.35		24.54		0.8	571.81		
B-6MW	09/30/03	596.35		24.35		0.8	572.00		
B-6MW	10/13/03	596.35		25.56		0.8	570.79		
B-6MW	11/25/03	596.35		25.12		0.8	571.23		
B-6MW	12/31/03	596.35		24.42		0.8	571.93		
B-6MW	01/19/04	596.35		24.83		0.8	571.52		
B-6MW	01/20/04	596.35		24.83		0.8	571.52		
B-6MW	02/27/04	596.35		25.87		0.8	570.48		
B-6MW	03/31/04	596.35		25.03		0.8	571.32		
B-6MW	04/07/04	596.35		24.68		0.8	571.67		
B-6MW	05/28/04	596.35		23.87		0.8	572.48		
B-6MW	06/30/04	596.35		23.96		0.8	572.39		
LF-1S	04/07/03	596.27	26.49	26.72	0.23	0.884	569.75		
LF-1S	04/16/03	596.27	25.25	25.26	0.01	0.884	571.02		
LF-1S	04/25/03	596.27	25.46	25.9	0.44	0.884	570.76	0.125	
LF-1S	05/09/03	596.27	25.25	25.85	0.6	0.884	570.95	0.1	
LF-1S	05/19/03	596.27	25.06	25.4	0.34	0.884	571.17	0.1	
LF-1S	05/28/03	596.27	24.58	24.6	0.02	0.884	571.69		
LF-1S	06/03/03	596.27	24.85	25.34	0.49	0.884	571.36	0.1	
LF-1S	06/11/03	596.27		24.38		0.884	571.89		
LF-1S	06/18/03	596.27	24.61	24.87	0.26	0.884	571.63	0.1	
LF-1S	06/25/03	596.27	24.54	24.94	0.4	0.884	571.68	0.1	
LF-1S	07/02/03	596.27	24.65	24.71	0.06	0.884	571.61		
LF-1S	07/10/03	596.27	24.75	24.76	0.01	0.884	571.52		
LF-1S	07/18/03	596.27		24.7		0.884	571.57		
LF-1S	07/23/03	596.27		24.73		0.884	571.54		
LF-1S	07/30/03	596.27		24.75		0.884	571.52		
LF-1S	08/08/03	596.27	24.65	24.65	0	0.884	571.62		
LF-1S	08/20/03	596.27	24.68	24.75	0.07	0.884	571.58	0.06	
LF-1S	09/04/03	596.27	25.08	25.76	0.68	0.884	571.11	0.1	
LF-1S	09/12/03	596.27	25.22	26.4	1.18	0.884	570.91	0.25	
LF-1S	09/18/03	596.27	25.25	26.66	1.41	0.884	570.86	0.25	
LF-1S	09/30/03	596.27		24.68		0.884	571.59		
LF-1S	10/10/03	596.27	25.3	26.34	1.04	0.884	570.84936	0.25	
LF-1S	10/13/03	596.27	25.34	26.5	1.16	0.884	570.79544		
LF-1S	10/17/03	596.27	25.25	25.67	0.42	0.884	570.97128	0.125	
LF-1S	10/30/03	596.27				0.884		0.25	IP PROBE NOT WORKING PROPERLY
LF-1S	11/05/03	596.27	25.37	26.41	1.04	0.884	570.77936	0.33	
LF-1S	11/12/03	596.27	25.52	26.7	1.18	0.884	570.61312	0.125	
LF-1S	11/21/03	596.27	26.54	26.72	0.18	0.884	569.70912		
LF-1S	12/05/03	596.27	25.5	25.55	0.05	0.884	570.7642		
LF-1S	12/10/03	596.27				0.884			NOT GAUGED- ACCESS BLOCKED DUE TO TANK 176 CLEAN
LF-1S	12/19/03	596.27		25.06		0.884	571.21		
LF-1S	12/31/03	596.27	24.95	24.95	0	0.884	571.32		
LF-1S	01/08/04	596.27	24.76	24.76	0	0.884	571.51		
LF-1S	01/19/04	596.27		24.77		0.884	571.5		
LF-1S	02/13/04	596.27	25.34	25.35	0.01	0.884	570.92884		
LF-1S	02/27/04	596.27	25.73	26.8	1.07	0.884	570.41588	0.25	
LF-1S	03/05/04	596.27		24.45		0.884	571.82		
LF-1S	03/17/04	596.27		25.44		0.884	570.83		
LF-1S	03/29/04	596.27	25.17	25.5	0.33	0.884	571.06172	0.04	
LF-1S	04/07/04	596.27		24.56		0.884	571.71		
LF-1S	04/13/04	596.27		24.56		0.884	571.71		
LF-1S	04/23/04	596.27				0.884			NOT GAUGED- CHEMOX TEST
LF-1S	05/19/04	596.27	24.63	24.83	0.2	0.884	571.62	0.25	

**Table 3. Summary of Water-Level, Product Thickness and Product Bailing Data in the ETYA
Buffalo Terminal, ExxonMobil Oil Corporation, Buffalo, New York**

LF-1S	05/28/04	596.27				0.884			NOT GAUGED- CHEMOX TEST
LF-1S	06/04/04	596.27	25.21	25.91	0.7	0.884	570.98	0.25	
LF-1S	06/30/04	596.27	23.79	25.3	1.51	0.884	572.30	0.5	
LF-2D	04/07/03	581.83		12.19		0.8	569.64		
LF-2D	07/23/03	581.83		11.22		0.8	570.61		
LF-2D	10/13/03	581.83		11.64		0.8	570.19		
LF-2D	01/19/04	581.83		10.96		0.8	570.87		
LF-2D	04/07/04	581.83		10.15		0.8	571.68		
LF-2S	04/07/03	581.77		7.04		0.8	574.73		
LF-2S	07/23/03	581.77		9.49		0.8	572.28		
LF-2S	10/13/03	581.77		10.41		0.8	571.36		
LF-2S	01/19/04	581.77		7.49		0.8	574.28		
LF-2S	04/07/04	581.77		6.57		0.8	575.20		
LF-3	04/07/03	596.17	26.38	26.38	0	0.883	569.79		
LF-3	07/23/03	596.17	24.62	24.63	0.01	0.883	571.55		
LF-3	10/13/03	596.17	25.39	25.48	0.09	0.883	570.76947		
LF-3	01/19/04	596.17	24.92	24.97	0.05	0.883	571.24415		
LF-3	04/07/04	596.17		24.3		0.883	571.87		SHEEN PRESENT
LF-4	04/07/03	594.87		23.74		0.8	571.13		
LF-4	07/23/03	594.87		22.16		0.8	572.71		
LF-4	10/13/03	594.87		22.92		0.8	571.95		
LF-4	01/19/04	594.87		22.22		0.8	572.65		
LF-4	04/07/04	594.87		22.02		0.8	572.85		
LF-5	04/07/03	597.62		27.72		0.8	569.90		
LF-5	07/23/03	597.62		26.06		0.8	571.56		
LF-5	10/13/03	597.62		26.83		0.8	570.79		
LF-5	01/19/04	597.62		26.1		0.8	571.52		
LF-5	04/07/04	597.62		25.94		0.8	571.68		
LF-6	04/07/03	598.14	28.41	28.65	0.24	0.883	569.70		
LF-6	04/25/03	598.14	27.33	27.86	0.53	0.883	570.75	0.5	ADSORBENT SOCK REPLACED
LF-6	05/28/03	598.14	26.46	26.47	0.01	0.883	571.68	0.25	ADSORBENT SOCK PRESENT
LF-6	06/03/03	598.14	26.75	27.1	0.35	0.883	571.35	0.5	ADSORBENT SOCK PRESENT
LF-6	06/11/03	598.14	26.06	26.49	0.43	0.883	572.03	0.5	ADSORBENT SOCK PRESENT
LF-6	06/18/03	598.14	25.5	25.52	0.02	0.883	572.64	0.5	ADSORBENT SOCK PRESENT
LF-6	06/25/03	598.14	25.9	26.35	0.45	0.883	572.19	0.25	
LF-6	07/02/03	598.14	25.43	27.2	1.77	0.883	572.50	1.06	
LF-6	07/18/03	598.14	27.65	28.33	0.68	0.883	570.41	0.5	
LF-6	07/23/03	598.14	26.56	27.08	0.52	0.883	571.52		
LF-6	08/20/03	598.14	26.42	26.95	0.53	0.883	571.66	0.75	
LF-6	10/13/03	598.14	27.39	27.54	0.15	0.883	570.73245		
LF-6	11/12/03	598.14	27.53	28.12	0.59	0.883	570.54097	0.25	
LF-6	11/21/03	598.14	27.49	27.6	0.11	0.883	570.63713		
LF-6	12/05/03	598.14	27.42	27.8	0.38	0.883	570.67554	0.25	
LF-6	12/10/03	598.14				0.883			NOT GAUGED- ACCESS BLOCKED DUE TO TANK 176 CLEAN
LF-6	12/19/03	598.14	26.98	28.99	2.01	0.883	570.92483		
LF-6	12/31/03	598.14	26.9	26.91	0.01	0.883	571.23883		
LF-6	01/08/04	598.14	26.67	26.67	0	0.883	571.47		
LF-6	01/19/04	598.14		26.55		0.883	571.59		
LF-6	02/13/04	598.14	27.24	27.49	0.25	0.883	570.87075		
LF-6	02/27/04	598.14	27.85	28.2	0.35	0.883	570.24905		
LF-6	03/05/04	598.14		26.37		0.883	571.77		
LF-6	03/17/04	598.14		27.28		0.883	570.86		
LF-6	03/29/04	598.14	27.06	27.24	0.18	0.883	571.05894	0.1	
LF-6	04/07/04	598.14	26.39	26.4	0.01	0.883	571.75		
LF-6	04/13/04	598.14	26.39	26.4	0.01	0.883	571.75		
LF-6	04/23/04	598.14				0.883			NOT GAUGED- CHEMOX TEST
LF-6	05/19/04	598.14	26.43	28.1	1.67	0.883	571.51	1.5	
LF-6	05/28/04	598.14				0.883			NOT GAUGED- CHEMOX TEST

**Table 3. Summary of Water-Level, Product Thickness and Product Bailing Data in the ETYA
Buffalo Terminal, ExxonMobil Oil Corporation, Buffalo, New York**

LF-6	06/04/04	598.14	25.5	25.68	0.18	0.883	572.62	0.1	
LF-6	06/30/04	598.14	25.77	25.94	0.17	0.883	572.35		
LF-7	04/07/03	598.28		28.84		0.8	569.44		
LF-7	07/23/03	598.28		26.72		0.8	571.56		
LF-7	10/13/03	598.28		27.61		0.8	570.67		
LF-7	01/19/04	598.28		27.04		0.8	571.24		
LF-7	04/07/04	598.28		26.53		0.8	571.75		
LF-8	04/07/03	596.99		24.72		0.8	572.27		
LF-8	07/23/03	596.99		21.72		0.8	575.27		
LF-8	10/13/03	596.99		21.98		0.8	575.01		
LF-8	01/19/04	596.99		21.06		0.8	575.93		
LF-8	04/07/04	596.99		20.25		0.8	576.74		
MW-1URS	04/07/03	594.82		13.27		0.8	581.55		
MW-1URS	05/20/03	594.82		13.38		0.8	581.44		
MW-1URS	06/25/03	594.82		13.38		0.8	581.44		
MW-1URS	07/22/03	594.82		13.73		0.8	581.09		
MW-1URS	07/23/03	594.82		13.73		0.8	581.09		
MW-1URS	08/27/03	594.82		13.75		0.8	581.07		
MW-1URS	09/30/03	594.82		16.35		0.8	578.47		WELL DAMAGED ON 9/22, NEW RISER INSTALLED, NOT YET SURVEYED
MW-1URS	10/13/03	594.82		15.17		0.8	579.65		
MW-1URS	11/25/03	594.82		14.93		0.8	579.89		
MW-1URS	12/31/03	594.82		14.39		0.8	580.43		
MW-1URS	01/19/04	594.82		14.46		0.8	580.36		
MW-1URS	01/20/04	594.82		14.46		0.8	580.36		
MW-1URS	02/27/04	594.82		14.91		0.8	579.91		
MW-1URS	03/31/04	594.82		14.27		0.8	580.55		
MW-1URS	04/07/04	594.82		9.66		0.8	585.16		
MW-1URS	05/28/04	594.82		13.99		0.8	580.83		
MW-1URS	06/30/04	594.82		14.56		0.8	580.26		
MW-28	04/07/03	599.91	29.74	29.75	0.01	0.883	570.17		SOLAR-POWERED PRODUCT PUMP IN WELL SINCE 8/6/02
MW-28	04/16/03	599.91				0.883			SOLAR-POWERED PRODUCT PUMP IN WELL SINCE 8/6/02; DTP 1.05
MW-28	04/25/03	599.91	28.48	28.5	0.02	0.883	571.43		SOLAR-POWERED PRODUCT PUMP IN WELL SINCE 8/6/02; DTP 1.03
MW-28	05/09/03	599.91	28.28	28.32	0.04	0.883	571.63		SOLAR-POWERED PRODUCT PUMP IN WELL SINCE 8/6/02; DTP 1.03
MW-28	05/19/03	599.91	27.86	27.87	0.01	0.883	572.05		SOLAR-POWERED PRODUCT PUMP IN WELL SINCE 8/6/02; DTP 1.03
MW-28	05/28/03	599.91	27.62	27.9	0.28	0.883	572.26		SOLAR-POWERED PRODUCT PUMP IN WELL SINCE 8/6/02; DTP 1.02
MW-28	06/03/03	599.91	27.95	28.4	0.45	0.883	571.91		SOLAR-POWERED PRODUCT PUMP IN WELL SINCE 8/6/02; DTP 0
MW-28	06/11/03	599.91	27.57	27.7	0.13	0.883	572.32		SOLAR-POWERED PRODUCT PUMP IN WELL SINCE 8/6/02; DTP 0
MW-28	06/18/03	599.91	27.65	27.8	0.15	0.883	572.24		SOLAR-POWERED PRODUCT PUMP IN WELL SINCE 8/6/02; DTP 2.8
MW-28	06/25/03	599.91	27.48	27.74	0.26	0.883	572.40		SOLAR-POWERED PRODUCT PUMP IN WELL SINCE 8/6/02; DTP 2.8
MW-28	07/02/03	599.91				0.883			SOLAR-POWERED PRODUCT PUMP IN WELL SINCE 8/6/02; DTP 2.8
MW-28	07/10/03	599.91				0.883			SOLAR-POWERED PRODUCT PUMP IN WELL SINCE 8/6/02; DTP 2.8
MW-28	07/18/03	599.91	27.76	28.33	0.57	0.883	572.08	0.12	SOLAR-POWERED PRODUCT PUMP IN WELL SINCE 8/6/02; DTP 2.8, DOWN DUE TO BAD REEL MOTOR
MW-28	07/23/03	599.91	27.62	28.71	1.09	0.883	572.16		

**Table 3. Summary of Water-Level, Product Thickness and Product Bailing Data in the ETYA
Buffalo Terminal, ExxonMobil Oil Corporation, Buffalo, New York**

MW-28	07/30/03	599.91	27.64	28.92	1.28	0.883	572.12	0.5	SOLAR-POWERED PRODUCT PUMP IN WELL SINCE 8/6/02; DTP 2.8, DOWN DUE TO BAD REEL MOTOR
MW-28	08/08/03	599.91				0.883			SOLAR-POWERED PRODUCT PUMP IN WELL SINCE 8/6/02; DTP 2.8
MW-28	08/20/03	599.91				0.883			SOLAR-POWERED PRODUCT PUMP IN WELL SINCE 8/6/02; DTP 2.67
MW-28	09/04/03	599.91	28.35	28.45	0.1	0.883	571.55		SOLAR-POWERED PRODUCT PUMP IN WELL SINCE 8/6/02
MW-28	09/12/03	599.91				0.883			SOLAR-POWERED PRODUCT PUMP IN WELL SINCE 8/6/02; DTP 2.5
MW-28	09/18/03	599.91				0.883			SOLAR-POWERED PRODUCT PUMP IN WELL SINCE 8/6/02; DTP 2.46
MW-28	09/30/03	599.91				0.883			SOLAR-POWERED PRODUCT PUMP IN WELL SINCE 8/6/02; DTP 2.80; REMOVED DRUM AND TRANSFERRED TO 8,000 AST; 0.35 OF PRODUCT
MW-28	10/10/03	599.91				0.883			SOLAR-POWERED PRODUCT PUMP IN WELL SINCE 8/6/02; DTP 2.79
MW-28	10/13/03	599.91	28.49	28.51	0.02	0.883	571.41766		SOLAR-POWERED PRODUCT PUMP IN WELL SINCE 8/6/02
MW-28	10/17/03	599.91				0.883			SOLAR-POWERED PRODUCT PUMP IN WELL SINCE 8/6/02; DTP 2.78
MW-28	11/05/03	599.91				0.883			SOLAR-POWERED PRODUCT PUMP IN WELL SINCE 8/6/02; DTP 2.78
MW-28	11/12/03	599.91				0.883			SOLAR-POWERED PRODUCT PUMP IN WELL SINCE 8/6/02; DTP 2.76
MW-28	11/21/03	599.91				0.883			SOLAR-POWERED PRODUCT PUMP IN WELL SINCE 8/6/02; DTP 2.75
MW-28	12/05/03	599.91				0.883			SOLAR-POWERED PRODUCT PUMP IN WELL SINCE 8/6/02; DTP 2.74
MW-28	12/10/03	599.91				0.883			SOLAR-POWERED PRODUCT PUMP IN WELL SINCE 8/6/02; DTP 2.74
MW-28	12/19/03	599.91	28.13	28.15	0.02	0.883	571.77766		SOLAR-POWERED PRODUCT PUMP IN WELL SINCE 8/6/02; DTP 2.74
MW-28	12/31/03	599.91				0.883			SOLAR-POWERED PRODUCT PUMP IN WELL SINCE 8/6/02; DTP 2.74
MW-28	01/08/04	599.91				0.883			SOLAR-POWERED PRODUCT PUMP IN WELL SINCE 8/6/02; DTP 2.74
MW-28	01/19/04	599.91	28.16	28.19	0.03	0.883	571.74649		SOLAR-POWERED PRODUCT PUMP IN WELL SINCE 8/6/02
MW-28	02/13/04	599.91				0.883			SOLAR-POWERED PRODUCT PUMP IN WELL SINCE 8/6/02; DTP 2.74
MW-28	02/27/04	599.91				0.883			SOLAR-POWERED PRODUCT PUMP IN WELL SINCE 8/6/02; DTP 2.75
MW-28	03/05/04	599.91				0.883			SOLAR-POWERED PRODUCT PUMP IN WELL SINCE 8/6/02; DTP 2.74

**Table 3. Summary of Water-Level, Product Thickness and Product Bailing Data in the ETYA
Buffalo Terminal, ExxonMobil Oil Corporation, Buffalo, New York**

MW-28	03/17/04	599.91	28.41	28.42	0.01	0.883	571.49883	SOLAR-POWERED PRODUCT PUMP IN WELL SINCE 8/6/02; DTP 2.7
MW-28	03/29/04	599.91	28.04	28.08	0.04	0.883	571.86532	SOLAR-POWERED PRODUCT PUMP IN WELL SINCE 8/6/02; DTP 2.68
MW-28	04/07/04	599.91	27.56	27.6	0.04	0.883	572.35	SOLAR-POWERED PRODUCT PUMP IN WELL SINCE 8/6/02
MW-28	04/13/04	599.91		3.67		0.883	596.24	SOLAR-POWERED PRODUCT PUMP IN WELL SINCE 8/6/02; DTP 2.64. SYSTEM DOWN FOR CHEMOX TEST
MW-28	04/23/04	599.91				0.883		SOLAR-POWERED PRODUCT PUMP IN WELL SINCE 8/6/02; SYSTEM DOWN FOR CHEMOX TEST
MW-28	05/19/04	599.91	27.55	27.57	0.02	0.883	572.36	SOLAR-POWERED PRODUCT PUMP IN WELL SINCE 8/6/02;DTP 1.9
MW-28	05/28/04	599.91				0.883		SOLAR-POWERED PRODUCT PUMP IN WELL SINCE 8/6/02;DTP 1.68
MW-28	06/04/04	599.91	27.09	27.16	0.07	0.883	572.81	SOLAR-POWERED PRODUCT PUMP IN WELL SINCE 8/6/02;DTP 1.44
MW-28	06/28/04	599.91				0.883		SOLAR-POWERED PRODUCT PUMP IN WELL SINCE 8/6/02;DTP 1.15
MW-28	06/30/04	599.91				0.883		SOLAR-POWERED PRODUCT PUMP IN WELL SINCE 8/6/02;DTP 2.8- NEW DRUM CHANGED
MW-2URS	04/07/03	581.83		12.64		0.8	569.19	
MW-2URS	07/23/03	581.83		12.44		0.8	569.39	
MW-2URS	10/13/03	581.83		12.64		0.8	569.19	
MW-2URS	01/19/04	581.83		11.26		0.8	570.57	
MW-2URS	04/07/04	581.83		9.61		0.8	572.22	
MW-39	04/07/03	596.21		24.4		0.8	571.81	
MW-39	07/23/03	596.21		19.47		0.8	576.74	
MW-39	10/13/03	596.21	21.58	21.59	0.01	0.8	574.628	
MW-39	01/19/04	596.21		23.96		0.8	572.25	
MW-39	04/07/04	596.21	21.35	21.36	0.01	0.8	574.86	
MW-3URS	04/07/03	599.58		29.72		0.88	569.86	
MW-3URS	07/23/03	599.58		27.95		0.88	571.63	
MW-3URS	10/13/03	599.58		28.66		0.88	570.92	
MW-3URS	01/19/04	599.58		28.24		0.88	571.34	
MW-3URS	04/07/04	599.58		27.73		0.88	571.85	
MW-4URS	04/07/03	594.59		24.9		0.8	569.69	
MW-4URS	05/20/03	594.59		23.41		0.8	571.18	
MW-4URS	06/25/03	594.59		23.08		0.8	571.51	
MW-4URS	07/22/03	594.59		23.07		0.8	571.52	
MW-4URS	07/23/03	594.59		23.07		0.8	571.52	
MW-4URS	08/27/03	594.59		22.97		0.8	571.62	
MW-4URS	09/30/03	594.59		22.86		0.8	571.73	
MW-4URS	10/13/03	594.59		24.02		0.8	570.57	
MW-4URS	11/25/03	594.59		23.5		0.8	571.09	
MW-4URS	12/31/03	594.59		22.93		0.8	571.66	
MW-4URS	01/19/04	594.59		23.36		0.8	571.23	
MW-4URS	01/20/04	594.59		23.36		0.8	571.23	
MW-4URS	02/27/04	594.59		24.39		0.8	570.2	
MW-4URS	03/31/04	594.59		23.46		0.8	571.13	
MW-4URS	04/07/04	594.59		23.2		0.8	571.39	
MW-4URS	05/28/04	594.59		22.35		0.8	572.24	
MW-4URS	06/30/04	594.59		22.47		0.8	572.12	
MW-5URS	04/07/03	595.36		13.97		0.8	581.39	
MW-5URS	07/23/03	595.36		14.26		0.8	581.10	
MW-5URS	10/13/03	595.36		14.36		0.8	581	
MW-5URS	01/19/04	595.36				0.8		NOT GAUGED- WELL RISER BROKEN

**Table 3. Summary of Water-Level, Product Thickness and Product Bailing Data in the ETYA
Buffalo Terminal, ExxonMobil Oil Corporation, Buffalo, New York**

MW-5URS	04/07/04	595.36		9.66		0.8	585.70		WELL CASING APPROX. 30" BROKEN OFF
P-15	04/07/03	597.04	28.61	28.62	0.01	0.88	568.43		
P-15	04/16/03	597.04	26.03	26.09	0.06	0.88	571.00		
P-15	04/25/03	597.04	26.14	26.31	0.17	0.88	570.88	0.1	
P-15	05/09/03	597.04	26.1	26.3	0.2	0.88	570.92	0.1	
P-15	05/19/03	597.04	25.76	25.9	0.14	0.88	571.26	0.1	
P-15	05/28/03	597.04	25.53	25.67	0.14	0.88	571.49	0.05	
P-15	06/03/03	597.04	25.55	25.7	0.15	0.88	571.47		
P-15	06/11/03	597.04	25.31	25.54	0.23	0.88	571.70		
P-15	06/18/03	597.04	25.44	25.64	0.2	0.88	571.58		
P-15	06/25/03	597.04	25.35	25.6	0.25	0.88	571.66		
P-15	07/02/03	597.04	25.45	25.67	0.22	0.88	571.56		
P-15	07/10/03	597.04	25.5	25.85	0.35	0.88	571.50		
P-15	07/18/03	597.04	25.33	25.5	0.17	0.88	571.69		
P-15	07/23/03	597.04	25.48	25.78	0.3	0.88	571.52		
P-15	07/30/03	597.04	25.42	25.73	0.31	0.88	571.58		
P-15	08/08/03	597.04	25.4	25.72	0.32	0.88	571.60		
P-15	08/20/03	597.04	25.43	25.83	0.4	0.88	571.56	0.06	
P-15	09/04/03	597.04	25.8	26.09	0.29	0.88	571.21	0.1	
P-15	09/12/03	597.04	26.03	26.3	0.27	0.88	570.98	0.125	
P-15	09/18/03	597.04	26.03	26.46	0.43	0.88	570.96	0.125	
P-15	09/30/03	597.04	25.54	25.71	0.17	0.88	571.48	0.06	
P-15	10/10/03	597.04	26.15	26.35	0.2	0.88	570.866		
P-15	10/13/03	597.04	26.18	26.53	0.35	0.88	570.818		
P-15	10/17/03	597.04	25.96	26.32	0.36	0.88	571.0368	0.008	
P-15	11/05/03	597.04	26.36	26.5	0.14	0.88	570.6632	0.012	
P-15	11/12/03	597.04	26.38	26.6	0.22	0.88	570.6336		
P-15	11/21/03	597.04	26.2	26.23	0.03	0.88	570.8364		
P-15	12/05/03	597.04	26.4	26.65	0.25	0.88	570.61		
P-15	12/10/03	597.04				0.88			NOT GAUGED- ACCESS BLOCKED DUE TO TANK 176 CLEAN
P-15	12/19/03	597.04	25.85	25.96	0.11	0.88	571.1768	0.1	
P-15	12/31/03	597.04	25.66	25.72	0.06	0.88	571.3728		
P-15	01/08/04	597.04	26.36	26.42	0.06	0.88	570.6728		
P-15	01/19/04	597.04	25.66	25.72	0.06	0.88	571.3728		
P-15	02/13/04	597.04	26.34	26.45	0.11	0.88	570.6868		
P-15	02/27/04	597.04	25.6	25.9	0.3	0.88	571.404		
P-15	03/05/04	597.04	25.37	25.41	0.04	0.88	571.6652		
P-15	03/17/04	597.04	25.45	25.65	0.2	0.88	571.566	0.05	
P-15	03/29/04	597.04	25.95	26.15	0.2	0.88	571.066	0.04	
P-15	04/07/04	597.04	25.44	25.54	0.1	0.88	571.59		
P-15	04/13/04	597.04	25.44	25.54	0.1	0.88	571.59	0.05	
P-15	04/23/04	597.04				0.88			NOT GAUGED- CHEMOX TEST
P-15	05/19/04	597.04	25.39	25.73	0.34	0.88	571.61	0.1	
P-15	05/28/04	597.04	24.61	25.1	0.49	0.88	572.37	0.25	
P-15	06/04/04	597.04	24.72	25.33	0.61	0.88	572.25	0.1	
P-15	06/18/04	597.04	24.6	25.28	0.68	0.88	572.36	0.1	
P-15	06/30/04	597.04	24.7	25.5	0.8	0.88	572.24	0.25	
RW-8R	04/07/03	593.4		23.2		0.8	570.20		
RW-8R	07/23/03	593.4		21.62		0.8	571.78		
RW-8R	10/13/03	593.4		22.53		0.8	570.87		
RW-8R	01/19/04	593.4		21.67		0.8	571.73		
RW-8R	04/07/04	593.4		21.33		0.8	572.07		
SB-74	04/07/03	599.1		29.4		0.8	569.70		
SB-74	07/23/03	599.1		27.64		0.8	571.46		
SB-74	10/13/03	599.1		28.39		0.8	570.71		
SB-74	01/19/04	599.1		28.01		0.8	571.09		
SB-74	04/07/04	599.1		27.46		0.8	571.64		
SB-75	04/07/03	599.86		30.14		0.8	569.72		
SB-75	07/23/03	599.86		28.31		0.8	571.55		
SB-75	10/13/03	599.86		29.04		0.8	570.82		
SB-75	01/19/04	599.86		28.77		0.8	571.09		
SB-75	04/07/04	599.86		28.13		0.8	571.73		
SB-76	04/07/03	600.96		26.13		0.8	574.83		
SB-76	07/23/03	600.96		26.24		0.8	574.72		
SB-76	10/13/03	600.96		26.24		0.8	574.72		
SB-76	01/19/04	600.96		26.38		0.8	574.58		
SB-76	04/07/04	600.96		26		0.8	574.96		
SB-78	04/07/03	598.97		22.29		0.8	576.68		
SB-78	05/20/03	598.97		22.2		0.8	576.77		

**Table 3. Summary of Water-Level, Product Thickness and Product Bailing Data in the ETYA
Buffalo Terminal, ExxonMobil Oil Corporation, Buffalo, New York**

SB-78	06/25/03	598.97		22.32		0.8	576.65		
SB-78	07/22/03	598.97		22.3		0.8	576.67		
SB-78	07/23/03	598.97		22.3		0.8	576.67		
SB-78	08/27/03	598.97		22.53		0.8	576.44		
SB-78	09/30/03	598.97		22.66		0.8	576.31		
SB-78	10/13/03	598.97		22.43		0.8	576.54		
SB-78	11/25/03	598.97		22.37		0.8	576.6		
SB-78	12/31/03	598.97		22.31		0.8	576.66		
SB-78	01/19/04	598.97		22.41		0.8	576.56		
SB-78	01/20/04	598.97		22.41		0.8	576.56		
SB-78	02/27/04	598.97		22.74		0.8	576.23		
SB-78	03/31/04	598.97		22.16		0.8	576.81		
SB-78	04/07/04	598.97		21.99		0.8	576.98		
SB-78	05/28/04	598.97		21.35		0.8	577.62		
SB-78	06/30/04	598.97		22.25		0.8	576.72		
SB-79	04/07/03	599.26		27.48		0.8	571.78		
SB-79	06/26/03	599.26		26.81		0.8	572.45		VISUAL INSPECTION WELL- RUST
SB-79	07/23/03	599.26		26.83		0.8	572.43		
SB-79	10/13/03	599.26		27.11		0.8	572.15		
SB-79	01/19/04	599.26		26.72		0.8	572.54		
SB-79	04/07/04	599.26		25.6		0.8	573.66		
SB-80	04/07/03	599.11		26.61		0.8	572.50		
SB-80	06/26/03	599.11		25.93		0.8	573.18		VISUAL INSPECTION WELL- CLEAR
SB-80	07/23/03	599.11		26.22		0.8	572.89		
SB-80	10/13/03	599.11		26.55		0.8	572.56		
SB-80	01/19/04	599.11		25.74		0.8	573.37		SHEEN PRESENT
SB-80	04/07/04	599.11		25.11		0.8	574.00		
SB-81	04/07/03	597.81		25.79		0.8	572.02		
SB-81	06/26/03	597.81		24.88		0.8	572.93		VISUAL INSPECTION WELL- RUST
SB-81	07/23/03	597.81		25.28		0.8	572.53		
SB-81	10/13/03	597.81		26.45		0.8	571.36		
SB-81	01/19/04	597.81		25.23		0.8	572.58		
SB-81	04/07/04	597.81		24.32		0.8	573.49		
SB-82	04/07/03	596.83		25.86		0.8	570.97		
SB-82	06/26/03	596.83		23.7		0.8	573.13		VISUAL INSPECTION WELL- CLEAR
SB-82	07/23/03	596.83		24.04		0.8	572.79		
SB-82	10/13/03	596.83		25.52		0.8	571.31		
SB-82	01/19/04	596.83		24.11		0.8	572.72		
SB-82	04/07/04	596.83		23.18		0.8	573.65		
SB-83	04/07/03	596.61		23.04		0.8	573.57		
SB-83	06/26/03	596.61		22.85		0.8	573.76		VISUAL INSPECTION WELL- CLEAR
SB-83	07/23/03	596.61		23.29		0.8	573.32		
SB-83	10/13/03	596.61		23.72		0.8	572.89		
SB-83	01/19/04	596.61		22.67		0.8	573.94		
SB-83	04/07/04	596.61		21.67		0.8	574.94		
SB-84	04/07/03	594.55		20.96		0.8	573.59		
SB-84	06/26/03	594.55		17.75		0.8	576.80		VISUAL INSPECTION WELL- CLEAR
SB-84	07/23/03	594.55		21.14		0.8	573.41		
SB-84	10/13/03	594.55		21.61		0.8	572.94		
SB-84	01/19/04	594.55		20.64		0.8	573.91		
SB-84	04/07/04	594.55		19.86		0.8	574.69		
SB-85	04/07/03	593.65		17.3		0.8	576.35		
SB-85	07/23/03	593.65		18.12		0.8	575.53		
SB-85	10/13/03	593.65		18.09		0.8	575.56		
SB-85	01/19/04	593.65		17.1		0.8	576.55		
SB-85	04/07/04	593.65		16.25		0.8	577.40		
SB-86	04/07/03	582.53		7.26		0.8	575.27		
SB-86	07/23/03	582.53		7.94		0.8	574.59		
SB-86	10/13/03	582.53		8.02		0.8	574.51		
SB-86	01/19/04	582.53		6.89		0.8	575.64		
SB-86	04/07/04	582.53		5.89		0.8	576.64		
W-1	04/07/03	595.98		17.44		0.8	578.54		
W-1	07/23/03	595.98		17.46		0.8	578.52		
W-1	10/13/03	595.98		17.55		0.8	578.43		
W-1	01/19/04	595.98		17.41		0.8	578.57		
W-1	04/07/04	595.98		16.96		0.8	579.02		

Table 4. Summary of Offgas Vapor Quality Data Collected during VER Pilot Test

Parameter	Units	Sample Designation: Sample Date:	PILOT STUDY LF-6 10/23/03
Benzene	mg/m ³		1.62
Toluene	mg/m ³		0.508 U
Ethyl benzene	mg/m ³		0.508 U
Xylenes (total)	mg/m ³		1.52 U
Total BTEX:	mg/m ³		1.62
MTBE	mg/m ³		1.52
TRPH (C1-C4)	mg/m ³		1870
TRPH Lo >C4-C10	mg/m ³		31

mg/m³ - milligrams per cubic meter
 TRPH - Total Recoverable Petroleum Hydrocarbons
 MTBE - Methyl Tertiary Butyl Ether
 BTEX - Benzene, Toluene, Ethylbenzene, Xylenes (total)
 U - Not detected

Table 5. Summary of Extracted Groundwater Quality Data Collected during VER Pilot Test

Parameter	Units	Sample Designation: Sample Date:	PILOT STUDY LF-6 10/23/03
Metals			
Calcium	µg/L		142000
Lead	µg/L		5 U
Magnesium	µg/L		26100
Manganese	µg/L		898
SVOCs			
Acenaphthene	µg/L		10 U
Acenaphthylene	µg/L		10 U
Anthracene	µg/L		10 U
Benzo[a]anthracene	µg/L		10 U
Benzo[a]pyrene	µg/L		10 U
Benzo[b]fluoranthene	µg/L		10 U
Benzo[g,h,i]perylene	µg/L		10 U
Benzo[k]fluoranthene	µg/L		10 U
Chrysene	µg/L		10 U
Dibenzo[a,h]anthracene	µg/L		10 U
Fluoranthene	µg/L		10 U
Fluorene	µg/L		24.5
Indeno[1,2,3-cd]pyrene	µg/L		10 U
Naphthalene	µg/L		10 U
Phenanthrene	µg/L		80
Pyrene	µg/L		10 U
VOCs			
Benzene	µg/L		4.4
Toluene	µg/L		3.7
Ethylbenzene	µg/L		1 U
Xylenes (total)	µg/L		10
Total BTEX	µg/L		18.1
1,2,4-Trimethylbenzene	µg/L		4.1
1,3,5-Trimethylbenzene	µg/L		3.1
Isopropylbenzene	µg/L		1 U
MTBE	µg/L		4.4
Naphthalene	µg/L		15.4
n-Butylbenzene	µg/L		1
n-Propylbenzene	µg/L		1 U
p-Isopropyltoluene	µg/L		1 U
sec-Butylbenzene	µg/L		1 U
tert-Butylbenzene	µg/L		1 U
Miscellaneous Groundwater Chemistry Parameters			
Alkalinity as CaCO ₃	mg/L		526000
Ferrous Iron	µg/L		19600
Hardness	mg/L		462000
Oil & Grease as HEM	mg/L		5200
Solids, Total Dissolved	mg/L		536000
Total Organic Carbon	mg/L		8990
Total Suspended Solids	mg/L		72000

µg/L - micrograms per liter

mg/L - milligrams per liter

SVOCs - Semivolatile Organic Compounds

VOCs - Volatile Organic Compounds

U - Not detected

Table 6. Summary of Volatile Organic Compounds Detected in Groundwater Samples for the Chemical Oxidation Pilot Study, ExxonMobil Corporation, Buffalo Terminal, Buffalo, New York.

Parameter (Concentrations in µg/L)	Sample Designation:	CO-1	CO-1	CO-1	CO-1	CO-1	CO-1
	Sample Date:	04/05/04	05/11/04	05/18/04	05/25/04	06/01/04	06/22/04
Benzene		99.9	14.5	4.9	4.8	10.1	9.1
Toluene		1 U	1 U	1 U	1 U	1 U	1 U
Ethylbenzene		1 U	1 U	1 U	1 U	1 U	1 U
Xylenes (total)		1 U	1 U	1 U	1 U	1 U	1 U
Total BTEX:		99.9	14.5	4.9	4.8	10.1	9.1
1,2,4-Trimethylbenzene		2.4	1 U	2	1.9	5.7	7.2
1,3,5-Trimethylbenzene		2.2	1 U	1 U	1 U	1 U	1
4-Isopropyltoluene		1.6	1 U	1 U	1 U	3	1 U
Isopropylbenzene		2	1 U	1 U	1 U	1 U	1 U
MTBE		9.3	1 U	1.6	3.2	3.1	3.2
n-Butylbenzene		5.1	1 U	1 U	1 U	1 U	2
n-Propylbenzene		3.4	1 U	1 U	1 U	1 U	1.4
Naphthalene		5 U	5 U	5 U	5 U	5 U	5 U
sec-Butylbenzene		6.4	1 U	1 U	1.5	1 U	1.4
tert-Butylbenzene		1 U	1 U	1 U	1.1	1 U	1.1
Total VOCs:		132.3	14.5	8.5	12.5	21.9	26.4

Notes:

µg/L - Micrograms per liter

U - The analyte was analyzed for, but not detected above the reported quantitation limit.

Table 6. Summary of Volatile Organic Compounds Detected in Groundwater Samples for the Chemical Oxidation Pilot Study, ExxonMobil Corporation, Buffalo Terminal, Buffalo, New York.

Parameter (Concentrations in µg/L)	Sample Designation:	CO-2	CO-2	CO-2	CO-2	CO-2	CO-2
	Sample Date:	04/05/04	05/11/04	05/18/04	05/25/04	06/01/04	06/22/04
Benzene		1.9	2.6	1 U	1 U	2.6	1.3
Toluene		1 U	1 U	1 U	1 U	1 U	1 U
Ethylbenzene		1 U	1 U	1 U	1 U	1 U	1 U
Xylenes (total)		1 U	1 U	1 U	1 U	1 U	1 U
Total BTEX:		1.9	2.6	0	0	2.6	1.3
1,2,4-Trimethylbenzene		1 U	1 U	1 U	1 U	1 U	1 U
1,3,5-Trimethylbenzene		1.4	1 U	1 U	1 U	1 U	1 U
4-Isopropyltoluene		1.4	1 U	1 U	1 U	1 U	1 U
Isopropylbenzene		1 U	1 U	1 U	1 U	1 U	1 U
MTBE		1 U	1	1 U	1.1	1 U	1.1
n-Butylbenzene		2.4	1 U	1 U	1 U	1 U	1 U
n-Propylbenzene		1.6	1 U	1 U	1 U	1 U	1 U
Naphthalene		5 U	5 U	5 U	5 U	5 U	5 U
sec-Butylbenzene		3.6	1 U	1 U	1 U	1 U	1 U
tert-Butylbenzene		1 U	1 U	1 U	1 U	1 U	1 U
Total VOCs:		12.3	3.6	0	1.1	2.6	2.4

Notes:

µg/L - Micrograms per liter

U - The analyte was analyzed for, but not detected above the reported quantitation l

Table 6. Summary of Volatile Organic Compounds Detected in Groundwater Samples for the Chemical Oxidation Pilot Study, ExxonMobil Corporation, Buffalo Terminal, Buffalo, New York.

Parameter (Concentrations in µg/L)	Sample Designation:	CO-3	CO-3	CO-3	CO-3	CO-3	CO-3
	Sample Date:	04/05/04	05/11/04	05/18/04	05/25/04	06/01/04	06/22/04
Benzene		17.1	29.1	56	42.8	178	189
Toluene		1 U	1 U	1 U	1 U	1 U	1.1
Ethylbenzene		1 U	1 U	1 U	1 U	1 U	1 U
Xylenes (total)		1.3	1 U	1 U	1 U	1 U	1 U
Total BTEX:		18.4	29.1	56	42.8	178	190.1
1,2,4-Trimethylbenzene		1 U	1 U	1 U	1 U	1 U	1 U
1,3,5-Trimethylbenzene		1 U	1 U	1 U	1 U	1 U	1 U
4-Isopropyltoluene		1.6	1 U	1 U	1 U	1 U	1 U
Isopropylbenzene		1.8	1 U	1 U	1 U	1 U	1 U
MTBE		15.9	6.7	8.2	7.9	9.2	6.7
n-Butylbenzene		5.1	1 U	1 U	1 U	1 U	1 U
n-Propylbenzene		2.2	1 U	1 U	1 U	1 U	1 U
Naphthalene		5.4	5 U	5 U	5 U	5 U	5 U
sec-Butylbenzene		7.2	1 U	1 U	1.1	1 U	1 U
tert-Butylbenzene		1 U	1.2	1 U	1 U	1 U	1 U
Total VOCs:		57.6	37	64.2	51.8	187.2	196.8

Notes:

µg/L - Micrograms per liter

U - The analyte was analyzed for, but not detected above the reported quantitation l

Table 6. Summary of Volatile Organic Compounds Detected in Groundwater Samples for the Chemical Oxidation Pilot Study, ExxonMobil Corporation, Buffalo Terminal, Buffalo, New York.

Parameter (Concentrations in µg/L)	Sample Designation:	CO-4	CO-4	CO-4	CO-4	CO-4	CO-4
	Sample Date:	04/05/04	05/11/04	05/18/04	05/25/04	06/01/04	06/22/04
Benzene		164	3.9	1 U	35.9	30.2	31.5
Toluene		1.4	1 U	1 U	1 U	1 U	1 U
Ethylbenzene		1 U	1 U	1 U	1 U	1 U	1 U
Xylenes (total)		1 U	1 U	1 U	1 U	1 U	1 U
Total BTEX:		165.4	3.9	0	35.9	30.2	31.5
1,2,4-Trimethylbenzene		1 U	1 U	1 U	1 U	1 U	1 U
1,3,5-Trimethylbenzene		1.7	1 U	1 U	1 U	1 U	1 U
4-Isopropyltoluene		1.5	1 U	1 U	1 U	1 U	1 U
Isopropylbenzene		3.5	1 U	1 U	1 U	1 U	1 U
MTBE		20.8	6.1	1 U	5.8	4.7	5.6
n-Butylbenzene		3.3	1 U	1 U	1 U	1 U	1 U
n-Propylbenzene		3.8	1 U	1 U	1 U	1 U	1 U
Naphthalene		5 U	5 U	5 U	5 U	5 U	5 U
sec-Butylbenzene		4.7	1 U	1 U	1	1 U	1 U
tert-Butylbenzene		1 U	1 U	1 U	1 U	1 U	1 U
Total VOCs:		204.7	10	0	42.7	34.9	37.1

Notes:

µg/L - Micrograms per liter

U - The analyte was analyzed for, but not detected above the reported quantitation l

Table 6. Summary of Volatile Organic Compounds Detected in Groundwater Samples for the Chemical Oxidation Pilot Study, ExxonMobil Corporation, Buffalo Terminal, Buffalo, New York.

Parameter (Concentrations in µg/L)	Sample Designation:	CO-5	CO-5	CO-5	CO-5	CO-5	CO-5
	Sample Date:	04/05/04	05/11/04	05/18/04	05/25/04	06/01/04	06/22/04
Benzene		65.8	10.6	11.9	4.4	4.3	1 U
Toluene		1 U	1 U	1 U	1 U	1 U	1 U
Ethylbenzene		1 U	1 U	1 U	1 U	1 U	1 U
Xylenes (total)		1 U	1 U	1 U	1 U	1 U	1 U
Total BTEX:		65.8	10.6	11.9	4.4	4.3	0
1,2,4-Trimethylbenzene		1 U	1 U	1 U	1 U	1 U	1 U
1,3,5-Trimethylbenzene		1.8	1 U	1 U	1 U	1 U	1 U
4-Isopropyltoluene		1.5	1 U	1 U	1 U	1 U	1 U
Isopropylbenzene		1 U	1 U	1 U	1 U	1 U	1 U
MTBE		16	3.9	3.8	3.6	2.5	1 U
n-Butylbenzene		2.4	1 U	1 U	1 U	1 U	1 U
n-Propylbenzene		1.7	1 U	1 U	1 U	1 U	1 U
Naphthalene		5 U	5 U	5 U	5 U	5 U	5 U
sec-Butylbenzene		3.8	1 U	1 U	1 U	1 U	1 U
tert-Butylbenzene		1 U	1 U	1 U	1.5	1 U	1 U
Total VOCs:		93	14.5	15.7	9.5	6.8	0

Notes:

µg/L - Micrograms per liter

U - The analyte was analyzed for, but not detected above the reported quantitation level

Table 6. Summary of Volatile Organic Compounds Detected in Groundwater Samples for the Chemical Oxidation Pilot Study, ExxonMobil Corporation, Buffalo Terminal, Buffalo, New York.

Parameter (Concentrations in µg/L)	Sample Designation:	LF-1S	MW-3URS	MW-3URS	MW-3URS	MW-3URS
	Sample Date:	04/05/04	04/05/04	05/11/04	05/18/04	05/25/04
Benzene						
Toluene		42	22.5	32.3	38.1	38.3
Ethylbenzene		1 U	1.2	1.6	1.6	2.3
Xylenes (total)		1.5	1 U	1 U	1 U	1 U
Total BTEX:		5.3	1.4	1 U	1 U	1 U
		48.8	25.1	33.9	39.7	40.6
1,2,4-Trimethylbenzene						
1,3,5-Trimethylbenzene		568	1 U	1 U	1 U	1 U
4-Isopropyltoluene		6.9	2.7	3.3	1 U	2.1
Isopropylbenzene		16.5	4.1	8.7	1 U	4.8
MTBE		14.5	3.2	3.8	1	4.3
n-Butylbenzene		3.3	4	1 U	1 U	1.9
n-Propylbenzene		21.3	8	10.7	3	11.5
Naphthalene		16	4.3	3.8	2.2	3.2
sec-Butylbenzene		22.9	11.9	35.3	5 U	32
tert-Butylbenzene		16.4	10.2	13.4	2.3	16.8
		6.4	2	4	1 U	5.7
Total VOCs:		741	75.5	116.9	48.2	122.9

Notes:

µg/L - Micrograms per liter

U - The analyte was analyzed for, but not detected above the reported quantitation l

Table 6. Summary of Volatile Organic Compounds Detected in Groundwater Samples for the Chemical Oxidation Pilot Study, ExxonMobil Corporation, Buffalo Terminal, Buffalo, New York.

Parameter (Concentrations in µg/L)	Sample Designation:	MW-3URS	MW-3URS	RW-8R	RW-8R	RW-8R	RW-8R
	Sample Date:	06/01/04	06/22/04	04/05/04	05/11/04	05/18/04	05/25/04
Benzene		39.6	40.9	14	10.2	12.6	10.4
Toluene		2.2	2	1 U	1 U	1 U	1 U
Ethylbenzene		1 U	1 U	1 U	1 U	1 U	1 U
Xylenes (total)		4	1 U	1 U	1 U	1 U	1 U
Total BTEX:		45.8	42.9	14	10.2	12.6	10.4
1,2,4-Trimethylbenzene		1 U	2.8	1 U	1 U	1 U	1 U
1,3,5-Trimethylbenzene		5.7	1 U	1.4	1 U	1 U	1 U
4-Isopropyltoluene		14	1 U	1 U	1 U	1 U	1 U
Isopropylbenzene		5.3	1.1	2	1.6	1.8	2.4
MTBE		1.9	1.3	4.9	1 U	1 U	1
n-Butylbenzene		13.3	2.8	3.3	2.1	1.7	2.7
n-Propylbenzene		3.8	2.6	2.2	1.1	1.5	1.2
Naphthalene		40.4	5 U	5.1	5 U	5 U	5 U
sec-Butylbenzene		21.9	2.5	4.5	1.3	1.5	3.9
tert-Butylbenzene		5.4	1 U	1 U	1 U	1 U	1 U
Total VOCs:		157.5	56	37.4	16.3	19.1	21.6

Notes:

µg/L - Micrograms per liter

U - The analyte was analyzed for, but not detected above the reported quantitation level

Table 6. Summary of Volatile Organic Compounds Detected in Groundwater Samples for the Chemical Oxidation Pilot Study, ExxonMobil Corporation, Buffalo Terminal, Buffalo, New York.

Parameter (Concentrations in µg/L)	Sample Designation:	RW-8R	RW-8R	VERMW-1	VERMW-1	VERMW-1	VERMW-1
	Sample Date:	06/01/04	06/22/04	04/05/04	05/11/04	05/18/04	05/25/04
Benzene		13.6	9.2	174	8	6.9	1.9
Toluene		1 U	1 U	1.4	1 U	1 U	1 U
Ethylbenzene		1 U	1 U	1 U	1 U	1 U	1 U
Xylenes (total)		1 U	1 U	1 U	1 U	1 U	1 U
Total BTEX:		13.6	9.2	175.4	8	6.9	1.9
1,2,4-Trimethylbenzene		1 U	1 U	2.5	1 U	1 U	1 U
1,3,5-Trimethylbenzene		1 U	1 U	2	1 U	1 U	1 U
4-Isopropyltoluene		1 U	1 U	1.9	1 U	1 U	1 U
Isopropylbenzene		2.6	1.7	3.6	1.4	1 U	1 U
MTBE		1.2	1 U	12.6	1 U	1 U	1.1
n-Butylbenzene		3.2	2	7	1.7	1 U	1 U
n-Propylbenzene		1.8	1.6	5.2	1 U	1 U	1 U
Naphthalene		5 U	5 U	6.7	5 U	5 U	5 U
sec-Butylbenzene		4.3	1.7	7.3	1.9	1 U	1 U
tert-Butylbenzene		1 U	1 U	1.1	1	1 U	1 U
Total VOCs:		26.7	16.2	225.3	14	6.9	3

Notes:

µg/L - Micrograms per liter

U - The analyte was analyzed for, but not detected above the reported quantitation level

Table 6. Summary of Volatile Organic Compounds Detected in Groundwater Samples for the Chemical Oxidation Pilot Study, ExxonMobil Corporation, Buffalo Terminal, Buffalo, New York.

Parameter (Concentrations in µg/L)	Sample Designation:	VERMW-1	VERMW-1	VERMW-2	VERMW-2	VERMW-2	VERMW-2
	Sample Date:	06/01/04	06/22/04	04/05/04	05/11/04	05/18/04	05/25/04
Benzene		7.6	5.1	238	1 U	1 U	1 U
Toluene		1 U	1 U	1 U	1 U	1 U	1 U
Ethylbenzene		1 U	1 U	1 U	1 U	1 U	1 U
Xylenes (total)		1 U	1 U	1 U	1 U	1 U	1 U
Total BTEX:		7.6	5.1	238	0	0	0
1,2,4-Trimethylbenzene		1 U	1 U	4.1	1 U	1 U	1 U
1,3,5-Trimethylbenzene		1 U	1 U	1 U	1 U	1 U	1 U
4-Isopropyltoluene		1 U	1 U	1.8	1 U	1 U	1 U
Isopropylbenzene		1 U	1 U	5.2	1 U	1 U	1 U
MTBE		1.6	1 U	14.4	1 U	1 U	1 U
n-Butylbenzene		1 U	1 U	9.3	1 U	1 U	1 U
n-Propylbenzene		1 U	1 U	8.5	1 U	1 U	1 U
Naphthalene		5 U	5 U	5.3	5 U	5 U	5 U
sec-Butylbenzene		1.2	1 U	8.4	1 U	1 U	1 U
tert-Butylbenzene		1 U	1 U	1	1 U	1 U	1 U
Total VOCs:		10.4	5.1	296	0	0	0

Notes:

µg/L - Micrograms per liter

U - The analyte was analyzed for, but not detected above the reported quantitation l

Table 6. Summary of Volatile Organic Compounds Detected in Groundwater Samples for the Chemical Oxidation Pilot Study, ExxonMobil Corporation, Buffalo Terminal, Buffalo, New York.

Parameter (Concentrations in µg/L)	Sample Designation:	VERMW-2	VERMW-2	VERMW-3	VERMW-4
	Sample Date:	06/01/04	06/22/04	04/05/04	06/22/04
Benzene		1 U	1 U	318	1 U
Toluene		1 U	1 U	1.1	1 U
Ethylbenzene		1 U	1 U	1.1	1 U
Xylenes (total)		1 U	1 U	1.3	1 U
Total BTEX:		0	0	321.5	0
1,2,4-Trimethylbenzene		1 U	1 U	14.7	1 U
1,3,5-Trimethylbenzene		1 U	1 U	1 U	1 U
4-Isopropyltoluene		1 U	1 U	2.7	1 U
Isopropylbenzene		1 U	1 U	6	1 U
MTBE		1 U	1 U	19.5	1 U
n-Butylbenzene		1 U	1 U	11.9	1 U
n-Propylbenzene		1 U	1 U	9.4	1 U
Naphthalene		5 U	5 U	7.8	5 U
sec-Butylbenzene		1 U	1 U	10.2	1 U
tert-Butylbenzene		1 U	1 U	1.7	1 U
Total VOCs:		0	0	405.4	

Notes:

µg/L - Micrograms per liter

U - The analyte was analyzed for, but not detected above the reported quantitation level

Table 7. Summary of Semivolatile Organic Compounds Detected in Groundwater Samples for the Chemical Oxidation Pilot Study, ExxonMobil Corporation, Buffalo Terminal, Buffalo, New York.

Parameter (Concentrations in µg/L)	Sample Designation:	CO-1	CO-1	CO-1	CO-1	CO-1	CO-1
	Sample Date:	04/05/04	05/11/04	05/18/04	05/25/04	06/01/04	06/22/04
Acenaphthene		3.3	2 U	2 U	2 U	2 U	2.2 U
Acenaphthylene		2.4 U	NA	2 U	NA	2 U	2.2 U
Anthracene		2.4 U	2 U	2 U	2 U	2 U	2.2 U
Benzo[a]anthracene		2.4 U	2 U	2 U	2 U	2 U	2.2 U
Benzo[a]pyrene		2.4 U	2 U	2 U	2 U	2 U	2.2 U
Benzo[b]fluoranthene		2.4 U	2 U	2 U	2 U	2 U	2.2 U
Benzo[g,h,i]perylene		2.4 U	2 U	2 U	2 U	2 U	2.2 U
Benzo[k]fluoranthene		2.4 U	2 U	2 U	2 U	2 U	2.2 U
Chrysene		2.4 U	2 U	2 U	2 U	2 U	2.2 U
Dibenzo[a,h]anthracene		2.4 U	2 U	2 U	2 U	2 U	2.2 U
Fluoranthene		2.4 U	2 U	2 U	2 U	2 U	2.2 U
Fluorene		2.8	2 U	2 U	2 U	2 U	2.2 U
Indeno[1,2,3-cd]pyrene		2.4 U	2 U	2 U	2 U	2 U	2.2 U
Naphthalene		2.4 U	2 U	2 U	2 U	2 U	2.2 U
Phenanthrene		2.4 U	2 U	2 U	2 U	2 U	2.2 U
Pyrene		2.4 U	2 U	2 U	2 U	2 U	2.2 U
Total SVOCs:		6.1	0	0	0	0	0

Notes:

µg/L - Micrograms per liter

U - The analyte was analyzed for, but not detected above the reported quantitation limit.

NA - Not analyzed

Table 7. Summary of Semivolatile Organic Compounds Detected in Groundwater Samples for the Chemical Oxidation Pilot Study, ExxonMobil Corporation, Buffalo Terminal, Buffalo, New York.

Parameter (Concentrations in µg/L)	Sample Designation:	CO-2	CO-2	CO-2	CO-2	CO-2	CO-2
	Sample Date:	04/05/04	05/11/04	05/18/04	05/25/04	06/01/04	06/22/04
Acenaphthene		2 U	2 U	2 U	2 U	7.7	2 U
Acenaphthylene		2 U	NA	2 U	NA	2.3 U	2 U
Anthracene		2 U	2 U	2 U	2 U	2.3 U	2 U
Benzo[a]anthracene		2 U	2 U	2 U	2 U	2.3 U	2 U
Benzo[a]pyrene		2 U	2 U	2 U	2 U	2.3 U	2 U
Benzo[b]fluoranthene		2 U	2 U	2 U	2 U	2.3 U	2 U
Benzo[g,h,i]perylene		2 U	2 U	2 U	2 U	2.3 U	2 U
Benzo[k]fluoranthene		2 U	2 U	2 U	2 U	2.3 U	2 U
Chrysene		2 U	2 U	2 U	2 U	2.3 U	2 U
Dibenzo[a,h]anthracene		2 U	2 U	2 U	2 U	2.3 U	2 U
Fluoranthene		2 U	2 U	2 U	2 U	2.3 U	2 U
Fluorene		2 U	2 U	2 U	2 U	10.7	2 U
Indeno[1,2,3-cd]pyrene		2 U	2 U	2 U	2 U	2.3 U	2 U
Naphthalene		2 U	2 U	2 U	2 U	2.3 U	2 U
Phenanthrene		2 U	2 U	2 U	2 U	17.4	2 U
Pyrene		2 U	2 U	2 U	2 U	2.3 U	2 U
Total SVOCs:		0	0	0	0	35.8	0

Notes:

µg/L - Micrograms per liter

U - The analyte was analyzed for, but not detected above the reported quantitation limit.

NA - Not analyzed

Table 7. Summary of Semivolatile Organic Compounds Detected in Groundwater Samples for the Chemical Oxidation Pilot Study, ExxonMobil Corporation, Buffalo Terminal, Buffalo, New York.

Parameter (Concentrations in µg/L)	Sample Designation:	CO-3	CO-3	CO-3	CO-3	CO-3	CO-3
	Sample Date:	04/05/04	05/11/04	05/18/04	05/25/04	06/01/04	06/22/04
Acenaphthene		3.6	2 U	2.2 U	2 U	2.2 U	2.2 U
Acenaphthylene		2 U	NA	2.2 U	NA	2.2 U	2.2 U
Anthracene		2 U	2 U	2.2 U	2 U	2.2 U	2.2 U
Benzo[a]anthracene		2 U	2 U	2.2 U	2 U	2.2 U	2.2 U
Benzo[a]pyrene		2 U	2 U	2.2 U	2 U	2.2 U	2.2 U
Benzo[b]fluoranthene		2 U	2 U	2.2 U	2 U	2.2 U	2.2 U
Benzo[g,h,i]perylene		2 U	2 U	2.2 U	2 U	2.2 U	2.2 U
Benzo[k]fluoranthene		2 U	2 U	2.2 U	2 U	2.2 U	2.2 U
Chrysene		2 U	2 U	2.2 U	2 U	2.2 U	2.2 U
Dibenzo[a,h]anthracene		2 U	2 U	2.2 U	2 U	2.2 U	2.2 U
Fluoranthene		2 U	2 U	2.2 U	2 U	2.2 U	2.2 U
Fluorene		2.6	2 U	2.2 U	2 U	2.2 U	2.2 U
Indeno[1,2,3-cd]pyrene		2 U	2 U	2.2 U	2 U	2.2 U	2.2 U
Naphthalene		2 U	2 U	2.2 U	2 U	2.2 U	2.2 U
Phenanthrene		2 U	2 U	2.2 U	2 U	2.2 U	2.2 U
Pyrene		2 U	2 U	2.2 U	2 U	2.2 U	2.2 U
Total SVOCs:		6.2	0	0	0	0	0

Notes:

µg/L - Micrograms per liter

U - The analyte was analyzed for, but not detected above the reported quantitation limit.

NA - Not analyzed

Table 7. Summary of Semivolatile Organic Compounds Detected in Groundwater Samples for the Chemical Oxidation Pilot Study, ExxonMobil Corporation, Buffalo Terminal, Buffalo, New York.

Parameter (Concentrations in µg/L)	Sample Designation:	CO-4	CO-4	CO-4	CO-4	CO-4	CO-4
	Sample Date:	04/05/04	05/11/04	05/18/04	05/25/04	06/01/04	06/22/04
Acenaphthene		2 U	2 U	2 U	2 U	2.2 U	2 U
Acenaphthylene		2 U	NA	2 U	NA	2.2 U	2 U
Anthracene		2 U	2 U	2 U	2 U	2.2 U	2 U
Benzo[a]anthracene		2 U	2 U	2 U	2 U	2.2 U	2 U
Benzo[a]pyrene		2 U	2 U	2 U	2 U	2.2 U	2 U
Benzo[b]fluoranthene		2 U	2 U	2 U	2 U	2.2 U	2 U
Benzo[g,h,i]perylene		2 U	2 U	2 U	2 U	2.2 U	2 U
Benzo[k]fluoranthene		2 U	2 U	2 U	2 U	2.2 U	2 U
Chrysene		2 U	2 U	2 U	2 U	2.2 U	2 U
Dibenzo[a,h]anthracene		2 U	2 U	2 U	2 U	2.2 U	2 U
Fluoranthene		2 U	2 U	2 U	2 U	2.2 U	2 U
Fluorene		2 U	2 U	2 U	2 U	2.2 U	2 U
Indeno[1,2,3-cd]pyrene		2 U	2 U	2 U	2 U	2.2 U	2 U
Naphthalene		2 U	2 U	2 U	2 U	2.2 U	2 U
Phenanthrene		2 U	2 U	2 U	2 U	2.2 U	2 U
Pyrene		2 U	2 U	2 U	2 U	2.2 U	2 U
Total SVOCs:		0	0	0	0	0	0

Notes:

µg/L - Micrograms per liter

U - The analyte was analyzed for, but not detected above the reported quantitation limit.

NA - Not analyzed

Table 7. Summary of Semivolatile Organic Compounds Detected in Groundwater Samples for the Chemical Oxidation Pilot Study, ExxonMobil Corporation, Buffalo Terminal, Buffalo, New York.

Parameter (Concentrations in µg/L)	Sample Designation:	CO-5	CO-5	CO-5	CO-5	CO-5	CO-5
	Sample Date:	04/05/04	05/11/04	05/18/04	05/25/04	06/01/04	06/22/04
Acenaphthene		2.4 U	2 U	2 U	2 U	3.6	2 U
Acenaphthylene		2.4 U	NA	2 U	NA	2.2 U	2 U
Anthracene		2.4 U	2 U	2 U	2 U	2.2 U	2 U
Benzo[a]anthracene		2.4 U	2 U	2 U	2 U	2.2 U	2 U
Benzo[a]pyrene		2.4 U	2 U	2 U	2 U	2.2 U	2 U
Benzo[b]fluoranthene		2.4 U	2 U	2 U	2 U	2.2 U	2 U
Benzo[g,h,i]perylene		2.4 U	2 U	2 U	2 U	2.2 U	2 U
Benzo[k]fluoranthene		2.4 U	2 U	2 U	2 U	2.2 U	2 U
Chrysene		2.4 U	2 U	2 U	2 U	2.2 U	2 U
Dibenzo[a,h]anthracene		2.4 U	2 U	2 U	2 U	2.2 U	2 U
Fluoranthene		2.4 U	2 U	2 U	2 U	2.2 U	2 U
Fluorene		2.4 U	2 U	2 U	2 U	3.3	2 U
Indeno[1,2,3-cd]pyrene		2.4 U	2 U	2 U	2 U	2.2 U	2 U
Naphthalene		2.4 U	2 U	2 U	2 U	2.2 U	2 U
Phenanthrene		2.4 U	2 U	2 U	2 U	2.2 U	2 U
Pyrene		2.4 U	2 U	2 U	2 U	2.2 U	2 U
Total SVOCs:		0	0	0	0	6.9	0

Notes:

µg/L - Micrograms per liter

U - The analyte was analyzed for, but not detected above the reported quantitation limit.

NA - Not analyzed

Table 7. Summary of Semivolatile Organic Compounds Detected in Groundwater Samples for the Chemical Oxidation Pilot Study, ExxonMobil Corporation, Buffalo Terminal, Buffalo, New York.

Parameter (Concentrations in µg/L)	Sample Designation:	LF-1S	MW-3URS	MW-3URS	MW-3URS	MW-3URS	MW-3URS
	Sample Date:	04/05/04	04/05/04	05/11/04	05/18/04	05/25/04	06/01/04
Acenaphthene		75.3	11.8	7.1	2.2 U	9.4	2.2 U
Acenaphthylene		2.4 U	2.4 U	NA	2.2 U	NA	2.2 U
Anthracene		37.6	2.4 U	2 U	2.2 U	2.5	2.2 U
Benzo[a]anthracene		2.8	2.4 U	2 U	2.2 U	2 U	2.2 U
Benzo[a]pyrene		2.4 U	2.4 U	2 U	2.2 U	2 U	2.2 U
Benzo[b]fluoranthene		2.4 U	2.4 U	2 U	2.2 U	2 U	2.2 U
Benzo[g,h,i]perylene		2.4 U	2.4 U	2 U	2.2 U	2 U	2.2 U
Benzo[k]fluoranthene		2.4 U	2.4 U	2 U	2.2 U	2 U	2.2 U
Chrysene		4.9	2.4 U	2 U	2.2 U	2 U	2.2 U
Dibenzo[a,h]anthracene		2.4 U	2.4 U	2 U	2.2 U	2 U	2.2 U
Fluoranthene		8.2	2.4 U	2 U	2.2 U	2 U	2.2 U
Fluorene		118	15.3	9.9	13.3	14	2.2 U
Indeno[1,2,3-cd]pyrene		2.4 U	2.4 U	2 U	2.2 U	2 U	2.2 U
Naphthalene		2.4 U	2.4 U	2 U	2.2 U	2 U	2.2 U
Phenanthrene		441	25.9	16	28.9	26	2.2 U
Pyrene		35.3	2.4 U	2 U	2.2 U	3	2.2 U
Total SVOCs:		723.1	53	33	42.2	54.9	0

Notes:

µg/L - Micrograms per liter

U - The analyte was analyzed for, but not detected above the reported quantitation limit.

NA - Not analyzed

Table 7. Summary of Semivolatile Organic Compounds Detected in Groundwater Samples for the Chemical Oxidation Pilot Study, ExxonMobil Corporation, Buffalo Terminal, Buffalo, New York.

Parameter (Concentrations in µg/L)	Sample Designation:	MW-3URS	RW-8R	RW-8R	RW-8R	RW-8R	RW-8R
	Sample Date:	06/22/04	04/05/04	05/11/04	05/18/04	05/25/04	06/01/04
Acenaphthene		8.7	3.4	3	2.2 U	3.3	2.2 U
Acenaphthylene		2.2 U	2.2 U	NA	2.2 U	NA	2.2 U
Anthracene		2.2 U	2.2 U	2 U	2.2 U	2 U	2.2 U
Benzo[a]anthracene		2.2 U	2.2 U	2 U	2.2 U	2 U	2.2 U
Benzo[a]pyrene		2.2 U	2.2 U	2 U	2.2 U	2 U	2.2 U
Benzo[b]fluoranthene		2.2 U	2.2 U	2 U	2.2 U	2 U	2.2 U
Benzo[g,h,i]perylene		2.2 U	2.2 U	2 U	2.2 U	2 U	2.2 U
Benzo[k]fluoranthene		2.2 U	2.2 U	2 U	2.2 U	2 U	2.2 U
Chrysene		2.2 U	2.2 U	2 U	2.2 U	2 U	2.2 U
Dibenzo[a,h]anthracene		2.2 U	2.2 U	2 U	2.2 U	2 U	2.2 U
Fluoranthene		2.2 U	2.2 U	2 U	2.2 U	2 U	2.2 U
Fluorene		11.1	3.7	2.6	2.2 U	3.1	2.2 U
Indeno[1,2,3-cd]pyrene		2.2 U	2.2 U	2 U	2.2 U	2 U	2.2 U
Naphthalene		2.2 U	2.2 U	2 U	2.2 U	2 U	2.2 U
Phenanthrene		14.4	2.2 U	2 U	2.2 U	2.2	2.2 U
Pyrene		2.2 U	2.2 U	2 U	2.2 U	2 U	2.2 U
Total SVOCs:		34.2	7.1	5.6	0	8.6	0

Notes:

µg/L - Micrograms per liter

U - The analyte was analyzed for, but not detected above the reported quantitation limit.

NA - Not analyzed

Table 7. Summary of Semivolatile Organic Compounds Detected in Groundwater Samples for the Chemical Oxidation Pilot Study, ExxonMobil Corporation, Buffalo Terminal, Buffalo, New York.

Parameter (Concentrations in µg/L)	Sample Designation:	RW-8R	VERMW-1	VERMW-1	VERMW-1	VERMW-1	VERMW-1
	Sample Date:	06/22/04	04/05/04	05/11/04	05/18/04	05/25/04	06/01/04
Acenaphthene		2 U	5.9	2 U	2.2 U	2 U	2 U
Acenaphthylene		2 U	2.2 U	NA	2.2 U	NA	2 U
Anthracene		2 U	2.2 U	2 U	2.2 U	2 U	2 U
Benzo[a]anthracene		2 U	2.2 U	2 U	2.2 U	2 U	2 U
Benzo[a]pyrene		2 U	2.2 U	2 U	2.2 U	2 U	2 U
Benzo[b]fluoranthene		2 U	2.2 U	2 U	2.2 U	2 U	2 U
Benzo[g,h,i]perylene		2 U	2.2 U	2 U	2.2 U	2 U	2 U
Benzo[k]fluoranthene		2 U	2.2 U	2 U	2.2 U	2 U	2 U
Chrysene		2 U	2.2 U	2 U	2.2 U	2 U	2 U
Dibenzo[a,h]anthracene		2 U	2.2 U	2 U	2.2 U	2 U	2 U
Fluoranthene		2 U	2.2 U	2 U	2.2 U	2 U	2 U
Fluorene		2 U	5.9	2 U	2.2 U	2 U	2 U
Indeno[1,2,3-cd]pyrene		2 U	2.2 U	2 U	2.2 U	2 U	2 U
Naphthalene		2 U	2.2 U	2 U	2.2 U	2 U	2 U
Phenanthrene		2 U	2.2 U	2 U	3.3	2 U	2 U
Pyrene		2 U	2.2 U	2 U	2.2 U	2 U	2 U
Total SVOCs:		0	11.8	0	3.3	0	0

Notes:

µg/L - Micrograms per liter

U - The analyte was analyzed for, but not detected above the reported quantitation limit.

NA - Not analyzed

Table 7. Summary of Semivolatile Organic Compounds Detected in Groundwater Samples for the Chemical Oxidation Pilot Study, ExxonMobil Corporation, Buffalo Terminal, Buffalo, New York.

Parameter (Concentrations in µg/L)	Sample Designation:	VERMW-1	VERMW-2	VERMW-2	VERMW-2	VERMW-2	VERMW-2
	Sample Date:	06/22/04	04/05/04	05/11/04	05/18/04	05/25/04	06/01/04
Acenaphthene		2 U	14	2 U	2.2 U	2 U	2.2 U
Acenaphthylene		2 U	2 U	NA	2.2 U	NA	2.2 U
Anthracene		2 U	2.3	2 U	2.2 U	2 U	2.2 U
Benzo[a]anthracene		2 U	2 U	2 U	2.2 U	2 U	2.2 U
Benzo[a]pyrene		2 U	2 U	2 U	2.2 U	2 U	2.2 U
Benzo[b]fluoranthene		2 U	2 U	2 U	2.2 U	2 U	2.2 U
Benzo[g,h,i]perylene		2 U	2 U	2 U	2.2 U	2 U	2.2 U
Benzo[k]fluoranthene		2 U	2 U	2 U	2.2 U	2 U	2.2 U
Chrysene		2 U	2 U	2 U	2.2 U	2 U	2.2 U
Dibenzo[a,h]anthracene		2 U	2 U	2 U	2.2 U	2 U	2.2 U
Fluoranthene		2 U	2 U	2 U	2.2 U	2 U	2.2 U
Fluorene		2 U	14	2 U	2.2 U	2 U	2.2 U
Indeno[1,2,3-cd]pyrene		2 U	2 U	2 U	2.2 U	2 U	2.2 U
Naphthalene		2 U	2 U	2 U	2.2 U	2 U	2.2 U
Phenanthrene		2 U	28	2.1	7.8	2 U	2.2 U
Pyrene		2 U	2.3	2 U	2.2 U	2 U	2.2 U
Total SVOCs:		0	60.6	2.1	7.8	0	0

Notes:

µg/L - Micrograms per liter

U - The analyte was analyzed for, but not detected above the reported quantitation limit.

NA - Not analyzed

Table 7. Summary of Semivolatile Organic Compounds Detected in Groundwater Samples for the Chemical Oxidation Pilot Study, ExxonMobil Corporation, Buffalo Terminal, Buffalo, New York.

Parameter (Concentrations in µg/L)	Sample Designation:	VERMW-2	VERMW-3	VERMW-4
	Sample Date:	06/22/04	04/05/04	06/22/04
Acenaphthene		2.2 U	8.7	18
Acenaphthylene		2.2 U	2.4 U	4 U
Anthracene		2.2 U	2.4 U	8.4
Benzo[a]anthracene		2.2 U	2.4 U	4 U
Benzo[a]pyrene		2.2 U	2.4 U	4 U
Benzo[b]fluoranthene		2.2 U	2.4 U	4 U
Benzo[g,h,i]perylene		2.2 U	2.4 U	4 U
Benzo[k]fluoranthene		2.2 U	2.4 U	4 U
Chrysene		2.2 U	2.4 U	4 U
Dibenzo[a,h]anthracene		2.2 U	2.4 U	4 U
Fluoranthene		2.2 U	2.4 U	4 U
Fluorene		2.2 U	8.7	22
Indeno[1,2,3-cd]pyrene		2.2 U	2.4 U	4 U
Naphthalene		2.2 U	2.4 U	4 U
Phenanthrene		2.2 U	15.3	40
Pyrene		2.2 U	2.4 U	10
Total SVOCs:		0	32.7	98.4

Notes:

µg/L - Micrograms per liter

U - The analyte was analyzed for, but not detected above the reported quantitation limit.

NA - Not analyzed

Table 8. Summary of Volatile Organic Compounds Detected in Product Samples - Chemox Pilot Test

Parameter (Concentrations in mg/kg)	Sample Designation: Sample Date:	Outside Pilot Test Area		Inside Pilot Test Area	
		MW-28 06/21/04	LF-1S 06/21/04	LF-6 06/21/04	VERMW-3 06/21/04
Benzene		8	22.2	ND	ND
Toluene		8	ND	ND	ND
Ethylbenzene		53.5	ND	ND	ND
Xylenes (total)		45	ND	ND	ND
Total BTEX:		114.5	22.2	0	0
1,2,4-Trimethylbenzene		1510	310	ND	173
1,3,5-Trimethylbenzene		11.5	ND	ND	ND
4-Isopropyltoluene		108	ND	ND	ND
Isopropylbenzene		86	126	ND	7.5
n-Butylbenzene		414	495	60.5	134
n-Propylbenzene		231	322	ND	8
Naphthalene		30.5	16.5	ND	ND
sec-Butylbenzene		170	225	36.5	78
Total VOCs:		2675.5	1516.7	97	400.5
Average:		2096		249	

mg/kg - Milligrams per kilogram

ND - Not detected

BTEX - Benzene, Toluene, Ethylbenzene, Total Xylenes

VOCs - Volatile Organic Compounds

Table 9. Summary of Semivolatile Organic Compounds Detected in Product Samples - Chemox Pilot Test

Parameter (Concentrations in mg/kg)	Sample Designation: Sample Date:	Outside Pilot Test Area		Inside Pilot Test Area	
		MW-28	LF-1S	LF-6	VERMW-3
		06/21/04	06/21/04	06/21/04	06/21/04
2-Methylnaphthalene		9700	9200	2720	3900
Acenaphthene		520	500	460	520
Anthracene		220	220	220	260
Dibenzofuran		220	220	ND	ND
Fluorene		800	780	760	800
Phenanthrene		2200	2200	2000	2200
Pyrene		240	240	260	240
Total SVOCs		13900	13360	6420	7920
Average:		13630		7170	

mg/kg - Milligrams per kilogram

ND - Not detected

SVOCs - Semivolatile Organic Compounds

Table 10. Summary of Soil Sample Results from SB-194 and MW-28

Parameter	Units	Sample Designation:	MW-28	SB-194
		Sample Date:	10/04/00	06/23/04
		Sample Depth (ft bls):	26-28	21-23
		Area:	Outside Pilot Test Area	Inside Pilot Test Area
SVOCs				
Acenaphthene	µg/kg		5100	495
Acenaphthylene	µg/kg		NA	66 U
Anthracene	µg/kg		2700	208
Benzo[a]anthracene	µg/kg		410 U	66 U
Benzo[a]pyrene	µg/kg		410 U	66 U
Benzo[b]fluoranthene	µg/kg		410 U	66 U
Benzo[g,h,i]perylene	µg/kg		410 U	66 U
Benzo[k]fluoranthene	µg/kg		410 U	66 U
Chrysene	µg/kg		410 U	66 U
Dibenzo[a,h]anthracene	µg/kg		410 U	66 U
Fluoranthene	µg/kg		480	66 U
Fluorene	µg/kg		7800	660
Indeno[1,2,3-cd]pyrene	µg/kg		410 U	66 U
Naphthalene	µg/kg		5500	66 U
Phenanthrene	µg/kg		27000	2310
Pyrene	µg/kg		2300	205
Total SVOCs			50880	3878
VOCs				
1,2,4-Trimethylbenzene	µg/kg		3100	2.9
1,3,5-Trimethylbenzene	µg/kg		300	2 U
4-Isopropyltoluene	µg/kg		620	2 U
Benzene	µg/kg		12 U	2 U
Ethylbenzene	µg/kg		110	2 U
Isopropylbenzene	µg/kg		510	2.8
MTBE	µg/kg		12 U	2 U
Naphthalene	µg/kg		1700	5 U
n-Butylbenzene	µg/kg		1000	33.9
n-Propylbenzene	µg/kg		370	11.4
sec-Butylbenzene	µg/kg		530	16.6
tert-Butylbenzene	µg/kg		460	2 U
Toluene	µg/kg		12 U	2.4
Xylenes (total)	µg/kg		89	3.6
Total VOCs			8789	73.6

mg/kg - Milligrams per kilogram

µg/kg - Micrograms per kilogram

NA - Not analyzed for specific compound

SVOCs - Semivolatile Organic Compounds

VOCs - Volatile Organic Compounds

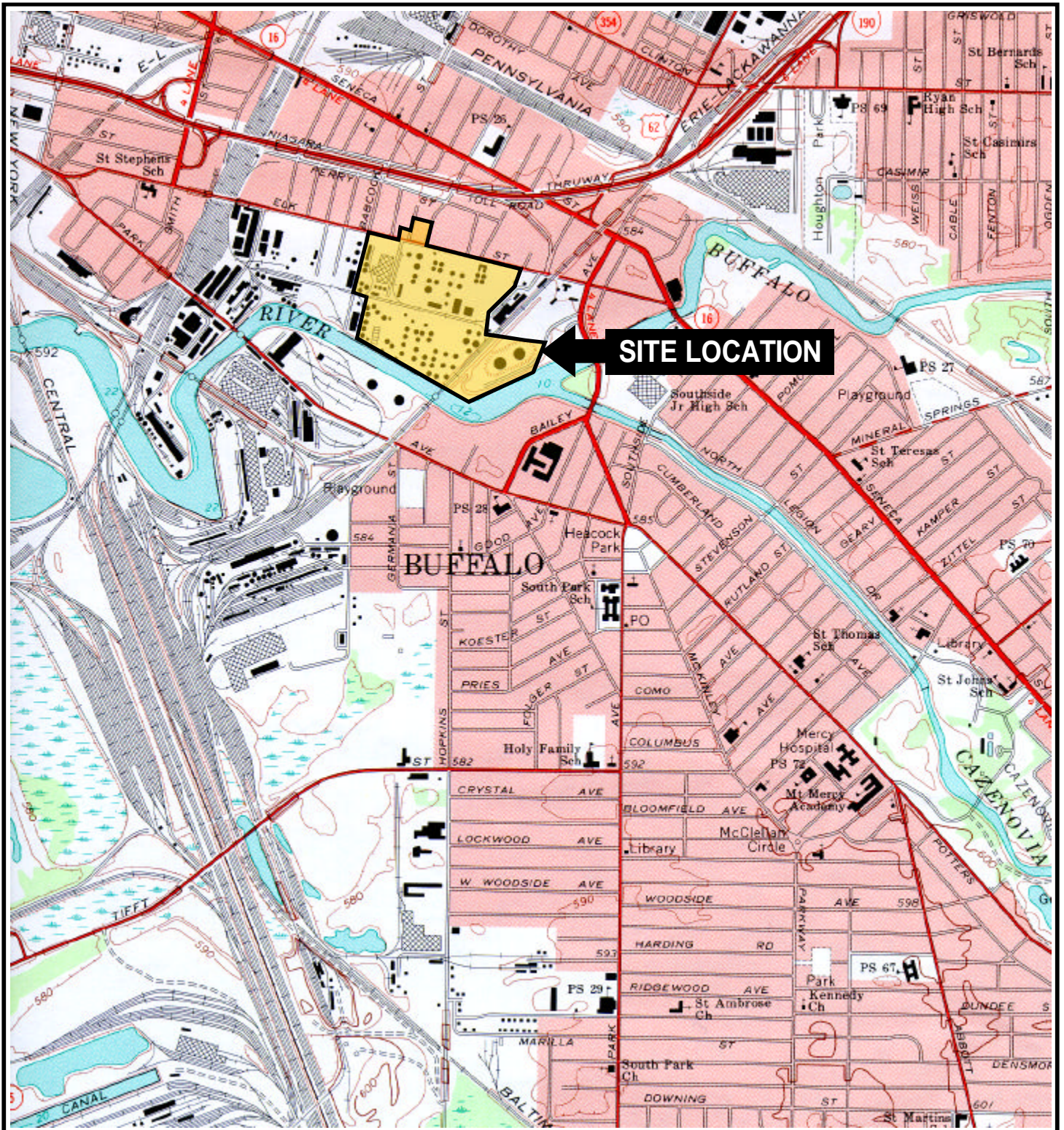

QUADRANGLE LOCATION

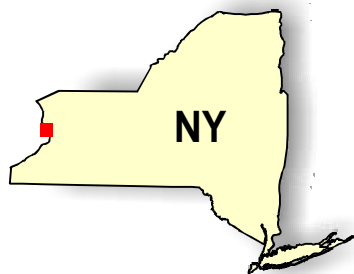

SOURCE:
USGS; 1965, Buffalo SE, New York
7.5 Minute Topographic Quadrangle



Title:

SITE LOCATION MAP

BUFFALO TERMINAL

Prepared for:

EXXONMOBIL OIL CORPORATION

ROUX
ROUX ASSOCIATES, INC.
Environmental Consulting
& Management

Compiled by: W.S.	Date: 20SEP04
Prepared by: B.H.C.	Scale: AS SHOWN
Project Mgr.: W.S.	Office: NY
File No.: MC522411.CDR	Project No.: 1725Y06

FIGURE

1

N:\PROJECTS\MC172\MC52\241\MC5224910.DWG

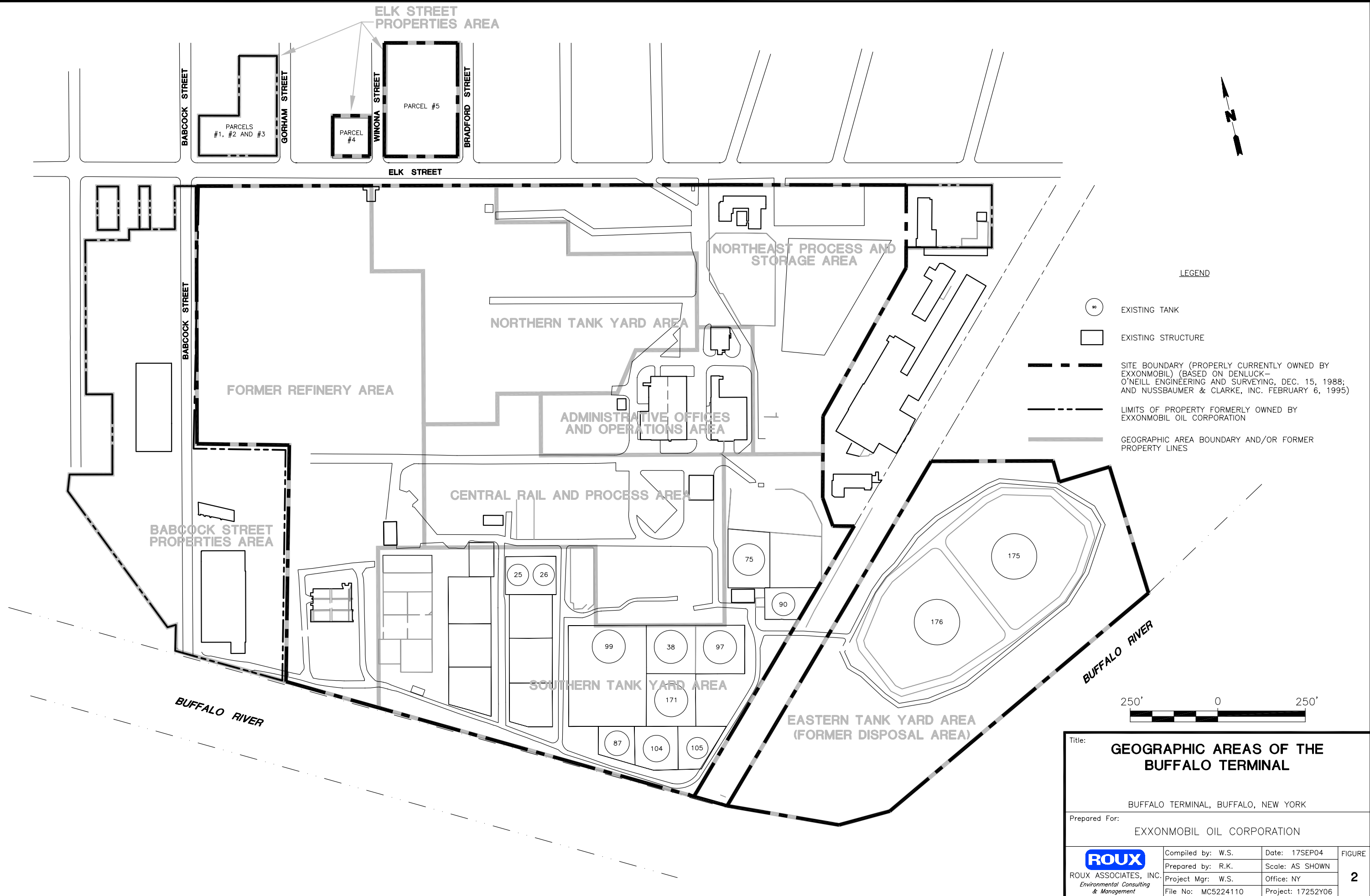

Title: GEOGRAPHIC AREAS OF THE BUFFALO TERMINAL

BUFFALO TERMINAL, BUFFALO, NEW YORK

Prepared For: EXXONMOBIL OIL CORPORATION

 ROUX ASSOCIATES, INC. <i>Environmental Consulting & Management</i>	Compiled by: W.S.	Date: 17SEP04	FIGURE 2
	Prepared by: R.K.	Scale: AS SHOWN	
	Project Mgr: W.S.	Office: NY	
	File No: MC5224110	Project: 17252Y06	

N:\PROJECTS\MC172Y\MC52Y\241\MC5224102.DWG

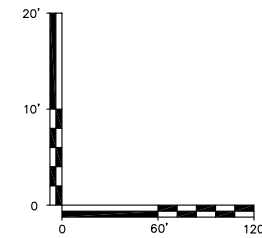
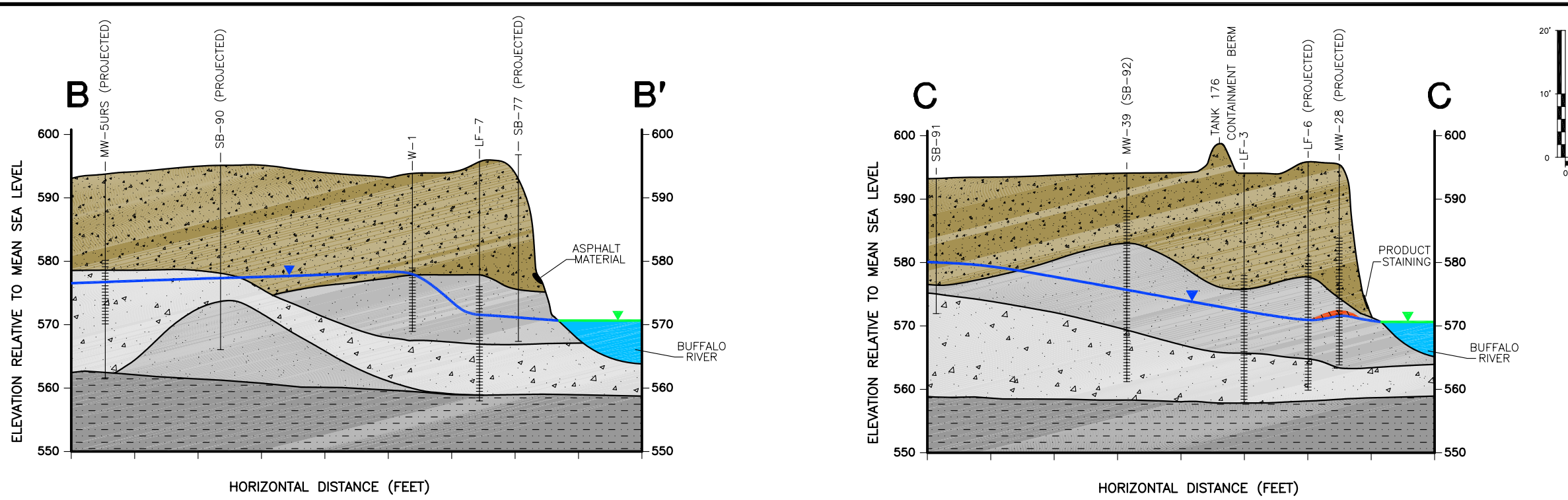

- LEGEND**
- BUFFALO RIVER ELEVATION IN FEET ABOVE MEAN SEA LEVEL (4/7/04)
 - WATER-TABLE ELEVATION IN FEET ABOVE MEAN SEA LEVEL (4/7/04)
 - INDICATES MONITORING WELL SCREENED INTERVAL
 - INDICATES SOIL BORING
 - FILL MATERIAL CONSISTING OF BLACK CINDERS, CONCRETE, BRICK, GLASS, SLAG, WOOD, SILT, GRAVEL AND SAND
 - ALLUVIAL DEPOSITS (SAND, SAND AND SILT, SAND AND GRAVEL, SILTY SAND, SILT)
 - ALLUVIAL DEPOSITS (SAND AND GRAVEL)
 - CLAY
 - SEPARATE-PHASE PRODUCT

- NOTES:**
1. FOR LOCATION OF SECTION LINES SEE PLATE 1.
 2. LAND SURFACE SHOWN IS ALONG THE SECTION CUT LINE, NOT NECESSARILY AT THE WELL/BORING LOCATIONS IF WELL/BORING IS PROJECTED ONTO THE LINE.
 3. MW-28 HAS A SOLAR POWERED PRODUCT RECOVERY PUMP INSTALLED SINCE APRIL 5, 2001.
 4. LINES SEPARATING CLAY LAYER FROM SAND AND GRAVEL LAYER ARE SHOWN DASHED WHERE INFERRED.

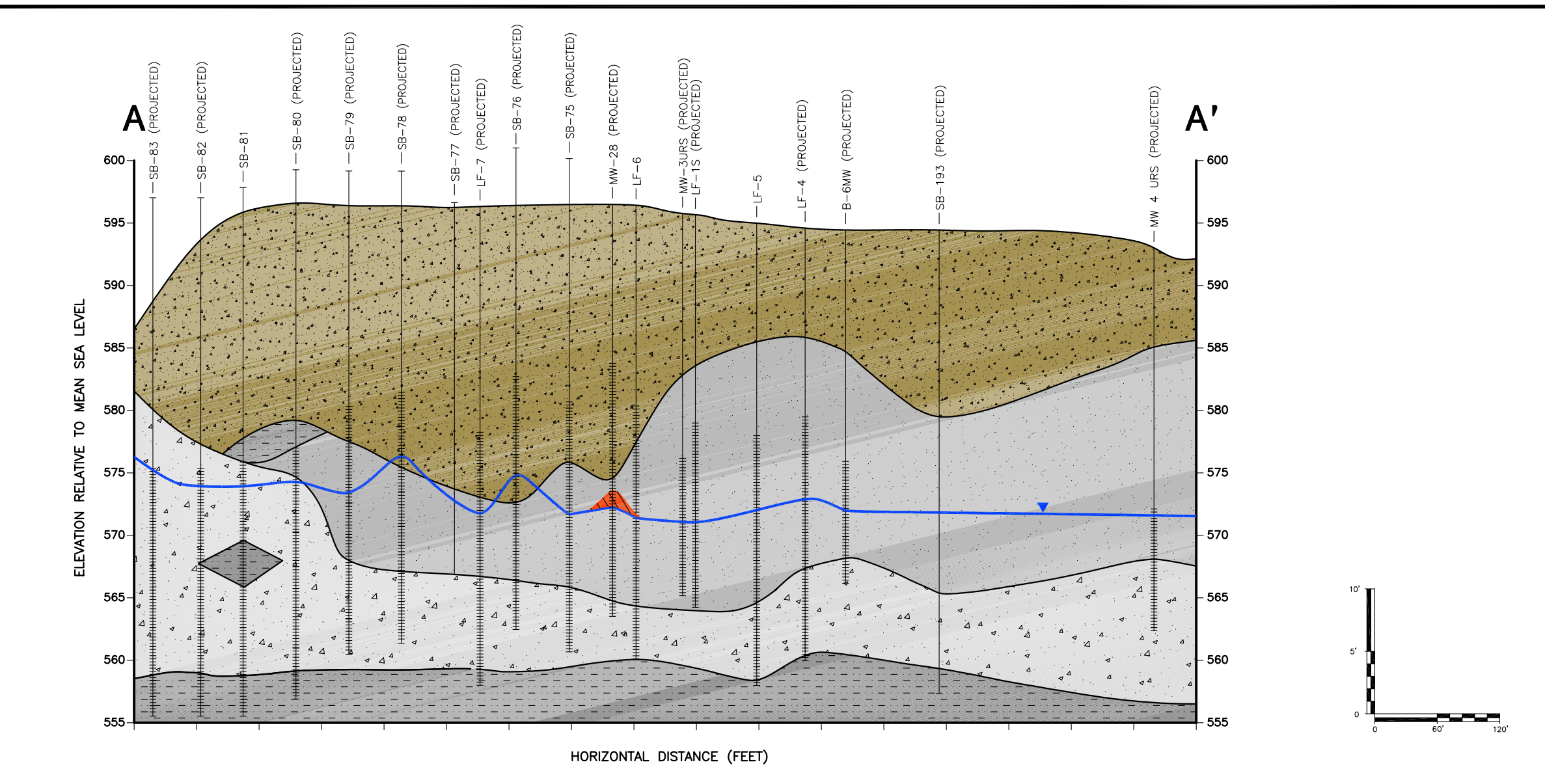
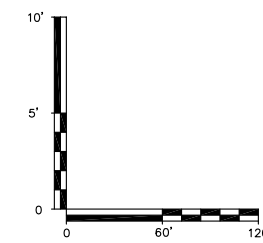

<p>Title: GENERALIZED HYDROGEOLOGIC CROSS SECTIONS A-A' B-B' AND C-C'</p> <p>BUFFALO TERMINAL, BUFFALO, NEW YORK</p>			
<p>Prepared For: EXXONMOBIL OIL CORPORATION</p>			
<p>ROUX ASSOCIATES, INC. Environmental Consulting & Management</p>	<p>Compiled by: N.C.</p>	<p>Date: 21AUG04</p>	<p>FIGURE 3</p>
	<p>Prepared by: R.K.</p>	<p>Scale: AS SHOWN</p>	
	<p>Project Mgr: N.C.</p>	<p>Office: NY</p>	
<p>File No: MC5224102</p>		<p>Project: 1725Y06</p>	

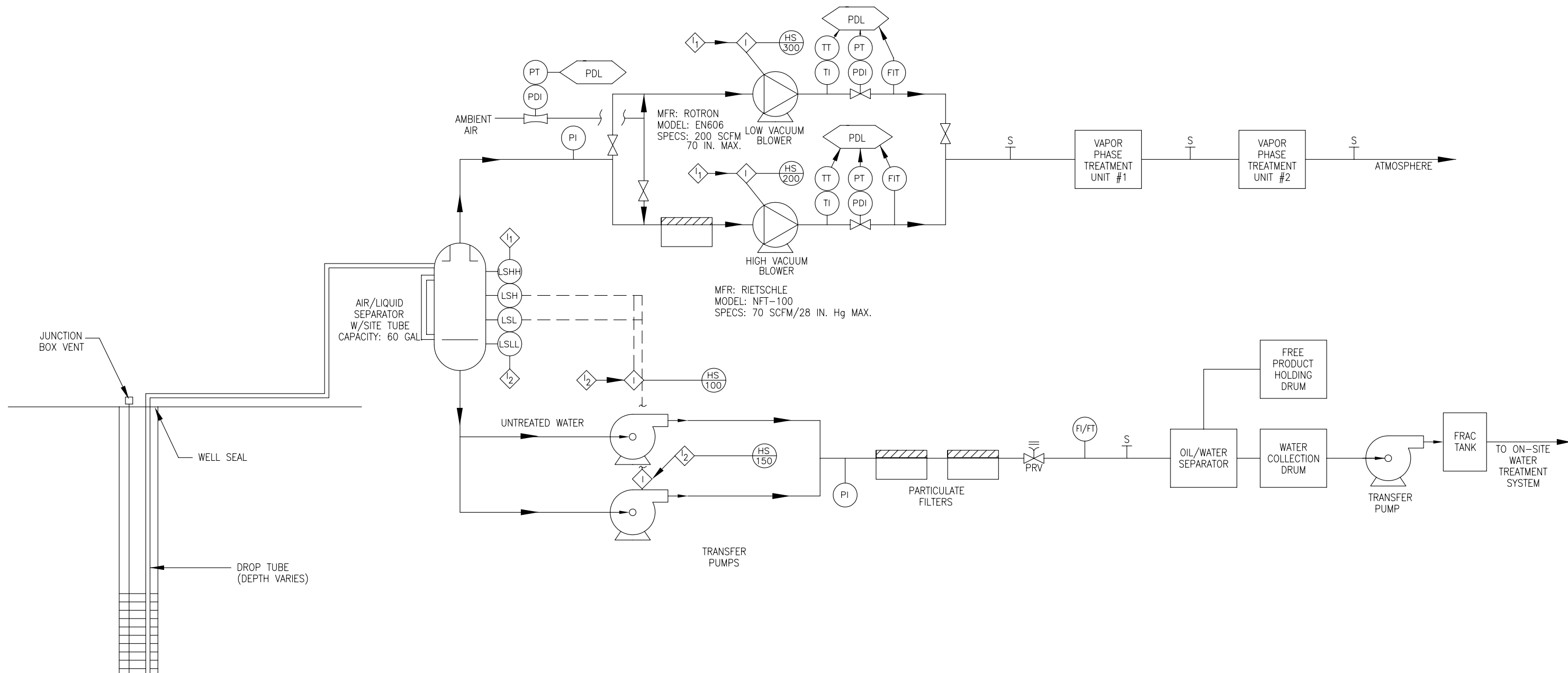

Title:
VACUUM ENHANCED RECOVERY PILOT SYSTEM PROCESS AND INSTRUMENTATION DIAGRAM

Prepared For:
 EXXONMOBIL OIL CORPORATION

ROUX ROUX ASSOCIATES, INC. <i>Environmental Consulting & Management</i>	Compiled by: N.C.	Date: 15SEP03	FIGURE 4
	Prepared by: G.M.	Scale: N.T.S.	
	Project Mgr: N.C.	Office: NY	
	File No: MC5224108	Project: 17252Y05	

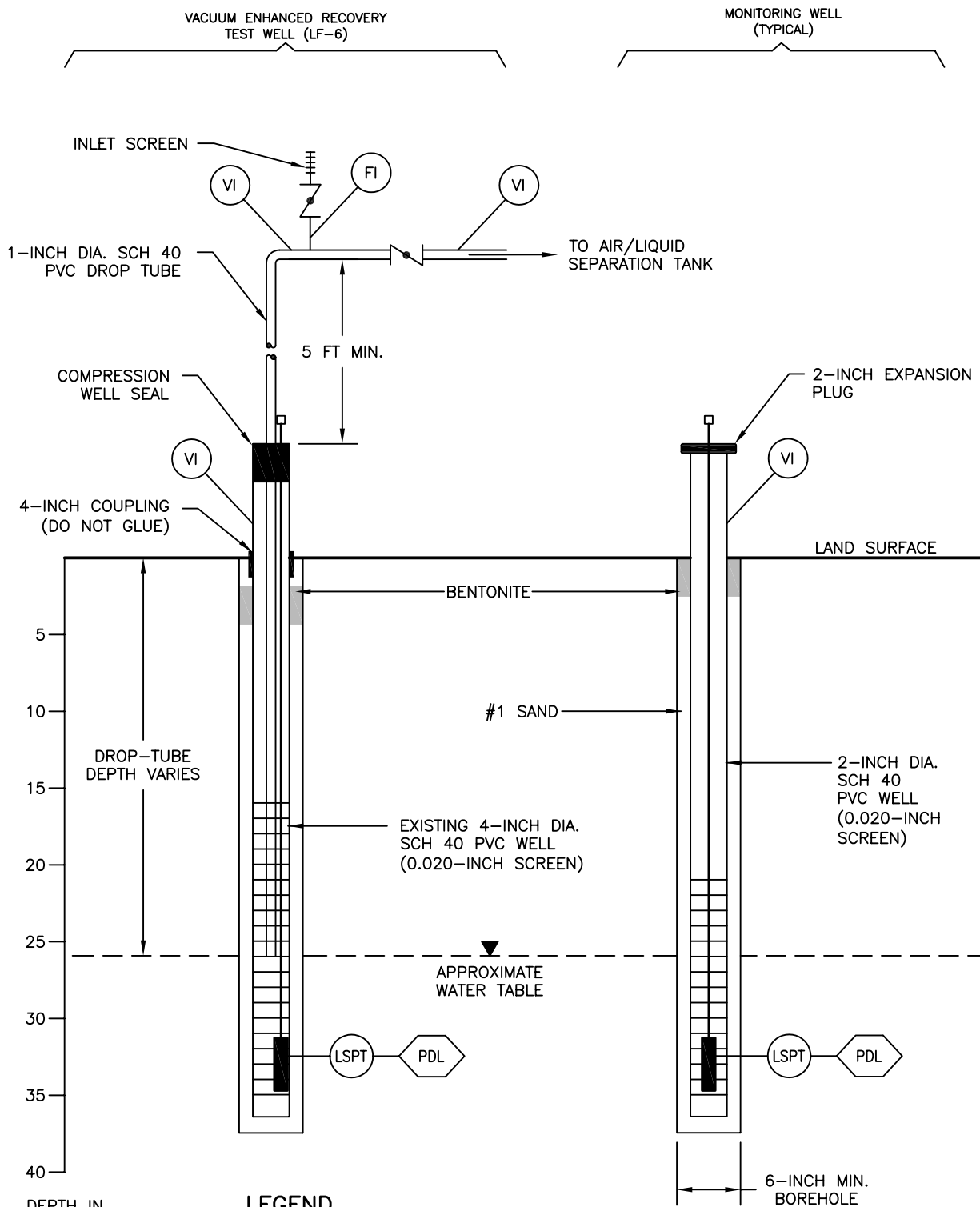

DEPTH IN FEET BELOW LAND SURFACE

LEGEND

- (FI) FLOW INDICATOR
- (VI) VACUUM INDICATOR
- ⌵ BUTTERFLY VALVE
- LSPT LEVEL SENSING PRESSURE TRANSDUCER
- PDL PROCESS DATA LOGGER

Title: **PILOT TEST WELL AND TYPICAL MONITORING WELL CONSTRUCTION FOR VACUUM ENHANCED RECOVERY PILOT TEST**

Prepared For: **EXXONMOBIL OIL CORPORATION**

 ROUX ASSOCIATES, INC. <i>Environmental Consulting & Management</i>	Compiled by: N.C.	Date: 18AUG03	FIGURE
	Prepared by: G.M.	Scale: N.T.S.	
	Project Mgr: N.C.	Office: NY	
	File No: MC5224109	Project: 17252Y05	

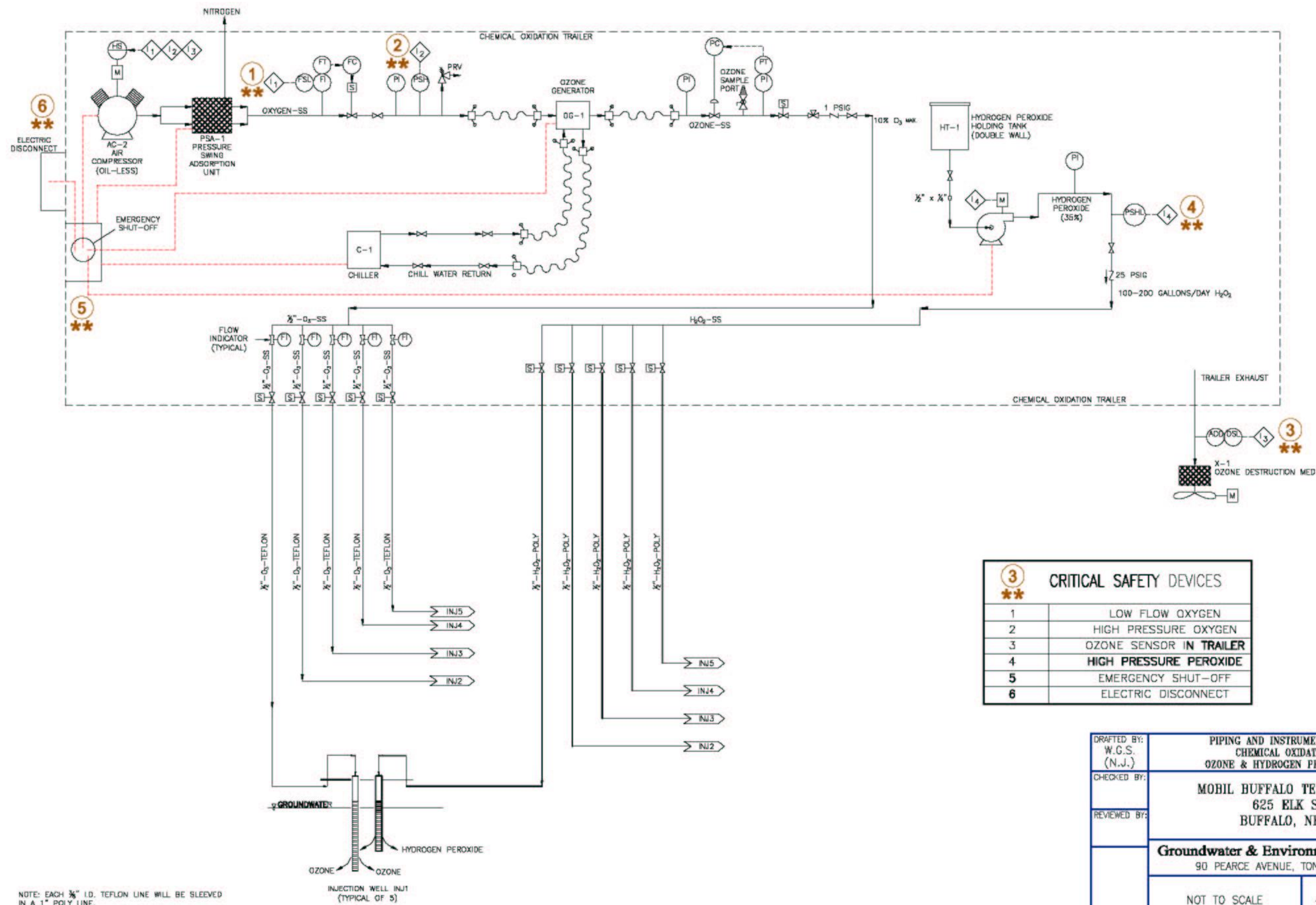

3 ** CRITICAL SAFETY DEVICES	
1	LOW FLOW OXYGEN
2	HIGH PRESSURE OXYGEN
3	OZONE SENSOR IN TRAILER
4	HIGH PRESSURE PEROXIDE
5	EMERGENCY SHUT-OFF
6	ELECTRIC DISCONNECT

NOTE: EACH 3/8\" I.D. TEFLON LINE WILL BE SLEEVED IN A 1\" POLY LINE.

DRAFTED BY: W.G.S. (N.J.)	PIPING AND INSTRUMENTATION DIAGRAM CHEMICAL OXIDATION SYSTEM OZONE & HYDROGEN PEROXIDE INJECTION	
CHECKED BY:	MOBIL BUFFALO TERMINAL #31010 625 ELK STREET BUFFALO, NEW YORK	
REVIEWED BY:	Groundwater & Environmental Services, Inc. 90 PEARCE AVENUE, TONAWANDA, NY 14150	
NOT TO SCALE	DATE 11-21-03	FIGURE 6

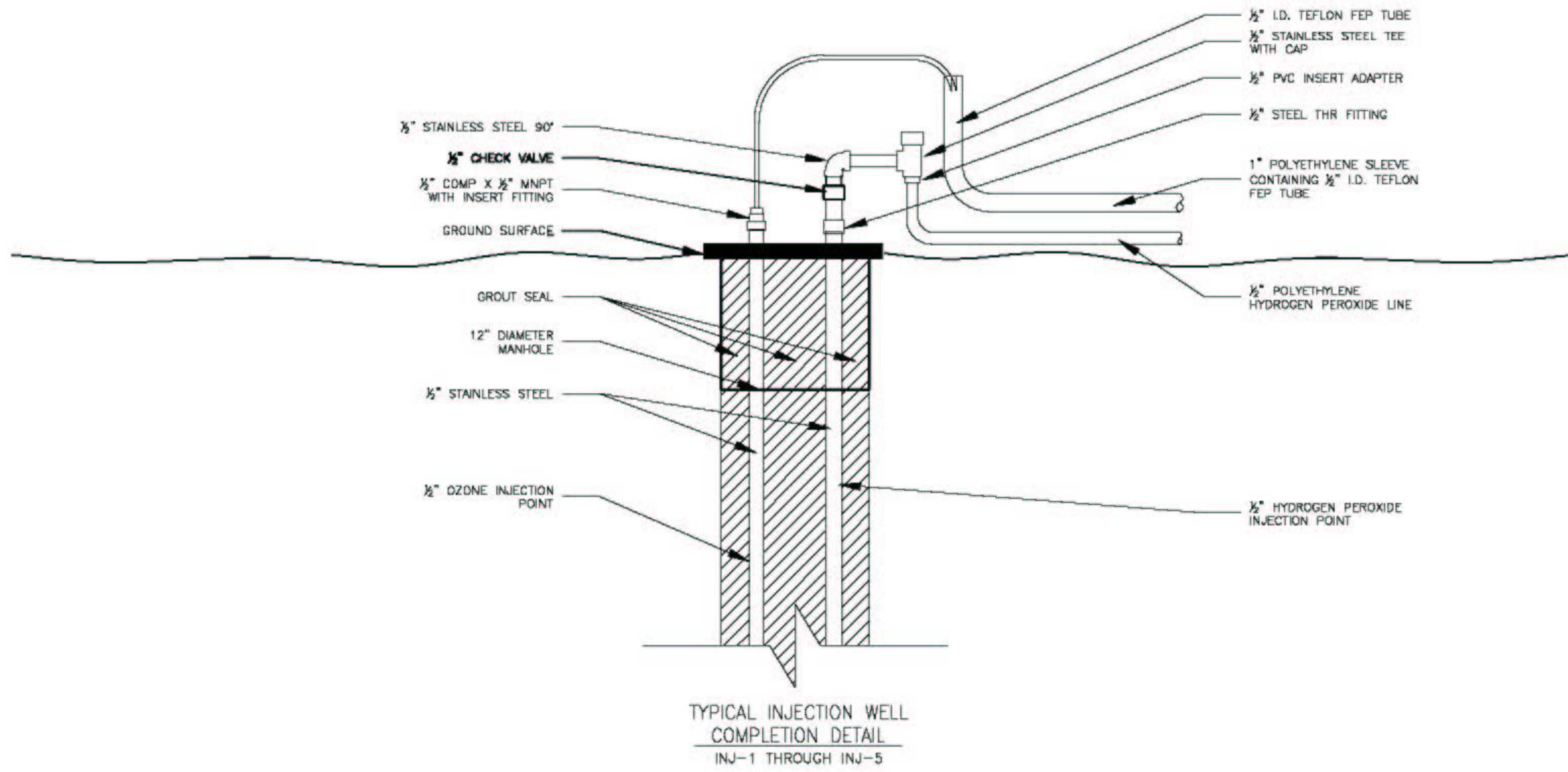

M:\Graphics\0900-Buffer\0000\Terminal\31010 Buffalo Terminal wellhead-chemox.dwg, 11/12/2003 02:00:13 PM, WShea, Acrobat PDFWriter

DRAFTED BY: W.G.S. (N.J.)	WELL CONNECTION DETAIL	
CHECKED BY:	MOBIL BUFFALO TERMINAL #31010 625 ELK STREET BUFFALO, NEW YORK	
REVIEWED BY:	Groundwater & Environmental Services, Inc. 90 PEARCE AVENUE, TONAWANDA, NY 14150	
NOT TO SCALE	DATE 11-12-03	FIGURE 7

Figure 8. Summary of Total Volatile Organic Compounds (VOCs) and Semivolatile Organic Compounds (SVOCs) for CO-1, Buffalo Terminal, ExxonMobil Oil Corporation, Buffalo, New York

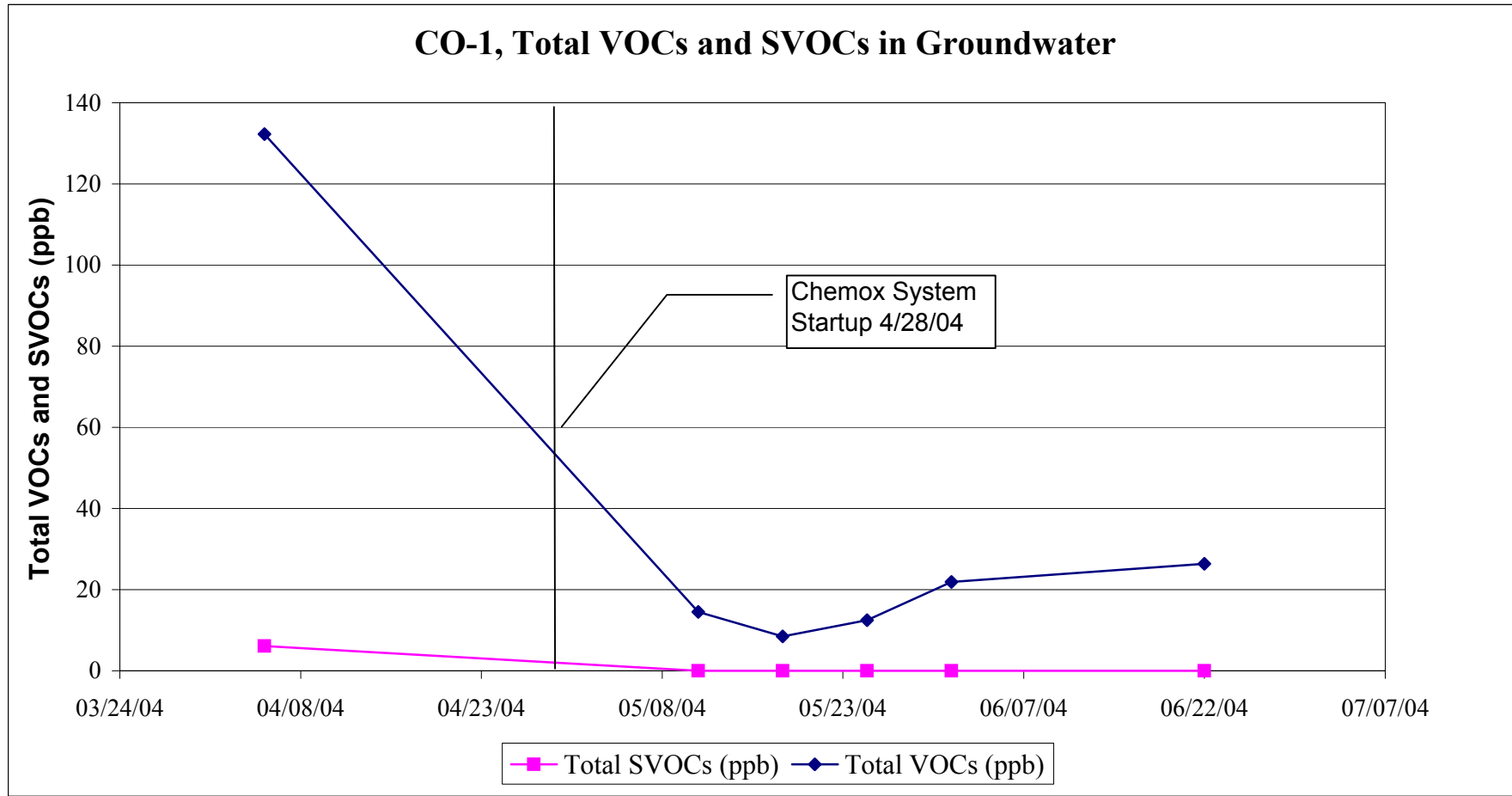

Figure 9. Summary of Total Volatile Organic Compounds (VOCs) and Semivolatile Organic Compounds (SVOCs) for CO-2, Buffalo Terminal, ExxonMobil Oil Corporation, Buffalo, New York

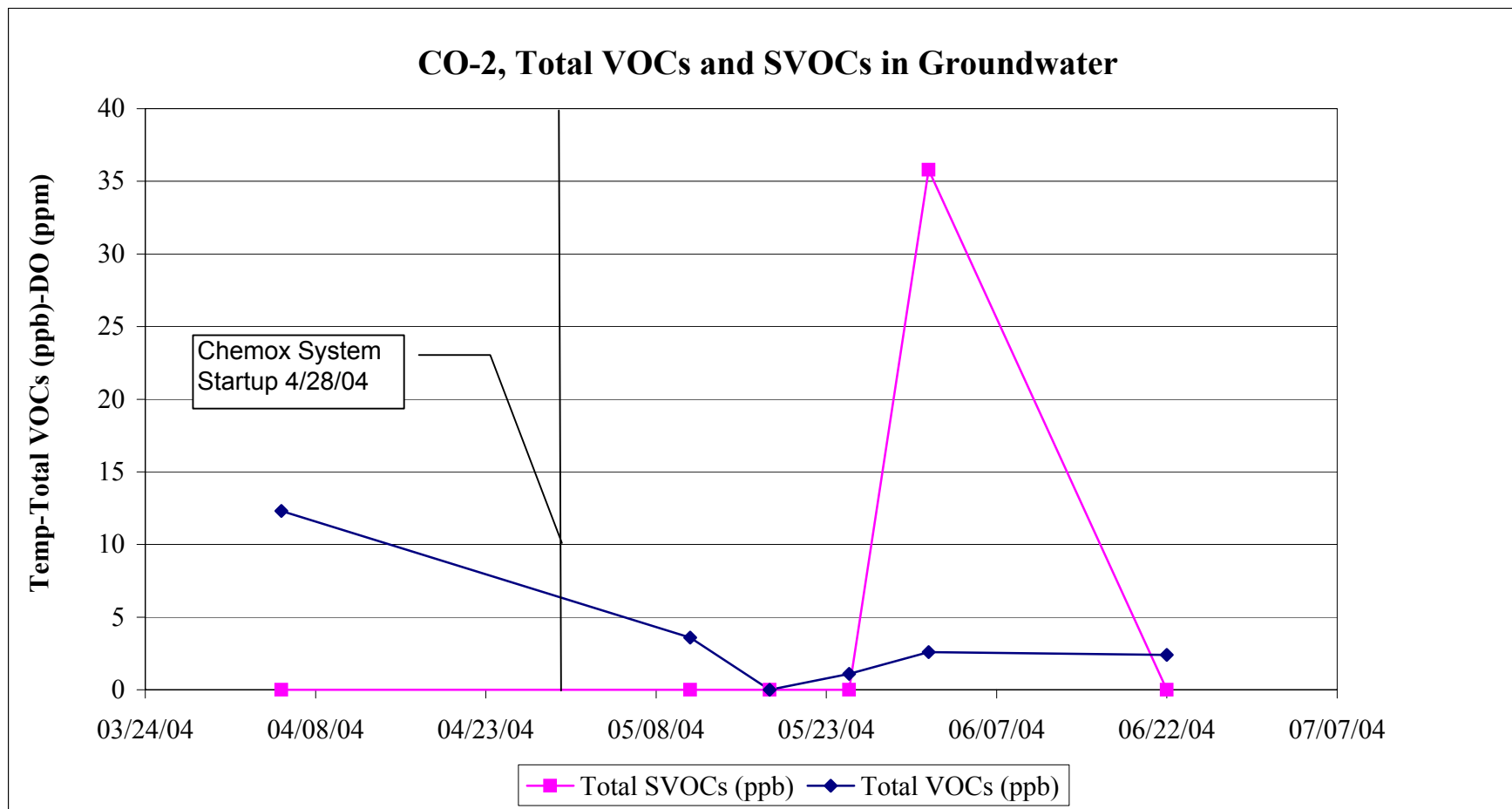

Figure 10. Summary of Total Volatile Organic Compounds (VOCs) and Semivolatile Organic Compounds (SVOCs) for CO-3, Buffalo Terminal, ExxonMobil Oil Corporation, Buffalo, New York

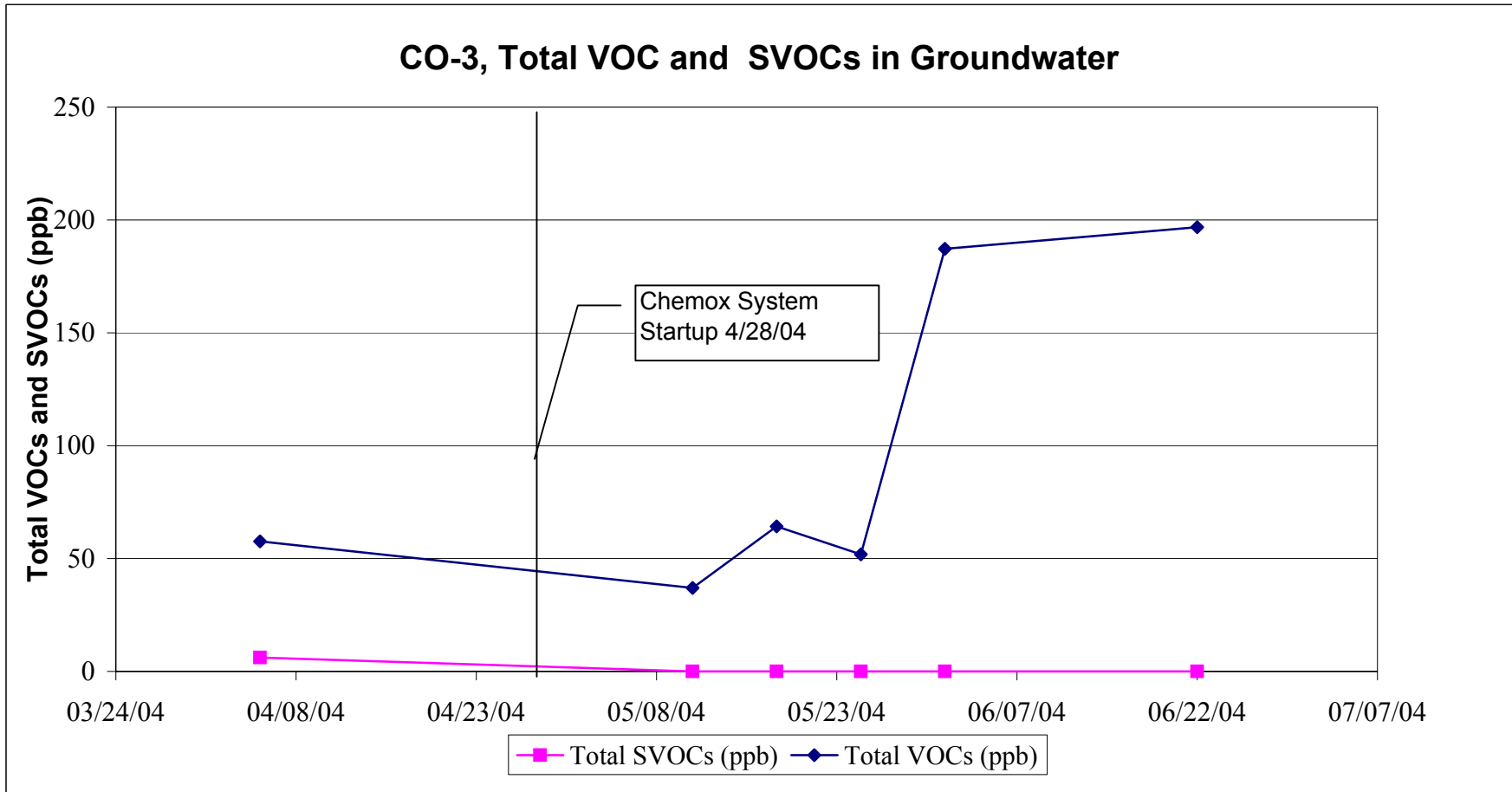

Figure 11. Summary of Total Volatile Organic Compounds (VOCs) and Semivolatile Organic Compounds (SVOCs) for CO-4, Buffalo Terminal, ExxonMobil Oil Corporation, Buffalo, New York

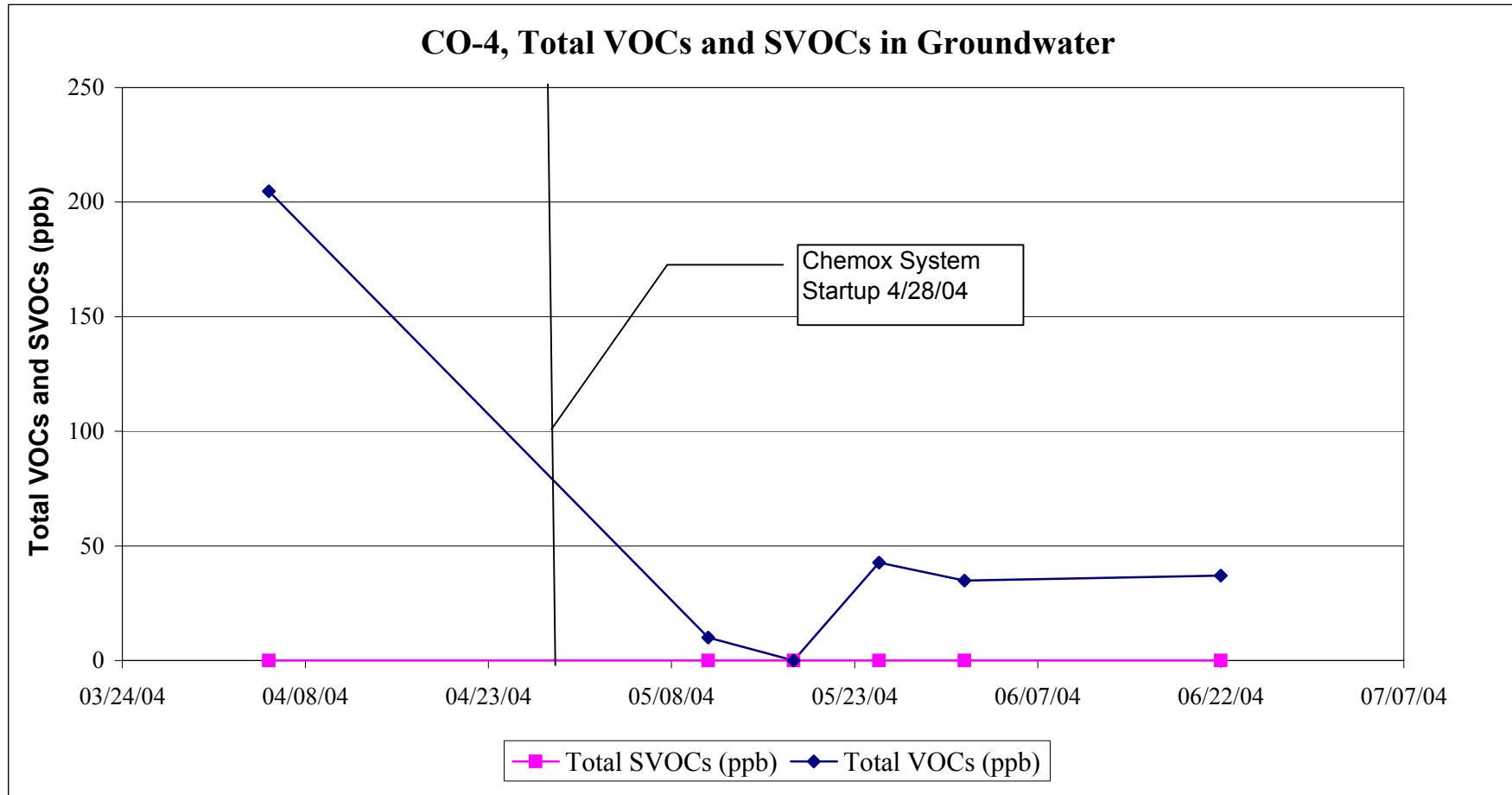

Figure 12. Summary of Total Volatile Organic Compounds (VOCs) and Semivolatile Organic Compounds (SVOCs) for CO-5, Buffalo Terminal, ExxonMobil Oil Corporation, Buffalo, New York

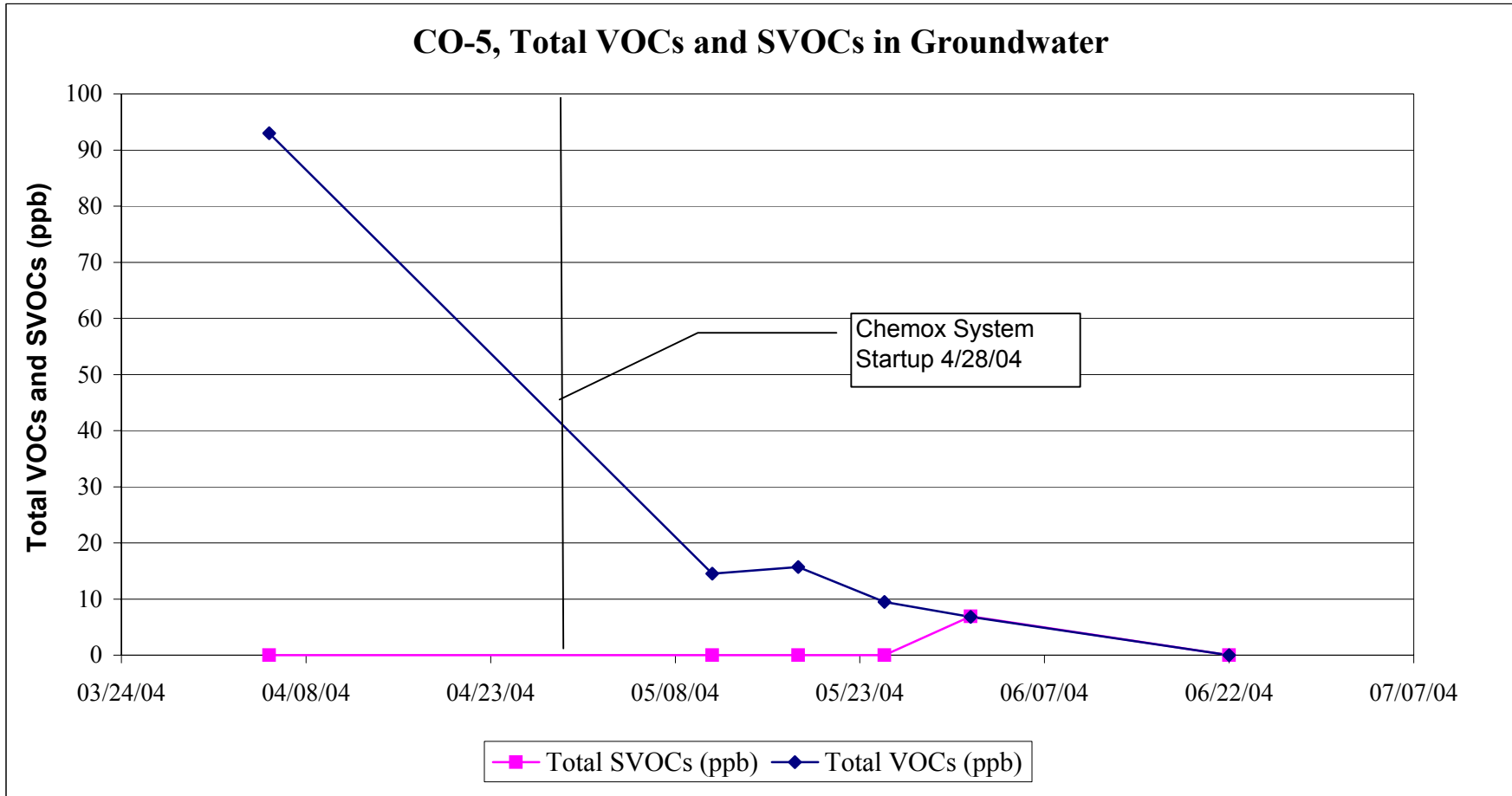

Figure 13. Summary of Total Volatile Organic Compounds (VOCs) and Semivolatile Organic Compounds (SVOCs) for VERMW-1, Buffalo Terminal, ExxonMobil Oil Corporation, Buffalo, New York

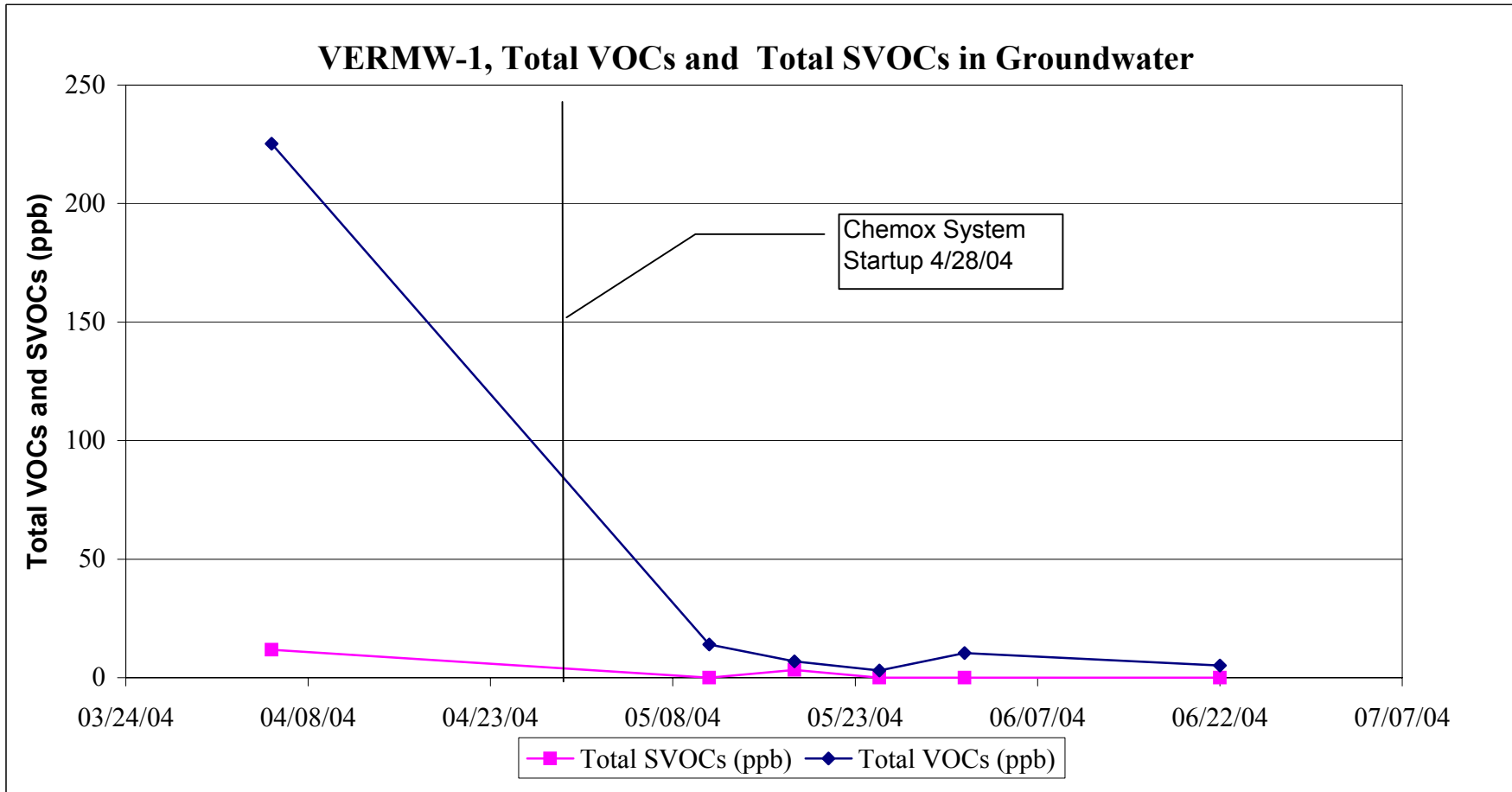

Figure 14. Summary of Total Volatile Organic Compounds (VOCs) and Semivolatile Organic Compounds (SVOCs) for VERMW-2, Buffalo Terminal, ExxonMobil Oil Corporation, Buffalo, New York

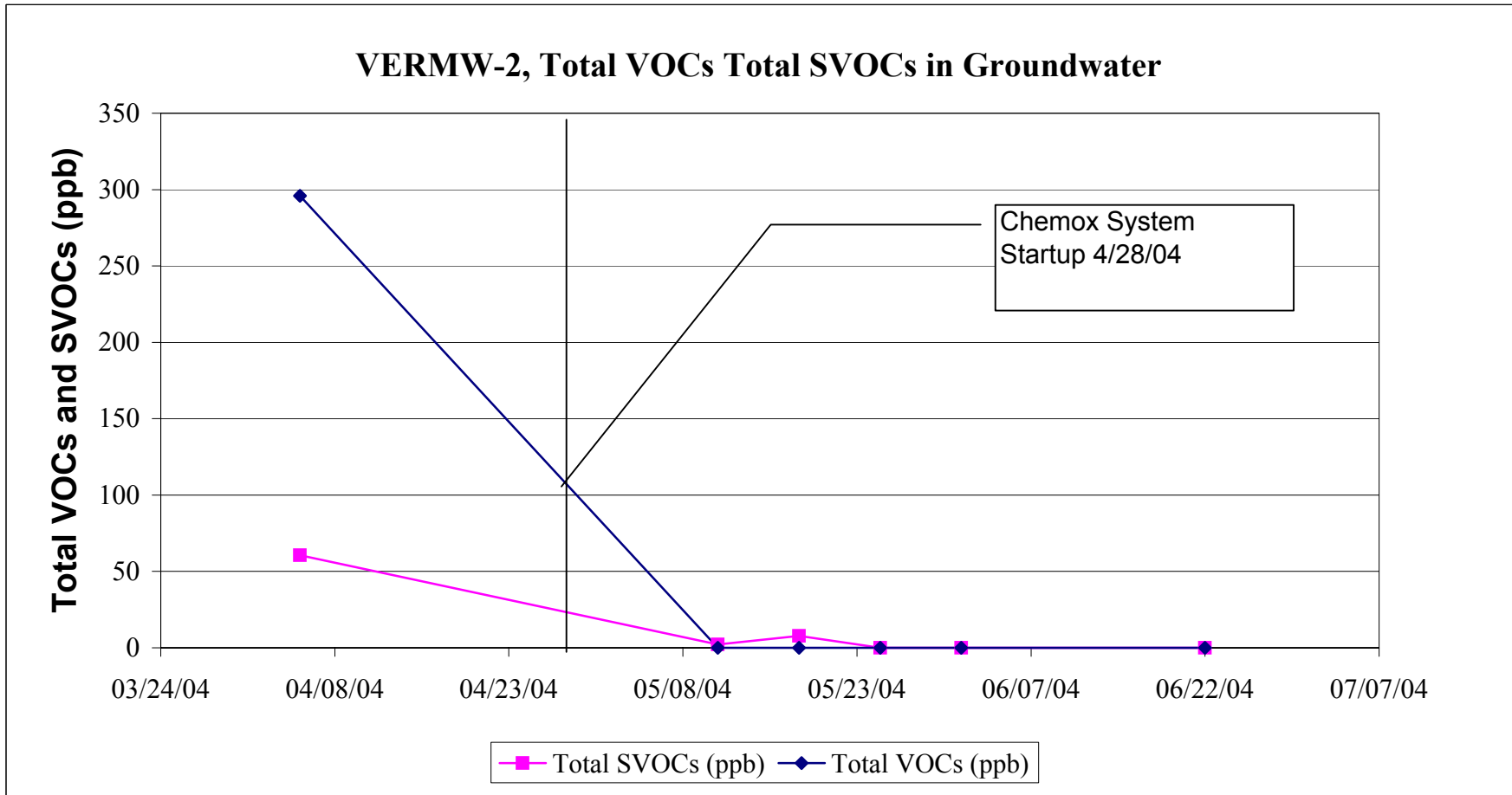

Figure 15. Summary of Total Volatile Organic Compounds (VOCs) and Semivolatile Organic Compounds (SVOCs) for MW-8R, Buffalo Terminal, ExxonMobil Oil Corporation, Buffalo, New York

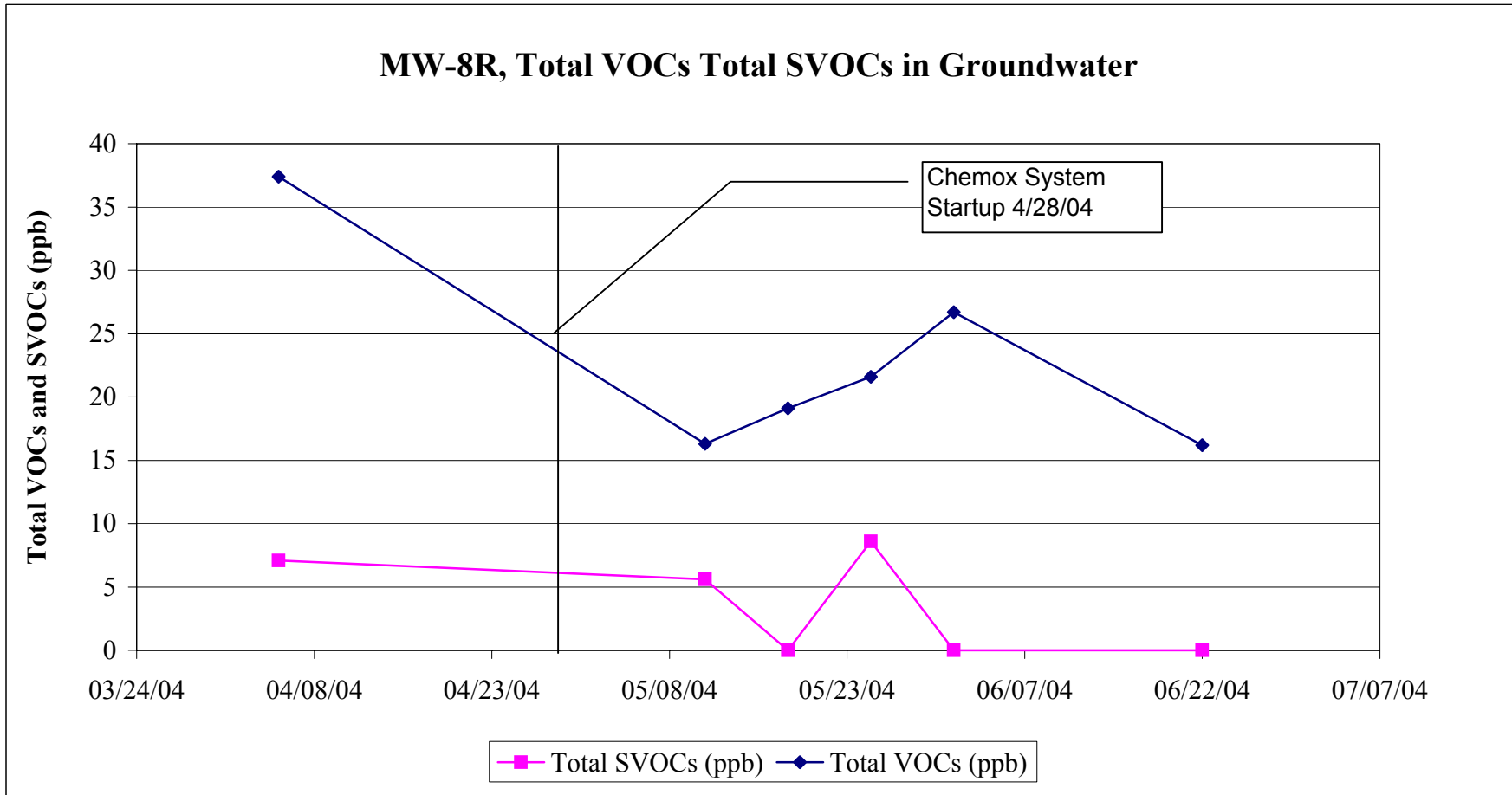

Figure 16. Summary of Total Volatile Organic Compounds (VOCs) and Semivolatile Organic Compounds (SVOCs) for MW-3URS, Buffalo Terminal, ExxonMobil Oil Corporation, Buffalo, New York

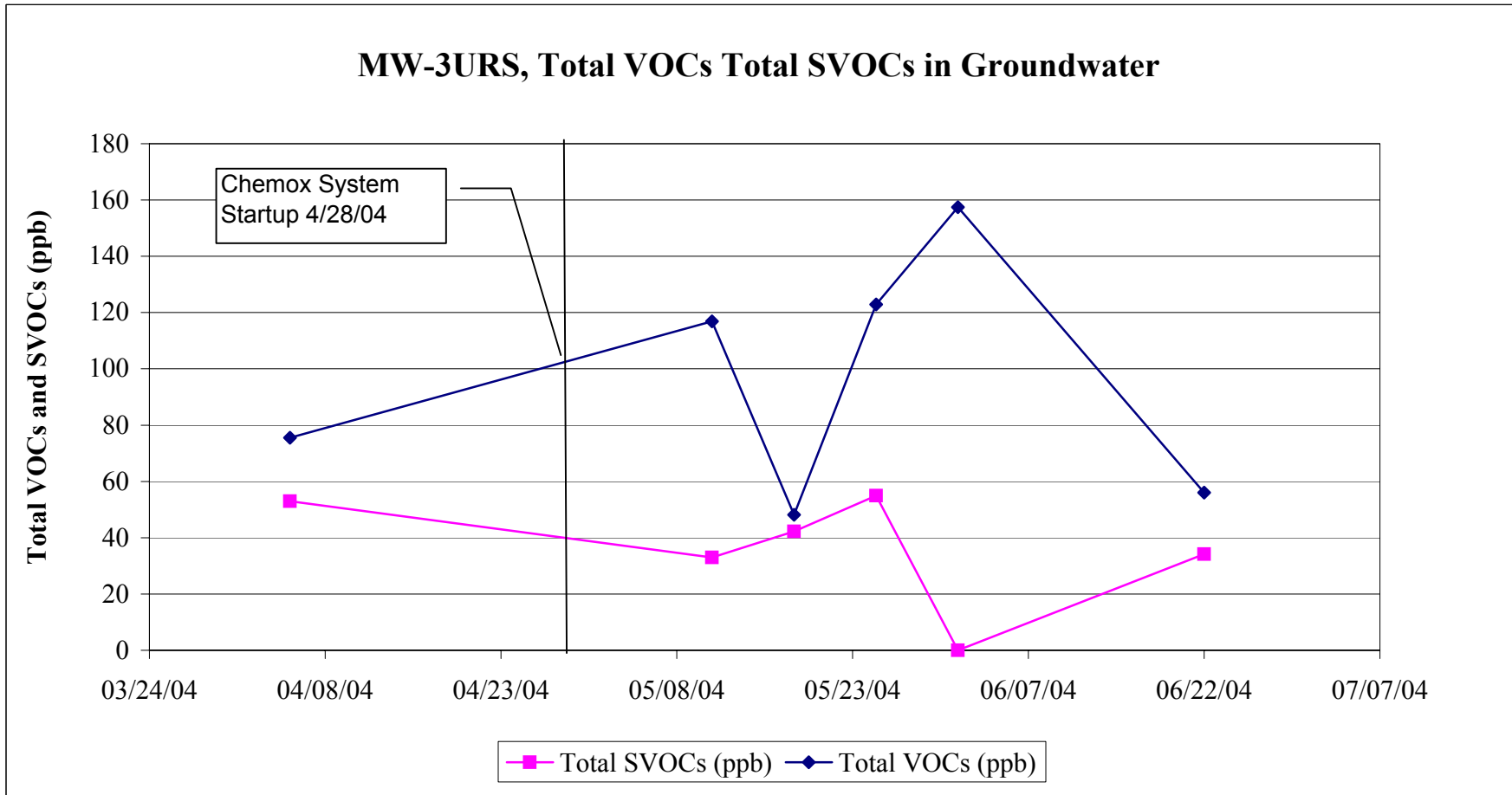

Figure 17. Summary of Total Volatile Organic Compounds (VOCs), Dissolved Oxygen (DO), Temperature and Oxidation Reduction Potential (ORP) for CO-1, Buffalo Terminal, ExxonMobil Oil Corporation, Buffalo, New York

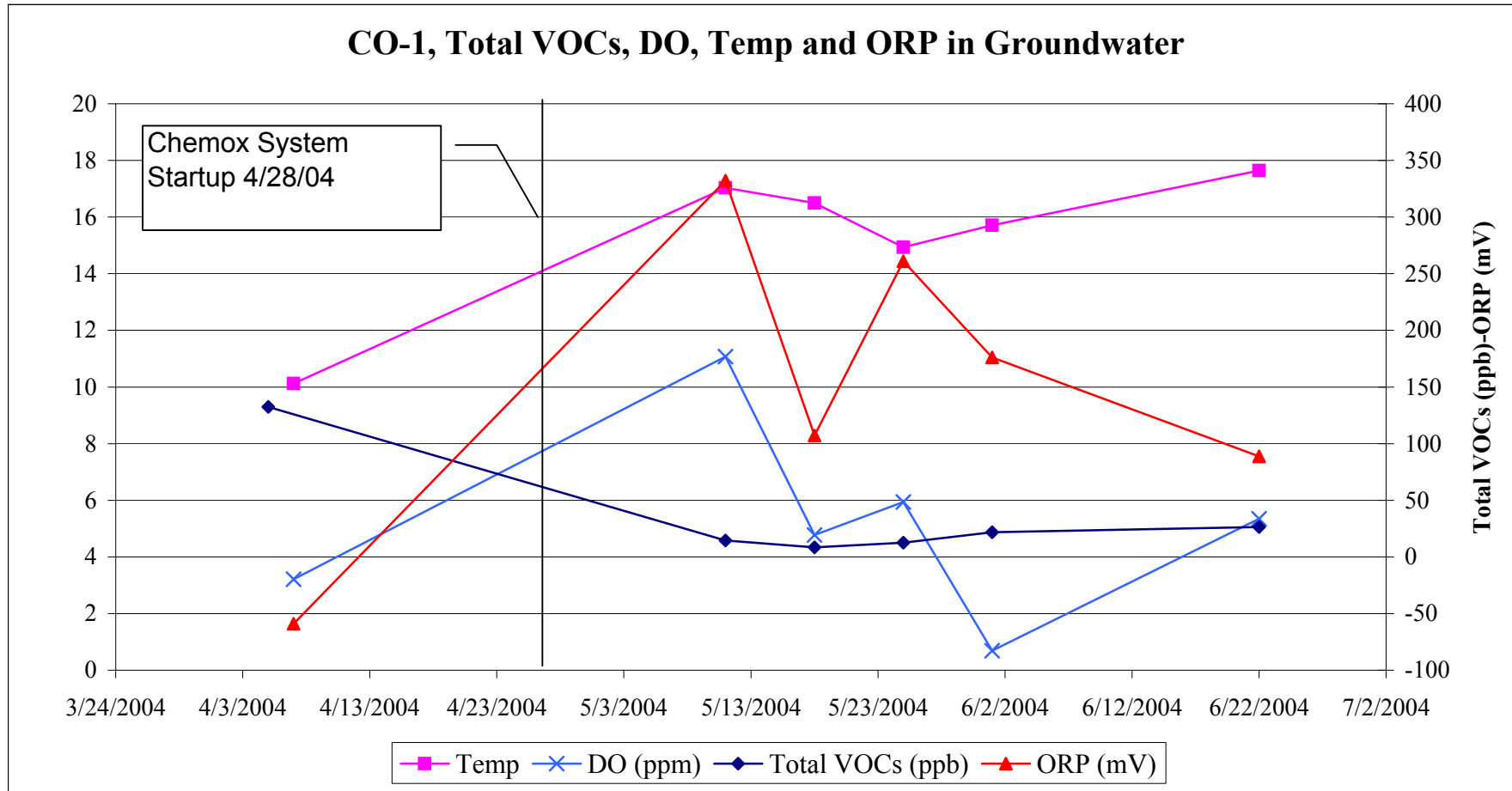

Figure 18. Summary of Total Volatile Organic Compounds (VOCs), Dissolved Oxygen (DO), Temperature and Oxidation Reduction Potential (ORP) for CO-2, Buffalo Terminal, ExxonMobil Oil Corporation, Buffalo, New York

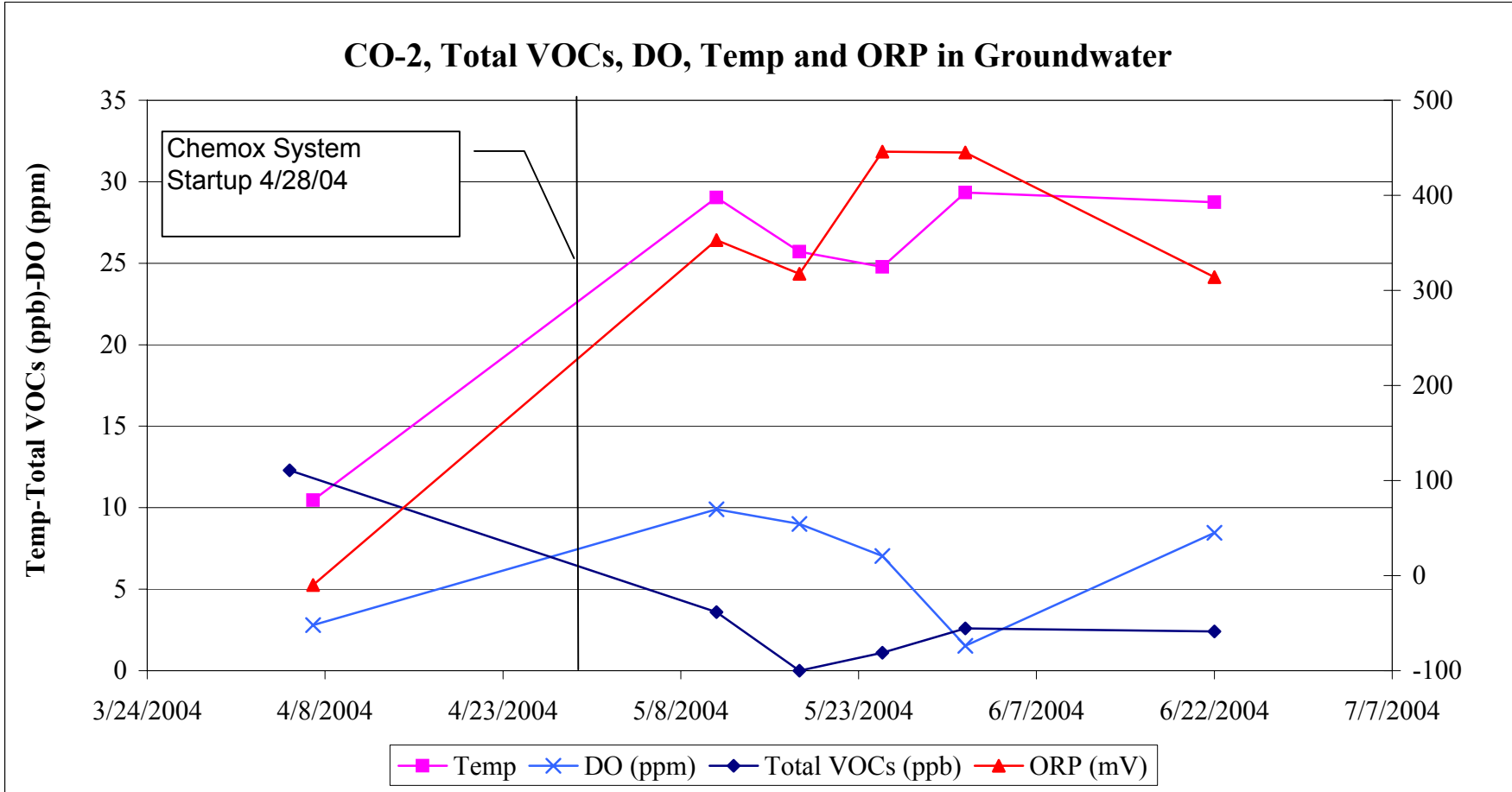

Figure 19. Summary of Total Volatile Organic Compounds (VOCs), Dissolved Oxygen (DO), Temperature and Oxidation Reduction Potential (ORP) for CO-3, Buffalo Terminal, ExxonMobil Oil Corporation, Buffalo, New York

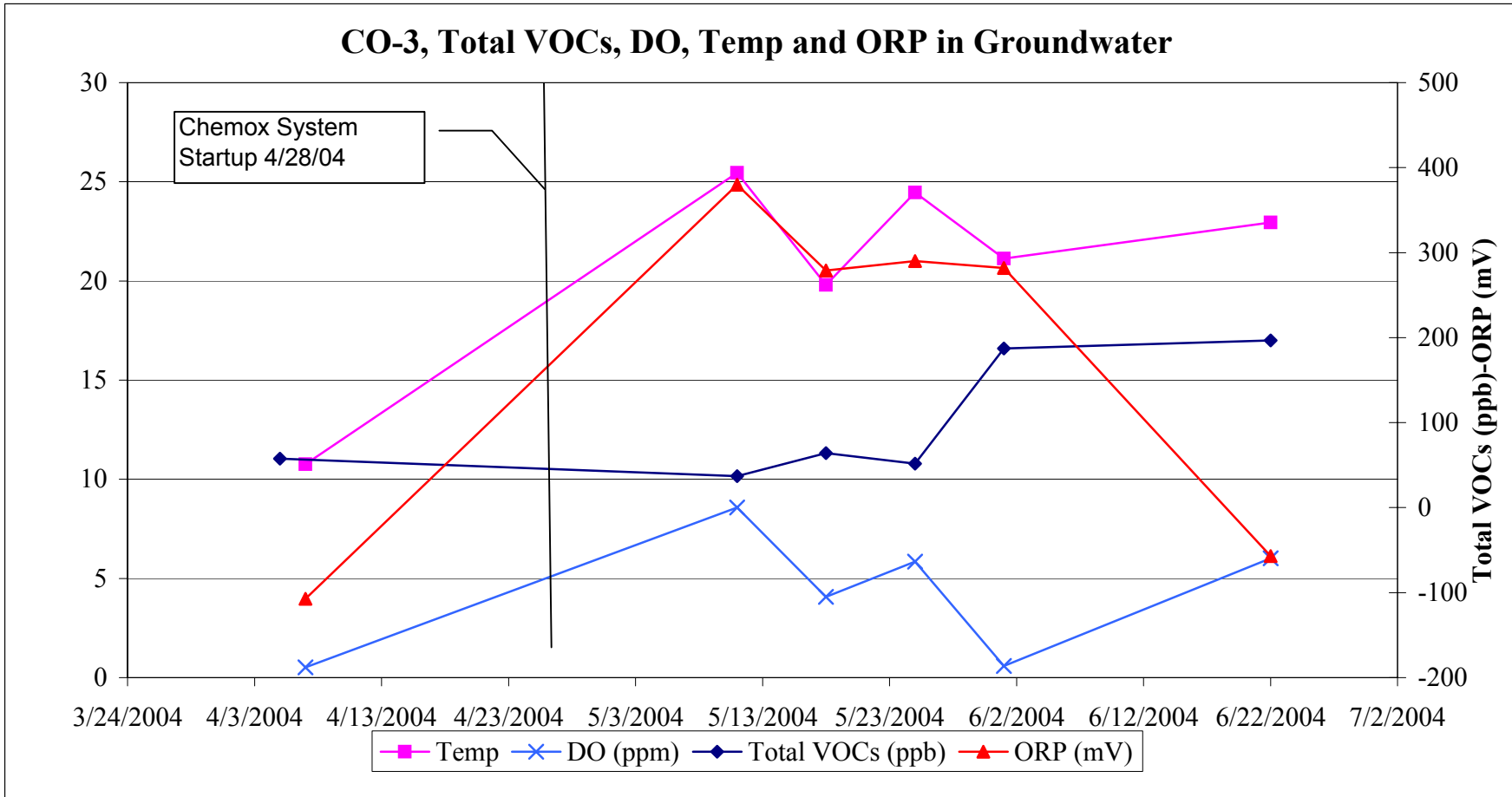

Figure 20. Summary of Total Volatile Organic Compounds (VOCs), Dissolved Oxygen (DO), Temperature and Oxidation Reduction Potential (ORP) for CO-4, Buffalo Terminal, ExxonMobil Oil Corporation, Buffalo, New York

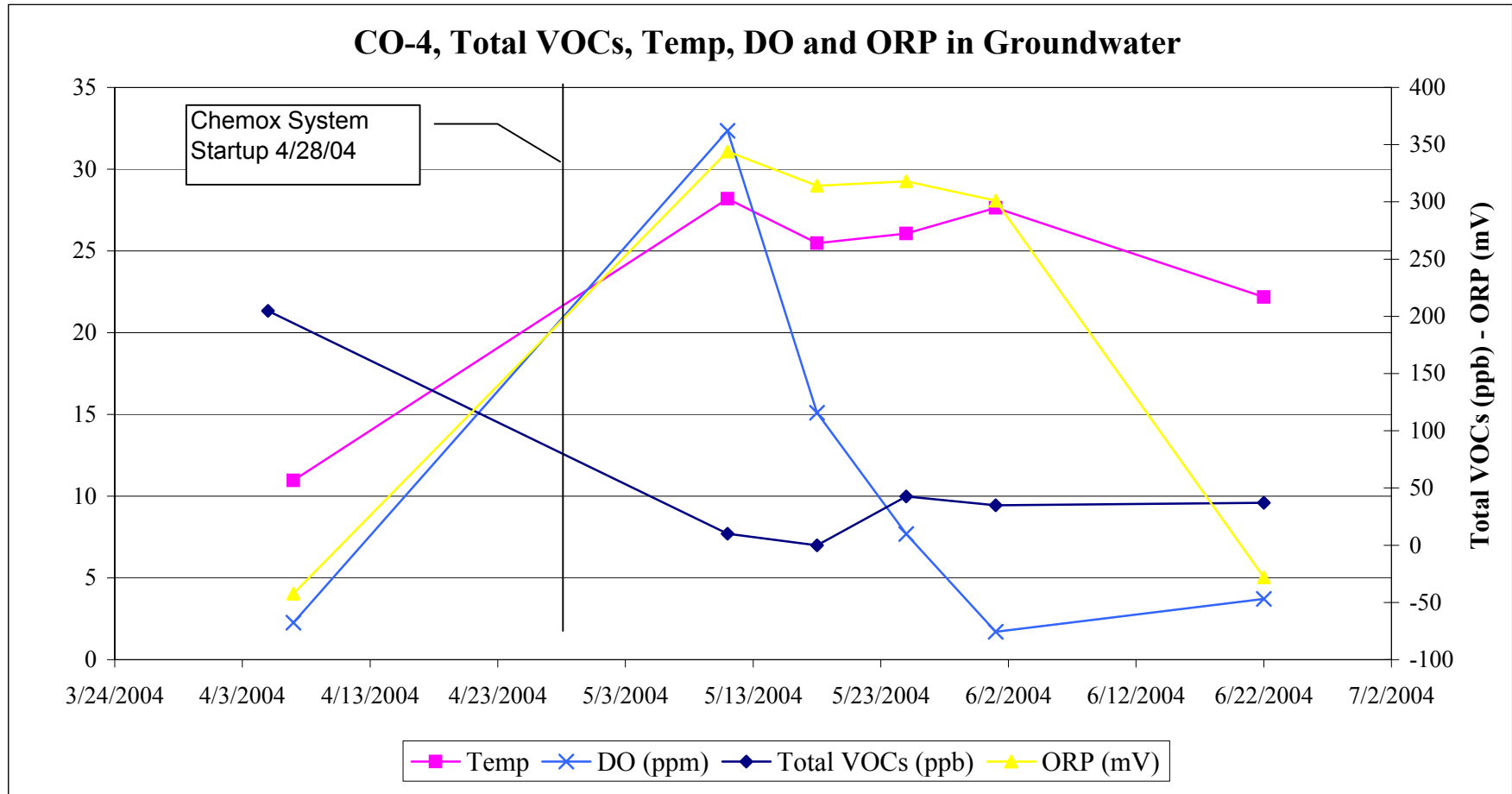

Figure 21. Summary of Total Volatile Organic Compounds (VOCs), Dissolved Oxygen (DO), Temperature and Oxidation Reduction Potential (ORP) for CO-5, Buffalo Terminal, ExxonMobil Oil Corporation, Buffalo, New York

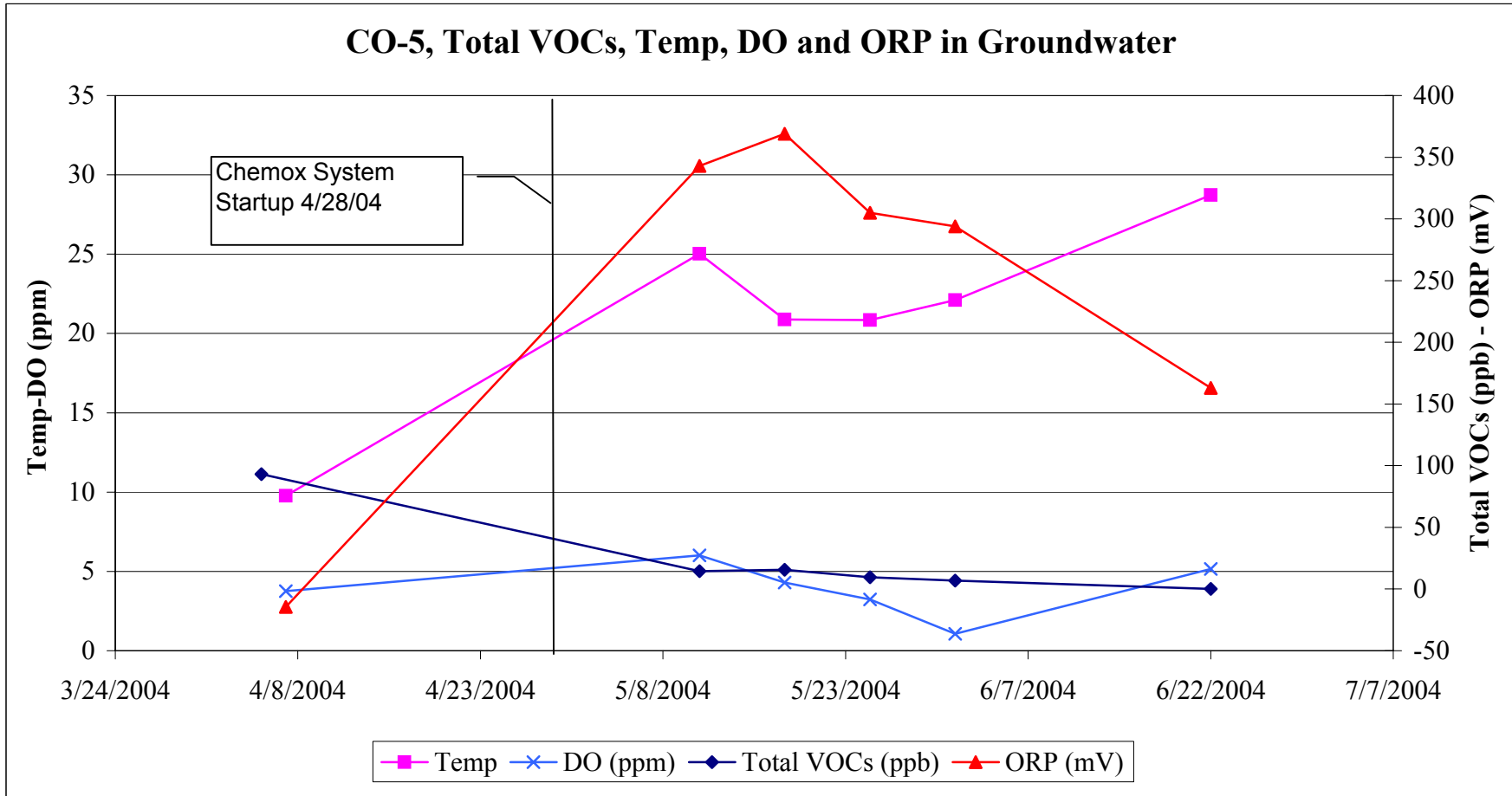

Figure 22. Summary of Total Volatile Organic Compounds (VOCs), Dissolved Oxygen (DO), Temperature and Oxidation Reduction Potential (ORP) for VERMW-1, Buffalo Terminal, ExxonMobil Oil Corporation, Buffalo, New York

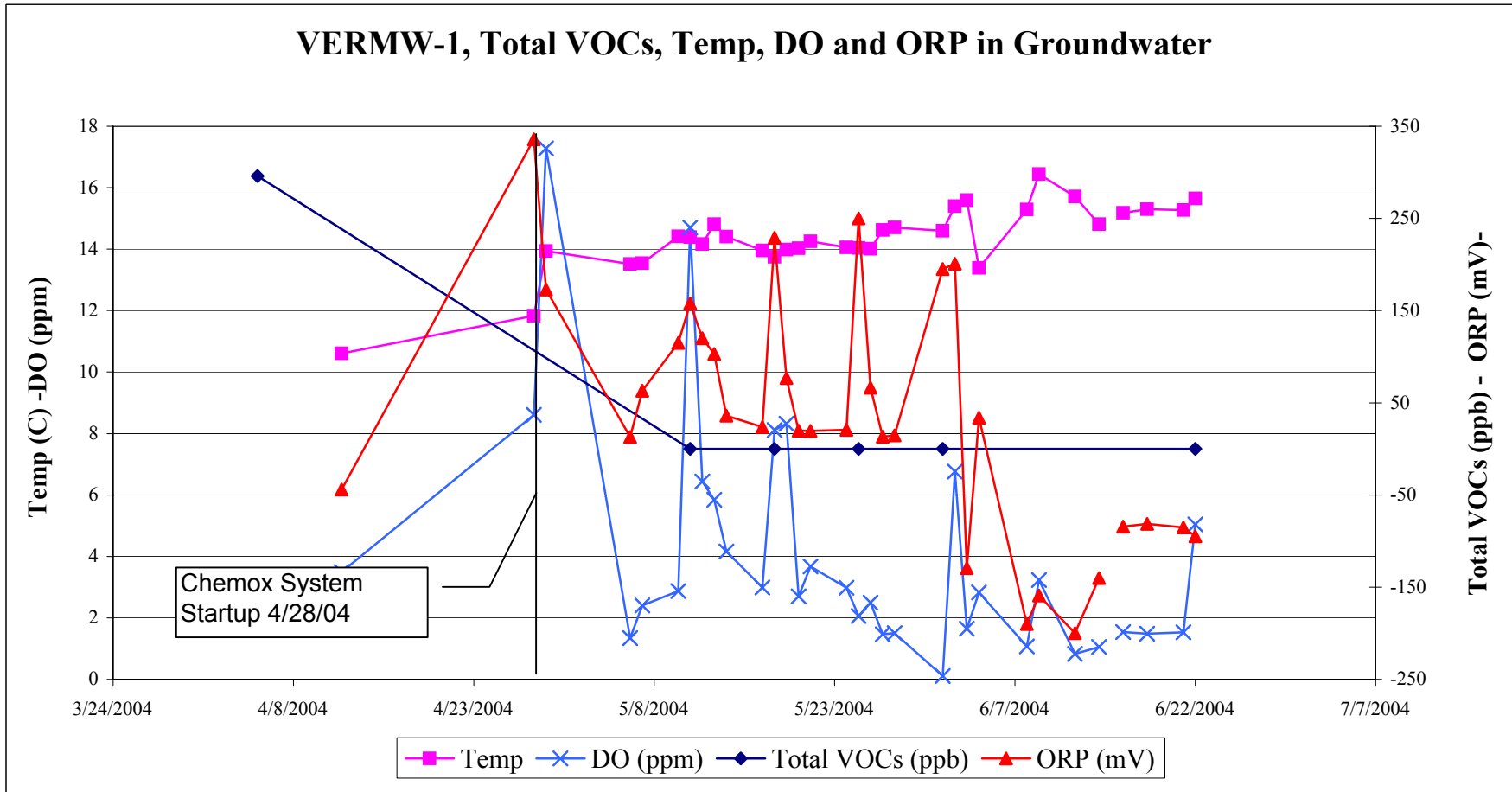
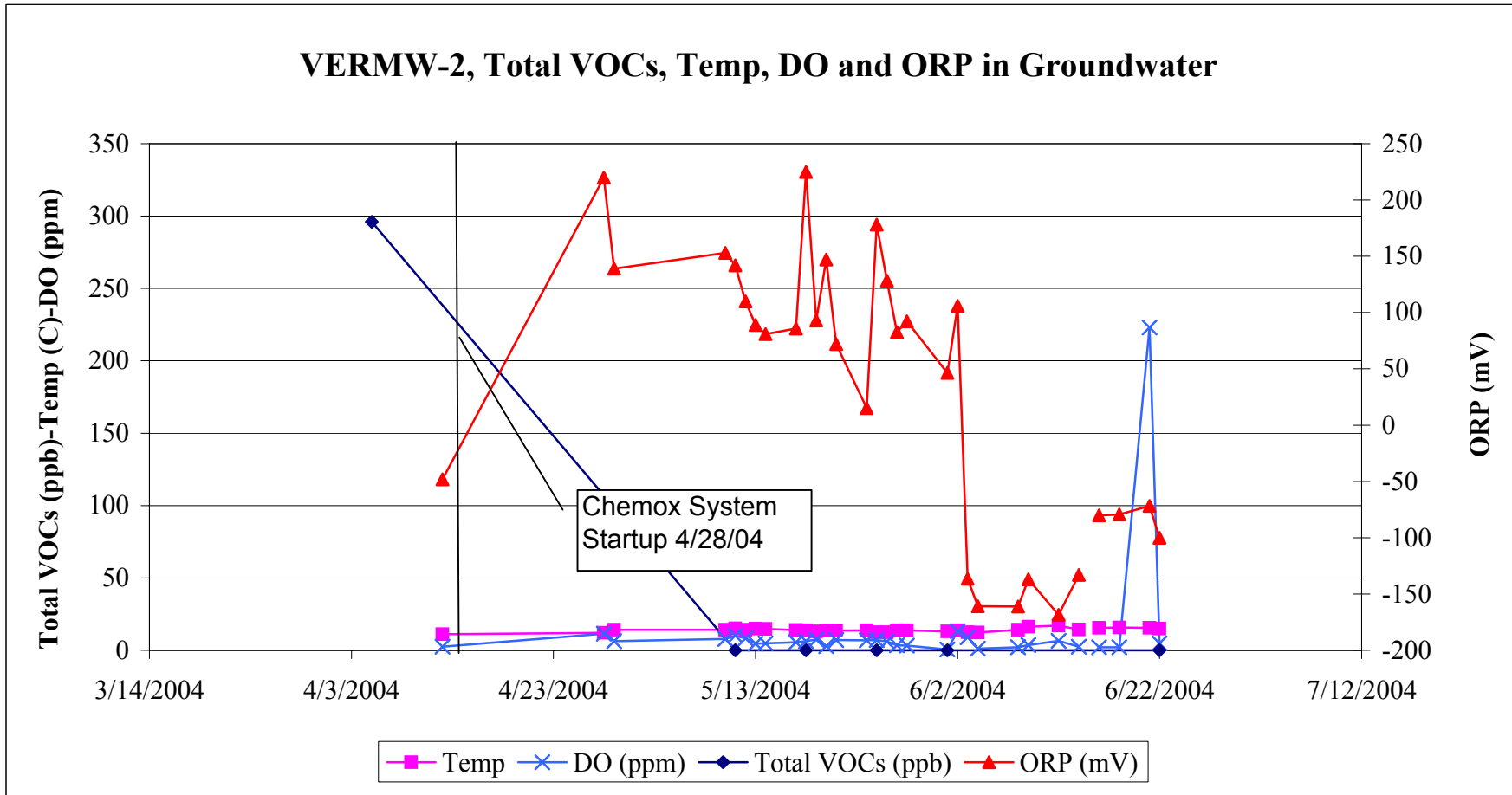

Figure 23. Summary of Total Volatile Organic Compounds (VOCs), Dissolved Oxygen (DO), Temperature and Oxidation Reduction Potential (ORP) for VERMW-2, Buffalo Terminal, ExxonMobil Oil Corporation, Buffalo, New York



LEGEND

- PROPOSED CHEMOX INJECTION WELL (TWO NESTED WELLS PER LOCATION)
- ▲ PROPOSED MEMBRANE INTERFACE PROBE LOCATION
- ⊙ PROPOSED GROUNDWATER OBSERVATION WELL
- EXISTING CHEMOX PILOT TEST INJECTION WELL (TWO NESTED WELLS PER LOCATION)
- ▲ EXISTING MEMBRANE INTERFACE PROBE LOCATION
- ⊙ EXISTING PILOT TEST OBSERVATION WELL
- EXISTING RECOVERY WELL
- ⊕ EXISTING MONITORING WELL
- CHEMOX CELL BOUNDARY
- G—G' LOCATION OF HYDROGEOLOGIC CROSS SECTION G-G' THROUGH THE CHEMOX IRM TARGET AREA

CHEMOX = CHEMICAL OXIDATION

NOTE: THE LOCATIONS OF PROPOSED CHEMOX WELLS, OBSERVATION WELLS AND MIP BORING LOCATIONS ARE APPROXIMATE.

- HISTORICAL WASTE HANDLING AREAS
- LIMITS OF SORBENT BOOM (proportions exaggerated for clarity)
- AREA OF PRODUCT SEEPAGE OBSERVED ON OCTOBER 26, 2000 (proportions exaggerated for clarity)
- LIMIT OF CURRENT AND HISTORICAL SEPARATE-PHASE PRODUCT OBSERVED IN MONITORING WELLS
- APPROXIMATE COURSE OF FORMER BUFFALO RIVER CHANNEL

- PORTION OF EXXON MOBIL CORP.'S BURIED PRODUCT PIPELINE THAT IS ABANDONED (Line purged and abandoned in place)
- PORTION OF EXXON MOBIL CORP.'S BURIED PRODUCT PIPELINE THAT IS ACTIVE
- EXXON MOBIL CORP.'S ACTIVE ABOVEGROUND PRODUCT PIPELINE
- LAKEHEAD PIPELINE CO.'S, BURIED PRODUCT PIPELINE (Line reportedly purged and filled with nitrogen in 1982)
- APPROXIMATE EXXON MOBIL CORP.'S PROPERTY LINE

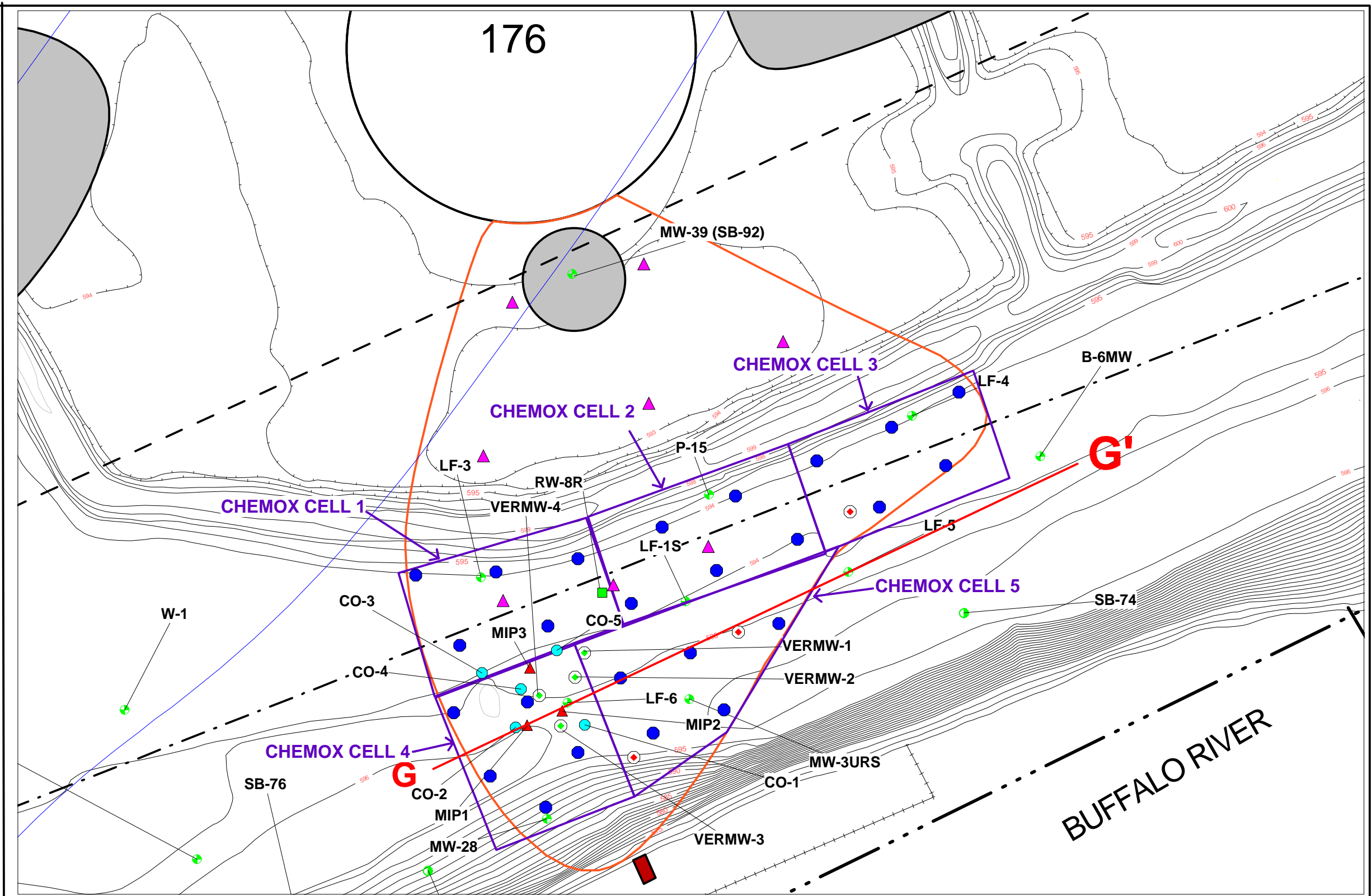

SITE PLAN WITH PROPOSED CHEMICAL OXIDATION SYSTEM IRM AND MONITORING NETWORK LAYOUT			
Prepared For: EXXONMOBIL OIL CORPORATION			
ROUX Environmental Consulting & Management	Compiled by: NC	Date: 11/30/04	FIGURE 24
	Prepared by: NC	Scale: AS SHOWN	
	Project Mgr: NC	Office: NY	
File No: MCS224102.WCR	Project: 17252Y05		

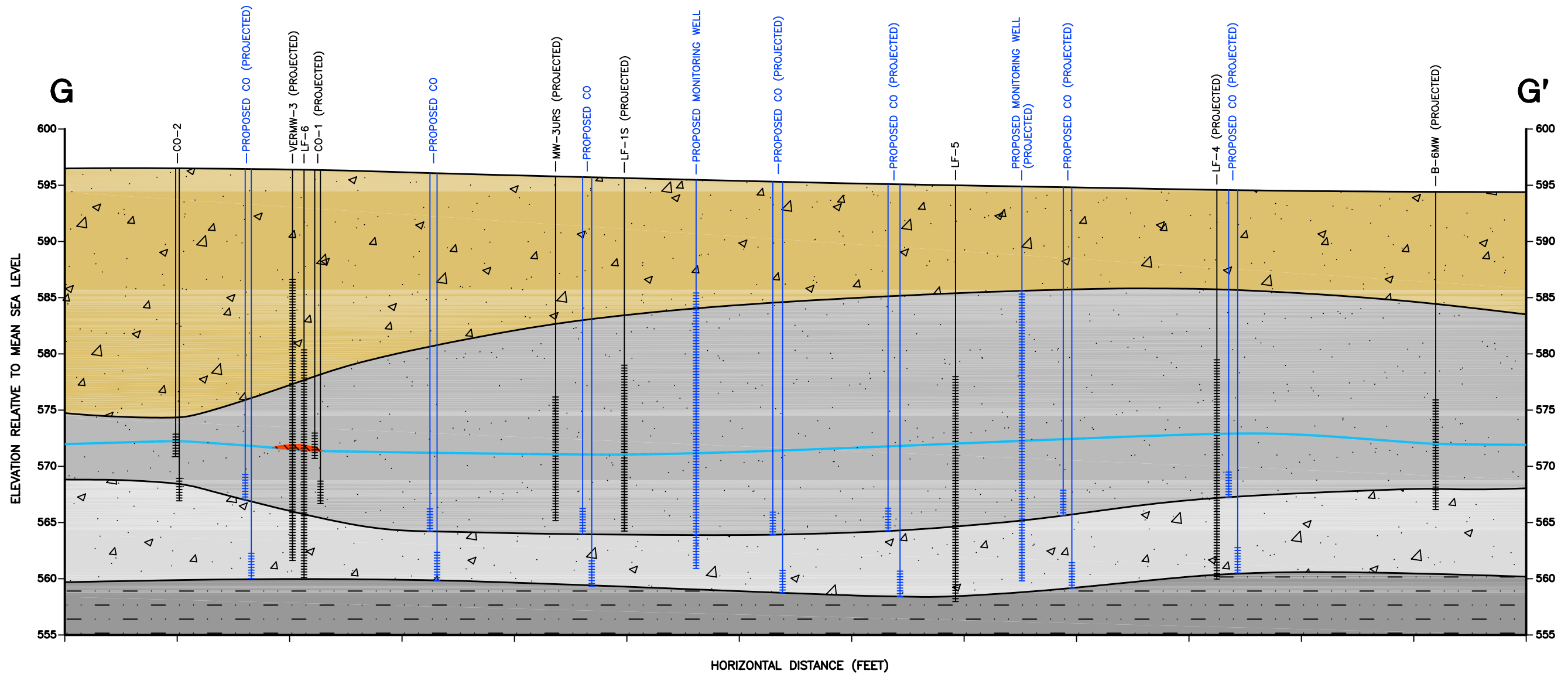

LEGEND

	BUFFALO RIVER ELEVATION IN FEET ABOVE MEAN SEA LEVEL		FILL MATERIAL CONSISTING OF BLACK CINDERS, CONCRETE, BRICK, GLASS, SLAG, WOOD, SILT, GRAVEL AND SAND		CLAY
	WATER-TABLE ELEVATION IN FEET ABOVE MEAN SEA LEVEL		ALLUVIAL DEPOSITS (SAND, SAND AND SILT, SAND AND GRAVEL, SILTY SAND, SILT)		SEPARATE-PHASE PRODUCT
	INDICATES MONITORING WELL SCREENED INTERVAL		ALLUVIAL DEPOSITS (SAND AND GRAVEL)		
	INDICATES SOIL BORING				
	INDICATES PROPOSED CHEMOX INJECTION WELL (CO) (2 NESTED WELLS PER LOCATION) AND PROPOSED MONITORING WELL				

- NOTES:**
- FOR LOCATION OF SECTION LINES SEE PLATE 1.
 - LAND SURFACE SHOWN IS ALONG THE SECTION CUT LINE, NOT NECESSARILY AT THE WELL/BORING LOCATIONS IF WELL/BORING IS PROJECTED ONTO THE LINE.
 - MW-28 HAS A SOLAR POWERED PRODUCT RECOVERY PUMP INSTALLED SINCE APRIL 5, 2001.
 - LINES SEPARATING CLAY LAYER FROM SAND AND GRAVEL LAYER ARE SHOWN DASHED WHERE INFERRED.

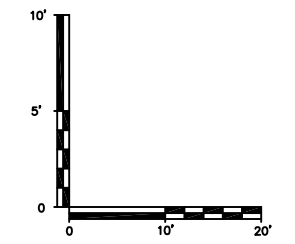

Title: GENERALIZED HYDROGEOLOGIC CROSS SECTION G-G' THROUGH PROPOSED CHEMOX IRM AREA

BUFFALO TERMINAL, BUFFALO, NEW YORK

Prepared For: EXXONMOBIL OIL CORPORATION

 ROUX ASSOCIATES, INC. Environmental Consulting & Management	Compiled by: N.C.	Date: 21AUG04	FIGURE
	Prepared by: R.K.	Scale: AS SHOWN	
	Project Mgr: N.C.	Office: NY	
	File No: MC5224102	Project: 17252Y06	

25

N:\PROJECTS\MC1121\MC5224102\DWG

APPENDIX A

Hydrographs of Selected Wells

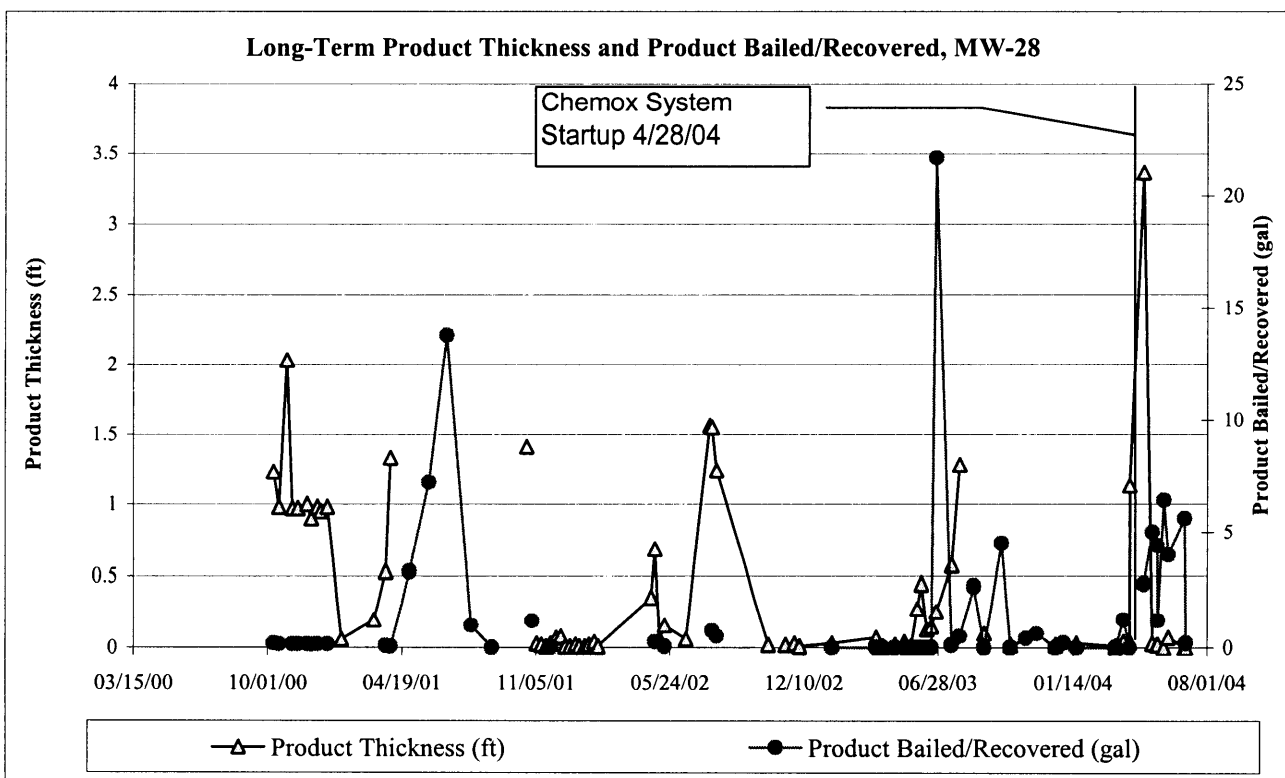
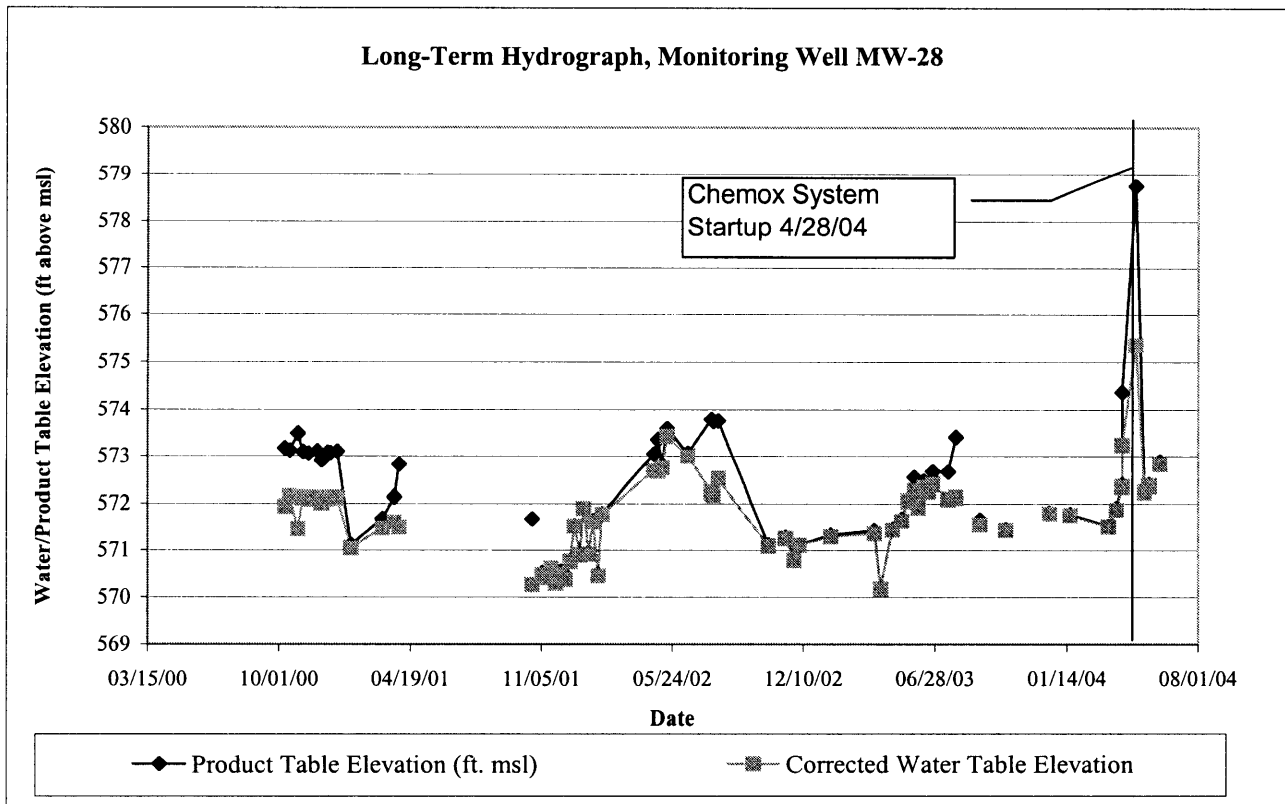

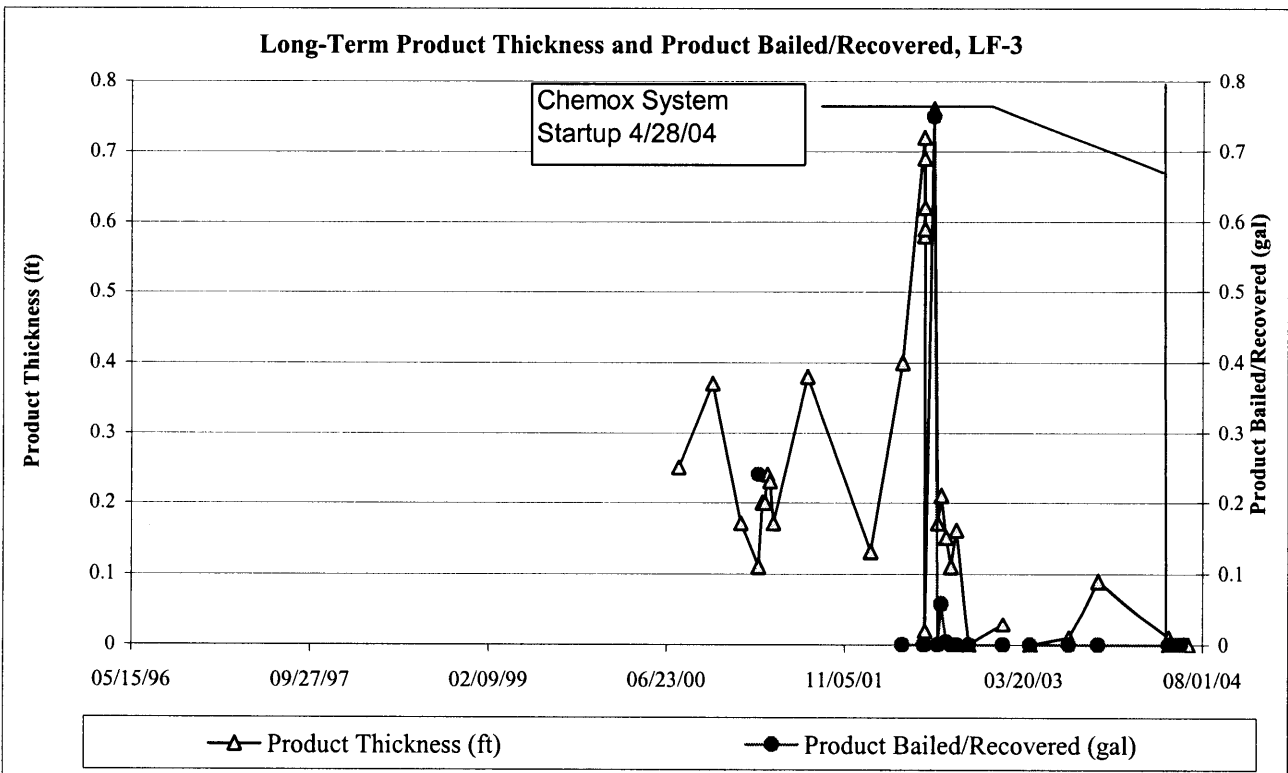
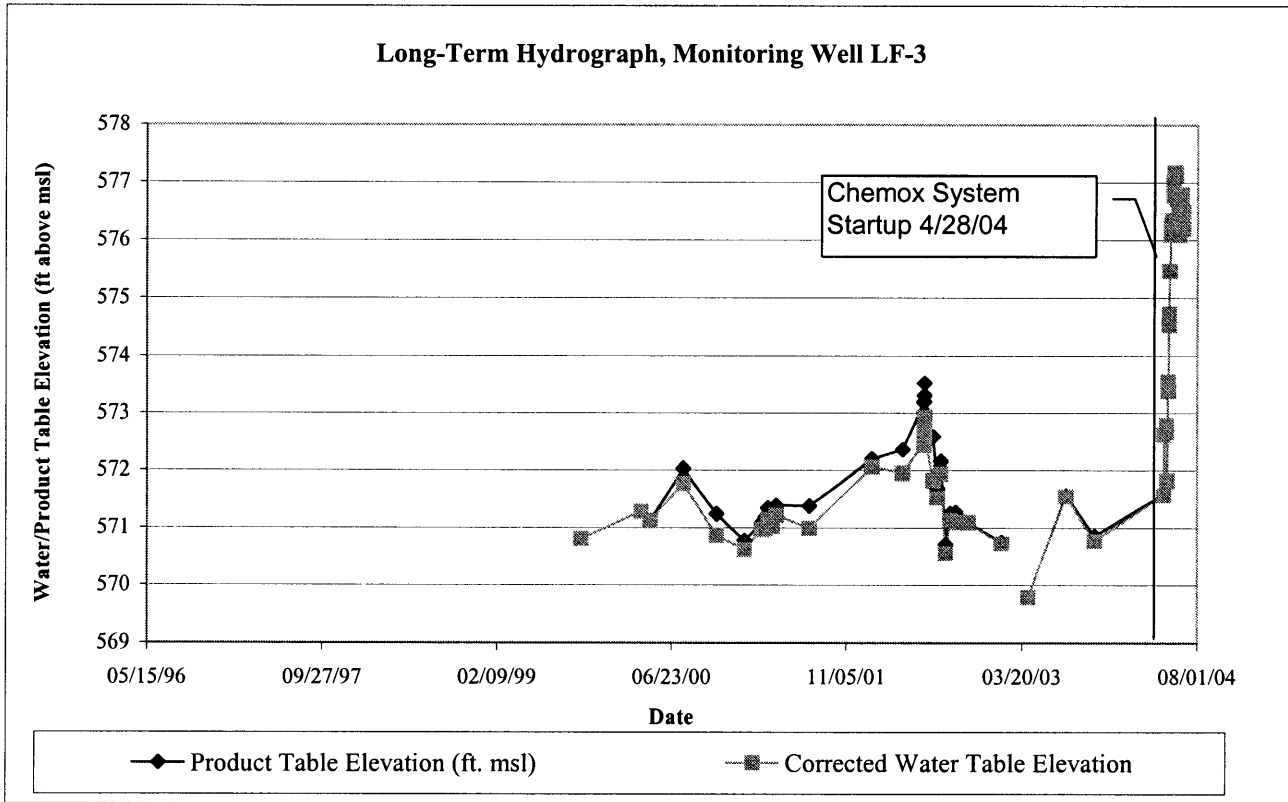

Long-Term Hydrographs for LF-6 (ETYA) during ChemOx Pilot Test, Buffalo Terminal, ExxonMobil Oil Corporation, Buffalo, New York

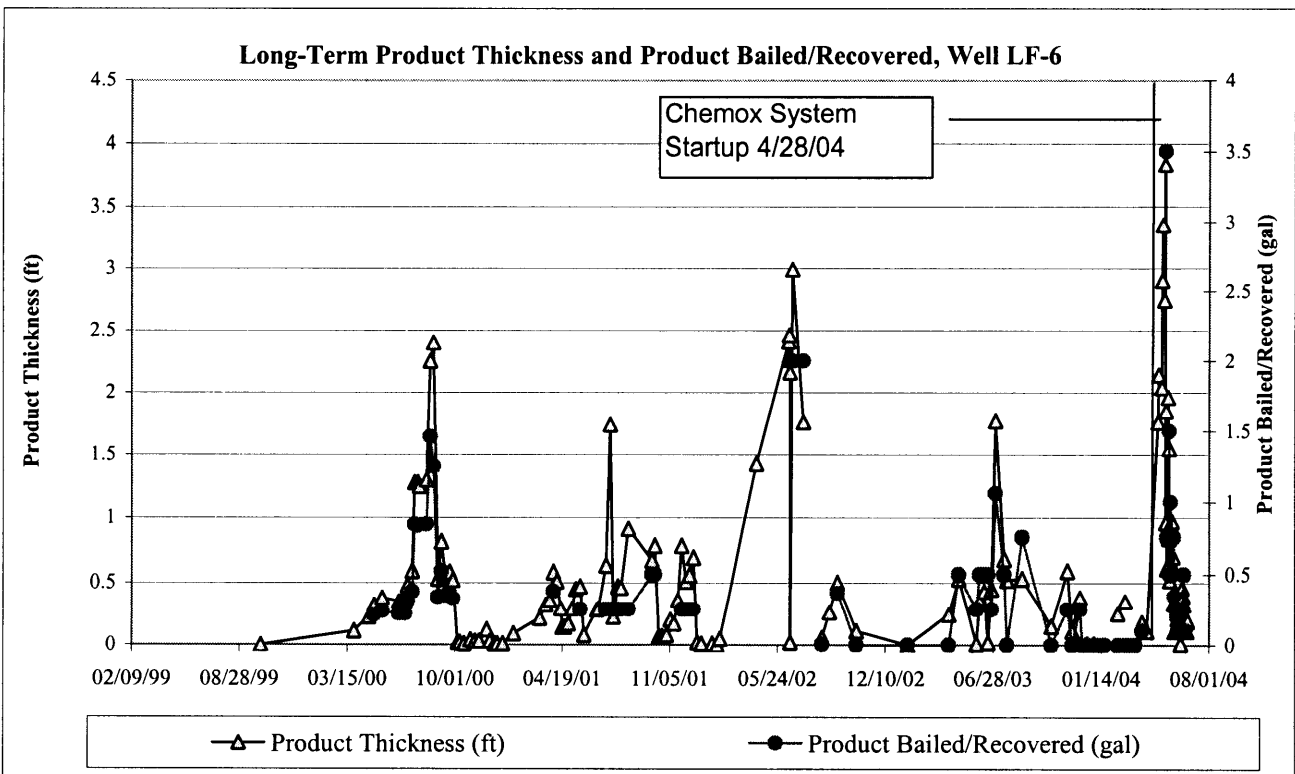
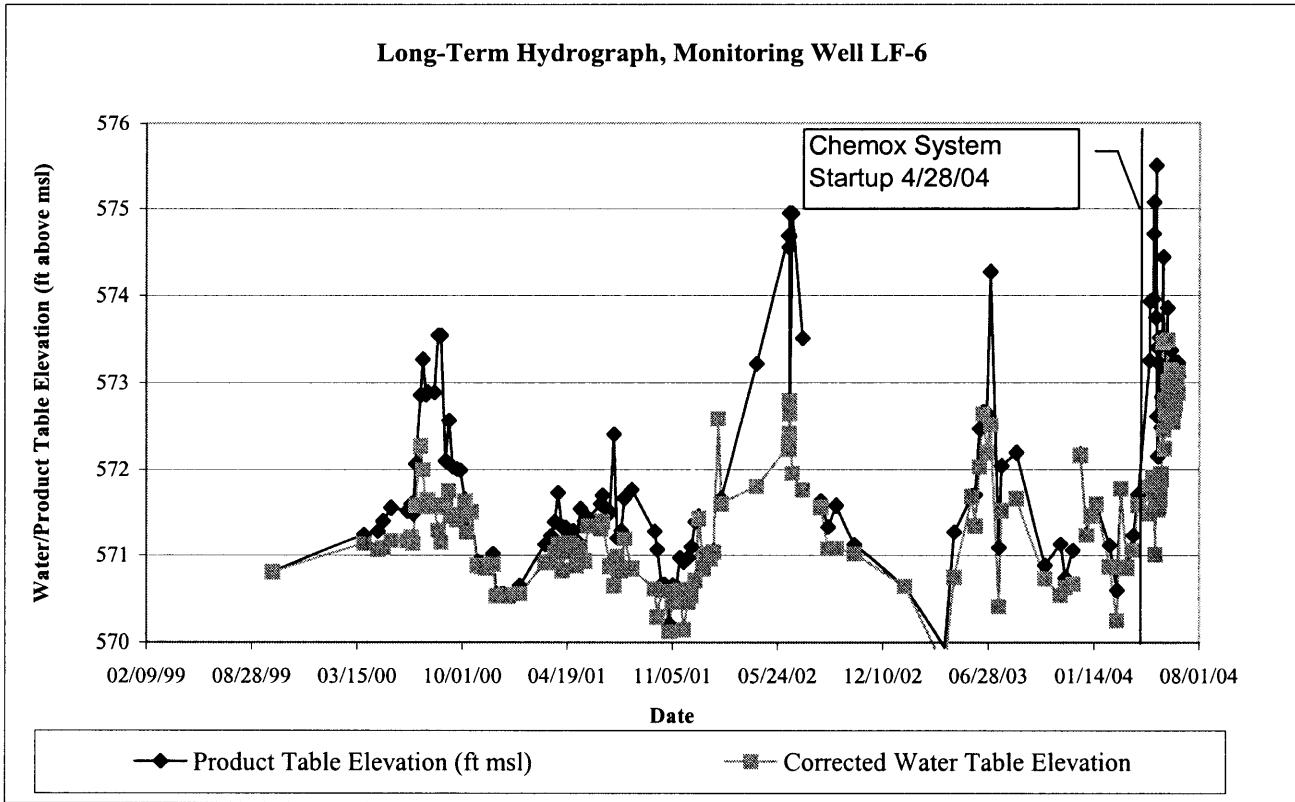

Long-Term Hydrographs for LF-1S (ETYA) during ChemOx Pilot Test, Buffalo Terminal, ExxonMobil Oil Corporation, Buffalo, New York

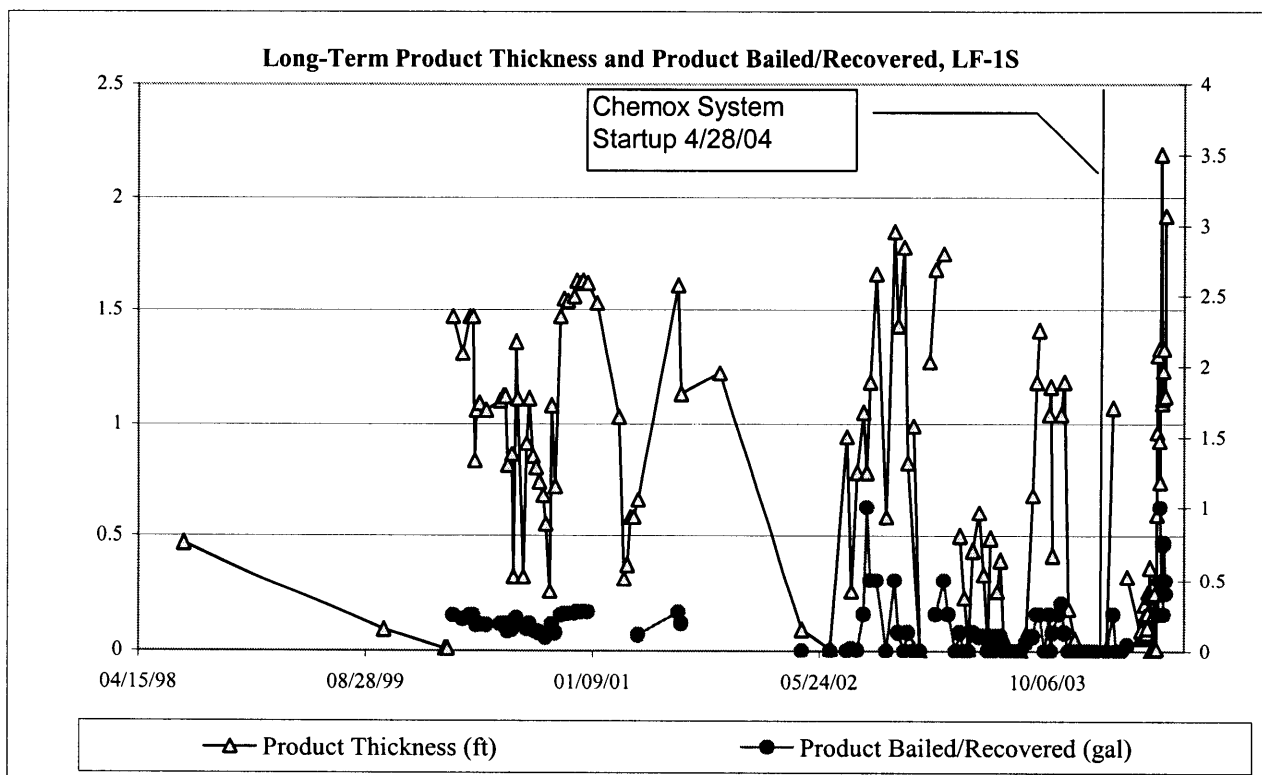
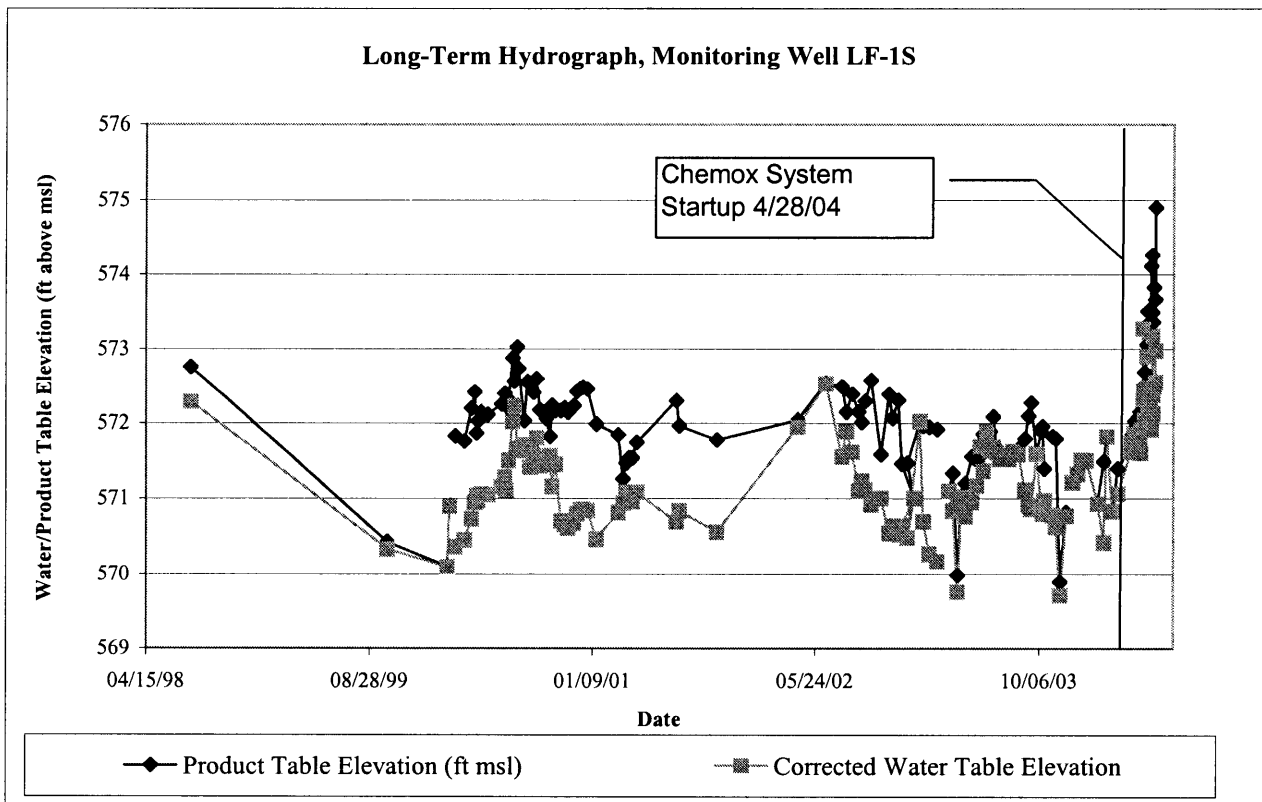

APPENDIX B

Separate-Phase Product Analysis Results for ETYA Wells

TABLE 1
 FREE PRODUCT INVESTIGATION
 BUFFALO, NY
 TERMINAL # 31-010

SAMPLE INFORMATION

Sample Number:	00-6495	00-6497
Date of Sample:	11/3/00	11/3/00
Date Received:	11/6/00	11/6/00
Sample Description:	MW-28	LF-1S
Appearance:	Dark brown hydrocarbon in a pint bottle	Dark brown hydrocarbon in a pint bottle

ANALYTICAL DATA

API Gravity @ 60 °F (TSL LP 78)	28.8	28.6
Lead Content, g/gal (ESL LP)	0.00	0.00

High Temperature Simulated Distillation
 (Mobil Method 1567)

Initial Boiling Point, °F	250	256
2 % recovered, °F	307	309
5 % recovered, °F	336	336
10 % recovered, °F	370	370
20 % recovered, °F	417	417
30 % recovered, °F	444	444
40 % recovered, °F	475	475
50 % recovered, °F	495	495
60 % recovered, °F	518	520
70 % recovered, °F	543	545
80 % recovered, °F	576	576
90 % recovered, °F	613	613
95 % recovered, °F	648	648
98 % recovered, °F	685	685
Final Boiling Point, °F	752	751

Comparative Hydrocarbon Distribution by Gas Chromatography, GC Fingerprint (ESL LP 26) The fingerprints of MW-28 and LF-1S show severely biodegraded diesel fuels and are identical to each other.

Composition by GC/FID, High Temperature
 Simulated Distillated Distillation and

Fingerprint		
% Gasoline	0	0
% Distillate	100	100
% Higher Boiling Material	0	0

ExxonMobil Research & Engineering, Paulsboro Technical Center, Paulsboro, NJ
 AJ Malanowicz/DH Richman
 November 17, 2000

APPENDIX C

Well Construction Logs for Pilot Test Area Wells

**MOBIL TERMINAL 31010
625 Elk Street, Buffalo, New York**



**Subsurface Log
LF-1S**

Owner: Mobil
Permit No.:
Casing Elevation:
Screen Diameter: 2"
Screen Length: 15'
Casing Diameter: 2"
Casing Length: 15'

Log By: Annmarie Kearns
Driller: GES
Drilling Method: Hollow Stem Auger
Slot Size: 10
Type: PVC
Sample Method: Split Spoon
Borehole Diameter: 6"
Water Level (Init):

Date: 06/30/98

Construction Details

Total Well Depth: 30'
Screen Interval: 15'-30'
Sand Pack Interval: 13'-30'
Sand Pack Type: #0

Backfill Interval: NA
Cement/Grout Interval: 0'-12'
Bentonite Interval: 12'-13'
Completion Details:

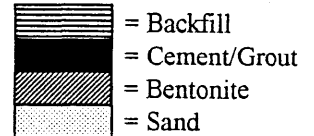

(ft)	Sample Depth (ft)	PID (ppm)	Lithology: Burmister Classification System	Well Schematic
0	0-2	14	FILL , fine to coarse Sand and Silt, trace fine Gravel and glass.	
2	2-4	1.5	FILL, fine to coarse Sand, trace (+) fine Gravel and Glass (2" clay layer @ 2').	
4	4-6	0	4-5' FILL, fine to coarse Sand and SILT, some fine to medium Gravel. 5-5.5" FILL, medium to coarse Sand. 5.5-8' FILL, fine to coarse Sand and Glass.	
6	6-8	0	FILL, fine Sand and Silt, brick, metallic slag.	
8	8-10	0	FILL, fine Sand and Silt, Brick.	
10	10-12	1.0	FILL, fine to coarse Sand, metallic slag.	
12	12-14	1.0	14-14.5' FILL, Cinders, metallic slag. 14.5-16' SILT, trace Clay.	
14	14-16	1.5	SILT and fine SAND.	
16	16-18	0.4	SILT and fine SAND.	
18	18-20	90	SILT and fine SAND.	
20	20-22	65	SILT and fine SAND.	
22	22-24	NC	22-23.4' Fine SAND and SILT. 23.4-23.8 Medium to coarse SAND, product in sample, strong odor. Not Recorded.	
24	24-26	50	Medium to coarse SAND, petroleum sheen and odor 27-28'. 28-29.2' Medium to coarse SAND. 29.2-29.6' WOOD. 29.6-30' Medium to coarse SAND and GRAVEL, petroleum sheen and odor present.	
26	26-28	80	30-31' Medium to coarse SAND. 31-32 Medium to coarse GRAVEL, some medium to coarse Sand, petroleum sheen.	
28	28-30	35	Medium to coarse SAND and fine to coarse GRAVEL.	
30	30-32	17	Medium to coarse SAND and fine to coarse GRAVEL. Note: Petroleum sheen in samples from 26-32' is likely present due to product in the soil at 23.4-23.8'.	
32	32-34	8	Bottom of boring @ 36 feet. Bedrock not encountered.	
34	34-36	5.5		
36				



ROUX ASSOCIATES, INC.
Environmental Consulting
& Management

1377 Motor Parkway
Islandia, NY 11749
Telephone: 631-232-2600
Fax: 631-232-9898

WELL CONSTRUCTION LOG

WELL NO. RW-8-R		NORTHING 1042649.43		EASTING 1082293.36	
PROJECT NO./NAME 17252Y04 / ExxonMobil Buffalo Terminal			LOCATION 625 Elk Street		
APPROVED BY S. Senh		LOGGED BY M. Falzone		Buffalo, New York	
DRILLING CONTRACTOR/DRILLER SJB / SJB			GEOGRAPHIC AREA ETYA		
DRILL BIT DIAMETER/TYPE 10.25-in. / Auger	BOREHOLE DIAMETER 18-inches	DRILLING EQUIPMENT/METHOD / HSA	SAMPLING METHOD 2" Split Spoon	START-FINISH DATE 8/1/02-8/2/02	
CASING MAT./DIA. Stainless Stl / 10-inch	SCREEN: TYPE Slotted	MAT. Stainless Steel		TOTAL LENGTH 30.0	DIA. 10-inch
ELEVATION OF: (FT.)		GROUND SURFACE 593.81	TOP OF WELL CASING 593.40	TOP & BOTTOM SCREEN 585.8 / 555.8	GW SURFACE 571.16
				GRAVEL PACK Morie #1	

Depth, feet	Graphic Log	Visual Description	Blow Counts per 6"	PID Values (ppm)	REMARKS
0	Flushmount				Hand cleared
5	Cement seal Ground seal Bentonite pellets	Fill - Coarse Sand and Ash, glass, slag; dry	4 2 2 1 1 1 1		10 % Recovery
10		Fill - Medium to coarse SAND, some fine to coarse Gravel; dry	1 1 1 5 5 5		10 % Recovery
15	# 1 Morie Sand	Fill - Medium to coarse SAND, some fine to coarse Gravel; dry	4 3 2 3		10 % Recovery
20		Red brown CLAY, with embedded Coal, trace fine Sand and Silt; dry			10 % Recovery
25	20-Slot stainless steel	No Recovery	4 3 5 4 4 5 7		20 % Recovery
30		Black fine Sand and Silt and Clay, some organic matter, wood, coal; dry	4 4 2 3 3 5 7 12 12		50 % Recovery
35		Black fine Sand and Silt and Clay; moist	4 2 3 3 3		50 % Recovery
		Olive gray fine SAND, some Silt and Clay; moist	5 7 12 12		70 % Recovery
		Olive gray fine to medium SAND, little Silt and Clay; wet	5 7 4 4 7 6 6 8 4 6 3 3		70 % Recovery
		Olive gray fine to medium SAND, little Silt and Clay grading to olive gray medium to fine Sand, trace silt; wet			70 % Recovery
		Olive gray fine to medium SAND, trace coarse Sand, soft; wet			70 % Recovery
		Olive to dark gray fine to medium Sand, some Silt and Clay, little fine to coarse subrounded Gravel; wet			50 % Recovery
		Olive gray medium to coarse SAND, little fine to medium subrounded Gravel, inclusion of silty sand at 32.5 - 33 ft bls; wet	7 4 2 3 3		
		Gray fine to medium SAND, little fine Gravel; wet	12 10 10 9		
		Olive gray fine to medium SAND, some coarse Sand, trace of fine subrounded gravel; wet	16 15 6 6 0 3 6 7		
	Sump	Olive gray to red brown CLAY, trace silt			Bottom of well at 38 ft bls

BORINGWELL 17252Y03.GPJ ROUX.GDT 2/28/03

Mobil Buffalo Terminal



LOG
LF-3

Project Name: Mobil Terminal
Location: Upper Tank Farm (Disposal Area)
Well Number: LF-3
Casing Elevation: 596.17
Screen Diameter: 4 Inches
Casing Diameter: 4 Inches

Log By: D.D'Amico
Driller: SJB
Drilling Method: Hollow Stem Auger
Slot Size: 20
Type: PVC
Sample Method: 3 inch Split Spoon

Date: 03-Aug-99
and 04-Aug-99

Construction Details

Water Level (Init): NC
Borehole Diameter: 10 inches
Total Well Depth: 36 Feet
Screen Interval: 36-16 Feet
Sand Pack Type: Morrie #2

Cement/Grout Interval: 13.4 - grade
Backfill Interval: NA
Bentonite Interval: 15-13.4 Feet
Sand Pack Interval: 36-15 Feet
Completion Details: Pro casing installed.

= Cement/Grout
 = Backfill
 = Bentonite
 = Sand

(ft)	Sample Depth (ft)	PID (ppm)	Blow Count	Percent Recovery	Lithology: Burmister Classification System
0	0-5		Air Knifed.		Hand cleared.
1			↓		
2					
3					
4			↓		
5	5-7	NC	W.O.H. for 12",1,1	10	FILL: Reddish brown coarse Sand and Silt and fine to medium Gravel (cinders, cobbles) (5-7'), dry, no odor, staining or sheen.
6					
7					
8					
9					
10	10-12	NC	W.O.H. for 12",1,3	30	FILL: Reddish brown coarse Sand and Silt and fine to medium Gravel (cinders, cobbles), moist, no odor, staining or sheen.
11					
12					
13					
14					
15					
16					
17					
18	18-20	20.0	W.O.H. 1,2,1	75	Gray black fine SAND and SILT, some Clay, moist, saturated at 19.5', petroleum odor, slight staining, no sheen.
19					

Mobil Buffalo Terminal



LOG
LF-3

Project Name: Mobil Terminal
Location: Upper Tank Farm (Disposal Area)
Well Number: LF-3
Casing Elevation: 596.17
Screen Diameter: 4 Inches
Casing Diameter: 4 Inches

Log By: D.D'Amico
Driller: SJB
Drilling Method: Hollow Stem Auger
Slot Size: 20
Type: PVC
Sample Method: 3 inch Split Spoon

Date: 03-Aug-99
and 04-Aug-99

Construction Details

Water Level (Init): NC
Borehole Diameter: 10 inches
Total Well Depth: 36 Feet
Screen Interval: 36-16 Feet
Sand Pack Type: Morrie #2

Cement/Grout Interval: 13.4 - grade
Backfill Interval: NA
Bentonite Interval: 15-13.4 Feet
Sand Pack Interval: 36-15 Feet
Completion Details: Pro casing

= Cement/Grout
 = Backfill
 = Bentonite
 = Sand

(ft)	Sample Depth (ft)	PID (ppm)	Blow Count	Percent Recovery	Lithology: Burmister Classification System
20	20-22	42.0	1,1,1,2	50	Gray black medium SAND and SILT, trace Clay, saturated, petroleum odor, little staining.
21					
22	22-24	38	2,3,2,2	100	Gray black medium SAND and SILT, trace Clay, saturated, petroleum odor, little staining.
23					
24	24-26	64.0	1,1,1	50	Gray black medium SAND and SILT, trace Clay, saturated, petroleum odor, little staining, slight sheen.
25					
26	26-28	58.0	2,3,5,6	25	Black, medium SAND and SILT, saturated, petroleum odor, slight sheen.
27					
28	28-30	10.0	5,4,6,8	25	Black, coarse SAND and SILT and fine GRAVEL, saturated, petroleum odor, no sheen.
29					
30	30-32	4.2	4,3,3,3	25	Black coarse SAND and SILT and medium GRAVEL, some Clay, saturated, slight petroleum odor, no sheen.
31					
32	32-34	5.6	3,2,4,4	25	Black coarse SAND and SILT and medium GRAVEL, some Clay, saturated, slight petroleum odor, no sheen.
33					
34	34-36	0.8	2,3,6,9	50	Black coarse SAND and SILT and medium to coarse GRAVEL/COBBLES, some Clay, saturated, no petroleum odor, no sheen.
35					
36					
37					
38					
39					Bottom of boring @ 36 feet.

Mobil Buffalo Terminal



LOG
LF-6

Project Name: Mobil Terminal
 Location: Upper Tank Farm (Disposal Area)
 Well Number: LF-6
 Casing Elevation: 598.14
 Screen Diameter: 4 Inches
 Casing Diameter: 4 Inches

Log By: D. D'Amico
 Driller: SJB
 Drilling Method: Hollow Stem Auger
 Slot Size: 20
 Type: PVC
 Sample Method: 3 inch Split Spoon

Date: 13-Aug-99

Construction Details

Water Level (Init): NC
 Borehole Diameter: 10 inches
 Total Well Depth: 36 Feet
 Screen Interval: 36-16 Feet
 Sand Pack Type: Morrie #2

Cement/Grout Interval: 13-grade
 Backfill Interval: NA
 Bentonite Interval: 15-13 Feet
 Sand Pack Interval: 37-15 Feet
 Completion Details: Pro casing

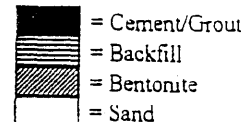

Sample (ft)	Sample Depth (ft)	PID (ppm)	Blow Count	Percent Recovery	Lithology: Burmister Classification System
0	0-3		Air Knifed.		Hand cleared. 5' Deep and 9" Diameter.
1			↓		
2					
3					
4					
5	5-7	ND	1,2,W.O.H. for 12"	10	FILL: Brown medium to coarse Sand and Silt. Cinders. Brick, trace medium Cobbles, dry, no odor or staining.
6					
7					
8					
9					
10	10-12	ND	4,4,5,3	25	FILL: Reddish brown medium to coarse Sand and Silt (10-12'). some medium Gravel, dry, no petroleum odor or staining.
11					
12					
13					
14					
15	15-17	0.2	1,1,4,3	20	Reddish brown medium to coarse SAND and SILT, some medium Gravel, dry, no petroleum odor or staining.
16					
17	17-19	0.2	3,3,3,4	25	Reddish brown medium to coarse SAND and SILT (17-18'). some medium Gravel, dry, no staining. Black fine Sand and Silt and Fill (18-19') (Wood, Brick, Cinders), moist, no petroleum odor.
18					
19					

Mobil Buffalo Terminal



LOG
LF-6

Project Name: Mobil Terminal
 Location: Upper Tank Farm (Disposal Area)
 Well Number: LF-6
 Casing Elevation: 598.14
 Screen Diameter: 4 Inches
 Casing Diameter: 4 Inches

Log By: D. D'Amico
 Driller: SJB
 Drilling Method: Hollow Stem Auger
 Slot Size: 20
 Type: PVC
 Sample Method: 3 inch Split Spoon

Date: 13-Aug-99

Construction Details

Water Level (Init): NC
 Borehole Diameter: 10 inches
 Total Well Depth: 36 Feet
 Screen Interval: 36-16 Feet
 Sand Pack Type: Morrie #2

Cement/Grout Interval: 13-grade
 Backfill Interval: NA
 Bentonite Interval: 15-13 Feet
 Sand Pack Interval: 37-15 Feet
 Completion Details: Pro casing

= Cement/Grout
 = Backfill
 = Bentonite
 = Sand

(ft)	Sample Depth (ft)	PID (ppm)	Blow Count	Percent Recovery	Lithology: Burmister Classification System
20	19-21	30.0	2,2,3,4	75	Gray black fine SAND and SILT, trace Clay. moist, slight petroleum odor, no sheen.
21	21-23	58	4,5,5,6	100	21-22' Gray black fine SAND and SILT. trace Clay. moist, slight petroleum odor, no sheen. 22-23' Gray fine to medium SAND. some Silt. moist, petroleum odor. slight sheen.
22					
23	23-25	92.0	5.4,4,5	20	Gray fine to medium Sand. some Silt. saturated, petroleum odor. slight sheen.
24					
25	25-27	88.0	W.O.H., 1, 3,3	75	Gray coarse SAND and SILT. saturated, petroleum odor. sheen.
26					
27	27-29	19.6	W.O.H. for 12". 1,1	50	Gray coarse SAND and SILT. saturated. slight petroleum odor. no sheen.
28					
29	29-31	6.0	2,2,3,3	25	Gray coarse SAND and SILT, some coarse to medium Gravel. saturated, slight petroleum odor. no sheen.
30					
31	31-33	5.8	1,3,5,7	50	Gray coarse SAND and SILT, some coarse to medium Gravel. saturated. slight petroleum odor. no sheen.
32					
33	33-35	ND	W.O.H. for 24"	50	Red gray fine to medium SAND, saturated.
34					
35	35-37	ND	1,1,3,5	50	Dark brown coarse SAND grading to dark brown fine Sand with coarse Gravel in shoe at 37 feet, no odor. saturated.
36					
37					CLAY at bottom of boring within bit.
38					
39					Bottom of boring @ 37 feet.

URS CO. INC.

TEST BORING DATA

Contractor: Empire Soil Investigation, Inc. Test Hole Number MW-3
 Client: Mobil Oil Corp. Local Name: Buffalo Terminal Disposal Site
 Location: Ground EL: 21.50 Ft
 Driller: Robert Kephart Date Started: 10/21/85 Initial Ground Water EL: 0.5 ft
 Helper: Dan Pawlowski Date Completed: 10/22/85 24 Hour Ground Water EL: -
 Inspector: Jeff Goldenberg Type of Core Drill: - Core Diameter: -
 Inside Dia. of Auger: 4" Weight of Hammer on Casing: - Drop of Hammer on Casing: -
 Inside Dia. of Spoon: 1-3/8" Weight of Hammer on Spoon: 140# Drop of Hammer on Spoon: 30"

Depth	Casing Blows	Sample No. Depth		Blows on Spoons						Rec.	Sample Identification and Profile Change	Well
				0-6	6-12	12-18	18-24	24-30	30-36			
5	H	S-1	0'	2'	6	7	3	3	12"	Black MF SAND and Silt, little mf Gravel (Cinders, Asphalt, petroleum smell)		
	O											
	L	S-2	2'	4'	4	4	5	5	22"	SAME (OILY SMELL)		
	L											
10	O	S-3	4'	6'	4	3	3	3	14"	Brown MF SAND, little Silt Brown black MF SAND, little Silt, some MF Gravel (Cinders, Glass)		
	W											
		S-4	6'	8'	2	2	3	4	7"	Red brown MF GRAVEL, some MF Sand, trace Silt (SLAG)		
	S											
15	T	S-5	8'	10'	2	2	3	2	9"	SAME, with trace Cinders		
	E											
	M	S-6	10'	12'	1	1	2	3	11"	SAME, with piece of carboard		
	A											
20	U											
	G											
	E	S-8	15'	17'	9	12	11	12	3"	Red brown MF SAND, some Silt, little fine Gravel (piece cinder)		
	R											
25		S-9	17'	19'	3	3	3	6	18"	Grey MF Sand, little Silt, little Gravel (Coal) Grey SILT		
		S-10	19'	21'	1	2	3	5	17"	SAME (Slight petroleum smell) BENTONITE		
30		S-11	21'	23'	5	5	6	5	21"	SAME Grey fine SAND, trace Silt (Slight petroleum smell)		
		S-12	25'	27'	WOH	1	5	4	24"	Grey fine SAND, little Silt (petroleum saturated)		
35												
		S-13	30'	32'	WOH	WOH	3	5	24"	SAME (petroleum saturated)		
40												
		S-14	34'	36'	14	7	8	5	24"	Grey MF SAND little Silt, little MF Gravel (petroleum saturated 34-35.5')		

Screen 32'11" to 21'11"
 Sand 36' to 19'9"
 Sealed 19'9" to 16'

Bottom of Hole @ 36.0'
 WOH = Weight of Hammer



ROUX ASSOCIATES, INC.
Environmental Consulting
& Management

1377 Motor Parkway
Islandia, New York 11749
Telephone: 631-232-2600
Fax: 631-232-9898

WELL CONSTRUCTION LOG

WELL NO. MW-28		NORTHING	EASTING		
PROJECT NO./NAME 17252Y03 / ExxonMobil Buffalo Terminal			LOCATION 625 Elk Street		
APPROVED BY N. Clarke		LOGGED BY		Buffalo, New York	
DRILLING CONTRACTOR/DRILLER ZEBRA /			GEOGRAPHIC AREA BSPA		
DRILL BIT DIAMETER/TYPE 2-in. /	BOREHOLE DIAMETER 10 1/4-inches	DRILLING EQUIPMENT/METHOD ICME 75 / HSA		SAMPLING METHOD 2" Split Spoon	START-FINISH DATE 10/4/00-10/4/00
CASING MAT./DIA. PVC / 2-inch	SCREEN: TYPE Slotted		MAT. PVC	TOTAL LENGTH 10.0	DIA. 2-inch SLOT SIZE 20-Slot
ELEVATION OF: (FT.)	GROUND SURFACE	TOP OF WELL CASING	TOP & BOTTOM SCREEN	GW SURFACE	GRAVEL PACK

Depth, feet	Stickup	Graphic Log	Visual Description	Blow Counts per 6"	PID Values (ppm)	REMARKS
	Stickup					
	CEMENT		FILL - Light Brown to brown medium to coarse SAND, little fine to coarse Gravel, Roots and Organic Material; Dry		0.0	75% recovery
	Cement seal around PVC riser		FILL - Light Brown to brown medium to coarse SAND, little fine to coarse Gravel, Roots and Organic Material		1.1	75% recovery
5			FILL - Brown medium to coarse SAND with Ash-like material throughout, Glass and Concrete noted		0.0	50% recovery
			FILL - Brown medium to coarse SAND with Ash-like material throughout, Glass and Concrete noted		0.0	50% recovery
10			FILL - Orange and gray Ash and Slag		0.0	60% recovery
			FILL - Orange, gray and black Ash and Slag, some Gravel		0.0	60% recovery
15			FILL - Orange, gray and black Ash and Slag		0.0	50% recovery
			FILL - Orange, gray and black Ash and Slag		0.0	50% recovery
20			FILL - Light Brown to brown fine to medium loose SAND, layers of gray and black Ash and Slag throughout		0.0	100% recovery
			FILL - Light Brown fine to medium dense SAND with layers of yellow-orange medium Sand, some Gravel and Ash		0.0	Odor, 100% recovery
			FILL - Brown to light brown fine to medium loose SAND, Brick, Glass, Slag and Ash		0.0	100% recovery, 25% of material is slough
25		x x x	Gray fine SAND, some Silt, little Clay; Moist		15	Black staining, petroleum odor, 100% recovery from 22-23 feet bls. From 23-26 feet bls. recovered material appears to be all slough
		x x x x x x x x x x x	Olive-gray/gray medium to fine SAND, little Silt, trace Clay; Wet		180	Recovered residual soil at 26 feet bls., odor. Product noted from 26-27 feet bls. Soil sample collected from 26-28 ft bls.
			Olive-gray/gray medium to fine SAND, little Silt, trace Clay		165	Odor
30						Bottom of boring at 32 feet bls.

BORING/WELL 17252Y03.GPJ ROUX.GDT 6/19/01



ROUX ASSOCIATES, INC.
 Environmental Consulting
 & Management

209 Shafter Street
 Islanda, NY 11749
 Telephone:
 Fax:

WELL CONSTRUCTION LOG

WELL NO. CO-1	NORTHING Not Measured	EASTING Not Measured
PROJECT NO./NAME 17252Y05 / ExxonMobil Buffalo Terminal		LOCATION 625 Elk Street
APPROVED BY	LOGGED BY M. Falzone	Buffalo, New York
DRILLING CONTRACTOR/DRILLER SJB / GES		GEOGRAPHIC AREA ETYA
DRILL BIT DIAMETER/TYPE 6.25-in. / Auger	BORE-HOLE DIAMETER 9-inches	DRILLING EQUIPMENT/METHOD / HSA
CASING MAT./DIA. Stainless Steel / 0.5-inch	SCREEN: TYPE Slotted	MAT. Stainless Steel TOTAL LENGTH 2.0 DIA. 0.5-inch SLOT SIZE 20-Slot
ELEVATION OF: (FT.)	GROUND SURFACE	TOP OF WELL CASING
		TOP & BOTTOM SCREEN
		GW SURFACE
		GRAVEL PACK Morie #1

Depth, feet	Graphic Log	Visual Description	Blow Counts per 6"	PID Values (ppm)	REMARKS
0	Flushmount	Utility Clearance			
5		No Samples Collected			
10	Cement Grout				
15	0.5 in Stainless Steel Casing				
20	Bentonite Seal	Olive gray to gray fine SAND, little Silt; Moist			Petroleum odor; black staining; 10 % Recovery
22	Morie #1 Gravel Pack	Olive gray to gray fine SAND, little medium Sand, little Silt; Wet			Petroleum odor; product present; 15 % Recovery
24	Peroxide Point - 0.5 in Stainless Steel Screen	Olive gray fine to medium SAND, little Silt; Wet			Petroleum odor; product present
26	Bentonite Seal	Olive gray fine to medium SAND, little Silt, trace Clay; Wet			Petroleum odor; product present
28	Morie #1 Gravel Pack	Olive gray to gray fine to coarse SAND, trace Silt; Wet			Petroleum odor; sheen present
30	Ozone Point - 0.5 in Stainless Steel Screen	Bottom of boring at 30 ft bis			

BORINGWELL 17252Y03.GPJ ROUX.GDT 11/20/03



ROUX ASSOCIATES, INC.
Professional Consulting & Management

209 Shafter Street
 Islandia, NY 11749
 Telephone:
 Fax:

WELL CONSTRUCTION LOG

WELL NO. CO-2	NORTHING Not Measured	EASTING Not Measured
PROJECT NO./NAME 17252Y05 / ExxonMobil Buffalo Terminal		LOCATION 625 Elk Street
APPROVED BY	LOGGED BY M. Falzone	Buffalo, New York
DRILLING CONTRACTOR/DRILLER SJB / GES		GEOGRAPHIC AREA ETYA
DRILL BIT DIAMETER/TYPE 6.25-in. / Auger	BOREHOLE DIAMETER 9-inches	DRILLING EQUIPMENT/METHOD / HSA
CASING MAT./DIA. Stainless Steel / 0.5-inch	SCREEN: TYPE Slotted	SAMPLING METHOD 2" Split Spoon
MAT. Stainless Steel TOTAL LENGTH 2.0		DIA. 0.5-inch SLOT SIZE 20-Slot
ELEVATION OF: (FT.)	GROUND SURFACE	TOP OF WELL CASING
		TOP & BOTTOM SCREEN
		GW SURFACE
		GRAVEL PACK Morie #1

Depth, feet	Graphic Log	Visual Description	Blow Counts per 6"	PID Values (ppm)	REMARKS
0	Flushmount	Utility Clearance			
5		No Samples Collected			
10	Cement Grout				
15	0.5 in Stainless Steel Casing				
20	Bentonite Seal				
25	Morie # 1 Gravel Pack	Olive gray fine SAND, little Silt and Clay, trace medium Sand; Moist to Wet			Petroleum odor, 70 % Recovery
25	Peroxide Point - 0.5 in Stainless Steel Screen	Olive gray fine to medium SAND, little Silt, trace Clay, Wet			Petroleum odor and product present
25	Bentonite Seal	Olive gray fine to medium SAND, little Silt, trace Clay, Wet			Petroleum odor
30	Morie # 1 Gravel Pack	Olive gray fine to medium SAND, little Silt, grading to fine to coarse Sand, trace medium Gravel; Wet			Bottom of boring at 30 ft bis
30	Ozone Point - 0.5 in Stainless Steel Screen				

BORINGWELL_17252Y03.GPJ ROUX.GDT 11/20/03



ROUX ASSOCIATES, INC.
 Professional Consulting
 & Management

209 Shafter Street
 Islandia, NY 11749
 Telephone:
 Fax:

WELL CONSTRUCTION LOG

WELL NO. CO-3		NORTHING Not Measured		EASTING Not Measured	
PROJECT NO./NAME 17252Y05 / ExxonMobil Buffalo Terminal				LOCATION 625 Elk Street	
APPROVED BY		LOGGED BY M. Falzone		Buffalo, New York	
DRILLING CONTRACTOR/DRILLER SJB / GES				GEOGRAPHIC AREA ETYA	
DRILL BIT DIAMETER/TYPE 6.25-in. / Auger		BOREHOLE DIAMETER 9-inches		DRILLING EQUIPMENT/METHOD / HSA	SAMPLING METHOD 2" Split Spoon
CASING MAT./DIA. Stainless Steel / 0.5-inch		SCREEN: TYPE Slotted		MAT. Stainless Steel	TOTAL LENGTH 2.0
ELEVATION OF: (FT.)		GROUND SURFACE		TOP OF WELL CASING	TOP & BOTTOM SCREEN
				GW SURFACE	GRAVEL PACK Morie #1
					SLOT SIZE 20-Slot
					START-FINISH DATE 10/16/03-10/16/03

Depth, feet	Graphic Log	Visual Description	Blow Counts per 6"	PID Values (ppm)	REMARKS
0	Flushmount	Utility Clearance			
5		No Samples Collected			
10	Cement Grout				
15	0.5 in Stainless Steel Casing				
20	Bentonite Seal	Olive gray Silt and Clay, little fine Sand; Moist			Petroleum odor
25	Morie # 1 Gravel Pack	Olive gray fine to medium SAND, little Silt, trace Clay; Wet			Petroleum odor; product present
25	Peroxide Point - 0.5 in Stainless Steel Screen	Olive gray fine to medium SAND, trace Silt; Wet			Petroleum odor; product present
30	Bentonite Seal	Olive gray fine to medium SAND; grading to fine Sand, some Silt, little Clay; Wet			Petroleum odor
30	Morie # 1 Gravel Pack	Olive gray fine SAND, little Silt, trace Clay; grading to medium to coarse Sand, little subrounded to subangular Gravel; Wet			Petroleum odor
30	Ozone Point - 0.5 in Stainless Steel Screen	Olive gray medium to coarse SAND, some subrounded to rounded Gravel; Wet			Petroleum odor
32					Bottom of boring at 32 ft b/s

BORINGWELL 17252Y03.GPJ ROUX.GDT 11/20/03



ROUX ASSOCIATES, INC.
Environmental Consulting
& Management

209 Shafter Street
Islandia, NY 11749
Telephone:
Fax:

WELL CONSTRUCTION LOG

WELL NO. CO-4	NORTHING Not Measured	EASTING Not Measured		
PROJECT NO./NAME 17252Y05 / ExxonMobil Buffalo Terminal		LOCATION 625 Elk Street		
APPROVED BY	LOGGED BY M. Falzone	Buffalo, New York		
DRILLING CONTRACTOR/DRILLER SJB / GES		GEOGRAPHIC AREA ETYA		
DRILL BIT DIAMETER/TYPE 6.25-in. / Auger	BOREHOLE DIAMETER 9-inches	DRILLING EQUIPMENT/METHOD / HSA	SAMPLING METHOD 2" Split Spoon	START-FINISH DATE 10/17/03-10/17/03
CASING MAT. DIA. Stainless Steel / 0.5-inch	SCREEN: TYPE Slotted	MAT. Stainless Steel	TOTAL LENGTH 2.0	DIA. 0.5-inch SLOT SIZE 20-Slot
ELEVATION OF:	GROUND SURFACE	TOP OF WELL CASING	TOP & BOTTOM SCREEN	GW SURFACE
(FT.)			/	GRAVEL PACK Morie #1

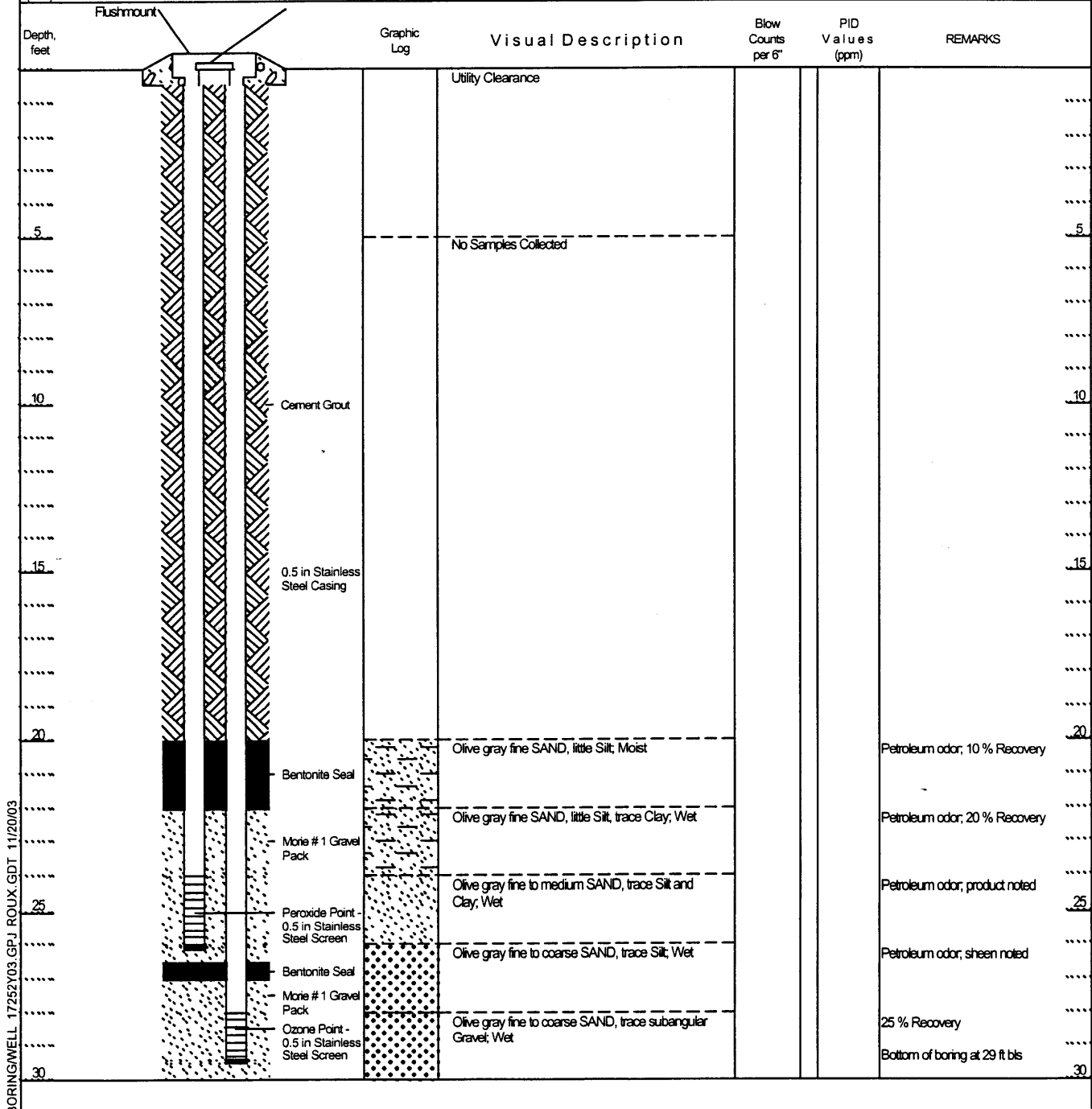

BORINGWELL 17252Y03.GPJ ROUX.GDT 11/20/03



ROUX ASSOCIATES, INC.
Environmental Consulting
& Management

209 Shaffer Street
Islandia, NY 11749
Telephone:
Fax:

WELL CONSTRUCTION LOG

WELL NO. CO-5	NORTHING Not Measured	EASTING Not Measured
PROJECT NO./NAME 17252Y05 / ExxonMobil Buffalo Terminal		LOCATION 625 Elk Street
APPROVED BY	LOGGED BY M. Falzone	Buffalo, New York
DRILLING CONTRACTOR/DRILLER SJB / GES		GEOGRAPHIC AREA ETYA
DRILL BIT DIAMETER/TYPE 6.25-in. / Auger	BORE-HOLE DIAMETER 9-inches	DRILLING EQUIPMENT/METHOD / HSA
CASING MAT./DIA. Stainless Steel / 0.5-inch	SCREEN: TYPE Slotted	SAMPLING METHOD 2" Split Spoon
ELEVATION OF: (FT.)		START-FINISH DATE 10/17/03-10/17/03
GROUND SURFACE		TOTAL LENGTH 2.0
TOP OF WELL CASING		DIA. 0.5-inch
TOP & BOTTOM SCREEN		SLOT SIZE 20-Slot
GW SURFACE		GRAVEL PACK Morie #1

Depth, feet	Graphic Log	Visual Description	Blow Counts per 6"	PID Values (ppm)	REMARKS
0	Flushmount	Utility Clearance			
5		No Samples Collected			
10	Cement Grout				
15	0.5 in Stainless Steel Casing				
20	Bentonite Seal				
25	Morie # 1 Gravel Pack	Olive gray fine to medium SAND, little Silt; Wet			Petroleum odor; product present; 20% Recovery
		Olive gray fine to medium SAND, trace Silt; Wet			Petroleum odor; sheen present
	Peroxide Point - 0.5 in Stainless Steel Screen	Olive gray fine to medium SAND, trace Silt, trace Clay; Wet			Petroleum odor; sheen present
	Bentonite Seal				
	Morie # 1 Gravel Pack	Olive gray fine to medium SAND, little Silt, trace Clay; grading to fine to coarse Sand, some subrounded to rounded Gravel; Wet			Petroleum odor; sheen present
30	Ozone Point - 0.5 in Stainless Steel Screen	Gray fine to coarse SAND; grading to fine Sand, some Silt, little Clay; Wet			
					Bottom of boring at 32 ft bls

BORING/WELL 17252Y05.GPJ ROUX.GDT 11/20/03



ROUX ASSOCIATES, INC.
Environmental Consulting
& Management

209 Shafter Street
Islandia, NY 11749
Telephone:
Fax:

WELL CONSTRUCTION LOG

WELL NO. VER-MW-1	NORTHING Not Measured	EASTING Not Measured
PROJECT NO./NAME 17252Y05 / ExxonMobil Buffalo Terminal		LOCATION 625 Elk Street
APPROVED BY	LOGGED BY M. Falzone	Buffalo, New York
DRILLING CONTRACTOR/DRILLER SJB / GES		GEOGRAPHIC AREA ETYA
DRILL BIT DIAMETER/TYPE 6.25-in. / Auger	BOREHOLE DIAMETER 9-inches	DRILLING EQUIPMENT/METHOD / HSA
CASING MAT./DIA. PVC / 2-inch	SCREEN: TYPE Slotted MAT. PVC	SAMPLING METHOD 2" Split Spoon
ELEVATION OF:		START-FINISH DATE 10/9/03-10/9/03
(FT.)	GROUND SURFACE	TOP OF WELL CASING
		TOP & BOTTOM SCREEN
		GW SURFACE
		GRAVEL PACK

Depth, feet	Stickup	Graphic Log	Visual Description	Blow Counts per 6"	PID Values (ppm)	REMARKS
5			Utility Clearance			
5			No Samples Collected			
10						
15			Fill - Medium to coarse SAND, trace Glass, trace Brick, trace Ash.			5 % Recovery
15			Fill - Medium to coarse SAND, trace Glass, trace Brick, trace Ash.			5 % Recovery
20			Olive grey SILT and CLAY, some fine Sand; Moist.			Petroleum odor; 60 % Recovery
20			Olive grey fine to medium SAND, trace Silt; Wet.			Product present; 90 % Recovery
25			Olive grey to grey fine to medium SAND; Wet.			Product present; Wood noted at 25 ft bls
25			Olive grey to grey fine to medium SAND, trace Silt and Clay; Wet.			Product present; 90 % Recovery
30			Olive grey fine to coarse SAND; Wet.			Petroleum odor; Sheen present; 70 % Recovery
30			Olive grey fine to coarse SAND; Wet.			Petroleum odor; Sheen present; 30 % Recovery
35			Grey to black fine to coarse SAND, little fine subrounded Gravel; Wet.			
35			Grey to black fine to coarse SAND, little fine subrounded Gravel; Wet.			Bottom of boring at 35 ft bls

BORING/WELL_17252Y03.GPJ ROUX.GDT 11/20/03



ROUX ASSOCIATES, INC.
Environmental Consulting
& Management

209 Shafter Street
Islandia, NY 11749
Telephone:
Fax:

WELL CONSTRUCTION LOG

WELL NO. VER-MW-2	NORTHING Not Measured	EASTING Not Measured
PROJECT NO./NAME 17252Y05 / ExxonMobil Buffalo Terminal		LOCATION 625 Elk Street
APPROVED BY	LOGGED BY M. Falzone	Buffalo, New York
DRILLING CONTRACTOR/DRILLER SJB / GES		GEOGRAPHIC AREA ETYA
DRILL BIT DIAMETER/TYPE 6.25-in. / Auger	BOREHOLE DIAMETER 9-inches	DRILLING EQUIPMENT/METHOD / HSA
CASING MAT./DIA. PVC / 2-inch	SCREEN: TYPE Slotted MAT. PVC	SAMPLING METHOD 2" Split Spoon
TOTAL LENGTH 24.0		START-FINISH DATE 10/8/03-10/9/03
ELEVATION OF: GROUND SURFACE TOP OF WELL CASING TOP & BOTTOM SCREEN		GW SURFACE GRAVEL PACK
(FT.)		

Depth, feet	Graphic Log	Visual Description	Blow Counts per 6"	PID Values (ppm)	REMARKS
0		Utility Clearance			
5		No Samples Collected			
10					
15		Fill - Grey to black ASH, little fine to coarse Sand, trace Brick.			
20		Olive grey SILT, some Clay, little fine Sand; Moist.		Petroleum odor.	
25		Olive grey fine to medium SAND, trace Silt, trace Clay; Wet.		Product present.	
30		Olive grey fine to medium SAND; Wet.		Product present.	
35		Olive grey fine to medium SAND; Wet.		Petroleum odor.	
35		Olive grey fine to medium SAND, some coarse Sand, little fine subrounded Gravel; Wet.	87.5	Petroleum odor.	
35		Olive grey fine to coarse SAND, little subrounded Gravel; Wet.		50 % Recovery	
35		Olive grey fine SAND, little medium Gravel; Wet.		Sheen present, 10 % Recovery	
35					Bottom of boring at 35 ft bls

BORINGWELL_17252Y05.GPJ ROUX.GDT 11/20/03



ROUX ASSOCIATES, INC.
 Environmental Consulting
 & Management

209 Shafter Street
 Islandia, NY 11749
 Telephone:
 Fax:

WELL CONSTRUCTION LOG

WELL NO. VER-MW-3	NORTHING Not Measured	EASTING Not Measured		
PROJECT NO./NAME 17252Y05 / ExxonMobil Buffalo Terminal		LOCATION 625 Elk Street		
APPROVED BY	LOGGED BY M. Falzone	Buffalo, New York		
DRILLING CONTRACTOR/DRILLER SJB / GES		GEOGRAPHIC AREA ETYA		
DRILL BIT DIAMETER/TYPE 6.25-in. / Auger	BORE-HOLE DIAMETER 9-inches	DRILLING EQUIPMENT/METHOD / HSA	SAMPLING METHOD 2" Split Spoon	START-FINISH DATE 10/8/03-10/8/03
CASING MAT./DIA. PVC / 2-inch	SCREEN: TYPE Slotted	MAT. PVC	TOTAL LENGTH 25.0	DIA. 2-inch SLOT SIZE 20-Slot
ELEVATION OF: (FT.)	GROUND SURFACE	TOP OF WELL CASING	TOP & BOTTOM SCREEN /	GW SURFACE GRAVEL PACK

Depth, feet	Graphic Log	Visual Description	Blow Counts per 6"	PID Values (ppm)	REMARKS
	Stickup CEMENT	Utility Clearance			
5		No Samples Collected			
10					
15		Fill - Black ASH, some medium to coarse Sand, trace Brick; Dry.			10 % Recovery
17		Fill - Black ASH, some grey Ash, little black coarse Sand; Dry.			10-20 % Recovery
20		Fill - Grey ASH, some black coarse SAND, little olive grey Silt and Clay.			20 % Recovery
22		Fill - Olive grey to grey SILT, some Clay, little fine Sand; Moist.			Petroleum odor; 80 % Recovery
23		Olive grey fine to medium SAND, trace Silt; Wet.			Product present from 22 ft to 23 ft bis.
25		Olive grey fine to medium SAND, little Silt, trace Clay; Wet.			Product present; Petroleum odor; 80 % Recovery
27		Olive grey fine to medium SAND, little coarse Sand; Wet.			Petroleum odor. Product present; 90 % Recovery
30		Olive Grey fine to coarse SAND, trace subrounded to rounded Gravel; Wet.			Petroleum odor.
32		Olive Grey fine to coarse SAND, trace subrounded to rounded Gravel; Wet.			Petroleum odor.
35		Olive Grey fine to coarse SAND, trace subrounded to rounded Gravel; Wet.			Petroleum odor.
35					Bottom of boring at 35 ft bis

BORINGWELL_17252Y03.GPJ ROUX.GDT 11/20/03



ROUX ASSOCIATES, INC.
 Environmental Consulting
 & Management

209 Shafter Street
 Islandia, NY 11749
 Telephone:
 Fax:

WELL CONSTRUCTION LOG

WELL NO. VER-MW-4	NORTHING Not Measured	EASTING Not Measured	
PROJECT NO./NAME 17252Y05 / ExxonMobil Buffalo Terminal		LOCATION 625 Elk Street	
APPROVED BY	LOGGED BY M. Falzone	Buffalo, New York	
DRILLING CONTRACTOR/DRILLER SJB / GES		GEOGRAPHIC AREA ETYA	
DRILL BIT DIAMETER/TYPE 6.25-in. / Auger	BOREHOLE DIAMETER 9-inches	DRILLING EQUIPMENT/METHOD / HSA	SAMPLING METHOD 2" Split Spoon
CASING MAT./DIA. PVC / 2-inch	SCREEN: TYPE Slotted MAT. PVC	TOTAL LENGTH 25.0	DIA. 2-inch SLOT SIZE 20-Slot
ELEVATION OF: (FT.)	GROUND SURFACE	TOP OF WELL CASING	TOP & BOTTOM SCREEN
			GW SURFACE
			GRAVEL PACK

Depth, feet	Stickup 	Graphic Log	Visual Description	Blow Counts per 6"	PID Values (ppm)	REMARKS
5			Utility Clearance			
5			No Recovery			
10			Fill - Fine to coarse SAND, some Ash, some Glass.			
10			Fill - Fine to coarse SAND, some Ash, some Glass.			
15			Fill - Fine to coarse SAND, some Ash, some Glass.			
15			Fill - Medium SAND, some Ash, some Glass.			
15			Fill - Medium SAND, some Ash, some Glass.			
20			No Recovery			Petroleum odor.
20			Olive grey SILT, some Clay, little Organic material; Moist.			60 % Recovery
25			Olive grey SILT, some Clay, little fine to medium Sand; Wet.			Product present; 60 % Recovery
25			Olive grey SILT, some Clay, little olive grey fine to medium Sand; Wet.			Product present; 60 % Recovery
25			Olive grey fine to medium SAND, trace Silt; Wet.			Petroleum odor; 70 % Recovery
30			Olive grey fine to medium SAND, little rounded - subrounded Gravel; Wet.			Petroleum odor; 60 % Recovery
30			Olive grey medium to coarse SAND, some fine to coarse subrounded Gravel; Wet.			
35			Olive grey medium to coarse SAND, some subrounded - rounded Gravel; Wet.			
35			Olive grey to grey medium to coarse SAND, some red to brown Clay.			Bottom of boring At 35 ft bis

BORINGWELL - 17252Y03.GPJ - ROUX.GDT - 11/20/03

APPENDIX D

VER Pilot Test Data and Graphs

Hydrographs of Monitoring Wells During VER Pilot Test

Hydrograph During VER Pilot Test, Monitoring Well MW-28

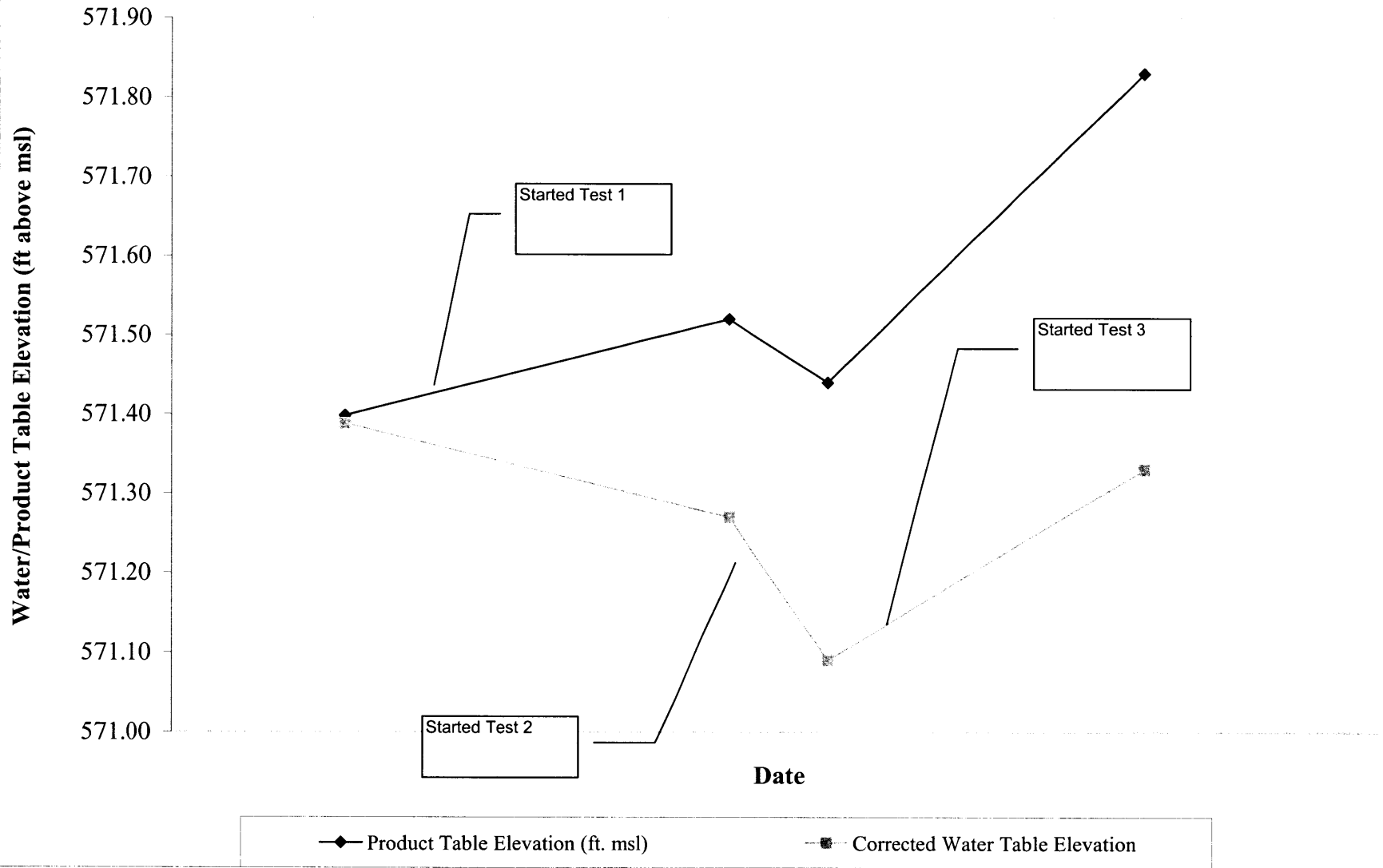

Hydrograph During VER Pilot Test, Monitoring Well VERMW-1

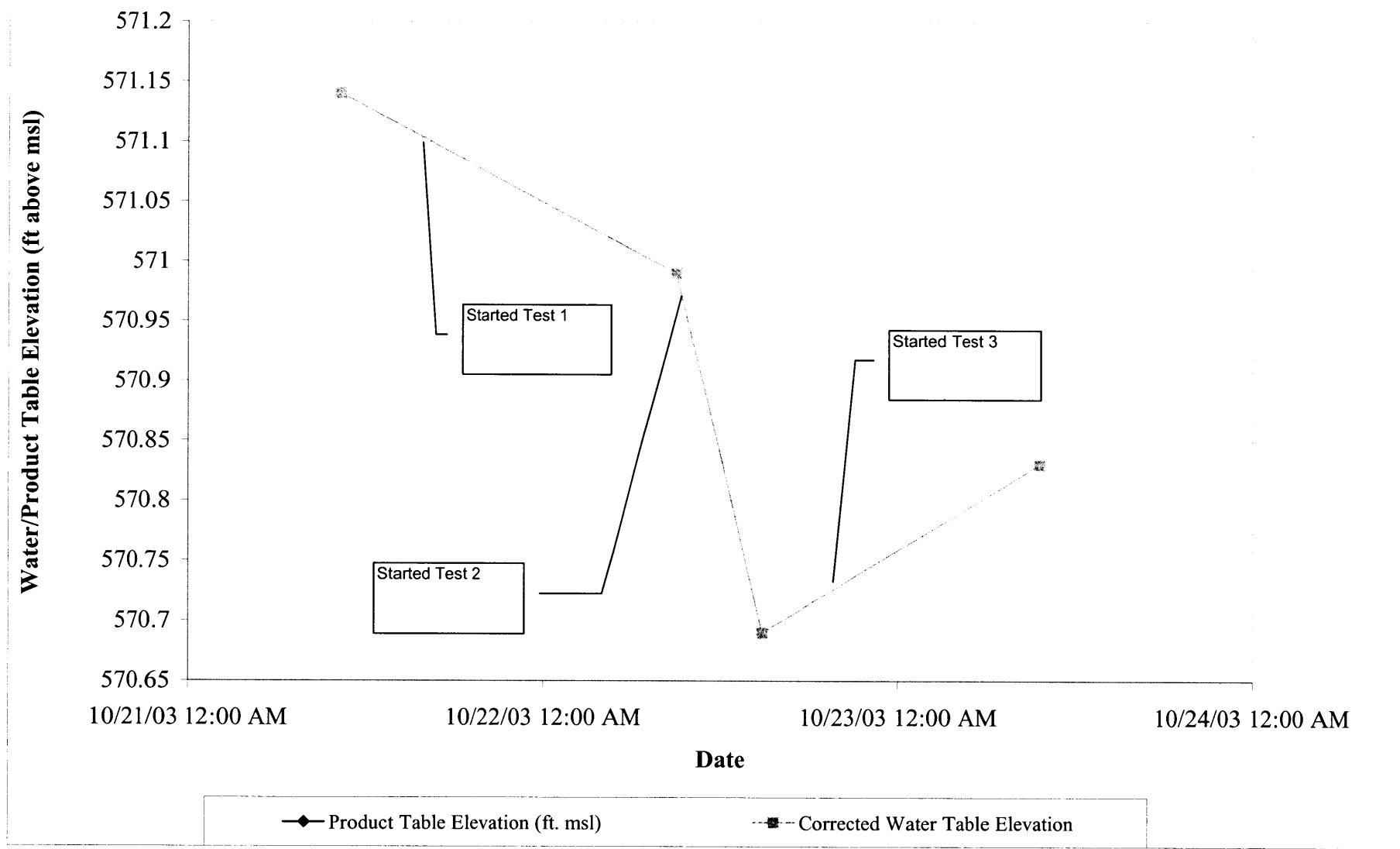

Hydrograph During VER Pilot Test, Monitoring Well VERMW-3

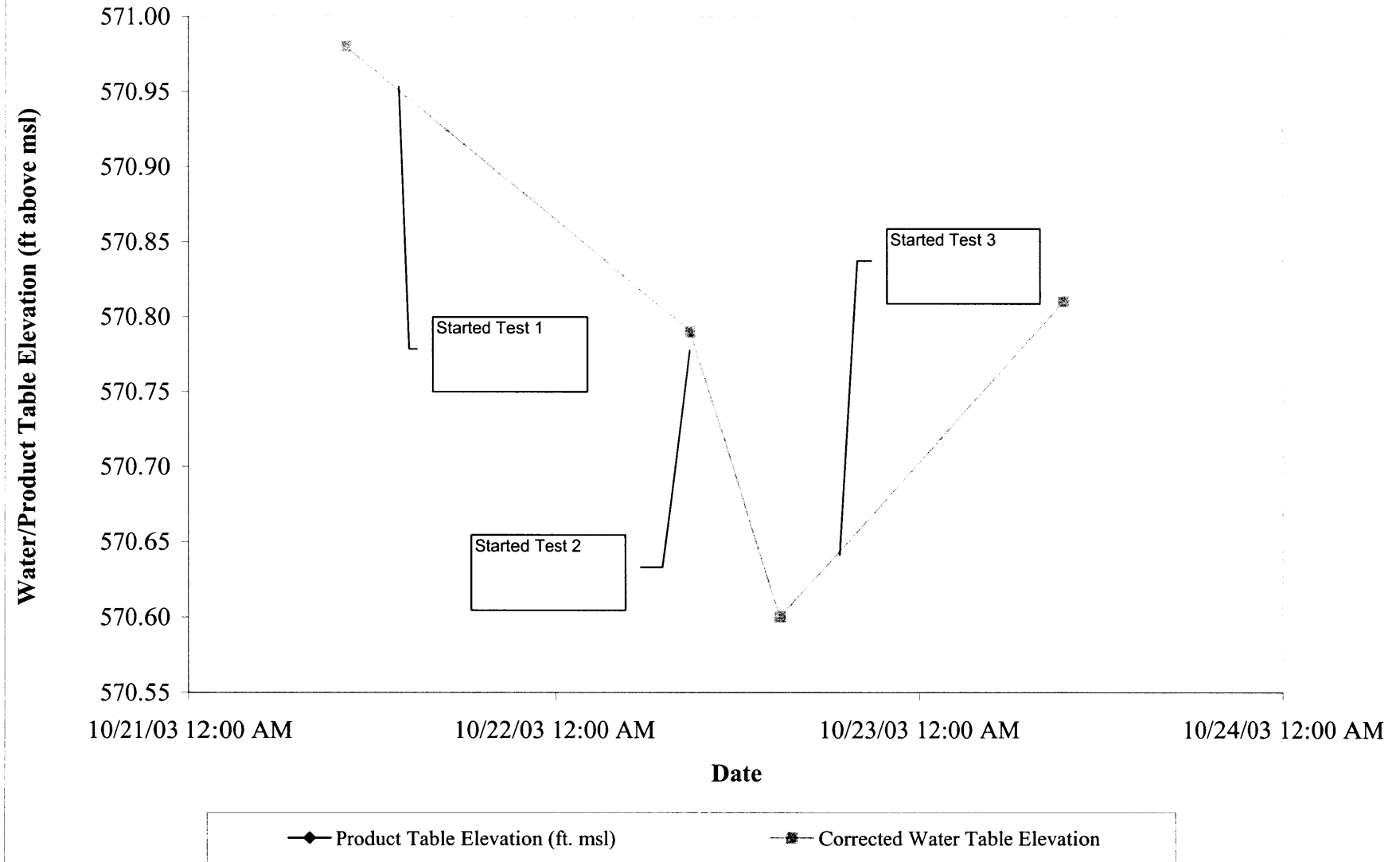

Hydrograph During VER Pilot Test, Monitoring Well VERMW-4

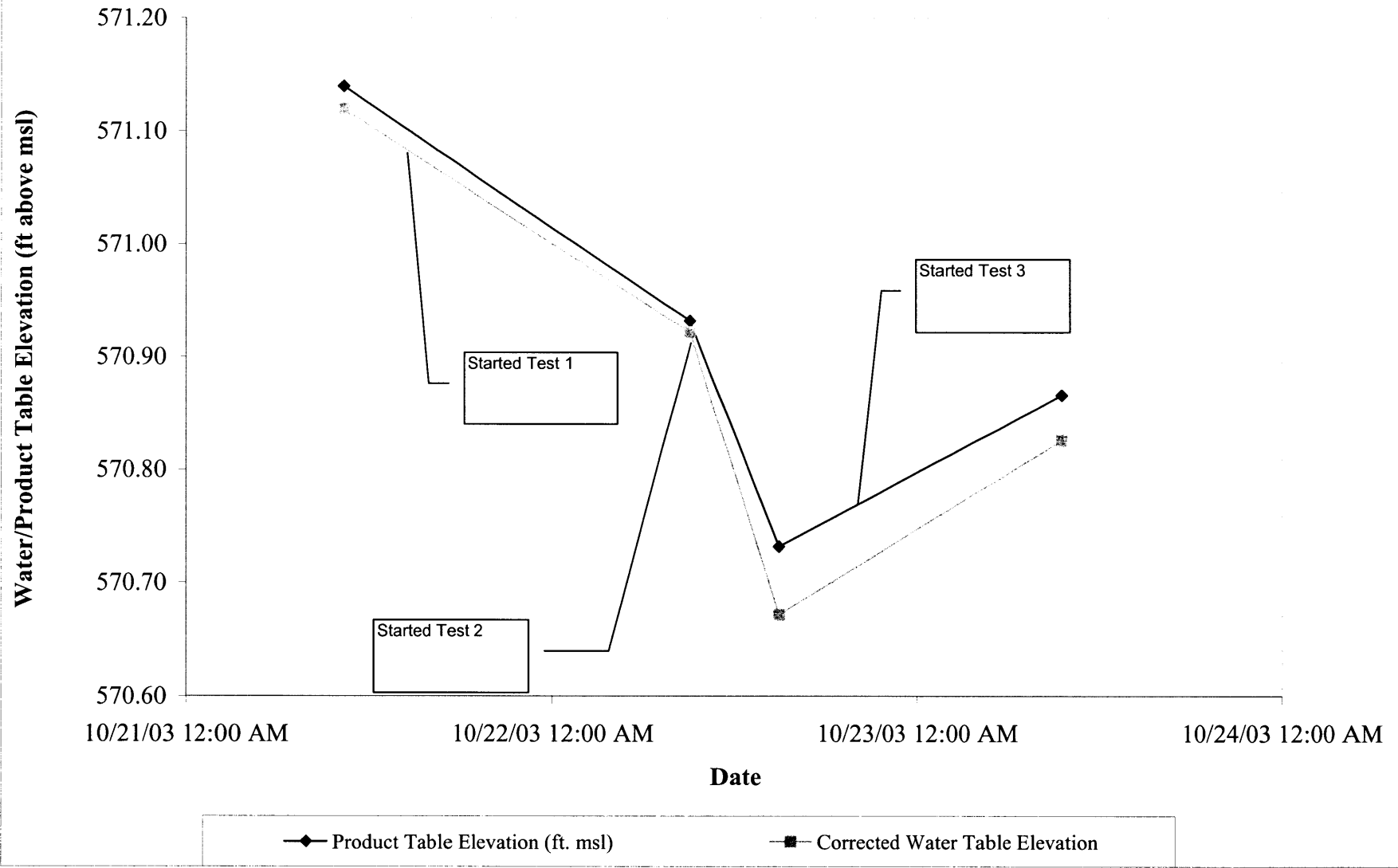

Hydrograph During VER Pilot Test, Monitoring Well RW-8R

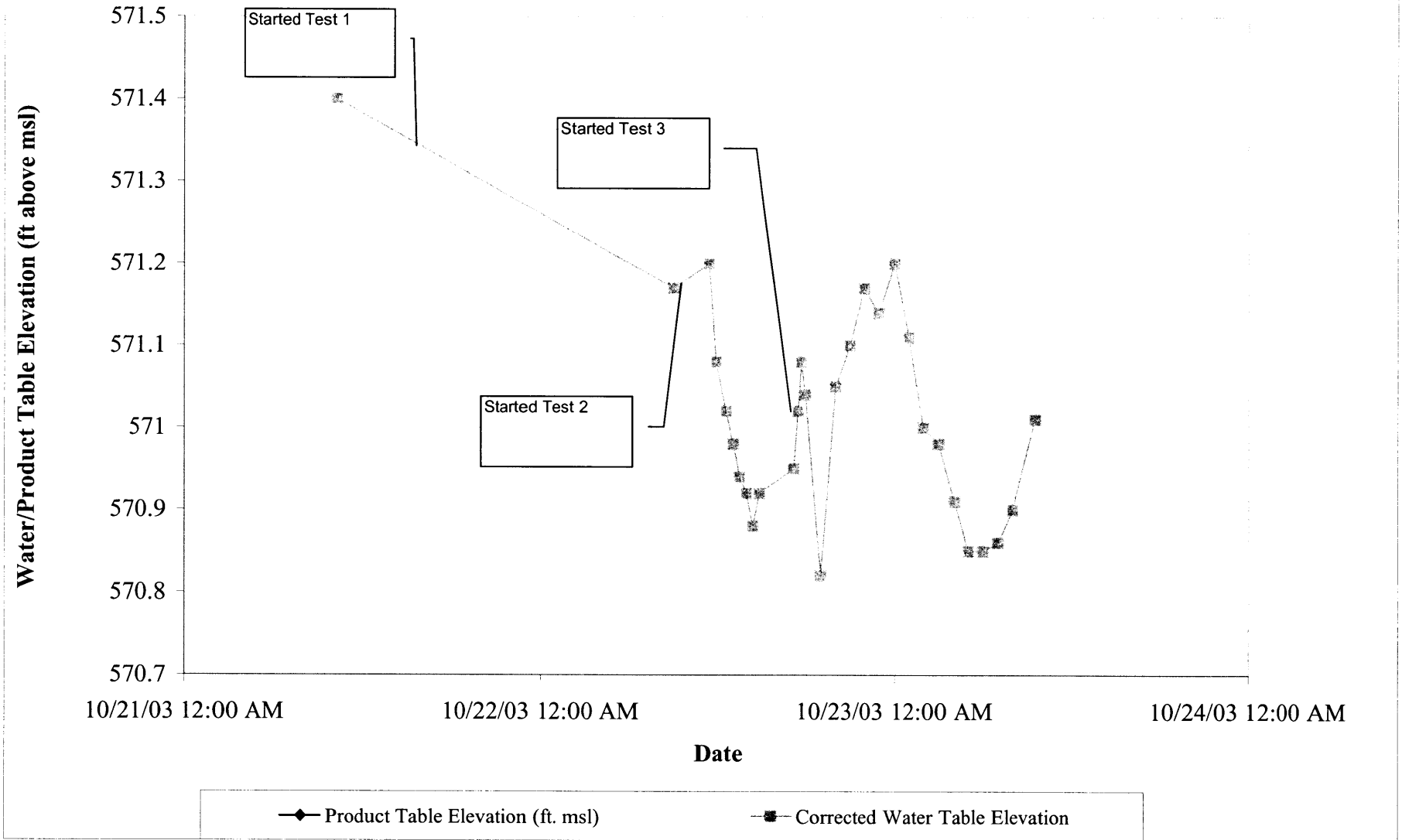

Hydrograph During VER Pilot Test, Monitoring Well LF-3

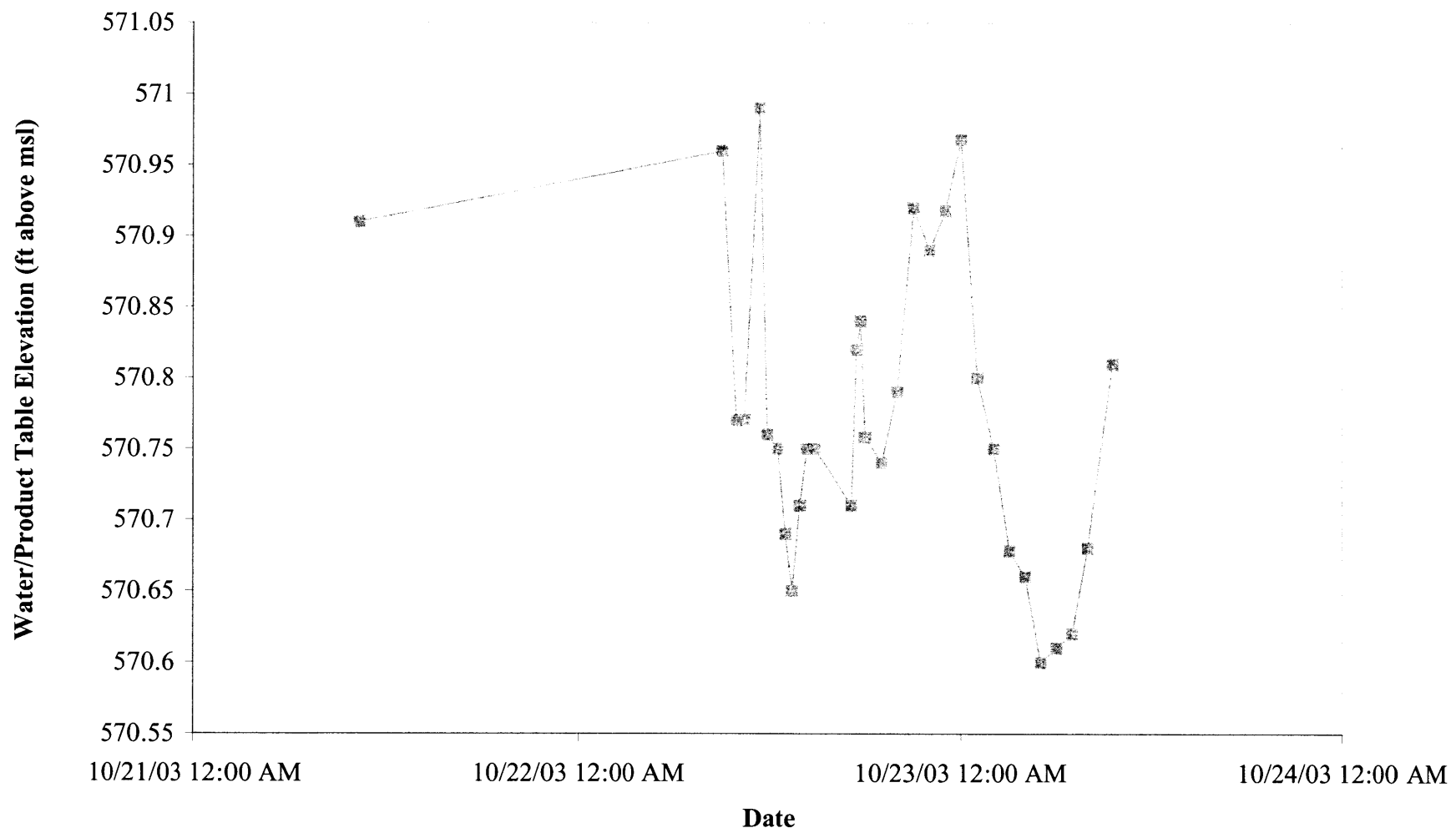

Product Table Elevation (ft. msl)
 Corrected Water Table Elevation

Hydrograph During VER Pilot Test, Monitoring Well LF-6

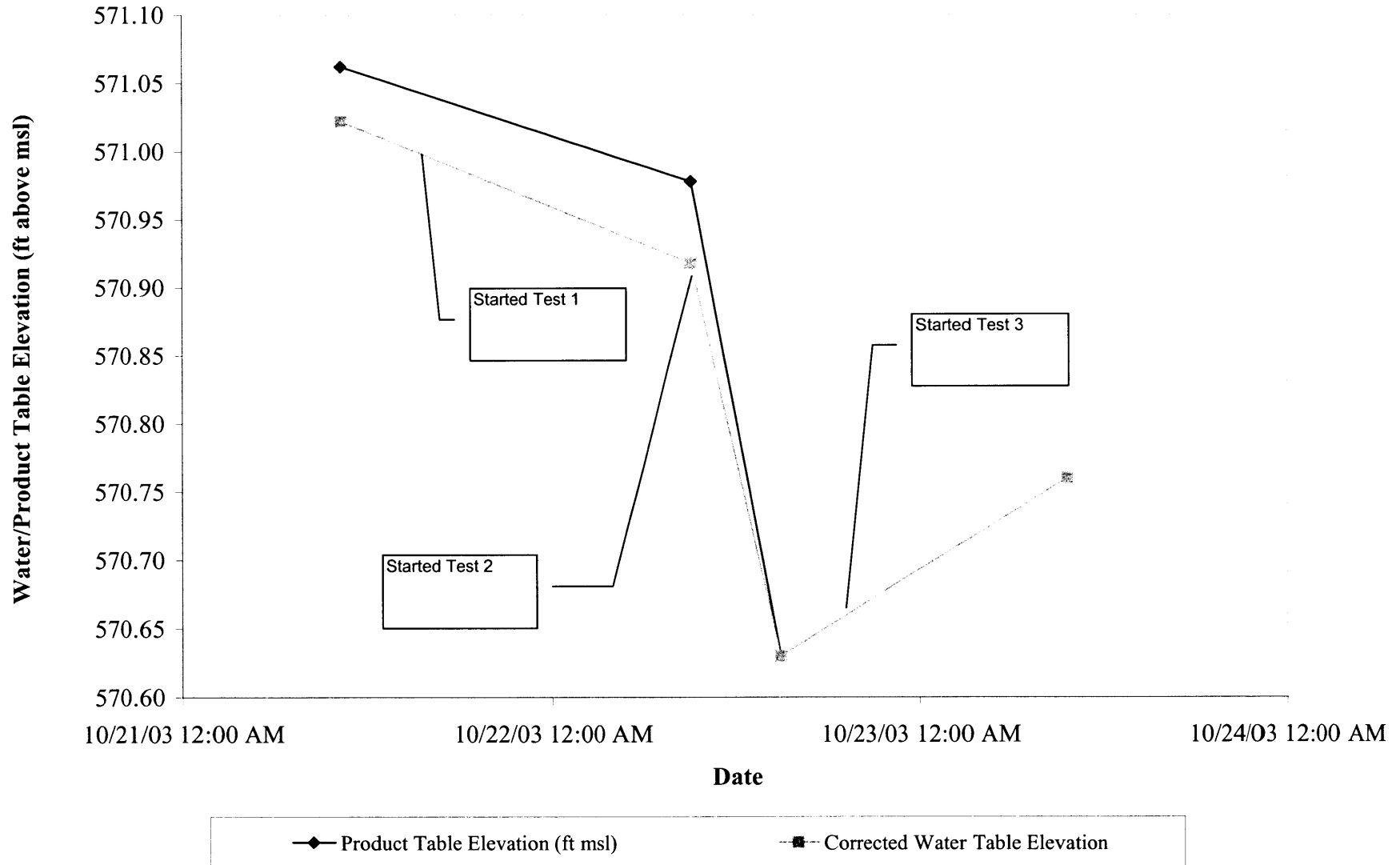

Hydrograph During VER Pilot Test, Monitoring Well LF-1S

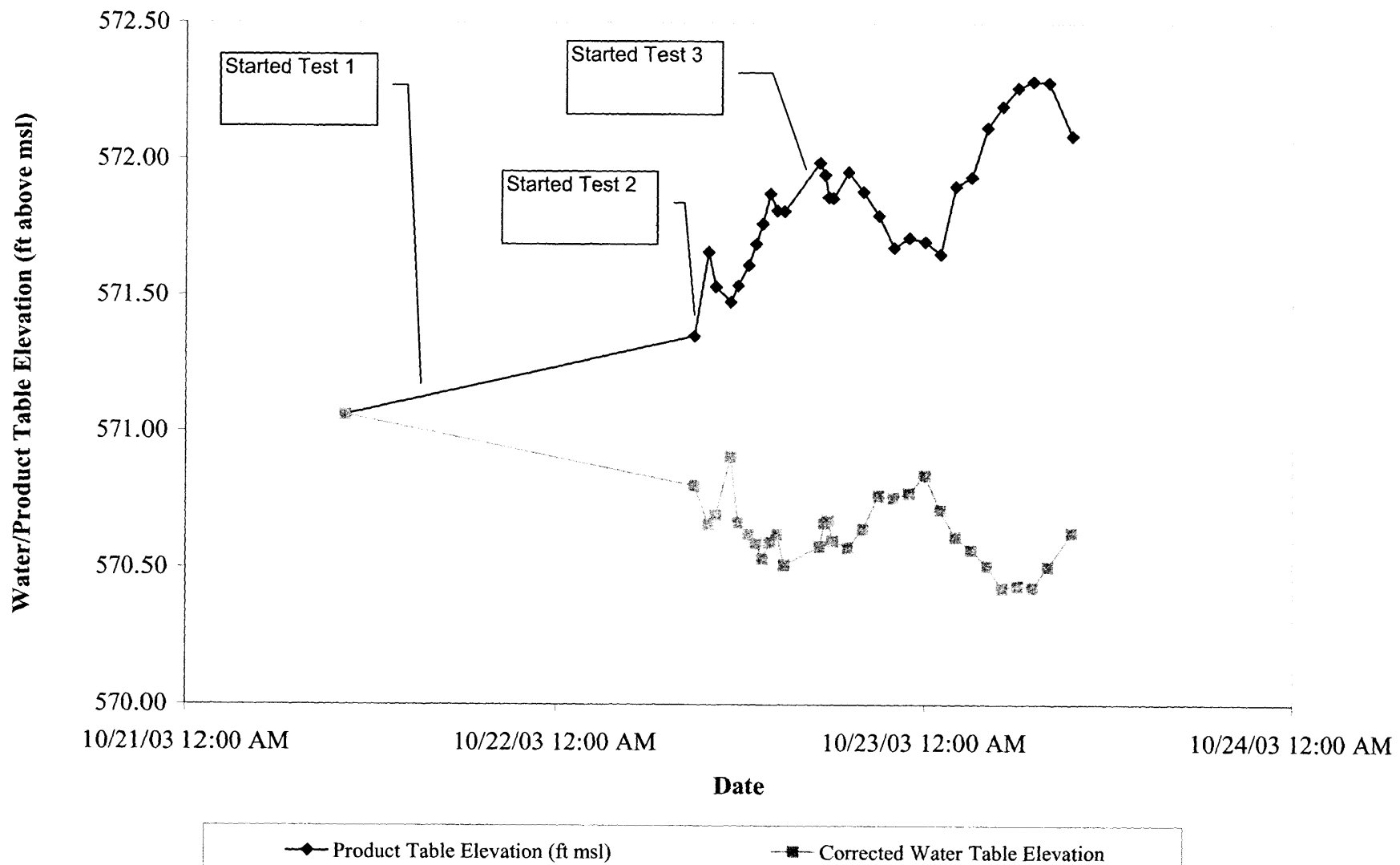

Hydrograph During VER Pilot Test, Monitoring Well VERMW-2

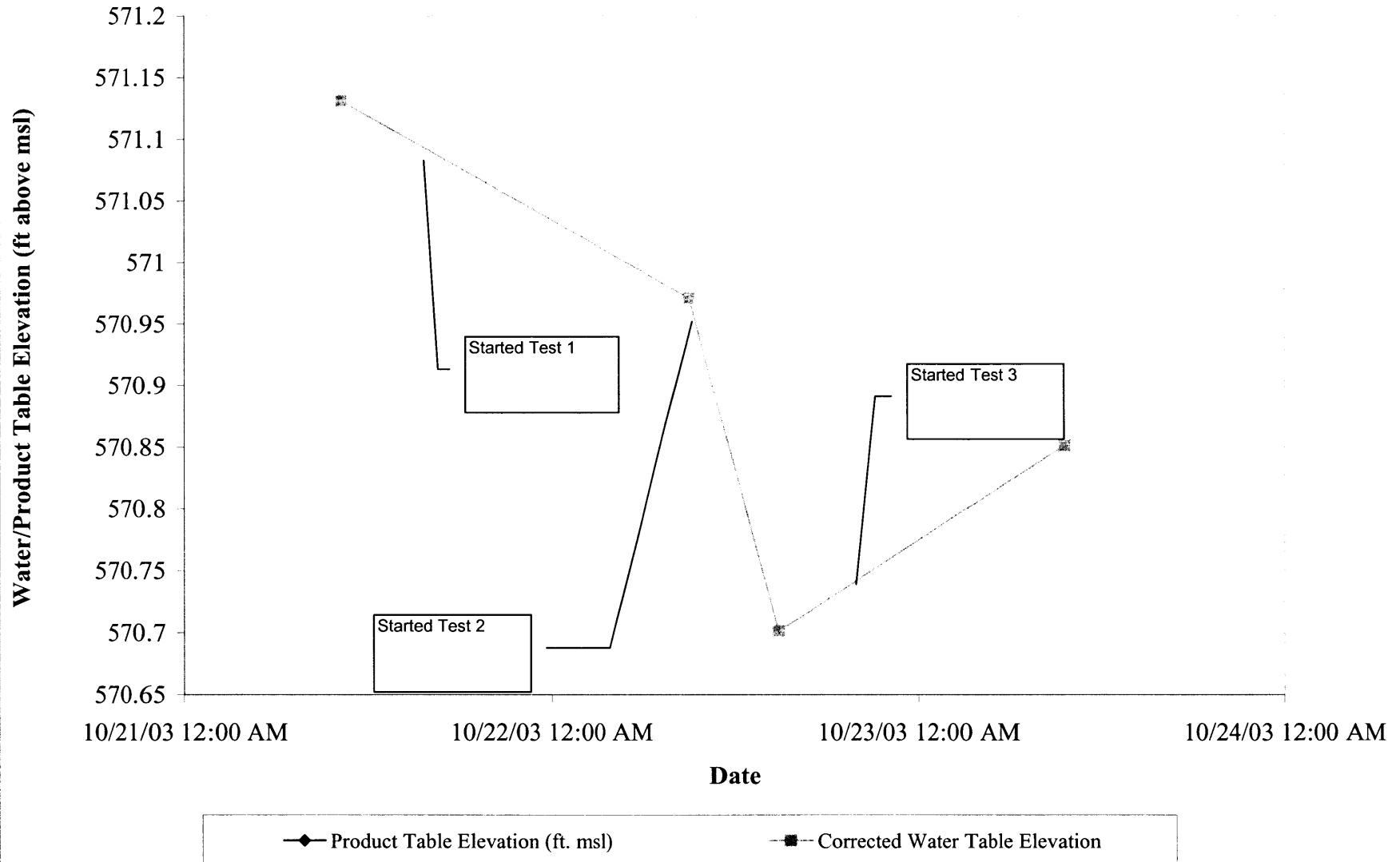

Graphs of Pressure and Water Table Response and DAPL Unit Data
Short-Term Test (Test 1), October 21, 2003

VER Pilot Test, Short-Term Test (Test 1), October 21, 2003
VERMW-3 : Vacuum Response

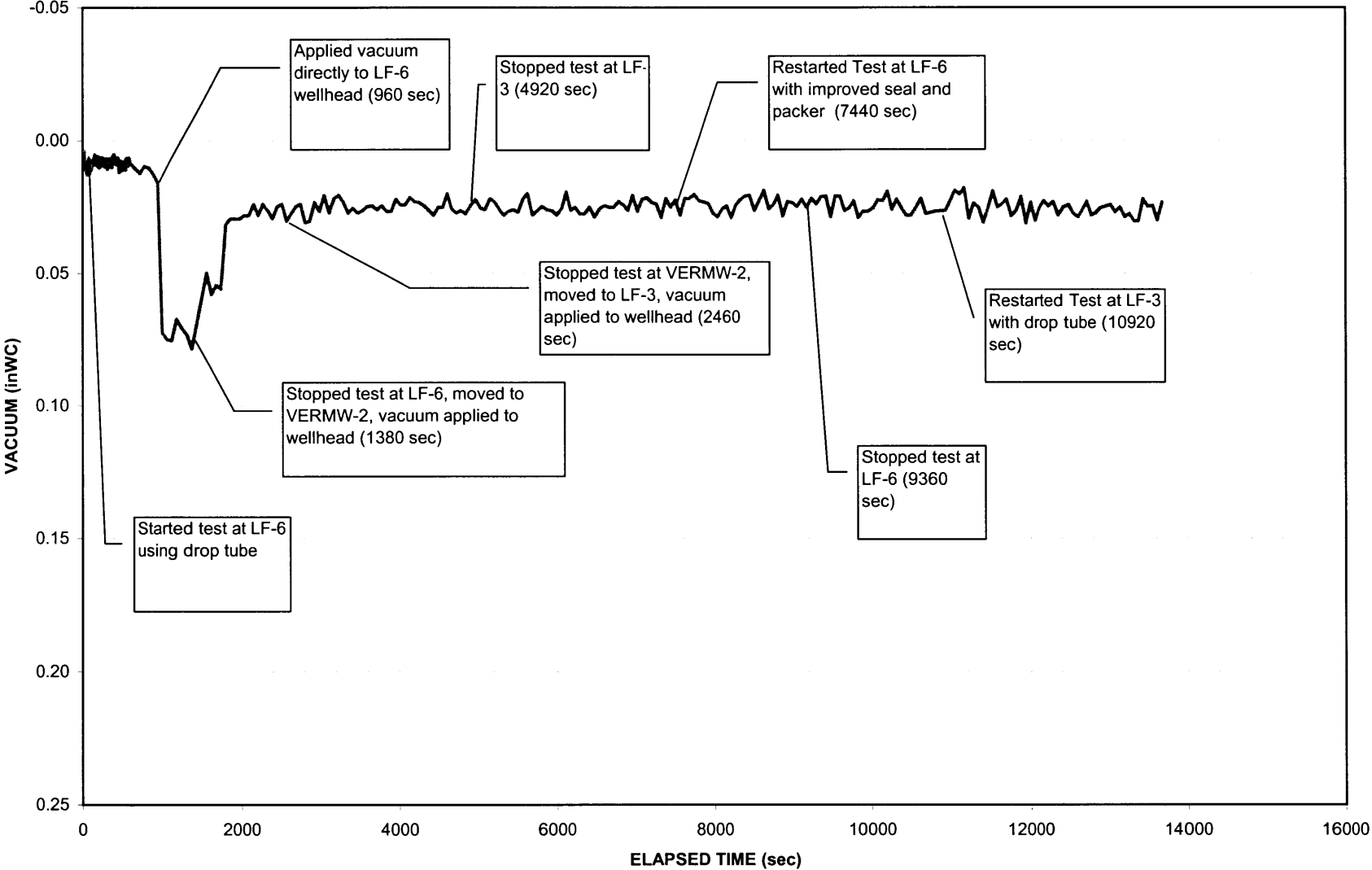

VER Pilot Test, Short-Term Test (Test 1), October 21, 2003
 VERMW-4 : Vacuum Response

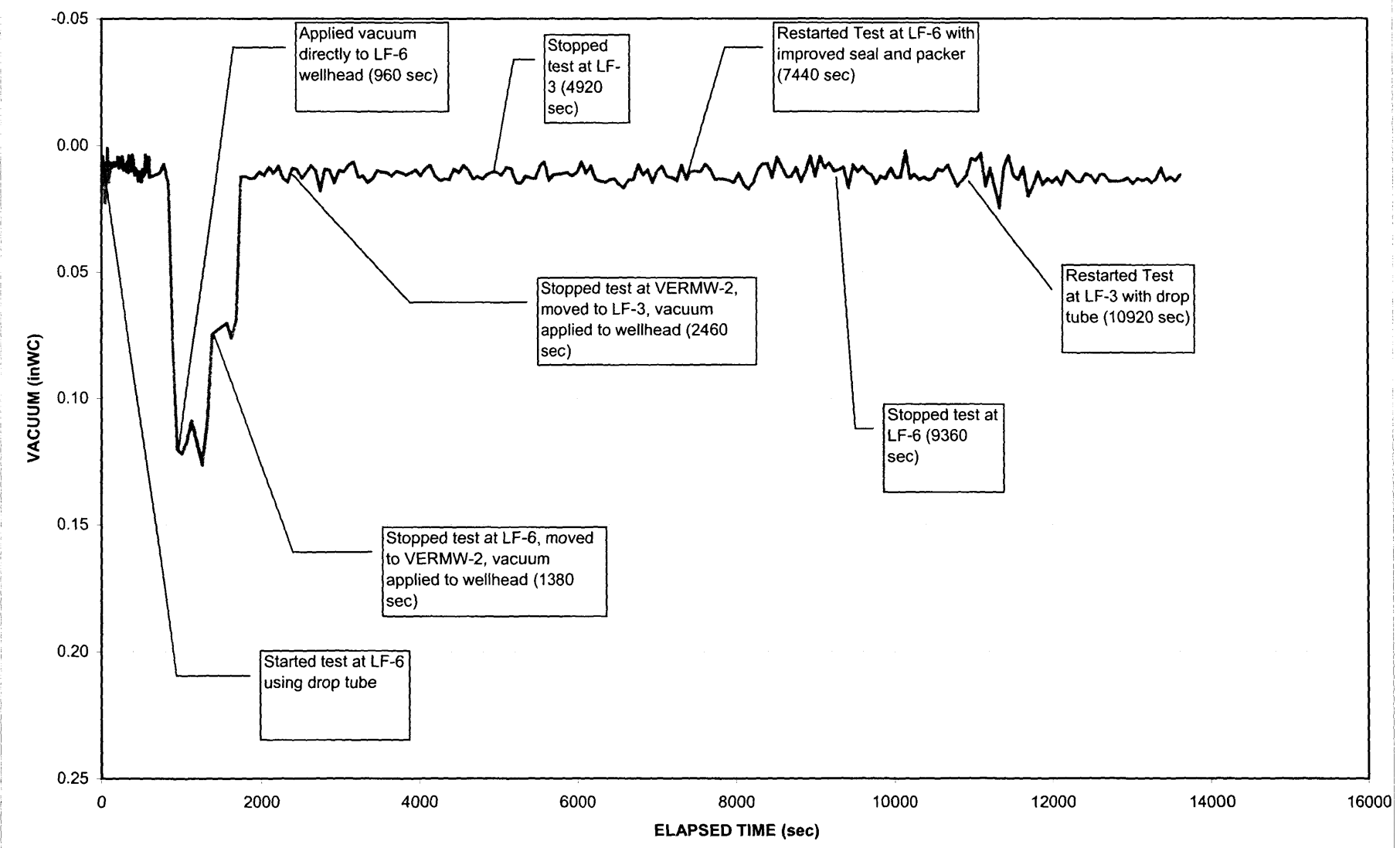

VER Pilot Test, Short-Term Test (Test 1), October 21, 2003
VERMW-2 : Vacuum Response

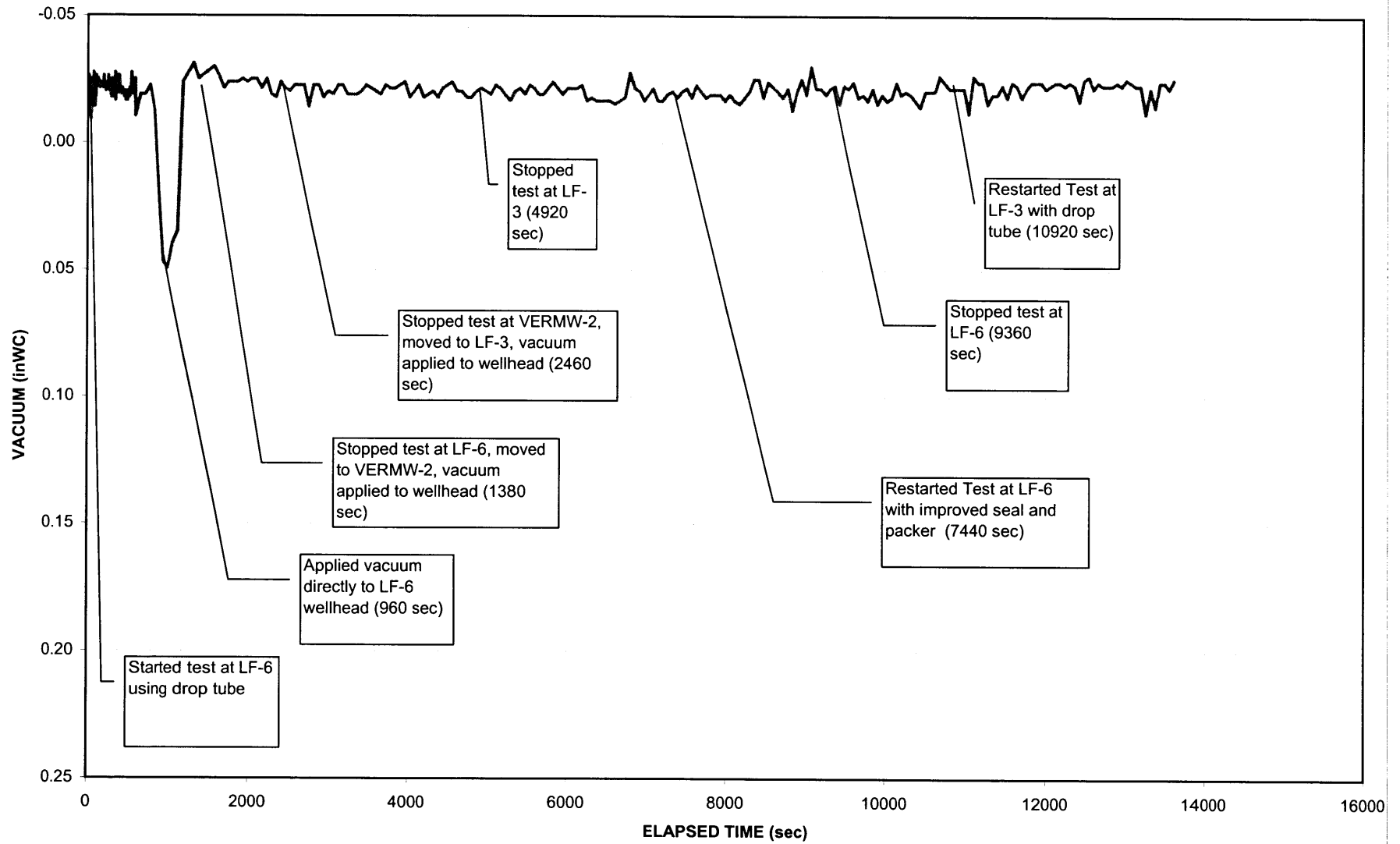

VER Pilot Test, Short-Term Test (Test 1), October 21, 2003
VERMW-1 : Vacuum Response

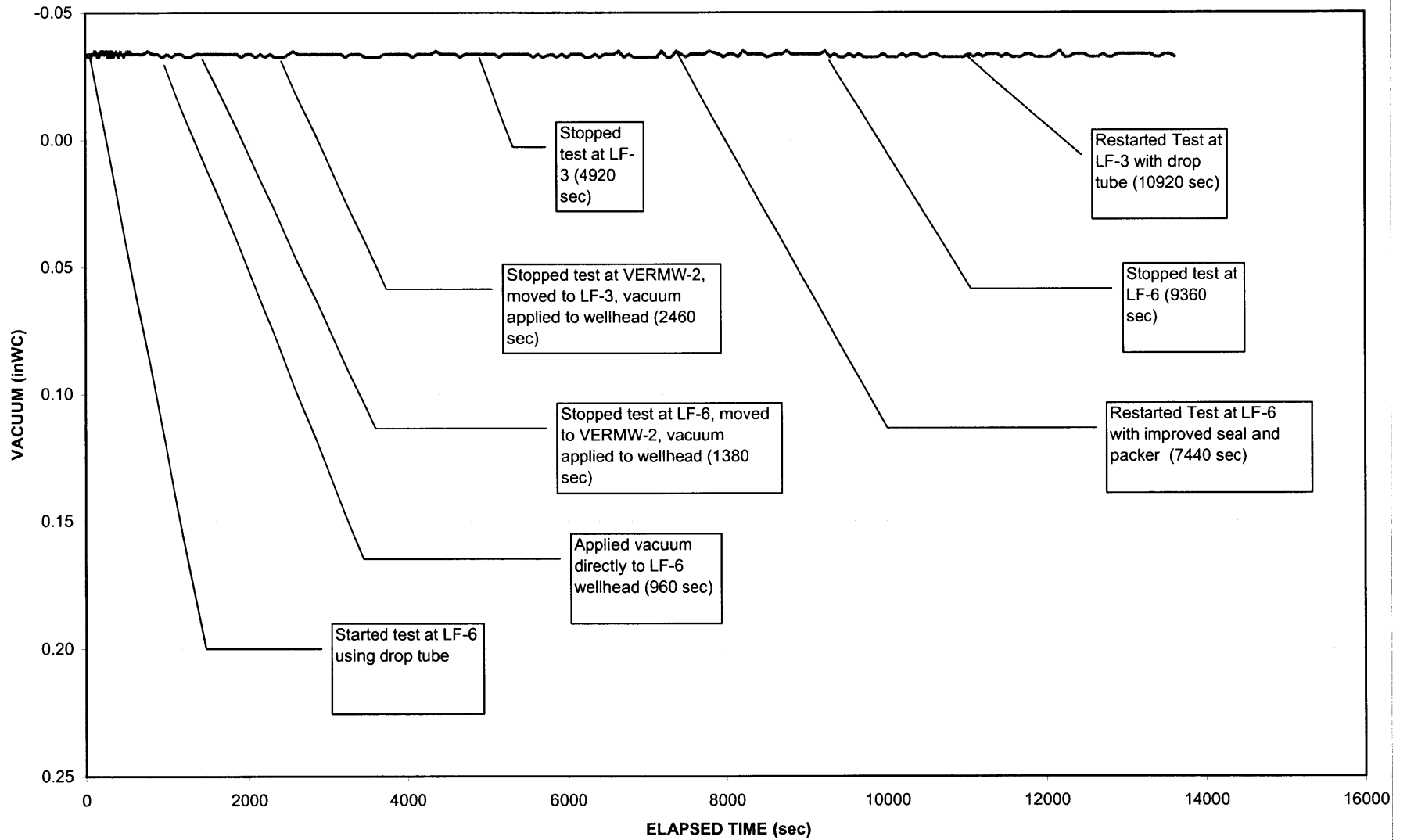

VER Pilot Test, Short-Term Test (Test 1), October 21, 2003
MW-28 : Vacuum Response

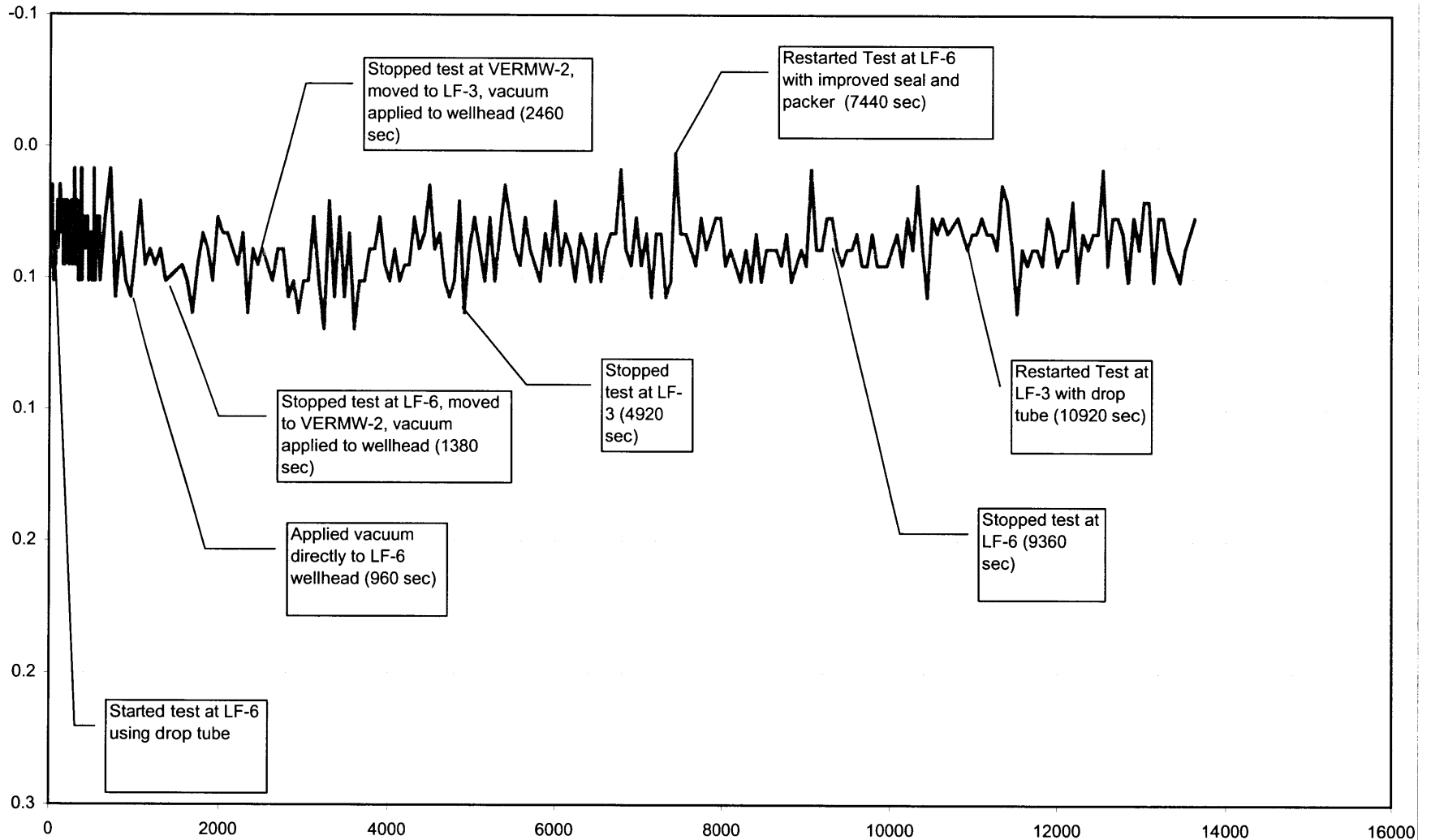

VER Pilot Test, Short-Term Test (Test 1), October 21, 2003
MW-3URS : Vacuum Response

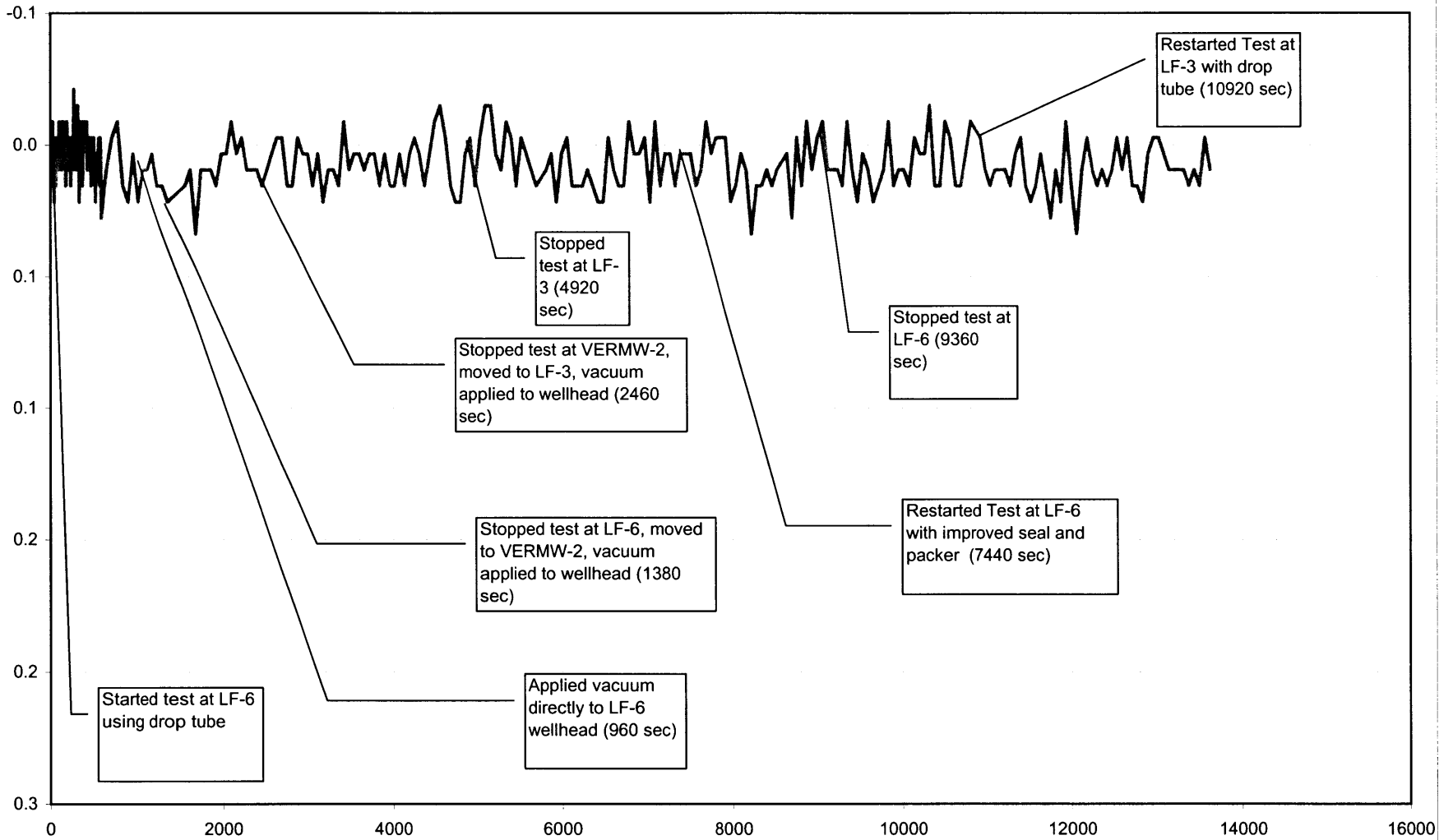

**VER Pilot Test, Short-Term Test (Test 1), October 21, 2003
VERMW-3 : Groundwater Response**

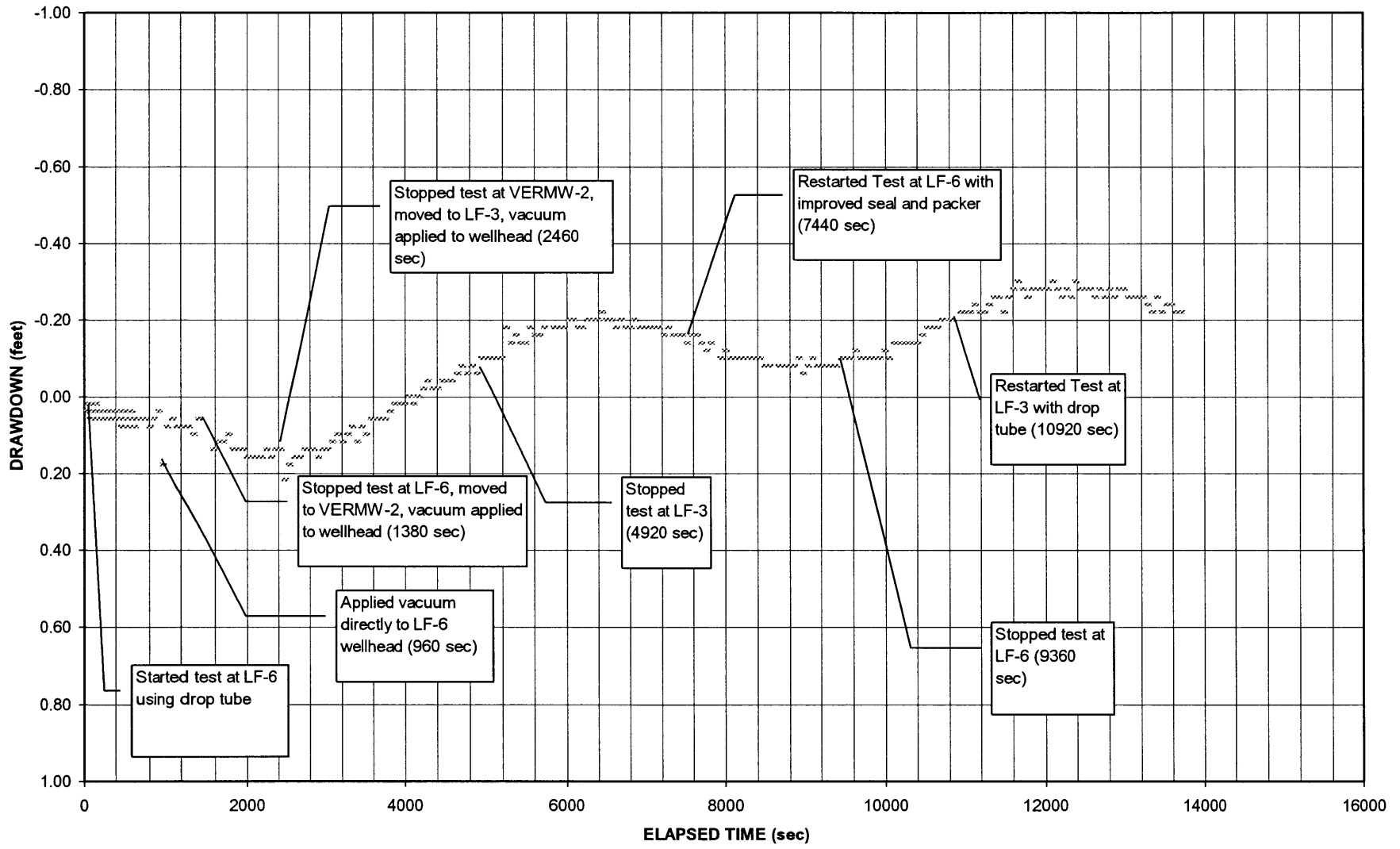

VER Pilot Test, Short-Term Test (Test 1), October 21, 2003
VERMW-4 : Groundwater Response

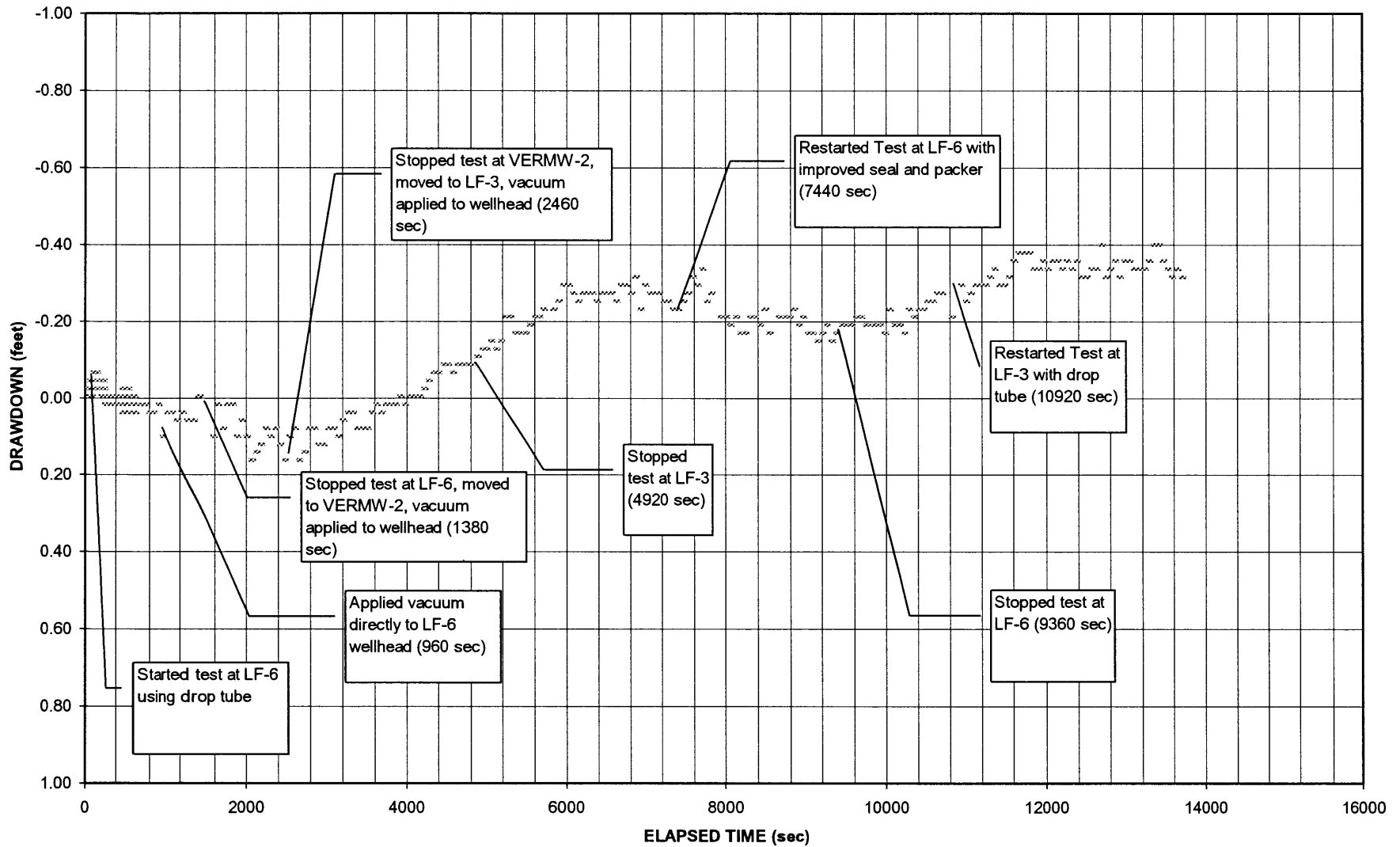

VER Pilot Test, Short-Term Test (Test 1), October 21, 2003
VERMW-2 : Groundwater Response

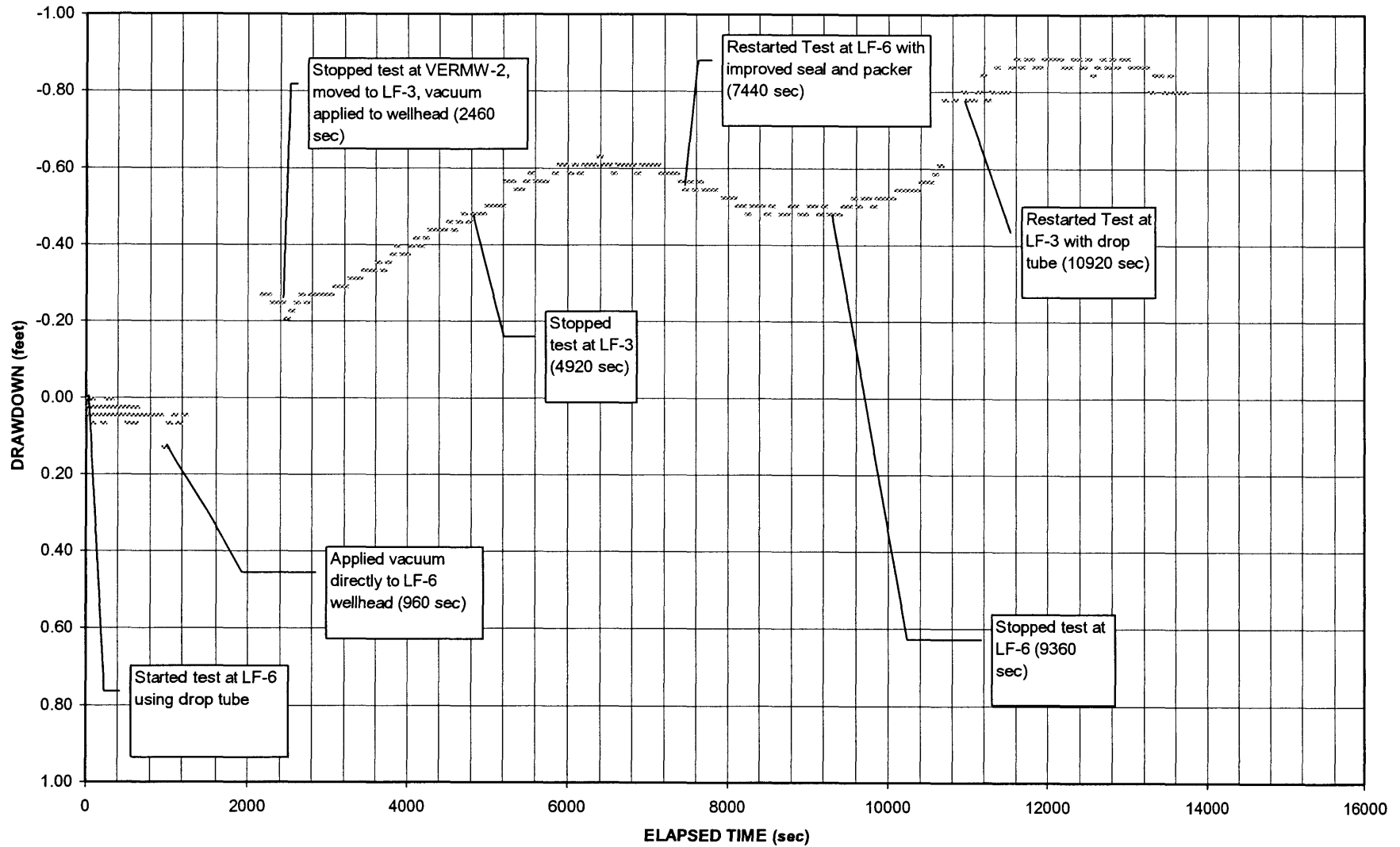

VER Pilot Test, Short-Term Test (Test 1), October 21, 2003
VERMW-1 : Groundwater Response

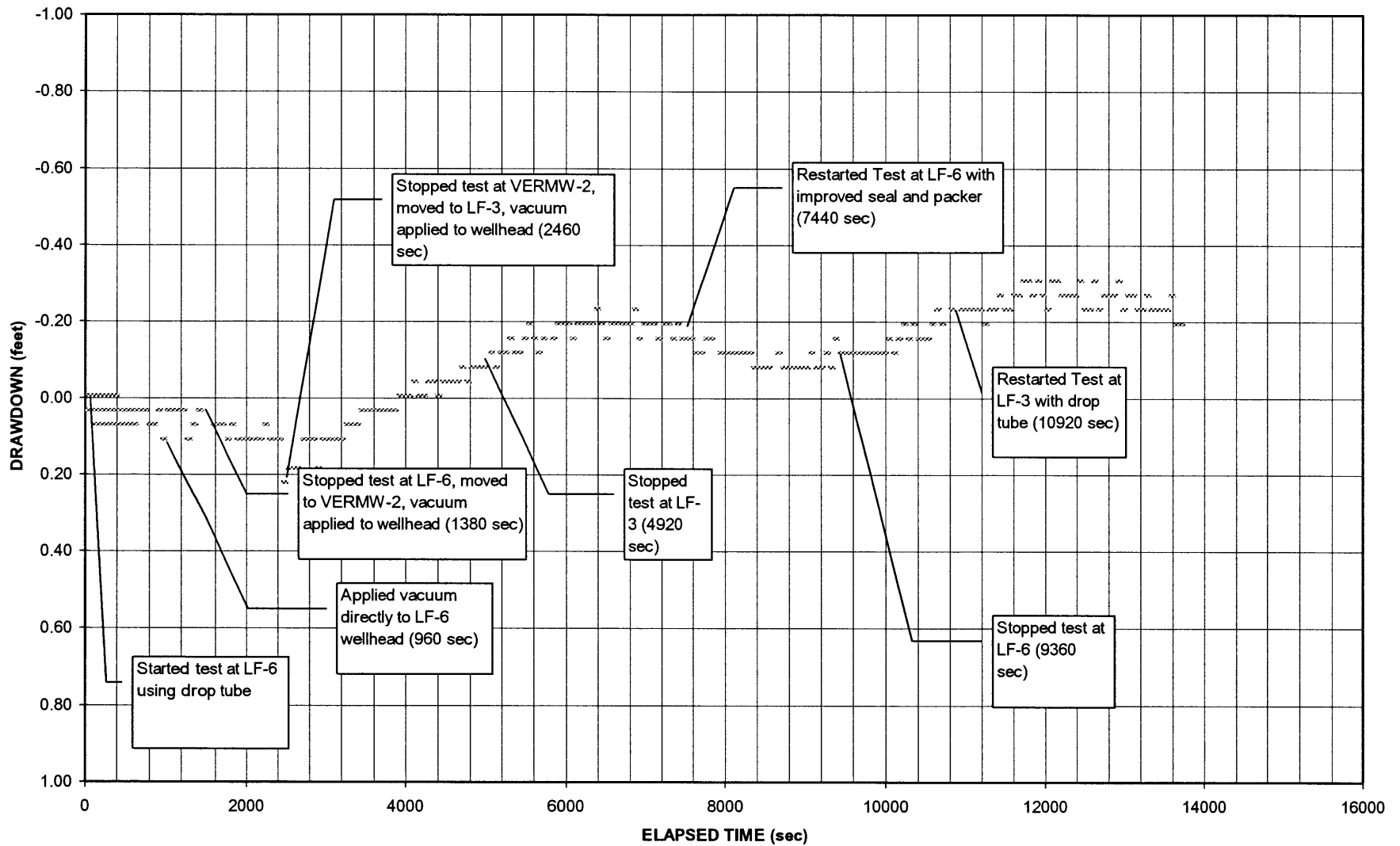

**VER Pilot Test, Short-Term Test (Test 1), October 21, 2003
MW-28 : Groundwater Response**

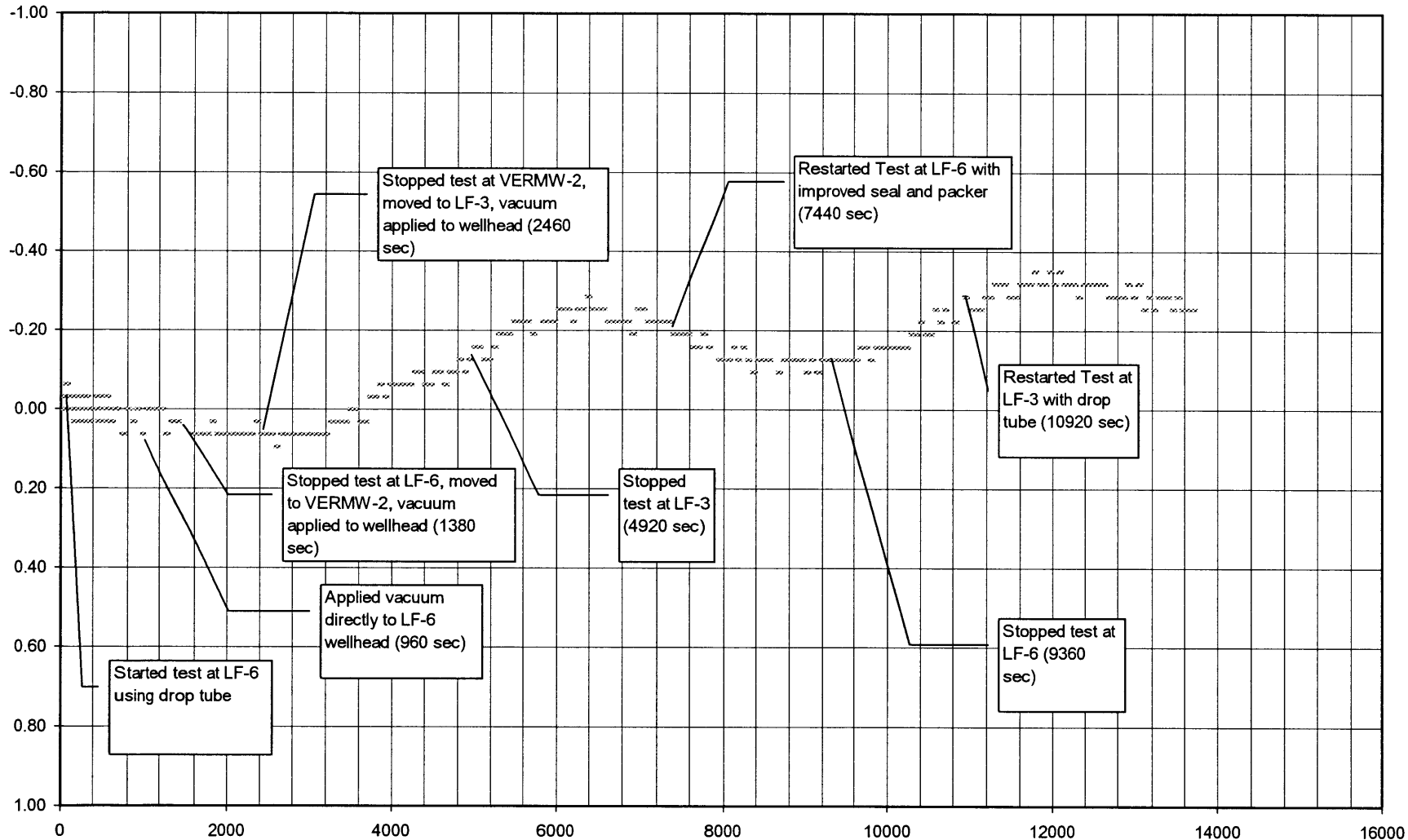

VER Pilot Test, Short-Term Test (Test 1), October 21, 2003
MW-3URS : Groundwater Response

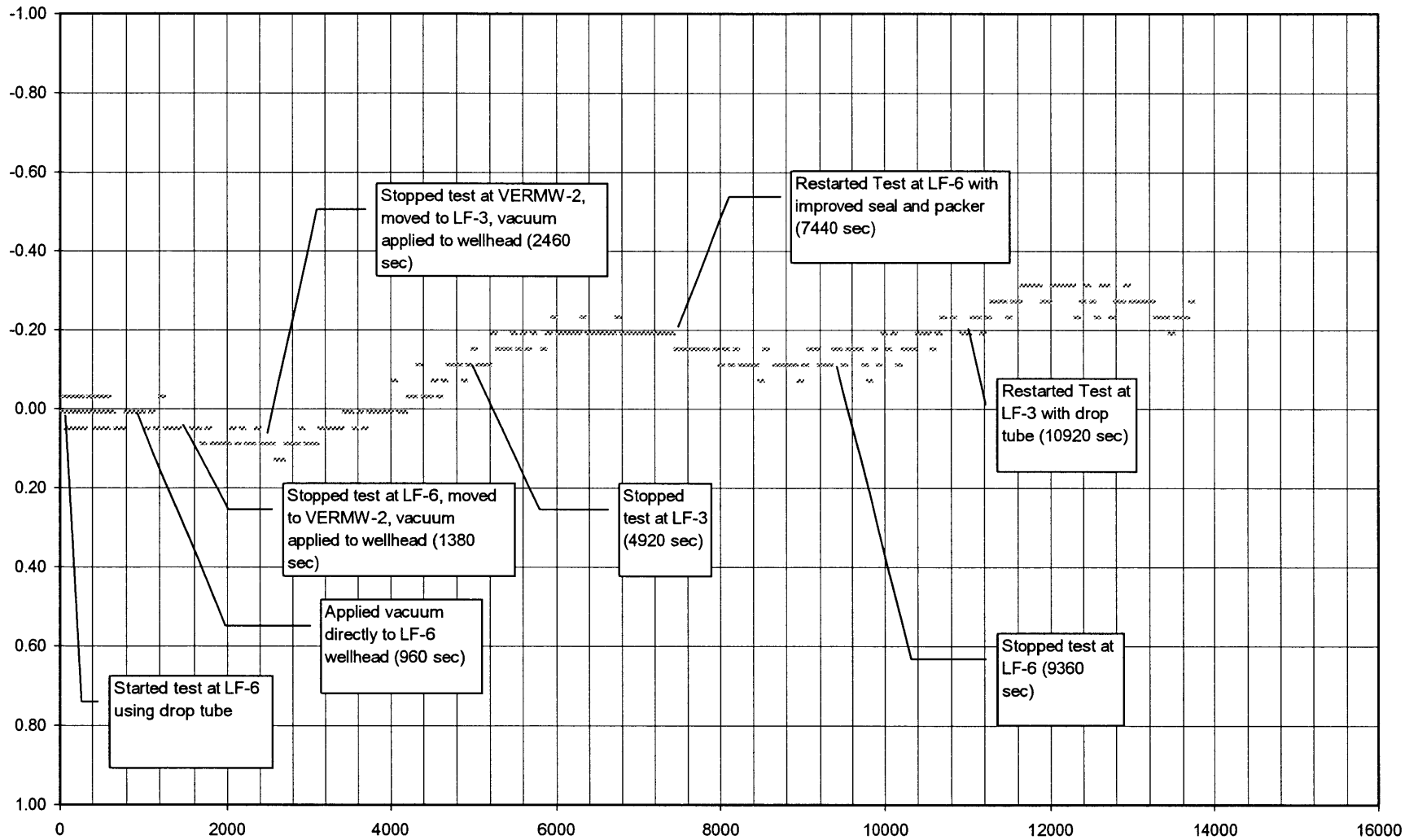

VER Pilot Test, Short-Term Test (Test 1), October 21, 2003
LF-6 : Groundwater Response

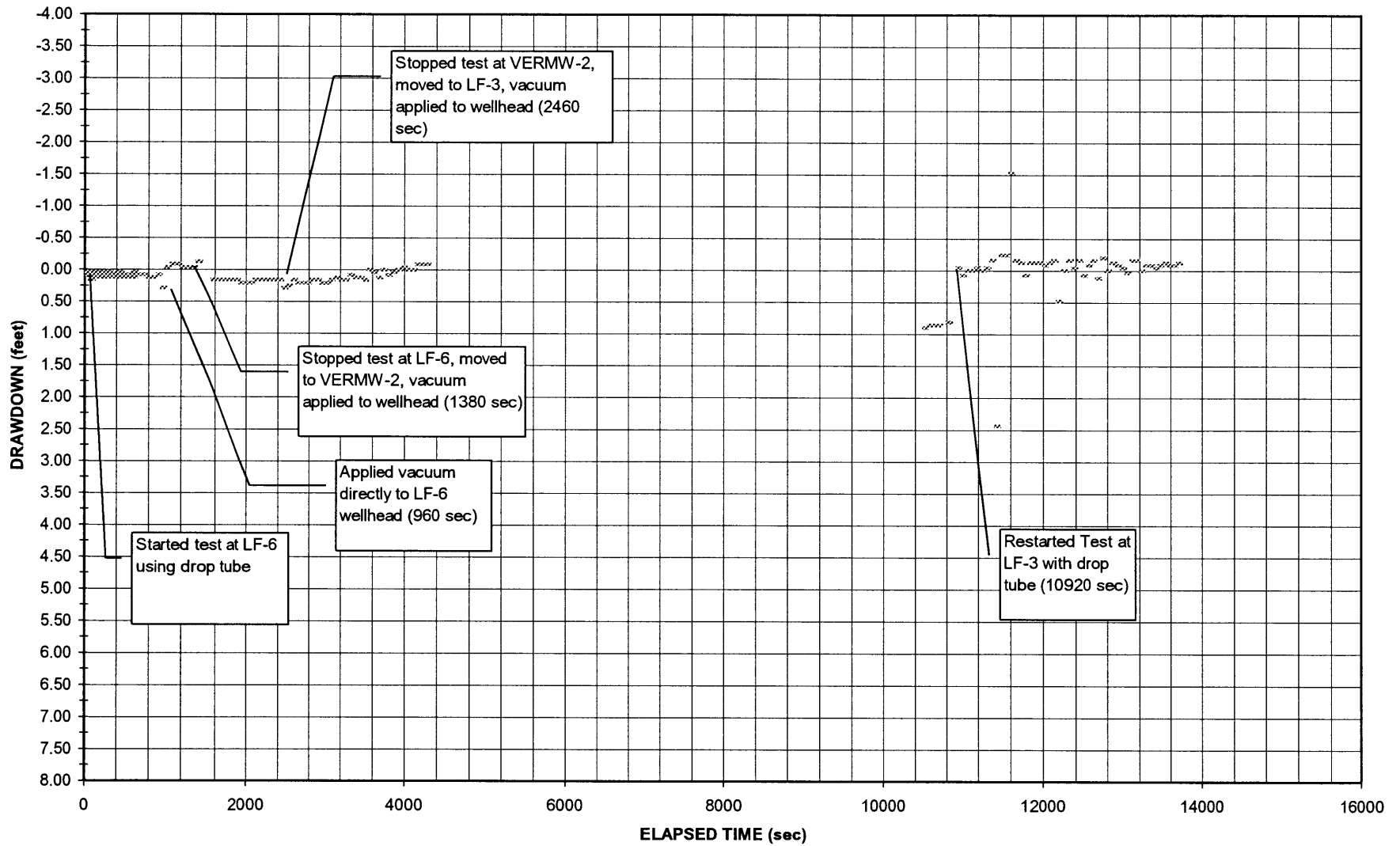

DAPL		XOM-Buffalo, NY terminal					XWell:LF-6											
DATA LOG		10/21/03 15:42:12 TPE/GW Pump					Test 1											
elapsed time (sec)	VERMW-3 Vac Resp (in WC)	VERMW-4 Vac Resp (in WC)	VERMW-2 Vac Resp (in WC)	VERMW-1 Vac Resp (in WC)	MW-28 Vac Resp (in WC)	MW-3URS Vac Resp (in WC)	Well Vacuum (inHg)	Straw Vacuum (inHg)	VERMW-3 GW DD (feet)	VERMW-4 GW DD (feet)	VERMW-2 GW DD (feet)	VERMW-1 GW DD (feet)	MW-28 GW DD (feet)	MW-3URS GW DD (feet)	LF-6 GW DD (feet)	HighVac AirFlow (scfm)	Time	Notes
12780	0.03	0.01	-0.02	-0.03	0.03	0.02	0.43	8.61	-0.28	-0.34	-0.89	-0.27	-0.29	-0.27	0.00	27.06	19:15:12	
12840	0.03	0.01	-0.02	-0.03	0.03	0.02	0.28	10.61	-0.26	-0.36	-0.86	-0.27	-0.29	-0.27	-0.12	25.89	19:16:12	
12900	0.03	0.01	-0.02	-0.03	0.05	0.02	0.32	13.21	-0.28	-0.32	-0.89	-0.31	-0.32	-0.31	-0.08	25.35	19:17:12	
12960	0.02	0.01	-0.02	-0.03	0.03	0.00	0.32	13.54	-0.28	-0.36	-0.89	-0.23	-0.29	-0.27	-0.04	25.30	19:18:12	
13020	0.02	0.01	-0.02	-0.03	0.04	0.00	0.68	9.57	-0.26	-0.36	-0.86	-0.27	-0.32	-0.27	0.04	27.45	19:19:12	
13080	0.03	0.02	-0.03	-0.03	0.02	0.00	0.52	9.14	-0.26	-0.34	-0.86	-0.27	-0.25	-0.27	-0.16	25.93	19:20:12	
13140	0.03	0.01	-0.02	-0.03	0.02	0.00	0.54	9.05	-0.26	-0.34	-0.86	-0.23	-0.29	-0.27	-0.16	25.85	19:21:12	
13200	0.03	0.01	-0.02	-0.03	0.05	0.01	0.63	10.54	-0.26	-0.34	-0.86	-0.23	-0.25	-0.27	0.00	26.30	19:22:12	
13260	0.03	0.01	-0.02	-0.03	0.03	0.01	0.57	8.98	-0.24	-0.36	-0.80	-0.27	-0.29	-0.23	-0.08	25.93	19:23:12	
13320	0.03	0.01	-0.01	-0.03	0.03	0.01	0.57	9.84	-0.22	-0.40	-0.84	-0.23	-0.29	-0.23	-0.08	26.09	19:24:12	
13380	0.03	0.01	-0.02	-0.03	0.04	0.01	0.56	9.33	-0.26	-0.40	-0.84	-0.23	-0.29	-0.23	-0.04	25.93	19:25:12	
13440	0.02	0.01	-0.01	-0.03	0.05	0.02	0.57	9.36	-0.22	-0.36	-0.80	-0.23	-0.25	-0.19	-0.08	26.09	19:26:12	
13500	0.02	0.01	-0.02	-0.03	0.05	0.01	0.57	9.09	-0.24	-0.34	-0.84	-0.23	-0.29	-0.23	-0.12	26.09	19:27:12	
13560	0.02	0.01	-0.02	-0.03	0.04	0.02	0.59	9.35	-0.24	-0.32	-0.80	-0.27	-0.25	-0.23	-0.08	26.18	19:28:12	
13620	0.03	0.01	-0.02	-0.03	0.03	0.00	0.57	8.67	-0.22	-0.34	-0.80	-0.19	-0.25	-0.23	-0.08	26.09	19:29:12	
13680	0.02	0.01	-0.03	-0.03	0.03	0.01	0.59	9.16	-0.22	-0.32	-0.80	-0.19	-0.25	-0.27	-0.12	25.89	19:30:12	

Graphs of Pressure and Water Table Response and DAPL Unit Data
Short-Term Test (Test 2), October 22, 2003

VER Pilot Test, Short-Term Test (Test 2), October 22, 2004
VERMW-3 : Vacuum Response

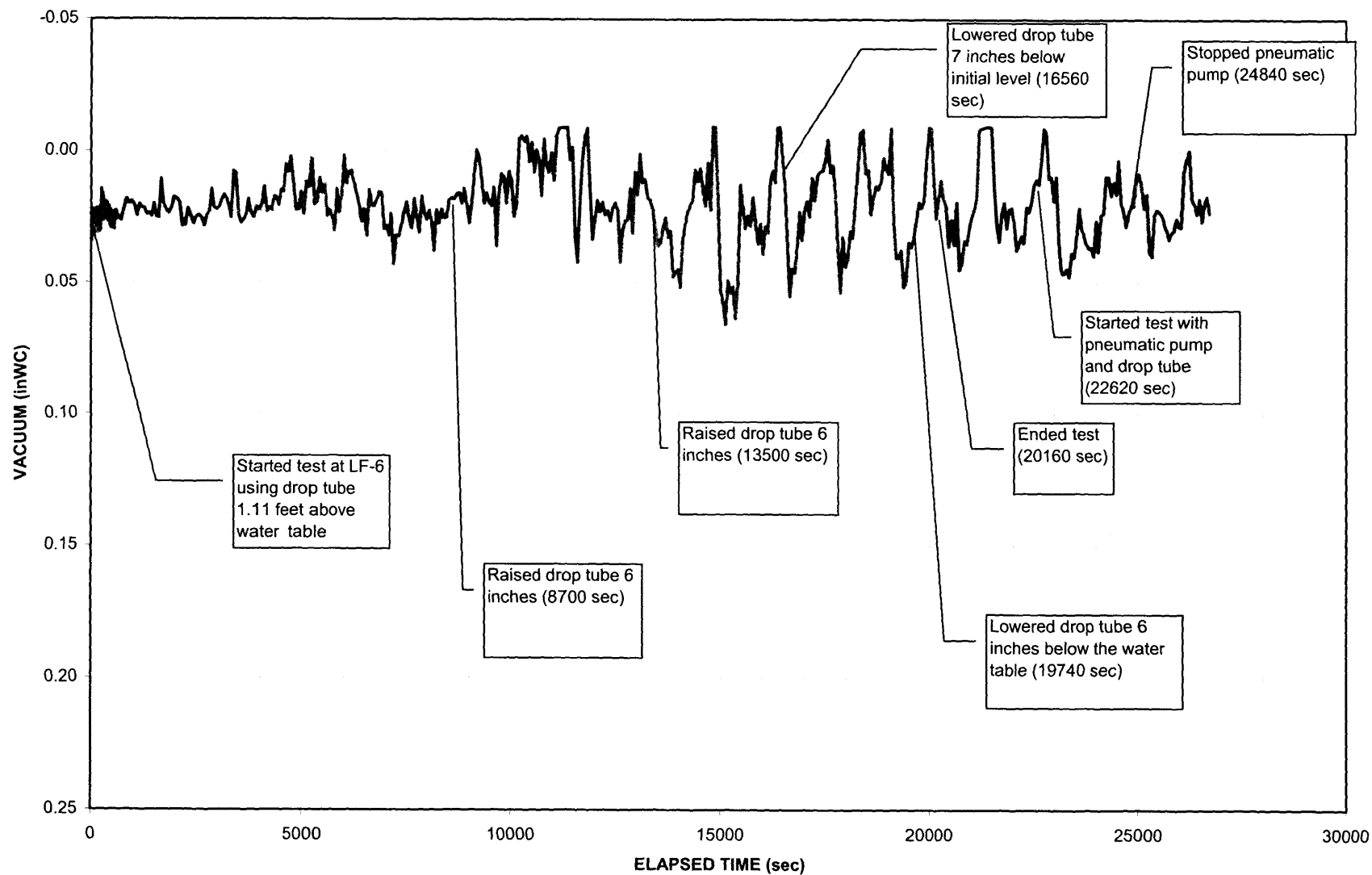

VER Pilot Test, Short-Term Test (Test 2), October 22, 2004
VERMW-4 : Vacuum Response

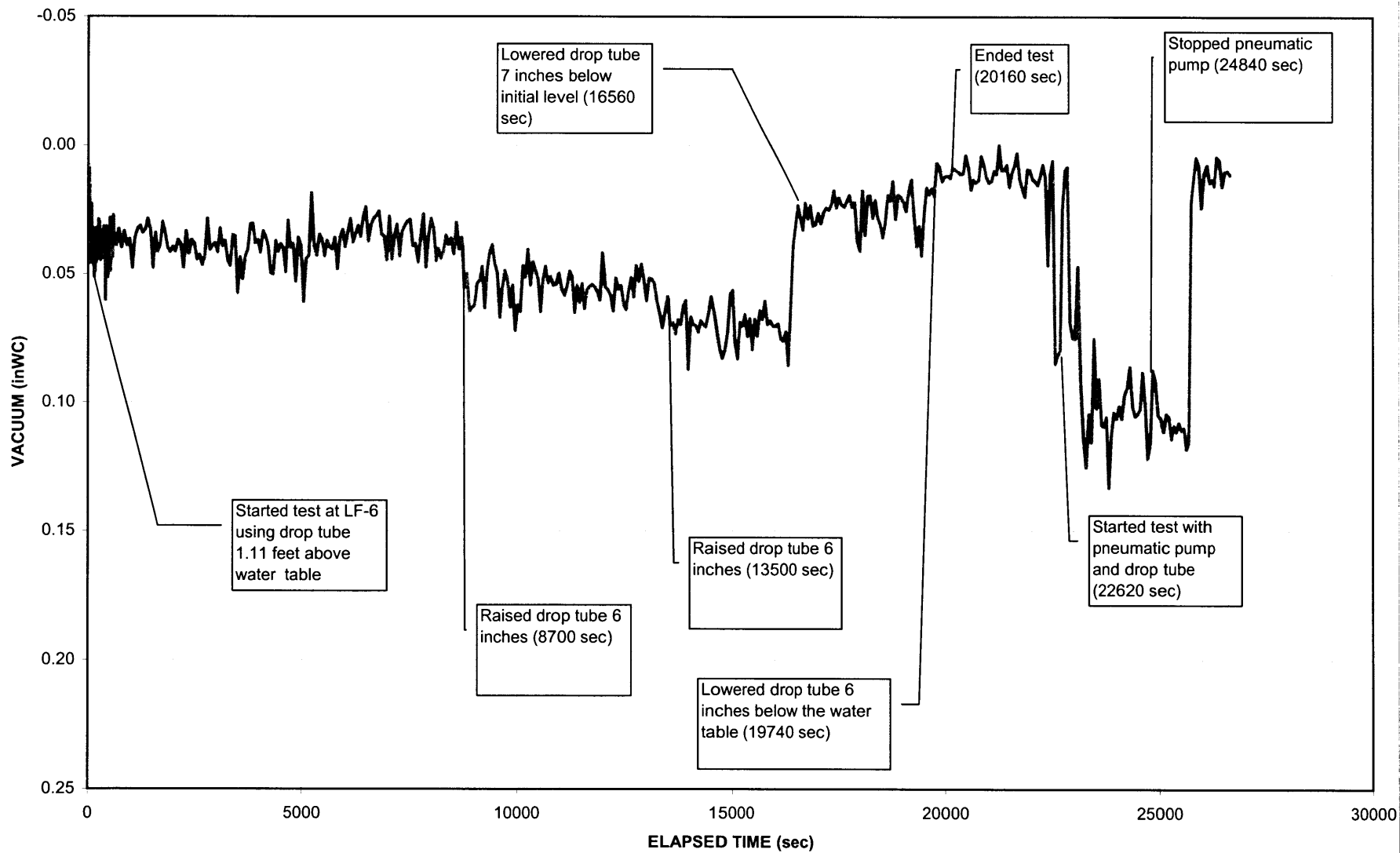

VER Pilot Test, Short-Term Test (Test 2), October 22, 2004
VERMW-2 : Vacuum Response

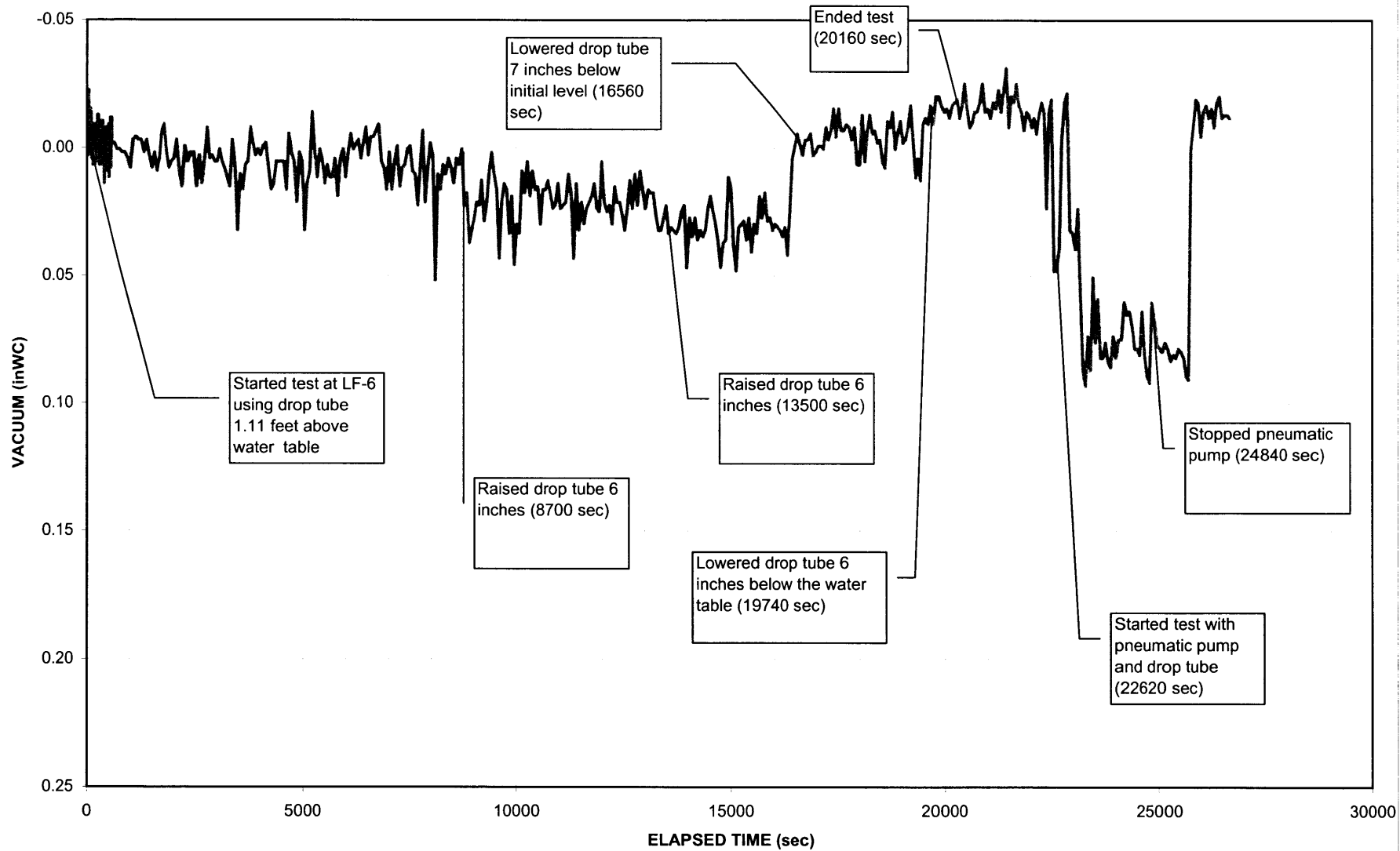

VER Pilot Test, Short-Term Test (Test 2), October 22, 2004
VERMW-1 : Vacuum Response

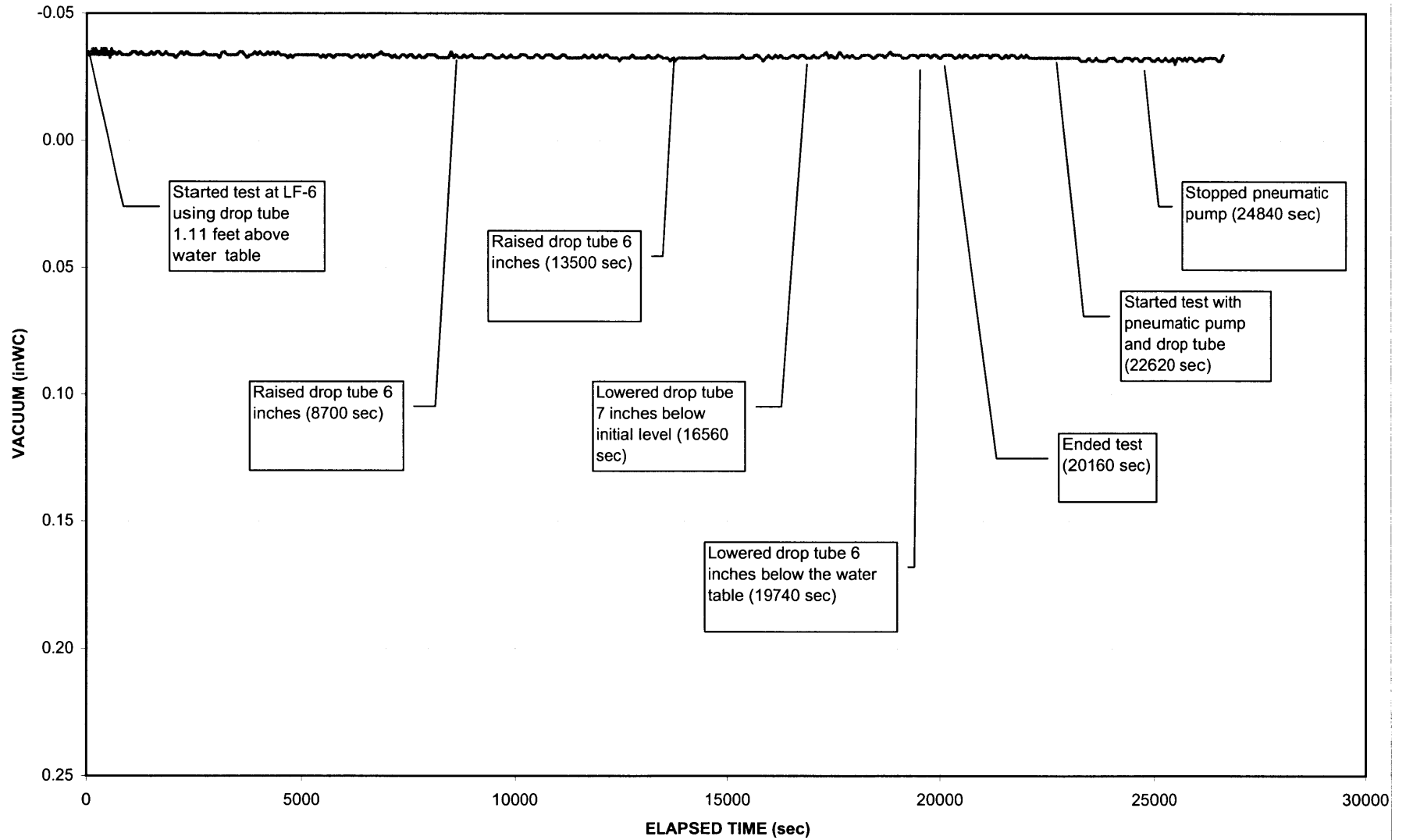

VER Pilot Test, Short-Term Test (Test 2), October 22, 2004
MW-28 : Vacuum Response

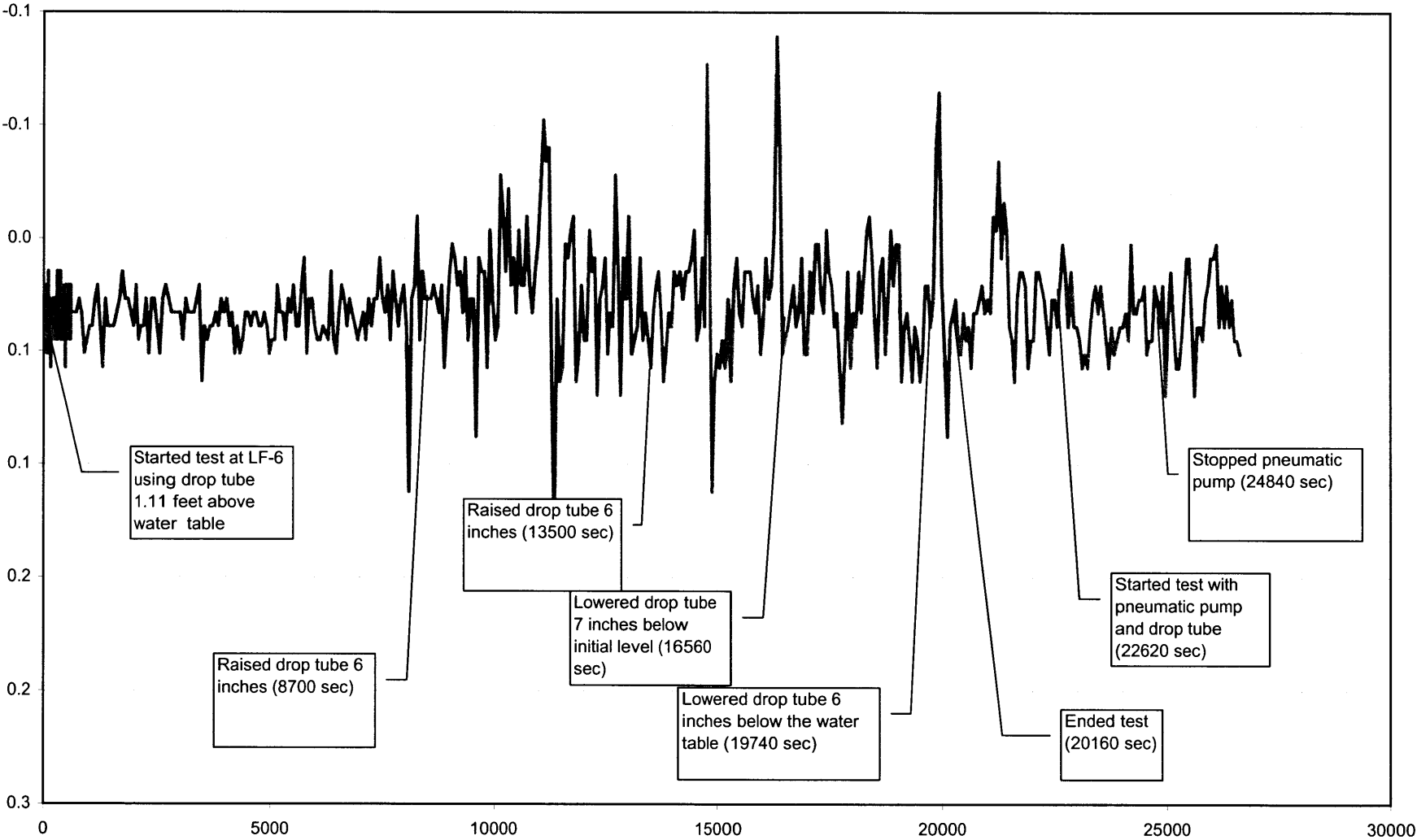

VER Pilot Test, Short-Term Test (Test 2), October 22, 2004
MW-28 : Vacuum Response

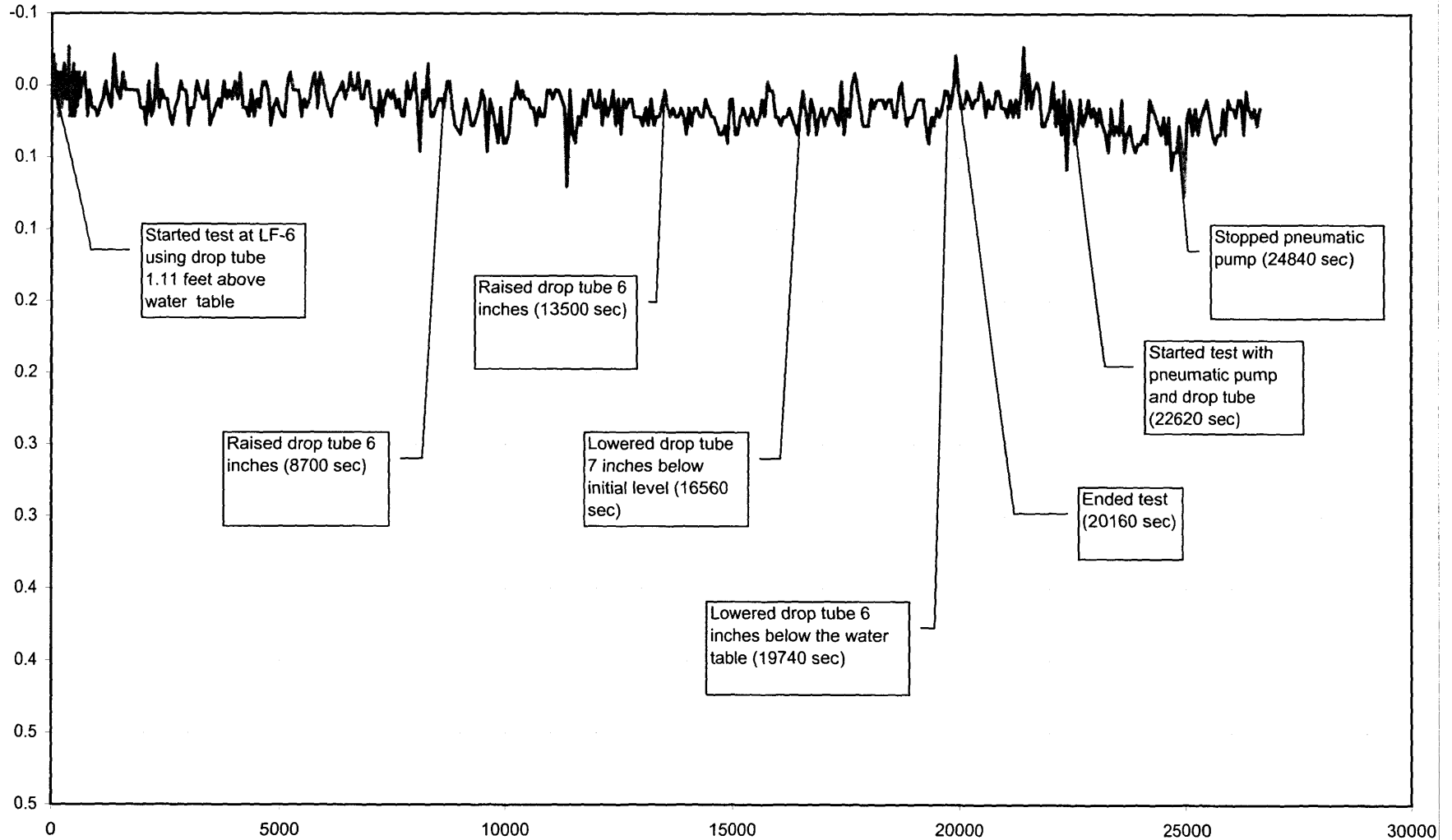

VER Pilot Test, Short-Term Test (Test 2), October 22, 2003
VERMW-3 : Groundwater Response

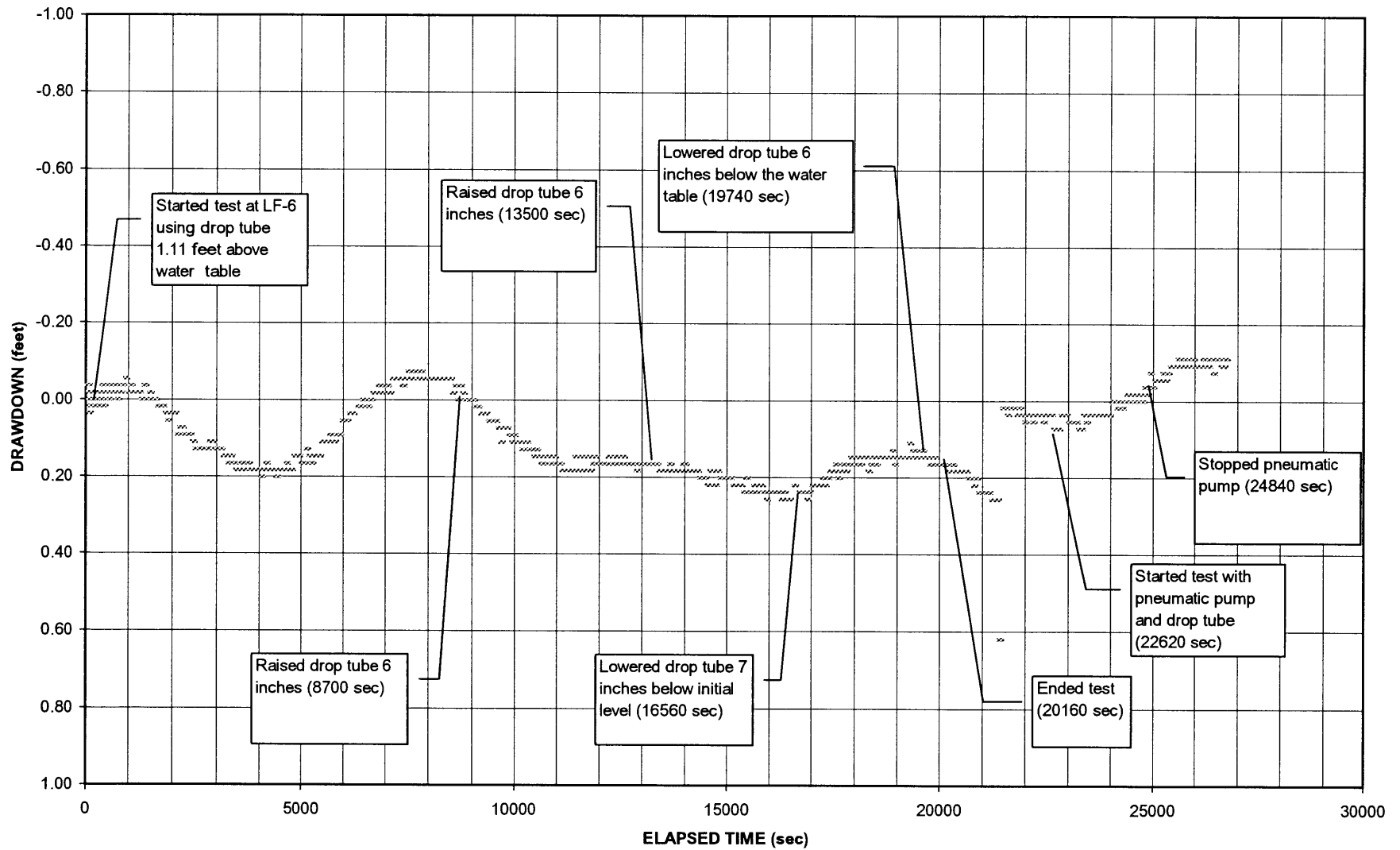

VER Pilot Test, Short-Term Test (Test 2), October 22, 2003
VERMW-4 : Groundwater Response

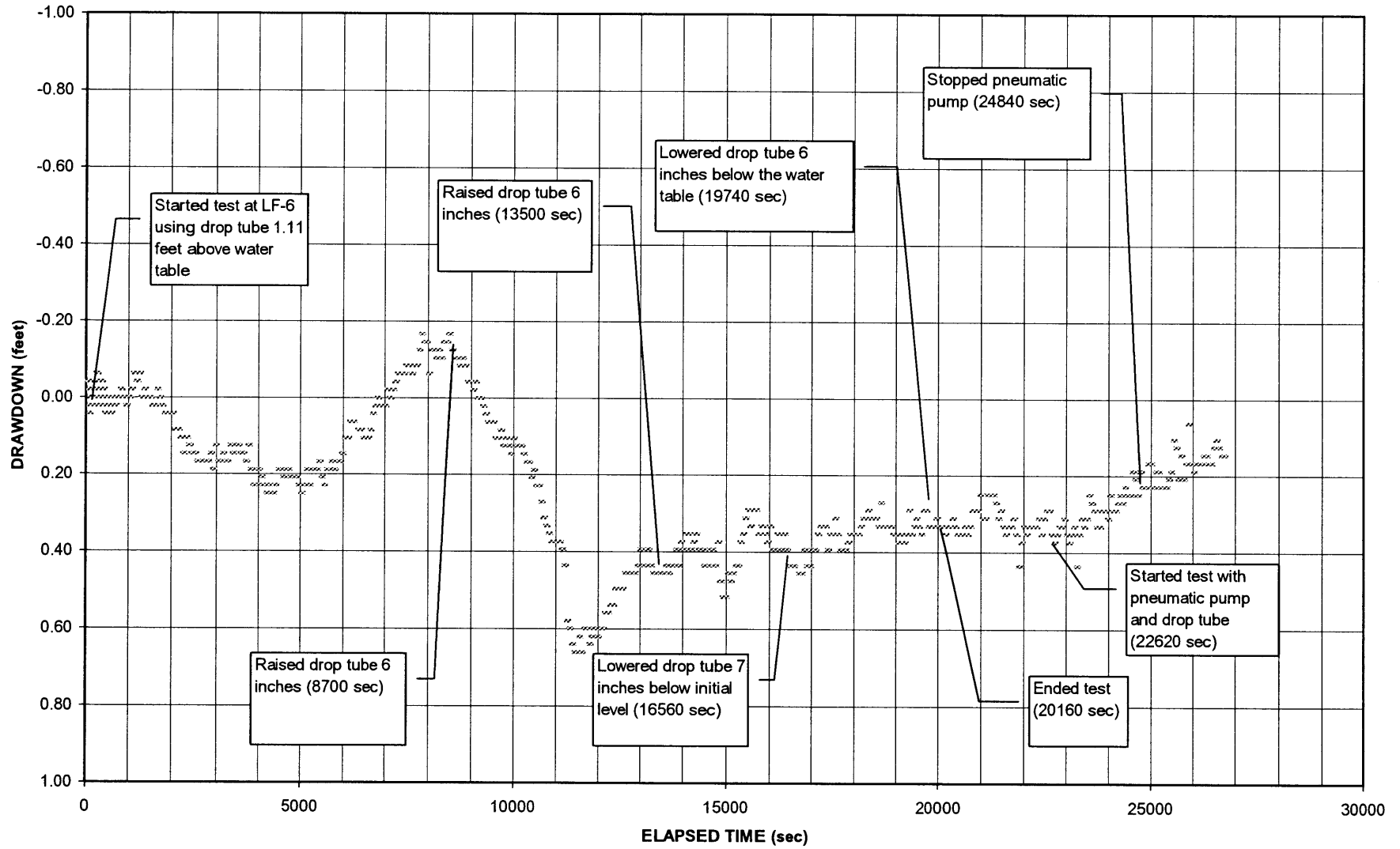

VER Pilot Test, Short-Term Test (Test 2), October 22, 2003
VERMW-2 : Groundwater Response

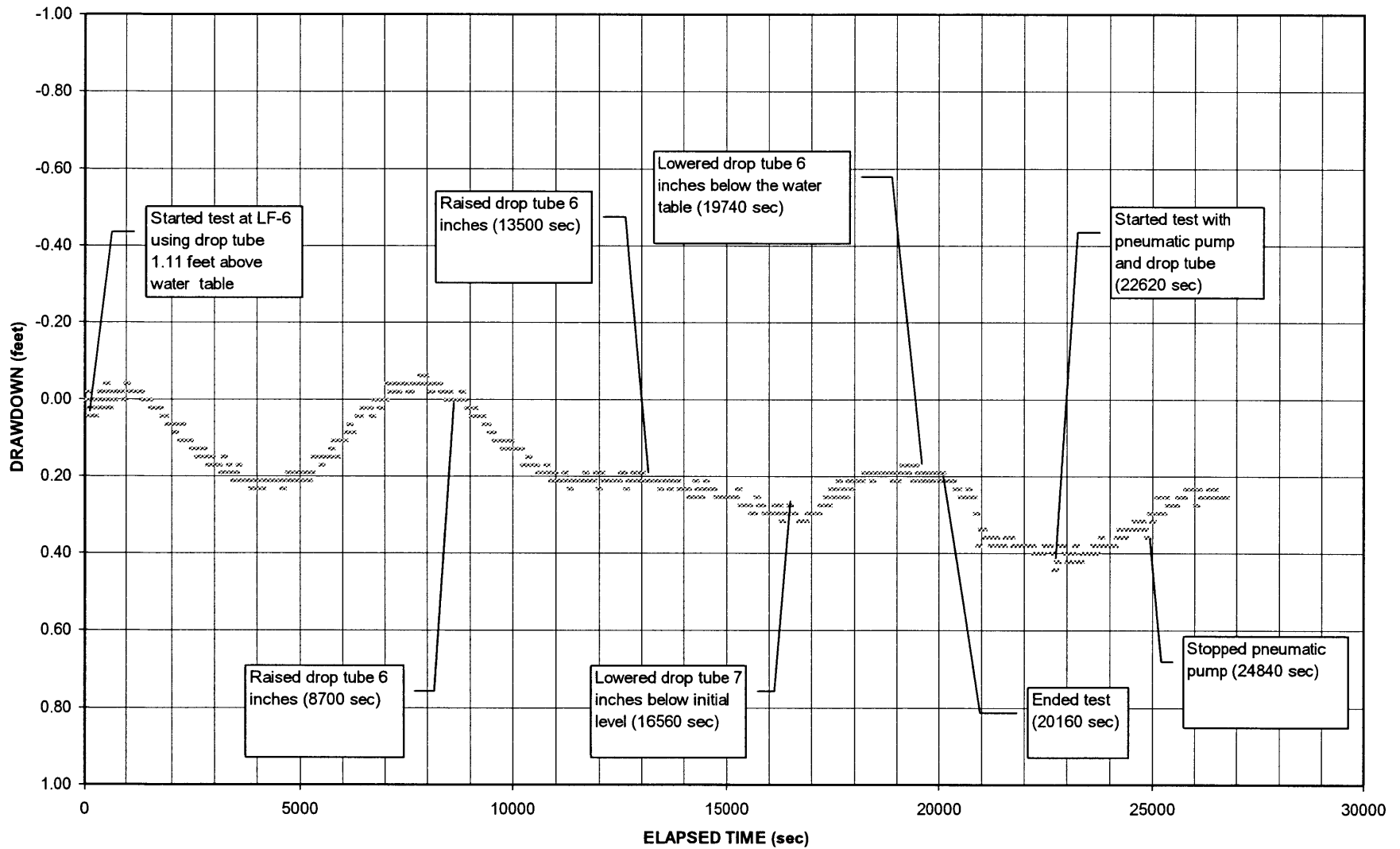

VER Pilot Test, Short-Term Test (Test 2), October 22, 2003
VERMW-1 : Groundwater Response

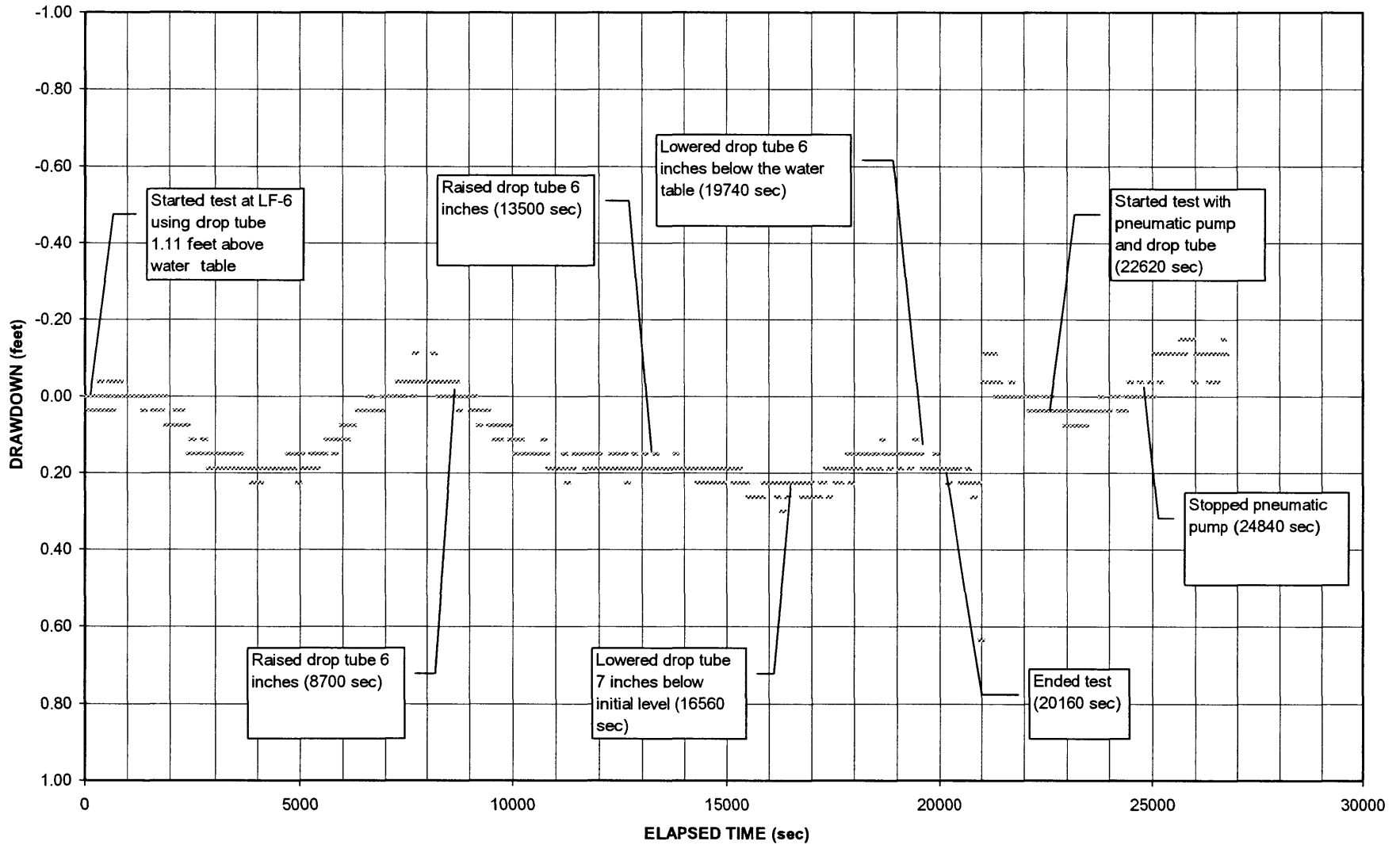

VER Pilot Test, Short-Term Test (Test 2), October 22, 2003
MW-28 : Groundwater Response

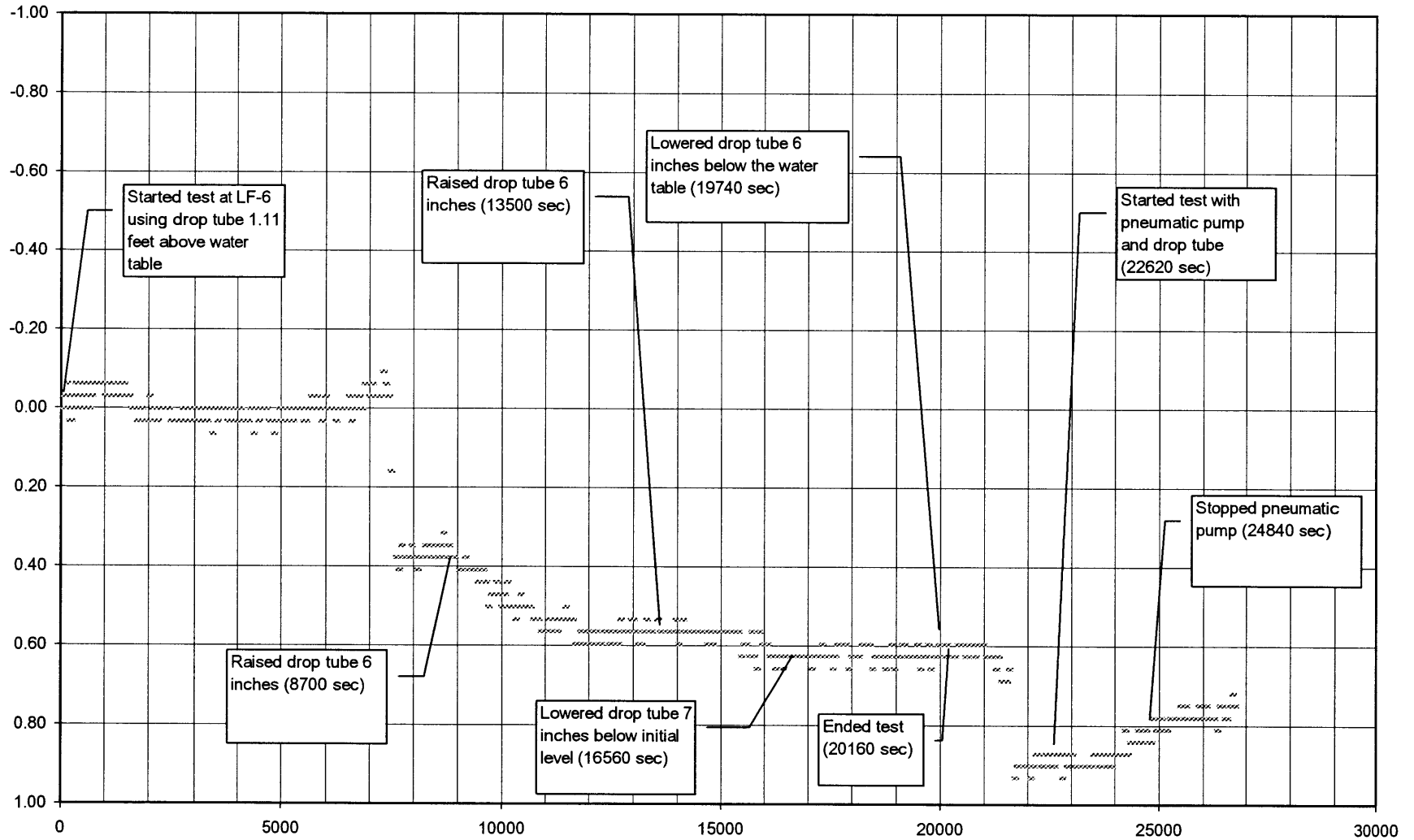

VER Pilot Test, Short-Term Test (Test 2), October 22, 2003
MW-3URS : Groundwater Response

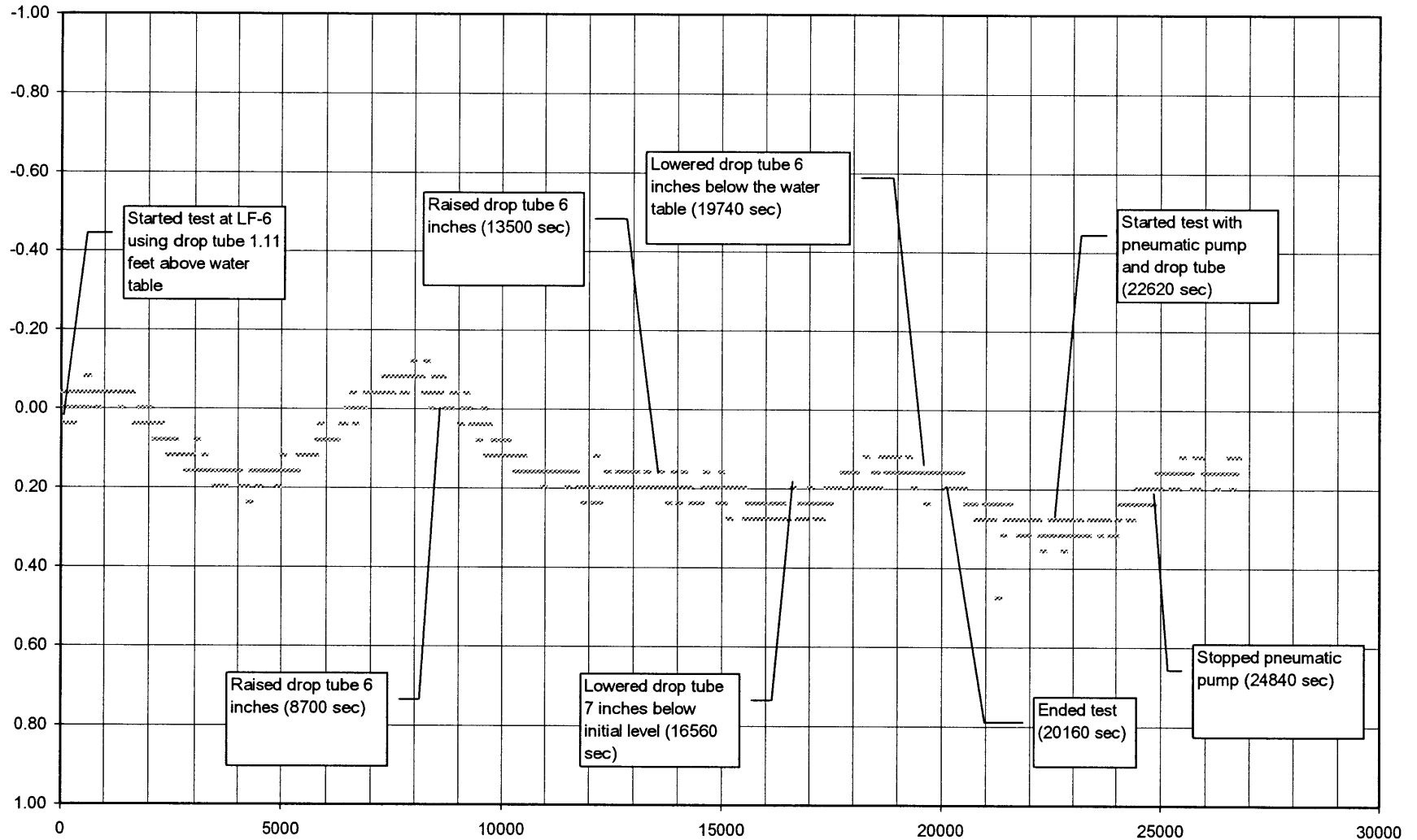

VER Pilot Test, Short-Term Test (Test 2), October 22, 2003
LF-6 : Groundwater Response

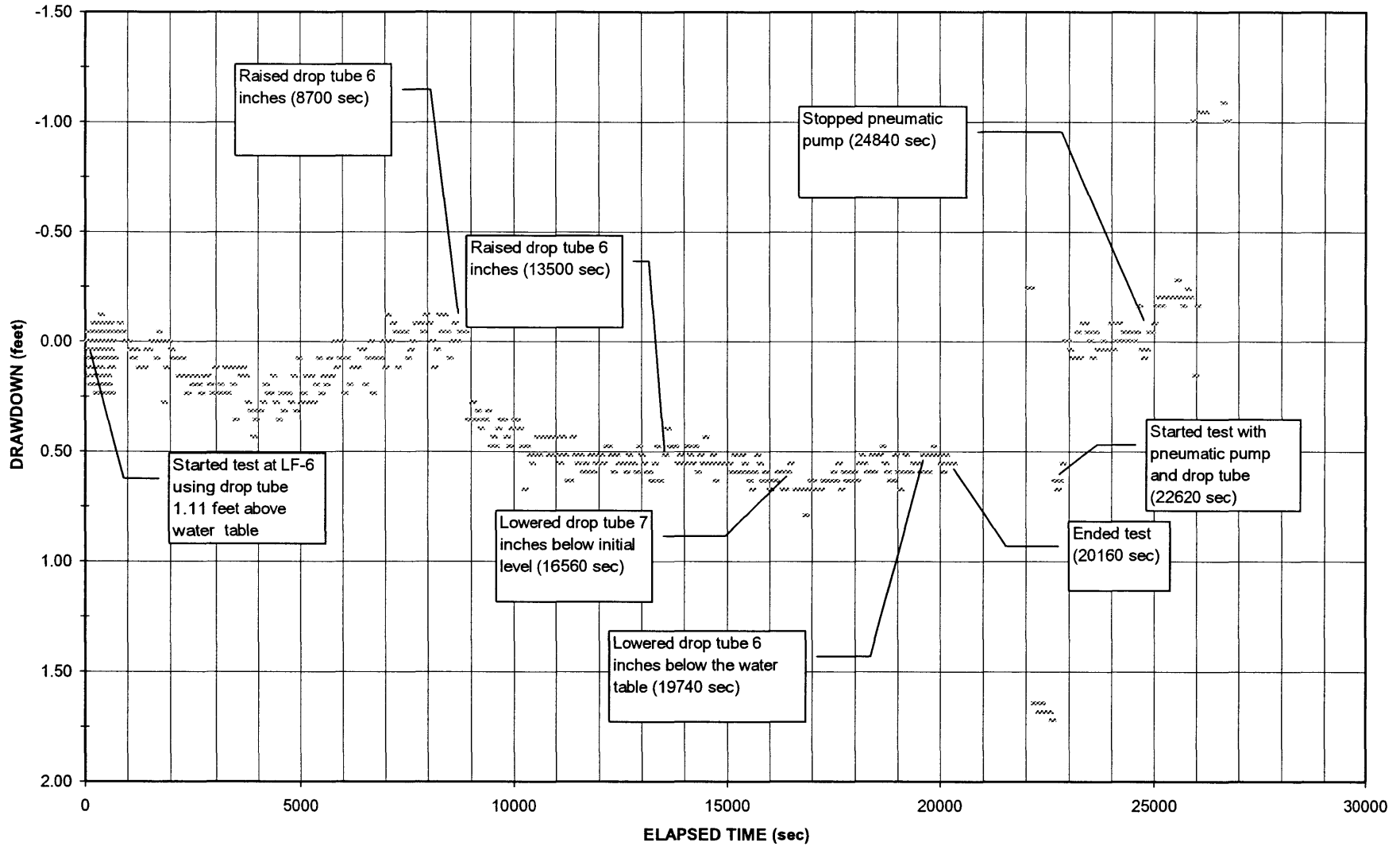

DAPL DATA LOG		XOM-Buffalo, NY Terminal					XWell:LF-6												
10/22/03 9:08:29 TPE		Test 2																	
elapsed time (sec)	VERMW-3 Vac Resp (in WC)	VERMW-4 Vac Resp (in WC)	VERMW-2 Vac Resp (in WC)	VERMW-1 Vac Resp (in WC)	MW-28 Vac Resp (in WC)	MW-3URS Vac Resp (in WC)	Well Vacuum (inHg)	Straw Vacuum (inHg)	VERMW-3 GW DD (feet)	VERMW-4 GW DD (feet)	VERMW-2 GW DD (feet)	VERMW-1 GW DD (feet)	MW-28 GW DD (feet)	MW-3URS GW DD (feet)	LF-6 GW DD (feet)	HighVac AirFlow (scfm)	Time	Notes	
5	0.03	0.01	-0.02	-0.03	0.05	0.00	0.23	0.32	-0.04	-0.04	0.00	0.00	0.00	-0.04	0.00	54.21	9:08:34		
10	0.03	0.01	-0.02	-0.03	0.04	0.00	0.25	0.28	-0.02	-0.04	-0.02	0.00	0.00	0.00	0.00	54.27	9:08:39		
15	0.03	0.01	-0.02	-0.03	0.05	-0.01	0.25	0.28	-0.04	-0.04	-0.02	0.00	-0.03	0.00	-0.04	54.29	9:08:44		
20	0.03	0.01	-0.02	-0.03	0.04	-0.02	0.23	0.32	0.00	-0.02	-0.02	0.04	-0.03	0.00	0.00	54.21	9:08:49		
25	0.03	0.01	-0.02	-0.03	0.03	0.00	0.23	0.32	-0.02	-0.04	0.00	0.00	-0.03	-0.04	0.04	54.18	9:08:54		
30	0.03	0.01	-0.02	-0.03	0.05	0.00	0.28	0.36	0.02	-0.02	0.00	0.00	0.00	0.00	0.04	44.77	9:08:59		
35	0.03	0.04	0.00	-0.03	0.02	-0.02	0.74	5.96	0.04	0.04	0.05	0.04	0.00	0.04	0.08	41.35	9:09:04		
40	0.03	0.02	-0.02	-0.03	0.04	-0.01	0.87	6.93	0.02	0.02	0.05	0.04	-0.03	0.00	0.12	38.81	9:09:09		
45	0.03	0.04	0.00	-0.03	0.04	0.01	0.81	8.12	0.02	0.02	0.05	0.04	-0.03	-0.04	0.00	36.69	9:09:14		
50	0.03	0.05	0.00	-0.03	0.04	0.00	0.63	8.89	0.00	0.00	0.05	0.04	0.00	0.04	-0.04	34.34	9:09:19		
55	0.03	0.04	-0.01	-0.03	0.05	0.01	0.63	6.36	0.02	0.00	0.00	0.04	0.00	-0.04	0.12	33.52	9:09:24		
60	0.03	0.03	-0.01	-0.03	0.03	-0.01	0.74	6.29	0.00	0.00	0.02	0.04	-0.03	-0.04	0.16	33.84	9:09:29	started TPE test	
65	0.02	0.03	0.00	-0.03	0.03	0.01	0.76	7.77	0.02	0.00	0.05	0.04	-0.03	-0.04	0.08	33.84	9:09:34		
70	0.02	0.04	0.00	-0.03	0.03	0.00	0.72	8.14	0.02	0.02	0.02	0.04	0.00	0.04	0.00	33.39	9:09:39		
75	0.03	0.04	0.00	-0.03	0.05	0.00	0.61	8.69	0.02	0.00	0.02	0.04	0.00	0.00	0.04	32.91	9:09:44		
80	0.02	0.04	-0.01	-0.03	0.05	0.01	0.67	7.83	0.00	0.00	0.02	0.04	-0.06	0.04	0.04	33.10	9:09:49		
85	0.03	0.02	-0.02	-0.03	0.04	0.00	0.68	6.73	0.02	0.00	0.02	0.04	0.00	0.00	0.20	33.07	9:09:54		
90	0.03	0.04	0.00	-0.03	0.03	-0.01	0.68	8.74	0.00	-0.02	0.05	0.00	0.00	0.00	0.00	32.94	9:09:59		
95	0.03	0.04	-0.01	-0.03	0.03	-0.01	0.65	8.25	0.02	-0.04	0.00	0.04	0.00	0.00	0.12	32.75	9:10:04		
100	0.03	0.03	-0.01	-0.03	0.03	0.00	0.68	7.35	0.02	0.00	0.02	0.04	0.00	0.00	0.00	32.97	9:10:11		
105	0.02	0.04	0.00	-0.03	0.01	0.00	0.78	8.06	-0.02	-0.02	0.02	0.04	0.00	0.00	0.12	33.33	9:10:14		
110	0.02	0.04	0.00	-0.03	0.04	0.01	0.67	8.41	0.02	-0.02	0.05	0.04	-0.03	0.00	0.00	32.84	9:10:19		
115	0.02	0.04	0.00	-0.03	0.04	0.00	0.70	8.25	0.02	0.02	0.02	0.04	-0.03	0.00	0.08	33.30	9:10:30		
125	0.03	0.04	0.00	-0.03	0.03	-0.01	0.85	7.35	0.02	0.00	0.02	0.04	0.00	0.00	0.16	33.23	9:10:34		
130	0.02	0.04	0.00	-0.03	0.05	0.02	0.70	8.56	0.00	0.02	0.02	0.00	-0.03	0.04	0.00	32.78	9:10:39		
135	0.02	0.05	0.00	-0.03	0.04	0.00	0.65	8.38	-0.02	0.00	0.02	0.00	0.00	0.00	0.04	32.84	9:10:44		
140	0.02	0.03	-0.01	-0.04	0.03	0.02	0.81	6.76	0.00	-0.02	0.02	0.00	0.00	0.04	0.04	32.84	9:10:49		
145	0.02	0.04	0.00	-0.03	0.05	0.01	0.63	8.34	0.00	-0.04	0.00	0.04	0.03	0.00	-0.08	32.81	9:10:54		
150	0.03	0.05	0.01	-0.03	0.05	0.02	0.65	8.69	0.00	-0.02	0.05	0.04	-0.03	0.00	0.04	32.75	9:10:59		
155	0.03	0.04	0.00	-0.03	0.06	0.00	0.74	6.67	0.02	-0.02	0.02	0.04	0.00	0.00	0.12	33.07	9:11:04		
160	0.03	0.04	0.01	-0.03	0.04	0.01	0.87	6.42	0.00	0.00	0.05	0.04	0.00	0.00	0.08	33.42	9:11:09		
165	0.03	0.05	0.01	-0.03	0.05	0.00	0.70	7.70	-0.02	-0.02	0.02	0.04	-0.03	-0.04	-0.08	32.68	9:11:14		
170	0.03	0.05	0.00	-0.03	0.04	0.01	0.65	8.34	0.00	-0.02	0.02	0.04	-0.03	-0.04	0.00	32.61	9:11:19		
175	0.03	0.03	-0.01	-0.03	0.03	0.00	0.65	7.81	-0.02	-0.04	0.02	0.04	0.00	0.00	0.16	32.42	9:11:24		
180	0.03	0.04	0.00	-0.03	0.03	0.00	0.72	6.87	0.00	-0.02	0.02	0.04	0.00	-0.04	0.20	33.01	9:11:29		
185	0.03	0.04	0.00	-0.03	0.03	0.00	0.85	7.51	-0.02	-0.02	0.05	0.04	0.00	0.00	0.04	33.10	9:11:34		
190	0.03	0.05	0.01	-0.03	0.03	-0.01	0.72	8.87	0.00	0.00	0.02	0.00	-0.03	-0.04	0.00	32.97	9:11:39		
195	0.02	0.04	0.01	-0.03	0.05	0.02	0.65	8.91	0.00	0.00	0.02	0.04	0.03	0.00	0.00	32.68	9:11:44		
200	0.03	0.05	0.00	-0.03	0.04	0.00	0.63	7.13	0.02	-0.06	0.02	0.04	0.00	0.00	0.08	32.48	9:11:49		
205	0.03	0.03	-0.01	-0.03	0.04	0.02	0.70	7.37	0.00	-0.02	0.02	0.00	-0.03	0.00	0.24	32.78	9:11:54		
210	0.02	0.03	0.00	-0.03	0.03	0.01	0.85	6.60	0.02	-0.02	0.00	0.04	0.00	0.00	0.08	32.84	9:11:59		
215	0.02	0.04	0.00	-0.04	0.05	0.01	0.67	8.89	0.00	-0.02	0.02	0.04	-0.03	-0.04	-0.04	32.52	9:12:04		
220	0.03	0.04	-0.01	-0.03	0.03	0.00	0.61	8.59	0.00	-0.06	0.02	0.00	0.00	0.00	0.00	32.19	9:12:09		
225	0.03	0.04	-0.01	-0.03	0.03	0.01	0.65	7.55	-0.02	-0.04	0.00	0.00	0.00	-0.04	0.04	32.48	9:12:14		
230	0.02	0.03	-0.01	-0.03	0.03	-0.01	0.70	7.62	0.00	-0.02	0.00	0.00	-0.03	0.04	0.20	32.81	9:12:19		
235	0.02	0.04	0.00	-0.03	0.04	0.00	0.87	7.62	0.00	-0.04	0.00	0.04	-0.03	0.00	-0.04	33.07	9:12:24		
240	0.02	0.04	0.01	-0.03	0.03	0.00	0.74	7.62	0.00	-0.04	0.02	0.04	-0.03	-0.04	-0.08	32.84	9:12:29		
245	0.02	0.04	0.00	-0.03	0.03	0.00	0.65	8.23	-0.02	-0.04	0.00	0.04	0.00	0.00	-0.04	32.48	9:12:34		
250	0.01	0.04	-0.01	-0.03	0.03	-0.01	0.59	8.65	-0.02	-0.04	0.02	0.04	-0.03	-0.04	0.00	32.35	9:12:39		
255	0.02	0.03	-0.01	-0.03	0.03	-0.01	0.74	7.84	-0.02	-0.04	0.00	0.00	-0.03	0.00	0.12	32.84	9:12:44		
260	0.02	0.03	-0.01	-0.03	0.03	-0.01	0.85	7.64	0.00	-0.04	0.00	0.04	0.00	0.00	0.08	33.17	9:12:49		
265	0.02	0.04	0.00	-0.03	0.03	0.00	0.68	8.12	0.00	-0.04	0.00	0.04	-0.03	-0.04	-0.04	32.61	9:12:54		
270	0.02	0.04	-0.01	-0.03	0.03	0.00	0.63	8.06	-0.02	-0.04	0.00	0.04	0.00	0.00	0.04	32.22	9:12:59		
275	0.02	0.03	-0.01	-0.03	0.03	-0.01	0.72	6.51	0.00	0.02	0.00	0.04	-0.03	0.00	0.20	32.58	9:13:04		
280	0.02	0.03	-0.01	-0.03	0.05	0.01	0.83	7.61	0.00	-0.02	0.00	0.04	0.00	-0.04	0.04	32.75	9:13:09		

DAPL DATA LOG		XOM-Buffalo,NYTerminal 10/22/03 9:08:29 TPE				XWell:LF-6 Test 2														
elapsed time (sec)	VERMW-3 Vac Resp (in WC)	VERMW-4 Vac Resp (in WC)	VERMW-2 Vac Resp (in WC)	VERMW-1 Vac Resp (in WC)	MW-28 Vac Resp (in WC)	MW-3URS Vac Resp (in WC)	Well Vacuum (inHg)	Straw Vacuum (inHg)	VERMW-3 GW DD (feet)	VERMW-4 GW DD (feet)	VERMW-2 GW DD (feet)	VERMW-1 GW DD (feet)	MW-28 GW DD (feet)	MW-3URS GW DD (feet)	LF-6 GW DD (feet)	HighVac AirFlow (scfm)	Time	Notes		
285	0.02	0.04	0.01	-0.03	0.04	0.01	0.68	8.74	0.00	0.00	0.00	0.04	0.00	-0.04	-0.04	32.45	9:13:14			
290	0.02	0.04	0.00	-0.03	0.03	0.01	0.70	9.00	0.00	0.00	0.00	0.00	-0.06	0.00	0.12	32.58	9:13:19			
295	0.02	0.04	0.00	-0.03	0.03	0.01	0.78	8.59	-0.02	0.00	-0.02	-0.04	-0.06	0.00	0.08	32.75	9:13:24			
300	0.02	0.04	0.01	-0.03	0.01	0.00	0.74	8.12	-0.02	0.00	0.00	0.00	-0.06	0.00	-0.08	32.52	9:13:29			
305	0.02	0.04	0.01	-0.03	0.05	0.01	0.67	9.02	-0.02	0.00	0.02	0.04	-0.03	0.00	0.00	32.52	9:13:34			
310	0.03	0.04	0.00	-0.03	0.03	0.00	0.67	6.65	-0.02	0.00	0.00	-0.04	0.00	-0.04	0.16	32.32	9:13:39			
315	0.02	0.03	0.00	-0.03	0.03	0.00	0.74	8.03	0.00	-0.02	0.02	0.04	-0.03	-0.04	0.24	32.81	9:13:44			
320	0.02	0.04	0.00	-0.03	0.01	-0.01	0.68	8.12	0.00	-0.04	0.00	0.04	-0.03	-0.04	-0.12	32.55	9:13:49			
325	0.02	0.04	0.00	-0.03	0.03	-0.01	0.68	8.21	-0.02	0.00	0.02	0.04	-0.03	-0.04	-0.04	32.35	9:13:54			
330	0.02	0.03	-0.01	-0.03	0.03	0.01	0.67	7.19	-0.04	0.00	0.02	0.04	-0.03	-0.04	0.12	32.32	9:13:59			
335	0.02	0.04	0.00	-0.03	0.03	-0.01	0.76	6.14	0.00	-0.02	0.00	0.04	0.00	0.00	0.08	32.65	9:14:04			
340	0.02	0.04	0.00	-0.03	0.04	0.00	0.79	7.57	-0.04	0.00	0.00	0.00	-0.03	-0.04	0.08	32.81	9:14:09			
345	0.02	0.04	0.01	-0.03	0.03	0.00	0.78	8.03	0.00	0.00	0.00	0.04	0.00	0.00	0.00	32.91	9:14:14			
350	0.02	0.04	0.00	-0.03	0.03	0.00	0.67	8.08	-0.02	0.00	0.00	0.04	-0.03	-0.04	-0.04	32.48	9:14:19			
355	0.02	0.04	0.00	-0.03	0.03	-0.03	0.59	7.46	-0.02	-0.02	0.00	0.00	-0.03	0.00	-0.04	32.48	9:14:24			
360	0.02	0.03	-0.01	-0.04	0.03	0.01	0.68	6.75	-0.02	0.00	0.00	0.00	-0.06	-0.04	0.20	33.23	9:14:29			
365	0.02	0.03	-0.01	-0.03	0.03	0.00	0.83	7.04	0.00	-0.02	0.00	0.00	-0.06	0.00	0.08	33.52	9:14:34			
370	0.02	0.04	0.00	-0.03	0.01	0.00	0.70	8.23	-0.02	0.00	0.00	0.04	-0.03	0.00	-0.04	33.07	9:14:39			
375	0.03	0.04	0.00	-0.03	0.03	-0.01	0.65	8.92	0.00	0.02	-0.02	0.00	-0.03	-0.04	-0.04	32.55	9:14:44			
380	0.02	0.03	-0.01	-0.03	0.05	0.02	0.68	7.81	0.02	0.02	0.00	0.00	-0.03	0.00	0.16	32.71	9:14:49			
385	0.02	0.03	-0.01	-0.03	0.03	0.00	0.83	7.53	-0.02	0.00	0.00	0.00	-0.03	-0.04	0.08	33.55	9:14:54			
390	0.02	0.04	0.00	-0.04	0.03	0.00	0.79	8.49	-0.02	0.02	0.00	0.00	-0.06	0.00	0.00	33.01	9:14:59			
395	0.02	0.04	0.00	-0.03	0.03	0.01	0.70	8.80	-0.02	0.02	0.00	0.00	-0.03	-0.04	0.00	32.71	9:15:04			
400	0.03	0.04	0.00	-0.03	0.03	0.00	0.65	7.77	-0.02	0.04	0.00	0.00	-0.06	0.00	0.00	32.71	9:15:09			
405	0.03	0.04	0.00	-0.03	0.03	0.00	0.63	8.25	-0.02	0.02	0.00	0.00	-0.03	0.00	0.16	32.81	9:15:14			
410	0.03	0.04	0.00	-0.03	0.05	0.02	0.85	7.26	-0.02	0.04	0.00	0.04	-0.03	0.00	0.04	33.36	9:15:19			
415	0.02	0.04	0.00	-0.03	0.03	0.00	0.81	7.42	-0.02	0.04	0.00	0.00	-0.03	-0.04	-0.08	33.04	9:15:24			
420	0.02	0.06	0.01	-0.03	0.03	0.00	0.67	8.34	-0.02	0.04	-0.02	0.00	-0.06	0.00	-0.04	32.75	9:15:29			
425	0.02	0.04	-0.01	-0.03	0.03	0.00	0.63	7.20	-0.02	0.04	0.00	0.04	-0.03	0.00	0.00	32.19	9:15:34			
430	0.02	0.03	-0.01	-0.03	0.03	0.01	0.63	8.32	-0.02	0.04	0.00	0.00	-0.03	-0.04	0.20	32.38	9:15:39			
435	0.02	0.04	0.00	-0.03	0.03	0.00	0.76	8.28	-0.02	0.04	0.00	0.00	-0.06	0.00	0.00	32.91	9:15:44			
440	0.02	0.04	0.00	-0.03	0.03	0.00	0.67	8.61	-0.04	0.04	0.00	0.00	-0.03	0.00	0.00	32.15	9:15:49			
445	0.03	0.04	0.00	-0.03	0.04	0.02	0.67	8.39	-0.04	0.04	-0.04	0.00	0.00	-0.04	-0.04	31.75	9:15:54			
450	0.03	0.04	-0.01	-0.03	0.03	-0.01	0.68	8.63	0.00	0.02	0.02	0.00	-0.03	0.00	0.24	32.55	9:15:59			
455	0.02	0.03	0.00	-0.04	0.03	0.01	0.79	5.90	-0.02	0.00	0.00	0.00	-0.06	0.00	0.20	32.84	9:16:04			
460	0.02	0.04	0.00	-0.03	0.03	-0.01	0.79	7.79	-0.02	0.04	0.00	0.00	-0.03	0.00	0.00	32.61	9:16:09			
465	0.02	0.05	0.01	-0.03	0.02	0.01	0.65	9.09	-0.02	0.04	0.00	0.00	-0.03	0.00	-0.08	32.05	9:16:14			
470	0.02	0.05	0.01	-0.03	0.03	0.00	0.59	8.87	-0.02	0.00	-0.04	0.00	-0.03	0.00	-0.04	31.68	9:16:19			
475	0.03	0.05	0.01	-0.03	0.06	0.00	0.65	9.07	-0.02	0.02	0.00	0.00	-0.06	0.00	0.08	32.02	9:16:24			
480	0.03	0.03	-0.01	-0.03	0.03	0.01	0.68	7.61	-0.04	0.00	0.00	0.00	-0.06	-0.04	0.24	32.02	9:16:29			
485	0.02	0.04	0.00	-0.03	0.02	0.02	0.79	8.47	-0.02	0.02	0.00	0.00	0.00	-0.04	-0.08	32.45	9:16:34			
490	0.02	0.05	0.01	-0.03	0.03	0.02	0.65	8.81	-0.04	0.02	0.00	0.00	-0.03	-0.04	-0.04	31.95	9:16:39			
495	0.03	0.04	0.00	-0.03	0.04	0.02	0.67	8.01	-0.02	0.02	0.00	0.00	-0.03	0.00	0.08	32.12	9:16:44			
500	0.03	0.03	0.00	-0.03	0.05	0.01	0.78	6.18	-0.02	0.02	0.02	0.00	-0.03	-0.04	0.16	32.55	9:16:49			
505	0.03	0.04	0.00	-0.03	0.03	0.01	0.85	6.71	0.00	0.00	-0.02	0.00	0.00	-0.04	0.00	32.58	9:16:54			
510	0.03	0.04	0.00	-0.03	0.03	0.00	0.70	9.02	-0.02	0.02	0.00	0.00	-0.03	-0.04	-0.08	32.15	9:16:59			
515	0.03	0.04	0.00	-0.03	0.04	-0.01	0.61	8.94	-0.02	0.00	0.00	0.00	-0.03	0.00	-0.04	31.72	9:17:04			
520	0.03	0.04	-0.01	-0.03	0.03	0.00	0.65	8.74	-0.02	0.00	-0.02	0.00	-0.03	-0.04	0.04	31.92	9:17:09			
525	0.03	0.03	-0.01	-0.03	0.02	0.01	0.74	7.77	-0.02	0.02	-0.02	0.00	-0.03	-0.04	0.20	32.61	9:17:14			
530	0.03	0.04	0.01	-0.03	0.03	0.00	0.79	8.19	-0.02	0.00	0.00	-0.04	-0.03	-0.04	0.00	32.65	9:17:19			
535	0.03	0.05	0.01	-0.03	0.04	0.01	0.65	8.45	-0.02	0.02	-0.02	0.04	-0.06	0.00	-0.04	32.25	9:17:24			
540	0.03	0.05	0.00	-0.03	0.03	0.00	0.61	7.99	-0.04	0.00	-0.02	0.04	-0.03	-0.08	-0.04	31.89	9:17:29			
545	0.03	0.04	0.00	-0.03	0.04	0.01	0.63	8.56	-0.04	0.02	0.00	0.00	-0.03	-0.04	0.08	32.19	9:17:34			
550	0.03	0.04	0.00	-0.03	0.03	0.02	0.87	7.81	-0.04	0.04	0.02	0.00	-0.06	-0.04	0.12	32.38	9:17:39			
555	0.03	0.04	0.01	-0.03	0.03	0.00	0.78	9.00	-0.02	0.02	0.00	0.00	-0.03	-0.04	-0.04	32.81	9:17:44			

DAPL DATA LOG		XOM-Buffalo, NY Terminal					XWell:LF-6												
		10/22/03 9:08:29 TPE					Test 2												
elapsed time (sec)	VERMW-3 Vac Resp (in WC)	VERMW-4 Vac Resp (in WC)	VERMW-2 Vac Resp (in WC)	VERMW-1 Vac Resp (in WC)	MW-28 Vac Resp (in WC)	MW-3URS Vac Resp (in WC)	Well Vacuum (inHg)	Straw Vacuum (inHg)	VERMW-3 GW DD (feet)	VERMW-4 GW DD (feet)	VERMW-2 GW DD (feet)	VERMW-1 GW DD (feet)	MW-28 GW DD (feet)	MW-3URS GW DD (feet)	LF-6 GW DD (feet)	HighVac AirFlow (scfm)	Time	Notes	
560	0.03	0.04	0.00	-0.03	0.03	0.01	0.72	8.21	-0.04	0.02	0.00	0.04	-0.03	0.00	0.04	32.55	9:17:49		
565	0.02	0.03	-0.01	-0.03	0.05	0.00	0.61	7.57	-0.04	0.00	-0.02	0.00	-0.03	-0.04	-0.08	32.52	9:17:54		
570	0.02	0.03	-0.01	-0.03	0.03	-0.01	0.63	8.21	-0.02	0.00	-0.02	0.04	-0.03	0.00	0.12	32.84	9:17:59		
575	0.03	0.03	0.00	-0.03	0.05	0.01	0.85	7.08	-0.02	0.02	-0.02	0.00	-0.03	-0.08	0.08	33.30	9:18:04		
580	0.02	0.04	0.01	-0.03	0.02	0.01	0.83	7.24	-0.04	0.02	-0.02	-0.04	0.00	-0.04	-0.04	33.07	9:18:09		
585	0.03	0.04	0.00	-0.03	0.03	0.01	0.65	8.23	-0.04	0.02	0.00	0.00	-0.06	-0.04	0.00	32.81	9:18:14		
590	0.03	0.04	0.00	-0.03	0.03	-0.01	0.63	6.87	-0.04	0.00	-0.02	0.04	0.00	-0.04	0.00	32.61	9:18:19		
595	0.03	0.03	-0.01	-0.04	0.05	0.01	0.61	7.42	-0.02	0.00	0.00	0.00	-0.03	-0.04	0.12	32.48	9:18:24		
600	0.02	0.03	-0.01	-0.03	0.02	0.00	0.68	7.46	-0.02	0.02	-0.02	0.00	-0.06	-0.04	0.24	32.97	9:18:29		
660	0.03	0.03	0.00	-0.03	0.03	0.01	0.83	7.39	-0.04	0.02	0.00	0.00	-0.03	-0.04	0.08	33.33	9:19:29		
720	0.03	0.04	0.00	-0.03	0.03	0.00	0.67	7.40	0.00	0.00	-0.02	-0.04	-0.06	-0.04	-0.04	32.84	9:20:29		
780	0.02	0.03	0.00	-0.03	0.03	-0.01	0.79	7.24	-0.02	-0.02	-0.02	-0.04	-0.06	0.00	-0.08	33.14	9:21:29		
840	0.02	0.04	0.00	-0.03	0.03	0.02	0.63	7.73	-0.04	0.00	-0.02	0.00	-0.06	-0.04	-0.04	32.91	9:22:29		
900	0.02	0.03	0.00	-0.03	0.03	0.00	0.81	8.61	-0.05	0.02	0.00	0.00	-0.06	-0.04	0.00	33.26	9:23:29		
960	0.02	0.04	0.00	-0.03	0.05	0.02	0.67	8.39	-0.02	0.00	-0.04	0.00	-0.03	-0.04	0.00	32.09	9:24:29		
1020	0.02	0.04	0.00	-0.03	0.05	0.02	0.81	8.14	-0.04	-0.02	-0.02	0.00	-0.03	-0.04	0.04	32.58	9:25:29		
1080	0.02	0.05	0.01	-0.03	0.04	0.02	0.67	7.50	-0.02	-0.06	-0.02	0.00	-0.06	-0.04	0.08	32.97	9:26:29		
1140	0.02	0.04	0.00	-0.03	0.04	0.02	0.67	7.39	-0.02	-0.04	-0.02	0.00	-0.03	-0.04	0.04	33.26	9:27:29		
1200	0.02	0.03	0.00	-0.03	0.03	0.01	0.81	6.51	-0.02	-0.06	-0.02	0.00	-0.03	-0.04	0.12	33.71	9:28:29		
1260	0.02	0.03	0.00	-0.03	0.02	0.00	0.85	6.71	0.00	0.00	-0.02	0.00	-0.06	-0.04	0.12	34.00	9:29:29		
1320	0.02	0.03	0.00	-0.03	0.04	0.01	0.65	8.45	-0.04	-0.02	0.00	0.04	-0.03	0.00	0.12	33.07	9:30:29		
1380	0.02	0.03	0.00	-0.03	0.06	0.02	0.79	7.90	0.00	0.00	0.00	0.00	-0.06	-0.04	0.04	33.87	9:31:29		
1440	0.02	0.03	0.00	-0.03	0.03	-0.02	0.89	6.71	-0.02	0.00	0.00	0.00	-0.03	-0.04	0.04	33.84	9:32:29		
1500	0.02	0.03	0.00	-0.03	0.04	0.00	0.85	8.45	0.00	0.02	0.02	0.00	-0.03	-0.04	0.00	32.97	9:33:29		
1560	0.03	0.05	0.01	-0.03	0.04	0.01	0.65	8.23	0.00	0.02	0.02	0.04	0.00	-0.04	0.00	32.61	9:34:29		
1620	0.03	0.03	0.00	-0.03	0.04	-0.01	0.72	7.70	0.02	-0.02	0.02	0.00	0.00	0.04	0.08	34.09	9:35:29		
1680	0.01	0.04	0.01	-0.03	0.03	0.00	0.81	7.62	0.02	0.00	0.02	0.00	0.03	0.04	-0.04	34.40	9:36:29		
1740	0.02	0.04	0.00	-0.03	0.03	0.00	0.83	7.42	0.02	0.02	0.05	0.04	0.00	0.00	0.00	34.00	9:37:29		
1800	0.02	0.03	-0.01	-0.03	0.01	0.00	0.78	6.76	0.04	0.04	0.05	0.00	0.00	0.00	0.28	33.39	9:38:29		
1860	0.02	0.03	-0.01	-0.03	0.03	0.00	0.70	7.15	0.06	0.04	0.07	0.08	0.03	0.04	0.12	33.36	9:39:29		
1920	0.02	0.04	0.00	-0.03	0.03	0.00	0.70	8.16	0.04	0.04	0.07	0.08	0.03	0.04	0.00	33.84	9:40:29		
1980	0.02	0.04	0.01	-0.03	0.03	0.02	0.74	8.01	0.04	0.04	0.07	0.08	-0.03	0.00	0.04	33.96	9:41:29		
2040	0.02	0.04	0.01	-0.03	0.04	0.02	0.72	7.62	0.04	0.08	0.09	0.08	0.00	0.04	0.08	34.06	9:42:29		
2100	0.02	0.04	0.00	-0.03	0.02	0.03	0.72	7.51	0.09	0.08	0.07	0.04	0.03	0.08	0.08	33.90	9:43:29		
2160	0.03	0.04	0.00	-0.03	0.05	0.00	0.72	7.90	0.07	0.11	0.11	0.08	0.03	0.08	0.16	33.87	9:44:29		
2220	0.03	0.04	0.01	-0.03	0.04	0.02	0.92	7.51	0.07	0.15	0.07	0.04	0.00	0.04	0.08	34.99	9:45:29		
2280	0.02	0.05	0.02	-0.03	0.04	0.02	0.83	7.61	0.09	0.11	0.11	0.08	0.00	0.08	0.16	34.34	9:46:29		
2340	0.02	0.03	0.00	-0.03	0.03	-0.01	0.87	6.69	0.09	0.13	0.11	0.08	0.00	0.08	0.24	35.11	9:47:29		
2400	0.03	0.04	0.01	-0.03	0.05	0.02	0.74	7.55	0.09	0.15	0.11	0.15	0.00	0.12	0.16	34.74	9:48:29		
2460	0.03	0.04	0.00	-0.03	0.03	0.00	0.81	6.31	0.11	0.15	0.13	0.11	0.03	0.08	0.20	35.29	9:49:29		
2520	0.02	0.04	0.00	-0.03	0.03	0.01	0.87	7.59	0.13	0.17	0.13	0.15	0.03	0.08	0.16	35.47	9:50:29		
2580	0.03	0.04	0.02	-0.03	0.04	0.01	0.96	6.87	0.13	0.17	0.15	0.15	0.03	0.12	0.20	35.53	9:51:29		
2640	0.03	0.04	0.00	-0.03	0.05	0.02	0.76	7.33	0.13	0.17	0.15	0.15	0.03	0.12	0.24	34.86	9:52:29		
2700	0.02	0.05	0.01	-0.03	0.03	0.03	0.92	7.29	0.13	0.17	0.13	0.11	0.00	0.12	0.16	34.77	9:53:29		
2760	0.02	0.04	0.00	-0.03	0.02	0.02	0.78	7.42	0.13	0.17	0.15	0.15	0.03	0.16	0.16	35.14	9:54:29		
2820	0.01	0.03	-0.01	-0.03	0.03	0.01	0.81	6.76	0.11	0.15	0.17	0.19	0.03	0.12	0.20	35.32	9:55:29		
2880	0.02	0.04	0.00	-0.03	0.03	0.00	0.78	6.27	0.11	0.19	0.15	0.15	0.00	0.12	0.24	35.23	9:56:29		
2940	0.02	0.04	0.00	-0.03	0.03	0.00	0.78	6.91	0.13	0.13	0.17	0.15	0.03	0.16	0.12	35.41	9:57:29		
3000	0.02	0.04	0.01	-0.03	0.03	0.00	0.85	6.60	0.13	0.17	0.17	0.19	0.00	0.08	0.24	36.10	9:58:29		
3060	0.02	0.04	0.01	-0.03	0.03	0.03	0.83	7.53	0.13	0.17	0.17	0.15	0.03	0.16	0.20	35.62	9:59:29		
3120	0.02	0.03	0.00	-0.03	0.05	0.02	0.98	6.34	0.15	0.15	0.19	0.19	0.00	0.16	0.24	35.89	10:00:29		
3180	0.02	0.04	0.01	-0.03	0.03	0.02	0.79	6.98	0.15	0.17	0.15	0.15	0.03	0.12	0.24	35.32	10:01:29		
3240	0.02	0.04	0.01	-0.03	0.03	0.00	0.98	6.40	0.17	0.17	0.19	0.19	0.03	0.16	0.24	36.04	10:02:29		
3300	0.03	0.04	0.01	-0.03	0.03	0.00	0.85	7.59	0.15	0.13	0.17	0.15	0.00	0.16	0.12	35.56	10:03:29		
3360	0.01	0.05	0.02	-0.03	0.03	0.01	0.87	7.81	0.17	0.15	0.19	0.15	0.07	0.16	0.20	35.11	10:04:29		

DAPL DATA LOG		XOM-Buffalo,NYTerminal 10/22/03 9:08:29 TPE				XWell:LF-6 Test 2													
elapsed time (sec)	VERMW-3 Vac Resp (in WC)	VERMW-4 Vac Resp (in WC)	VERMW-2 Vac Resp (in WC)	VERMW-1 Vac Resp (in WC)	MW-28 Vac Resp (in WC)	MW-3URS Vac Resp (in WC)	Well Vacuum (inHg)	Straw Vacuum (inHg)	VERMW-3 GW DD (feet)	VERMW-4 GW DD (feet)	VERMW-2 GW DD (feet)	VERMW-1 GW DD (feet)	MW-28 GW DD (feet)	MW-3URS GW DD (feet)	LF-6 GW DD (feet)	HighVac AirFlow (scfm)	Time	Notes	
3420	0.01	0.03	0.00	-0.03	0.03	0.01	0.85	6.43	0.19	0.13	0.21	0.19	0.00	0.20	0.36	36.07	10:05:29		
3480	0.02	0.04	0.01	-0.03	0.02	0.00	0.94	6.93	0.19	0.13	0.19	0.19	0.03	0.20	0.12	36.10	10:06:29		
3540	0.03	0.06	0.03	-0.03	0.06	0.03	1.00	7.31	0.17	0.15	0.17	0.15	0.00	0.16	0.16	36.01	10:07:29		
3600	0.03	0.04	0.01	-0.03	0.04	0.02	0.89	7.77	0.19	0.15	0.21	0.19	0.00	0.16	0.12	35.71	10:08:29		
3660	0.02	0.05	0.02	-0.03	0.05	0.02	0.87	7.42	0.17	0.17	0.21	0.19	0.00	0.20	0.16	35.71	10:09:29		
3720	0.02	0.04	0.01	-0.03	0.04	0.01	0.79	7.20	0.17	0.13	0.21	0.19	0.03	0.16	0.28	35.68	10:10:29		
3780	0.02	0.04	0.01	-0.03	0.04	0.02	0.85	6.65	0.19	0.19	0.21	0.19	0.03	0.16	0.32	35.74	10:11:29		
3840	0.03	0.03	-0.01	-0.03	0.03	0.00	0.96	5.46	0.19	0.23	0.23	0.23	0.00	0.16	0.44	36.51	10:12:29		
3900	0.02	0.03	0.00	-0.03	0.04	0.01	0.94	6.58	0.19	0.23	0.21	0.19	0.03	0.16	0.36	35.62	10:13:29		
3960	0.02	0.04	0.00	-0.03	0.03	0.00	0.81	7.75	0.19	0.19	0.23	0.19	0.03	0.16	0.32	35.74	10:14:29		
4020	0.02	0.04	0.00	-0.03	0.03	0.01	1.01	6.60	0.20	0.21	0.21	0.23	0.00	0.20	0.32	36.13	10:15:29		
4080	0.01	0.04	0.00	-0.03	0.03	0.00	0.83	6.43	0.19	0.23	0.23	0.19	0.03	0.20	0.28	35.50	10:16:29		
4140	0.02	0.03	0.00	-0.03	0.04	0.01	1.01	7.24	0.17	0.25	0.21	0.19	0.03	0.20	0.20	36.19	10:17:29		
4200	0.02	0.04	0.00	-0.03	0.03	-0.01	0.96	6.34	0.19	0.23	0.21	0.19	0.03	0.24	0.24	35.80	10:18:29		
4260	0.02	0.04	0.01	-0.03	0.05	0.02	1.01	5.81	0.19	0.25	0.21	0.19	0.00	0.16	0.24	35.65	10:19:29		
4320	0.02	0.05	0.02	-0.03	0.04	0.02	0.98	7.72	0.19	0.25	0.21	0.19	0.07	0.16	0.16	35.26	10:20:29		
4380	0.02	0.05	0.01	-0.03	0.05	0.02	0.89	6.86	0.20	0.23	0.21	0.19	0.00	0.20	0.28	35.95	10:21:29		
4440	0.02	0.04	0.01	-0.03	0.05	0.00	0.89	5.78	0.19	0.19	0.21	0.19	0.03	0.20	0.36	36.07	10:22:29		
4500	0.01	0.04	0.01	-0.03	0.03	0.02	0.79	6.95	0.19	0.19	0.21	0.19	0.00	0.16	0.24	35.77	10:23:29		
4560	0.02	0.04	0.01	-0.03	0.03	0.01	1.00	5.99	0.19	0.21	0.23	0.19	0.00	0.16	0.32	36.57	10:24:29		
4620	0.01	0.04	0.01	-0.03	0.04	0.02	0.94	6.78	0.17	0.19	0.21	0.19	0.00	0.16	0.24	36.07	10:25:29		
4680	0.01	0.05	0.02	-0.03	0.03	0.00	0.87	7.42	0.19	0.19	0.19	0.15	0.03	0.16	0.24	36.13	10:26:29		
4740	0.00	0.03	-0.01	-0.03	0.03	0.00	0.94	5.01	0.19	0.21	0.21	0.19	0.03	0.16	0.28	36.01	10:27:29		
4800	0.01	0.04	0.00	-0.03	0.04	0.00	0.79	7.77	0.15	0.21	0.21	0.19	0.07	0.16	0.16	35.95	10:28:29		
4860	0.02	0.04	0.01	-0.03	0.04	0.03	0.92	6.58	0.15	0.21	0.19	0.15	0.03	0.20	0.32	36.51	10:29:29		
4920	0.02	0.05	0.02	-0.03	0.03	0.02	0.81	7.86	0.15	0.23	0.21	0.02	0.00	0.16	0.08	36.10	10:30:29		
4980	0.02	0.04	0.00	-0.03	0.04	0.01	1.01	6.09	0.17	0.25	0.21	0.15	0.03	0.12	0.28	36.69	10:31:29		
5040	0.02	0.04	0.01	-0.03	0.05	0.02	0.92	6.64	0.17	0.23	0.19	0.19	0.00	0.16	0.24	36.34	10:32:29		
5100	0.01	0.06	0.03	-0.03	0.05	0.02	0.90	7.37	0.13	0.19	0.19	0.19	0.03	0.16	0.16	36.16	10:33:29		
5160	0.01	0.04	0.01	-0.03	0.05	0.02	1.01	6.36	0.15	0.23	0.21	0.19	0.00	0.16	0.28	35.74	10:34:29		
5220	0.00	0.04	0.01	-0.03	0.02	0.00	0.85	7.70	0.17	0.19	0.19	0.15	0.03	0.16	0.16	35.38	10:35:29		
5280	0.02	0.02	-0.01	-0.03	0.03	-0.01	0.98	6.23	0.15	0.19	0.15	0.15	0.00	0.16	0.28	35.98	10:36:29		
5340	0.02	0.04	0.00	-0.03	0.03	0.00	0.79	6.73	0.15	0.19	0.15	0.19	0.00	0.12	0.20	35.59	10:37:29		
5400	0.01	0.04	0.01	-0.03	0.05	0.00	0.81	7.59	0.15	0.17	0.15	0.15	0.00	0.12	0.08	35.74	10:38:29		
5460	0.02	0.03	0.00	-0.03	0.03	0.00	0.96	6.71	0.11	0.21	0.17	0.15	0.03	0.12	0.24	35.92	10:39:29		
5520	0.01	0.04	0.00	-0.03	0.03	0.02	0.94	6.21	0.11	0.23	0.15	0.15	0.03	0.12	0.16	35.56	10:40:29		
5580	0.02	0.04	0.01	-0.03	0.02	0.01	0.92	7.24	0.11	0.19	0.15	0.11	0.00	0.12	0.20	35.74	10:41:29		
5640	0.02	0.04	0.01	-0.03	0.04	0.02	0.87	7.46	0.09	0.19	0.15	0.11	-0.03	0.12	0.08	35.50	10:42:29		
5700	0.03	0.04	0.01	-0.03	0.04	0.01	1.00	7.46	0.11	0.17	0.13	0.11	0.00	0.12	0.16	35.26	10:43:29		
5760	0.03	0.04	0.01	-0.03	0.02	0.00	0.87	7.33	0.11	0.19	0.11	0.15	-0.03	0.08	0.00	34.53	10:44:29		
5820	0.01	0.04	0.00	-0.03	0.01	-0.01	0.98	6.76	0.09	0.17	0.15	0.11	0.00	0.04	0.12	35.65	10:45:29		
5880	0.02	0.05	0.02	-0.03	0.05	0.02	0.89	7.04	0.09	0.17	0.11	0.11	0.03	0.08	0.08	35.68	10:46:29		
5940	0.02	0.04	0.00	-0.03	0.03	-0.01	0.89	6.89	0.06	0.15	0.11	0.08	-0.03	0.08	0.00	35.56	10:47:29		
6000	0.00	0.03	0.00	-0.03	0.03	0.00	0.85	5.59	0.06	0.11	0.11	0.11	0.00	0.08	0.24	35.68	10:48:29		
6060	0.01	0.04	0.01	-0.03	0.04	0.01	0.81	8.28	0.06	0.11	0.09	0.11	0.00	0.08	0.08	35.17	10:49:29		
6120	0.01	0.03	0.00	-0.03	0.05	0.02	0.85	6.56	0.04	0.06	0.07	0.08	0.00	0.08	0.20	35.29	10:50:29		
6180	0.01	0.03	-0.01	-0.03	0.05	0.02	0.79	6.98	0.04	0.06	0.09	0.08	0.03	0.08	0.12	34.80	10:51:29		
6300	0.02	0.04	0.00	-0.03	0.04	0.01	0.70	7.75	0.02	0.08	0.05	0.04	0.00	0.04	0.12	34.15	10:53:29		
6360	0.02	0.03	0.00	-0.03	0.05	0.00	0.92	6.93	0.02	0.08	0.05	0.04	0.00	0.04	0.04	35.44	10:54:29		
6420	0.03	0.04	0.00	-0.03	0.01	0.00	0.85	6.25	0.00	0.11	0.02	0.04	0.00	0.00	0.04	35.11	10:55:29		
6480	0.02	0.03	0.00	-0.03	0.05	0.01	0.79	6.91	0.00	0.11	0.02	0.04	-0.03	0.00	0.20	34.65	10:56:29		
6540	0.03	0.02	-0.01	-0.03	0.05	0.00	0.74	7.31	0.02	0.11	0.02	0.00	0.03	-0.04	0.08	33.62	10:57:29		
6600	0.01	0.04	0.00	-0.03	0.03	-0.01	0.72	7.88	0.00	0.08	0.02	0.00	0.00	0.04	0.00	33.58	10:58:29		
6660	0.02	0.03	0.00	-0.03	0.02	0.00	0.81	7.19	-0.02	0.04	0.05	0.04	-0.03	0.00	0.24	34.62	10:59:29		
6720	0.02	0.03	0.00	-0.03	0.03	0.00	0.74	6.34	-0.02	0.02	0.00	0.04	-0.03	0.00	0.08	34.25	11:00:29		

DAPL DATA LOG	XOM-Buffalo, NY Terminal				XWell:LF-6												HighVac AirFlow (scfm)	Time	Notes
	10/22/03 9:08:29 TPE				Test 2														
	elapsed time (sec)	VERMW-3 Vac Resp (in WC)	VERMW-4 Vac Resp (in WC)	VERMW-2 Vac Resp (in WC)	VERMW-1 Vac Resp (in WC)	MW-28 Vac Resp (in WC)	MW-3URS Vac Resp (in WC)	Well Vacuum (inHg)	Straw Vacuum (inHg)	VERMW-3 GW DD (feet)	VERMW-4 GW DD (feet)	VERMW-2 GW DD (feet)	VERMW-1 GW DD (feet)	MW-28 GW DD (feet)	MW-3URS GW DD (feet)	LF-6 GW DD (feet)			
6780	0.02	0.03	-0.01	-0.03	0.04	-0.01	0.78	6.43	-0.04	0.00	0.00	0.04	0.00	0.00	0.08	34.15	11:01:29		
6840	0.02	0.03	-0.01	-0.03	0.03	0.01	0.74	7.40	-0.02	0.02	0.02	0.04	-0.06	-0.04	0.08	34.21	11:02:29		
6900	0.02	0.03	0.01	-0.03	0.03	0.01	0.90	7.13	-0.04	0.02	0.00	0.00	-0.06	-0.04	0.00	34.37	11:03:29		
6960	0.03	0.04	0.01	-0.03	0.04	0.00	0.87	6.07	-0.02	0.02	0.00	0.00	-0.03	-0.04	0.12	34.74	11:04:29		
7020	0.03	0.04	0.02	-0.03	0.05	0.00	0.70	7.77	-0.04	-0.02	-0.04	0.00	-0.06	-0.04	-0.12	33.42	11:05:29		
7080	0.03	0.03	0.00	-0.03	0.04	0.02	0.89	6.14	-0.02	0.00	-0.02	0.00	-0.03	-0.04	0.00	34.74	11:06:29		
7140	0.02	0.04	0.02	-0.03	0.03	0.02	0.70	7.28	-0.05	-0.02	-0.04	0.00	-0.03	-0.04	-0.08	34.15	11:07:29		
7200	0.04	0.03	0.01	-0.03	0.05	0.03	0.72	8.12	-0.05	-0.04	-0.04	0.00	-0.03	-0.04	-0.04	33.81	11:08:29		
7260	0.03	0.03	0.00	-0.03	0.03	0.00	0.85	6.82	-0.05	-0.06	-0.02	-0.04	-0.09	-0.08	0.12	34.18	11:09:29		
7320	0.03	0.04	0.02	-0.03	0.04	0.02	0.72	7.88	-0.05	-0.06	-0.04	-0.04	-0.06	-0.08	-0.04	34.65	11:10:29		
7380	0.03	0.03	0.01	-0.03	0.03	0.01	0.85	6.45	-0.04	-0.06	-0.04	0.00	-0.03	-0.04	-0.04	35.02	11:11:29		
7440	0.02	0.03	0.01	-0.03	0.03	0.00	0.76	6.23	-0.05	-0.08	-0.04	-0.04	0.16	-0.04	-0.04	34.80	11:12:29		
7500	0.02	0.03	0.00	-0.03	0.01	0.01	0.76	7.73	-0.07	-0.08	-0.02	-0.04	1.44	-0.08	0.08	34.65	11:13:29		
7560	0.03	0.03	0.00	-0.03	0.03	0.00	0.90	5.34	-0.05	-0.06	-0.02	-0.04	0.38	-0.08	0.04	34.93	11:14:29		
7620	0.03	0.04	0.01	-0.03	0.03	0.02	0.87	6.01	-0.07	-0.08	-0.04	0.00	0.41	-0.08	0.00	34.80	11:15:29		
7680	0.02	0.04	0.01	-0.03	0.02	0.01	0.76	7.77	-0.07	-0.08	-0.04	-0.11	0.35	-0.04	-0.08	34.46	11:16:29		
7740	0.03	0.05	0.02	-0.03	0.05	0.02	0.72	7.51	-0.05	-0.12	-0.04	-0.04	0.38	-0.04	-0.08	34.59	11:17:29		
7800	0.03	0.04	0.01	-0.03	0.01	0.02	0.79	6.98	-0.07	-0.17	-0.06	-0.04	0.38	-0.08	-0.08	34.71	11:18:29		
7860	0.02	0.03	-0.01	-0.03	0.03	0.00	0.81	6.07	-0.05	-0.14	-0.04	-0.04	0.38	-0.08	-0.04	34.90	11:19:29		
7920	0.02	0.05	0.02	-0.03	0.04	0.01	0.78	8.05	-0.05	-0.14	-0.06	-0.04	0.35	-0.12	-0.12	33.96	11:20:29		
7980	0.03	0.04	0.01	-0.03	0.03	0.00	0.83	8.08	-0.05	-0.06	-0.04	-0.04	0.38	-0.08	-0.08	35.02	11:21:29		
8040	0.02	0.03	0.00	-0.03	0.02	-0.01	0.96	6.20	-0.05	-0.12	-0.02	-0.04	0.41	-0.08	0.00	34.53	11:22:29		
8100	0.03	0.03	0.00	-0.03	0.04	0.02	0.83	5.78	-0.05	-0.12	-0.04	-0.11	0.38	-0.08	0.12	35.20	11:23:29		
8160	0.04	0.04	0.05	-0.03	0.11	0.05	0.87	6.42	-0.05	-0.10	-0.04	-0.04	0.38	-0.04	0.04	35.29	11:24:29		
8220	0.02	0.04	0.01	-0.03	0.03	0.00	0.78	7.86	-0.05	-0.12	-0.04	0.00	0.35	-0.12	-0.12	34.99	11:25:29		
8280	0.03	0.04	0.02	-0.03	0.02	0.01	0.81	8.08	-0.05	-0.10	-0.02	-0.04	0.35	-0.04	-0.04	35.11	11:26:29		
8340	0.02	0.04	0.01	-0.03	-0.01	-0.01	0.74	7.22	-0.05	-0.14	-0.02	-0.04	0.38	0.00	-0.12	35.02	11:27:29		
8400	0.03	0.03	0.01	-0.03	0.05	0.02	0.85	7.20	-0.05	-0.14	0.00	0.00	0.35	-0.08	-0.04	35.26	11:28:29		
8460	0.03	0.04	0.00	-0.03	0.01	0.02	0.74	7.51	-0.05	-0.17	-0.02	-0.04	0.35	-0.04	0.08	35.05	11:29:29		
8520	0.02	0.04	0.01	-0.03	0.03	0.02	0.92	6.42	-0.02	-0.12	0.00	0.00	0.38	-0.04	0.00	35.59	11:30:29		
8580	0.02	0.04	0.01	-0.03	0.03	0.01	0.78	7.22	-0.04	-0.10	0.00	0.00	0.35	-0.08	-0.08	35.17	11:31:29		
8640	0.02	0.03	0.00	-0.03	0.03	0.01	0.87	8.10	0.00	-0.10	0.00	-0.04	0.32	0.00	0.00	34.77	11:32:29		
8700	0.02	0.04	0.01	-0.03	0.02	0.02	1.00	3.78	-0.04	-0.08	0.00	0.04	0.38	0.00	-0.04	42.65	11:33:29	Raised TPE tube 6" in extraction well	
8760	0.02	0.04	0.00	-0.03	0.03	0.00	1.14	6.36	-0.02	-0.10	-0.02	0.00	0.35	0.00	-0.04	40.41	11:34:29		
8820	0.02	0.06	0.02	-0.03	0.03	0.00	1.07	5.83	0.00	-0.08	0.00	0.00	0.38	-0.04	-0.04	38.29	11:35:29		
8880	0.01	0.05	0.02	-0.03	0.02	0.02	1.14	6.16	0.00	-0.04	0.02	0.00	0.38	-0.04	0.36	41.11	11:36:29		
9000	0.03	0.06	0.04	-0.03	0.06	0.03	1.11	6.20	0.00	-0.02	0.05	0.04	0.41	0.04	0.28	38.40	11:38:29		
9060	0.02	0.06	0.03	-0.03	0.01	0.03	1.11	6.21	0.02	-0.04	0.02	0.00	0.41	0.00	0.36	38.31	11:39:29		
9120	0.01	0.05	0.02	-0.03	0.00	0.02	1.20	6.51	0.02	0.00	0.05	0.04	0.38	-0.04	0.32	38.03	11:40:29		
9180	0.00	0.05	0.02	-0.03	0.01	0.01	1.29	6.53	0.04	0.00	0.05	0.08	0.41	0.00	0.40	37.89	11:41:29		
9240	0.00	0.05	0.01	-0.03	0.02	0.02	1.12	5.76	0.04	0.02	0.05	0.04	0.41	0.04	0.36	38.48	11:42:29		
9300	0.01	0.06	0.03	-0.03	0.01	0.03	1.29	6.03	0.04	0.04	0.07	0.04	0.41	0.04	0.36	38.73	11:43:29		
9360	0.02	0.05	0.02	-0.03	0.03	0.03	1.22	6.36	0.06	0.06	0.07	0.04	0.41	0.04	0.32	38.70	11:44:29		
9420	0.02	0.04	0.01	-0.03	0.01	0.02	1.20	5.02	0.06	0.06	0.09	0.08	0.44	0.08	0.48	38.62	11:45:29		
9480	0.02	0.04	0.00	-0.03	0.05	0.02	1.09	6.18	0.06	0.06	0.09	0.08	0.41	0.04	0.44	38.29	11:46:29		
9540	0.02	0.05	0.01	-0.03	0.03	0.00	1.22	5.89	0.06	0.11	0.11	0.11	0.41	0.00	0.48	38.78	11:47:29		
9600	0.01	0.05	0.02	-0.03	0.03	0.01	1.14	5.56	0.07	0.11	0.11	0.08	0.44	0.12	0.40	38.62	11:48:29		
9660	0.04	0.07	0.04	-0.03	0.09	0.05	1.31	6.16	0.11	0.08	0.11	0.11	0.50	0.04	0.36	38.70	11:49:29		
9720	0.02	0.06	0.02	-0.03	0.01	0.01	1.22	6.29	0.07	0.13	0.13	0.08	0.47	0.12	0.36	38.87	11:50:29		
9780	0.01	0.05	0.01	-0.03	0.01	0.02	1.16	5.92	0.07	0.11	0.11	0.08	0.47	0.08	0.44	38.51	11:51:29		
9840	0.01	0.05	0.02	-0.03	0.01	0.03	1.14	5.50	0.09	0.13	0.13	0.08	0.44	0.12	0.48	38.81	11:52:29		
9900	0.02	0.06	0.03	-0.03	0.06	0.04	1.23	5.89	0.11	0.15	0.11	0.11	0.47	0.12	0.40	38.84	11:53:29		
9960	0.01	0.05	0.02	-0.03	0.00	0.02	1.16	5.85	0.09	0.11	0.13	0.11	0.50	0.08	0.36	38.70	11:54:29		
10020	0.01	0.07	0.05	-0.03	0.03	0.04	1.25	5.76	0.11	0.13	0.13	0.15	0.47	0.12	0.36	38.65	11:55:29		

DAPL DATA LOG	XOM-Buffalo,NYTerminal				XWell:LF-6													Time	Notes
	10/22/03 9:08:29 TPE				Test 2														
	elapsed time (sec)	VERMW-3 Vac Resp (in WC)	VERMW-4 Vac Resp (in WC)	VERMW-2 Vac Resp (in WC)	VERMW-1 Vac Resp (in WC)	MW-28 Vac Resp (in WC)	MW-3URS Vac Resp (in WC)	Well Vacuum (inHg)	Straw Vacuum (inHg)	VERMW-3 GW DD (feet)	VERMW-4 GW DD (feet)	VERMW-2 GW DD (feet)	VERMW-1 GW DD (feet)	MW-28 GW DD (feet)	MW-3URS GW DD (feet)	LF-6 GW DD (feet)	HighVac AirFlow (scfm)		
10080	0.02	0.06	0.03	-0.03	0.05	0.04	1.25	5.17	0.11	0.13	0.13	0.11	0.44	0.08	0.40	38.87	11:56:29		
10140	0.02	0.06	0.03	-0.03	0.04	0.03	1.16	5.48	0.13	0.13	0.13	0.11	0.50	0.12	0.48	38.73	11:57:29		
10200	0.00	0.05	0.01	-0.03	-0.03	0.01	1.16	5.48	0.11	0.15	0.17	0.15	0.50	0.12	0.67	39.17	11:58:29		
10260	-0.01	0.05	0.02	-0.03	-0.01	0.01	1.18	5.99	0.11	0.17	0.17	0.15	0.53	0.16	0.48	38.95	11:59:29		
10320	0.00	0.04	0.01	-0.03	0.01	0.00	1.23	5.87	0.13	0.17	0.15	0.15	0.50	0.16	0.52	39.06	12:00:29		
10380	-0.01	0.05	0.02	-0.03	-0.02	0.01	1.23	6.18	0.13	0.21	0.17	0.15	0.47	0.12	0.56	39.17	12:01:29		
10440	0.00	0.05	0.01	-0.03	0.02	0.00	1.27	5.63	0.15	0.19	0.17	0.15	0.50	0.12	0.52	39.31	12:02:29		
10500	0.00	0.05	0.02	-0.03	0.01	0.01	1.29	6.29	0.13	0.23	0.17	0.15	0.50	0.16	0.44	39.28	12:03:29		
10560	0.01	0.05	0.02	-0.03	0.03	0.01	1.34	5.98	0.15	0.23	0.19	0.15	0.50	0.16	0.52	38.92	12:04:29		
10620	0.00	0.06	0.03	-0.03	0.00	0.02	1.20	6.78	0.17	0.27	0.19	0.15	0.50	0.16	0.44	38.89	12:05:29		
10680	0.00	0.05	0.02	-0.03	0.02	0.02	1.29	5.67	0.17	0.31	0.19	0.11	0.53	0.16	0.44	39.55	12:06:29		
10740	0.02	0.05	0.02	-0.03	0.02	0.03	1.27	5.57	0.15	0.33	0.17	0.15	0.53	0.16	0.44	39.55	12:07:29		
10800	0.00	0.05	0.01	-0.03	-0.01	0.02	1.18	6.18	0.15	0.35	0.19	0.19	0.53	0.16	0.52	39.52	12:08:29		
10860	0.01	0.05	0.02	-0.03	0.02	0.02	1.31	6.45	0.17	0.37	0.21	0.19	0.57	0.16	0.44	39.71	12:09:29		
10920	0.01	0.05	0.02	-0.03	0.03	0.02	1.25	6.07	0.15	0.37	0.19	0.19	0.57	0.20	0.44	39.79	12:10:29		
10980	0.00	0.05	0.02	-0.03	0.01	0.00	1.33	6.25	0.17	0.37	0.21	0.19	0.57	0.16	0.52	39.90	12:11:29		
11040	0.01	0.05	0.01	-0.03	0.00	0.00	1.31	5.56	0.17	0.37	0.21	0.19	0.53	0.16	0.56	39.76	12:12:29		
11100	-0.01	0.06	0.02	-0.03	-0.02	0.01	1.36	5.94	0.19	0.39	0.21	0.19	0.57	0.16	0.44	39.74	12:13:29		
11160	-0.01	0.06	0.02	-0.03	-0.05	0.00	1.31	5.45	0.19	0.44	0.19	0.15	0.53	0.16	0.52	39.95	12:14:29		
11220	-0.01	0.06	0.02	-0.03	-0.03	0.00	1.27	5.76	0.19	0.58	0.21	0.23	0.57	0.16	0.63	39.82	12:15:29		
11280	-0.01	0.05	0.01	-0.03	-0.04	0.01	1.23	5.63	0.19	0.60	0.23	0.19	0.53	0.16	0.63	39.66	12:16:29		
11340	-0.01	0.05	0.02	-0.03	0.06	0.02	1.29	5.54	0.19	0.64	0.21	0.19	0.53	0.16	0.44	39.55	12:17:29		
11400	0.00	0.07	0.04	-0.03	0.13	0.07	1.27	5.74	0.15	0.66	0.21	0.15	0.50	0.16	0.52	39.60	12:18:29		
11460	0.00	0.05	0.01	-0.03	0.03	0.00	1.29	6.01	0.19	0.66	0.21	0.15	0.53	0.20	0.56	39.74	12:19:29		
11520	0.03	0.06	0.03	-0.03	0.06	0.03	1.33	5.57	0.15	0.62	0.21	0.15	0.53	0.16	0.52	39.60	12:20:29		
11580	0.04	0.05	0.02	-0.03	0.06	0.04	1.23	6.86	0.19	0.66	0.21	0.15	0.53	0.16	0.60	39.68	12:21:29		
11640	0.02	0.06	0.03	-0.03	0.00	0.02	1.33	5.39	0.15	0.60	0.19	0.19	0.60	0.16	0.56	39.90	12:22:29		
11700	0.00	0.06	0.02	-0.03	0.01	0.03	1.29	4.64	0.15	0.60	0.21	0.19	0.60	0.20	0.60	39.77	12:23:29		
11760	-0.01	0.06	0.02	-0.03	0.00	0.01	1.38	5.54	0.19	0.64	0.21	0.15	0.57	0.20	0.52	39.71	12:24:29		
11820	-0.01	0.05	0.02	-0.03	-0.01	0.02	1.31	6.05	0.17	0.62	0.21	0.19	0.60	0.24	0.60	39.95	12:25:29		
11880	0.01	0.06	0.01	-0.03	0.06	0.00	1.34	5.30	0.15	0.60	0.19	0.19	0.57	0.20	0.56	39.93	12:26:29		
11940	0.03	0.06	0.02	-0.03	0.05	0.00	1.33	6.38	0.17	0.62	0.23	0.15	0.57	0.20	0.52	39.87	12:27:29		
12000	0.03	0.06	0.02	-0.03	0.02	0.02	1.29	4.93	0.17	0.60	0.19	0.19	0.60	0.20	0.52	39.76	12:28:29		
12060	0.02	0.04	0.01	-0.03	0.05	0.02	1.23	5.72	0.17	0.60	0.21	0.19	0.57	0.24	0.56	39.66	12:29:29		
12120	0.02	0.06	0.02	-0.03	0.05	0.00	1.36	5.24	0.17	0.56	0.21	0.19	0.57	0.12	0.48	40.06	12:30:29		
12180	0.02	0.06	0.02	-0.03	0.00	0.03	1.33	6.14	0.15	0.56	0.21	0.19	0.60	0.24	0.48	39.77	12:31:29		
12240	0.02	0.06	0.02	-0.03	0.01	0.01	1.34	5.81	0.17	0.54	0.21	0.15	0.60	0.20	0.52	39.74	12:32:29		
12300	0.02	0.06	0.03	-0.03	0.01	0.02	1.29	6.01	0.17	0.54	0.21	0.19	0.57	0.20	0.60	39.68	12:33:29		
12360	0.03	0.05	0.02	-0.03	0.07	0.02	1.29	5.17	0.15	0.50	0.21	0.15	0.57	0.16	0.52	39.95	12:34:29		
12420	0.02	0.06	0.02	-0.03	0.03	0.00	1.38	5.21	0.17	0.50	0.21	0.19	0.60	0.20	0.56	39.63	12:35:29		
12480	0.02	0.05	0.02	-0.03	0.02	0.03	1.27	6.01	0.15	0.50	0.19	0.19	0.60	0.20	0.56	39.50	12:36:29		
12540	0.02	0.06	0.03	-0.03	0.01	0.01	1.25	5.83	0.15	0.50	0.19	0.15	0.57	0.20	0.56	39.44	12:37:29		
12600	0.04	0.06	0.03	-0.03	0.05	0.03	1.25	6.32	0.17	0.46	0.23	0.23	0.60	0.16	0.60	38.65	12:38:29		
12660	0.03	0.06	0.02	-0.03	0.03	0.01	1.29	5.61	0.17	0.46	0.21	0.19	0.53	0.20	0.52	39.22	12:39:29		
12720	0.03	0.05	0.01	-0.03	0.04	0.02	1.31	5.39	0.17	0.46	0.21	0.19	0.57	0.16	0.56	39.50	12:40:29		
12780	0.03	0.06	0.02	-0.03	-0.03	0.01	1.36	5.61	0.17	0.46	0.19	0.15	0.57	0.16	0.56	39.47	12:41:29		
12840	0.01	0.05	0.01	-0.03	0.01	0.01	1.29	6.18	0.19	0.46	0.21	0.19	0.57	0.20	0.60	39.36	12:42:29		
12900	0.03	0.05	0.02	-0.03	0.07	0.02	1.44	5.65	0.17	0.44	0.21	0.19	0.53	0.16	0.48	39.36	12:43:29		
12960	0.01	0.05	0.01	-0.03	0.01	0.02	1.27	5.45	0.17	0.39	0.19	0.19	0.53	0.16	0.52	39.00	12:44:29		
13020	0.02	0.05	0.02	-0.03	0.03	0.02	1.33	5.56	0.17	0.44	0.21	0.15	0.57	0.16	0.56	39.17	12:45:29		
13080	0.00	0.06	0.02	-0.03	-0.01	0.01	1.20	6.07	0.17	0.44	0.21	0.19	0.60	0.20	0.60	39.20	12:46:29		
13140	0.01	0.05	0.02	-0.03	0.05	0.02	1.34	5.37	0.17	0.39	0.21	0.19	0.60	0.20	0.60	39.20	12:47:29		
13200	0.01	0.05	0.02	-0.03	0.05	0.03	1.29	5.70	0.17	0.44	0.21	0.19	0.57	0.20	0.63	39.33	12:48:29		
13260	0.02	0.05	0.02	-0.03	0.04	0.01	1.33	6.05	0.17	0.46	0.21	0.15	0.53	0.16	0.56	39.41	12:49:29		
13320	0.02	0.06	0.03	-0.03	0.01	0.03	1.27	6.20	0.17	0.46	0.21	0.19	0.57	0.20	0.48	39.33	12:50:29		

DAPL DATA LOG		XOM-Buffalo, NY Terminal 10/22/03 9:08:29 TPE				XWell:LF-6 Test 2														
elapsed time (sec)	VERMW-3 Vac Resp (in WC)	VERMW-4 Vac Resp (in WC)	VERMW-2 Vac Resp (in WC)	VERMW-1 Vac Resp (in WC)	MW-28 Vac Resp (in WC)	MW-3URS Vac Resp (in WC)	Well Vacuum (inHg)	Straw Vacuum (inHg)	VERMW-3 GW DD (feet)	VERMW-4 GW DD (feet)	VERMW-2 GW DD (feet)	VERMW-1 GW DD (feet)	MW-28 GW DD (feet)	MW-3URS GW DD (feet)	LF-6 GW DD (feet)	HighVac AirFlow (scfm)	Time	Notes		
13380	0.02	0.07	0.03	-0.03	0.05	0.02	1.20	4.99	0.19	0.46	0.23	0.19	0.57	0.20	0.63	40.75	12:51:29			
13500	0.04	0.07	0.03	-0.03	0.03	0.02	1.58	5.06	0.19	0.46	0.21	0.19	0.53	0.20	0.52	42.49	12:53:29	raised drop tube		
13560	0.03	0.06	0.02	-0.03	0.06	0.00	1.58	5.08	0.19	0.44	0.21	0.19	0.57	0.16	0.40	42.37	12:54:29	another 6 inches		
13620	0.03	0.07	0.03	-0.03	0.03	0.02	1.58	5.34	0.17	0.46	0.23	0.19	0.57	0.20	0.48	42.32	12:55:29			
13680	0.03	0.07	0.03	-0.03	0.02	0.02	1.62	4.84	0.19	0.44	0.21	0.19	0.57	0.20	0.48	42.47	12:56:29			
13740	0.03	0.07	0.03	-0.03	0.01	0.02	1.64	4.58	0.19	0.44	0.21	0.15	0.57	0.24	0.48	42.39	12:57:29			
13800	0.03	0.07	0.03	-0.03	0.03	0.02	1.56	5.08	0.19	0.39	0.21	0.19	0.57	0.20	0.56	42.39	12:58:29			
13860	0.05	0.07	0.03	-0.03	0.06	0.02	1.56	4.24	0.19	0.44	0.23	0.19	0.57	0.16	0.52	42.22	12:59:29			
13920	0.05	0.06	0.02	-0.03	0.05	0.02	1.60	5.43	0.17	0.37	0.23	0.19	0.53	0.20	0.56	42.52	13:00:29			
13980	0.04	0.06	0.02	-0.03	0.03	0.02	1.66	5.23	0.17	0.39	0.23	0.19	0.60	0.24	0.56	42.65	13:01:29			
14040	0.05	0.09	0.05	-0.03	0.04	0.03	1.55	5.70	0.19	0.35	0.23	0.19	0.57	0.20	0.48	42.37	13:02:29			
14100	0.03	0.07	0.03	-0.03	0.01	0.02	1.60	5.19	0.19	0.35	0.26	0.19	0.53	0.16	0.52	42.55	13:03:29			
14160	0.03	0.07	0.03	-0.03	0.02	0.03	1.58	5.15	0.19	0.39	0.26	0.19	0.57	0.20	0.56	42.44	13:04:29			
14220	0.02	0.07	0.03	-0.03	0.01	0.02	1.60	5.10	0.19	0.37	0.21	0.19	0.57	0.20	0.48	42.49	13:05:29			
14280	0.02	0.07	0.04	-0.03	0.03	0.02	1.55	5.12	0.19	0.35	0.23	0.23	0.57	0.24	0.60	42.22	13:06:29			
14340	0.02	0.07	0.03	-0.03	0.01	0.02	1.58	5.81	0.20	0.39	0.26	0.23	0.57	0.24	0.52	42.47	13:07:29			
14400	0.01	0.07	0.03	-0.03	0.01	0.02	1.66	4.88	0.20	0.39	0.23	0.19	0.57	0.24	0.56	42.34	13:08:29			
14460	0.01	0.07	0.03	-0.03	0.01	0.01	1.58	4.99	0.20	0.44	0.21	0.23	0.57	0.24	0.44	42.37	13:09:29			
14520	0.01	0.07	0.02	-0.03	0.00	0.02	1.62	5.59	0.22	0.44	0.23	0.23	0.57	0.20	0.56	42.29	13:10:29			
14580	0.01	0.06	0.02	-0.03	0.05	0.02	1.58	5.13	0.19	0.39	0.23	0.19	0.57	0.16	0.56	42.06	13:11:29			
14640	0.02	0.06	0.02	-0.03	0.04	0.02	1.62	4.99	0.19	0.39	0.23	0.23	0.60	0.20	0.52	41.99	13:12:29			
14700	0.00	0.07	0.03	-0.03	0.01	0.03	1.66	4.82	0.22	0.44	0.26	0.19	0.57	0.20	0.63	42.17	13:13:29			
14760	0.02	0.08	0.04	-0.03	0.04	0.03	1.64	4.79	0.19	0.37	0.26	0.23	0.60	0.20	0.56	42.17	13:14:29			
14820	-0.01	0.08	0.05	-0.03	-0.08	0.03	1.62	5.23	0.20	0.48	0.26	0.19	0.57	0.20	0.56	42.47	13:15:29			
14880	-0.01	0.08	0.04	-0.03	0.00	0.03	1.64	4.73	0.20	0.52	0.26	0.23	0.57	0.24	0.56	42.55	13:16:29			
14940	0.02	0.07	0.04	-0.03	0.11	0.04	1.64	5.06	0.20	0.52	0.26	0.19	0.57	0.16	0.56	42.44	13:17:29			
15000	0.05	0.06	0.01	-0.03	0.06	0.01	1.62	4.91	0.20	0.46	0.26	0.19	0.57	0.24	0.56	42.24	13:18:29			
15060	0.06	0.06	0.02	-0.03	0.05	0.01	1.62	5.48	0.20	0.48	0.26	0.19	0.57	0.20	0.60	42.49	13:19:29			
15120	0.07	0.08	0.04	-0.03	0.06	0.03	1.69	4.71	0.22	0.46	0.26	0.23	0.57	0.28	0.52	42.19	13:20:29			
15180	0.05	0.08	0.05	-0.03	0.05	0.03	1.69	4.57	0.22	0.44	0.26	0.19	0.57	0.20	0.60	42.22	13:21:29			
15240	0.05	0.07	0.03	-0.03	0.06	0.02	1.64	4.93	0.22	0.44	0.23	0.19	0.57	0.20	0.60	42.44	13:22:29			
15300	0.05	0.07	0.03	-0.03	0.03	0.02	1.69	4.73	0.22	0.37	0.28	0.23	0.57	0.20	0.52	42.34	13:23:29			
15360	0.06	0.07	0.03	-0.03	0.06	0.02	1.60	4.53	0.24	0.35	0.28	0.23	0.57	0.20	0.56	42.29	13:24:29			
15420	0.05	0.07	0.04	-0.03	0.02	0.03	1.60	4.71	0.20	0.31	0.28	0.23	0.63	0.20	0.60	42.24	13:25:29			
15480	0.01	0.07	0.03	-0.03	0.01	0.02	1.58	5.26	0.24	0.29	0.28	0.26	0.60	0.28	0.63	42.37	13:26:29			
15540	0.02	0.08	0.04	-0.03	0.03	0.02	1.60	5.28	0.24	0.33	0.30	0.26	0.60	0.24	0.67	42.14	13:27:29			
15600	0.03	0.07	0.03	-0.03	0.04	0.03	1.64	4.69	0.22	0.29	0.30	0.26	0.63	0.28	0.60	42.55	13:28:29			
15660	0.02	0.07	0.03	-0.03	0.01	0.02	1.62	5.02	0.24	0.29	0.26	0.26	0.57	0.24	0.52	42.04	13:29:29			
15720	0.03	0.06	0.02	-0.03	0.01	0.01	1.64	5.04	0.22	0.35	0.28	0.26	0.63	0.28	0.56	42.14	13:30:29			
15780	0.02	0.07	0.03	-0.03	0.01	0.02	1.62	5.02	0.22	0.33	0.28	0.26	0.66	0.24	0.63	42.27	13:31:29			
15840	0.03	0.06	0.02	-0.03	0.03	0.00	1.58	5.48	0.24	0.35	0.30	0.23	0.57	0.28	0.60	41.99	13:32:29			
15900	0.04	0.07	0.03	-0.03	0.03	0.00	1.66	4.95	0.26	0.37	0.30	0.23	0.60	0.24	0.63	42.49	13:33:29			
15960	0.03	0.07	0.03	-0.03	0.02	0.00	1.58	5.23	0.24	0.33	0.30	0.23	0.60	0.28	0.67	41.96	13:34:29			
16020	0.04	0.07	0.03	-0.03	0.05	0.02	1.64	4.80	0.24	0.39	0.30	0.23	0.60	0.28	0.63	42.12	13:35:29			
16080	0.03	0.07	0.03	-0.03	0.04	0.02	1.60	5.15	0.24	0.39	0.28	0.23	0.63	0.24	0.63	42.04	13:36:29			
16140	0.03	0.07	0.03	-0.03	0.01	0.03	1.62	5.59	0.24	0.35	0.30	0.26	0.63	0.24	0.60	42.12	13:37:29			
16200	0.01	0.08	0.03	-0.03	0.03	0.02	1.66	4.90	0.24	0.35	0.28	0.23	0.66	0.28	0.60	42.14	13:38:29			
16260	0.01	0.08	0.03	-0.03	0.02	0.02	1.56	5.39	0.26	0.39	0.32	0.30	0.63	0.24	0.67	40.96	13:39:29			
16320	0.01	0.07	0.03	-0.03	0.00	0.02	1.66	5.17	0.24	0.35	0.30	0.23	0.63	0.24	0.67	41.50	13:40:29			
16380	-0.01	0.09	0.04	-0.03	-0.09	0.02	1.66	4.49	0.26	0.39	0.30	0.26	0.66	0.28	0.60	41.78	13:41:29			
16440	-0.01	0.06	0.02	-0.03	-0.05	0.03	1.58	4.90	0.26	0.44	0.28	0.23	0.63	0.28	0.56	41.53	13:42:29			
16560	0.01	0.04	0.00	-0.03	0.05	0.03	0.59	6.87	0.22	0.44	0.30	0.23	0.63	0.20	0.67	38.31	13:44:29	dropped TPE tube to 7" below intial tube length		

DAPL DATA LOG		XOM-Buffalo, NY Terminal 10/22/03 9:08:29 TPE				XWell:LF-6 Test 2												
elapsed time (sec)	VERMW-3 Vac Resp (in WC)	VERMW-4 Vac Resp (in WC)	VERMW-2 Vac Resp (in WC)	VERMW-1 Vac Resp (in WC)	MW-28 Vac Resp (in WC)	MW-3URS Vac Resp (in WC)	Well Vacuum (inHg)	Straw Vacuum (inHg)	VERMW-3 GW DD (feet)	VERMW-4 GW DD (feet)	VERMW-2 GW DD (feet)	VERMW-1 GW DD (feet)	MW-28 GW DD (feet)	MW-3URS GW DD (feet)	LF-6 GW DD (feet)	HighVac AirFlow (scfm)	Time	Notes
16680	0.06	0.02	-0.01	-0.03	0.04	0.00	0.63	8.50	0.24	0.46	0.32	0.23	0.63	0.28	0.67	31.31	13:46:29	
16740	0.04	0.03	0.00	-0.03	0.02	0.03	0.67	8.01	0.24	0.46	0.32	0.26	0.63	0.24	0.67	31.31	13:47:29	
16800	0.05	0.02	0.00	-0.03	0.04	0.01	0.70	7.46	0.24	0.39	0.32	0.23	0.63	0.28	0.79	31.38	13:48:29	
16860	0.04	0.03	0.00	-0.03	0.03	0.02	0.63	8.43	0.26	0.44	0.30	0.26	0.63	0.28	0.67	31.24	13:49:29	
16920	0.02	0.02	-0.01	-0.03	0.01	0.03	0.70	8.50	0.24	0.44	0.30	0.23	0.63	0.24	0.63	31.34	13:50:29	
16980	0.03	0.03	0.00	-0.03	0.05	0.02	0.61	7.66	0.22	0.39	0.30	0.26	0.63	0.20	0.63	30.76	13:51:29	
17040	0.02	0.03	0.00	-0.03	0.05	0.02	0.59	8.49	0.22	0.39	0.30	0.26	0.66	0.24	0.67	30.65	13:52:29	
17100	0.02	0.03	0.00	-0.03	0.01	0.03	0.70	7.94	0.22	0.35	0.30	0.26	0.63	0.28	0.67	30.55	13:53:29	
17160	0.02	0.03	0.00	-0.03	0.03	0.02	0.61	7.24	0.22	0.33	0.28	0.23	0.63	0.24	0.67	30.62	13:54:29	
17220	0.01	0.03	0.00	-0.03	0.00	0.02	0.63	8.92	0.20	0.33	0.28	0.23	0.63	0.28	0.63	31.07	13:55:29	
17280	0.02	0.02	-0.01	-0.03	0.00	0.02	0.57	8.01	0.22	0.33	0.26	0.19	0.60	0.24	0.63	30.72	13:56:29	
17340	0.01	0.03	0.00	-0.03	0.03	0.02	0.68	7.19	0.20	0.39	0.28	0.26	0.63	0.20	0.63	31.07	13:57:29	
17400	0.01	0.02	-0.01	-0.03	0.03	0.03	0.65	7.00	0.19	0.35	0.23	0.19	0.63	0.24	0.63	30.97	13:58:29	
17460	0.01	0.02	-0.02	-0.03	0.00	0.00	0.56	7.73	0.19	0.35	0.26	0.19	0.63	0.20	0.60	30.76	13:59:29	
17520	0.00	0.02	0.00	-0.03	0.01	0.03	0.57	8.28	0.17	0.31	0.23	0.23	0.63	0.20	0.63	30.93	14:00:29	
17580	0.00	0.02	-0.02	-0.03	0.02	0.02	0.50	8.16	0.20	0.35	0.21	0.19	0.63	0.20	0.56	30.30	14:01:29	
17640	0.01	0.02	-0.01	-0.03	0.04	0.02	0.59	8.25	0.19	0.39	0.26	0.23	0.60	0.20	0.67	30.30	14:02:29	
17700	0.01	0.02	-0.01	-0.03	0.03	0.00	0.56	6.87	0.17	0.39	0.23	0.19	0.60	0.16	0.60	30.13	14:03:29	
17760	0.02	0.02	-0.01	-0.03	0.06	-0.01	0.59	7.95	0.19	0.39	0.26	0.19	0.60	0.16	0.63	30.62	14:04:29	
17820	0.04	0.02	-0.01	-0.03	0.08	0.00	0.57	8.19	0.17	0.37	0.21	0.15	0.60	0.16	0.63	30.97	14:05:29	
17880	0.05	0.02	0.00	-0.03	0.05	0.02	0.61	7.55	0.15	0.35	0.23	0.23	0.66	0.20	0.60	30.65	14:06:29	
17940	0.03	0.02	-0.01	-0.03	0.01	0.03	0.56	8.03	0.15	0.35	0.21	0.19	0.63	0.20	0.60	30.79	14:07:29	
18000	0.04	0.04	0.01	-0.03	0.06	0.03	0.59	7.08	0.17	0.35	0.21	0.15	0.63	0.16	0.63	30.79	14:08:29	
18060	0.04	0.04	0.01	-0.03	0.03	0.03	0.48	7.84	0.15	0.35	0.21	0.19	0.63	0.20	0.56	30.41	14:09:29	
18120	0.03	0.02	-0.01	-0.03	0.04	0.01	0.50	7.97	0.17	0.33	0.21	0.15	0.63	0.20	0.52	30.72	14:10:29	
18180	0.03	0.03	0.01	-0.03	0.01	0.02	0.61	6.47	0.15	0.31	0.19	0.15	0.60	0.20	0.56	30.97	14:11:29	
18240	0.02	0.02	-0.01	-0.03	0.03	0.01	0.54	8.63	0.15	0.31	0.19	0.15	0.60	0.12	0.60	30.41	14:12:29	
18300	0.01	0.02	-0.01	-0.03	0.01	0.01	0.54	8.85	0.19	0.29	0.19	0.19	0.60	0.20	0.60	30.20	14:13:29	
18360	-0.01	0.03	-0.01	-0.03	0.00	0.01	0.52	7.97	0.17	0.31	0.21	0.19	0.60	0.20	0.52	30.44	14:14:29	
18420	-0.01	0.02	-0.01	-0.03	-0.01	0.02	0.56	8.16	0.15	0.31	0.19	0.15	0.66	0.16	0.60	30.65	14:15:29	
18480	0.01	0.03	0.00	-0.03	0.01	0.01	0.54	8.76	0.17	0.31	0.19	0.15	0.63	0.16	0.52	30.55	14:16:29	
18540	0.01	0.03	0.00	-0.03	0.04	0.01	0.48	9.05	0.15	0.33	0.19	0.19	0.63	0.20	0.52	30.65	14:17:29	
18600	0.02	0.04	0.01	-0.03	0.06	0.02	0.59	7.88	0.15	0.27	0.19	0.11	0.63	0.12	0.48	30.69	14:18:29	
18660	0.02	0.03	0.01	-0.03	0.01	0.02	0.54	7.84	0.15	0.33	0.19	0.15	0.63	0.12	0.56	30.48	14:19:29	
18720	0.01	0.02	-0.01	-0.03	0.01	0.00	0.54	8.08	0.15	0.33	0.19	0.15	0.66	0.16	0.60	31.14	14:20:29	
18780	0.01	0.02	-0.01	-0.03	0.05	0.00	0.52	8.17	0.15	0.33	0.19	0.19	0.63	0.12	0.63	30.97	14:21:29	
18840	0.01	0.01	-0.01	-0.03	0.03	0.02	0.56	9.05	0.13	0.33	0.21	0.15	0.60	0.16	0.63	31.00	14:22:29	
18900	0.00	0.03	0.00	-0.03	0.00	0.03	0.52	8.65	0.17	0.35	0.19	0.15	0.66	0.12	0.52	29.95	14:23:29	
18960	0.01	0.02	-0.01	-0.03	0.02	0.02	0.61	8.27	0.15	0.35	0.21	0.15	0.63	0.12	0.60	30.16	14:24:29	
19020	0.01	0.02	-0.01	-0.03	0.00	0.02	0.59	7.81	0.15	0.37	0.19	0.19	0.63	0.16	0.67	29.81	14:25:29	
19080	-0.01	0.02	0.00	-0.03	0.00	0.02	0.57	7.44	0.15	0.35	0.17	0.15	0.60	0.16	0.60	32.02	14:26:29	
19140	0.03	0.03	0.00	-0.03	0.06	0.01	0.50	8.16	0.15	0.37	0.17	0.15	0.60	0.16	0.52	32.09	14:27:29	
19200	0.04	0.02	-0.01	-0.03	0.04	0.01	0.50	6.40	0.15	0.35	0.19	0.15	0.63	0.12	0.60	31.92	14:28:29	
19260	0.04	0.01	-0.02	-0.03	0.03	0.01	0.52	6.71	0.11	0.29	0.17	0.19	0.63	0.16	0.60	31.68	14:29:29	
19320	0.04	0.03	0.00	-0.03	0.05	0.03	0.54	8.83	0.13	0.35	0.21	0.15	0.63	0.20	0.56	32.32	14:30:29	
19380	0.05	0.04	0.01	-0.03	0.06	0.04	0.61	7.26	0.15	0.33	0.17	0.11	0.63	0.16	0.56	31.95	14:31:29	
19440	0.05	0.03	0.00	-0.03	0.04	0.02	0.52	6.91	0.13	0.31	0.19	0.15	0.60	0.16	0.56	31.78	14:32:29	
19500	0.03	0.04	0.01	-0.03	0.05	0.03	0.48	7.72	0.15	0.33	0.21	0.15	0.66	0.16	0.60	31.92	14:33:29	
19560	0.04	0.03	-0.01	-0.03	0.06	0.02	0.48	7.22	0.13	0.35	0.19	0.19	0.63	0.16	0.52	31.55	14:34:29	
19620	0.03	0.02	-0.01	-0.03	0.05	0.02	0.52	8.32	0.15	0.29	0.21	0.19	0.63	0.24	0.60	31.34	14:35:29	
19680	0.03	0.02	-0.01	-0.03	0.02	0.02	0.54	7.31	0.15	0.29	0.19	0.19	0.60	0.16	0.60	31.31	14:36:29	
19740	0.02	0.02	-0.02	-0.03	0.02	0.00	0.48	7.99	0.17	0.33	0.21	0.19	0.66	0.16	0.52	31.41	14:37:29	lowered drop tube to 27 ft 6 in btc
19800	0.02	0.02	-0.01	-0.03	0.04	0.00	0.39	8.25	0.17	0.33	0.21	0.19	0.63	0.16	0.48	31.85	14:38:29	
19860	0.02	0.01	-0.02	-0.03	0.03	0.02	0.37	9.62	0.15	0.33	0.19	0.15	0.63	0.16	0.52	29.23	14:39:29	

DAPL DATA LOG	XOM-Buffalo,NY Terminal						XWell:LF-6													
	10/22/03 9:08:29 TPE						Test 2													
elapsed time (sec)	VERMW-3 Vac Resp (in WC)	VERMW-4 Vac Resp (in WC)	VERMW-2 Vac Resp (in WC)	VERMW-1 Vac Resp (in WC)	MW-28 Vac Resp (in WC)	MW-3URS Vac Resp (in WC)	Well Vacuum (inHg)	Straw Vacuum (inHg)	VERMW-3 GW DD (feet)	VERMW-4 GW DD (feet)	VERMW-2 GW DD (feet)	VERMW-1 GW DD (feet)	MW-28 GW DD (feet)	MW-3URS GW DD (feet)	LF-6 GW DD (feet)	HighVac AirFlow (scfm)	Time	Notes		
19920	0.00	0.01	-0.02	-0.03	-0.04	0.00	0.36	9.68	0.17	0.31	0.19	0.19	0.60	0.16	0.52	29.08	14:40:29			
19980	-0.01	0.01	-0.02	-0.03	-0.06	-0.02	0.36	9.55	0.17	0.33	0.21	0.19	0.60	0.16	0.56	29.12	14:41:29			
20040	-0.01	0.01	-0.01	-0.03	0.02	0.00	0.37	9.62	0.17	0.33	0.19	0.19	0.63	0.20	0.60	28.75	14:42:29			
20100	0.01	0.01	-0.02	-0.03	0.05	0.02	0.37	9.69	0.17	0.35	0.21	0.19	0.60	0.16	0.52	28.56	14:43:29			
20160	0.03	0.01	-0.01	-0.03	0.09	0.02	0.36	9.58	0.19	0.33	0.21	0.23	0.63	0.20	0.56	28.67	14:44:29	End TPE at LF-6		
20280	0.01	0.01	-0.02	-0.03	0.04	0.00	0.36	0.37	0.17	0.31	0.21	0.19	0.63	0.16	0.56	54.04	14:46:29			
20340	0.02	0.01	-0.02	-0.03	0.03	0.02	0.36	0.37	0.19	0.33	0.23	0.19	0.60	0.20		54.14	14:47:29			
20400	0.02	0.01	-0.01	-0.03	0.05	0.01	0.37	0.39	0.19	0.35	0.23	0.19	0.60	0.16		54.10	14:48:29			
20460	0.04	0.01	-0.02	-0.03	0.05	0.01	0.36	0.37	0.19	0.35	0.26	0.23	0.60	0.20		54.20	14:49:29			
20520	0.03	0.00	-0.03	-0.03	0.03	0.00	0.37	0.36	0.19	0.35	0.26	0.23	0.63	0.24		54.12	14:50:29			
20580	0.04	0.01	-0.02	-0.03	0.05	0.00	0.36	0.36	0.19	0.33	0.26	0.23	0.63	0.24		54.18	14:51:29			
20640	0.02	0.02	-0.01	-0.03	0.04	0.02	0.37	0.36	0.20	0.35	0.23	0.19	0.60	0.24		54.02	14:52:29			
20700	0.04	0.01	-0.01	-0.03	0.06	0.01	0.37	0.36	0.20	0.33	0.26	0.23	0.60	0.24		54.25	14:53:29			
20760	0.04	0.01	-0.01	-0.03	0.03	0.02	0.37	0.36	0.22	0.29	0.26	0.26	0.63	0.28		54.29	14:54:29			
20820	0.03	0.01	-0.01	-0.03	0.03	0.02	0.37	0.36	0.20	0.29	0.30	0.23	0.60	0.28		54.20	14:55:29			
20880	0.04	0.00	-0.02	-0.03	0.03	0.00	0.36	0.37	0.24	0.29	0.38	0.23	0.60	0.28		54.33	14:56:29			
20940	0.03	0.01	-0.03	-0.03	0.02	0.00	0.36	0.36	0.24	0.25	0.34	0.64	0.60	0.24		54.25	14:57:29			
21000	0.02	0.01	-0.01	-0.03	0.03	0.02	0.37	0.36	0.24	0.31	0.34	-0.04	0.63	0.28		54.25	14:58:29			
21060	0.02	0.01	-0.02	-0.03	0.03	0.02	0.36	0.36	0.24	0.31	0.36	-0.11	0.63	0.24		54.16	14:59:29			
21120	0.02	0.01	-0.01	-0.03	0.03	0.02	0.36	0.36	0.24	0.25	0.36	-0.11	0.63	0.28		54.21	15:00:29			
21180	-0.01	0.01	-0.02	-0.03	-0.01	0.01	0.36	0.34	0.26	0.25	0.38	-0.04	0.63	0.24		54.25	15:01:29			
21240	-0.01	0.01	-0.02	-0.03	0.00	0.02	0.36	0.34	0.26	0.25	0.36	-0.11	0.66	0.48		54.18	15:02:29			
21300	-0.01	0.00	-0.02	-0.03	-0.03	0.01	0.37	0.34	0.26	0.27	0.36	0.00	0.63	0.24		54.18	15:03:29			
21360	-0.01	0.01	-0.01	-0.03	0.01	0.02	0.36	0.34	0.62	0.31	0.38	-0.04	0.69	0.32		54.25	15:04:29			
21420	-0.01	0.01	-0.02	-0.03	-0.02	0.00	0.36	0.34	0.02	0.29	0.38	0.00	0.69	0.28		54.16	15:05:29			
21480	-0.01	0.01	-0.03	-0.03	0.00	-0.03	0.36	0.36	0.02	0.33	0.38	0.00	0.69	0.24		54.39	15:06:29			
21540	0.01	0.02	-0.01	-0.03	0.04	0.02	0.36	0.36	0.04	0.35	0.36	0.00	0.66	0.28		54.31	15:07:29			
21600	0.03	0.01	-0.02	-0.03	0.05	-0.01	0.36	0.36	0.02	0.33	0.36	0.00	1.35	0.28		54.29	15:08:29			
21660	0.03	0.01	-0.02	-0.03	0.06	0.02	0.37	0.36	0.02	0.33	0.36	-0.04	0.93	0.28		54.35	15:09:29			
21720	0.02	0.00	-0.03	-0.03	0.03	0.00	0.36	0.36	0.02	0.31	0.38	0.00	0.90	0.32		54.43	15:10:29			
21780	0.02	0.01	-0.02	-0.03	0.01	0.00	0.36	0.37	0.04	0.35	0.38	0.00	0.90	0.28		54.35	15:11:29			
21840	0.03	0.02	-0.01	-0.03	0.01	0.00	0.37	0.34	0.02	0.44	0.38	0.00	0.90	0.32		54.43	15:12:29			
21900	0.02	0.02	-0.01	-0.03	0.02	0.03	0.36	0.36	0.04	0.37	0.38	0.00	0.90	0.32		54.33	15:13:29			
21960	0.02	0.01	-0.01	-0.03	0.06	0.03	0.36	0.36	0.06	0.33	0.38	0.00	0.90	0.28		54.29	15:14:29			
22020	0.03	0.01	-0.01	-0.03	0.05	0.02	0.37	0.36	0.04	0.35	0.38	0.00	0.93	0.28	-0.24	54.41	15:15:29			
22080	0.04	0.01	-0.01	-0.03	0.05	0.02	0.37	0.37	0.04	0.33	0.38	0.04	0.90	0.28	-0.24	54.25	15:16:29			
22140	0.03	0.01	-0.01	-0.03	0.01	0.00	0.36	0.36	0.06	0.33	0.38	0.04	0.87	0.28	1.64	54.33	15:17:29			
22200	0.03	0.02	-0.01	-0.03	0.01	0.03	0.37	0.36	0.04	0.33	0.40	0.00	0.87	0.32	1.64	54.53	15:18:29			
22260	0.03	0.01	-0.01	-0.03	0.02	0.01	0.37	0.36	0.04	0.33	0.40	0.04	0.90	0.36	1.68	54.51	15:19:29			
22320	0.02	0.01	-0.02	-0.03	0.03	0.03	0.36	0.36	0.04	0.31	0.40	0.04	0.90	0.32	1.64	54.45	15:20:29			
22380	0.02	0.01	-0.01	-0.03	0.04	0.00	0.37	0.36	0.06	0.35	0.40	0.04	0.87	0.32	1.68	54.41	15:21:29			
22440	0.02	0.05	0.02	-0.03	0.05	0.06	0.37	0.37	0.04	0.31	0.38	0.00	0.87	0.28	1.68	54.47	15:22:29			
22500	0.01	0.01	-0.01	-0.03	0.03	0.01	0.36	0.34	0.04	0.29	0.38	0.04	0.90	0.32	1.68	54.51	15:23:29			
22560	0.01	0.01	-0.02	-0.03	0.03	0.02	0.36	0.34	0.04	0.29	0.38	0.00	0.90	0.28	1.72	54.55	15:24:29			
22620	0.01	0.08	0.05	-0.03	0.04	0.04	1.60	2.26	0.07	0.35	0.40	0.04	0.87	0.28	0.63	49.54	15:25:31	Begin Test with pneumatic pump		
22680	0.00	0.08	0.05	-0.03	0.02	0.03	1.60	2.33	0.07	0.37	0.44	0.04	0.87	0.32	0.67	49.45	15:26:29			
22740	-0.01	0.08	0.04	-0.03	0.00	0.01	1.55	2.37	0.07	0.35	0.42	0.04	0.93	0.36	0.63	49.43	15:27:29			
22800	-0.01	0.02	0.00	-0.03	0.01	0.03	0.37	0.37	0.04	0.33	0.38	0.04	0.87	0.28	0.56	52.90	15:28:29	pause test to reset static water level @ LF 6		
22860	0.01	0.01	-0.02	-0.03	0.04	0.02	0.39	0.36	0.04	0.33	0.38	0.04	0.90	0.32	0.00	53.30	15:29:29	level reset		
22920	0.01	0.01	-0.02	-0.03	0.01	0.01	0.37	0.36	0.04	0.31	0.40	0.08	0.87	0.28	0.00	53.46	15:30:29			
22980	0.02	0.07	0.03	-0.03	0.04	0.02	1.58	2.31	0.06	0.35	0.42	0.04	0.87	0.32	0.04	50.46	15:31:29			

DAPL DATA LOG		XOM-Buffalo,NYTerminal					XWell:LF-6												
		10/22/03 9:08:29 TPE					Test 2												
elapsed time (sec)	VERMW-3 Vac Resp (in WC)	VERMW-4 Vac Resp (in WC)	VERMW-2 Vac Resp (in WC)	VERMW-1 Vac Resp (in WC)	MW-28 Vac Resp (in WC)	MW-3URS Vac Resp (in WC)	Well Vacuum (inHg)	Straw Vacuum (inHg)	VERMW-3 GW DD (feet)	VERMW-4 GW DD (feet)	VERMW-2 GW DD (feet)	VERMW-1 GW DD (feet)	MW-28 GW DD (feet)	MW-3URS GW DD (feet)	LF-6 GW DD (feet)	HighVac AirFlow (scfm)	Time	Notes	
23040	0.01	0.07	0.03	-0.03	0.04	0.02	1.55	2.20	0.06	0.37	0.42	0.04	0.90	0.32	0.07	50.33	15:32:29		
23100	0.03	0.08	0.04	-0.03	0.05	0.03	1.58	2.17	0.06	0.35	0.40	0.08	0.90	0.28	0.07	49.69	15:33:29		
23160	0.05	0.05	0.02	-0.03	0.06	0.02	0.78	1.23	0.06	0.33	0.38	0.08	0.90	0.32	-0.04	51.81	15:34:29		
23220	0.05	0.09	0.06	-0.03	0.05	0.03	2.06	2.90	0.07	0.44	0.42	0.04	0.90	0.32	0.07	49.67	15:35:29		
23280	0.04	0.11	0.09	-0.03	0.06	0.03	2.39	3.45	0.07	0.35	0.42	0.08	0.90	0.32	-0.08	49.21	15:36:29		
23340	0.05	0.13	0.09	-0.03	0.04	0.05	2.41	3.21	0.04	0.31	0.40	0.04	0.90	0.28	-0.08	48.80	15:37:29		
23400	0.04	0.10	0.07	-0.03	0.03	0.02	2.30	3.21	0.06	0.33	0.40	0.08	0.90	0.28	-0.04	48.86	15:38:29		
23460	0.04	0.12	0.09	-0.03	0.02	0.03	2.28	3.25	0.04	0.31	0.40	0.04	0.87	0.28	0.00	48.64	15:39:29		
23520	0.03	0.08	0.05	-0.03	0.03	0.03	2.09	2.74	0.04	0.25	0.40	0.04	0.87	0.28	0.07	49.88	15:40:29		
23580	0.02	0.10	0.08	-0.03	0.02	0.03	2.04	2.77	0.04	0.27	0.38	0.04	0.90	0.32	-0.04	49.56	15:41:29		
23640	0.03	0.09	0.06	-0.03	0.03	0.01	2.09	2.85	0.04	0.29	0.40	0.04	0.87	0.28	0.04	49.67	15:42:29		
23700	0.03	0.11	0.08	-0.03	0.05	0.05	2.11	2.86	0.04	0.33	0.38	0.04	0.87	0.28	0.04	49.69	15:43:29		
23760	0.04	0.11	0.08	-0.03	0.06	0.03	2.04	2.92	0.04	0.33	0.36	0.00	0.90	0.28	0.00	49.51	15:44:29		
23820	0.04	0.11	0.08	-0.03	0.04	0.03	1.98	2.64	0.04	0.29	0.38	0.04	0.87	0.32	0.04	49.17	15:45:29		
23880	0.04	0.13	0.08	-0.03	0.05	0.04	2.09	2.90	0.04	0.29	0.38	0.04	0.90	0.32	0.04	49.47	15:46:29		
23940	0.04	0.11	0.09	-0.03	0.05	0.05	2.13	3.08	0.04	0.31	0.38	0.04	0.87	0.32	-0.08	49.51	15:47:29		
24000	0.03	0.10	0.07	-0.03	0.04	0.04	2.11	2.74	0.00	0.25	0.38	0.00	0.87	0.28	0.04	49.45	15:48:29		
24060	0.04	0.11	0.08	-0.03	0.04	0.04	2.15	3.03	0.00	0.29	0.38	0.00	0.87	0.24	0.00	49.49	15:49:29		
24120	0.02	0.10	0.07	-0.03	0.03	0.03	2.00	2.97	0.02	0.29	0.36	0.00	0.87	0.24	-0.08	49.51	15:50:29		
24180	0.02	0.11	0.07	-0.03	0.05	0.04	2.13	2.94	0.00	0.27	0.34	0.04	0.81	0.24	0.00	49.32	15:51:29		
24240	0.01	0.10	0.06	-0.03	0.00	0.01	2.09	2.94	0.02	0.25	0.36	0.04	0.87	0.28	-0.04	49.79	15:52:29		
24300	0.01	0.09	0.07	-0.03	0.03	0.02	2.09	2.85	0.00	0.27	0.36	0.04	0.84	0.28	0.00	49.67	15:53:29		
24360	0.02	0.09	0.06	-0.03	0.03	0.02	1.56	2.20	-0.02	0.23	0.34	0.00	0.84	0.24	-0.04	50.48	15:54:29		
24420	0.01	0.10	0.07	-0.03	0.03	0.03	2.06	2.83	0.00	0.25	0.34	-0.04	0.84	0.20	0.00	49.60	15:55:29		
24480	0.02	0.11	0.08	-0.03	0.03	0.03	2.02	2.74	-0.02	0.25	0.34	0.00	0.81	0.24	0.00	49.86	15:56:29		
24540	0.00	0.10	0.08	-0.03	0.02	0.02	2.08	2.86	0.00	0.19	0.32	0.00	0.84	0.24	-0.04	50.07	15:57:29		
24600	0.02	0.10	0.08	-0.03	0.05	0.04	2.06	2.94	-0.02	0.21	0.34	0.00	0.81	0.20	-0.16	49.58	15:58:29		
24660	0.02	0.09	0.06	-0.03	0.05	0.02	2.08	2.86	-0.02	0.25	0.32	-0.04	0.81	0.20	0.04	49.36	15:59:29		
24720	0.03	0.10	0.08	-0.03	0.05	0.06	2.04	2.99	0.00	0.19	0.32	0.00	0.84	0.24	0.07	49.51	16:00:29		
24780	0.02	0.12	0.09	-0.03	0.02	0.05	2.02	2.85	-0.04	0.23	0.34	0.00	0.84	0.24	0.04	49.43	16:01:29		
24840	0.02	0.12	0.09	-0.03	0.03	0.05	2.11	2.99	-0.02	0.23	0.36	0.00	0.78	0.20	-0.04	49.54	16:02:29	stopped gw pump	
24900	0.02	0.09	0.06	-0.03	0.04	0.03	1.86	2.66	-0.07	0.17	0.30	-0.04	0.81	0.16	-0.04	49.77	16:03:29		
24960	0.01	0.09	0.07	-0.03	0.02	0.04	2.11	2.92	-0.04	0.17	0.32	0.00	0.81	0.20	-0.08	49.38	16:04:29		
25020	0.01	0.11	0.08	-0.03	0.07	0.08	2.33	3.21	-0.05	0.23	0.30	-0.11	0.78	0.16	-0.16	48.88	16:05:29		
25080	0.01	0.11	0.08	-0.03	0.03	0.02	2.37	3.39	-0.05	0.19	0.26	-0.11	0.81	0.16	-0.20	49.08	16:06:29		
25140	0.02	0.11	0.08	-0.03	0.01	0.02	2.39	3.21	-0.05	0.19	0.30	-0.04	0.81	0.16	-0.16	49.04	16:07:29		
25200	0.02	0.10	0.08	-0.03	0.04	0.03	2.41	3.25	-0.07	0.23	0.30	-0.11	0.78	0.20	-0.20	48.95	16:08:29		
25260	0.04	0.11	0.08	-0.03	0.06	0.02	2.33	3.19	-0.05	0.23	0.26	-0.11	0.78	0.16	-0.20	48.80	16:09:29		
25320	0.04	0.11	0.08	-0.03	0.06	0.03	2.44	3.36	-0.07	0.23	0.28	-0.11	0.78	0.20	-0.20	48.97	16:10:29		
25380	0.02	0.11	0.08	-0.03	0.05	0.02	2.41	3.19	-0.09	0.21	0.28	-0.11	0.78	0.16	-0.20	48.99	16:11:29		
25440	0.02	0.11	0.08	-0.03	0.03	0.02	2.39	3.41	-0.09	0.19	0.28	-0.11	0.75	0.12	-0.20	48.95	16:12:29		
25500	0.02	0.11	0.08	-0.03	0.01	0.01	2.35	3.18	-0.09	0.11	0.28	-0.11	0.78	0.16	-0.28	48.93	16:13:29		
25560	0.02	0.11	0.08	-0.03	0.01	0.02	2.44	3.25	-0.11	0.13	0.26	-0.11	0.75	0.16	-0.20	48.97	16:14:29		
25620	0.03	0.11	0.08	-0.03	0.04	0.03	2.39	3.27	-0.09	0.21	0.26	-0.15	0.78	0.16	-0.16	49.12	16:15:29		
25680	0.03	0.12	0.09	-0.03	0.07	0.04	2.44	3.32	-0.11	0.15	0.26	-0.11	0.78	0.20	-0.20	48.91	16:16:29		
25740	0.03	0.12	0.09	-0.03	0.04	0.03	2.41	3.36	-0.09	0.21	0.23	-0.15	0.78	0.12	-0.24	49.06	16:17:29		
25800	0.03	0.02	0.00	-0.03	0.04	0.03	0.43	0.41	-0.09	0.17	0.23	-0.15	0.78	0.20	-0.20	54.02	16:18:29		
25860	0.03	0.01	-0.01	-0.03	0.05	0.02	0.43	0.39	-0.11	0.06	0.23	-0.15	0.75	0.12	-1.01	54.08	16:19:29		
25920	0.03	0.00	-0.02	-0.03	0.03	0.03	0.41	0.37	-0.11	0.17	0.23	-0.04	0.78	0.16	0.15	53.90	16:20:29		
25980	0.03	0.01	-0.02	-0.03	0.02	0.01	0.41	0.39	-0.09	0.19	0.28	-0.11	0.78	0.16	-0.16	54.14	16:21:29		
26040	0.03	0.02	0.00	-0.03	0.01	0.02	0.41	0.37	-0.09	0.17	0.23	-0.11	0.75	0.16	-1.05	54.08	16:22:29		
26100	0.01	0.01	-0.01	-0.03	0.01	0.02	0.41	0.37	-0.09	0.17	0.26	-0.11	0.78	0.16	-1.05	54.02	16:23:29		
26160	0.00	0.01	-0.02	-0.03	0.00	0.02	0.43	0.37	-0.11	0.17	0.26	-0.11	0.78	0.16	-1.05	53.90	16:24:29		
26220	0.00	0.01	-0.01	-0.03	0.04	0.01	0.39	0.37	-0.11	0.15	0.26	-0.11	0.78	0.20		53.98	16:25:29		
26280	0.02	0.01	-0.02	-0.03	0.02	0.01	0.39	0.37	-0.09	0.15	0.23	-0.04	0.81	0.16		54.23	16:26:29		

DAPL DATA LOG		XOM-Buffalo,NYTerminal				XWell:LF-6												
		10/22/03 9:08:29 TPE				Test 2												
elapsed time (sec)	VERMW-3 Vac Resp (in WC)	VERMW-4 Vac Resp (in WC)	VERMW-2 Vac Resp (in WC)	VERMW-1 Vac Resp (in WC)	MW-28 Vac Resp (in WC)	MW-3URS Vac Resp (in WC)	Well Vacuum (inHg)	Straw Vacuum (inHg)	VERMW-3 GW DD (feet)	VERMW-4 GW DD (feet)	VERMW-2 GW DD (feet)	VERMW-1 GW DD (feet)	MW-28 GW DD (feet)	MW-3URS GW DD (feet)	LF-6 GW DD (feet)	HighVac AirFlow (scfm)	Time	Notes
26340	0.02	0.02	-0.01	-0.03	0.04	0.03	0.41	0.37	-0.11	0.17	0.26	-0.11	0.75	0.16		54.04	16:27:29	
26400	0.02	0.00	-0.02	-0.03	0.02	0.00	0.41	0.37	-0.07	0.17	0.23	-0.11	0.75	0.16		54.02	16:28:29	
26460	0.02	0.01	-0.02	-0.03	0.04	0.02	0.39	0.37	-0.11	0.13	0.26	-0.04	0.78	0.16		54.00	16:29:29	
26520	0.03	0.02	-0.01	-0.03	0.03	0.02	0.39	0.39	-0.11	0.11	0.26	-0.11	0.78	0.12		54.02	16:30:29	
26580	0.02	0.01	-0.01	-0.03	0.05	0.02	0.41	0.37	-0.09	0.13	0.26	-0.11	0.75	0.20	-1.09	53.98	16:31:29	
26640	0.02	0.01	-0.01	-0.03	0.05	0.03	0.41	0.37	-0.09	0.15	0.26	-0.15	0.72	0.16	-1.01	53.98	16:32:29	
26700	0.02	0.01	-0.01	-0.03	0.05	0.02	0.41	0.36	-0.11	0.15	0.26	-0.11	0.75	0.12	-1.01	53.90	16:33:29	

Graphs of Pressure and Water Table Response and DAPL Unit Data
Long-Term Test (Test 3), October 22/23, 2003

VER Pilot Test, Long-Term Test (Test 3), October 22/23, 2004
VERMW-3 : Vacuum Response

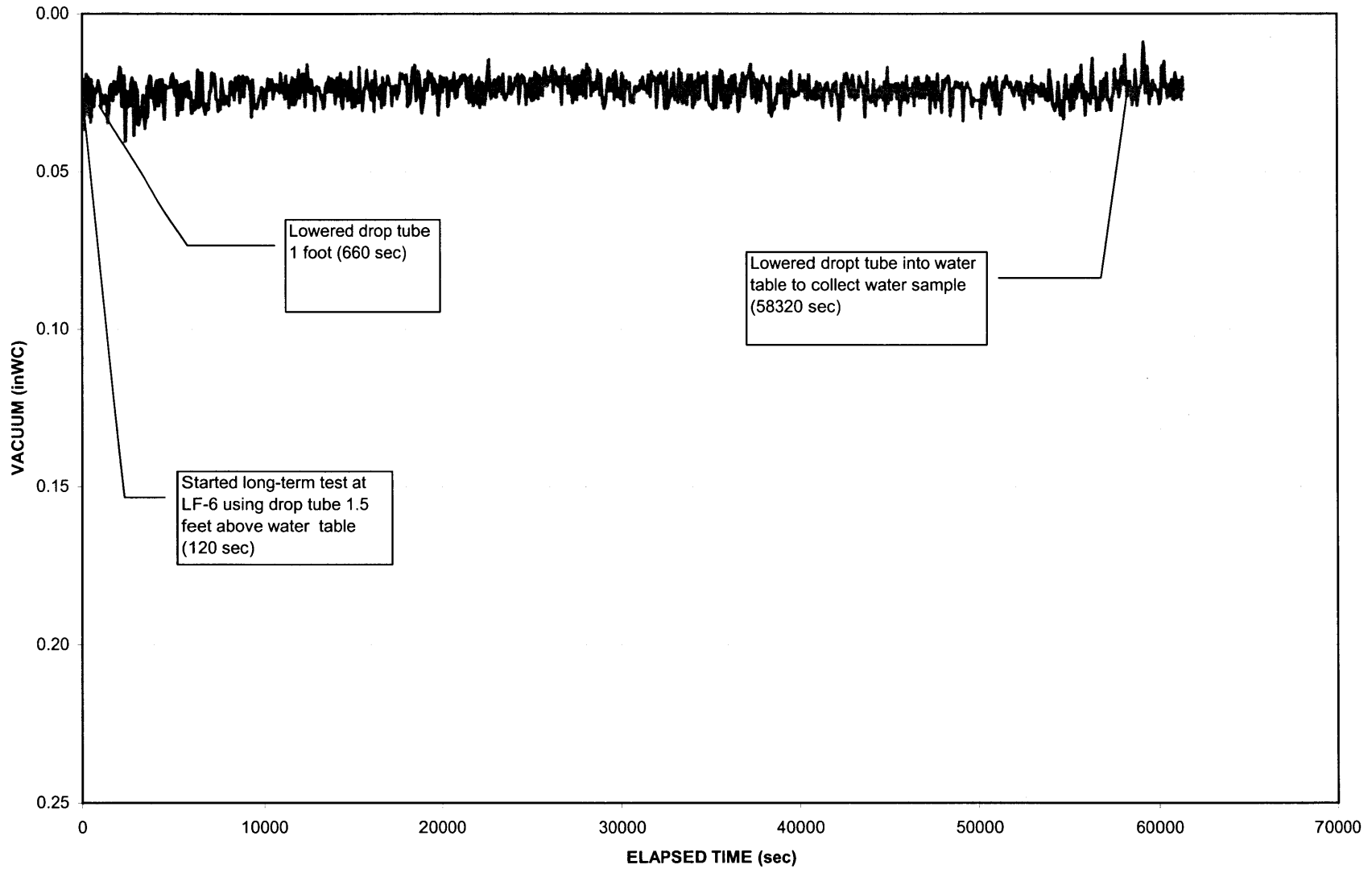

VER Pilot Test, Long-Term Test (Test 3), October 22/23, 2004
VERMW-4 : Vacuum Response

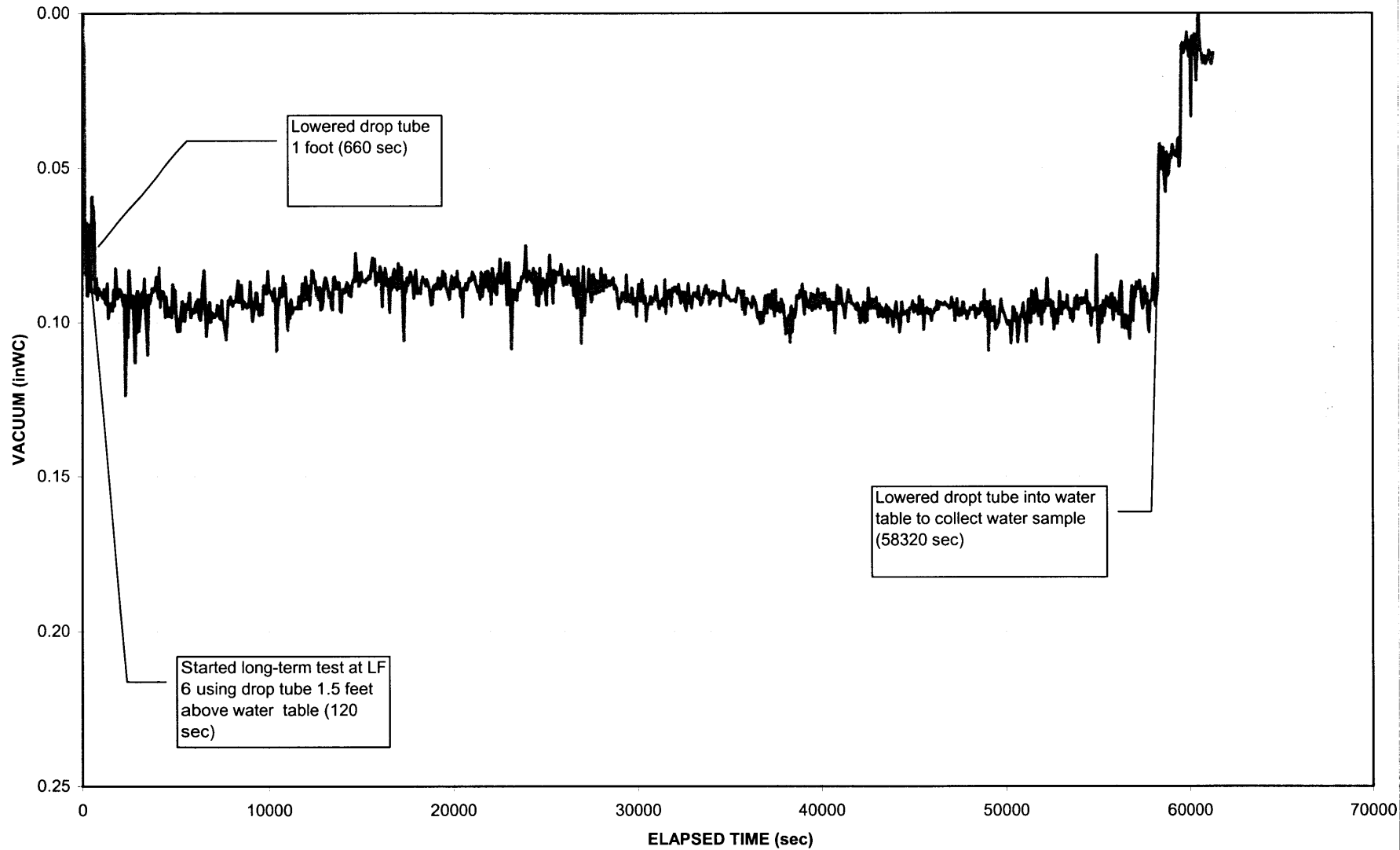

VER Pilot Test, Long-Term Test (Test 3), October 22/23, 2004
VERMW-2 : Vacuum Response

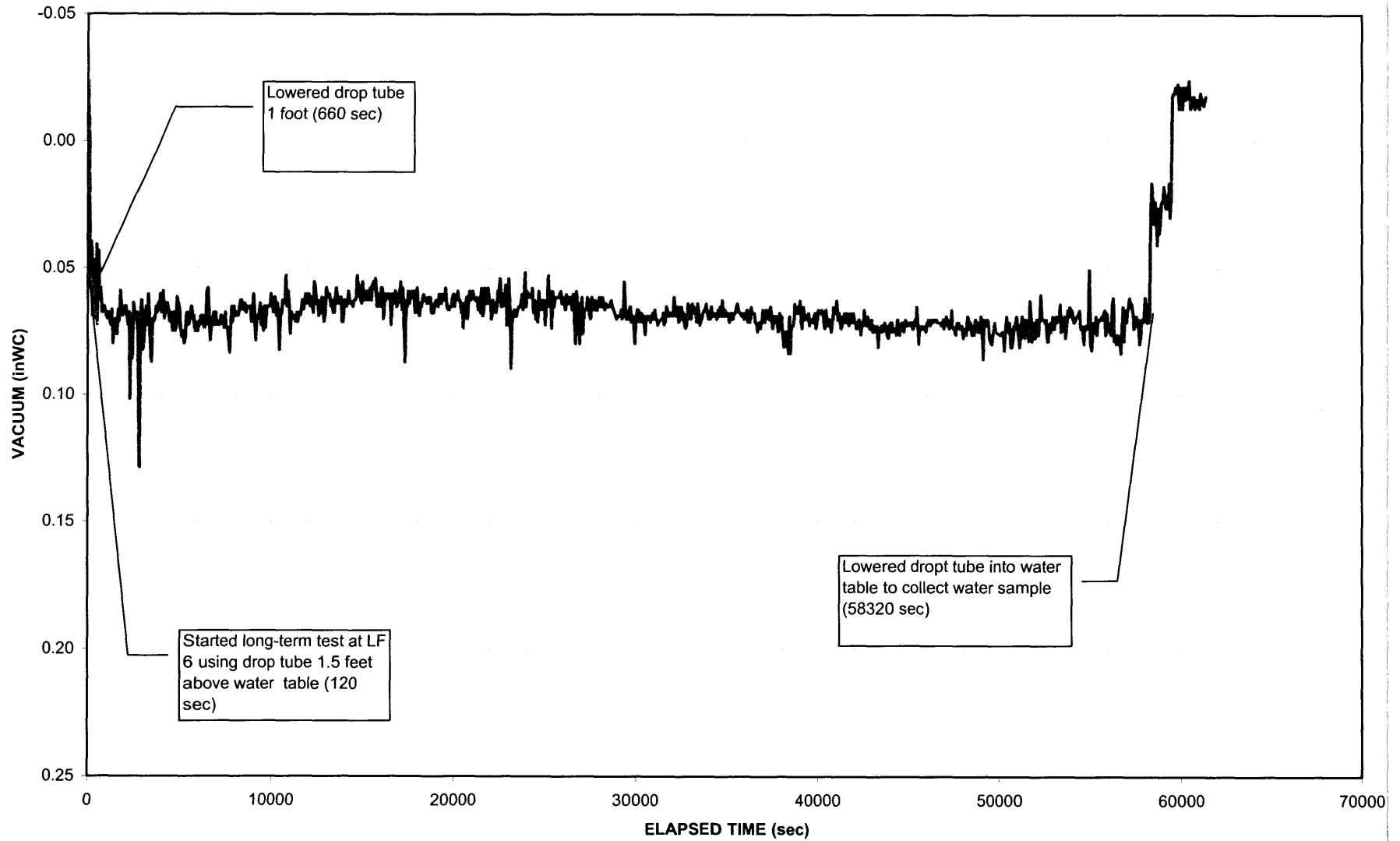

VER Pilot Test, Long-Term Test (Test 3), October 22/23, 2004
VERMW-1 : Vacuum Response

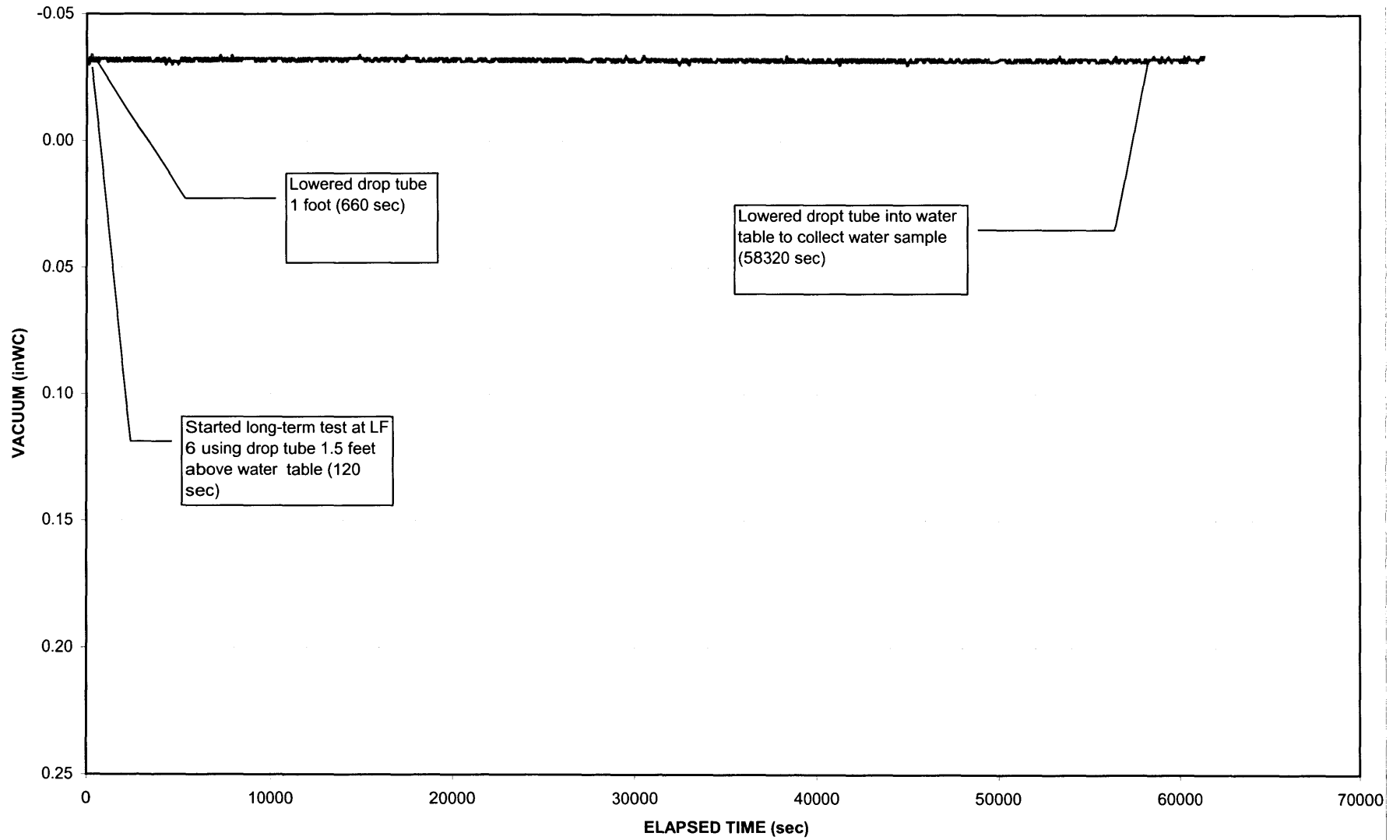

VER Pilot Test, Long-Term Test (Test 3), October 22/23, 2004
MW-28 : Vacuum Response

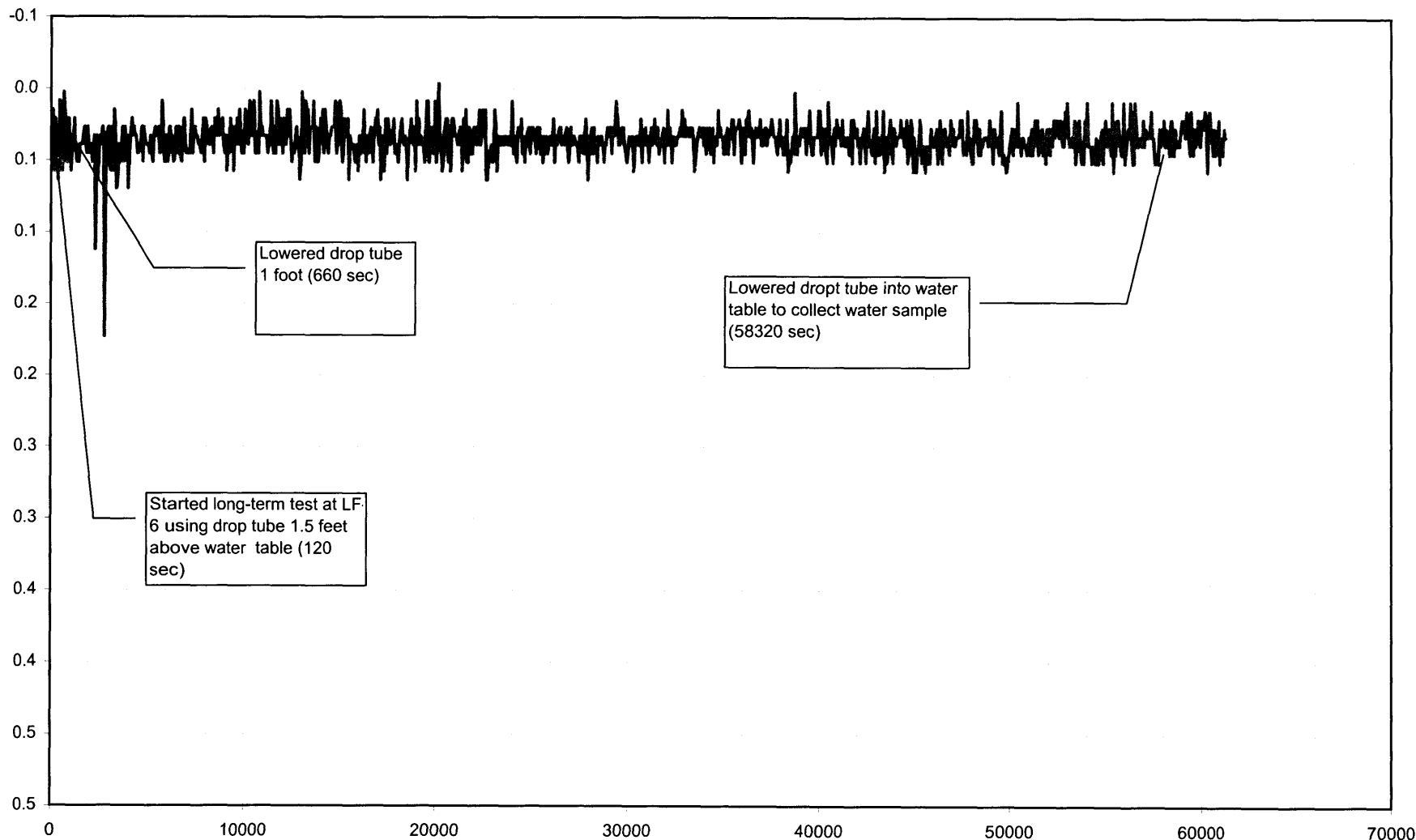

VER Pilot Test, Long-Term Test (Test 3), October 22/23, 2004
MW-3URS : Vacuum Response

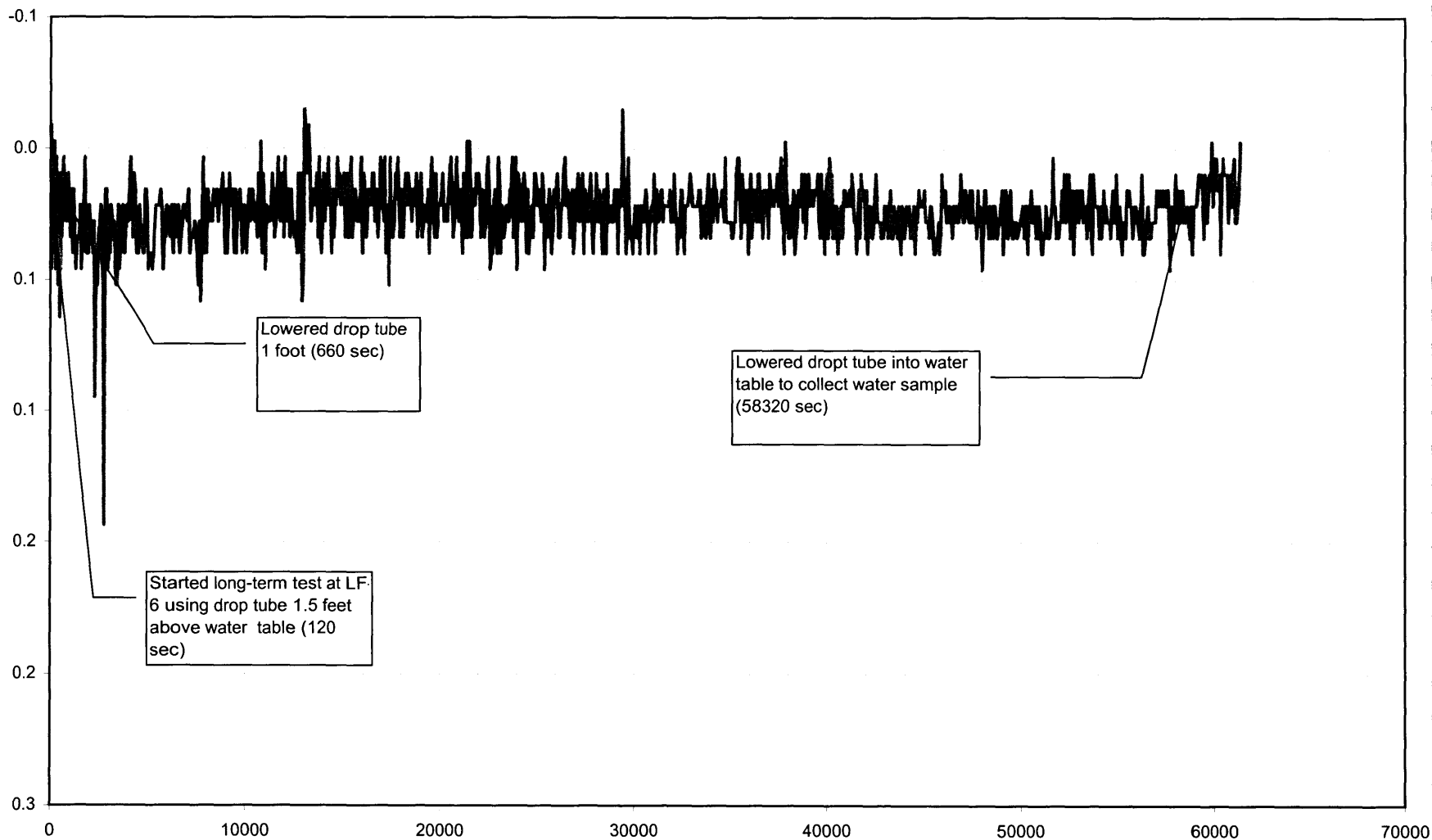

VER Pilot Test, Long-Term Test (Test 3), October 22/23, 2003
VERMW-3 : Groundwater Response

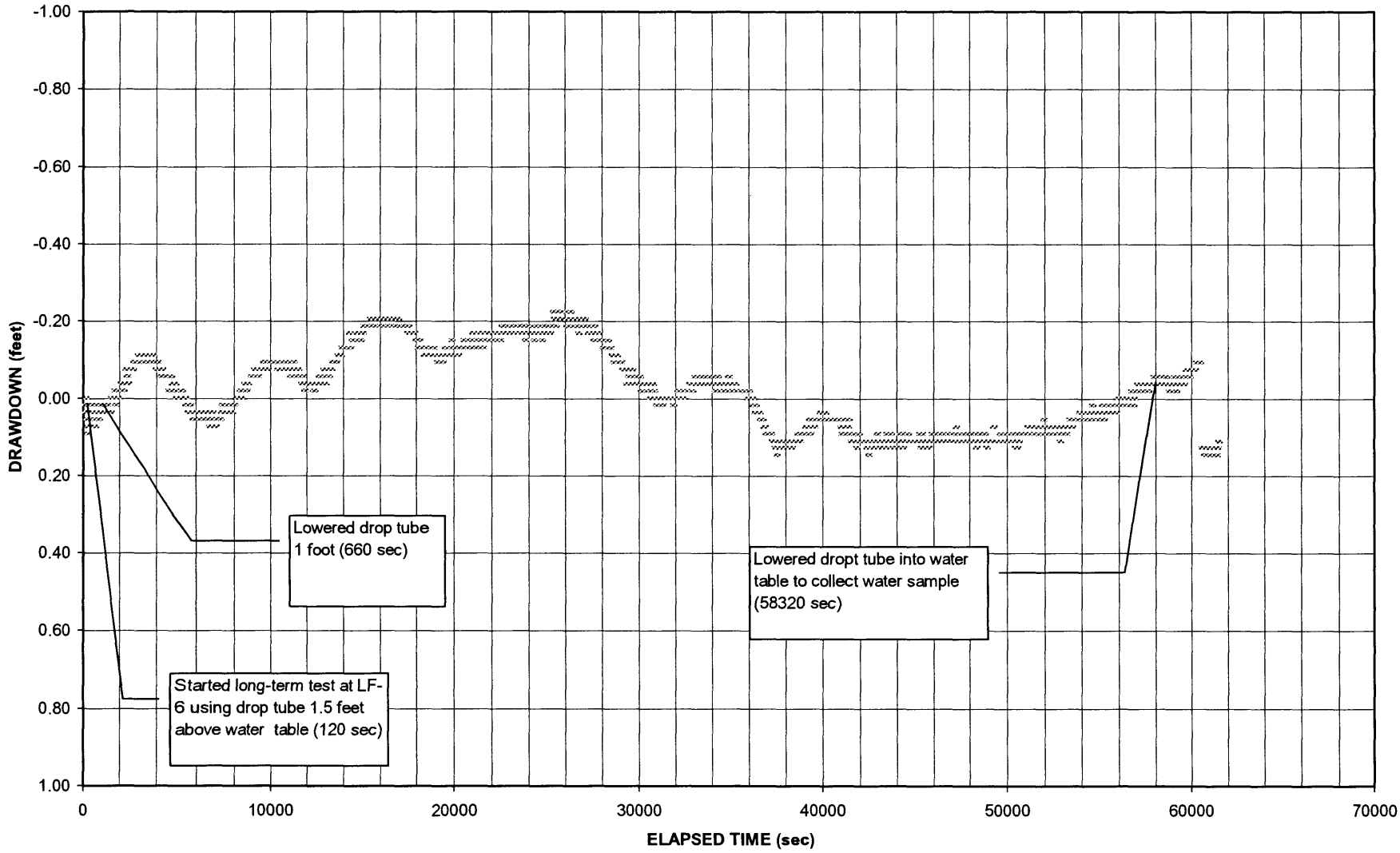

VER Pilot Test, Long-Term Test (Test 3), October 22/23, 2003
VERMW-4 : Groundwater Response

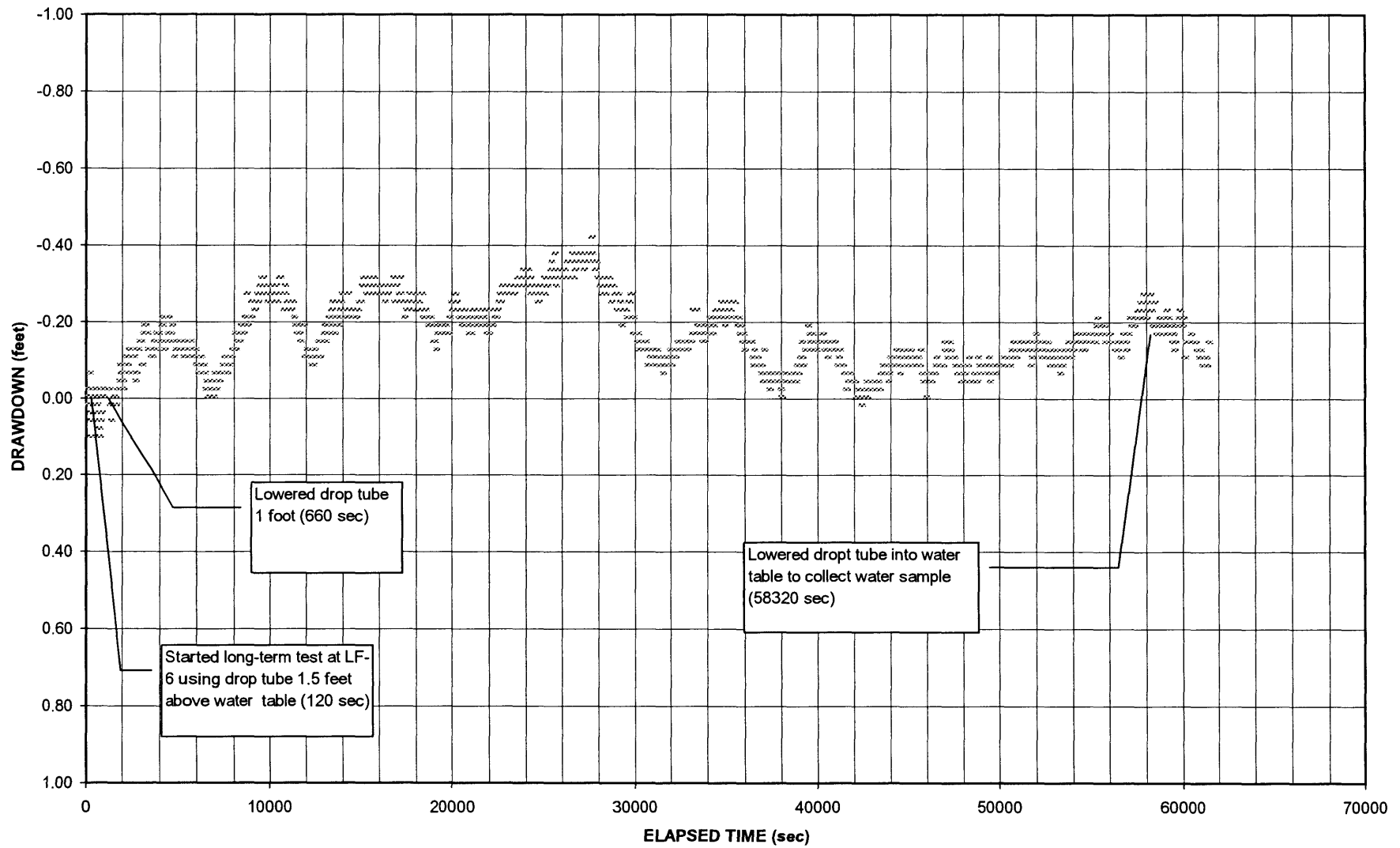

VER Pilot Test, Long-Term Test (Test 3), October 22/23, 2003
VERMW-2 : Groundwater Response

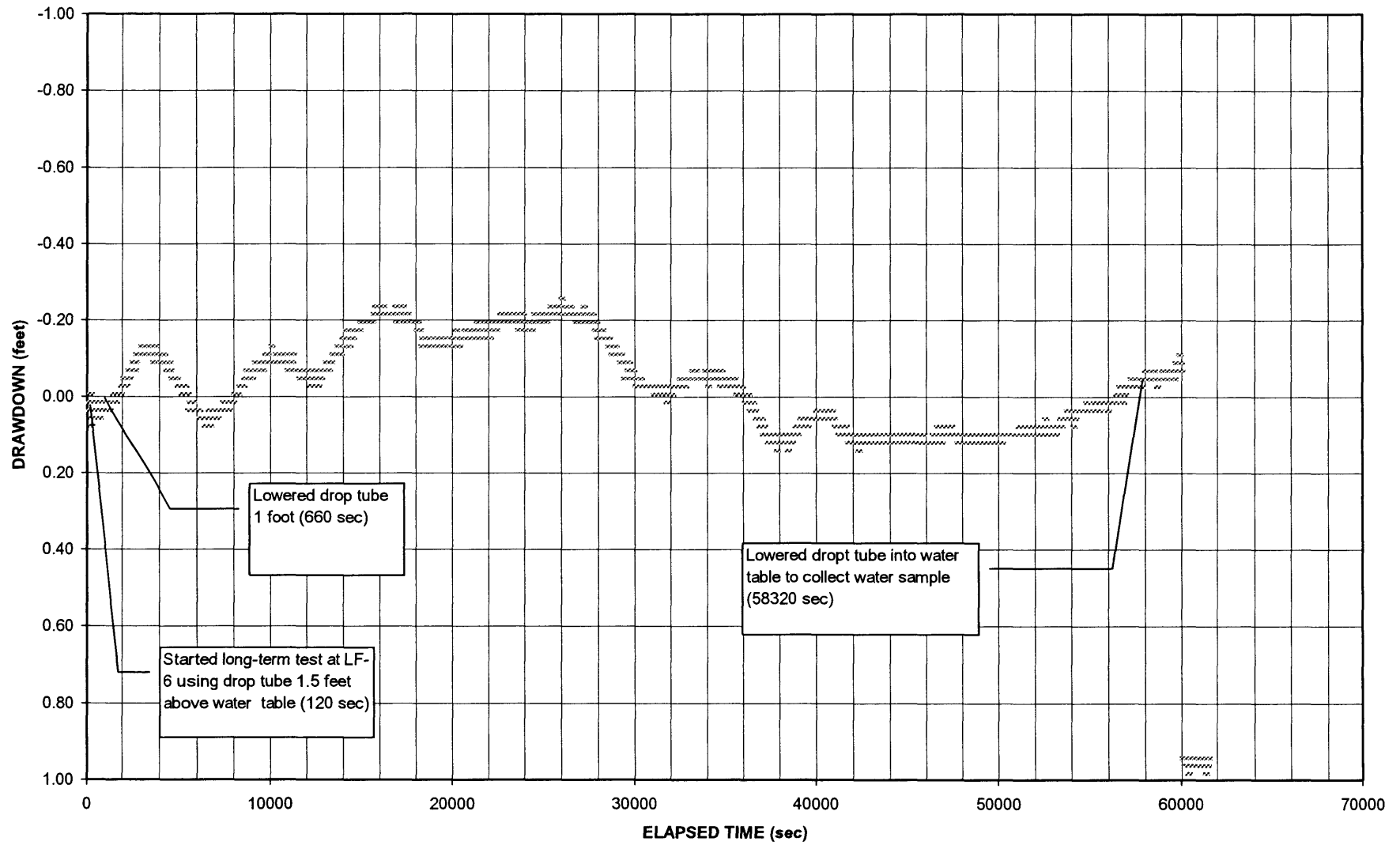

VER Pilot Test, Long-Term Test (Test 3), October 22/23, 2003
VERMW-1 : Groundwater Response

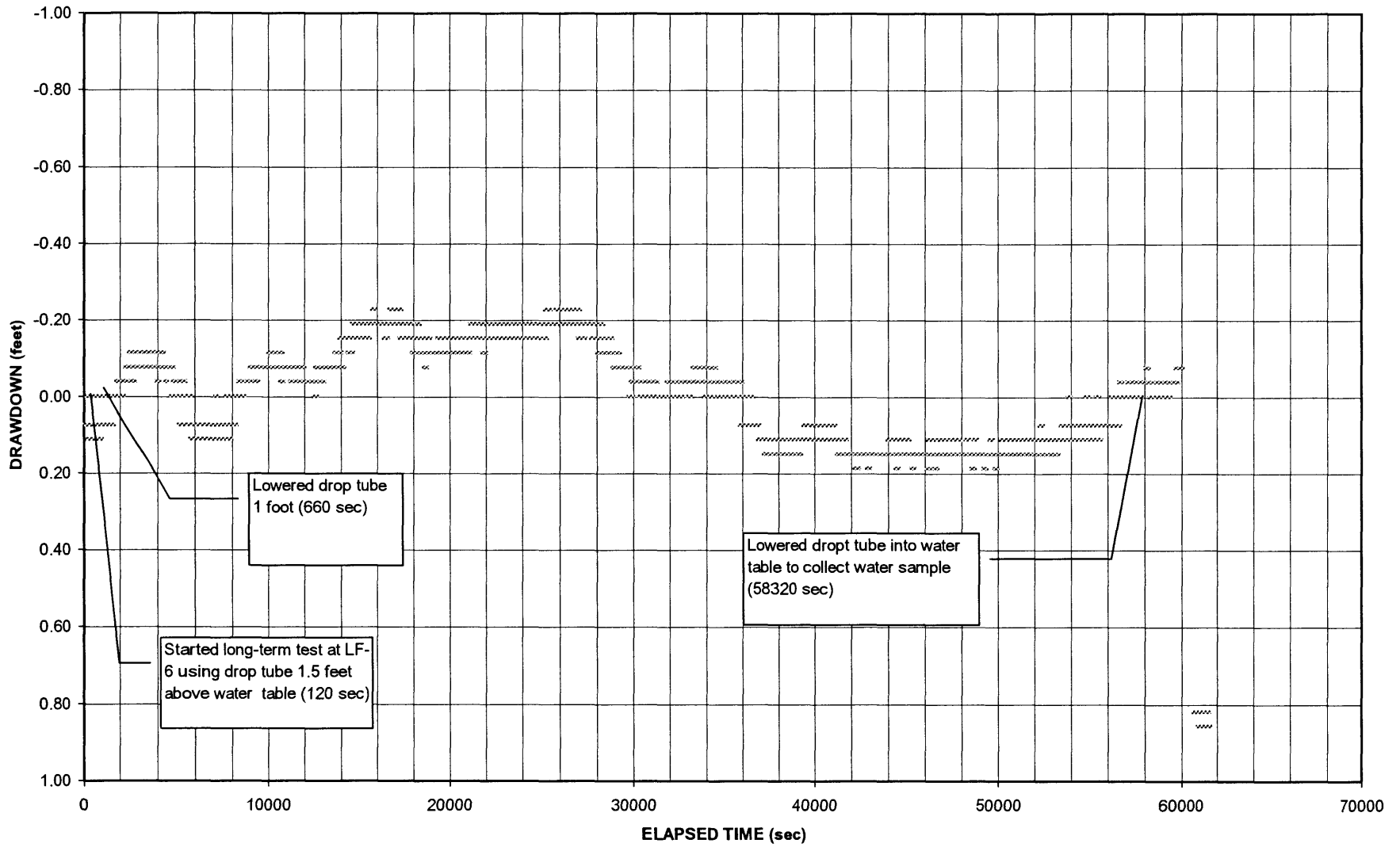

VER Pilot Test, Long-Term Test (Test 3), October 22/23, 2003
VERMW-28 : Groundwater Response

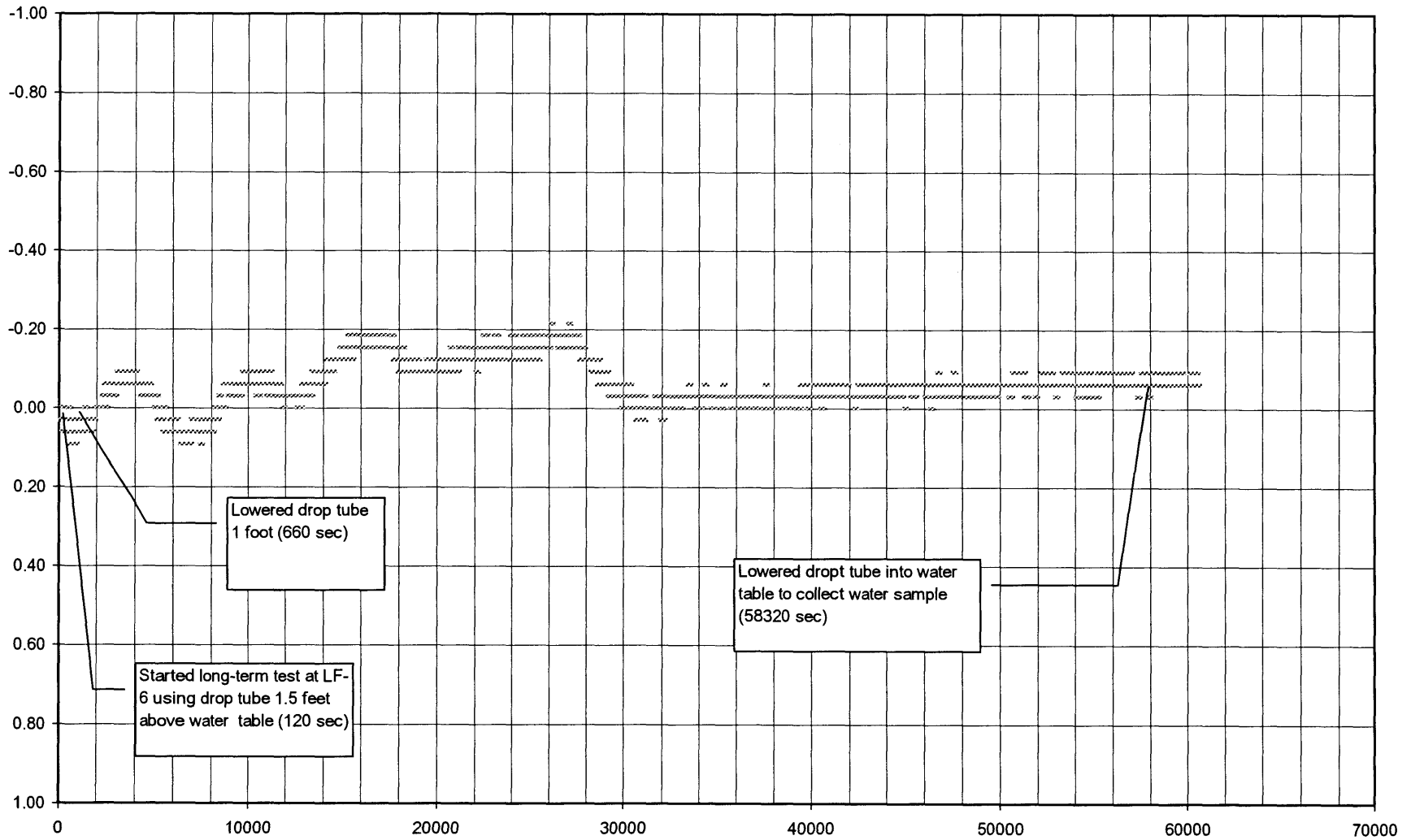

VER Pilot Test, Long-Term Test (Test 3), October 22/23, 2003
MW-3URS : Groundwater Response

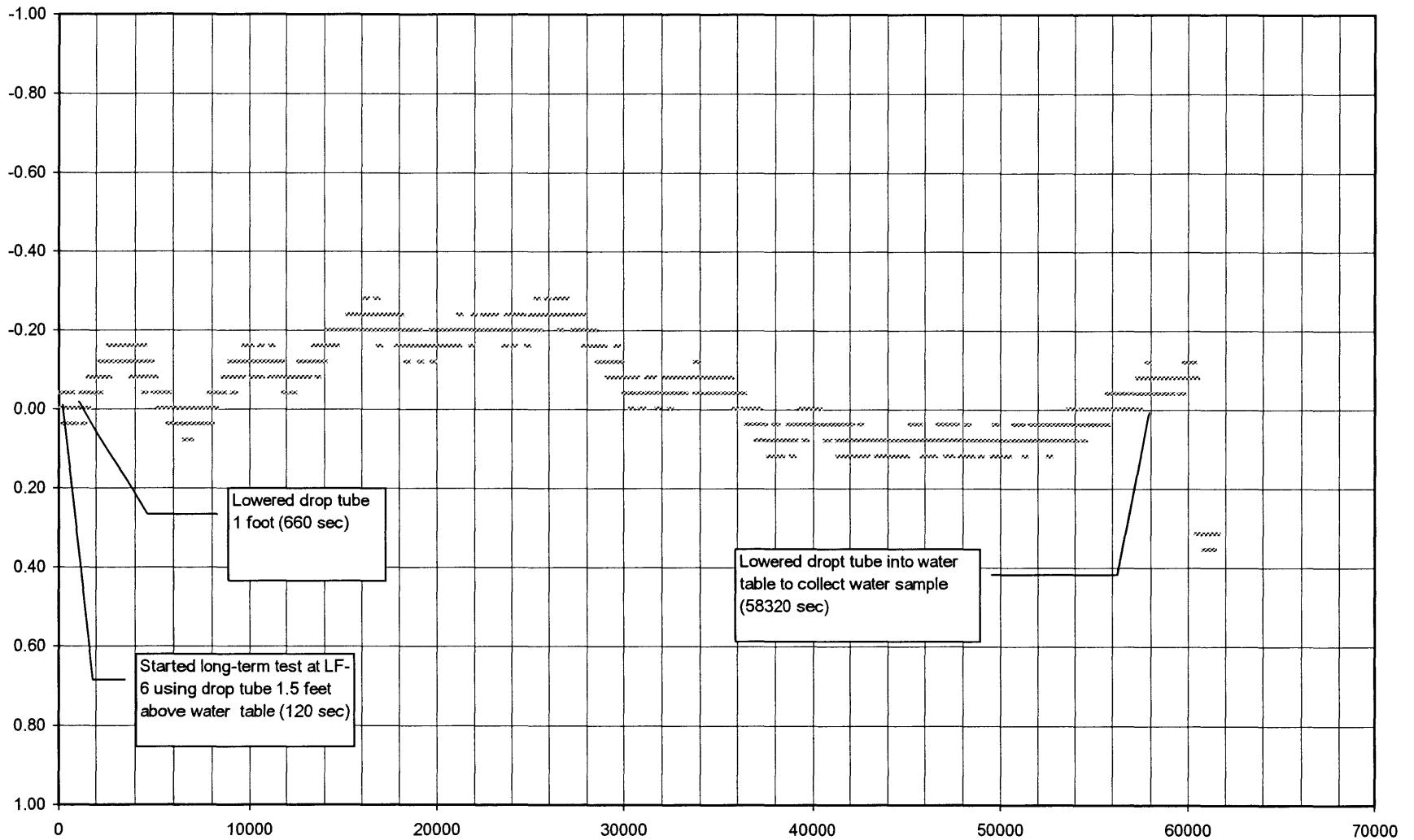

VER Pilot Test, Long-Term Test (Test 3), October 22/23, 2003
LF-6 : Groundwater Response

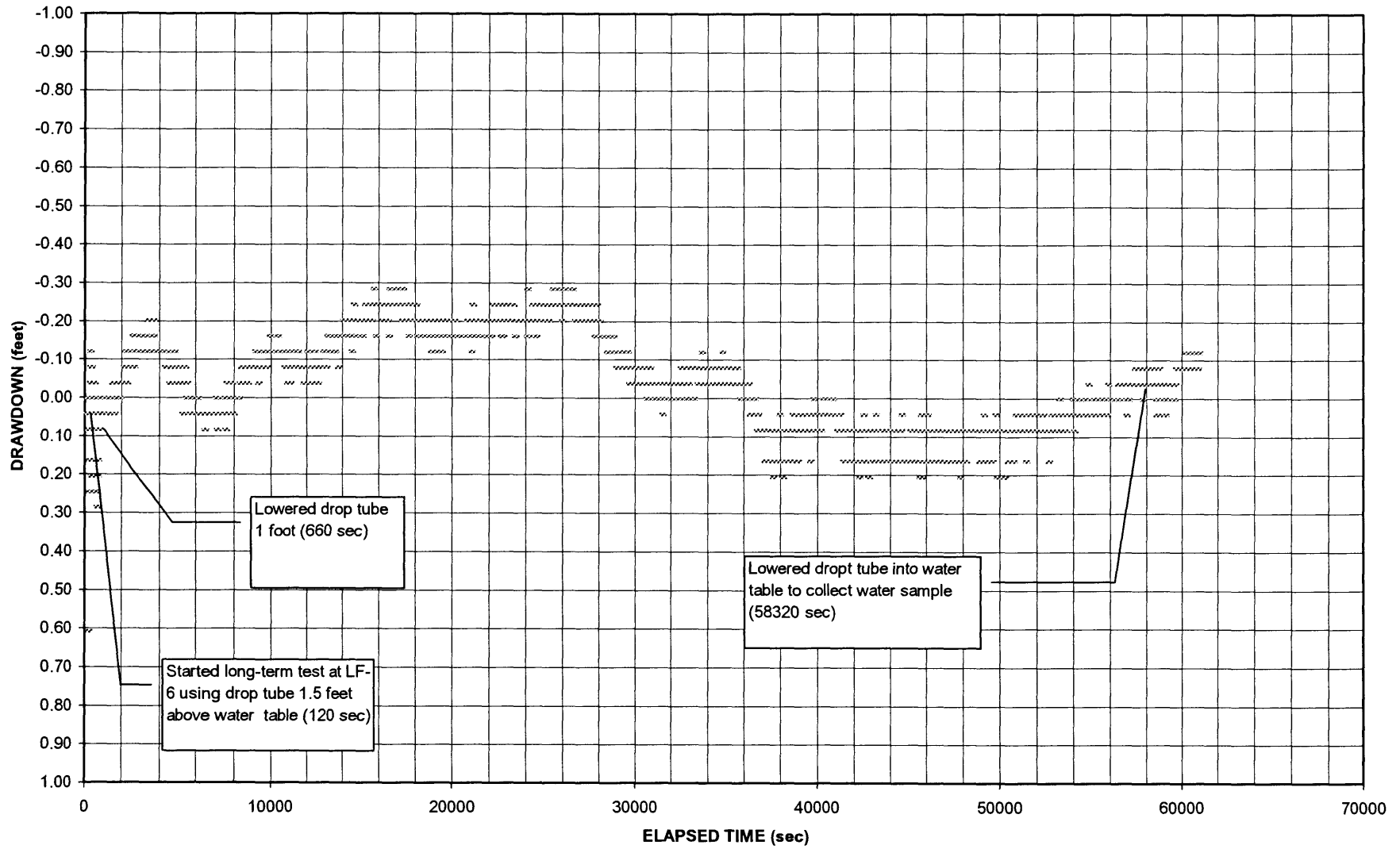

DAPL DATA LOG	XOM-Buffalo, NY Terminal										XWell: LF-6							Time	Notes
	10/22/03 16:51:21 TPE										Test 3								
elapsed time (sec)	VERMW-3 Vac Resp (in WC)	VERMW-4 Vac Resp (in WC)	VERMW-2 Vac Resp (in WC)	VERMW-1 Vac Resp (in WC)	MW-28 Vac Resp (in WC)	MW-3URS Vac Resp (in WC)	Well Vacuum (inHg)	Straw Vacuum (inHg)	VERMW-3 GW DD (feet)	VERMW-4 GW DD (feet)	VERMW-2 GW DD (feet)	VERMW-1 GW DD (feet)	MW-28 GW DD (feet)	MW-3URS GW DD (feet)	LF-6 GW DD (feet)	HighVac AirFlow (scfm)			
5	0.02	0.01	-0.01	-0.03	0.03	0.02	0.43	0.37	0.04	0.02	0.04	0.07	0.03	-0.04	0.04	54.23	16:51:26		
10	0.03	0.02	0.00	-0.03	0.05	0.03	0.39	0.37	0.02	-0.02	0.02	0.07	0.03	0.00	0.04	54.23	16:51:31		
15	0.02	0.03	0.01	-0.03	0.05	0.05	0.43	0.39	0.02	0.02	0.02	0.00	0.03	-0.04	0.00	54.37	16:51:36		
20	0.03	0.02	-0.01	-0.03	0.03	0.02	0.41	0.39	0.02	0.02	0.02	0.07	0.03	0.00	0.04	55.15	16:51:41		
25	0.03	0.01	-0.01	-0.03	0.05	0.03	0.39	0.39	0.02	-0.02	0.02	0.00	0.00	-0.04	0.04	54.08	16:51:46		
30	0.02	0.01	0.00	-0.03	0.06	0.03	0.41	0.37	0.02	-0.02	0.00	0.00	0.03	-0.04	0.08	54.08	16:51:51		
35	0.03	0.00	-0.02	-0.03	0.04	0.02	0.39	0.39	0.02	-0.02	0.02	0.07	0.03	0.00	0.08	54.00	16:51:56		
40	0.03	0.01	-0.01	-0.03	0.06	0.02	0.41	0.37	0.00	0.00	0.04	0.00	0.03	-0.04	0.04	54.02	16:52:01		
45	0.03	0.01	-0.01	-0.03	0.02	-0.01	0.43	0.39	0.05	-0.02	0.02	0.07	0.06	0.00	0.04	54.10	16:52:06		
50	0.03	0.01	-0.01	-0.03	0.05	0.05	0.41	0.39	0.02	-0.07	0.02	0.00	0.03	0.00	0.08	54.23	16:52:11		
55	0.04	0.02	0.00	-0.03	0.04	0.02	0.41	0.37	0.00	0.00	0.02	0.07	0.06	-0.04	0.04	54.02	16:52:16		
60	0.04	0.02	0.00	-0.03	0.05	0.03	0.39	0.39	0.02	0.00	0.02	0.07	0.03	0.00	0.04	54.20	16:52:21		
70	0.03	0.01	-0.01	-0.03	0.04	0.02	0.41	0.41	0.04	0.00	0.00	0.00	0.06	0.00	0.00	54.04	16:52:31		
75	0.03	0.01	-0.01	-0.03	0.04	0.03	0.41	0.37	0.00	0.00	0.02	0.00	0.06	0.00	0.04	54.18	16:52:36		
80	0.03	0.01	-0.01	-0.03	0.03	0.01	0.41	0.37	0.04	-0.02	0.00	0.00	0.03	-0.04	0.04	54.14	16:52:41		
110	0.03	0.01	0.00	-0.03	0.01	0.02	1.01	1.42	0.09	0.06	0.08	0.00	0.03	-0.04	0.61	52.65	16:53:11		
115	0.03	0.04	0.03	-0.03	0.05	0.03	1.55	4.05	0.07	0.10	0.08	0.00	0.03	0.00	0.17	46.02	16:53:16		
120	0.03	0.05	0.04	-0.03	0.04	0.02	1.53	6.60	0.05	0.04	0.06	0.11	0.00	0.00	0.25	42.77	16:53:21	start test (long duration), drop tube is 1.5 ft above water	
125	0.03	0.06	0.05	-0.03	0.03	0.03	1.51	7.22	0.05	0.04	0.08	0.07	0.03	0.00	0.04	41.17	16:53:26		
130	0.03	0.08	0.05	-0.03	0.03	0.02	1.25	7.68	0.04	-0.02	0.04	0.07	0.03	-0.04	0.08	39.63	16:53:31		
165	0.03	0.07	0.05	-0.03	0.05	0.02	1.45	6.69	0.05	0.02	0.04	0.07	0.06	0.04	0.04	38.59	16:54:06		
170	0.03	0.08	0.06	-0.03	0.06	0.03	1.49	5.76	0.02	0.00	0.04	0.07	0.06	0.00	0.17	38.48	16:54:11		
175	0.02	0.07	0.04	-0.03	0.02	0.02	1.44	5.76	0.04	-0.02	0.04	0.07	0.03	0.00	0.04	38.70	16:54:16		
180	0.03	0.07	0.05	-0.03	0.06	0.03	1.51	6.01	0.04	-0.02	0.04	0.07	0.03	-0.04	0.08	38.73	16:54:21		
185	0.02	0.07	0.05	-0.03	0.04	0.02	1.55	6.54	0.05	-0.02	0.02	0.07	0.03	0.04	-0.12	38.37	16:54:26		
190	0.03	0.08	0.06	-0.03	0.03	0.02	1.44	6.80	0.05	-0.02	0.04	0.07	0.03	0.00	-0.08	38.37	16:54:31		
195	0.03	0.08	0.06	-0.03	0.03	0.02	1.33	7.02	0.04	-0.02	0.04	0.07	0.03	0.00	-0.04	38.12	16:54:36		
200	0.02	0.07	0.04	-0.03	0.02	0.00	1.49	6.27	0.05	0.00	0.06	0.07	0.06	0.04	0.08	38.59	16:54:41		
205	0.03	0.07	0.05	-0.03	0.03	0.03	1.49	6.31	0.05	-0.02	0.04	0.07	0.03	-0.04	0.04	38.56	16:54:46		
210	0.02	0.08	0.05	-0.03	0.03	0.02	1.33	6.86	0.02	0.02	0.04	0.07	0.03	0.00	0.08	38.31	16:54:51		
215	0.03	0.08	0.05	-0.03	0.03	0.03	1.38	6.42	0.04	0.02	0.02	0.07	0.03	0.04	0.04	37.95	16:54:56		
220	0.02	0.08	0.05	-0.03	0.03	0.02	1.36	6.73	0.04	0.02	0.04	0.11	0.06	0.00	0.04	38.20	16:55:01		
225	0.02	0.07	0.04	-0.03	0.03	0.02	1.34	6.62	0.04	0.06	0.04	0.07	0.06	0.00	0.04	38.12	16:55:06		
230	0.02	0.07	0.05	-0.03	0.05	0.03	1.42	6.34	0.04	0.02	0.04	0.07	0.06	0.00	0.04	38.09	16:55:11		
235	0.03	0.08	0.06	-0.03	0.04	0.02	1.44	5.92	0.04	0.00	0.02	0.11	0.03	-0.04	0.08	38.09	16:55:16		
240	0.02	0.08	0.05	-0.03	0.05	0.04	1.42	6.54	0.04	0.02	0.04	0.07	0.06	-0.04	0.21	38.29	16:55:21		
245	0.03	0.09	0.06	-0.03	0.03	0.03	1.49	6.27	0.04	0.04	0.02	0.07	0.06	0.00	0.04	38.26	16:55:26		
250	0.03	0.09	0.07	-0.03	0.05	0.02	1.45	6.58	0.04	0.02	0.04	0.07	0.03	-0.04	0.04	38.23	16:55:31		
255	0.03	0.08	0.06	-0.03	0.04	0.04	1.53	6.36	0.04	0.02	0.04	0.07	0.03	-0.04	0.04	38.42	16:55:36		
260	0.03	0.09	0.07	-0.03	0.03	0.02	1.40	6.54	0.04	0.00	0.04	0.07	0.03	-0.04	-0.08	37.92	16:55:41		
265	0.03	0.09	0.07	-0.03	0.06	0.04	1.42	6.40	0.04	0.00	0.06	0.07	0.06	0.00	0.08	38.26	16:55:46		
270	0.03	0.08	0.06	-0.03	0.05	0.03	1.44	6.84	0.05	0.04	0.04	0.07	0.06	0.00	0.04	38.26	16:55:51		
275	0.02	0.09	0.07	-0.03	0.05	0.05	1.40	6.73	0.02	-0.02	0.04	0.07	0.03	0.00	0.04	38.06	16:55:56		
280	0.02	0.09	0.06	-0.03	0.04	0.03	1.47	6.87	0.05	0.00	0.04	0.00	0.03	0.00	0.00	38.29	16:56:01		
285	0.02	0.09	0.06	-0.03	0.03	0.03	1.27	7.29	0.04	0.00	0.04	0.07	0.06	0.00	0.00	38.17	16:56:06		
290	0.03	0.08	0.06	-0.03	0.03	0.04	1.49	7.00	0.04	-0.02	0.04	0.07	0.06	0.00	0.04	38.40	16:56:11		
295	0.02	0.09	0.06	-0.03	0.04	0.03	1.49	6.65	0.05	0.00	0.04	0.07	0.06	0.04	0.00	38.23	16:56:16		
300	0.02	0.08	0.05	-0.03	0.03	0.00	1.42	6.91	0.05	0.04	0.04	0.11	0.06	0.00	0.08	38.62	16:56:21		
305	0.03	0.08	0.05	-0.03	0.03	0.03	1.42	6.82	0.05	0.04	0.04	0.07	0.03	0.00	0.08	38.29	16:56:26		
310	0.03	0.09	0.06	-0.03	0.03	0.02	1.31	7.06	0.04	0.06	0.02	0.00	0.06	0.00	0.17	38.17	16:56:31		
315	0.03	0.08	0.05	-0.03	0.05	0.04	1.42	6.73	0.04	0.04	0.04	0.07	0.03	0.04	0.08	38.23	16:56:36		
320	0.03	0.08	0.05	-0.03	0.04	0.04	1.36	6.62	0.04	0.02	0.04	0.07	0.06	0.00	0.04	38.09	16:56:41		
325	0.02	0.08	0.05	-0.03	0.04	0.04	1.45	6.49	0.05	0.02	0.06	0.00	0.03	0.00	0.08	38.51	16:56:46		
330	0.03	0.08	0.05	-0.03	0.03	0.03	1.44	6.40	0.05	0.02	0.04	0.00	0.03	0.00	0.17	38.51	16:56:51		
335	0.02	0.07	0.05	-0.03	0.04	0.03	1.44	5.99	0.05	-0.02	0.06	0.07	0.06	0.04	0.04	38.40	16:56:56		
340	0.03	0.08	0.05	-0.03	0.05	0.04	1.44	6.75	0.04	0.00	0.04	0.00	0.06	0.04	0.00	38.54	16:57:01		
345	0.03	0.08	0.05	-0.03	0.04	0.03	1.42	5.81	0.04	0.00	0.04	0.11	0.03	-0.04	0.00	37.95	16:57:06		

DAPL	XOM-Buffalo,NYTerminal														XWell: LF-6		Time	Notes
DATA LOG	10/22/03	16:51:21	TPE											Test 3				
elapsed time (sec)	VERMW-3 Vac Resp (in WC)	VERMW-4 Vac Resp (in WC)	VERMW-2 Vac Resp (in WC)	VERMW-1 Vac Resp (in WC)	MW-28 Vac Resp (in WC)	MW-3URS Vac Resp (in WC)	Well Vacuum (inHg)	Straw Vacuum (inHg)	VERMW-3 GW DD (feet)	VERMW-4 GW DD (feet)	VERMW-2 GW DD (feet)	VERMW-1 GW DD (feet)	MW-28 GW DD (feet)	MW-3URS GW DD (feet)	LF-6 GW DD (feet)	HighVac AirFlow (scfm)		
350	0.02	0.08	0.05	-0.03	0.05	0.03	1.40	6.64	0.02	0.02	0.04	0.07	0.06	0.04	0.04	38.48		
355	0.03	0.08	0.05	-0.03	0.04	0.03	1.42	6.23	0.04	0.00	0.04	0.07	0.03	0.00	0.04	38.31		
360	0.03	0.08	0.06	-0.03	0.03	0.02	1.42	6.62	0.05	0.00	0.04	0.07	0.03	-0.04	0.04	38.48		
365	0.03	0.08	0.06	-0.03	0.06	0.04	1.40	6.20	0.05	-0.02	0.04	0.07	0.06	-0.04	0.25	38.20		
370	0.03	0.07	0.05	-0.03	0.05	0.04	1.38	7.04	0.04	-0.02	0.04	0.07	0.06	0.04	0.04	38.31		
375	0.02	0.08	0.05	-0.03	0.05	0.04	1.45	6.21	0.04	-0.02	0.04	0.07	0.03	0.00	0.21	38.56		
380	0.02	0.08	0.06	-0.03	0.04	0.05	1.51	6.71	0.05	-0.02	0.04	0.07	0.03	-0.04	0.08	38.62		
385	0.03	0.09	0.07	-0.03	0.04	0.04	1.47	6.21	0.04	-0.02	0.04	0.11	0.03	-0.04	0.00	38.29		
390	0.03	0.08	0.06	-0.03	0.06	0.04	1.45	6.40	0.05	0.04	0.04	0.07	0.06	0.00	0.00	38.56		
395	0.03	0.09	0.07	-0.03	0.05	0.05	1.36	6.78	0.04	0.04	0.04	0.07	0.06	0.00	0.00	38.15		
400	0.02	0.08	0.06	-0.03	0.06	0.03	1.51	5.92	0.05	0.04	0.04	0.07	0.00	0.00	0.04	38.65		
405	0.02	0.08	0.06	-0.03	0.05	0.02	1.55	6.53	0.05	0.02	0.04	0.07	0.03	0.00	0.08	38.65		
410	0.03	0.09	0.07	-0.03	0.05	0.03	1.51	6.14	0.05	0.04	0.04	0.07	0.06	0.04	0.04	38.65		
415	0.03	0.08	0.06	-0.03	0.05	0.04	1.34	6.56	0.05	0.00	0.02	0.11	0.06	-0.04	-0.04	38.17		
420	0.02	0.08	0.05	-0.03	0.04	0.03	1.44	6.31	0.04	0.02	0.04	0.11	0.06	0.00	0.08	38.65		
425	0.03	0.08	0.06	-0.03	0.03	0.04	1.45	5.43	0.04	0.00	0.04	0.07	0.06	0.04	0.08	38.67		
430	0.03	0.08	0.06	-0.03	0.05	0.03	1.53	6.29	0.04	0.00	0.04	0.07	0.09	0.00	0.04	38.67		
435	0.03	0.07	0.05	-0.03	0.01	0.02	1.40	6.53	0.04	0.02	0.04	0.07	0.03	0.00	0.04	38.34		
440	0.02	0.08	0.07	-0.03	0.05	0.05	1.36	6.58	0.05	0.00	0.04	0.07	0.03	0.00	0.04	38.15		
445	0.03	0.07	0.05	-0.03	0.03	0.04	1.36	6.62	0.04	0.00	0.04	0.11	0.06	0.04	0.08	38.42		
450	0.02	0.07	0.06	-0.03	0.05	0.05	1.45	6.54	0.04	0.02	0.04	0.07	0.06	0.00	0.08	38.56		
455	0.03	0.08	0.06	-0.03	0.04	0.05	1.55	6.42	0.04	0.06	0.06	0.07	0.03	0.00	0.04	38.65		
460	0.03	0.07	0.06	-0.03	0.05	0.03	1.60	5.85	0.04	0.04	0.06	0.07	0.06	0.00	0.04	38.51		
465	0.03	0.07	0.05	-0.03	0.04	0.02	1.45	6.36	0.04	0.02	0.04	0.07	0.06	0.04	0.04	38.29		
470	0.03	0.07	0.06	-0.03	0.04	0.04	1.47	6.93	0.07	0.02	0.04	0.07	0.06	0.00	0.08	38.34		
475	0.03	0.08	0.07	-0.03	0.06	0.06	1.44	6.16	0.04	0.00	0.02	0.07	0.03	0.00	0.04	38.29		
480	0.02	0.07	0.05	-0.03	0.04	0.05	1.38	6.56	0.05	0.00	0.04	0.07	0.03	0.04	0.04	38.31		
485	0.03	0.07	0.05	-0.03	0.04	0.03	1.42	6.53	0.04	-0.02	0.02	0.11	0.06	0.00	0.08	38.31		
490	0.03	0.07	0.05	-0.03	0.04	0.02	1.42	5.83	0.04	0.00	0.04	0.07	0.03	0.00	0.08	38.23		
495	0.03	0.06	0.04	-0.03	0.05	0.03	1.36	6.71	0.04	0.00	0.04	0.00	0.09	0.04	0.08	38.31		
500	0.02	0.06	0.04	-0.03	0.02	0.02	1.42	6.10	0.05	0.00	0.06	0.11	0.06	0.00	0.25	38.65		
505	0.03	0.06	0.05	-0.03	0.05	0.01	1.51	6.43	0.05	-0.02	0.04	0.07	0.06	-0.04	0.17	38.62		
510	0.02	0.06	0.04	-0.03	0.05	0.03	1.51	6.60	0.05	0.00	0.04	0.11	0.06	0.04	0.17	38.56		
515	0.02	0.07	0.05	-0.03	0.03	0.02	1.55	5.68	0.02	0.06	0.04	0.11	0.06	0.00	0.00	38.59		
520	0.03	0.07	0.05	-0.03	0.04	0.03	1.47	6.18	0.05	0.06	0.06	0.07	0.06	-0.04	0.08	38.73		
525	0.03	0.07	0.05	-0.03	0.04	0.03	1.51	5.24	0.04	0.04	0.06	0.11	0.03	-0.04	0.17	38.65		
530	0.03	0.09	0.07	-0.03	0.04	0.05	1.44	5.87	0.04	0.04	0.04	0.11	0.06	0.00	0.17	38.92		
535	0.03	0.07	0.05	-0.03	0.02	0.01	1.49	6.65	0.05	0.06	0.06	0.11	0.03	0.00	0.21	38.76		
540	0.03	0.07	0.05	-0.03	0.03	0.03	1.51	6.16	0.07	0.04	0.04	0.07	0.06	0.00	0.08	38.62		
545	0.02	0.08	0.06	-0.03	0.03	0.03	1.45	6.98	0.05	0.06	0.04	0.07	0.03	0.04	0.08	38.78		
550	0.03	0.08	0.05	-0.03	0.04	0.03	1.36	6.31	0.05	0.06	0.02	0.07	0.06	0.00	0.04	38.34		
555	0.03	0.07	0.05	-0.03	0.01	0.03	1.44	6.16	0.04	0.04	0.04	0.00	0.03	0.00	0.08	38.34		
560	0.03	0.06	0.04	-0.03	0.03	0.03	1.38	6.87	0.04	0.04	0.02	0.00	0.03	0.00	0.17	38.42		
565	0.03	0.06	0.04	-0.03	0.02	0.02	1.45	6.05	0.04	0.04	0.04	0.07	0.03	0.00	0.17	38.73		
570	0.03	0.07	0.05	-0.03	0.05	0.03	1.44	6.40	0.04	0.08	0.06	0.07	0.03	0.00	0.29	38.84		
575	0.03	0.07	0.05	-0.03	0.04	0.03	1.45	5.99	0.04	0.04	0.04	0.00	0.06	0.00	0.21	38.79		
580	0.03	0.06	0.04	-0.03	0.04	0.02	1.40	6.76	0.04	0.06	0.06	0.11	0.06	0.04	0.17	38.54		
585	0.02	0.07	0.05	-0.03	0.06	0.02	1.42	6.34	0.05	0.04	0.04	0.00	0.03	0.00	0.08	38.67		
590	0.03	0.07	0.05	-0.03	0.05	0.02	1.36	6.23	0.05	0.06	0.04	0.07	0.03	0.00	0.21	38.56		
595	0.02	0.07	0.05	-0.03	0.05	0.01	1.53	5.85	0.04	0.08	0.02	0.00	0.03	0.04	0.17	38.59		
600	0.02	0.07	0.04	-0.03	0.05	0.02	1.45	6.78	0.05	0.10	0.04	0.07	0.03	0.00	0.08	38.95		
660	0.03	0.07	0.04	-0.03	0.05	0.02	1.42	5.74	0.05	0.06	0.04	0.11	0.06	0.00	0.08	38.59		
720	0.02	0.09	0.06	-0.03	0.00	0.00	2.04	5.24	0.05	0.04	0.02	0.11	0.09	0.04	0.00	42.82		
780	0.03	0.09	0.06	-0.03	0.02	0.02	1.98	5.10	0.04	0.00	0.02	0.00	0.06	0.00	0.04	42.82		
840	0.02	0.09	0.07	-0.03	0.05	0.03	2.08	5.13	0.02	0.00	0.04	0.07	0.06	0.00	0.00	42.97		
900	0.02	0.09	0.07	-0.03	0.05	0.03	2.06	4.71	0.02	-0.02	0.02	0.00	0.03	0.00	0.04	42.77		
1020	0.02	0.09	0.07	-0.03	0.02	0.01	2.04	5.12	0.04	-0.02	0.02	0.07	0.06	0.00	0.00	42.72		
1080	0.03	0.09	0.07	-0.03	0.06	0.03	2.06	4.40	0.04	-0.02	0.02	0.07	0.03	-0.04	0.00	42.82		
1140	0.03	0.09	0.07	-0.03	0.04	0.02	2.02	5.21	0.02	-0.02	0.02	0.00	0.03	0.00	0.00	43.07		

DAPL DATA LOG	XOM-Buffalo, NY Terminal 10/22/03 16:51:21 TPE							XWell: LF-6 Test 3										HighVac AirFlow	Time	Notes
elapsed time (sec)	VERMW-3 Vac Resp (in WC)	VERMW-4 Vac Resp (in WC)	VERMW-2 Vac Resp (in WC)	VERMW-1 Vac Resp (in WC)	MW-28 Vac Resp (in WC)	MW-3URS Vac Resp (in WC)	Well Vacuum (inHg)	Straw Vacuum (inHg)	VERMW-3 GW DD (feet)	VERMW-4 GW DD (feet)	VERMW-2 GW DD (feet)	VERMW-1 GW DD (feet)	MW-28 GW DD (feet)	MW-3URS GW DD (feet)	LF-6 GW DD (feet)	HighVac AirFlow (scfm)	Time	Notes		
19380	0.02	0.09	0.06	-0.03	0.04	0.03	1.87	4.80	-0.13	-0.17	-0.15	-0.11	-0.12	-0.16	-0.16	43.07	22:14:21			
19440	0.02	0.09	0.06	-0.03	0.04	0.02	1.89	5.24	-0.13	-0.17	-0.13	-0.15	-0.12	-0.16	-0.16	43.22	22:15:21			
19500	0.03	0.08	0.06	-0.03	0.05	0.04	1.87	5.30	-0.11	-0.19	-0.13	-0.11	-0.09	-0.16	-0.16	43.12	22:16:21			
19560	0.02	0.09	0.06	-0.03	0.03	0.02	1.87	4.97	-0.11	-0.19	-0.13	-0.15	-0.12	-0.16	-0.20	43.00	22:17:21			
19620	0.02	0.08	0.06	-0.03	0.01	0.00	1.89	5.02	-0.13	-0.17	-0.13	-0.15	-0.12	-0.20	-0.16	43.12	22:18:21			
19680	0.02	0.09	0.07	-0.03	0.01	0.01	1.93	4.66	-0.13	-0.17	-0.13	-0.11	-0.09	-0.12	-0.16	43.09	22:19:21			
19740	0.03	0.09	0.07	-0.03	0.05	0.03	1.86	4.91	-0.15	-0.17	-0.13	-0.11	-0.12	-0.16	-0.16	43.12	22:20:21			
19800	0.03	0.09	0.07	-0.03	0.04	0.03	1.93	4.64	-0.11	-0.21	-0.15	-0.15	-0.09	-0.16	-0.16	42.97	22:21:21			
19860	0.03	0.09	0.07	-0.03	0.03	0.01	1.91	4.48	-0.13	-0.25	-0.15	-0.11	-0.09	-0.16	-0.16	43.00	22:22:21			
19920	0.02	0.09	0.07	-0.03	0.03	0.03	1.89	4.11	-0.11	-0.23	-0.15	-0.15	-0.09	-0.16	-0.20	43.00	22:23:21			
19980	0.02	0.08	0.06	-0.03	0.05	0.02	1.93	4.82	-0.13	-0.25	-0.13	-0.11	-0.09	-0.16	-0.16	43.14	22:24:21			
20040	0.02	0.09	0.06	-0.03	0.01	0.02	1.91	4.93	-0.11	-0.23	-0.13	-0.11	-0.09	-0.16	-0.16	43.00	22:25:21			
20100	0.02	0.09	0.07	-0.03	0.05	0.02	1.91	4.35	-0.11	-0.27	-0.17	-0.15	-0.12	-0.20	-0.20	43.14	22:26:21			
20160	0.02	0.09	0.06	-0.03	0.04	0.02	1.87	4.35	-0.13	-0.25	-0.13	-0.11	-0.09	-0.16	-0.16	43.02	22:27:21			
20220	0.02	0.09	0.06	-0.03	0.00	0.01	1.89	5.12	-0.13	-0.23	-0.13	-0.11	-0.12	-0.20	-0.16	43.00	22:28:21			
20280	0.02	0.08	0.06	-0.03	0.04	0.03	1.87	4.93	-0.13	-0.21	-0.13	-0.11	-0.12	-0.20	-0.16	43.07	22:29:21			
20340	0.03	0.09	0.06	-0.03	0.04	0.02	1.89	4.82	-0.13	-0.23	-0.15	-0.15	-0.09	-0.16	-0.16	42.95	22:30:21			
20400	0.03	0.09	0.06	-0.03	0.06	0.03	1.91	4.71	-0.15	-0.21	-0.15	-0.15	-0.12	-0.16	-0.16	42.92	22:31:21			
20460	0.02	0.09	0.07	-0.03	0.05	0.03	1.91	5.10	-0.13	-0.19	-0.15	-0.15	-0.09	-0.20	-0.16	42.92	22:32:21			
20520	0.02	0.09	0.06	-0.03	0.03	0.02	1.89	5.17	-0.15	-0.21	-0.15	-0.15	-0.09	-0.16	-0.16	43.09	22:33:21			
20580	0.02	0.10	0.07	-0.03	0.02	0.01	1.91	5.06	-0.15	-0.23	-0.17	-0.11	-0.09	-0.16	-0.16	43.09	22:34:21			
20640	0.02	0.09	0.06	-0.03	0.02	0.00	1.91	4.68	-0.13	-0.21	-0.15	-0.11	-0.15	-0.16	-0.16	43.02	22:35:21			
20700	0.02	0.09	0.07	-0.03	0.05	0.02	1.91	5.02	-0.15	-0.21	-0.17	-0.15	-0.12	-0.16	-0.16	42.95	22:36:21			
20760	0.03	0.09	0.06	-0.03	0.03	0.03	1.91	4.62	-0.15	-0.19	-0.15	-0.15	-0.12	-0.20	-0.20	42.95	22:37:21			
20820	0.03	0.09	0.07	-0.03	0.06	0.03	1.91	4.80	-0.13	-0.17	-0.15	-0.11	-0.12	-0.16	-0.16	43.09	22:38:21			
20880	0.03	0.09	0.06	-0.03	0.02	0.02	1.87	4.95	-0.17	-0.17	-0.15	-0.11	-0.09	-0.16	-0.20	42.75	22:39:21			
20940	0.02	0.09	0.06	-0.03	0.02	0.00	1.89	4.37	-0.15	-0.17	-0.15	-0.15	-0.12	-0.16	-0.12	42.97	22:40:21			
21000	0.02	0.09	0.06	-0.03	0.03	0.02	1.93	4.69	-0.15	-0.23	-0.17	-0.15	-0.09	-0.16	-0.24	42.97	22:41:21			
21060	0.02	0.09	0.06	-0.03	0.03	0.03	1.87	5.30	-0.15	-0.21	-0.17	-0.19	-0.15	-0.24	-0.16	42.85	22:42:21			
21120	0.02	0.08	0.06	-0.03	0.03	0.02	1.93	4.60	-0.15	-0.23	-0.15	-0.15	-0.15	-0.20	-0.20	42.90	22:43:21			
21180	0.02	0.08	0.06	-0.03	0.04	0.02	1.87	4.57	-0.13	-0.19	-0.15	-0.15	-0.15	-0.20	-0.16	43.00	22:44:21			
21240	0.02	0.08	0.06	-0.03	0.03	0.04	1.84	4.93	-0.15	-0.19	-0.19	-0.15	-0.12	-0.20	-0.20	42.87	22:45:21			
21300	0.02	0.09	0.06	-0.03	0.03	0.01	1.91	4.51	-0.17	-0.21	-0.17	-0.15	-0.12	-0.20	-0.20	42.95	22:46:21			
21360	0.02	0.09	0.06	-0.03	0.03	0.01	1.89	4.80	-0.13	-0.19	-0.17	-0.19	-0.12	-0.20	-0.20	43.09	22:47:21			
21420	0.03	0.09	0.07	-0.03	0.06	0.03	1.87	4.84	-0.13	-0.21	-0.17	-0.15	-0.15	-0.20	-0.20	42.90	22:48:21			
21480	0.02	0.09	0.06	-0.03	0.02	0.00	1.89	4.66	-0.17	-0.19	-0.15	-0.15	-0.15	-0.20	-0.16	42.92	22:49:21			
21540	0.03	0.09	0.07	-0.03	0.03	0.03	1.91	5.19	-0.17	-0.23	-0.17	-0.19	-0.12	-0.20	-0.16	43.00	22:50:21			
21600	0.02	0.08	0.06	-0.03	0.01	0.00	1.91	4.49	-0.15	-0.21	-0.17	-0.19	-0.12	-0.20	-0.16	42.97	22:51:21			
21660	0.02	0.09	0.07	-0.03	0.05	0.02	1.93	4.31	-0.17	-0.19	-0.19	-0.19	-0.12	-0.20	-0.20	42.82	22:52:21			
21720	0.03	0.09	0.07	-0.03	0.05	0.03	1.86	5.21	-0.17	-0.23	-0.19	-0.11	-0.15	-0.16	-0.20	42.77	22:53:21			
21780	0.03	0.09	0.06	-0.03	0.03	0.02	1.87	4.84	-0.15	-0.17	-0.17	-0.11	-0.12	-0.20	-0.20	42.95	22:54:21			
21840	0.02	0.08	0.06	-0.03	0.03	0.02	1.89	4.66	-0.15	-0.17	-0.15	-0.15	-0.15	-0.24	-0.16	42.82	22:55:21			
21900	0.03	0.09	0.06	-0.03	0.05	0.02	1.89	5.13	-0.15	-0.17	-0.19	-0.15	-0.12	-0.20	-0.20	42.92	22:56:21			
21960	0.02	0.08	0.06	-0.03	0.05	0.01	1.89	4.75	-0.17	-0.19	-0.15	-0.19	-0.12	-0.20	-0.16	42.77	22:57:21			
22020	0.03	0.09	0.06	-0.03	0.03	0.02	1.87	5.19	-0.15	-0.19	-0.17	-0.15	-0.09	-0.20	-0.16	42.82	22:58:21			
22080	0.02	0.08	0.06	-0.03	0.03	0.01	1.93	4.57	-0.15	-0.19	-0.19	-0.15	-0.12	-0.20	-0.24	42.62	22:59:21			
22140	0.03	0.09	0.07	-0.03	0.03	0.02	1.91	4.71	-0.15	-0.23	-0.17	-0.15	-0.12	-0.20	-0.20	42.77	23:00:21			
22200	0.02	0.08	0.06	-0.03	0.04	0.03	1.95	4.57	-0.17	-0.21	-0.17	-0.19	-0.15	-0.20	-0.24	42.75	23:01:21			
22260	0.02	0.09	0.06	-0.03	0.03	0.02	1.86	5.04	-0.15	-0.23	-0.17	-0.15	-0.12	-0.20	-0.24	42.49	23:02:21			
22320	0.03	0.09	0.06	-0.03	0.01	0.02	1.89	5.19	-0.15	-0.21	-0.17	-0.19	-0.12	-0.20	-0.20	42.57	23:03:21			
22380	0.03	0.09	0.07	-0.03	0.04	0.03	1.84	4.93	-0.17	-0.23	-0.19	-0.19	-0.18	-0.24	-0.20	42.44	23:04:21			
22440	0.03	0.09	0.07	-0.03	0.03	0.03	1.87	4.93	-0.19	-0.25	-0.19	-0.15	-0.12	-0.20	-0.20	42.57	23:05:21			
22500	0.02	0.08	0.06	-0.03	0.01	0.01	1.91	4.38	-0.19	-0.27	-0.19	-0.19	-0.18	-0.20	-0.24	42.49	23:06:21			
22560	0.02	0.09	0.06	-0.03	0.02	0.00	1.87	4.77	-0.17	-0.25	-0.21	-0.15	-0.15	-0.20	-0.16	42.70	23:07:21			
22620	0.01	0.08	0.05	-0.03	0.01	0.02	1.84	5.08	-0.17	-0.29	-0.21	-0.19	-0.15	-0.20	-0.24	42.27	23:08:21			
22680	0.02	0.09	0.07	-0.03	0.06	0.05	1.89	5.24	-0.17	-0.27	-0.19	-0.15	-0.15	-0.24	-0.16	42.72	23:09:21			
22740	0.03	0.09	0.07	-0.03	0.06	0.04	1.87	4.99	-0.17	-0.27	-0.19	-0.19	-0.12	-0.20	-0.20	42.62	23:10:21			
22800	0.02	0.09	0.06	-0.03	0.05	0.04	1.84	5.45	-0.19	-0.29	-0.19	-0.15	-0.12	-0.24	-0.24	42.60	23:11:21			
22860	0.03	0.09	0.06	-0.03	0.05	0.02	1.82	4.82	-0.19	-0.29	-0.21	-0.19	-0.12	-0.24	-0.24	42.27	23:12:21			
22920	0.02	0.08	0.06	-0.03	0.04	0.02	1.84	4.73	-0.17	-0.27	-0.21	-0.19	-0.15	-0.20	-0.24	42.47	23:13:21			

DAPL DATA LOG	XOM-Buffalo, NY Terminal							XWell: LF-6											Time	Notes
	10/22/03 16:51:21 TPE							Test 3												
elapsed time (sec)	VERMW-3 Vac Resp (in WC)	VERMW-4 Vac Resp (in WC)	VERMW-2 Vac Resp (in WC)	VERMW-1 Vac Resp (in WC)	MW-28 Vac Resp (in WC)	MW-3URS Vac Resp (in WC)	Well Vacuum (inHg)	Straw Vacuum (inHg)	VERMW-3 GW DD (feet)	VERMW-4 GW DD (feet)	VERMW-2 GW DD (feet)	VERMW-1 GW DD (feet)	MW-28 GW DD (feet)	MW-3URS GW DD (feet)	LF-6 GW DD (feet)	HighVac AirFlow (scfm)				
30240	0.02	0.09	0.07	-0.03	0.04	0.03	1.97	4.75	-0.04	-0.15	-0.05	-0.04	-0.06	-0.08	-0.04	43.71				
30300	0.02	0.09	0.07	-0.03	0.03	0.02	1.98	4.95	-0.02	-0.13	-0.03	0.00	0.00	0.00	-0.04	43.73				
30360	0.02	0.09	0.07	-0.03	0.06	0.04	2.02	4.60	-0.04	-0.13	-0.03	0.00	-0.03	-0.08	-0.08	43.78				
30420	0.02	0.09	0.07	-0.03	0.04	0.02	2.00	4.55	-0.02	-0.13	-0.03	0.00	0.00	-0.04	-0.08	43.83				
30480	0.02	0.09	0.07	-0.03	0.03	0.02	1.98	4.82	-0.02	-0.15	-0.03	-0.04	-0.03	-0.04	-0.04	43.61				
30540	0.03	0.10	0.08	-0.03	0.03	0.03	2.00	4.80	0.00	-0.13	-0.03	-0.04	-0.03	-0.08	0.00	43.81				
30600	0.03	0.10	0.07	-0.03	0.04	0.02	2.00	4.38	0.00	-0.09	-0.03	-0.04	0.03	-0.04	0.00	43.73				
30660	0.03	0.09	0.07	-0.03	0.04	0.02	2.02	4.58	-0.04	-0.13	-0.03	-0.04	0.00	-0.04	-0.04	43.88				
30720	0.03	0.09	0.07	-0.03	0.02	0.02	2.02	4.11	-0.02	-0.11	-0.03	-0.04	-0.03	-0.04	-0.08	43.76				
30780	0.02	0.09	0.07	-0.03	0.05	0.04	2.02	4.66	0.00	-0.11	-0.03	0.00	-0.03	0.00	-0.04	43.78				
30840	0.02	0.09	0.07	-0.03	0.03	0.03	2.00	5.02	0.02	-0.11	-0.03	0.00	0.00	0.00	0.00	43.86				
30900	0.02	0.09	0.07	-0.03	0.03	0.03	2.06	4.66	0.00	-0.09	-0.03	0.00	-0.03	-0.04	-0.04	43.81				
30960	0.02	0.09	0.07	-0.03	0.03	0.02	2.04	4.13	0.00	-0.11	0.00	0.00	0.03	-0.04	-0.04	43.81				
31020	0.02	0.09	0.07	-0.03	0.04	0.02	2.00	4.57	0.00	-0.13	-0.03	0.00	-0.03	-0.04	0.00	43.76				
31080	0.02	0.09	0.07	-0.03	0.03	0.01	2.00	4.69	0.02	-0.09	0.00	-0.04	0.00	-0.04	0.00	43.95				
31140	0.02	0.09	0.07	-0.03	0.05	0.04	2.02	4.11	0.00	-0.13	0.00	0.00	0.00	-0.08	-0.04	43.76				
31200	0.02	0.09	0.07	-0.03	0.04	0.02	2.06	4.20	0.02	-0.11	0.00	0.00	0.00	-0.04	-0.04	44.08				
31260	0.02	0.10	0.07	-0.03	0.03	0.02	2.02	4.69	0.00	-0.11	-0.03	0.00	0.00	-0.04	-0.04	43.98				
31380	0.02	0.09	0.07	-0.03	0.04	0.03	2.06	4.57	0.00	-0.09	-0.03	0.00	0.00	-0.08	0.00	44.03				
31440	0.03	0.09	0.07	-0.03	0.02	0.02	2.00	4.15	0.00	-0.07	0.00	0.00	0.00	-0.08	0.04	44.00				
31500	0.02	0.09	0.07	-0.03	0.03	0.02	1.98	4.97	0.00	-0.09	-0.03	0.00	0.00	-0.04	-0.04	44.00				
31560	0.02	0.09	0.07	-0.03	0.04	0.03	2.00	4.44	0.00	-0.09	0.00	0.00	-0.03	-0.04	0.00	43.91				
31620	0.03	0.10	0.07	-0.03	0.03	0.02	2.00	4.53	0.00	-0.09	0.00	0.00	0.00	-0.04	-0.04	43.76				
31680	0.02	0.09	0.07	-0.03	0.05	0.02	2.04	4.55	0.00	-0.11	0.02	0.00	0.00	0.00	0.00	44.08				
31800	0.02	0.09	0.07	-0.03	0.04	0.02	2.04	4.71	0.02	-0.11	-0.03	-0.04	-0.03	-0.04	-0.04	44.03				
31860	0.02	0.09	0.07	-0.03	0.03	0.02	2.04	4.05	0.00	-0.13	-0.03	-0.04	0.03	-0.04	0.00	44.00				
31920	0.02	0.09	0.07	-0.03	0.03	0.02	2.02	4.05	0.00	-0.11	0.00	0.00	0.03	-0.04	0.00	44.00				
31980	0.03	0.09	0.07	-0.03	0.05	0.03	1.98	4.90	0.00	-0.09	0.00	0.00	0.03	-0.04	-0.04	44.05				
32040	0.03	0.09	0.07	-0.03	0.03	0.02	2.04	4.26	-0.02	-0.13	-0.03	0.00	0.00	-0.04	0.00	43.81				
32100	0.02	0.09	0.07	-0.03	0.04	0.03	2.02	4.20	-0.02	-0.11	-0.03	0.00	0.00	-0.08	-0.04	43.83				
32160	0.02	0.09	0.06	-0.03	0.01	0.01	2.00	4.44	-0.02	-0.11	-0.03	-0.04	-0.03	-0.08	-0.04	43.88				
32220	0.02	0.09	0.07	-0.03	0.04	0.02	2.00	4.64	0.00	-0.13	-0.03	0.00	0.00	-0.04	0.00	43.98				
32280	0.02	0.09	0.07	-0.03	0.03	0.03	2.02	4.53	0.00	-0.15	-0.03	-0.04	-0.03	-0.04	-0.04	43.88				
32340	0.02	0.09	0.07	-0.03	0.03	0.04	2.02	4.26	0.00	-0.13	-0.03	0.00	0.00	0.00	-0.04	43.73				
32400	0.03	0.09	0.07	-0.03	0.05	0.03	2.00	4.88	-0.02	-0.15	-0.05	0.00	-0.03	-0.08	0.00	43.69				
32460	0.03	0.09	0.07	-0.03	0.04	0.03	1.95	4.88	-0.02	-0.13	-0.05	-0.04	-0.03	-0.04	-0.08	43.69				
32520	0.02	0.09	0.07	-0.03	0.03	0.02	1.98	4.88	-0.02	-0.15	-0.03	0.00	0.00	-0.08	0.00	43.91				
32580	0.02	0.09	0.07	-0.03	0.04	0.02	2.02	4.55	-0.02	-0.13	-0.05	-0.04	-0.03	-0.08	0.00	43.69				
32640	0.03	0.09	0.07	-0.03	0.04	0.03	1.98	4.27	-0.04	-0.15	-0.03	-0.04	0.00	-0.04	-0.08	43.61				
32700	0.03	0.09	0.07	-0.03	0.03	0.04	2.00	4.71	-0.02	-0.15	-0.03	-0.04	-0.03	-0.08	-0.04	43.66				
32760	0.03	0.10	0.07	-0.03	0.03	0.02	2.02	4.33	-0.04	-0.15	-0.05	-0.04	0.00	-0.08	-0.04	43.69				
32820	0.03	0.09	0.07	-0.03	0.03	0.02	1.95	4.82	-0.02	-0.13	-0.05	-0.04	0.00	-0.04	-0.04	43.78				
32880	0.02	0.09	0.06	-0.03	0.03	0.02	2.02	4.51	-0.04	-0.15	-0.05	-0.04	-0.03	-0.08	-0.04	43.64				
32940	0.03	0.09	0.07	-0.03	0.01	0.02	2.02	4.27	-0.06	-0.15	-0.05	-0.04	0.00	-0.08	0.00	43.61				
33000	0.02	0.09	0.07	-0.03	0.03	0.01	2.02	4.58	-0.04	-0.15	-0.05	0.00	0.00	-0.04	-0.08	43.78				
33060	0.03	0.10	0.07	-0.03	0.02	0.02	1.93	5.02	-0.06	-0.17	-0.07	-0.04	-0.03	-0.08	-0.08	43.69				
33120	0.02	0.09	0.06	-0.03	0.03	0.02	1.95	4.62	-0.04	-0.23	-0.07	-0.04	-0.03	-0.04	0.00	43.69				
33240	0.03	0.09	0.07	-0.03	0.03	0.02	1.95	4.49	-0.06	-0.17	-0.05	-0.08	-0.03	-0.08	-0.08	43.64				
33300	0.02	0.09	0.07	-0.03	0.03	0.02	2.00	4.84	-0.04	-0.23	-0.07	-0.04	-0.03	-0.08	-0.08	43.73				
33360	0.02	0.09	0.07	-0.03	0.03	0.02	1.98	4.33	-0.04	-0.19	-0.05	-0.04	-0.06	-0.08	-0.04	43.61				
33420	0.02	0.09	0.06	-0.03	0.03	0.02	1.98	4.58	-0.04	-0.19	-0.05	-0.04	-0.03	-0.08	-0.08	43.61				
33480	0.03	0.09	0.07	-0.03	0.03	0.02	1.98	5.01	-0.06	-0.17	-0.05	-0.04	-0.03	-0.08	-0.04	43.59				
33600	0.03	0.09	0.07	-0.03	0.06	0.03	1.97	5.32	-0.04	-0.15	-0.05	-0.08	-0.03	-0.08	-0.12	43.39				
33660	0.02	0.09	0.07	-0.03	0.04	0.02	2.00	4.44	-0.04	-0.17	-0.05	-0.08	0.00	-0.04	-0.08	43.47				
33720	0.03	0.09	0.07	-0.03	0.03	0.02	2.00	4.26	-0.04	-0.15	-0.05	-0.04	-0.03	-0.12	-0.04	43.44				
33780	0.02	0.09	0.07	-0.03	0.03	0.03	1.97	4.58	-0.04	-0.19	-0.07	0.00	-0.03	-0.08	-0.04	43.51				
33840	0.02	0.09	0.07	-0.03	0.03	0.02	1.97	4.80	-0.06	-0.17	-0.07	-0.08	0.00	-0.08	-0.08	43.44				
33900	0.03	0.09	0.06	-0.03	0.03	0.01	1.95	4.86	-0.04	-0.17	-0.05	0.00	-0.03	-0.08	-0.04	43.37				
33960	0.02	0.09	0.07	-0.03	0.03	0.03	1.98	4.51	-0.04	-0.17	-0.03	-0.04	0.00	-0.08	-0.08	43.42				
34020	0.03	0.09	0.07	-0.03	0.04	0.03	1.98	4.05	-0.06	-0.21	-0.05	-0.08	0.00	-0.04	-0.04	43.27				

DAPL DATA LOG	XOM-Buffalo,NYTerminal						XWell: LF-6											HighVac AirFlow (scfm)	Time	Notes
	10/22/03	16:51:21	TPE				Test 3													
elapsed time (sec)	VERMW-3 Vac Resp (in WC)	VERMW-4 Vac Resp (in WC)	VERMW-2 Vac Resp (in WC)	VERMW-1 Vac Resp (in WC)	MW-28 Vac Resp (in WC)	MW-3URS Vac Resp (in WC)	Well Vacuum (inHg)	Straw Vacuum (inHg)	VERMW-3 GW DD (feet)	VERMW-4 GW DD (feet)	VERMW-2 GW DD (feet)	VERMW-1 GW DD (feet)	MW-28 GW DD (feet)	MW-3URS GW DD (feet)	LF-6 GW DD (feet)					
34080	0.03	0.09	0.07	-0.03	0.03	0.02	1.97	4.38	-0.02	-0.21	-0.07	-0.04	-0.03	-0.04	-0.08					
34140	0.03	0.09	0.07	-0.03	0.05	0.03	2.02	4.38	-0.02	-0.19	-0.05	0.00	-0.03	-0.04	-0.04					
34200	0.02	0.09	0.07	-0.03	0.03	0.01	2.00	4.48	-0.06	-0.17	-0.05	-0.04	-0.06	-0.04	-0.04					
34260	0.03	0.09	0.07	-0.03	0.03	0.02	1.97	4.71	-0.04	-0.19	-0.05	-0.04	-0.03	-0.08	-0.08					
34320	0.02	0.09	0.07	-0.03	0.03	0.02	2.00	4.57	-0.04	-0.23	-0.05	-0.04	-0.03	-0.04	-0.08					
34380	0.03	0.09	0.07	-0.03	0.05	0.03	1.97	4.62	-0.02	-0.21	-0.07	-0.08	-0.03	-0.08	-0.04					
34440	0.02	0.09	0.07	-0.03	0.03	0.02	2.00	4.57	-0.04	-0.21	-0.05	-0.04	-0.03	-0.08	-0.04					
34500	0.02	0.09	0.07	-0.03	0.03	0.02	2.02	4.57	-0.04	-0.21	-0.05	-0.04	-0.03	-0.04	-0.04					
34560	0.02	0.09	0.07	-0.03	0.05	0.02	2.00	4.33	-0.04	-0.21	-0.05	0.00	0.00	-0.08	-0.04					
34620	0.02	0.09	0.07	-0.03	0.03	0.02	1.98	4.60	-0.02	-0.23	-0.03	0.00	-0.03	-0.08	-0.08					
34680	0.02	0.09	0.07	-0.03	0.04	0.02	1.98	5.04	-0.04	-0.25	-0.07	-0.04	-0.03	-0.04	-0.08					
34740	0.03	0.09	0.07	-0.03	0.04	0.03	2.02	4.29	-0.04	-0.25	-0.05	-0.04	-0.03	-0.04	-0.12					
34800	0.02	0.09	0.06	-0.03	0.01	0.00	1.98	4.26	-0.06	-0.25	-0.05	-0.04	-0.03	-0.08	-0.08					
34860	0.03	0.09	0.07	-0.03	0.03	0.03	2.04	3.96	-0.04	-0.19	-0.05	-0.04	-0.03	-0.08	-0.08					
34920	0.03	0.09	0.07	-0.03	0.03	0.03	1.98	4.55	-0.02	-0.21	-0.05	-0.04	-0.03	-0.08	-0.04					
34980	0.03	0.09	0.07	-0.03	0.03	0.03	1.97	4.91	-0.02	-0.23	-0.05	0.00	0.00	-0.08	-0.04					
35040	0.03	0.09	0.07	-0.03	0.03	0.03	2.00	4.58	-0.04	-0.21	-0.03	-0.04	0.00	-0.08	-0.04					
35100	0.03	0.09	0.07	-0.03	0.05	0.03	1.98	4.49	-0.04	-0.25	-0.05	-0.04	0.00	-0.08	-0.08					
35160	0.03	0.09	0.07	-0.03	0.05	0.03	2.00	4.22	-0.04	-0.23	-0.03	-0.04	-0.06	-0.04	-0.04					
35220	0.02	0.09	0.07	-0.03	0.03	0.03	2.00	4.71	-0.02	-0.25	-0.05	-0.04	-0.03	-0.04	-0.04					
35280	0.02	0.09	0.07	-0.03	0.03	0.03	1.98	4.31	-0.02	-0.21	-0.03	-0.04	-0.03	-0.08	-0.04					
35340	0.03	0.09	0.07	-0.03	0.05	0.03	2.04	4.49	-0.02	-0.21	-0.03	0.00	-0.03	-0.08	-0.08					
35400	0.02	0.09	0.07	-0.03	0.03	0.01	2.02	4.66	-0.02	-0.25	-0.05	-0.04	-0.03	-0.04	-0.08					
35460	0.02	0.09	0.07	-0.03	0.03	0.00	1.97	4.80	-0.02	-0.21	-0.03	-0.04	-0.03	-0.04	-0.04					
35520	0.02	0.09	0.07	-0.03	0.02	0.00	2.04	4.49	-0.02	-0.19	0.00	0.00	-0.03	-0.08	-0.08					
35580	0.02	0.09	0.06	-0.03	0.02	0.02	2.00	4.73	-0.02	-0.21	-0.03	-0.04	-0.03	-0.04	-0.04					
35640	0.03	0.09	0.07	-0.03	0.05	0.03	1.95	5.08	-0.02	-0.17	-0.03	-0.04	0.00	-0.04	-0.04					
35700	0.02	0.09	0.07	-0.03	0.03	0.01	2.04	4.33	-0.02	-0.19	-0.03	0.00	-0.03	-0.04	0.00					
35760	0.02	0.09	0.07	-0.03	0.03	0.02	2.02	4.46	-0.02	-0.15	-0.03	-0.04	-0.03	0.00	0.00					
35820	0.03	0.10	0.07	-0.03	0.03	0.03	2.04	4.20	0.00	-0.17	-0.03	0.07	-0.03	-0.04	0.00					
35880	0.03	0.09	0.07	-0.03	0.02	0.02	2.00	4.33	-0.02	-0.13	0.00	0.00	-0.03	-0.04	-0.04					
35940	0.02	0.10	0.07	-0.03	0.03	0.02	2.06	4.24	0.00	-0.15	0.00	0.00	0.00	-0.04	0.00					
36000	0.03	0.09	0.07	-0.03	0.05	0.04	2.06	4.88	0.00	-0.15	0.02	0.00	-0.03	-0.04	0.00					
36060	0.03	0.09	0.07	-0.03	0.03	0.02	2.04	4.48	0.02	-0.15	0.02	0.00	-0.03	-0.04	0.00					
36120	0.02	0.09	0.07	-0.03	0.03	0.01	2.02	4.68	0.00	-0.15	0.00	0.00	-0.03	-0.04	-0.04					
36180	0.03	0.09	0.07	-0.03	0.05	0.03	2.02	4.93	0.04	-0.15	0.00	0.00	0.00	-0.04	0.00					
36240	0.02	0.09	0.07	-0.03	0.02	0.02	2.06	4.20	0.02	-0.15	0.04	0.07	0.00	0.00	0.04					
36300	0.03	0.10	0.07	-0.03	0.02	0.02	2.06	4.26	0.04	-0.11	0.02	0.07	0.00	0.00	0.04					
36360	0.02	0.09	0.07	-0.03	0.01	0.02	2.06	4.46	0.04	-0.09	0.04	0.00	0.00	0.00	0.00					
36420	0.02	0.09	0.07	-0.03	0.03	0.03	2.06	4.40	0.04	-0.13	0.02	0.07	0.00	0.04	0.04					
36480	0.02	0.09	0.07	-0.03	0.03	0.01	2.04	4.46	0.05	-0.11	0.04	0.07	-0.03	0.00	0.00					
36540	0.02	0.09	0.07	-0.03	0.03	0.01	2.06	4.95	0.05	-0.11	0.04	0.07	-0.03	0.00	0.04					
36600	0.03	0.10	0.07	-0.03	0.05	0.03	2.06	4.90	0.05	-0.11	0.06	0.07	-0.03	0.04	0.08					
36660	0.03	0.10	0.07	-0.03	0.03	0.02	2.09	4.75	0.07	-0.09	0.06	0.07	-0.03	0.00	0.04					
36720	0.02	0.10	0.07	-0.03	0.03	0.03	2.09	4.26	0.07	-0.09	0.06	0.07	-0.03	0.04	0.08					
36780	0.02	0.10	0.07	-0.03	0.03	0.02	2.09	4.26	0.09	-0.07	0.08	0.11	-0.03	0.04	0.08					
36840	0.02	0.10	0.07	-0.03	0.03	0.02	2.09	4.51	0.09	-0.09	0.08	0.11	0.00	0.04	0.08					
36900	0.03	0.10	0.07	-0.03	0.03	0.02	2.09	4.27	0.09	-0.04	0.06	0.11	0.00	0.08	0.08					
36960	0.03	0.10	0.07	-0.03	0.02	0.02	2.04	4.91	0.09	-0.13	0.10	0.11	-0.03	0.00	0.08					
37020	0.02	0.09	0.07	-0.03	0.04	0.03	2.11	4.16	0.09	-0.04	0.08	0.11	0.00	0.04	0.17					
37080	0.02	0.09	0.07	-0.03	0.04	0.01	2.06	4.18	0.09	-0.07	0.10	0.11	0.00	0.04	0.08					
37140	0.02	0.10	0.07	-0.03	0.04	0.02	2.09	4.62	0.11	-0.07	0.10	0.15	-0.03	0.08	0.17					
37200	0.02	0.09	0.07	-0.03	0.03	0.02	2.11	4.73	0.11	-0.04	0.10	0.15	-0.03	0.08	0.08					
37260	0.02	0.09	0.07	-0.03	0.03	0.02	2.11	4.33	0.13	-0.02	0.12	0.15	-0.03	0.04	0.08					
37320	0.03	0.09	0.07	-0.03	0.04	0.02	2.09	4.38	0.11	-0.07	0.10	0.15	0.00	0.08	0.17					
37380	0.02	0.10	0.07	-0.03	0.03	0.02	2.11	4.57	0.15	-0.04	0.12	0.11	-0.03	0.08	0.17					
37440	0.02	0.09	0.07	-0.03	0.03	0.02	2.06	4.88	0.13	-0.04	0.12	0.15	-0.06	0.08	0.08					
37500	0.02	0.10	0.07	-0.03	0.03	0.01	2.11	4.40	0.11	-0.07	0.12	0.15	-0.03	0.08	0.21					
37560	0.03	0.10	0.07	-0.03	0.02	0.02	2.11	4.20	0.13	-0.04	0.10	0.15	-0.03	0.12	0.17					
37620	0.02	0.09	0.07	-0.03	0.03	0.02	2.11	4.13	0.13	-0.04	0.12	0.15	-0.03	0.12	0.17					

DAPL DATA LOG	XOM-Buffalo,NYTerminal						XWell: LF-6											HighVac AirFlow (scfm)	Time	Notes
	10/22/03	16:51:21	TPE				Test 3													
elapsed time (sec)	VERMW-3 Vac Resp (in WC)	VERMW-4 Vac Resp (in WC)	VERMW-2 Vac Resp (in WC)	VERMW-1 Vac Resp (in WC)	MW-28 Vac Resp (in WC)	MW-3URS Vac Resp (in WC)	Well Vacuum (inHg)	Straw Vacuum (inHg)	VERMW-3 GW DD (feet)	VERMW-4 GW DD (feet)	VERMW-2 GW DD (feet)	VERMW-1 GW DD (feet)	MW-28 GW DD (feet)	MW-3URS GW DD (feet)	LF-6 GW DD (feet)					
37680	0.02	0.10	0.07	-0.03	0.03	0.00	2.04	4.44	0.13	-0.04	0.12	0.15	0.00	0.12	0.17					
37740	0.02	0.09	0.07	-0.03	0.03	0.03	2.11	4.18	0.11	-0.07	0.14	0.11	-0.03	0.08	0.08					
37800	0.03	0.10	0.07	-0.03	0.04	0.03	2.13	4.33	0.13	-0.04	0.12	0.11	-0.03	0.08	0.17					
37860	0.02	0.10	0.07	-0.03	0.05	0.04	2.11	4.37	0.13	-0.02	0.10	0.11	-0.03	0.04	0.04					
37920	0.02	0.09	0.07	-0.03	0.03	0.00	2.09	4.55	0.13	0.00	0.12	0.15	-0.03	0.08	0.17					
37980	0.02	0.09	0.07	-0.03	0.02	0.02	2.11	4.11	0.11	-0.04	0.10	0.15	-0.03	0.04	0.21					
38040	0.02	0.09	0.07	-0.03	0.04	0.02	2.08	4.29	0.11	-0.07	0.12	0.15	0.00	0.08	0.21					
38100	0.02	0.10	0.08	-0.03	0.03	0.03	2.13	3.96	0.13	-0.04	0.10	0.11	0.00	0.12	0.17					
38160	0.02	0.10	0.08	-0.03	0.05	0.03	2.13	4.09	0.13	-0.04	0.12	0.15	0.00	0.08	0.08					
38220	0.02	0.10	0.08	-0.03	0.05	0.02	2.08	4.58	0.13	-0.07	0.12	0.11	-0.03	0.12	0.17					
38280	0.03	0.10	0.07	-0.03	0.04	0.03	2.11	4.15	0.11	-0.04	0.10	0.15	-0.03	0.08	0.17					
38340	0.02	0.10	0.08	-0.03	0.02	0.02	2.09	4.66	0.11	-0.04	0.14	0.15	0.00	0.08	0.17					
38400	0.03	0.11	0.08	-0.03	0.06	0.04	2.11	4.55	0.11	-0.04	0.10	0.15	0.00	0.08	0.08					
38460	0.03	0.09	0.07	-0.03	0.05	0.03	2.11	4.24	0.11	-0.04	0.10	0.15	-0.03	0.08	0.17					
38520	0.03	0.10	0.08	-0.03	0.05	0.03	2.09	4.27	0.09	-0.04	0.12	0.15	0.00	0.08	0.08					
38580	0.03	0.10	0.07	-0.03	0.05	0.02	2.06	4.48	0.11	-0.07	0.12	0.15	-0.03	0.08	0.04					
38640	0.03	0.10	0.07	-0.03	0.03	0.02	2.09	4.13	0.11	-0.04	0.10	0.11	0.00	0.04	0.08					
38700	0.03	0.10	0.07	-0.03	0.05	0.02	2.08	4.35	0.09	-0.04	0.10	0.11	-0.03	0.08	0.04					
38760	0.02	0.09	0.06	-0.03	0.00	0.01	2.08	4.04	0.09	-0.09	0.08	0.11	-0.03	0.08	0.08					
38820	0.02	0.09	0.07	-0.03	0.03	0.03	2.06	4.62	0.09	-0.07	0.10	0.15	-0.03	0.12	0.17					
38880	0.02	0.09	0.07	-0.03	0.05	0.01	2.06	4.27	0.09	-0.09	0.10	0.15	-0.03	0.08	0.08					
38940	0.03	0.09	0.07	-0.03	0.03	0.03	2.06	4.49	0.07	-0.11	0.08	0.15	0.00	0.08	0.08					
39000	0.02	0.09	0.07	-0.03	0.04	0.03	2.09	4.33	0.09	-0.15	0.08	0.11	-0.03	0.04	0.08					
39060	0.02	0.09	0.06	-0.03	0.03	0.01	2.04	4.64	0.09	-0.11	0.06	0.15	0.00	0.04	0.04					
39120	0.02	0.09	0.07	-0.03	0.03	0.01	2.06	4.29	0.05	-0.09	0.08	0.11	-0.03	0.04	0.04					
39180	0.03	0.10	0.07	-0.03	0.03	0.02	2.06	4.09	0.09	-0.13	0.06	0.11	0.00	0.04	0.04					
39240	0.02	0.09	0.07	-0.03	0.03	0.02	2.04	4.71	0.05	-0.13	0.08	0.11	0.00	0.00	0.08					
39300	0.03	0.09	0.07	-0.03	0.03	0.02	2.09	4.55	0.07	-0.13	0.06	0.11	0.00	0.04	0.08					
39360	0.03	0.09	0.07	-0.03	0.05	0.02	2.06	4.73	0.05	-0.19	0.06	0.07	-0.06	0.04	0.08					
39420	0.03	0.10	0.07	-0.03	0.03	0.02	2.08	4.18	0.07	-0.17	0.08	0.11	-0.03	0.04	0.04					
39480	0.02	0.09	0.07	-0.03	0.03	0.02	2.06	4.60	0.05	-0.15	0.06	0.11	-0.06	0.08	0.17					
39540	0.02	0.09	0.07	-0.03	0.01	0.02	2.06	4.71	0.05	-0.15	0.06	0.11	-0.03	0.04	0.04					
39600	0.03	0.10	0.07	-0.03	0.03	0.01	2.02	4.84	0.05	-0.17	0.06	0.07	-0.06	0.00	0.04					
39660	0.02	0.09	0.07	-0.03	0.05	0.03	2.08	4.05	0.05	-0.13	0.06	0.11	-0.03	0.04	0.00					
39720	0.03	0.09	0.07	-0.03	0.05	0.03	2.08	4.29	0.04	-0.15	0.06	0.11	-0.03	0.00	0.08					
39780	0.02	0.10	0.07	-0.03	0.03	0.01	2.08	3.91	0.05	-0.13	0.06	0.11	0.00	0.00	0.04					
39840	0.03	0.09	0.07	-0.03	0.03	0.03	2.04	4.77	0.04	-0.13	0.06	0.11	-0.03	0.00	0.04					
39900	0.02	0.09	0.07	-0.03	0.03	0.02	2.06	4.73	0.05	-0.15	0.04	0.07	-0.03	0.04	0.04					
39960	0.03	0.09	0.07	-0.03	0.03	0.04	2.08	4.75	0.05	-0.15	0.04	0.07	-0.03	0.04	0.04					
40020	0.02	0.10	0.07	-0.03	0.01	0.02	2.04	4.53	0.04	-0.15	0.04	0.11	-0.03	0.00	0.04					
40080	0.02	0.09	0.07	-0.03	0.01	0.01	2.00	4.69	0.05	-0.15	0.06	0.07	-0.06	0.00	0.08					
40140	0.02	0.09	0.07	-0.03	0.05	0.03	2.08	4.64	0.05	-0.17	0.04	0.11	-0.03	0.00	0.04					
40200	0.02	0.09	0.07	-0.03	0.03	0.00	2.06	4.49	0.05	-0.17	0.04	0.11	-0.03	0.04	0.00					
40260	0.02	0.09	0.07	-0.03	0.03	0.01	2.04	4.49	0.05	-0.13	0.06	0.11	-0.06	0.04	0.04					
40320	0.03	0.09	0.07	-0.03	0.03	0.01	2.04	4.16	0.05	-0.13	0.06	0.07	-0.06	0.04	0.04					
40380	0.02	0.09	0.07	-0.03	0.05	0.03	2.06	4.31	0.05	-0.15	0.06	0.11	-0.03	0.04	0.04					
40440	0.03	0.10	0.07	-0.03	0.05	0.03	2.04	4.68	0.05	-0.11	0.06	0.11	0.00	0.04	0.00					
40500	0.02	0.09	0.07	-0.03	0.01	0.02	2.02	4.71	0.05	-0.15	0.04	0.07	0.00	0.04	0.04					
40560	0.02	0.10	0.07	-0.03	0.03	0.02	2.06	4.49	0.05	-0.13	0.06	0.11	-0.03	0.08	0.04					
40620	0.03	0.10	0.07	-0.03	0.03	0.04	2.04	4.82	0.05	-0.15	0.06	0.07	-0.06	0.08	0.04					
40680	0.03	0.09	0.07	-0.03	0.04	0.03	2.08	4.64	0.05	-0.15	0.06	0.11	-0.03	0.04	0.04					
40740	0.03	0.09	0.07	-0.03	0.05	0.03	2.09	4.07	0.05	-0.13	0.04	0.07	-0.06	0.08	0.00					
40800	0.02	0.10	0.07	-0.03	0.03	0.02	2.06	4.40	0.05	-0.15	0.06	0.11	-0.03	0.04	0.04					
40860	0.03	0.09	0.07	-0.03	0.04	0.03	2.11	4.48	0.07	-0.13	0.06	0.11	-0.03	0.04	0.04					
40920	0.02	0.09	0.07	-0.03	0.02	0.02	2.06	4.09	0.09	-0.13	0.08	0.07	-0.03	0.04	0.04					
40980	0.03	0.09	0.07	-0.03	0.03	0.02	2.08	4.38	0.07	-0.09	0.08	0.11	-0.03	0.04	0.08					
41040	0.03	0.09	0.07	-0.03	0.03	0.02	2.11	4.46	0.09	-0.11	0.08	0.11	-0.06	0.04	0.04					
41100	0.02	0.09	0.06	-0.03	0.03	0.02	2.04	4.64	0.05	-0.13	0.10	0.11	-0.03	0.04	0.08					
41160	0.02	0.09	0.07	-0.03	0.04	0.02	2.04	4.44	0.07	-0.09	0.08	0.15	-0.03	0.04	0.04					
41220	0.03	0.09	0.07	-0.03	0.02	0.02	2.09	4.31	0.07	-0.09	0.08	0.11	-0.03	0.08	0.08					

DAPL DATA LOG		XOM-Buffalo,NYTerminal					XWell: LF-6												
		10/22/03 16:51:21 TPE			Test 3														
elapsed time (sec)	VERMW-3 Vac Resp (in WC)	VERMW-4 Vac Resp (in WC)	VERMW-2 Vac Resp (in WC)	VERMW-1 Vac Resp (in WC)	MW-28 Vac Resp (in WC)	MW-3URS Vac Resp (in WC)	Well Vacuum (inHg)	Straw Vacuum (inHg)	VERMW-3 GW DD (feet)	VERMW-4 GW DD (feet)	VERMW-2 GW DD (feet)	VERMW-1 GW DD (feet)	MW-28 GW DD (feet)	MW-3URS GW DD (feet)	LF-6 GW DD (feet)	HighVac AirFlow (scfm)	Time	Notes	
48480	0.03	0.10	0.07	-0.03	0.03	0.02	2.08	4.26	0.11	-0.07	0.10	0.19	-0.06	0.08	0.08	44.46	6:19:21		
48540	0.03	0.10	0.08	-0.03	0.05	0.03	2.09	4.16	0.11	-0.07	0.12	0.15	-0.03	0.08	0.08	44.53	6:20:21		
48600	0.02	0.10	0.07	-0.03	0.04	0.02	2.11	4.05	0.11	-0.07	0.10	0.11	-0.06	0.08	0.08	44.63	6:21:21		
48660	0.02	0.10	0.08	-0.03	0.04	0.03	2.13	3.87	0.09	-0.04	0.12	0.15	-0.06	0.08	0.08	44.51	6:22:21		
48720	0.02	0.09	0.07	-0.03	0.03	0.02	2.11	4.73	0.11	-0.11	0.12	0.15	-0.06	0.08	0.08	44.61	6:23:21		
48780	0.02	0.10	0.07	-0.03	0.03	0.03	2.09	4.40	0.13	-0.09	0.10	0.15	-0.06	0.08	0.17	44.49	6:24:21		
48840	0.02	0.10	0.07	-0.03	0.03	0.03	2.09	4.22	0.11	-0.07	0.12	0.15	-0.06	0.12	0.08	44.58	6:25:21		
48900	0.02	0.09	0.07	-0.03	0.03	0.03	2.08	4.44	0.11	-0.09	0.10	0.15	-0.03	0.08	0.17	44.51	6:26:21		
48960	0.02	0.10	0.07	-0.03	0.04	0.03	2.11	4.00	0.11	-0.09	0.12	0.15	-0.03	0.08	0.08	44.49	6:27:21		
49020	0.02	0.10	0.07	-0.03	0.02	0.02	2.11	4.35	0.11	-0.09	0.10	0.15	-0.06	0.08	0.04	44.58	6:28:21		
49080	0.02	0.09	0.07	-0.03	0.03	0.02	2.09	4.62	0.11	-0.09	0.10	0.15	-0.03	0.08	0.17	44.56	6:29:21		
49140	0.03	0.11	0.09	-0.03	0.03	0.04	2.09	4.07	0.07	-0.09	0.12	0.19	-0.03	0.08	0.08	44.49	6:30:21		
49200	0.03	0.09	0.07	-0.03	0.05	0.03	2.11	4.37	0.11	-0.09	0.10	0.15	-0.06	0.08	0.17	44.46	6:31:21		
49260	0.02	0.10	0.07	-0.03	0.03	0.02	2.11	4.29	0.11	-0.07	0.10	0.15	-0.06	0.08	0.08	44.41	6:32:21		
49320	0.02	0.10	0.07	-0.03	0.03	0.03	2.09	4.24	0.11	-0.11	0.12	0.15	-0.06	0.08	0.17	44.44	6:33:21		
49380	0.02	0.10	0.07	-0.03	0.04	0.03	2.11	4.13	0.11	-0.04	0.12	0.15	-0.03	0.08	0.08	44.49	6:34:21		
49440	0.02	0.10	0.07	-0.03	0.03	0.03	2.13	4.18	0.11	-0.09	0.10	0.15	-0.06	0.08	0.08	44.34	6:35:21		
49500	0.02	0.10	0.08	-0.03	0.05	0.02	2.06	4.20	0.09	-0.09	0.12	0.11	-0.06	0.12	0.17	44.20	6:36:21		
49560	0.02	0.10	0.08	-0.03	0.03	0.03	2.09	4.18	0.11	-0.09	0.10	0.15	-0.06	0.08	0.08	44.51	6:37:21		
49620	0.03	0.10	0.08	-0.03	0.01	0.03	2.09	4.64	0.11	-0.07	0.10	0.15	-0.03	0.04	0.08	44.39	6:38:21		
49680	0.03	0.10	0.08	-0.03	0.05	0.03	2.11	4.04	0.11	-0.09	0.12	0.15	-0.06	0.08	0.04	44.37	6:39:21		
49740	0.03	0.10	0.07	-0.03	0.05	0.03	2.13	4.29	0.09	-0.09	0.10	0.19	-0.03	0.12	0.21	44.39	6:40:21		
49800	0.03	0.09	0.07	-0.03	0.05	0.03	2.11	4.18	0.11	-0.09	0.12	0.15	-0.06	0.12	0.08	44.41	6:41:21		
50100	0.03	0.10	0.07	-0.03	0.06	0.03	2.09	4.57	0.11	-0.09	0.12	0.11	-0.06	0.08	0.08	44.58	6:46:21		
50160	0.03	0.10	0.08	-0.03	0.03	0.02	2.09	4.24	0.09	-0.11	0.10	0.15	-0.06	0.08	0.21	44.65	6:47:21		
50220	0.02	0.10	0.07	-0.03	0.05	0.03	2.08	4.53	0.11	-0.11	0.10	0.11	-0.06	0.12	0.08	44.56	6:48:21		
50280	0.02	0.10	0.07	-0.03	0.03	0.02	2.09	4.35	0.09	-0.11	0.10	0.11	-0.06	0.12	0.08	44.56	6:49:21		
50340	0.03	0.11	0.08	-0.03	0.03	0.02	2.11	4.69	0.13	-0.11	0.10	0.15	-0.06	0.08	0.17	44.68	6:50:21		
50400	0.03	0.10	0.08	-0.03	0.04	0.04	2.09	4.11	0.11	-0.09	0.10	0.15	-0.03	0.08	0.17	44.58	6:51:21		
50460	0.02	0.10	0.07	-0.03	0.01	0.02	2.08	4.73	0.13	-0.09	0.10	0.15	-0.03	0.08	0.08	44.46	6:52:21		
50520	0.02	0.10	0.07	-0.03	0.04	0.02	2.09	4.37	0.11	-0.11	0.10	0.15	-0.06	0.08	0.17	44.53	6:53:21		
50580	0.02	0.10	0.07	-0.03	0.03	0.02	2.13	4.31	0.09	-0.13	0.10	0.11	-0.09	0.08	0.08	44.41	6:54:21		
50640	0.02	0.10	0.07	-0.03	0.05	0.03	2.09	4.31	0.09	-0.15	0.10	0.15	-0.06	0.04	0.17	44.46	6:55:21		
50700	0.02	0.11	0.08	-0.03	0.03	0.03	2.09	4.37	0.09	-0.11	0.10	0.15	-0.09	0.04	0.08	44.61	6:56:21		
50760	0.03	0.10	0.08	-0.03	0.03	0.02	2.08	4.27	0.09	-0.15	0.10	0.11	-0.06	0.08	0.04	44.37	6:57:21		
50820	0.03	0.10	0.08	-0.03	0.04	0.03	2.08	4.49	0.09	-0.11	0.10	0.15	-0.09	0.08	0.08	44.34	6:58:21		
50880	0.02	0.10	0.07	-0.03	0.04	0.02	2.08	4.71	0.09	-0.13	0.10	0.11	-0.06	0.08	0.08	44.41	6:59:21		
50940	0.03	0.10	0.07	-0.03	0.05	0.03	2.08	4.35	0.09	-0.15	0.10	0.15	-0.06	0.08	0.08	44.10	7:00:21		
51000	0.02	0.09	0.07	-0.03	0.04	0.02	2.09	4.26	0.07	-0.15	0.08	0.11	-0.06	0.04	0.08	44.34	7:01:21		
51060	0.03	0.10	0.07	-0.03	0.03	0.03	2.09	4.07	0.09	-0.13	0.10	0.11	-0.06	0.08	0.04	44.20	7:02:21		
51120	0.03	0.10	0.08	-0.03	0.05	0.04	2.08	4.26	0.09	-0.15	0.08	0.11	-0.09	0.08	0.08	44.32	7:03:21		
51180	0.03	0.11	0.08	-0.03	0.03	0.04	2.11	3.94	0.07	-0.15	0.08	0.11	-0.03	0.12	0.08	44.32	7:04:21		
51240	0.03	0.10	0.07	-0.03	0.05	0.03	2.09	4.60	0.09	-0.13	0.10	0.15	-0.06	0.08	0.08	44.37	7:05:21		
51300	0.02	0.09	0.07	-0.03	0.04	0.03	2.09	4.26	0.09	-0.13	0.08	0.11	-0.03	0.08	0.17	44.25	7:06:21		
51360	0.02	0.10	0.07	-0.03	0.02	0.02	2.09	4.11	0.07	-0.15	0.08	0.11	-0.06	0.08	0.08	44.29	7:07:21		
51420	0.02	0.10	0.08	-0.03	0.03	0.03	2.09	4.27	0.09	-0.15	0.10	0.15	-0.06	0.08	0.04	44.29	7:08:21		
51480	0.02	0.09	0.07	-0.03	0.02	0.03	2.09	4.13	0.09	-0.13	0.08	0.11	-0.06	0.08	0.08	44.25	7:09:21		
51540	0.02	0.10	0.07	-0.03	0.05	0.03	2.08	4.73	0.09	-0.15	0.10	0.11	-0.06	0.04	0.08	44.32	7:10:21		
51600	0.02	0.10	0.07	-0.03	0.04	0.03	2.08	4.68	0.09	-0.09	0.10	0.15	-0.06	0.04	0.04	44.49	7:11:21		
51660	0.02	0.10	0.08	-0.03	0.04	0.02	2.04	4.49	0.09	-0.11	0.10	0.11	-0.06	0.08	0.08	44.29	7:12:21		
51720	0.02	0.09	0.06	-0.03	0.03	0.00	2.06	4.69	0.07	-0.15	0.10	0.11	-0.06	0.08	0.08	44.44	7:13:21		
51780	0.02	0.09	0.07	-0.03	0.05	0.02	2.06	4.13	0.07	-0.13	0.08	0.11	-0.03	0.08	0.04	44.41	7:14:21		
51840	0.02	0.10	0.08	-0.03	0.04	0.02	2.09	4.71	0.05	-0.17	0.08	0.11	-0.06	0.04	0.08	44.49	7:15:21		
51900	0.03	0.09	0.07	-0.03	0.05	0.03	2.11	4.07	0.07	-0.13	0.08	0.11	-0.06	0.08	0.04	44.39	7:16:21		
51960	0.03	0.09	0.08	-0.03	0.03	0.03	2.04	4.73	0.09	-0.13	0.08	0.11	-0.06	0.08	0.04	44.37	7:17:21		
52020	0.02	0.10	0.08	-0.03	0.03	0.03	2.06	4.20	0.07	-0.13	0.10	0.15	-0.06	0.04	0.08	44.32	7:18:21		
52080	0.02	0.09	0.07	-0.03	0.03	0.03	2.09	4.60	0.07	-0.15	0.08	0.11	-0.09	0.04	0.08	44.44	7:19:21		
52140	0.02	0.10	0.07	-0.03	0.05	0.03	2.11	4.13	0.07	-0.11	0.08	0.11	-0.09	0.08	0.08	44.37	7:20:21		
52200	0.02	0.10	0.08	-0.03	0.03	0.02	2.09	4.51	0.09	-0.15	0.08	0.15	-0.09	0.08	0.04	44.41	7:21:21		
52260	0.03	0.09	0.07	-0.03	0.04	0.03	2.09	4.07	0.07	-0.11	0.10	0.07	-0.06	0.04	0.04	44.32	7:22:21		

DAPL DATA LOG	XOM-Buffalo,NYTerminal						XWell: LF-6											HighVac AirFlow (scfm)	Time	Notes
	10/22/03 16:51:21 TPE						Test 3													
elapsed time (sec)	VERMW-3 Vac Resp (in WC)	VERMW-4 Vac Resp (in WC)	VERMW-2 Vac Resp (in WC)	VERMW-1 Vac Resp (in WC)	MW-28 Vac Resp (in WC)	MW-3URS Vac Resp (in WC)	Well Vacuum (inHg)	Straw Vacuum (inHg)	VERMW-3 GW DD (feet)	VERMW-4 GW DD (feet)	VERMW-2 GW DD (feet)	VERMW-1 GW DD (feet)	MW-28 GW DD (feet)	MW-3URS GW DD (feet)	LF-6 GW DD (feet)					
55920	0.03	0.10	0.08	-0.03	0.05	0.03	2.02	4.55	0.02	-0.17	0.02	0.07	-0.09	-0.04	0.00					
55980	0.02	0.09	0.07	-0.03	0.01	0.02	2.00	4.35	0.02	-0.15	0.02	0.07	-0.06	0.00	0.00					
56160	0.03	0.09	0.07	-0.03	0.05	0.02	1.98	4.26	0.00	-0.15	0.02	0.00	-0.09	-0.04	0.00					
56220	0.03	0.10	0.08	-0.03	0.03	0.03	2.00	4.60	0.02	-0.13	0.02	0.07	-0.06	0.00	0.00					
56280	0.02	0.09	0.06	-0.03	0.03	0.02	2.00	4.18	0.02	-0.13	0.02	0.07	-0.06	-0.04	0.00					
56340	0.01	0.09	0.06	-0.03	0.01	0.01	2.00	4.33	0.02	-0.15	0.00	0.00	-0.06	-0.04	-0.04					
56400	0.03	0.10	0.08	-0.03	0.04	0.04	2.00	4.55	0.00	-0.13	0.00	0.00	-0.09	-0.04	0.00					
56460	0.03	0.10	0.08	-0.03	0.05	0.04	2.02	4.31	0.00	-0.15	0.00	0.07	-0.09	-0.04	0.00					
56520	0.02	0.10	0.08	-0.03	0.05	0.03	1.98	3.96	0.00	-0.11	-0.03	0.00	-0.06	0.00	-0.04					
56580	0.03	0.10	0.08	-0.03	0.01	0.03	2.02	4.64	-0.02	-0.15	0.00	-0.04	-0.06	0.00	0.00					
56640	0.03	0.10	0.08	-0.03	0.03	0.02	2.00	4.55	-0.02	-0.17	0.00	0.00	-0.09	-0.04	-0.04					
56700	0.03	0.10	0.08	-0.03	0.04	0.03	1.98	4.64	0.02	-0.15	0.02	0.00	-0.06	-0.04	-0.04					
56760	0.03	0.11	0.08	-0.03	0.04	0.03	1.98	4.88	0.00	-0.15	0.00	0.00	-0.06	-0.04	0.00					
56820	0.02	0.10	0.07	-0.03	0.03	0.03	2.02	4.66	-0.02	-0.13	0.00	0.00	-0.09	-0.04	0.04					
56880	0.03	0.09	0.07	-0.03	0.03	0.03	1.97	4.44	-0.02	-0.17	-0.03	0.00	-0.09	0.00	-0.04					
56940	0.03	0.10	0.08	-0.03	0.04	0.03	2.02	4.07	-0.04	-0.17	-0.03	0.00	-0.06	-0.04	0.00					
57000	0.02	0.09	0.07	-0.03	0.02	0.03	2.00	4.46	-0.02	-0.21	-0.03	-0.04	-0.06	-0.04	-0.04					
57060	0.03	0.09	0.07	-0.03	0.04	0.02	1.98	4.31	-0.04	-0.19	-0.03	0.00	-0.06	-0.04	-0.04					
57120	0.02	0.09	0.07	-0.03	0.03	0.02	1.98	4.66	-0.02	-0.19	-0.05	0.00	-0.06	-0.04	-0.04					
57180	0.03	0.09	0.07	-0.03	0.03	0.02	1.97	4.82	-0.02	-0.19	-0.05	0.00	-0.06	-0.04	-0.04					
57240	0.03	0.09	0.06	-0.03	0.03	0.02	1.98	4.66	-0.02	-0.19	-0.03	-0.04	-0.06	-0.08	-0.04					
57300	0.03	0.09	0.06	-0.03	0.03	0.02	2.02	4.15	-0.02	-0.21	-0.03	0.00	-0.03	0.00	-0.08					
57360	0.03	0.09	0.06	-0.03	0.03	0.02	1.98	4.71	-0.04	-0.21	-0.03	0.00	-0.06	-0.04	-0.08					
57420	0.03	0.09	0.07	-0.03	0.01	0.02	1.97	4.58	-0.04	-0.23	-0.03	0.00	-0.06	-0.08	-0.08					
57480	0.03	0.10	0.07	-0.03	0.03	0.02	2.00	4.58	-0.02	-0.21	-0.05	-0.04	-0.09	-0.08	-0.08					
57540	0.02	0.09	0.07	-0.03	0.03	0.02	2.04	4.58	-0.04	-0.23	-0.05	0.00	-0.06	-0.04	-0.04					
57600	0.02	0.09	0.07	-0.03	0.05	0.02	1.95	4.38	-0.04	-0.25	-0.05	-0.04	-0.06	-0.04	-0.08					
57660	0.02	0.09	0.07	-0.03	0.05	0.02	1.95	4.40	-0.04	-0.21	-0.03	0.00	-0.09	-0.08	-0.04					
57720	0.02	0.09	0.07	-0.03	0.05	0.03	1.95	4.49	-0.04	-0.27	-0.03	-0.04	-0.06	-0.12	0.00					
57780	0.03	0.10	0.08	-0.03	0.05	0.05	1.93	4.75	-0.06	-0.23	-0.05	-0.04	-0.09	-0.08	-0.04					
57840	0.02	0.10	0.08	-0.03	0.03	0.02	1.97	5.02	-0.04	-0.25	-0.05	-0.04	-0.03	-0.04	-0.08					
57900	0.02	0.09	0.07	-0.03	0.04	0.02	1.93	4.77	-0.06	-0.21	-0.07	-0.04	-0.09	-0.04	-0.08					
57960	0.02	0.09	0.07	-0.03	0.03	0.03	1.98	4.40	-0.04	-0.25	-0.05	-0.04	-0.09	-0.08	-0.08					
58020	0.02	0.09	0.07	-0.03	0.03	0.02	1.97	4.27	-0.04	-0.23	-0.05	-0.08	-0.06	-0.08	-0.04					
58080	0.01	0.08	0.06	-0.03	0.02	0.01	1.97	4.48	-0.04	-0.27	-0.07	-0.04	-0.09	-0.04	-0.08					
58140	0.02	0.09	0.07	-0.03	0.04	0.03	1.98	4.35	-0.04	-0.23	-0.07	-0.04	-0.06	-0.08	-0.04					
58200	0.03	0.09	0.07	-0.03	0.03	0.02	1.93	4.57	-0.06	-0.23	-0.07	0.00	-0.09	-0.08	-0.08					
58260	0.03	0.09	0.07	-0.03	0.04	0.03	2.00	4.20	-0.06	-0.19	-0.05	-0.04	-0.06	-0.08	-0.08					
58320	0.02	0.09	0.07	-0.03	0.03	0.03	1.91	4.90	-0.06	-0.19	-0.07	-0.04	-0.09	-0.08	-0.08					
58380	0.02	0.05	0.03	-0.03	0.05	0.02	0.89	6.73	-0.04	-0.25	-0.07	-0.04	-0.09	-0.04	-0.04					
58440	0.02	0.04	0.02	-0.03	0.02	0.02	0.92	6.23	-0.04	-0.17	-0.05	0.00	-0.06	-0.04	0.00					
58500	0.03	0.04	0.02	-0.03	0.02	0.03	1.00	6.25	-0.06	-0.17	-0.05	-0.04	-0.06	-0.08	0.04					
58560	0.03	0.05	0.03	-0.03	0.05	0.02	1.11	6.69	-0.04	-0.17	-0.03	-0.04	-0.06	-0.04	-0.04					
58620	0.03	0.04	0.02	-0.03	0.05	0.03	0.96	7.13	-0.02	-0.21	-0.05	0.00	-0.06	-0.08	-0.08					
58680	0.02	0.05	0.03	-0.03	0.03	0.02	0.94	6.16	-0.04	-0.17	-0.05	-0.04	-0.09	-0.04	0.00					
58740	0.02	0.06	0.04	-0.03	0.04	0.03	1.07	5.90	-0.04	-0.19	-0.05	-0.04	-0.06	-0.04	0.00					
58800	0.03	0.04	0.03	-0.03	0.04	0.03	0.94	6.65	-0.04	-0.21	-0.05	0.00	-0.09	-0.04	0.04					
58860	0.03	0.05	0.04	-0.03	0.04	0.02	0.94	6.87	-0.04	-0.21	-0.07	-0.04	-0.06	-0.04	-0.04					
58920	0.02	0.05	0.03	-0.03	0.04	0.04	1.05	6.67	-0.06	-0.17	-0.05	-0.04	-0.06	-0.08	-0.04					
58980	0.02	0.05	0.02	-0.03	0.03	0.02	0.94	6.14	-0.04	-0.19	-0.05	-0.04	-0.09	-0.04	0.04					
59040	0.02	0.05	0.02	-0.03	0.02	0.02	0.96	6.20	-0.02	-0.23	-0.05	-0.04	-0.06	-0.08	-0.04					
59100	0.02	0.04	0.02	-0.03	0.02	0.02	0.89	6.78	-0.04	-0.17	-0.05	0.00	-0.06	-0.08	0.00					
59160	0.01	0.05	0.02	-0.03	0.03	0.02	0.89	7.20	-0.06	-0.21	-0.05	0.00	-0.06	-0.08	-0.04					
59220	0.01	0.05	0.03	-0.03	0.03	0.01	1.01	6.20	-0.06	-0.19	-0.07	-0.04	-0.06	-0.08	0.00					
59280	0.03	0.05	0.02	-0.03	0.01	0.01	0.92	6.10	-0.04	-0.17	-0.05	-0.04	-0.06	-0.08	0.00					
59340	0.02	0.05	0.03	-0.03	0.03	0.01	1.01	6.38	-0.04	-0.15	-0.05	-0.04	-0.06	-0.08	0.00					
59400	0.02	0.04	0.02	-0.03	0.03	0.02	0.92	6.51	-0.04	-0.17	-0.05	-0.04	-0.09	-0.08	-0.04					
59460	0.02	0.05	0.03	-0.03	0.05	0.03	0.85	7.22	-0.04	-0.13	-0.07	-0.04	-0.06	-0.04	0.00					

DAPL	XOM-Buffalo,NYTerminal														XWell: LF-6				
DATA LOG	10/22/03	16:51:21	TPE											Test 3					
elapsed time (sec)	VERMW-3 Vac Resp (in WC)	VERMW-4 Vac Resp (in WC)	VERMW-2 Vac Resp (in WC)	VERMW-1 Vac Resp (in WC)	MW-28 Vac Resp (in WC)	MW-3URS Vac Resp (in WC)	Well Vacuum (inHg)	Straw Vacuum (inHg)	VERMW-3 GW DD (feet)	VERMW-4 GW DD (feet)	VERMW-2 GW DD (feet)	VERMW-1 GW DD (feet)	MW-28 GW DD (feet)	MW-3URS GW DD (feet)	LF-6 GW DD (feet)	HighVac AirFlow (scfm)	Time	Notes	
59520	0.03	0.05	0.02	-0.03	0.01	0.01	0.90	7.20	-0.06	-0.15	-0.05	-0.04	-0.09	-0.08	-0.04	36.42	9:23:21		
59580	0.02	0.01	-0.02	-0.03	0.03	0.02	0.39	0.43	-0.08	-0.19	-0.09	-0.04	-0.09	-0.04	-0.08	53.48	9:24:21		
59640	0.03	0.01	-0.02	-0.03	0.05	0.03	0.39	0.39	-0.08	-0.19	-0.07	-0.08	-0.06	-0.08	-0.08	53.56	9:25:21		
59700	0.02	0.01	-0.02	-0.03	0.03	0.02	0.39	0.39	-0.06	-0.21	-0.09	-0.08	-0.06	-0.12	-0.08	53.70	9:26:21		
59760	0.02	0.01	-0.02	-0.03	0.04	0.01	0.41	0.39	-0.06	-0.23	-0.11	-0.08	-0.06	-0.08	-0.08	53.86	9:27:21		
59820	0.02	0.01	-0.02	-0.03	0.03	0.01	0.41	0.41	-0.08	-0.19	-0.09	-0.08	-0.06	-0.12	-0.08	53.86	9:28:21		
59880	0.02	0.01	-0.02	-0.03	0.02	0.00	0.39	0.37	-0.08	-0.19	-0.07	1.11	-0.06	-0.12	-0.08	53.92	9:29:21		
59940	0.02	0.01	-0.01	-0.03	0.03	0.02	0.41	0.37	-0.08	-0.21	0.94	1.15	-0.06	-0.12	-0.08	53.92	9:30:21		
60000	0.03	0.01	-0.02	-0.03	0.04	0.01	0.39	0.37	-0.08	-0.11	0.94	1.15	-0.06	-0.08	-0.08	53.92	9:31:21		
60060	0.03	0.01	-0.02	-0.03	0.02	0.00	0.37	0.36	-0.08	-0.15	0.94	1.11	-0.09	-0.08	-0.12	53.88	9:32:21		
60120	0.03	0.03	-0.01	-0.03	0.02	0.00	0.39	0.39	-0.09	-0.15	0.96	1.11	-0.09	-0.12	-0.08	54.10	9:33:21		
60180	0.02	0.01	-0.02	-0.03	0.03	0.02	0.39	0.36	-0.09	-0.15	0.96	1.15	-0.06	-0.12	-0.12	53.90	9:34:21		
60240	0.02	0.01	-0.02	-0.03	0.01	0.01	0.39	0.37	-0.09	-0.15	0.98	1.15	-0.06	-0.08	-0.08	53.94	9:35:21		
60300	0.02	0.01	-0.02	-0.03	0.02	0.01	0.39	0.37	-0.09	-0.17	0.94	1.15	-0.06	-0.08	-0.12	53.94	9:36:21		
60360	0.02	0.01	-0.02	-0.03	0.06	0.04	0.39	0.37	-0.09	-0.15	0.96	1.15	-0.09	0.32	-0.08	53.90	9:37:21		
60420	0.02	0.02	-0.02	-0.03	0.03	0.02	0.39	0.39	0.13	-0.15	0.96	1.15	-0.06	0.32	-0.12	54.02	9:38:21		
60480	0.03	0.01	-0.02	-0.03	0.01	0.00	0.39	0.37	0.13	-0.15	0.94	1.11	1.68	0.32	-0.08	54.00	9:39:21		
60540	0.02	-0.01	-0.01	-0.03	0.03	0.01	0.39	0.36	0.15	-0.15	0.96	1.15	1.65	0.32	-0.08	54.00	9:40:21		
60600	0.03	0.01	-0.02	-0.03	0.03	0.01	0.39	0.37	0.15	-0.15	0.94	0.82	1.65	0.32	-0.08	54.14	9:41:21		
60660	0.02	0.01	-0.02	-0.03	0.05	0.01	0.37	0.36	0.13	-0.13	0.94	0.82	1.62	0.32	-0.12	54.00	9:42:21		
60720	0.02	0.01	-0.02	-0.03	0.03	0.01	0.39	0.37	0.13	-0.13	0.94	0.82	1.65	0.32	-0.08	54.10	9:43:21		
60780	0.03	0.02	-0.01	-0.03	0.05	0.03	0.39	0.37	0.15	-0.11	0.96	0.82	1.65	0.35	-0.08	54.00	9:44:21		
60840	0.03	0.01	-0.02	-0.03	0.04	0.02	0.37	0.37	0.13	-0.13	0.96	0.86	1.65	0.32	-0.12	54.08	9:45:21		
60900	0.02	0.01	-0.02	-0.03	0.03	0.01	0.37	0.37	0.15	-0.13	0.96	0.86	1.68	0.32	7.98	54.18	9:46:21		
60960	0.02	0.02	-0.02	-0.03	0.02	0.02	0.39	0.36	0.15	-0.09	0.96	0.82	1.65	0.32	8.28	54.16	9:47:21		
61020	0.03	0.02	-0.01	-0.03	0.05	0.01	0.41	0.37	0.13	-0.09	0.94	0.86	1.65	0.35	7.04	54.18	9:48:21		
61080	0.02	0.02	-0.02	-0.03	0.03	0.00	0.37	0.34	0.15	-0.11	0.94	0.86	1.65	0.32	10.06	54.00	9:49:21		
61140	0.02	0.01	-0.02	-0.03	0.04	0.03	0.39	0.36	0.15	-0.09	0.96	0.82	1.65	0.32	10.11	54.04	9:50:21		
61200	0.02	0.01	-0.02	-0.03	0.05	0.03	0.39	0.37	0.13	-0.11	0.98	0.82	1.65	0.35	10.11	54.04	9:51:21		
61260	0.03	0.02	-0.01	-0.03	0.03	0.02	0.37	0.36	0.15	-0.09	0.96	0.86	1.62	0.32	10.17	54.14	9:52:21		
61320	0.02	0.02	-0.02	-0.03	0.03	0.02	0.39	0.34	0.13	-0.15	0.96	0.82	1.65	0.32	10.22	54.14	9:53:21		
61380	0.02	0.01	-0.02	-0.03	0.03	0.00	0.39	0.36	0.11	-0.15	0.94	0.86	1.65	0.32	10.17	53.98	9:54:21		

APPENDIX E

ChemOx Pilot Test Data and Graphs

Membrane Interface Probe Location MIP1 Results

PID Response - MIP1 with Chemical Injection Point CO-2 Shown

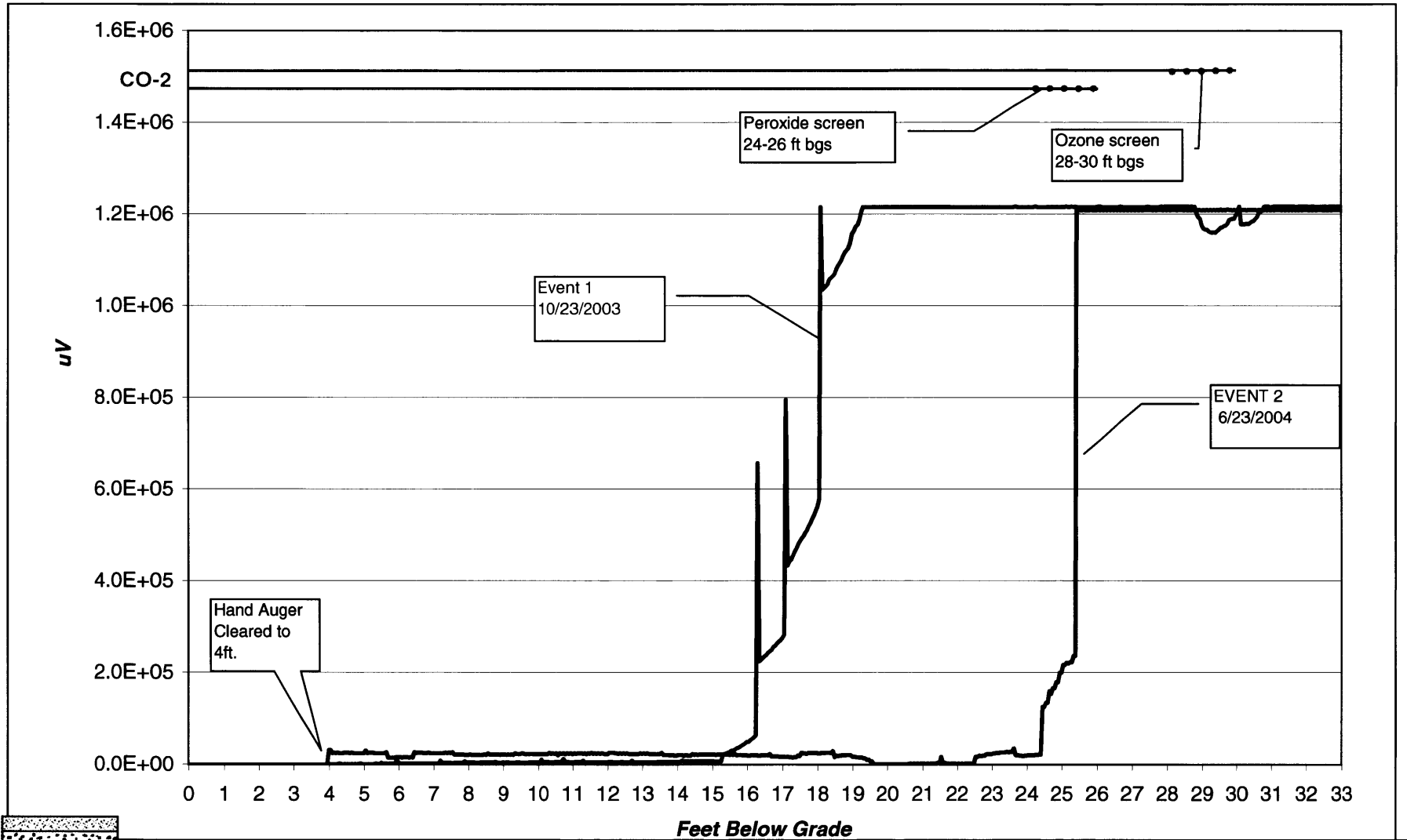

Zebra Environmental 30 No. Prospect Avenue, Lynbrook, N	For: GES Project Name: ExxonMobil Buffalo
--	--

FID Response - MIP1 with Chemical Injection Point CO-2 Shown

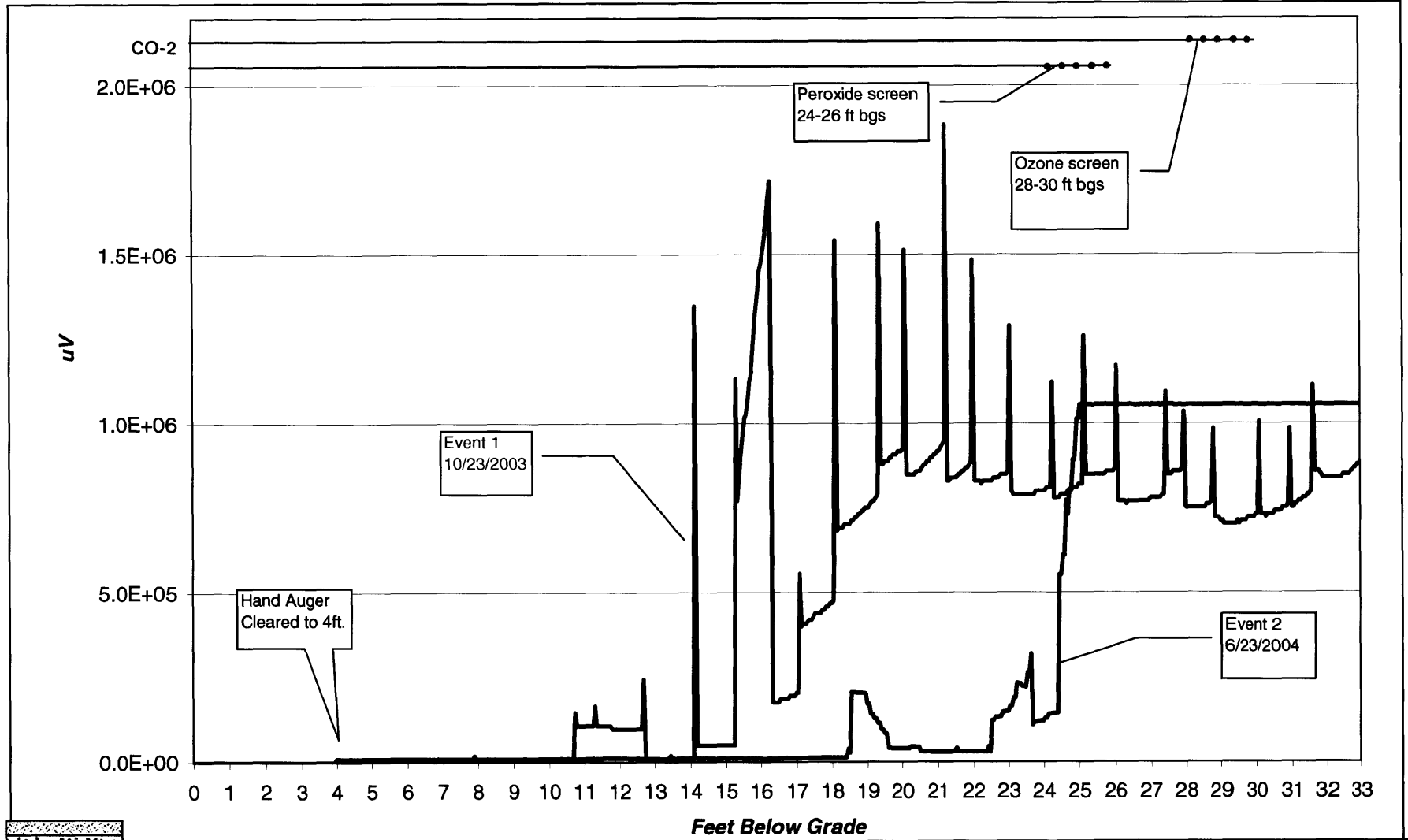

Zebra Environmental 30 No. Prospect Avenue, Lynbrook, N	For: GES Project Name: ExxonMobil Buffalo
--	--

Soil Conductivity - MIP1

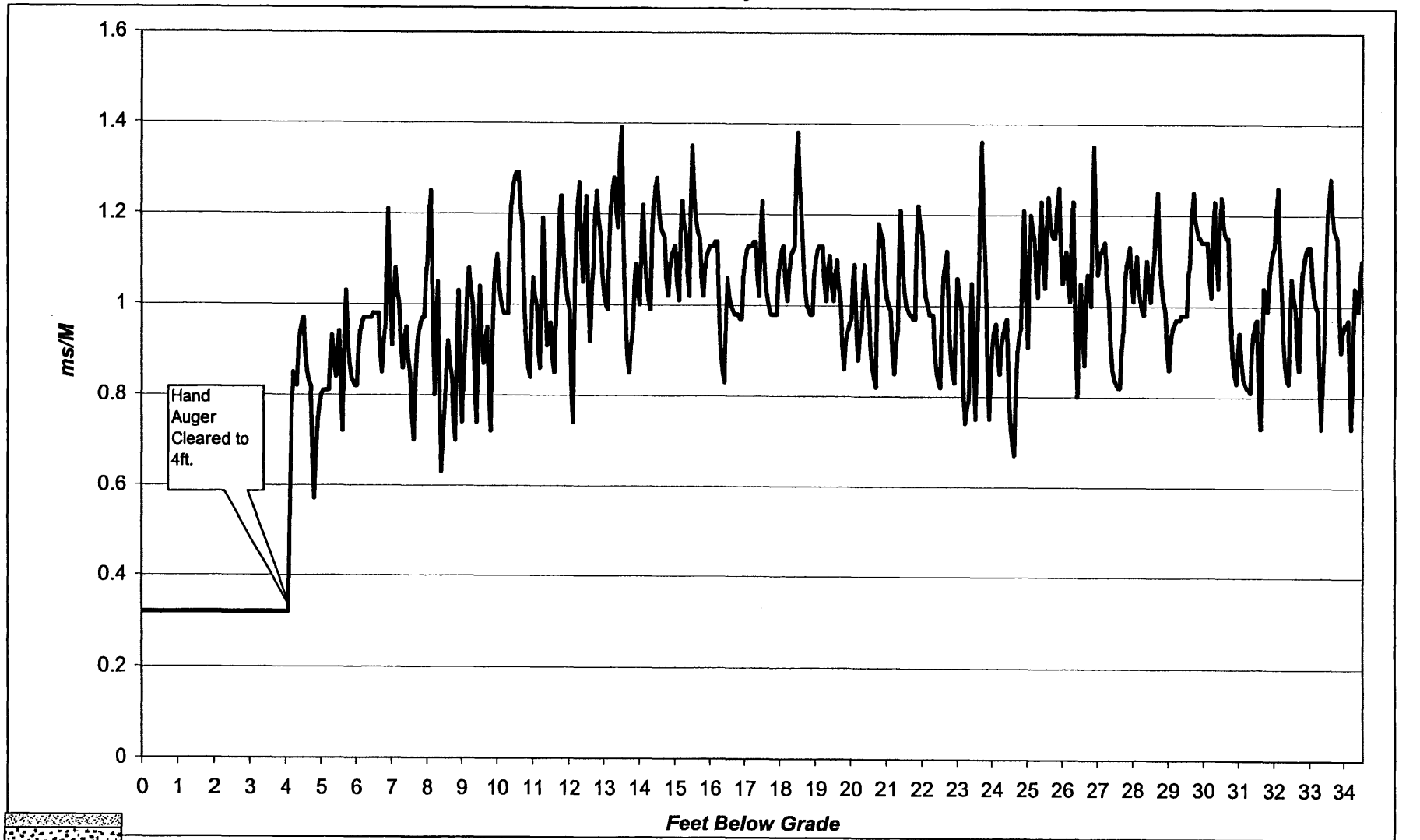

Zebra Environmental 30 No. Prospect Avenue, Lynbrook, N	For: GES Project Name: ExxonMobil Buffalo
--	--

Membrane Interface Probe Location MIP2 Results

PID Response - MIP2 with Chemical Injection Point CO-1 Shown

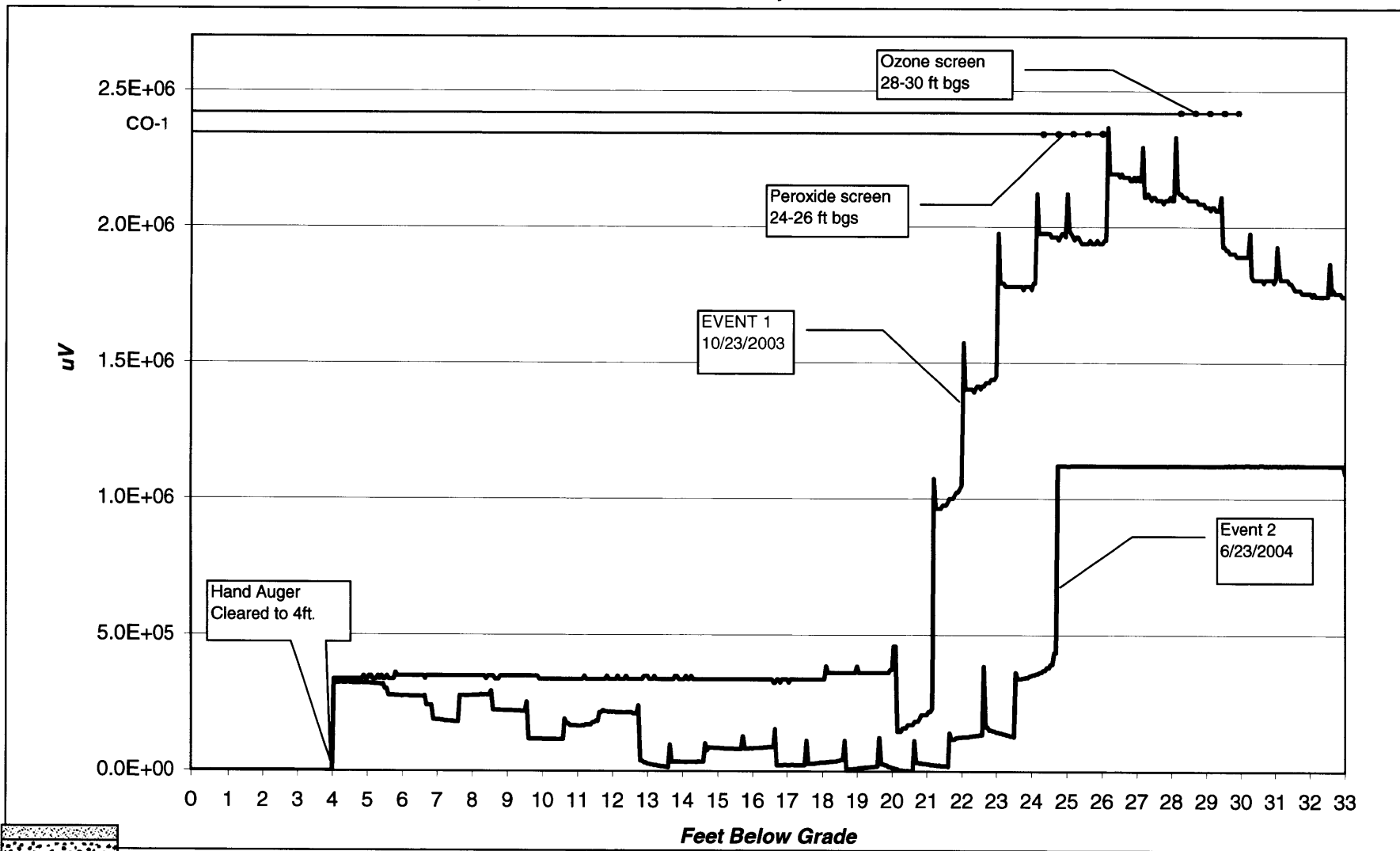

Zebra Environmental 30 No. Prospect Avenue, Lynbrook, N	For: GES Project Name: ExxonMobil Buffalo
--	--

FID Response - MIP2 with Chemical Injection Point CO-1 Shown

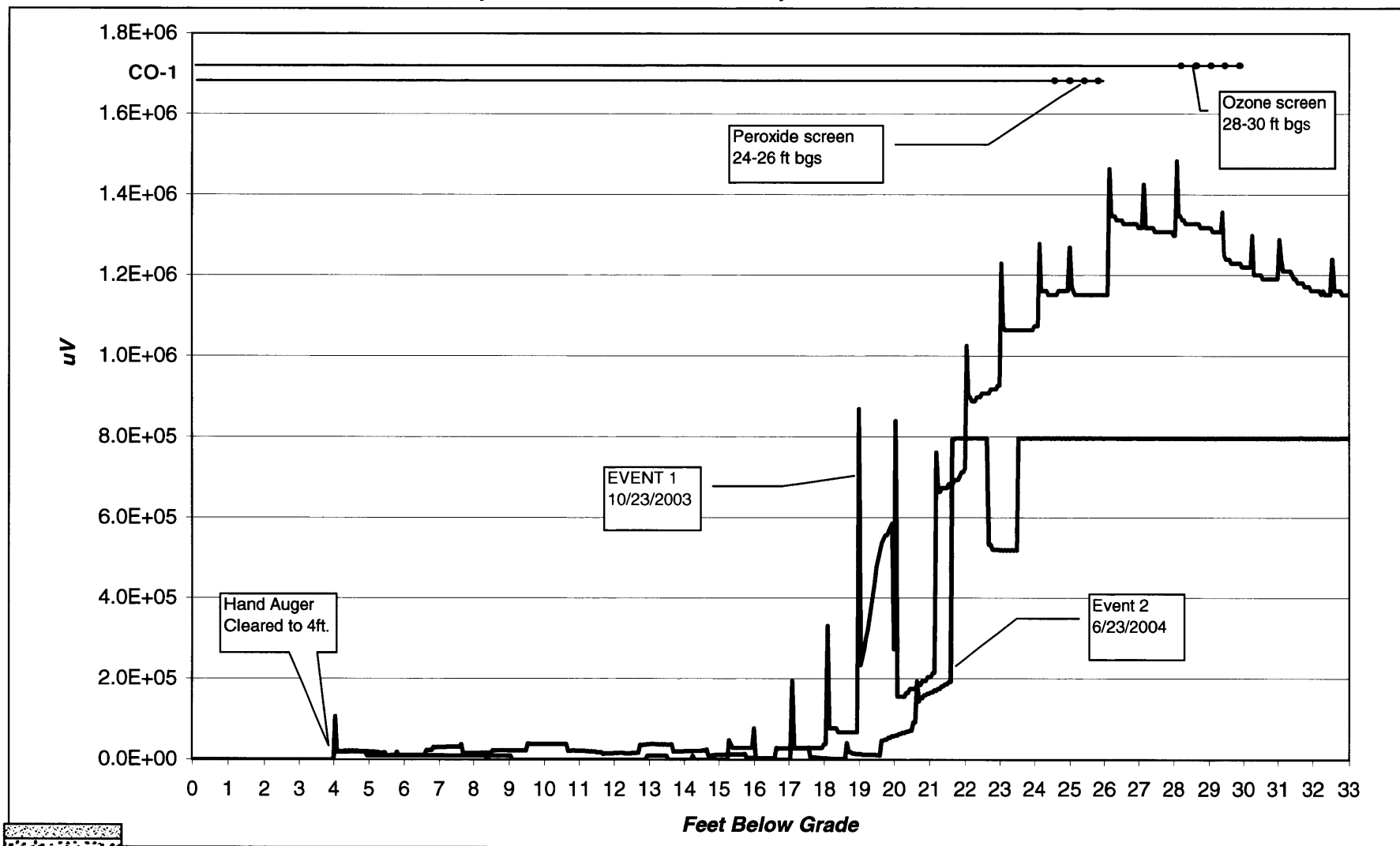

Zebra Environmental 30 No. Prospect Avenue, Lynbrook, N	For: GES Project Name: ExxonMobil Buffalo
--	--

Soil Conductivity - MIP2

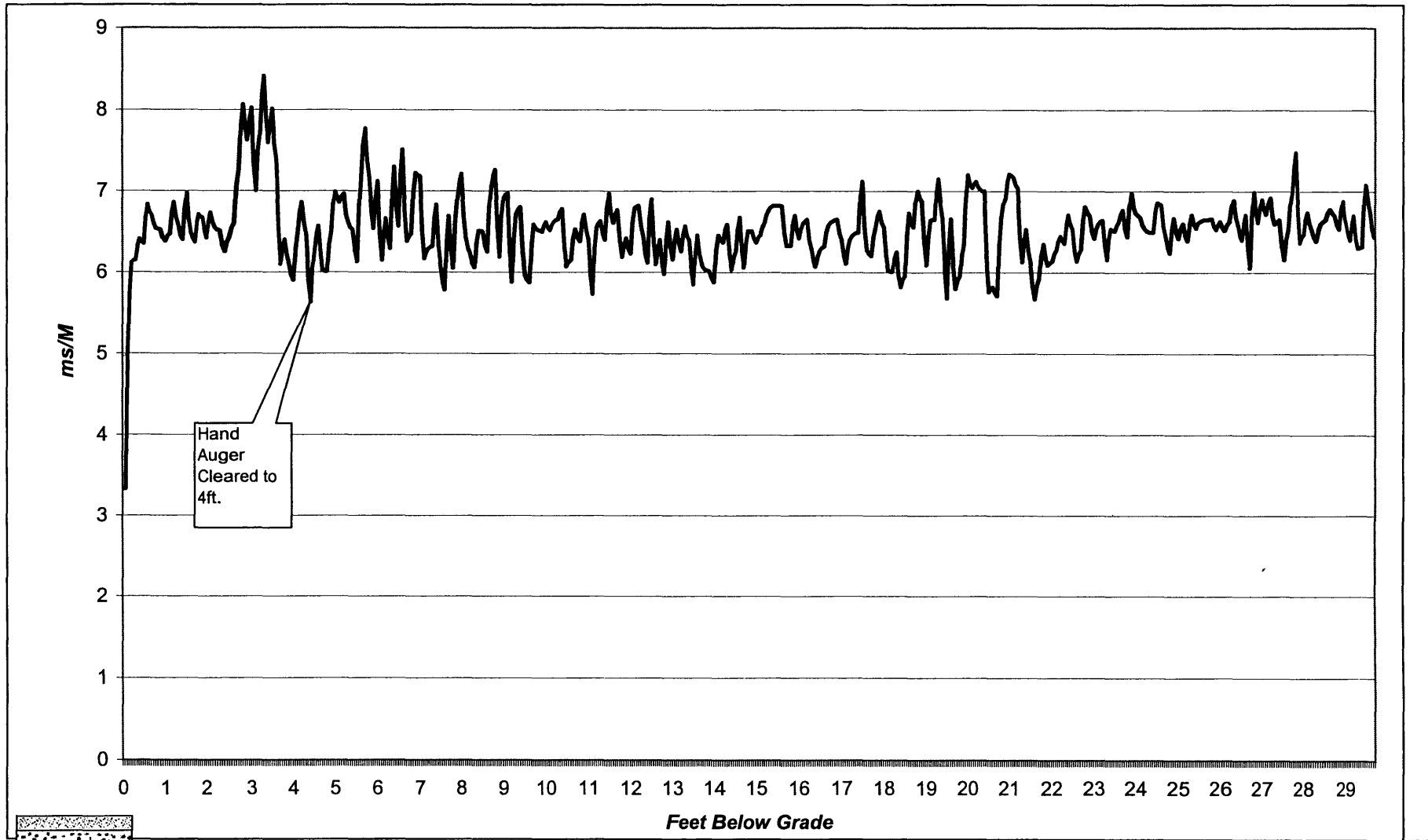

Zebra Environmental 30 No. Prospect Avenue, Lynbrook, N	For: GES Project Name: ExxonMobil Buffalo
--	--

Membrane Interface Probe Location MIP3 Results

PID Response - MIP3 with Chemical Injection Points CO-4 and CO-5 Shown

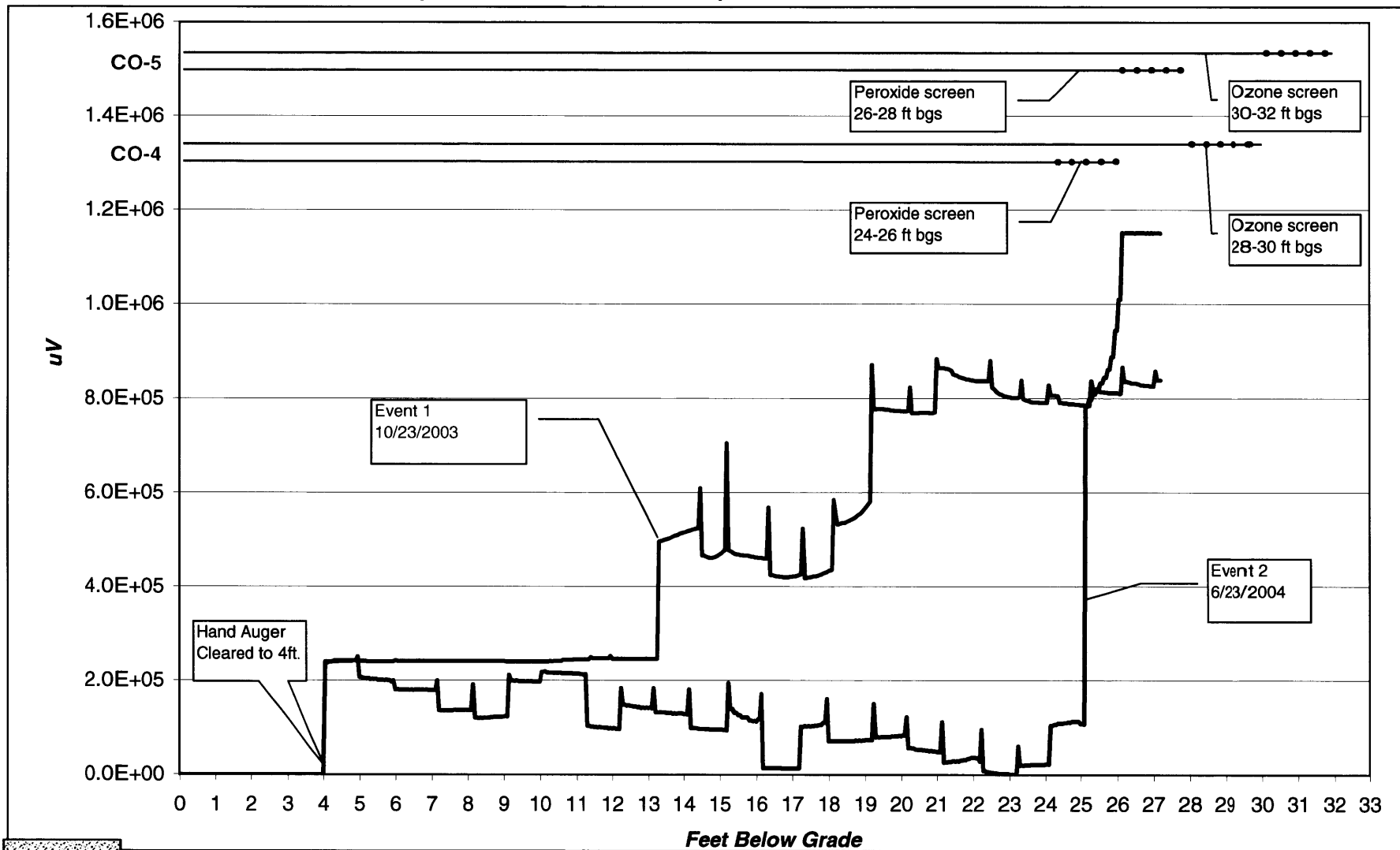

Zebra Environmental
30 No. Prospect Avenue, Lynbrook, NY

For: GES
Project Name: ExxonMobil Buffalo

FID Response - MIP3 with Chemical Injection Points CO-4 and CO-5 Shown

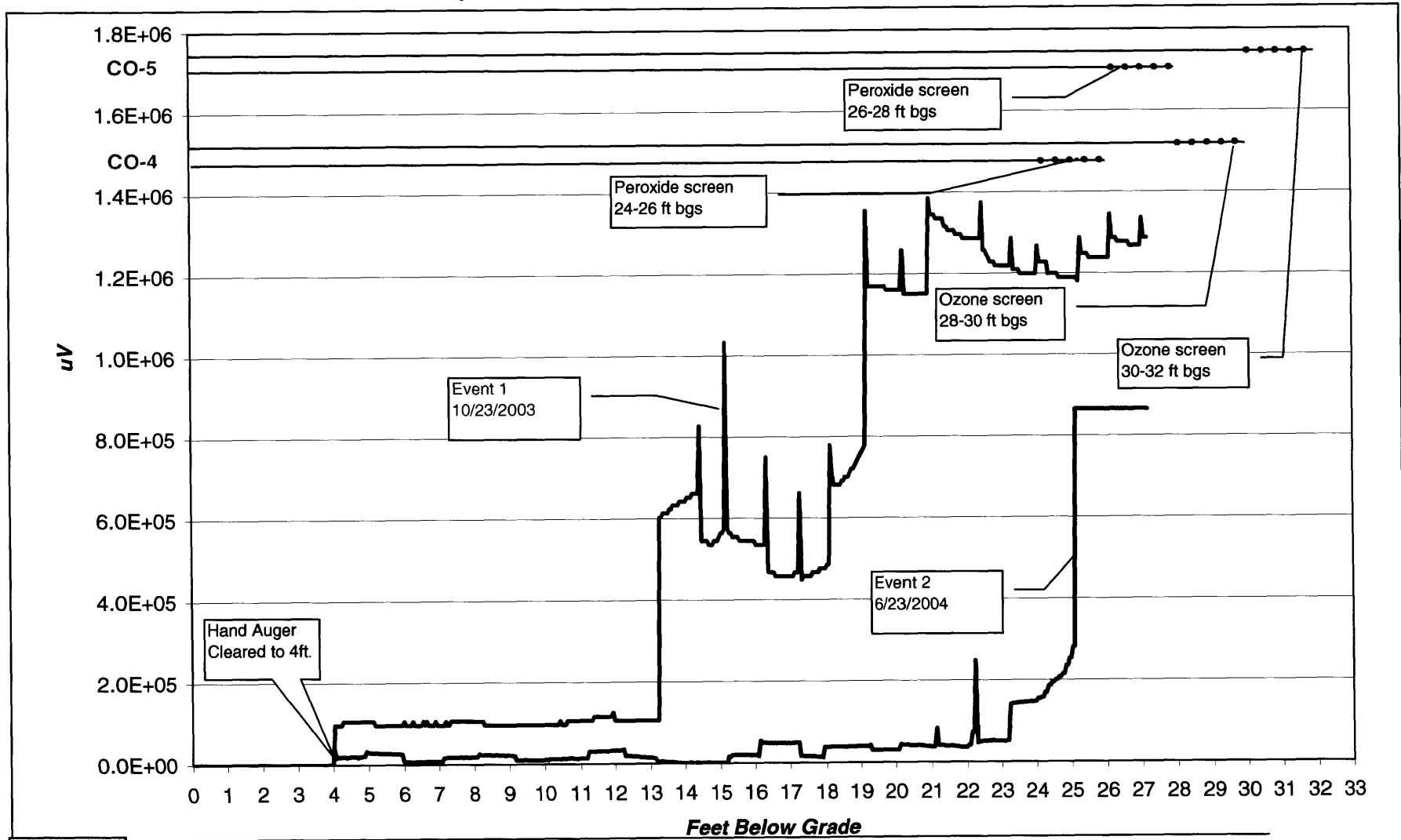

Zebra Environmental
30 No. Prospect Avenue, Lynbrook, NY

For: GES
Project Name: ExxonMobil Buffalo

Soil Conductivity - MIP3

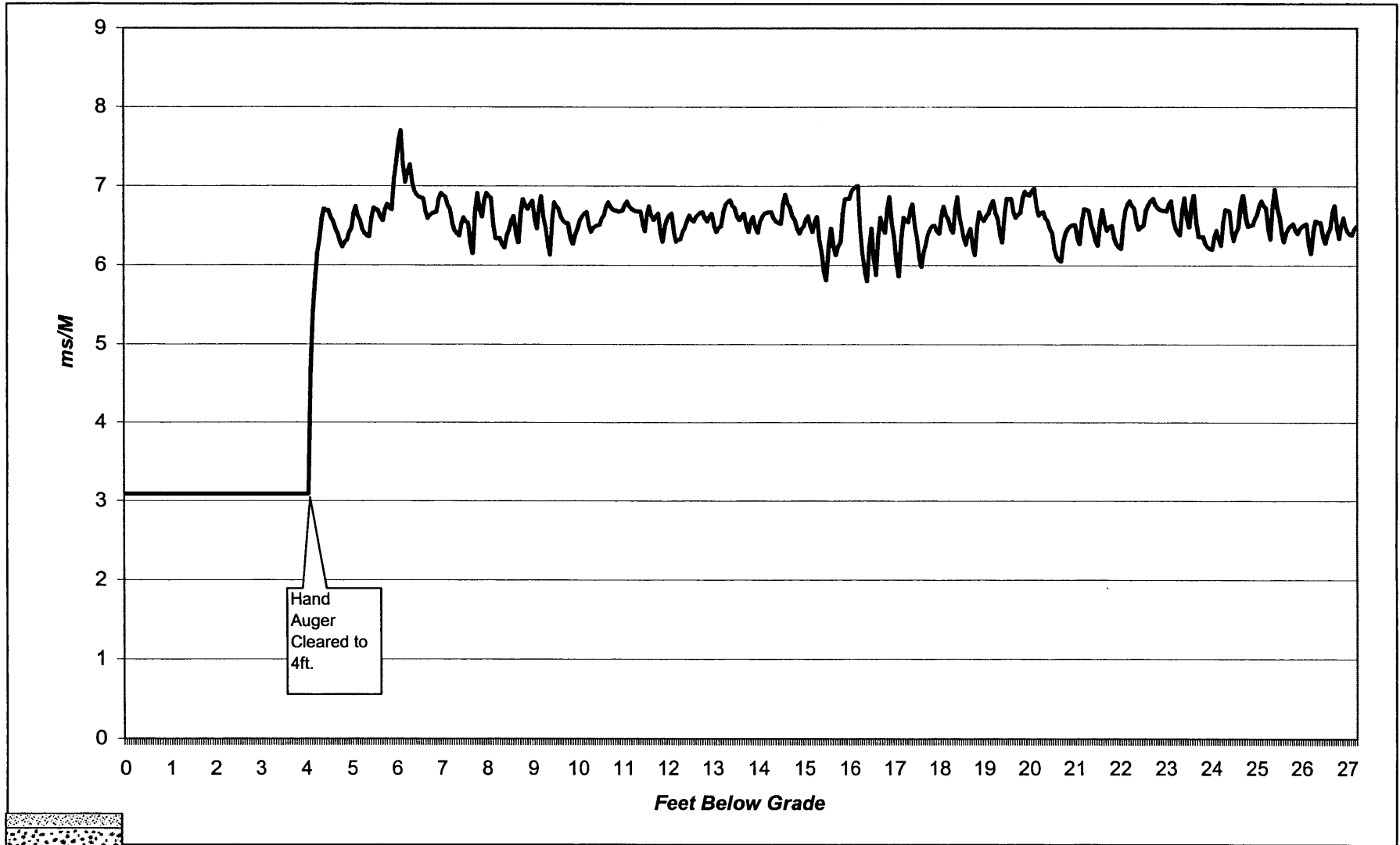

Zebra Environmental 30 No. Prospect Avenue, Lynbrook, N	For: GES Project Name: ExxonMobil Buffalo
--	--

Hydrographs for LF-3 (ETYA) during ChemOx Pilot Test, Buffalo Terminal, ExxonMobil Oil Corporation, Buffalo, New York

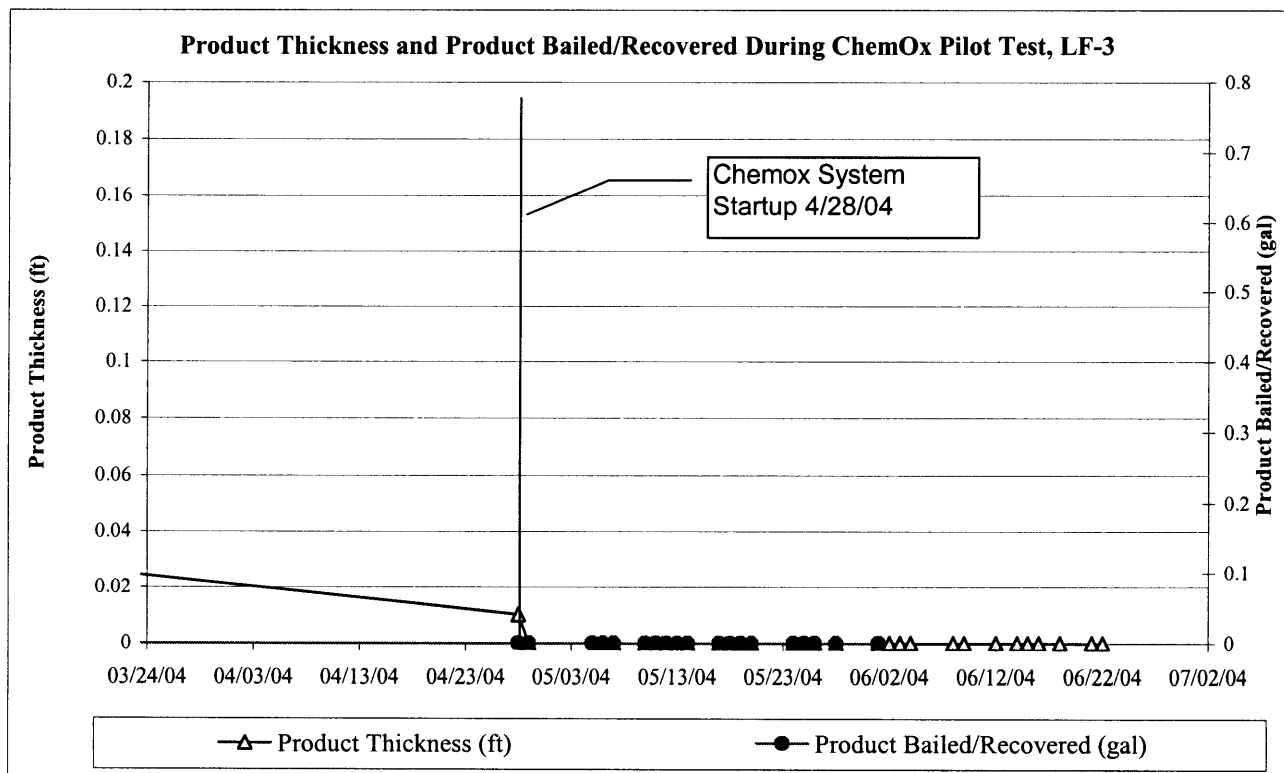
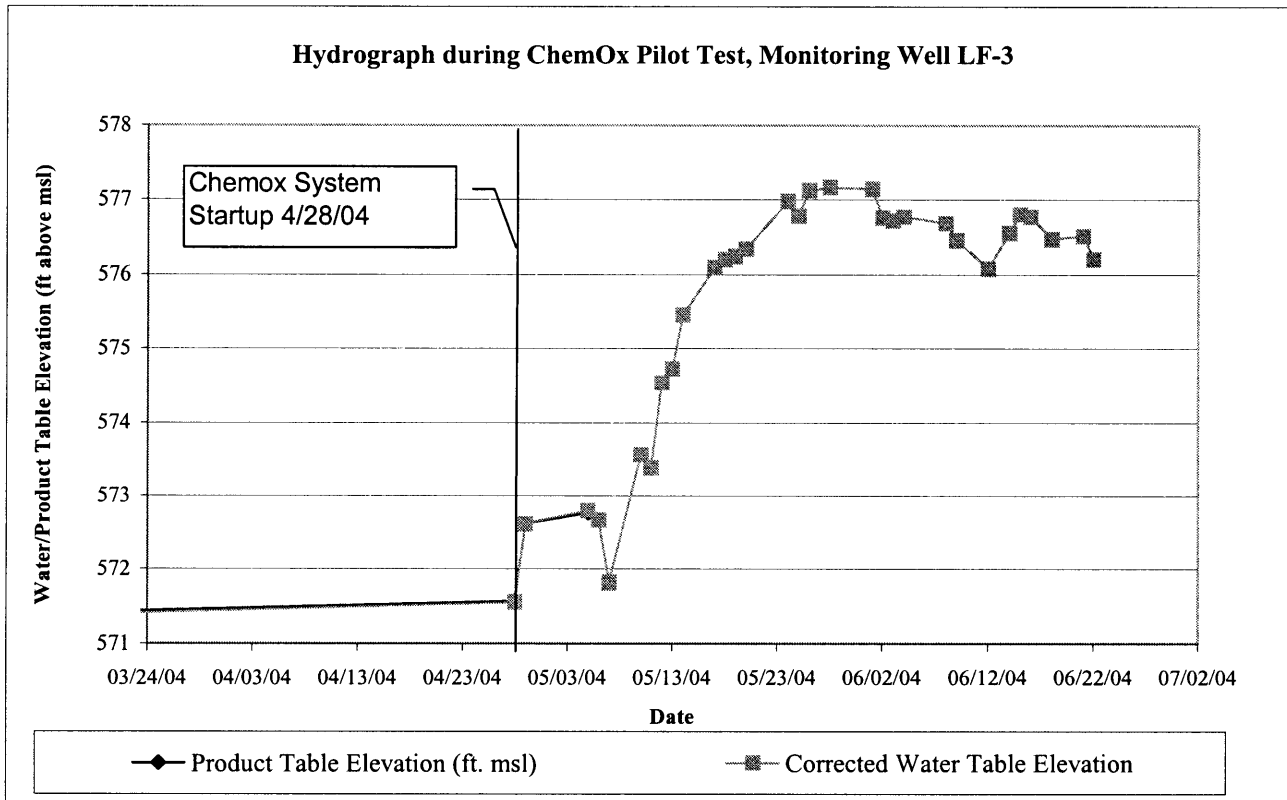

Hydrographs for LF-6 (ETYA) during ChemOx Pilot Test, Buffalo Terminal, ExxonMobil Oil Corporation, Buffalo, New York

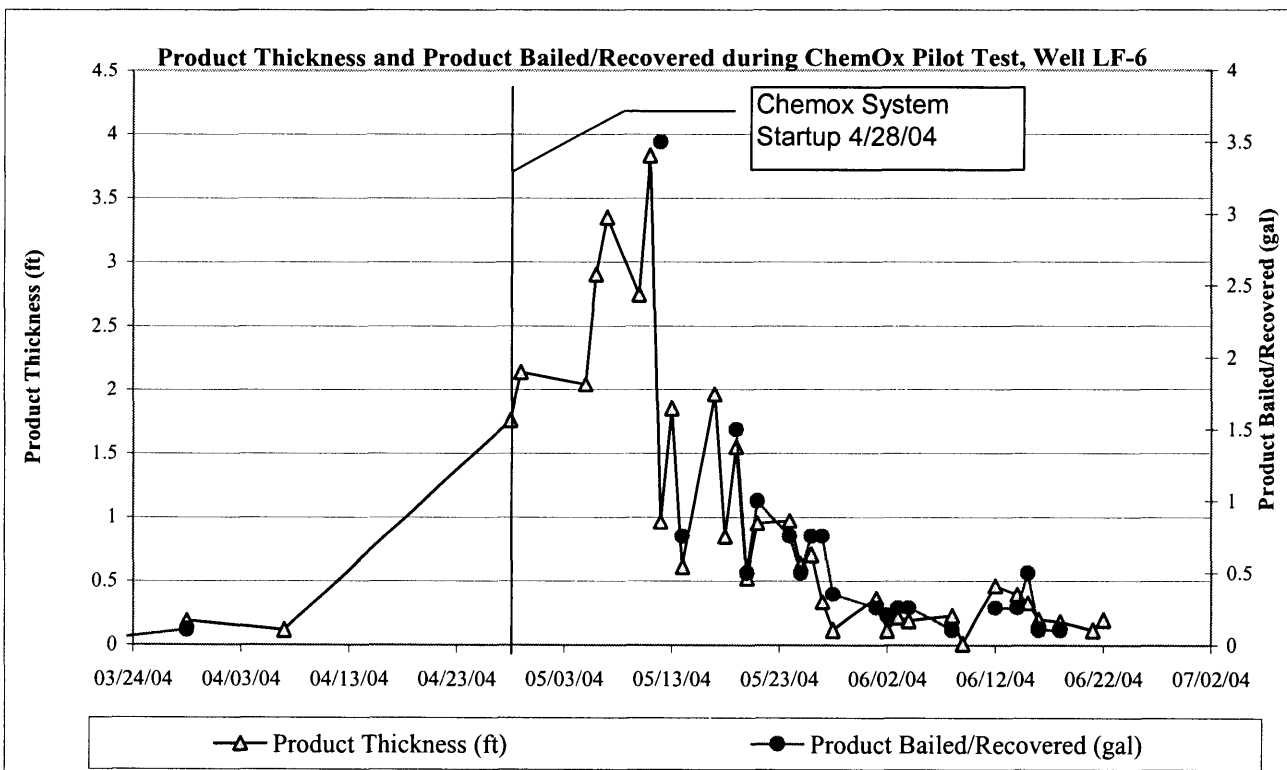
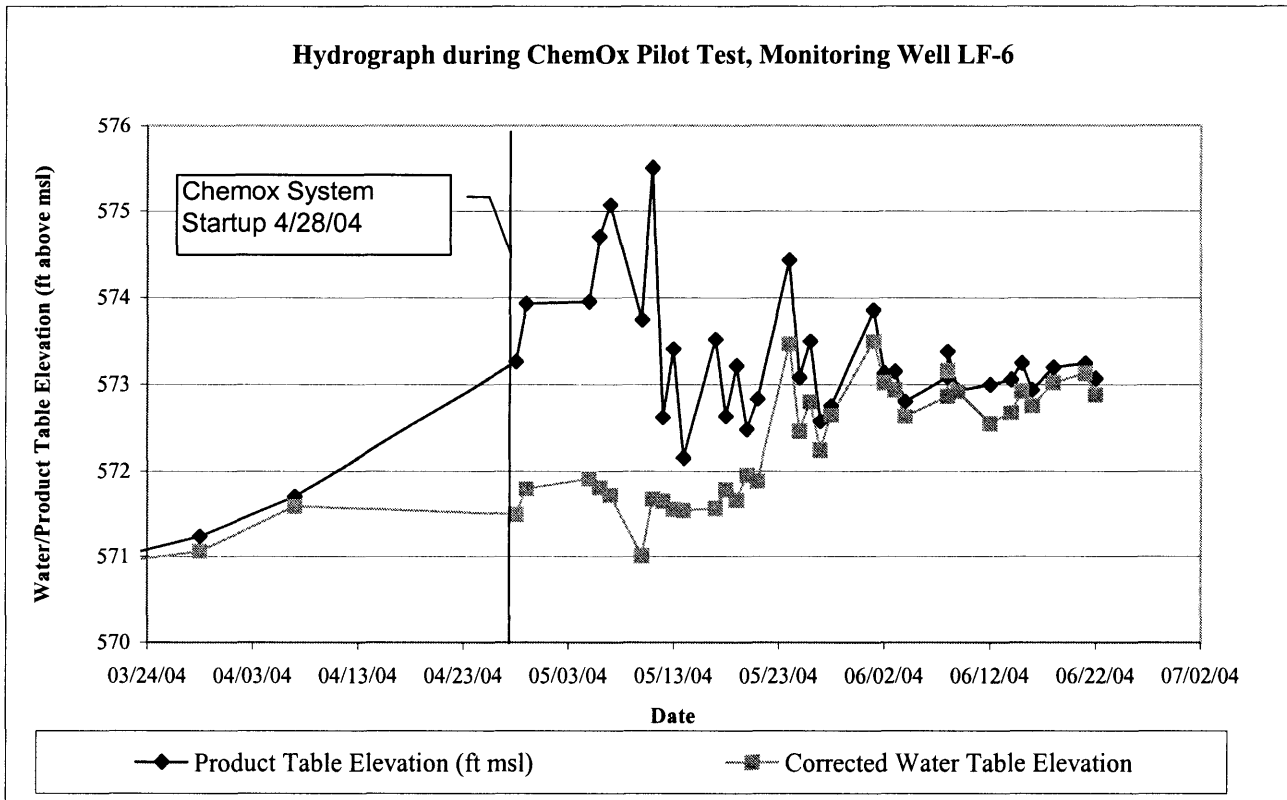

Hydrographs for LF-1S (ETYA) during ChemOx Pilot Test, Buffalo Terminal, ExxonMobil Oil Corporation, Buffalo, New York

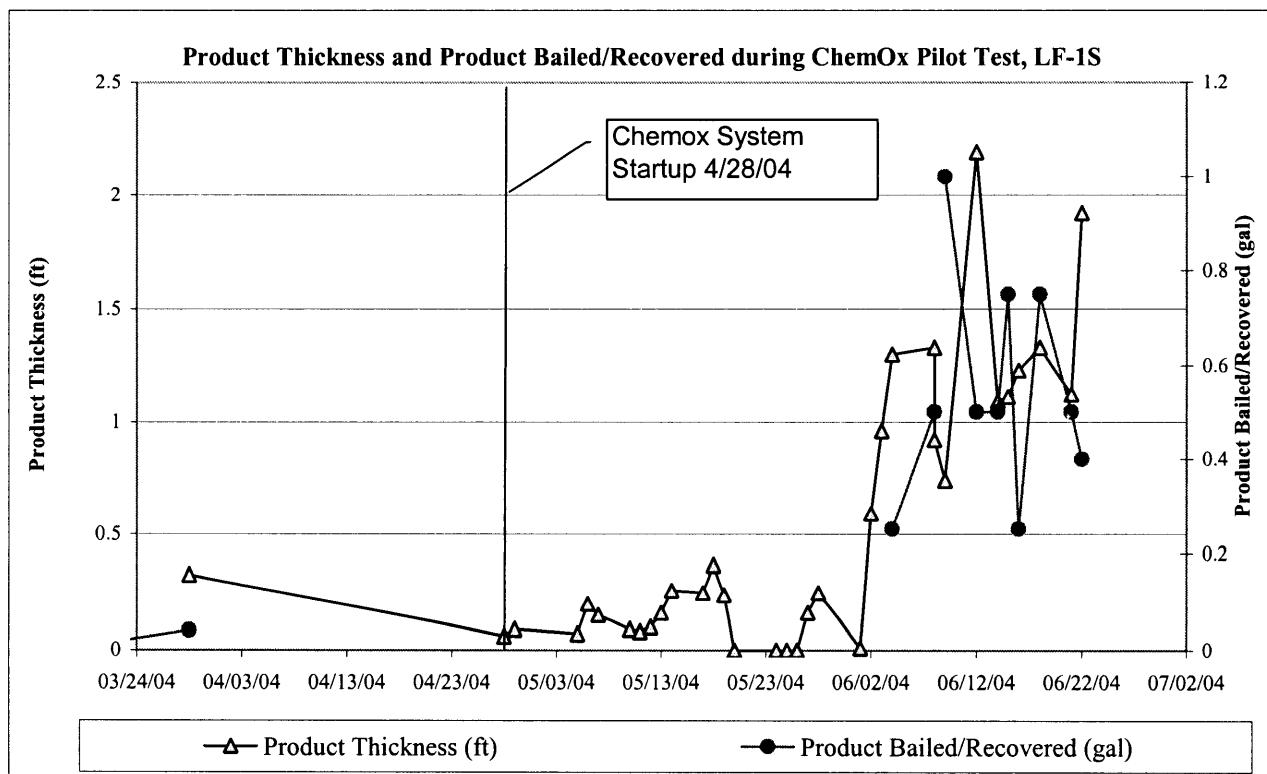
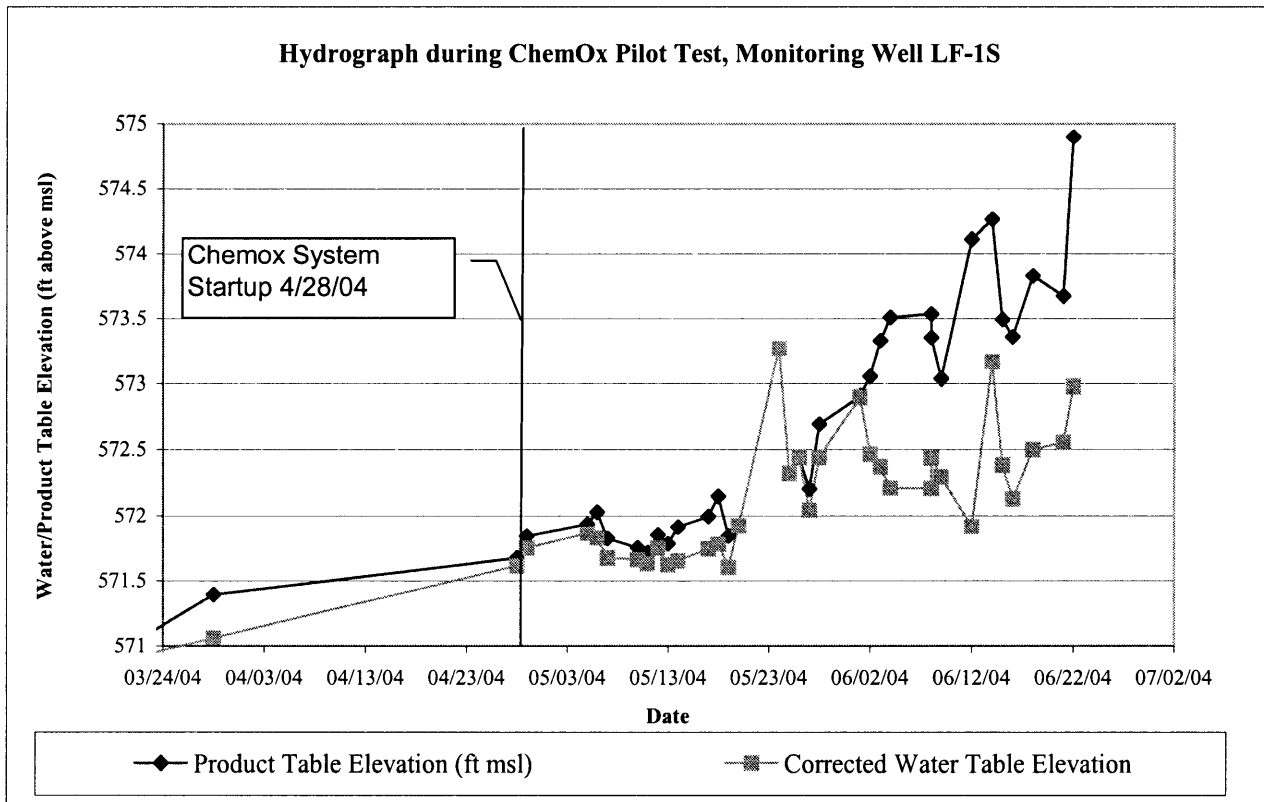

Hydrographs for MW-28 (ETYA) during ChemOx Pilot Test, Buffalo Terminal, ExxonMobil Oil Corporation, Buffalo, New York

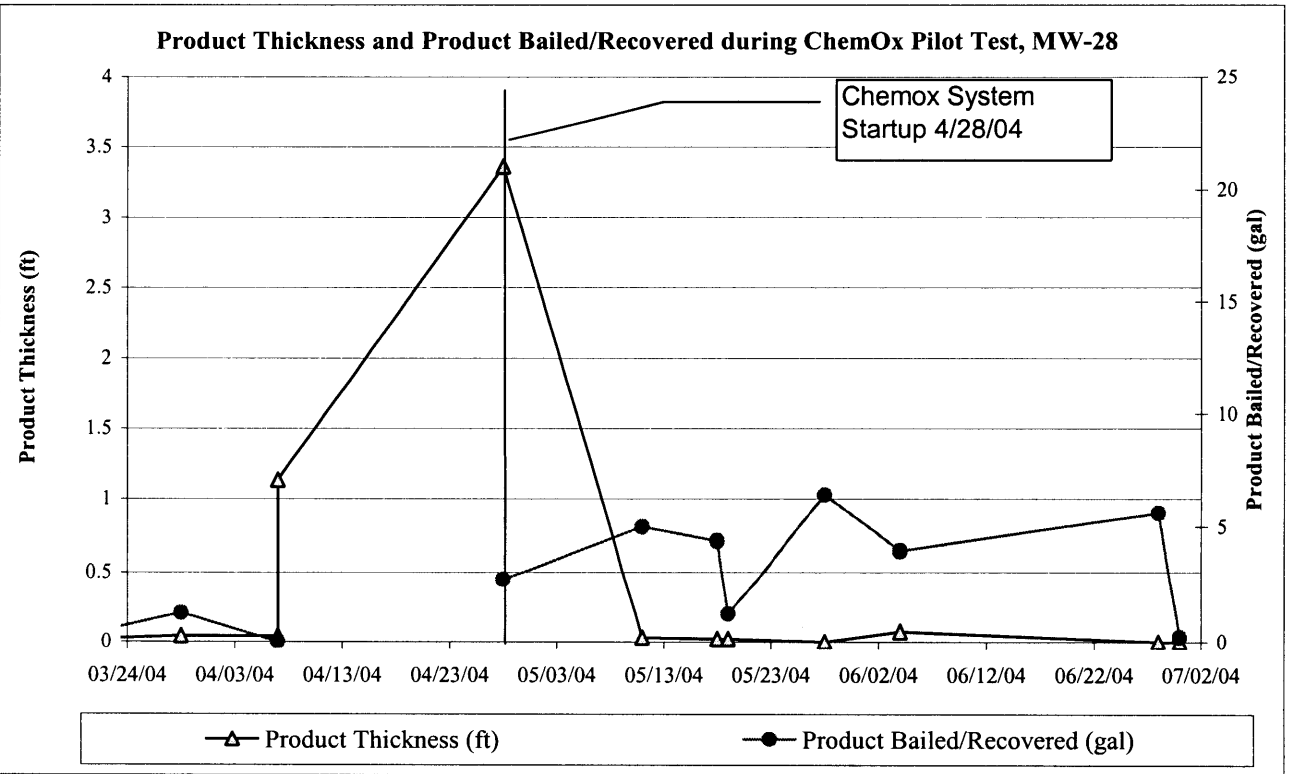
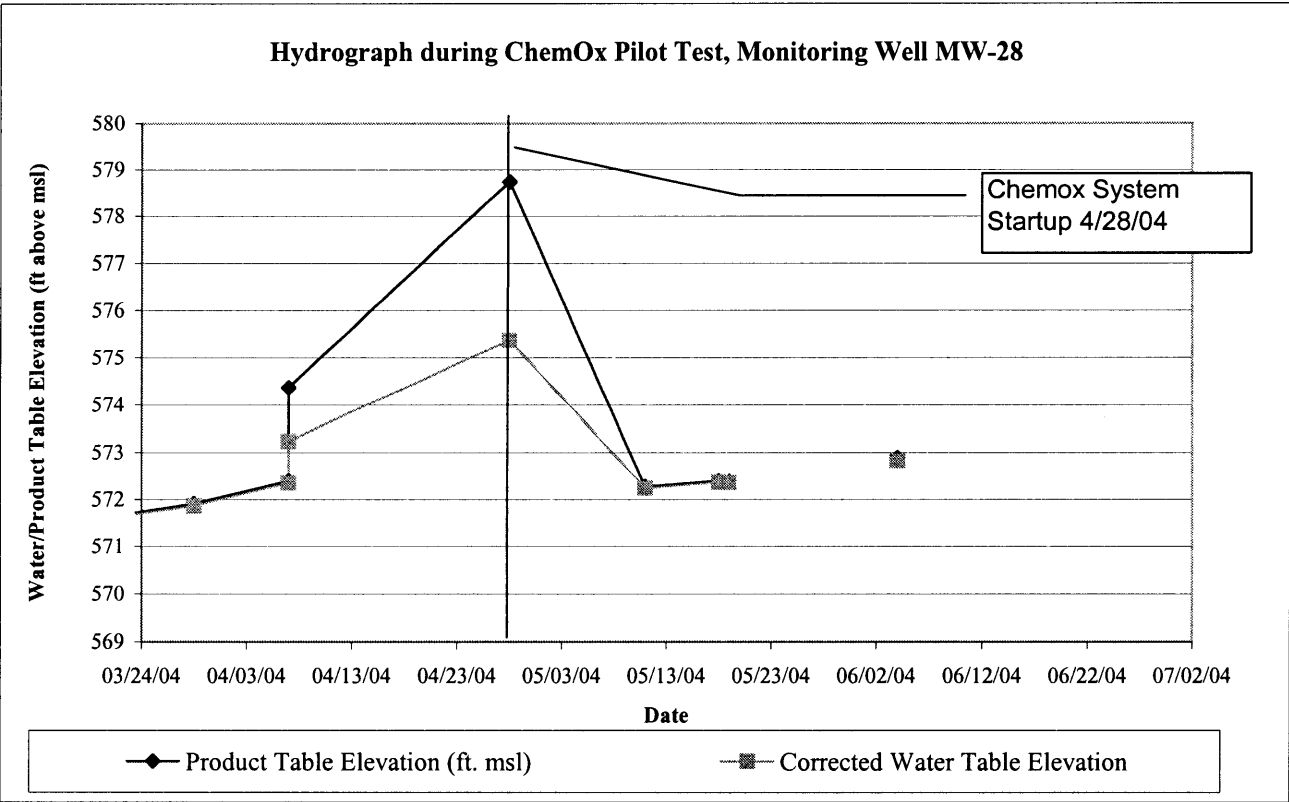

Hydrograph during ChemOx Pilot Test, Chemical Injection Well CO-1

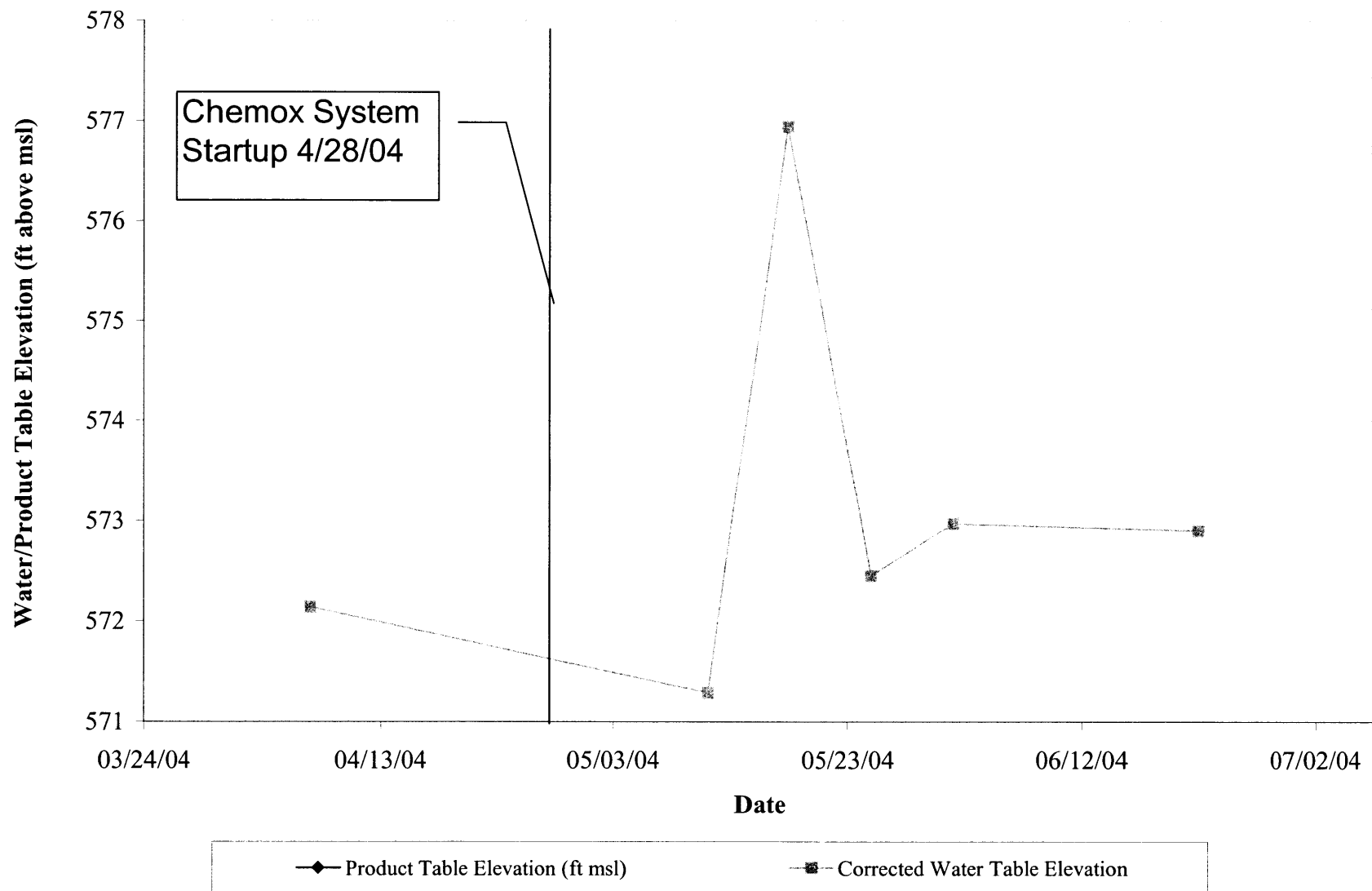

Hydrograph during ChemOx Pilot Test, Chemical Injection Well CO-2

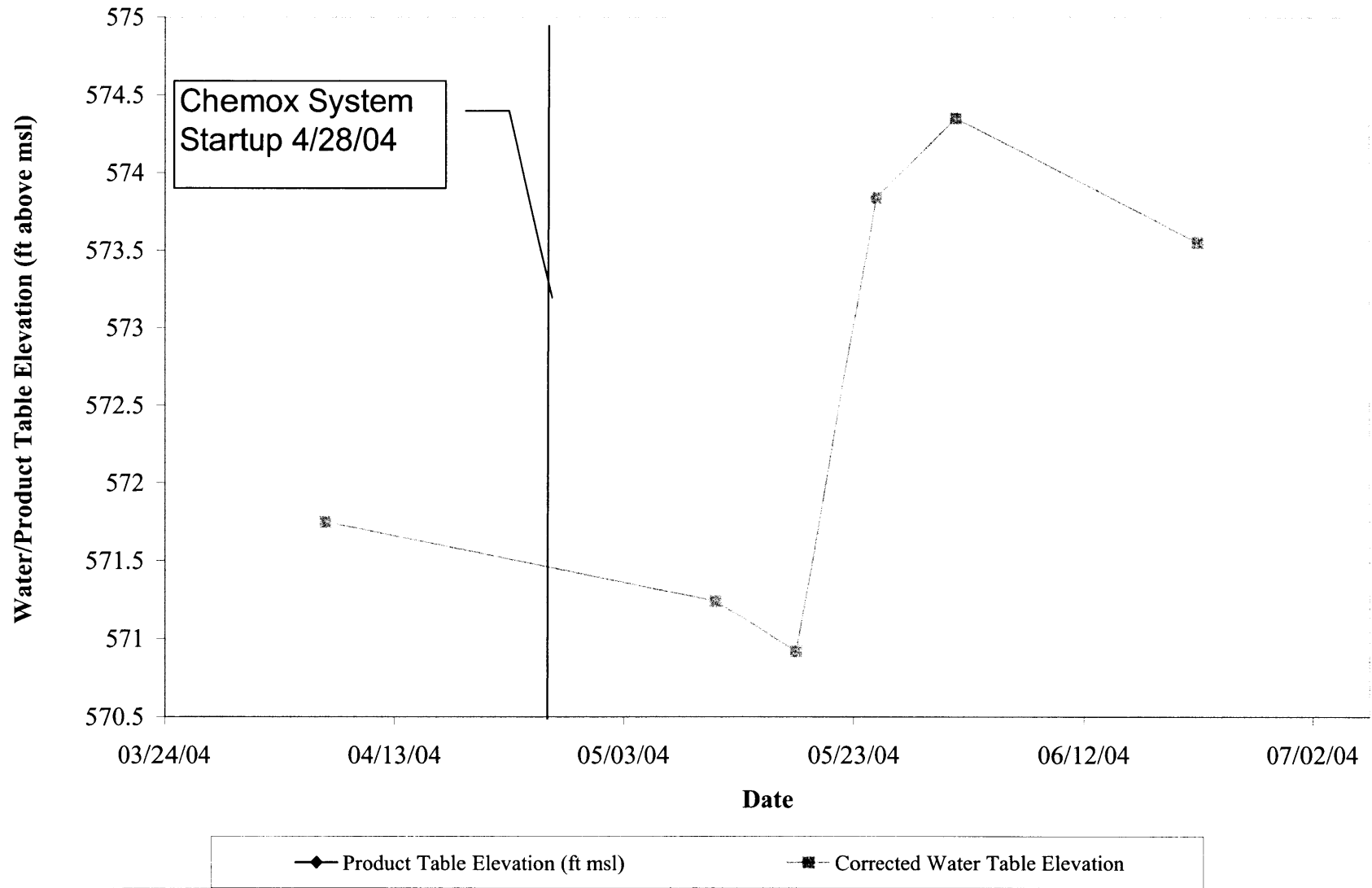

Hydrograph during ChemOx Pilot Test, Chemical Injection Well CO-3

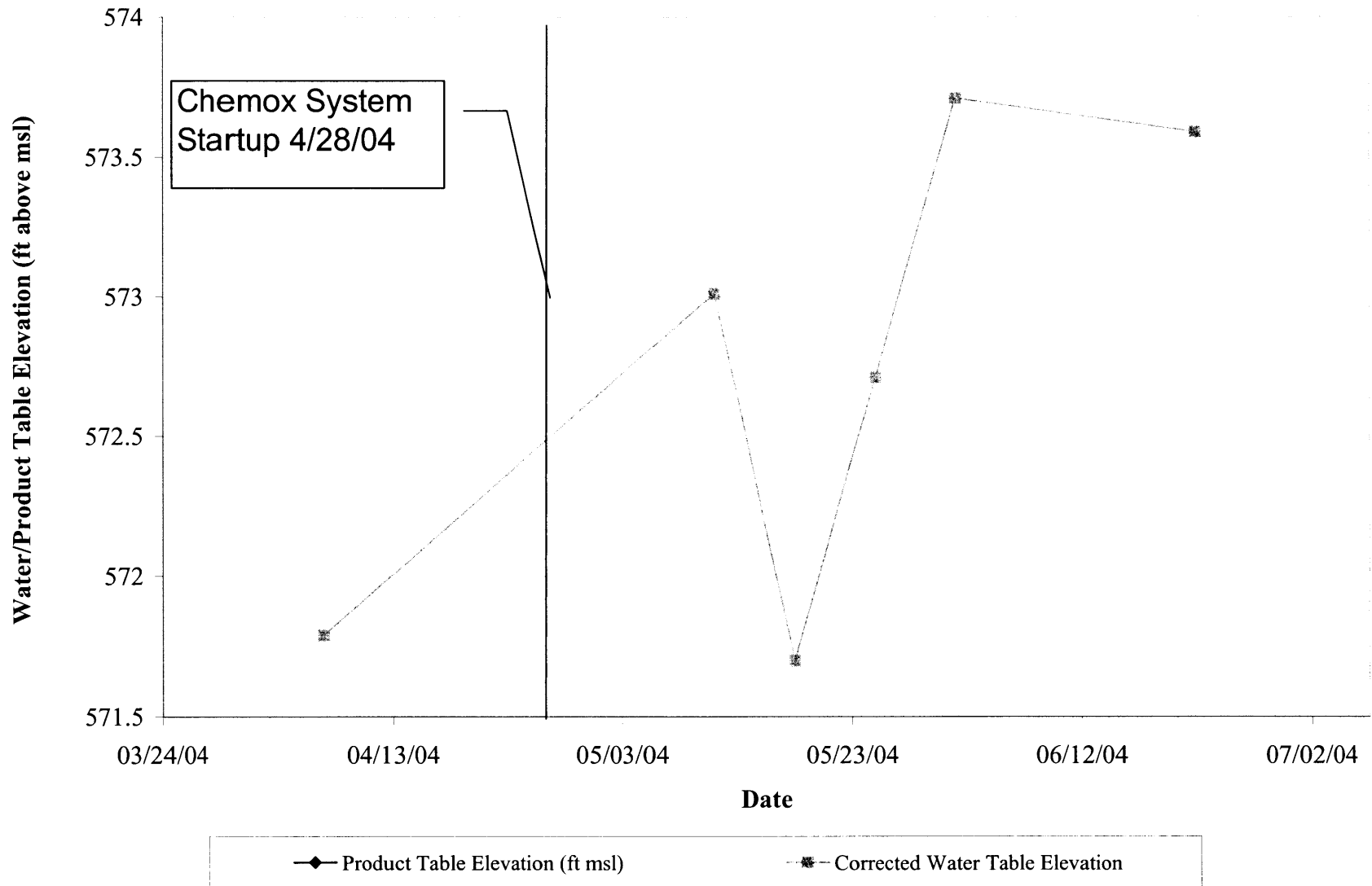

Hydrograph during ChemOx Pilot Test, Chemical Injection Well CO-4

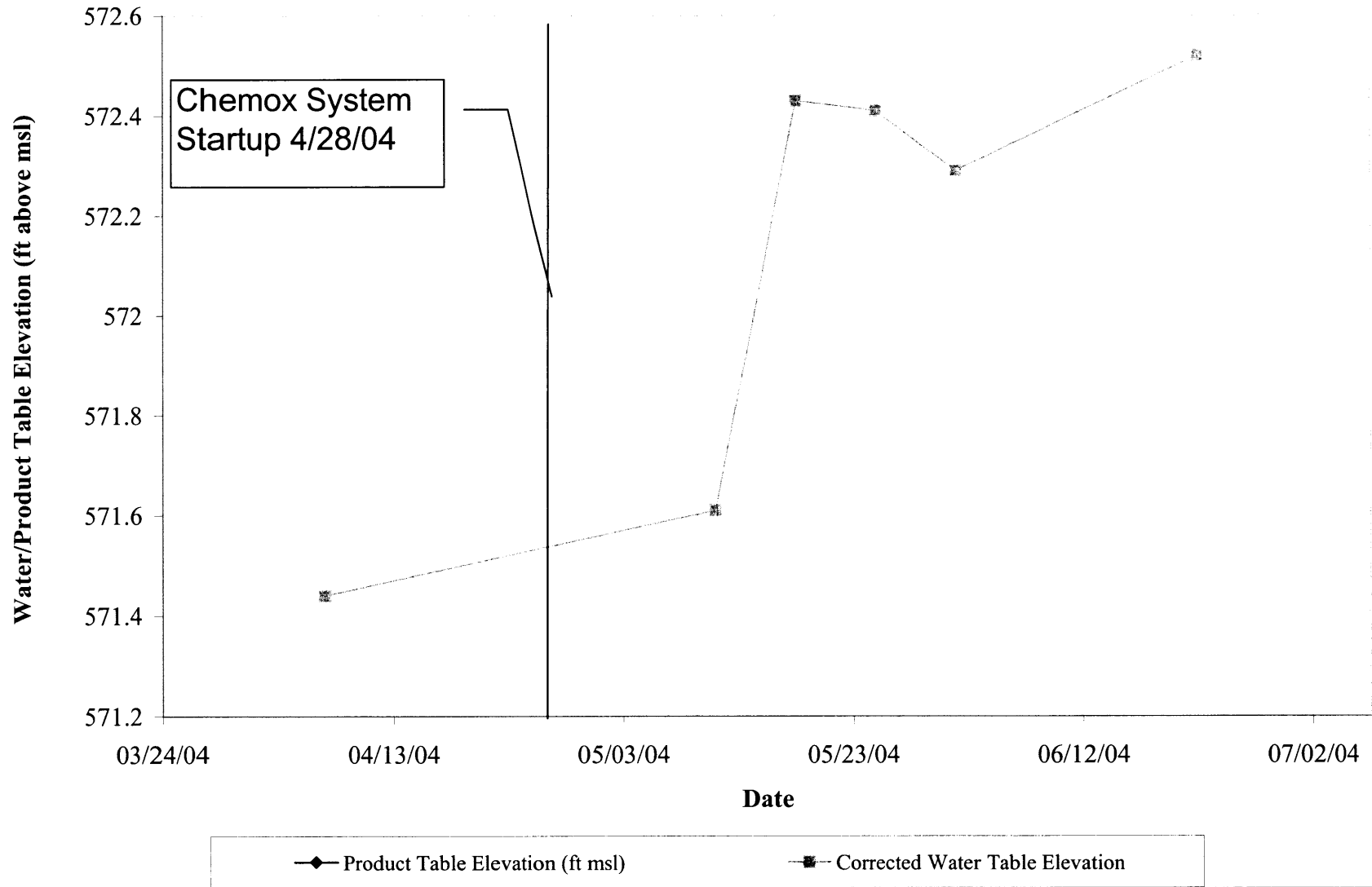

Hydrograph during ChemOx Pilot Test, Chemical Injection Well CO-5

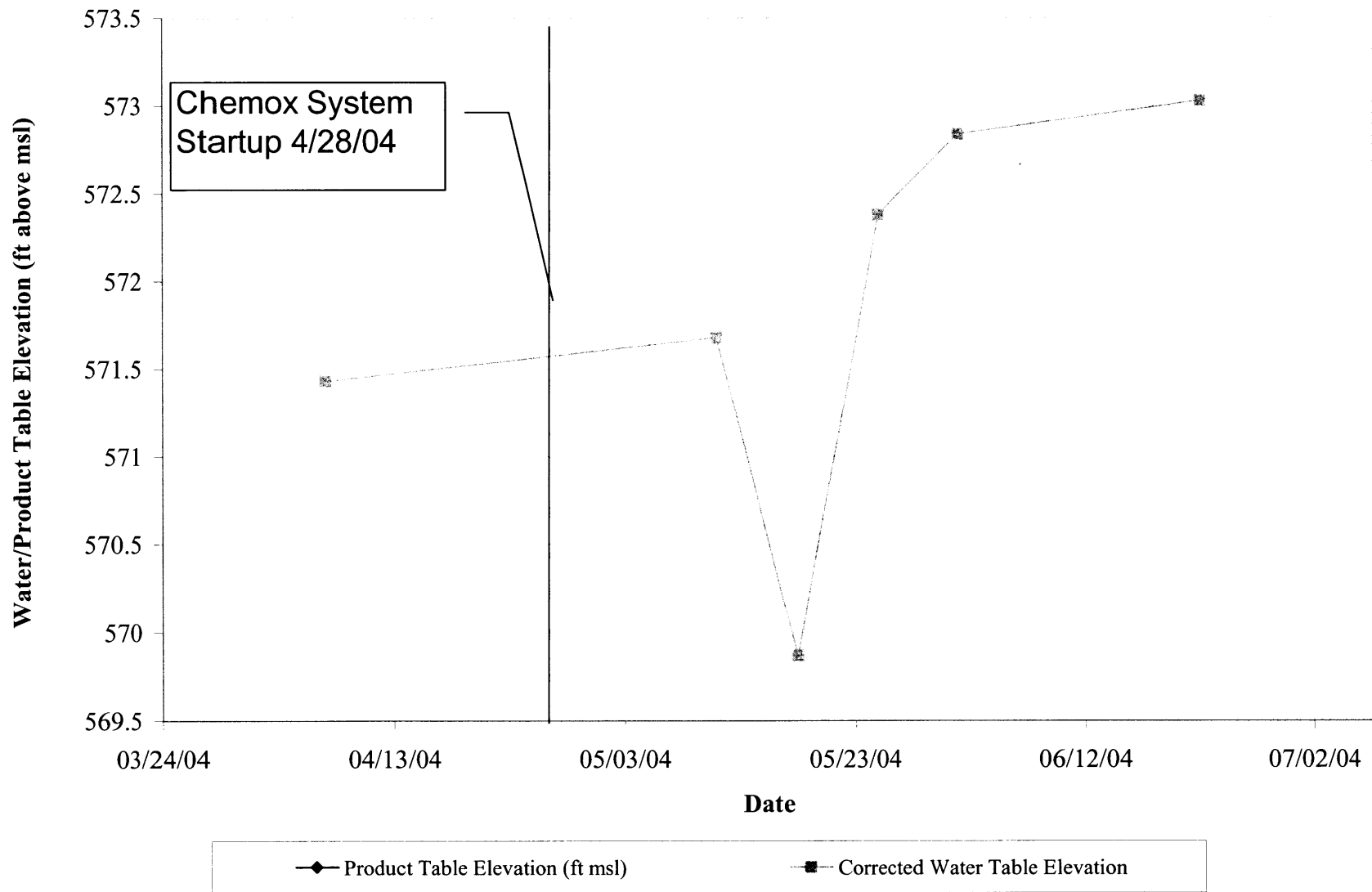

Hydrograph during ChemOx Pilot Test, Monitoring Well VERMW-4

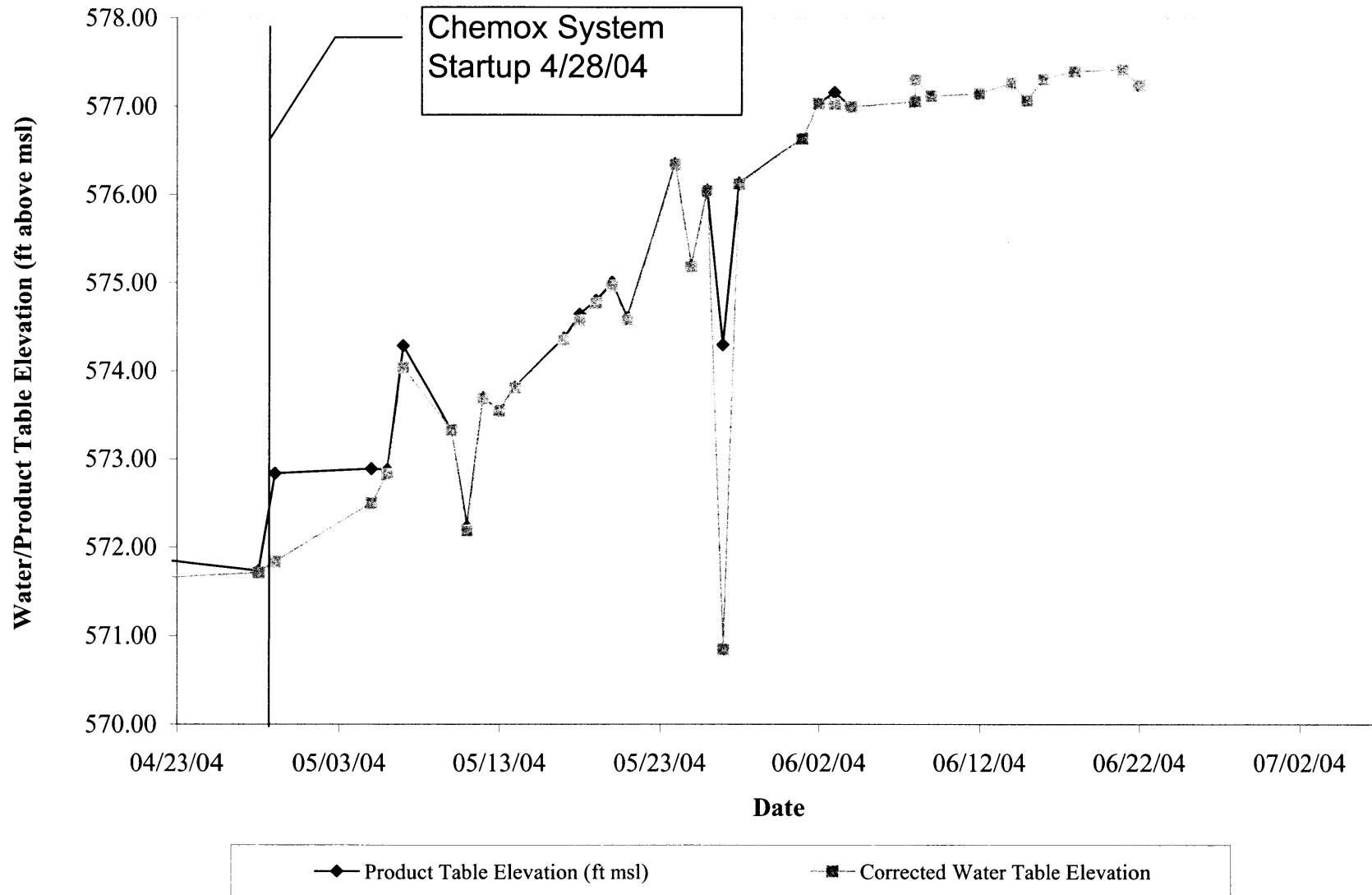

Hydrograph during ChemOx Pilot Test, Monitoring Well VERMW-2

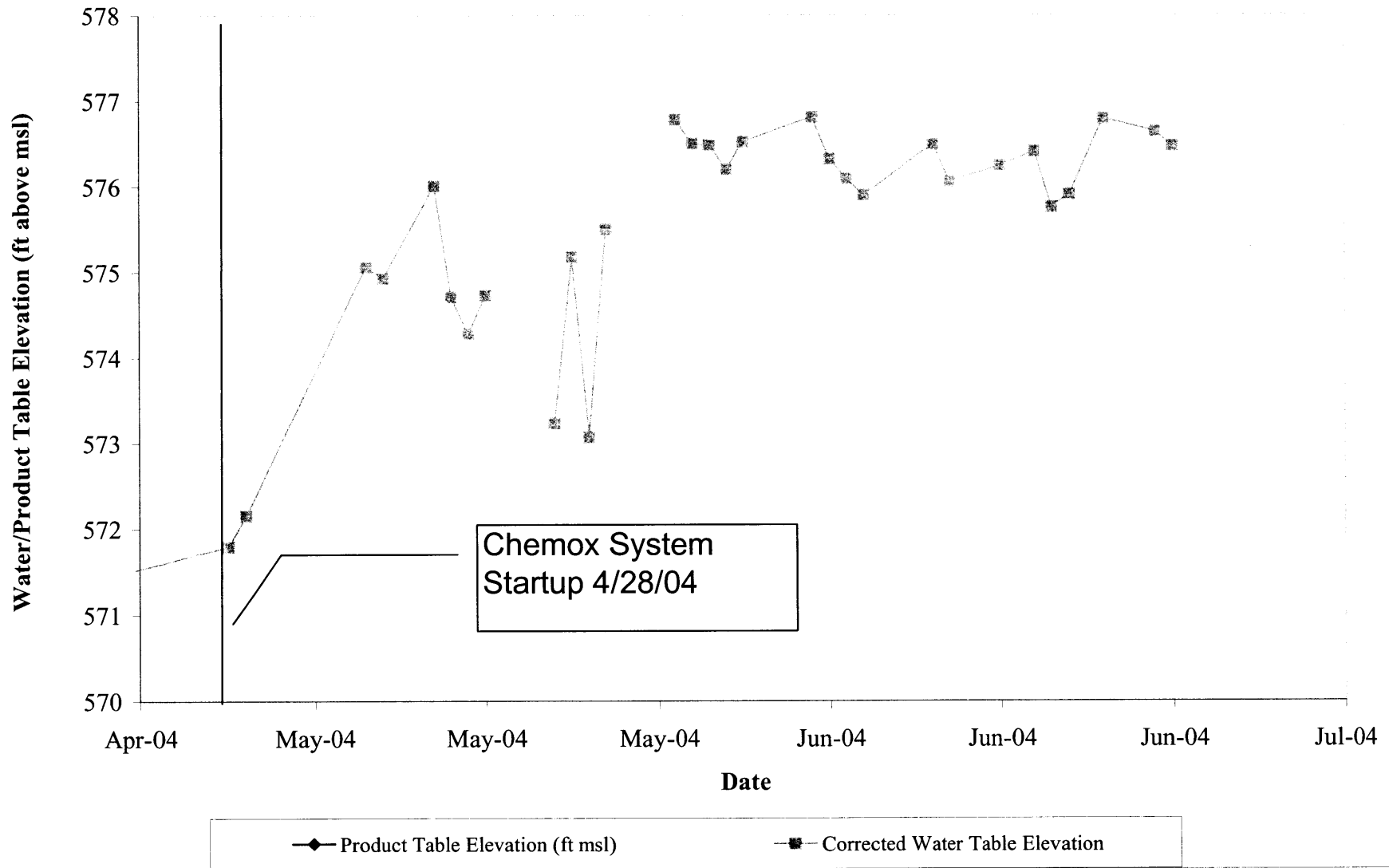

Hydrograph during ChemOx Pilot Test, Monitoring Well VERMW-1

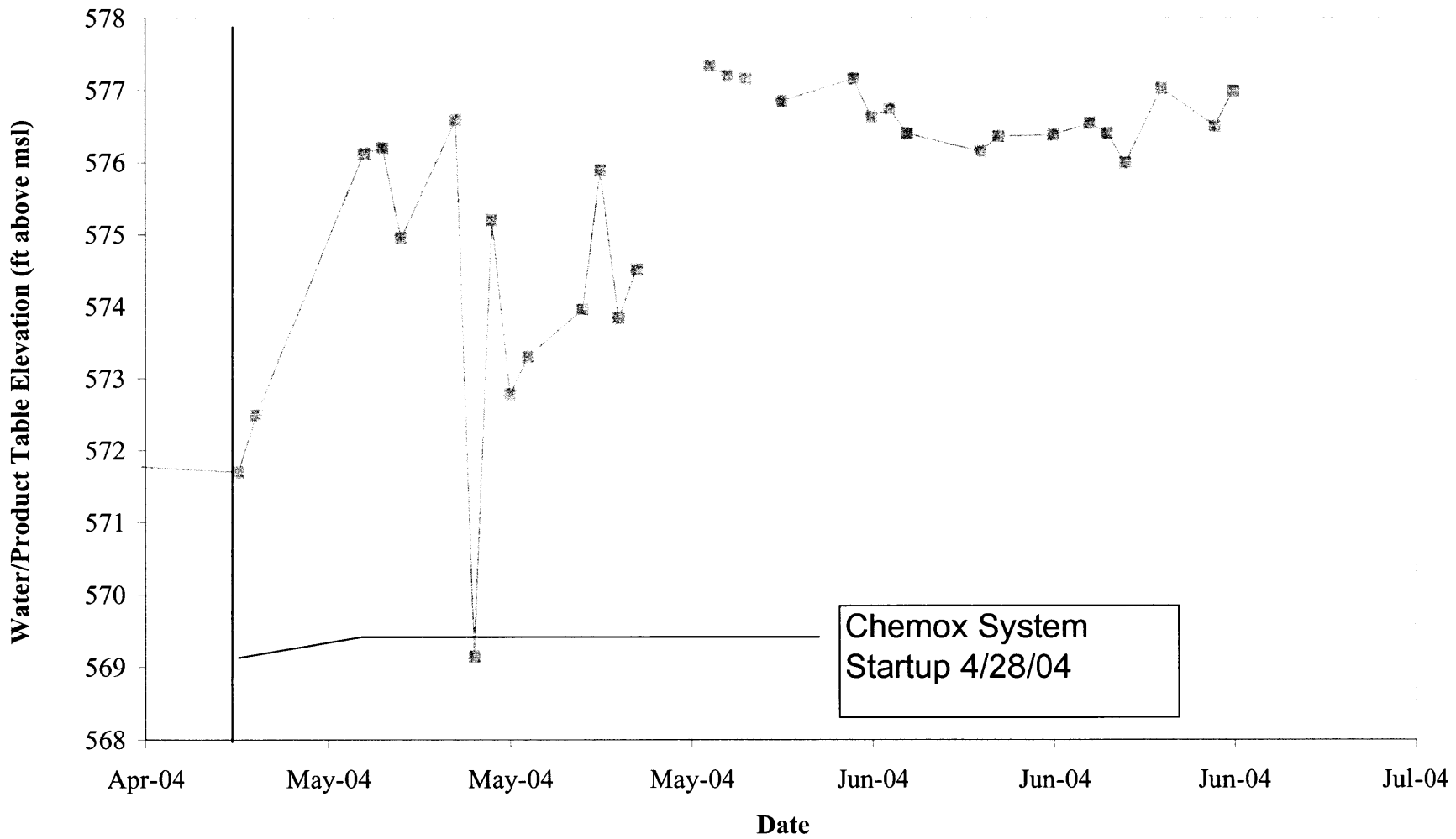

Chemox System
Startup 4/28/04

◆ Product Table Elevation (ft msl)

■ Corrected Water Table Elevation

Concentrations of Headspace Parameters
with Time during ChemOx Pilot Test

VERMW-1, Headspace Parameters

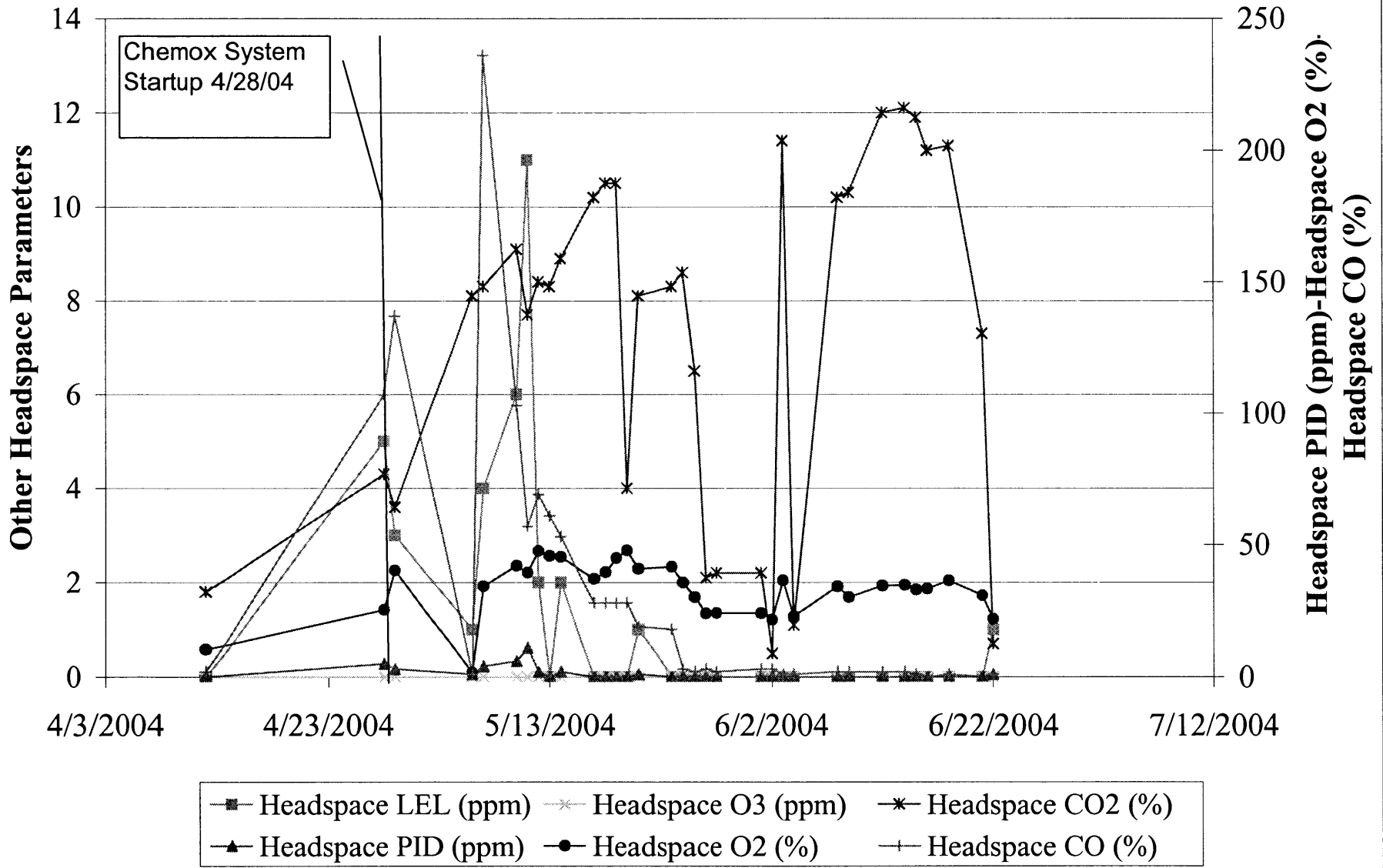

VERMW-2, Headspace Parameters

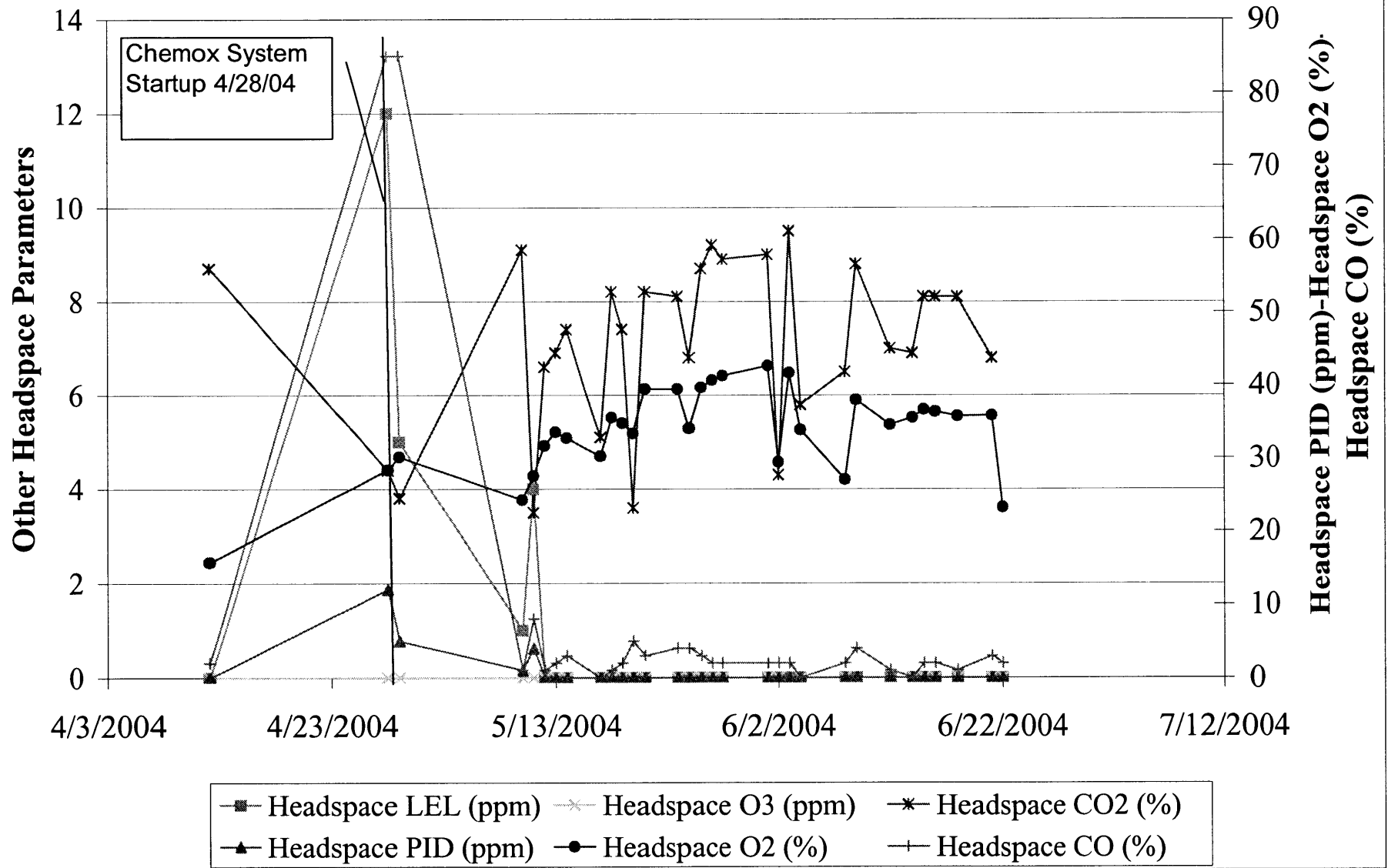

VERMW-3, Headspace Parameters

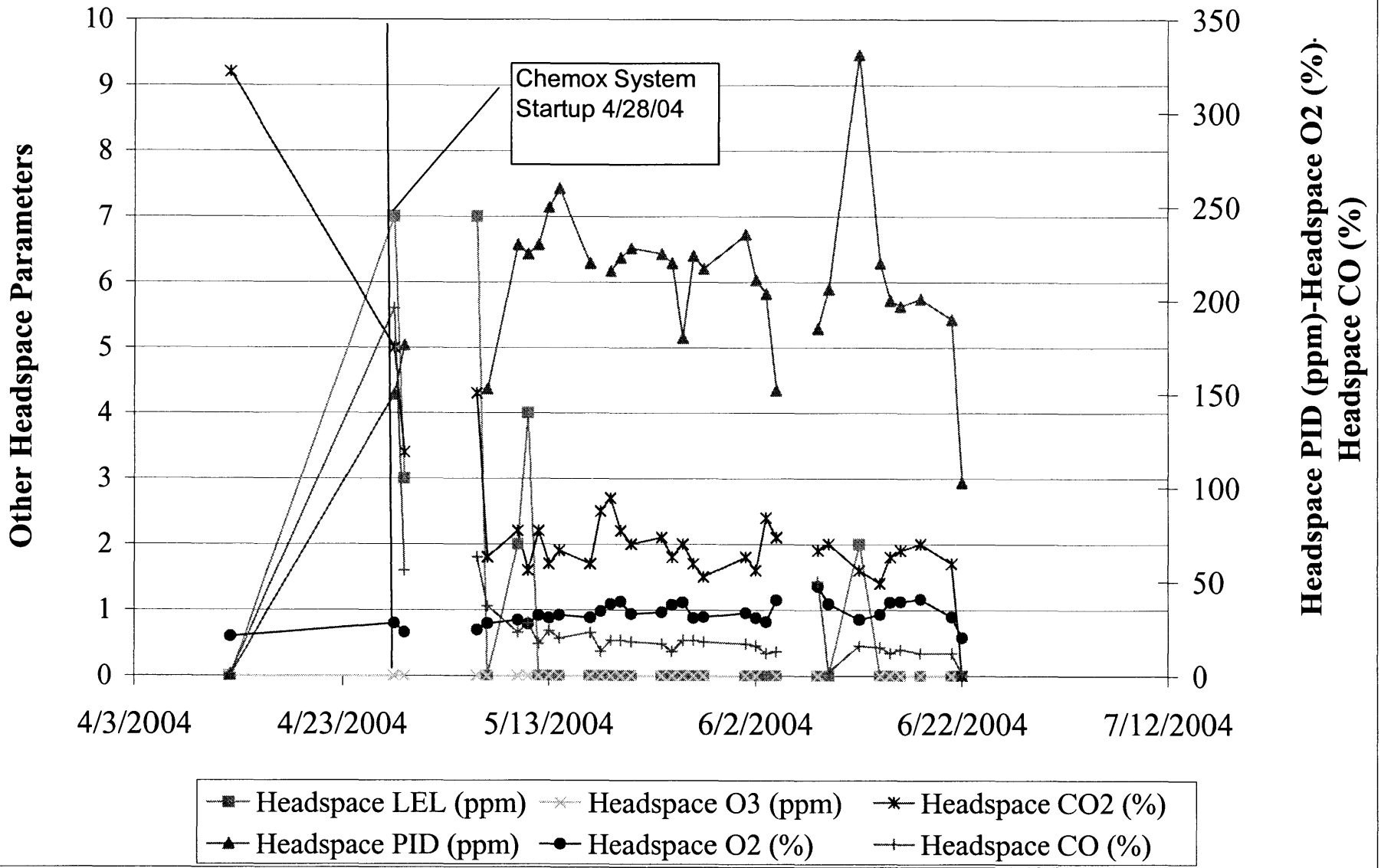

VERMW-4, Headspace Parameters

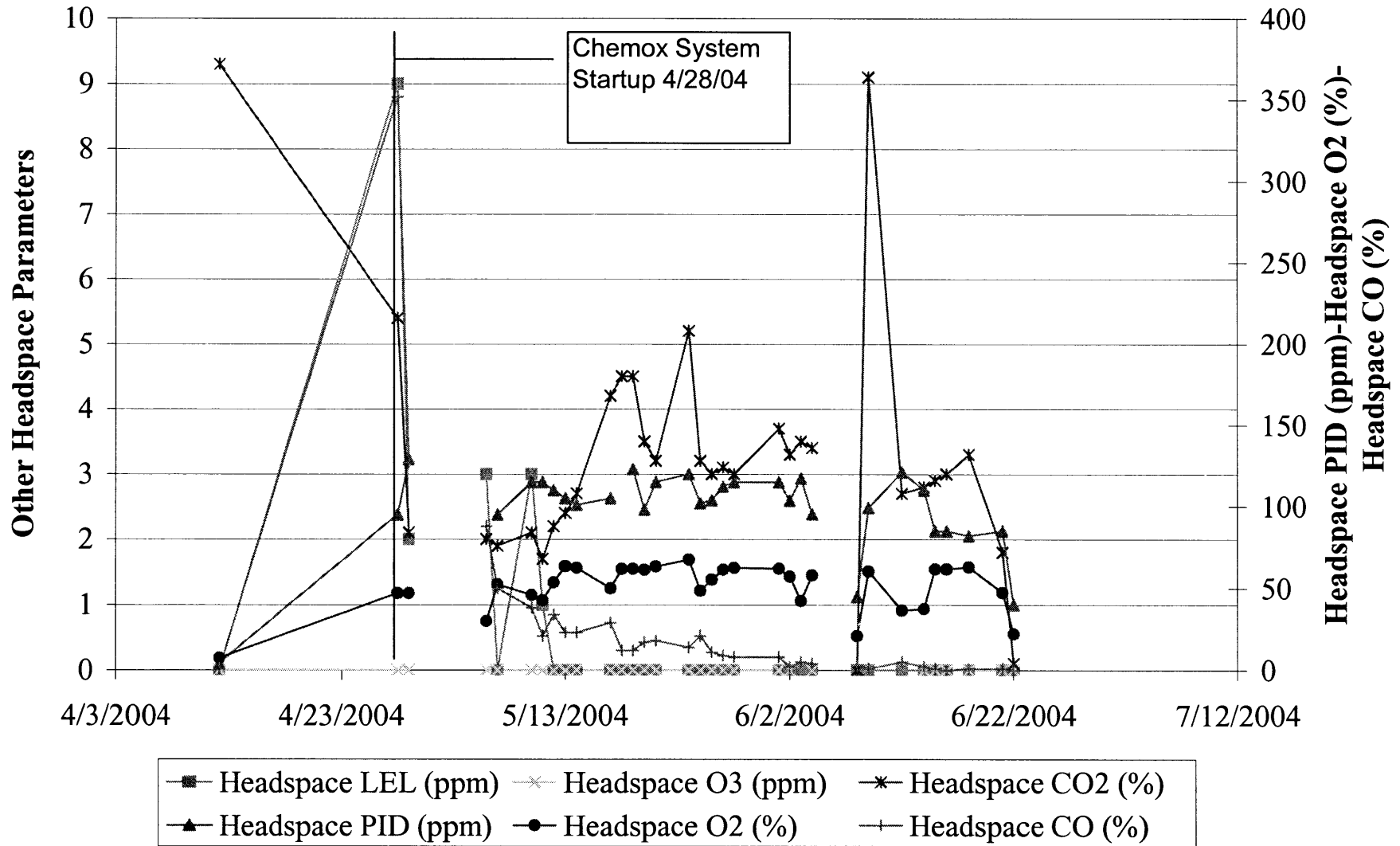

LF-1S, Headspace Parameters

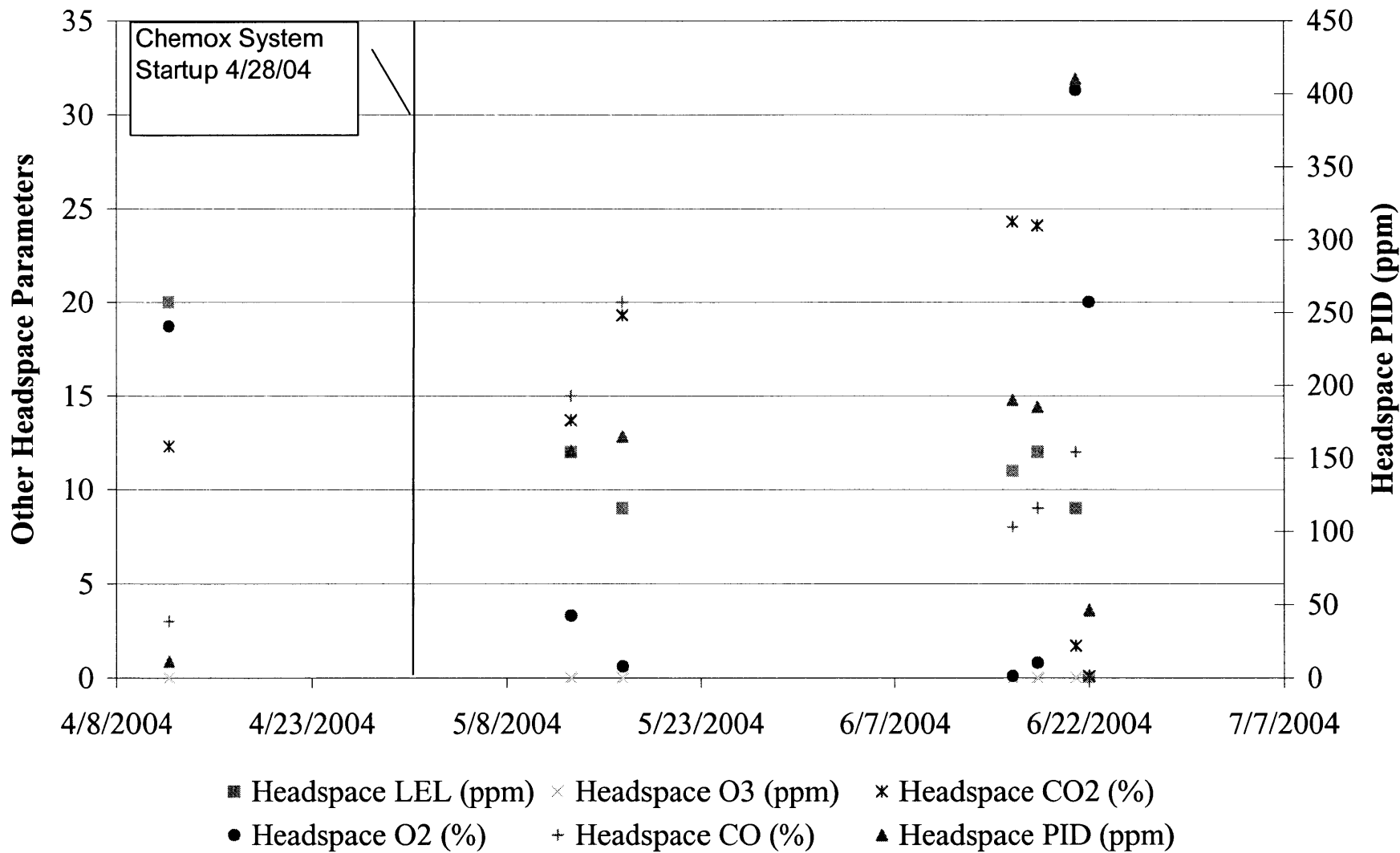

LF-6, Headspace Parameters

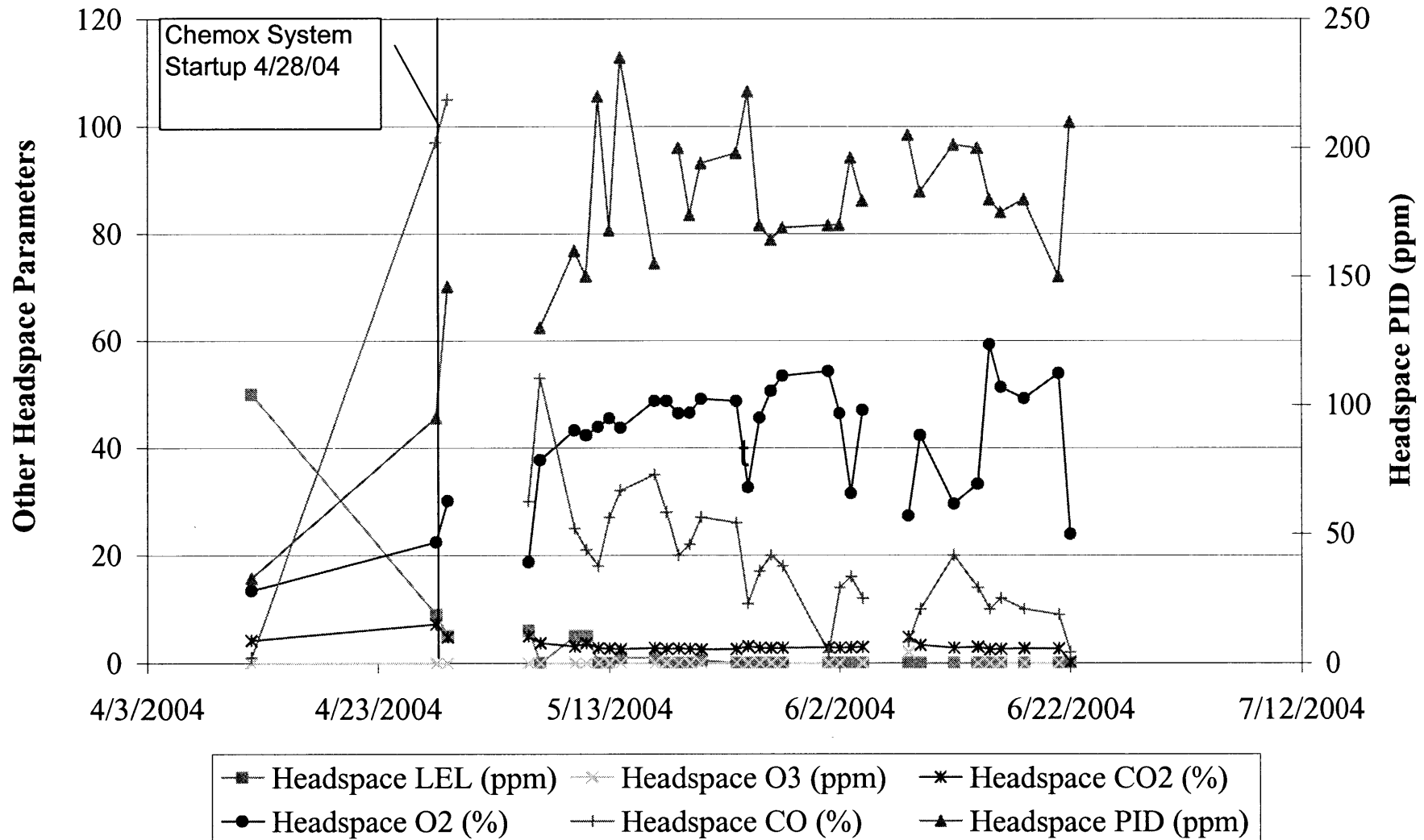

ChemOx Pilot Test Data

Chemical Oxidation (ChemOx) Pilot Test Data

Location	Date	Time	System Parameters		Headspace Parameters						Groundwater Parameters										Comments			
			Pressure (PSI)	Flow (GPH)	LEL (PPM)	PID (PPM)	O ₃ (PPM)	CO ₂ (%)	O ₂ (%)	CO (%)	pH	Temp	ORP (mV)	DO (PPM)	Cond (PPM)	Turb (PPM)	% H ₂ O ₂	DTW (ft)	DTP (ft)	TD		Sampled Y/N		
Ambient Air	4/7/2004																							BASELINE GROUNDWATER DATA
Ambient Air	4/12/2004																							BASELINE HEADSPACE DATA
Ambient Air	4/27/2004																							
Ambient Air	4/28/2004	0830			0	0	0																	PLC ON @ 8:30AM
Ambient Air	04/29/04				0	0.3	0																	ALL PRESSURE READINGS ARE SUSPECT DUE TO HIGH WINDS
Ambient Air	5/6/2004				0	0	0																	System back online at 1200; PID dead battery; Could not get solid start of product reading due to bubbling
Ambient Air	5/7/2004				0	0	0																	LEL INSTRUMENT MALFUNCTION
Ambient Air	5/10/2004				0	0	0																	ALL WATER APPEARS RUSTY
Ambient Air	5/11/2004				0	0	0																	SYSTEM DOWN FROM 0900-1200 FOR GROUNDWATER SAMPLING AND EQUIPMENT MAINTENANCE; SYSTEM DOWN FROM 1400-1530 FOR CO WELLS DO MEASUREMENT; TOO MUCH PRODUCT TO GET GOOD H2O2 READING
Ambient Air	05/12/04																							ALL PRESSURE READINGS ARE SUSPECT DUE TO HIGH WINDS
Ambient Air	05/13/04																							
Ambient Air	5/14/2004																							
Ambient Air	5/17/2004		0	0	0	0.01	0																	
Ambient Air	5/18/2004				0	0	0																	SYSTEM DOWN FROM 1100-1400; NO PID AVAILABLE FOR WELL READINGS
Ambient Air	5/19/2004				0	0	0																	
Ambient Air	5/20/2004				0	0	0																	
Ambient Air	5/21/2004				0	0	0																	
Ambient Air	5/24/2004				0	0	0																	
Ambient Air	5/25/2004																							SYSTEM DOWN FROM 0800-1045
Ambient Air	5/26/2004				0	0	0																	
Ambient Air	5/27/2004																							
Ambient Air	5/28/2004																							SYSTEM DOWN FROM 0800-1020
Ambient Air	6/1/2004																							DO METER REFUSING TO CALIBRATE
Ambient Air	6/2/2004																							SYSTEM DOWN @ 1045 ON 6/7 TILL 6/8 NOON
Ambient Air	6/8/2004																							SYSTEM DOWN @ 1045 ON 6/7 TILL 6/8 NOON
Ambient Air	6/8/2004																							
Ambient Air	6/9/2004																							
Ambient Air	6/12/2004																							
Ambient Air	6/14/2004																							
Ambient Air	6/15/2004																							
Ambient Air	6/16/2004																							
Ambient Air	6/18/2004																							
Ambient Air	6/21/2004																							SYSTEM DOWN @ 0830 FOR END OF TEST
Ambient Air	6/22/2004																							
CO-1	4/7/2004									6.81	10.12	-58.9	3.21	824	170			23.5				27.7	N	
CO-1	5/11/2004									6.4	17.03	332	11.07	801	202	0.05		24.35				27.90	Y	
CO-1	5/18/2004									6.6	16.5	107.1	4.77	1116	25.5	0.05		18.7				27.89	Y	
CO-1	5/25/2004									6.49	14.93	261	5.94	930	22	0.05		23.19				27.91	Y	
CO-1	6/1/2004									6.69	15.71	176	0.69	951	33.5	0		22.67				27.96	Y	
CO-1	6/22/2004									6.7	17.64	88.7	5.35	1685	49.2	0.05		22.74				27.93	Y	
CO-2	4/7/2004									6.85	10.46	-9.8	2.79	576	436			23.39				27.96	N	
CO-2	04/29/04		25																					

Chemical Oxidation (ChemOx) Pilot Test Data

Location	Date	Time	System Parameters							Headspace Parameters										Sampled Y/N	Comments	
			Pressure (PSI)	Flow (GPH)	LEL (PPM)	PID (PPM)	O ₃ (PPM)	CO ₂ (%)	O ₂ (%)	CO (%)	pH	Temp	ORP (mV)	DO (PPM)	Cond (PPM)	Turb (PPM)	% H ₂ O ₂	DTW (ft)	DTP (ft)			TD
CO-2	5/11/2004									6.19	29.03	353	9.9	1388	20	2	23.9		28.10	Y		
CO-2	5/18/2004									8.97	25.7	317.3	9.01	1578	74.9	0.05	24.22		28.36	Y		
CO-2	5/25/2004									3.55	24.77	446	7.03	20.28	0.3	0.3	21.3		28.37	Y		
CO-2	6/1/2004									3.82	29.34	445	1.52	2010	56.4	0.3	20.79		28.39	Y		
CO-2	6/22/2004									4.88	28.74	314	8.47	1540	3.7	0.5	21.59		28.57	Y		
CO-3	4/7/2004									7.12	10.76	-107.4	0.52	846	160		22.37		30.74	N		
CO-3	04/29/04		25																			
CO-3	5/11/2004									6.81	25.45	380	8.58	1097	508	0.05	21.15		31.15	Y		
CO-3	5/18/2004									6.81	19.8	278.9	4.07	907	24.4	0.05	22.46		31.17	Y		
CO-3	5/25/2004									6.64	24.46	290	5.85	810	11	0	21.45		31.13	Y		
CO-3	6/1/2004									6.63	21.13	282	0.59	735	52.6	0.05	20.45		31.15	Y		
CO-3	6/22/2004									6.81	22.95	-57	6.01	428	31.3	0.05	20.57		31.24	Y		
CO-4	4/7/2004									6.87	10.96	-42.3	2.26	597	644		22.27		31.13	N		
CO-4	4/13/2004	15:08	15																			Short term test, day 1/step 1, air/ozone injection at CO-4 at 15 psi, 2.6 scfm
CO-4	4/13/2004	16:58	36																			Short term test, day 1/step 2, air/ozone injection at CO-4 at 36 psi, 5.1 scfm
CO-4	4/13/2004	17:53	60																			Short term test, day 1/step 3, air/ozone injection at CO-4 at 60 psi, 7.6 scfm
CO-4	4/16/2004	12:20	60	4.2																		Short term test, day 3, air/ozone injection at CO-4 and CO-5 at 60 psi, 7.6 scfm and peroxide at 4.2 gph, 5 min cycles
CO-4	4/28/2004	8:35																				START LONG-TERM PILOT TEST, STEP 1 STARTED @ CO-4
CO-4	04/29/04		25																			
CO-4	5/11/2004									6.01	28.2	344	32.35	1037	1212	10	22.1		31.10	Y		
CO-4	5/18/2004									6.96	25.48	314.0	15.1	295	192.7	0.05	21.28		31.22	Y		
CO-4	5/25/2004									6.7	26.07	318	7.69	1056	1200	25	21.3		31.31	Y		
CO-4	6/1/2004									6.96	27.63	301	1.7	1065	313	25	21.42		31.69	Y		
CO-4	6/22/2004									6.81	22.18	-28	3.72	1088	21.3	0.5	21.19		32.75	Y		
CO-5	4/7/2004									7.08	9.76	-14.4	3.75	705	583		22.15		31.2	N		
CO-5	4/16/2004	12:20	60	4.2																		Short term test, day 3, air/ozone injection at CO-4 and CO-5 at 60 psi, 7.6 scfm and peroxide at 4.2 gph, 5 min cycles
CO-5	04/29/04		25																			
CO-5	5/11/2004									6.62	25.03	343	6.01	1166	124	0.5	21.9		32.20	Y		
CO-5	5/18/2004									6.51	20.88	369.0	4.29	1111	64.5	0.3	23.71		31.88	Y		
CO-5	5/25/2004									6.6	20.85	305	3.23	1090	15	0.05	21.2		32.16	Y		
CO-5	6/1/2004									6.66	22.1	294	1.07	1143	5.2	0.05	20.74		32.1	Y		
CO-5	6/22/2004									6.94	28.73	163	5.16	625	144	0.5	20.55		32.27	Y		
LF-1S	4/12/2004				20	11.2	0	12.3	18.7	3												
LF-1S	4/16/2004	12:20	0.11		10.2	73.4	0	17	0	3.2							25.16	25.15				Short term test, day 3, air/ozone injection at CO-4 and CO-5 at 60 psi, 7.6 scfm and peroxide at 4.2 gph, 5 min cycles
LF-1S	4/28/2004																24.71	24.65				START LONG-TERM PILOT TEST, STEP 1 STARTED @ CO-4
LF-1S	04/29/04																24.60	24.51				
LF-1S	05/05/04																24.47	24.40				
LF-1S	5/6/2004																24.62	24.42				

Chemical Oxidation (ChemOx) Pilot Test Data

Location	Date	Time	System Parameters		Headspace Parameters						Groundwater Parameters										Comments	
			Pressure (PSI)	Flow (GPH)	LEL (PPM)	PID (PPM)	O ₃ (PPM)	CO ₂ (%)	O ₂ (%)	CO (%)	pH	Temp	ORP (mV)	DO (PPM)	Cond (PPM)	Turb (PPM)	% H ₂ O ₂	DTW (ft)	DTP (ft)	TD		Sampled Y/N
LF-1S	5/7/2004																	24.73	24.58			
LF-1S	5/10/2004																	24.69	24.60			
LF-1S	5/11/2004																	24.71	24.63	30.70	N	
LF-1S	05/12/04																	24.61	24.51			
LF-1S	05/13/04				12	155	0	13.7	3.3	15								24.79	24.63			
LF-1S	5/17/2004				9	165	0	19.3	0.6	20								24.75	24.50			
LF-1S	5/18/2004																	24.82	24.45	30.71	N	
LF-1S	5/19/2004																	24.88	24.64			
LF-1S	5/20/2004																	24.35	24.35			
LF-1S	5/24/2004																	23.00	23.00			
LF-1S	5/25/2004																	23.95	23.95	30.67	N	
LF-1S	5/26/2004																	23.83	23.83			
LF-1S	5/27/2004																	24.37	24.21			
LF-1S	5/28/2004																	24.05	23.80			
LF-1S	6/1/2004																	23.38	23.37	30.67	N	
LF-1S	6/2/2004																	24.33	23.74			
LF-1S	6/3/2004																	24.75	23.79			
LF-1S	6/4/2004	0:00																25.21	23.91			BAILED 0.25 GALLON
LF-1S	6/8/2004																	25.24	23.91			BAILED 0.5 GALLON
LF-1S	6/8/2004																	24.65	23.73			
LF-1S	6/9/2004																	24.63	23.89			BAILED 1 GALLON
LF-1S	6/12/2004																	26.29	24.10			BAILED 0.5 GALLON
LF-1S	6/14/2004																	24.07	22.98			BAILED 0.5 GALLON
LF-1S	6/15/2004																	24.87	23.76			BAILED 0.75 GALLON
LF-1S	6/16/2004				11	190	0	24.3	0.1	8						0	25.23	24.00			BAILED 0.25 GALLON	
LF-1S	6/18/2004				12	185	0	24.1	0.8	9								24.95	23.62			BAILED 0.75 GALLON
LF-1S	6/21/2004				9	410	0	1.7	31.3	12								24.71	23.59			BAILED 0.5 GALLON
LF-1S	6/22/2004				0	46.1	0	0.1	20	0								24.99	23.07			BAILED 0.4 GALLON
LF-3	4/12/2004				0	3.1	0.004	0	20.9	3												
LF-3	4/16/2004	12:20	0																			Short term test, day 3, air/ozone injection at CO-4 and CO-5 at 60 psi, 7.6 scfm and peroxide at 4.2 gph, 5 min cycles
LF-3	4/28/2004																					START LONG-TERM PILOT TEST, STEP 1 STARTED @ CO-4
LF-3	04/29/04																	24.61	24.60			
LF-3	05/05/04																	23.55	23.55			
LF-3	05/05/04																	23.38	23.38			
LF-3	5/6/2004																	23.50	23.50			
LF-3	5/7/2004																	24.35	24.35			
LF-3	5/10/2004																	22.62	22.62			
LF-3	5/11/2004																	22.80	22.80	36.85	N	
LF-3	05/12/04																	21.64	21.64			
LF-3	05/13/04						0			128								21.45	21.45			
LF-3	5/14/2004																	20.71	20.71			
LF-3	5/17/2004																	20.08	20.08			
LF-3	5/18/2004																	19.97	19.97	36.84	N	
LF-3	5/19/2004																	19.93	19.93			
LF-3	5/20/2004																	19.83	19.83			
LF-3	5/24/2004																	19.19	19.19			
LF-3	5/25/2004																	19.39	19.39	36.84	N	
LF-3	5/26/2004																	19.05	19.05			
LF-3	5/28/2004																	19.01	19.01			
LF-3	6/1/2004																	19.03	19.03	36.8	N	
LF-3	6/2/2004																	19.41				
LF-3	6/3/2004																	19.45				
LF-3	6/4/2004	0:00																19.40				
LF-3	6/8/2004																	19.49	19.49			

Chemical Oxidation (ChemOx) Pilot Test Data

Location	Date	Time	System Parameters		Headspace Parameters					Groundwater Parameters										Comments			
			Pressure (PSI)	Flow (GPH)	LEL (PPM)	PID (PPM)	O ₃ (PPM)	CO ₂ (%)	O ₂ (%)	CO (%)	pH	Temp	ORP (mV)	DO (PPM)	Cond (PPM)	Turb (PPM)	% H ₂ O ₂	DTW (ft)	DTP (ft)		TD	Sampled Y/N	
LF-3	6/9/2004																19.72						
LF-3	6/12/2004																20.09						
LF-3	6/14/2004																19.62	19.62					
LF-3	6/15/2004																19.37	19.37					
LF-3	6/16/2004																19.40	19.4					
LF-3	6/18/2004																19.70	19.7					
LF-3	6/21/2004																19.66	19.66					
LF-3	6/22/2004																19.97	19.97		N			
LF-5	4/28/2004																26.03					START LONG-TERM PILOT TEST, STEP 1 STARTED @ CO-4	
LF-6	4/7/2004																26.65	26.54	39.9	N			
LF-6	4/12/2004				50	32.8	0	4.2	13.4	1													
LF-6	4/16/2004	12:20	0.48		19.5	125	0	3.8	19.4	33							25.02					Short term test, day 3, air/ozone injection at CO-4 and CO-5 at 60 psi, 7.6 scfm and peroxide at 4.2 gph, 5 min cycles	
LF-6	4/28/2004	0:00			9	95	0	7.2	22.4	97					0.05	28.20	26.44					START LONG-TERM PILOT TEST, STEP 1 STARTED @ CO-4	
LF-6	04/29/04		0.05		5	146	0	4.8	30.1	105						28.24	26.10						
LF-6	05/05/04															28.03	25.99						
LF-6	5/6/2004		0.05		6		0	5	18.7	30					0	28.90	26.00						
LF-6	5/7/2004		0.06		0	130	0	3.7	37.7	53					0	29.38	26.03						
LF-6	5/10/2004		0.09		5	160	0	3.1	43.2	25						29.55	26.81					TOO MUCH PRODUCT TO GET GOOD READING	
LF-6	5/11/2004		0.17		5	150	0	3.7	42.3	21						29.85	26.02	39.86	N				
LF-6	05/12/04		0.13		0	220	0	2.8	43.9	18						27.34	26.38					BAILED 3.5 GALLONS PRIOR TO GAUGING; TOO MUCH PRODUCT TO GET GOOD H2O2 READING	
LF-6	05/13/04		0.3		0	168	0	2.7	45.5	27						28.22	26.37						
LF-6	5/14/2004		0.24		1	235	0	2.6	43.7	32				0.05	27.14	26.53						BAILED 0.75 GALLON	
LF-6	5/17/2004		0.23		1	155	0	2.8	48.7	35				0.05	28.31	26.35							
LF-6	5/18/2004				0		0	2.6	48.7	28						27.10	26.26	39.85	N				
LF-6	5/19/2004		0.21		0	200	0	2.7	46.4	20				0.05	27.85	26.30						BAILED 1.5 GALLONS	
LF-6	5/20/2004		0.31		0	174	0	2.6	46.5	22				0.05	26.65	26.13						BAILED 0.5 GALLON	
LF-6	5/21/2004		0.3		0.5	194	0	2.5	49.1	27				0.05	27.10	26.15						BAILED 1 GALLON	
LF-6	5/24/2004		0.2		0	198	0	2.6	48.7	26				0.05	25.53	24.56						BAILED 0.75 GALLON	
LF-6	5/25/2004		0.19		0	222	0	3.1	32.6	11				0	26.25	25.62	39.86	N				BAILED 0.5 GALLON	
LF-6	5/26/2004		0.2		0	170	0	2.8	45.6	17				0.3	25.96	25.26						BAILED 0.75 GALLON	
LF-6	5/27/2004				0	164.4	0	2.8	50.6	20				0.05	26.20	25.87						BAILED 0.75 GALLON	
LF-6	5/28/2004				0	169	0	2.8	53.4	18				0.05	25.60	25.49						BAILED 0.35 GALLON	
LF-6	6/1/2004		0.2		0	170	0	2.9	54.3	2					24.96	24.60	39.9	N				BAILED 0.25 GALLON	
LF-6	6/2/2004		0.25		0	170.1	0	2.8	46.4	14					25.22	25.11						BAILED 0.2 GALLON	
LF-6	6/3/2004	0:00	0.06		0	196.2		2.9	31.5	16					25.39	25.18						BAILED 0.25 GALLON	
LF-6	6/4/2004	0:00	0.12		0	179.5	0	3	47	12					25.68	25.50						BAILED 0.25 GALLON	
LF-6	6/8/2004														25.47	25.25						BAILED 0.1 GALLON	
LF-6	6/8/2004		0.07		0	205	2	4.8	27.3	4				0	25.18	24.96							
LF-6	6/9/2004		0.08		0	183		3.3	42.3	10					25.23	25.22							
LF-6	6/12/2004		0.08		0	201.2		2.8	29.5	20					26.01	25.55						BAILED 0.25 GALLON	
LF-6	6/14/2004		0.28		0	200	0	3	33.2	14					25.82	25.43						BAILED 0.25 GALLON	
LF-6	6/15/2004		0.07		0	180	0	2.5	59.3	10					25.50	25.18						BAILED 0.5 GALLON	
LF-6	6/16/2004		0.25		0	175	0	2.6	51.3	12				0.05	25.56	25.37						BAILED 0.1 GALLON	
LF-6	6/18/2004		0.18		0	180	0	2.7	49.2	10					25.27	25.10						BAILED 0.1 GALLON	
LF-6	6/21/2004		0.21		0	150	0	2.7	53.9	9				0	25.11	25.00							
LF-6	6/22/2004				0	210	0	0.2	23.9	2					25.43	25.24	39.8	N					
MW-28	4/7/2004														28.80	27.67	33	N					
MW-28	4/12/2004				0	11.2	0	5.2	16.7	0													

Chemical Oxidation (ChemOx) Pilot Test Data

Location	Date	Time	System Parameters			Headspace Parameters					Groundwater Parameters										Comments
			Pressure (PSI)	Flow (GPH)	LEL (PPM)	PID (PPM)	O ₃ (PPM)	CO ₂ (%)	O ₂ (%)	CO (%)	pH	Temp	ORP (mV)	DO (PPM)	Cond (PPM)	Turb (PPM)	% H ₂ O ₂	DTW (ft)	DTP (ft)	TD	
MW-28	4/16/2004	12:20	0		0	48	0	0	20.9	7							30.13	27.97			Short term test, day 3, air/ozone injection at CO-4 and CO-5 at 60 psi, 7.6 scfm and peroxide at 4.2 gph, 5 min cycles
MW-28	4/28/2004																30.86	27.50			START LONG-TERM PILOT TEST, STEP 1 STARTED @ CO-4
MW-28	04/29/04																				
MW-28	05/05/04																				DTP 2.50 IN DRUM
MW-28	5/6/2004																				DTP 2.49 IN DRUM
MW-28	5/7/2004																				DTP 2.42 IN DRUM
MW-28	5/10/2004																				DTP 2.25 IN DRUM
MW-28	5/11/2004																27.73	27.70	33.02	N	
MW-28	05/12/04																				DTP 2.18 IN DRUM
MW-28	05/13/04							0													DTP 2.14 IN DRUM
MW-28	5/14/2004																				DTP 2.08 IN DRUM
MW-28	5/17/2004																				DTP 1.96 IN DRUM
MW-28	5/18/2004																27.58	27.56	33.00	N	
MW-28	5/19/2004																				DTP 1.9 IN DRUM
MW-28	5/20/2004																				DTP 1.82 IN DRUM
MW-28	5/21/2004																				DTP 1.78 IN DRUM
MW-28	5/24/2004																				DTP 1.71 IN DRUM
MW-28	5/25/2004																			N	DTP 1.7 IN DRUM
MW-28	5/26/2004																				DTP 1.68 IN DRUM
MW-28	5/27/2004																				DTP 1.65 IN DRUM
MW-28	5/28/2004																				DTP 1.64 IN DRUM
MW-28	6/1/2004																			N	DTP 1.56 IN DRUM
MW-28	6/2/2004																				DTP 1.52 IN DRUM
MW-28	6/3/2004																				DTP 1.48 IN DRUM
MW-28	6/4/2004																				DTP 1.44 IN DRUM
MW-28	6/8/2004																				DTP 1.43 IN DRUM
MW-28	6/9/2004																				DTP 1.36 IN DRUM
MW-28	6/12/2004																				DTP 1.25 IN DRUM
MW-28	6/14/2004																				DTP 1.24 IN DRUM
MW-28	6/15/2004																				DTP 1.24 IN DRUM
MW-28	6/16/2004																				DTP 1.22 IN DRUM
MW-28	6/18/2004																				DTP 1.19 IN DRUM
MW-28	6/21/2004																				DTP 1.16 IN DRUM
MW-28	6/22/2004																				DTP 1.16 IN DRUM
MW-3URS	4/7/2004										6.95	11.51	-83.7	16	791	97.4	27.65		34.7	N	
MW-3URS	4/12/2004				6	4.9	0	0.1	20.3	0											
MW-3URS	4/16/2004	12:20	0.82				108	0	16	1							28.37				Short term test, day 3, air/ozone injection at CO-4 and CO-5 at 60 psi, 7.6 scfm and peroxide at 4.2 gph, 5 min cycles
MW-3URS	4/16/2004	14:56									6.53	16.35	21.1	2.02	89.9	1043	0.05				Short term test, day 3, final groundwater round
MW-3URS	4/28/2004																27.94				START LONG-TERM PILOT TEST, STEP 1 STARTED @ CO-4
MW-3URS	04/29/04																27.69				
MW-3URS	05/05/04																27.60				
MW-3URS	5/6/2004																27.72				
MW-3URS	5/7/2004																27.73				
MW-3URS	5/10/2004																27.69				
MW-3URS	5/11/2004																27.62		33.97	Y	
MW-3URS	05/12/04																27.79				
MW-3URS	05/13/04							0									27.70				
MW-3URS	5/14/2004																27.81				

Chemical Oxidation (ChemOx) Pilot Test Data

Location	Date	Time	System Parameters		Headspace Parameters					Groundwater Parameters										Comments								
			Pressure (PSI)	Flow (GPH)	LEL (PPM)	PID (PPM)	O ₃ (PPM)	CO ₂ (%)	O ₂ (%)	CO (%)	pH	Temp	ORP (mV)	DO (PPM)	Cond (PPM)	Turb (PPM)	% H ₂ O ₂	DTW (ft)	DTP (ft)		TD	Sampled Y/N						
MW-3URS	5/17/2004																						27.69					
MW-3URS	5/18/2004										6.5	14.74	82	2.71	1037	25.8	0.05	27.65							34.25	Y		
MW-3URS	5/19/2004																											
MW-3URS	5/20/2004																											
MW-3URS	5/21/2004																											
MW-3URS	5/24/2004																											
MW-3URS	5/25/2004																											
MW-3URS	5/26/2004																											
MW-3URS	5/27/2004																											
MW-3URS	5/28/2004																											
MW-3URS	6/1/2004																											
MW-3URS	6/2/2004																											
MW-3URS	6/3/2004																											
MW-3URS	6/4/2004	0:00																										
MW-3URS	6/8/2004																											
MW-3URS	6/9/2004																											
MW-3URS	6/12/2004																											
MW-3URS	6/14/2004																											
MW-3URS	6/15/2004																											
MW-3URS	6/16/2004																											
MW-3URS	6/21/2004																											
MW-3URS	6/22/2004																											
RW-8R	4/28/2004																											
RW-8R	5/18/2004																											
RW-8R	5/25/2004																											
RW-8R	6/1/2004																											
RW-8R	6/22/2004																											
VERMW-1	4/7/2004										6.89	10.61	-44	3.49	764	111												
VERMW-1	4/12/2004					0	2.6	0	1.8	10.4	2																	
VERMW-1	4/13/2004	15:08	0.03					0																				
VERMW-1	4/13/2004	16:58	0.03																									
VERMW-1	4/13/2004	17:53	0.05																									
VERMW-1	4/15/2004	16:03																										
VERMW-1	4/16/2004	12:20	0.42			4	76	0	3.2	24.4	42																	
VERMW-1	4/16/2004	14:56										6.49	14.78	71.1	6.69	90	126.8	1										
VERMW-1	4/28/2004					5	73	0	4.3	25.3	107	6.36	11.83	336	8.61	968	98.7	0.05										
VERMW-1	04/29/04		0.09			3	78	0	3.6	40.2	137	6.69	13.94	173	17.28	1011	9.3	0										
VERMW-1	05/05/04																											
VERMW-1	5/6/2004		0			1		0	8.1	1.6	1	6.47	13.52	13	1.34	1016	36.4	0										
VERMW-1	5/7/2004		0.02			4	62	0	8.3	34.2	236	6.71	13.54	63	2.4	1020	33.7	0										
VERMW-1	5/10/2004		0.03			6	98	0	9.1	42	103	6.51	14.42	115	2.87	983	19.5	0										
VERMW-1	5/11/2004		0.03			11	126.3	0	7.7	39.4	57	6.43	14.39	158	14.7	1178	18.5	0										
VERMW-1	05/12/04		0.01			2	105	0	8.4	47.6	69	6.48	14.16	120	6.44	927	45	0.05										
VERMW-1	05/13/04		0.03			0	98	0	8.3	45.7	61	6.2	14.81	103	5.84	934	88	0										
VERMW-1	5/14/2004		0.02			2	93	0	8.9	45.4	53	6.39	14.41	36	4.16	928	28.5	0										
VERMW-1	5/17/2004		0.025			0	98	0	10.2	37	28	6.4	13.96	23.6	2.99	909	5.8	0.05										
VERMW-1	5/18/2004					0		0	10.5	39.6	28	6.42	13.75	229.0	8.11	1125	2.9	0.05										

Chemical Oxidation (ChemOx) Pilot Test Data

Location	Date	Time	System Parameters		Headspace Parameters						Groundwater Parameters										Comments	
			Pressure (PSI)	Flow (GPH)	LEL (PPM)	PID (PPM)	O ₃ (PPM)	CO ₂ (%)	O ₂ (%)	CO (%)	pH	Temp	ORP (mV)	DO (PPM)	Cond (PPM)	Turb (PPM)	% H ₂ O ₂	DTW (ft)	DTP (ft)	TD		Sampled Y/N
VERMW-1	5/19/2004		0.03		0	95	0	10.5	44.9	28	6.55	13.98	77	8.32	871	5.9	0.05	23.10				
VERMW-1	5/20/2004		0.03		0	137	0	4	47.8	28	6.45	14.03	19.8	2.7	875	2.1	0	22.43				
VERMW-1	5/21/2004		0		1	97	0	8.1	40.9	19	6.44	14.25	19.4	3.67	875	0.9	0					
VERMW-1	5/24/2004		0.005		0	95	0	8.3	41.6	18	6.5	14.06	20.8	2.98	890	5.7	0	19.60				
VERMW-1	5/25/2004		0.005		0	7.9	0	8.6	35.6	3	6.35	14.04	250	2.06	1045	4	0.05	19.74		36.45	Y	
VERMW-1	5/26/2004		0		0	32	0	6.5	30.1	2	6.44	14.01	66.4	2.49	980	4.2	0	19.78				
VERMW-1	5/27/2004				0	10.7	0	2.1	23.9	3	6.41	14.62	13.2	1.47	995	0	0					
VERMW-1	5/28/2004				0	12.1	0	2.2	24.1	2	6.48	14.7	14.7	1.5	997	1.3	0	20.09				
VERMW-1	6/1/2004		0.01		0	11.4	0	2.2	24	3	6.45	14.6	195	0.11	1043	0	0.05	19.78		36.4	Y	
VERMW-1	6/2/2004		0		0	6.4	0	0.5	21.6	3	6.35	15.4	200.7	6.76	1233	5.1	0.05	20.31				
VERMW-1	6/3/2004	0:00	0		0	10.9		11.4	36.5	1	6.48	15.6	-129.2	1.65	1223	0	0.05	20.20				
VERMW-1	6/4/2004	0:00	0		0	5.1	0	1.1	22.9	1	6.32	13.39	33.8	2.83	1198	5	0.05	20.54				
VERMW-1	6/8/2004		0.05		0	9.8	0	10.2	34.1	2	6.32	15.29	-190	1.07	953	0	0	20.79				
VERMW-1	6/9/2004		0		0	4.3		10.3	30.1	2	6.24	16.44	-159	3.23	1146	2.1		20.58				
VERMW-1	6/12/2004		0		0	6.4		12	34.4	2	6.38	15.71	-199.9	0.83	1149	0	0.05	20.56				
VERMW-1	6/14/2004		0		0	7.1	0	12.1	34.7	2	6.4	14.81	-140	1.05	929	0	0	20.40				
VERMW-1	6/15/2004		0		0	6.4	0	11.9	32.9	1							20.54					
VERMW-1	6/16/2004		0.01		0	5.2	0	11.2	33.3	0	6.55	15.18	-84.2	1.54	945	4.7	0	20.95				
VERMW-1	6/18/2004		0		0	4.8	0	11.3	36.4	1	6.55	15.3	-81.4	1.49	896	3.2	0	19.92				
VERMW-1	6/21/2004		0		0	3.4	0	7.3	30.8	0	6.47	15.27	-85.3	1.53	850	1.7	0	20.44				
VERMW-1	6/22/2004				1	0.2	0	0.7	21.9	1	6.55	15.65	-94.8	5.04	1206	780	0.05	19.95		36.2	Y	
VERMW-2	4/7/2004										6.74	11.19	-48	2.45	751	192		26.85		37.33	N	
VERMW-2	4/12/2004				0	0.9	0	8.7	15.7	2												
VERMW-2	4/13/2004	15:08	0.12				0							11.45								Short term test, day 1/step 1, air/ozone injection at CO-4 at 15 psi, 2.6 scfm
VERMW-2	4/13/2004	16:58	0.22											10.43								Short term test, day 1/step 2, air/ozone injection at CO-4 at 36 psi, 5.1 scfm
VERMW-2	4/13/2004	17:53	0.4											10.48				25.20				Short term test, day 1/step 3, air/ozone injection at CO-4 at 60 psi, 7.6 scfm
VERMW-2	4/15/2004	16:03												3.81		0						Short Term Test, day 2, peroxide injection at multiple wells
VERMW-2	4/16/2004	12:20	1.5		14	100	0	4.1	8.5	51								26.49				Short term test, day 3, air/ozone injection at CO-4 and CO-5 at 60 psi, 7.6 scfm and peroxide at 4.2 gph, 5 min cycles
VERMW-2	4/16/2004	14:56									6.48	16.23	122.9	5.99	57.9	1255	0.5					Short term test, day 3, final groundwater round
VERMW-2	4/28/2004	0:00			12	90	0	4.4	28.3	85	6.65	12.12	220	11.40	812	22	0.05	25.76				START LONG-TERM PILOT TEST, STEP 1 STARTED @ CO-4, VERY SLIGHT SHEEN PRESENT
VERMW-2	04/29/04		0.16		5	74.5	0	3.8	30.1	85	6.67	14.13	139	6.37	860	19	0	25.40				
VERMW-2	5/6/2004		0.01		0		0	0	19.1	3							0	22.49	22.49			
VERMW-2	5/7/2004		0.03		-1	0.5	0	0	19.2	5							0.05	22.63	22.62			
VERMW-2	5/10/2004		0.02		1	8.7	0	9.1	24.2	1	6.59	14.25	153	7.87	753	257	0	21.54				NO SHEEN OR PRODUCT PRESENT
VERMW-2	5/11/2004		0.01		4	93	0	3.5	27.5	8	6.35	15.22	142	10.18	766	118	0	22.84		36.65	Y	
VERMW-2	05/12/04		0.01		0	65	0	6.6	31.6	1	6.45	14.21	110	8.16	747	171	0	23.27				
VERMW-2	05/13/04		0.01		0	54	0	6.9	33.5	2	6.14	14.87	89	4.57	757	34		22.82				
VERMW-2	5/14/2004		0.01		0	33	0	7.4	32.7	3	6.31	14.7	81	4.83	766	18.1	0.05					
VERMW-2	5/17/2004		0.01		0	33	0	5.1	30.2	0	6.36	13.97	85.7	5.5	800	2.3	0.05	24.32				
VERMW-2	5/18/2004				0		0	8.2	35.5	1	6.4	13.81	225.0	6.38	1011	81.6	0.05	22.37		36.29	Y	
VERMW-2	5/19/2004		0.01		0	32	0	7.4	34.7	2	6.56	12.97	93	7.45	758	35	0.05	24.48				
VERMW-2	5/20/2004		0.01		0	88	0	3.6	33.3	5	6.37	13.55	147	2.83	998	31.4	0.05	22.05				
VERMW-2	5/21/2004		0.005		0	13	0	8.2	39.4	3	6.45	13.59	72	7.09	760	6.5	0.05					
VERMW-2	5/24/2004		0.01		0	15	0	8.1	39.4	4	6.54	13.87	15.2	6.8	795	73	0.05	20.77				
VERMW-2	5/25/2004		0		0	1.8	0	6.8	34	4	6.41	12.45	178	7.06	868	5.7	0.05	21.05		36.08	Y	
VERMW-2	5/26/2004		0		0	3.6	0	8.7	39.6	3	6.54	12.5	128.4	6.1	951	50	0	21.07				
VERMW-2	5/27/2004				0	4	0	9.2	40.6	2	6.48	13.77	82.7	3.42	861	2.9	0.05	21.35				

Chemical Oxidation (ChemOx) Pilot Test Data

Location	Date	Time	System Parameters		Headspace Parameters						Groundwater Parameters										Comments	
			Pressure (PSI)	Flow (GPH)	LEL (PPM)	PID (PPM)	O ₃ (PPM)	CO ₂ (%)	O ₂ (%)	CO (%)	pH	Temp	ORP (mV)	DO (PPM)	Cond (PPM)	Turb (PPM)	% H ₂ O ₂	DTW (ft)	DTP (ft)	TD		Sampled Y/N
VERMW-2	5/28/2004				0	3.7	0	8.9	41.2	2	6.5	13.81	92.3	3.21	853	3.3	0.05	21.03				
VERMW-2	6/1/2004		0		0	3.6	0	9	42.6	2	6.68	13.04	46.5	0.58	1081	1.8	0.05	20.74		35.96	Y	
VERMW-2	6/2/2004		0.02		0	5.1	0	4.3	29.4	2	6.52	13.88	106.1	13.14	1045	4.5	0.05	21.23				
VERMW-2	6/3/2004	0:00	0		0	1.8		9.5	41.6	2	6.54	12.5	-136.5	9.05	1014	8.3	0.05	21.46				
VERMW-2	6/4/2004	0:00	0		0	1.4	0	5.8	33.8	0	6.45	12.29	-160.9	1.19	981	0	0.3	21.65				
VERMW-2	6/8/2004		0.01		0	41.7	0	6.5	27	2	6.39	14.26	-161	2.14	700	0	0	21.06				
VERMW-2	6/9/2004		0		0	7.3		8.8	37.9	4	6.33	16.34	-137	3.68	900	0		21.49				
VERMW-2	6/12/2004		0		0	4.8		7	34.5	1	6.53	17.03	-168.5	6.44	879	19.3	0.05	21.31				
VERMW-2	6/14/2004		0.01		0	4.9	0	6.9	35.5	0	6.43	14.29	-133	2.54	699	1.8	0.05	21.14				
VERMW-2	6/15/2004		0.01		0	2	0	8.1	36.6	2							21.79					
VERMW-2	6/16/2004		0.01		0	1.1	0	8.1	36.3	2	6.59	15.5	-80.2	2.1	725	0.4	0.05	21.64				
VERMW-2	6/18/2004		0.02		0	2	0	8.1	35.7	1	6.61	15.62	-79.4	2.18	750	0.8	0.05	20.76				
VERMW-2	6/21/2004		0.005		0	1.2	0	6.8	35.8	3	6.52	15.49	-71.7	223	782	0	0.05	20.91				
VERMW-2	6/22/2004				0	0	0	0.9	23.2	2	6.6	14.92	-100	4.85	726	1.6	0.05	21.08		35.55	Y	
VERMW-3	4/7/2004										6.89	10.90	-83	3.54	675	288		27.21		37.2	N	
VERMW-3	4/12/2004				0	0.2	0	9.2	20.9	1												
VERMW-3	4/13/2004	15:08	0.03				0							3.66								Short term test, day 1/step 1, air/ozone injection at CO-4 at 15 psi, 2.6 scfm
VERMW-3	4/13/2004	16:58	0.07											6.43								Short term test, day 1/step 2, air/ozone injection at CO-4 at 36 psi, 5.1 scfm
VERMW-3	4/13/2004	17:53	0.09											5.27				27.80				Short term test, day 1/step 3, air/ozone injection at CO-4 at 60 psi, 7.6 scfm
VERMW-3	4/15/2004	16:03												4.17			0					Short Term Test, day 2, peroxide injection at multiple wells
VERMW-3	4/15/2004	16:03															2					Short Term Test, day 2, peroxide injection at multiple wells. Product sample collected was bubbling/fizzing
VERMW-3	4/16/2004	12:20	0.32		8	150	0	4	20.6	145								27.67				Short term test, day 3, air/ozone injection at CO-4 and CO-5 at 60 psi, 7.6 scfm and peroxide at 4.2 gph, 5 min cycles
VERMW-3	4/16/2004	14:56									6.66	15.35	-7.7	2.49	531.3	1014	0.3					Short term test, day 3, final groundwater round
VERMW-3	4/28/2004	0:00			7	150	0	5.0	27.9	196	6.60	11.90	220	7.85	692	113	0	27.24				START LONG-TERM PILOT TEST, STEP 1 STARTED @ CO-4, VERY SLIGHT SHEEN PRESENT
VERMW-3	04/29/04		0.01		3	176.2	0	3.4	23.0	56							0.05	28.21	26.92			PRODUCT PRESENT
VERMW-3	5/1/2004																					VERMW-3 product approx 1.25' thick black product, 0.25' of corklike product, 0.25' of foam-like product
VERMW-3	05/05/04																	27.77	26.74			
VERMW-3	5/6/2004		0.02		7		0	4.3	24.3	63							0	29.55	26.00			
VERMW-3	5/7/2004		0.03		0	153	0	1.8	27.7	37							0	29.63	26.54			
VERMW-3	5/10/2004		0.01		2	230	0	2.2	29.5	23								29.85	26.36			TOO MUCH PRODUCT TO GET GOOD H2O2 READING
VERMW-3	5/11/2004		0.04		4	225	0	1.6	27.4	28								30.15	26.81	37.08	N	
VERMW-3	05/12/04		0.01		0	230	0	2.2	32.0	17								28.30	26.90			BAILED 2 GALLONS PRIOR TO GAUGING; TOO MUCH PRODUCT TO GET GOOD H2O2 READING
VERMW-3	05/13/04		0.04		0	250	0	1.7	30.7	24								29.15	26.80			
VERMW-3	5/14/2004		0.015		0	260	0	1.9	32.3	20							0	29.48	26.91			BAILED 0.75 GALLONS
VERMW-3	5/17/2004		0.015		0	220	0	1.7	30.8	23							0.05	29.01	25.15			
VERMW-3	5/18/2004				0		0	2.5	34.3	13								29.80	26.58	37.08	N	
VERMW-3	5/19/2004				0	216	0	2.7	38.0	19							0.05	29.15	25.70			BAILED 1 GALLON
VERMW-3	5/20/2004		0.055		0	223	0	2.2	39.4	19							0.05	28.80	26.11			BAILED 0.5 GALLON
VERMW-3	5/21/2004		0.08		0	228	0	2	32.8	18							0.05	29.05	26.25			BAILED 0.5 GALLON

Chemical Oxidation (ChemOx) Pilot Test Data

Location	Date	Time	System Parameters		Headspace Parameters						Groundwater Parameters										Comments
			Pressure (PSI)	Flow (GPH)	LEL (PPM)	PID (PPM)	O ₃ (PPM)	CO ₂ (%)	O ₂ (%)	CO (%)	pH	Temp	ORP (mV)	DO (PPM)	Cond (PPM)	Turb (PPM)	% H ₂ O ₂	DTW (ft)	DTP (ft)	TD	
VERMW-3	5/24/2004		0.06		0	225	0	2.1	33.7	17						0.05	29.20	24.93			BAILED 1 GALLON (EMULSIFIED APPEARANCE)
VERMW-3	5/25/2004		0.06		0	220	0	1.8	37.6	13						0.3	29.74	26.00	36.94	N	BAILED 1 GALLON
VERMW-3	5/26/2004		0		0	180	0	2	39.0	19						0.05	29.38	25.90			BAILED 1 GALLON
VERMW-3	5/27/2004				0	224.1	0	1.7	30.7	19						0.05	21.85	21.85			BAILED 1 GALLON
VERMW-3	5/28/2004				0	217	0	1.5	31.3	18						0	28.58	25.99			BAILED 2 GALLONS
VERMW-3	6/1/2004		0.07		0	235.4	0	1.8	33.4	17							29.97	25.38	36.75	N	BAILED 1.5 GALLONS
VERMW-3	6/2/2004		0.05		0	211.1	0	1.6	30.7	16							29.95	26.01			BAILED 3 GALLONS
VERMW-3	6/3/2004	0:00	0.01		0	203.7		2.4	28.6	12							29.74	26.00			BAILED 1 GALLON
VERMW-3	6/4/2004	0:00	0.03		0	152.1	0	2.1	40.2	13							29.40	23.61			BAILED 1 GALLON
VERMW-3	6/8/2004																29.40	25.3			BAILED 1 GALLON OF MIXED PRODUCT/WATER
VERMW-3	6/8/2004		0.03		0	185	0	1.9	47.4	50						0	26.01	25.70			
VERMW-3	6/9/2004		0.03		0	206.2		2	38.2	2							29.29	25.98			BAILED 2 GALLONS
VERMW-3	6/12/2004		0.015		2	331		1.6	29.9	16							30.02	25.01			BAILED 1.5 GALLONS
VERMW-3	6/14/2004		0.04		0	220	0	1.4	32.6	15							29.20	25.50			BAILED 1 GALLON
VERMW-3	6/15/2004		0.06		0	200	0	1.8	38.9	12							29.12	25.40			BAILED 2.5 GALLONS
VERMW-3	6/16/2004		0.03		0	197	0	1.9	39.3	14					0.05		29.18	25.36			BAILED 1 GALLON
VERMW-3	6/18/2004		0.01		0	201	0	2	40.7	12							29.57	25.97			BAILED 2 GALLONS
VERMW-3	6/21/2004		0.08		0	190	0	1.7	31.3	12					0.05		29.20	25.91			BAILED 2 GALLONS
VERMW-3	6/22/2004				0	102.8	0	0	20.2	1							29.10	26.03		N	BAILED 1 GALLON
VERMW-4	4/7/2004																26.56	25.89	37.75	N	
VERMW-4	4/12/2004				0	4.3	0	9.3	7.4	1											
VERMW-4	4/16/2004	12:20	0.14		10	101	0	3.7	21.1	1187							26.46				Short term test, day 3, air/ozone injection at CO-4 and CO-5 at 60 psi, 7.6 scfm and peroxide at 4.2 gph, 5 min cycles
VERMW-4	4/16/2004	14:56														1					Short term test, day 3, final groundwater round
VERMW-4	4/28/2004	0:00			9	95	0	5.4	46.9	352					0.05	25.84	25.82				
VERMW-4	04/29/04		0.24		2	129	0	2.1	47.0	127					0.05	26.50	25.50				DTP AND DTW ARE ESTIMATES DUE TO BUBBLING
VERMW-4	5/1/2004																				VERMW-4 product approx 0.25" thick, appears corklike
VERMW-4	05/05/04																25.35	24.96			
VERMW-4	5/6/2004		0.4		3		0	2	29.9	88					0.05	24.75	24.70				
VERMW-4	5/7/2004		0.19		0	95	0	1.9	52.3	50					0.3	23.70	23.45				
VERMW-4	5/10/2004		0.14		3	115	0	2.1	45.9	38					0.03	24.21	24.21				
VERMW-4	5/11/2004		0.06		1	115	0	1.7	42.6	21					0.05	25.34	25.38	37.61	N		
VERMW-4	05/12/04		0.12		0	110	0	2.2	53.5	34					0.05	23.86	23.85				
VERMW-4	05/13/04		0.06		0	105	0	2.4	63.4	23						23.99	23.99				
VERMW-4	5/14/2004		0.03		0	101	0	2.7	62.4	23					0.05	23.74	23.73				
VERMW-4	5/17/2004		0.04		0	105	0	4.2	50.0	29					0.05	23.20	23.18				
VERMW-4	5/18/2004				0		0	4.5	61.9	12						23.02	22.95		N		
VERMW-4	5/19/2004		0.02		0	123	0	4.5	61.8	12					0.05	22.79	22.76				
VERMW-4	5/20/2004		0.015		0	98	0	3.5	61.2	17					0.05	22.60	22.56				
VERMW-4	5/21/2004		0.04		0	115	0	3.2	63.3	18					0.05	22.97	22.95				
VERMW-4	5/24/2004		0.05		0	120	0	5.2	67.4	14					0.05	21.20	21.19				
VERMW-4	5/25/2004		0.03		0	102	0	3.2	48.6	21					0.05	22.36	22.35	32.65	N		
VERMW-4	5/26/2004		0.02		0	104	0	3	55.3	11					0.05	21.50	21.49				
VERMW-4	5/27/2004				0	112.2	0	3.1	61.3	9					0.05	29.45	26.00				
VERMW-4	5/28/2004				0	115	0	3	62.4	8					0.05	21.42	21.41				
VERMW-4	6/1/2004		0.03		0	115	0	3.7	62.0	8						20.90	20.90	37.58	N		
VERMW-4	6/2/2004		0.03		0	103.7	0	3.3	57.1	2						20.50					
VERMW-4	6/3/2004	0:00	0.03		0	117.2		3.5	42.3	5						20.61	20.48				
VERMW-4	6/4/2004	0:00	0		0	95.4	0	3.4	57.9	4						20.54					
VERMW-4	6/8/2004															20.48	20.48				

Chemical Oxidation (ChemOx) Pilot Test Data

			System Parameters		Headspace Parameters						Groundwater Parameters										Comments	
Location	Date	Time	Pressure (PSI)	Flow (GPH)	LEL (PPM)	PID (PPM)	O ₃ (PPM)	CO ₂ (%)	O ₂ (%)	CO (%)	pH	Temp	ORP (mV)	DO (PPM)	Cond (PPM)	Turb (PPM)	% H ₂ O ₂	DTW (ft)	DTP (ft)	TD		Sampled Y/N
VERMW-4	6/8/2004		0		0	44.7	0	0	20.9	3							0.05	20.23	20.23			
VERMW-4	6/9/2004		0.02		0	99.2		9.1	60.2	1								20.42				
VERMW-4	6/12/2004		0.02		0	121.2		2.7	36.5	5								20.39				
VERMW-4	6/14/2004		0.07		0	110	0	2.8	37.4	2								20.27	20.27			
VERMW-4	6/15/2004		0.16		0	85	0	2.9	61.7	1								20.47	20.47			
VERMW-4	6/16/2004		0.02		0	85	0	3	61.7	0							0.05	20.23				
VERMW-4	6/18/2004		0.04		0	82	0	3.3	62.9	1								20.14	20.14			
VERMW-4	6/21/2004		0.03		0	85	0	1.8	47.3	1							0.05	20.12	20.12			
VERMW-4	6/22/2004				0	40.1	0	0.1	22	0								20.3		36.67	Y	

Material Safety Data Sheets

PRODUCT INFORMATION

20%-40% hydrogen peroxide concentration
material safety data sheet
cas no. 7722-84-1

U.S. / Canada Version - Effective July 1, 1996
WWW Replication - Effective June 4, 1997

1. Chemical Product / Company Identification

Product name...	Durox (TM) REG & LR 35% Hybrite (R) 32.5% OxyPure (R) 35% Semiconductor, REG & SEG 31% Standard 27.5 & 35% Super D (R) 25 & 35% Technical 35% Chlorate Grade 20%	
Synonyms...	Hydrogen peroxide solutions 20 to 40%	
Information provided by...	FMC Corporation Peroxygen Chemical Division 1735 Market Street Philadelphia, PA 19103 (215) 299-6000	FMC of Canada Ltd. Peroxygen Chemical Division PG Pulp Mill Road Prince George, BC Y2N2S6 (604) 561-4200
Emergency phone numbers...	Chemtrec Medical Plant/Other	(800) 424-9300 (303) 595-9048 call collect (609) 924-6677 call collect in U.S. (613) 996-6666 CANUTEC

2. Composition / Information on Ingredients

CAS # and Components...

Material / Component	Hydrogen Peroxide	Water
Percent	20 to 40%	60 to 80%
CAS #	7722-84-1	7732-18-5

3. Hazard Identification

Emergency Overview...

Oxidizer. Contact with combustibles may cause fire. Decomposes yielding oxygen that supports combustion of organic matters and can cause overpressure if confined.

Health Effects...

Corrosive to eyes, nose, throat and lungs. May cause irreversible tissue damage to the eyes including blindness. May cause skin irritation.

4. First Aid Measures

Eyes...

Immediately flush with large amounts of water for at least 15 minutes, lifting upper and lower lids intermittently. See a physician or ophthalmologist.

Skin...

Wash with large amounts of water. If irritation persists, see a physician.

Inhalation...

Remove to fresh air. If breathing difficulty or discomfort occurs, call a physician.

Ingestion...

If swallowed, drink plenty of water immediately to dilute. Do not induce vomiting or give anything by mouth to an unconscious person. See a physician.

Notes to Physician...

Hydrogen peroxide at these concentrations is a strong oxidant. Direct contact with the eye is likely to cause corneal damage especially if not washed immediately. Careful ophthalmologic evaluation is recommended and the possibility of local corticosteroid therapy should be considered. Because of the likelihood of corrosive effects on the gastrointestinal tract after ingestion and the unlikelihood of systemic effects, attempts at evacuating the stomach via emesis induction or gastric lavage should be avoided. There is remote possibility, however, that a nasogastric or orogastric tube may be required for the reduction of severe distension due to gas formation.

5. Fire Fighting Measures

Extinguishing Media...

Preferably water or water fog. Carbon dioxide and dry chemical may also be used.

Special Firefighting Procedures...

Any tank or container surrounded by fire should be flooded with water for cooling. Wear full protective clothing and self-contained breathing apparatus.

Degrees of Fire and Explosion Hazard...

Product is noncombustible. On decomposition H₂O₂ releases oxygen which may intensify fire.

Hazardous Decomposition Products...

Oxygen which supports combustion.

6. Accidental Release Measures

Procedure for Release Or Spill...

Dilute with large volume of water and hold in a pond or diked area until H₂O₂ decomposes. Dispose according to methods outlined for waste disposal.

7. Handling and Storage

Handling...

Wear cup type chemical safety goggles and/or full face shield, polyester or acrylic full cover clothing and rubber or neoprene gloves and shoes. Avoid cotton, wool and leather. Avoid excessive heat and contamination. Contamination may cause decomposition and generation of oxygen gas which could result in high pressures and possible container rupture. Hydrogen peroxide should be stored only in vented containers and should be transferred only in a prescribed manner (see FMC technical bulletins). Never return unused hydrogen peroxide to original container. Empty drums should be triple rinsed with water before discarding. Utensils used for handling hydrogen peroxide should be made only of glassy stainless steel, aluminum or plastic.

Ventilation...

Provide mechanical general and/or local exhaust ventilation to prevent release of vapor or mist into the work environment.

Storage...

Store drums in cool areas out of direct sunlight and away from combustibles. For bulk storage refer to FMC technical bulletins.

8. Exposure Controls / Personal Protection

Control Measures...

Ventilation should be provided to minimize the release of H₂O₂ vapors and mist into the work environment. Spills should be collected or confined immediately and diluted for disposal to prevent release into the work area. Remove contaminated clothing immediately and wash before reuse.

Recommended Personal Protective Equipment...

Respiratory

If concentrations in excess of 10 ppm are expected use approved self-contained breathing apparatus. Do not use oxidizable sorbants such as activated carbon.

Eyes

Use cup type chemical goggles and/or full face shield.

Gloves

Liquid proof rubber or neoprene gloves.

Special Clothing and Equipment

Polyester or acrylic full clothing. (avoid cottony wool and leather)

Footwear

Rubber or neoprene footwear. (avoid leather)

9. Physical and Chemical Properties

Properties for...	20%	31%	35%
Melting / Freezing Point	-15°C (6°F)	-26°C (-15°F)	-33°C (-27°F)
Boiling Point	103°C (218°F)	107°C (225°F)	108°C (226°F)
Vapor Pressure	28 mm Hg @ 30°C	24 mm Hg @ 30°C	23 mm Hg @ 30°C
Vapor Density (Air=1)	No data available	No data available	No data available
Room Temperature (appearance and state)	Clear colorless liquid	Clear colorless liquid	Clear colorless liquid
Vapor Density (Air=1)	Odorless	Odorless	Odorless
Specific Gravity (H ₂ O = 1)	1.07 @ 20 °C / 4 °C	1.11 @ 20 °C / 4 °C	1.13 @ 20 °C / 4 °C
Solubility in H ₂ O, % by wt	100%	100%	100%

% Volatiles	100%	100%	100%
Evaporation Rate (butyl acetate=1)	Above 1	Above 1	Above 1
pH (as is)	2.0 - 3.5	2.0 - 3.5	2.0 - 3.5
pH (1% solution)	5.0 - 6.0	5.0 - 6.0	5.0 - 6.0
Odor Threshold	Not available	Not available	Not available
Density (g/mL)	Not available	Not available	Not available
Partition Coefficient (n-octanol/water)	Not available	Not available	Not available
Flash Point	Non-combustible	Non-combustible	Non-combustible
Autoignition Temperature	Non-combustible	Non-combustible	Non-combustible
Flammable Limits: Upper	Non-combustible	Non-combustible	Non-combustible
Flammable Limits: Lower (air)	Non-combustible	Non-combustible	Non-combustible
Explosive Properties	Not applicable	Not applicable	Not applicable
Oxidizing Properties	Strong oxidizer	Strong oxidizer	Strong oxidizer
Solubility: Fat Solubility (solvent - oil)	No data available	No data available	No data available

10. Stability and Reactivity

Stability...	Stable (heat and contamination could cause decomposition)
Hazardous Polymerization...	Will not occur
Conditions to Avoid...	Excessive heat or contamination could cause product to become unstable.
Materials to Avoid...	Dirt, organics, cyanides and combustibles such as wood, paper, oils, etc.
Major Contaminants that Contribute to Instability...	Iron and other heavy metals, copper alloys and caustic.
Incompatibility...	Reducing agents, wood, paper and other combustibles (see above)
Hazardous Decomposition Products...	Oxygen that supports combustion
Sensitivity to Mech Impact...	No data available
Sensitivity to Static Discharge...	No data available

11. Toxicological Information

Eye Contact...	Extremely irritating/corrosive (rabbit) (35% H2O2) Ref. 183-748
Skin Contact...	Mildly irritating after 4 hours exposure (rabbit) (35% H2O2) Ref. 183-747
Skin Absorption...	LD50 > 2000 mg/kg (rabbit) (35% H2O2) Ref. 183-746
Inhalation...	LC50 > 0.17 mg/L (rat) (50% H2O2) Ref. 189-1080
Ingestion...	LD50 = 1193 mg/kg (rat) (35% H2O2) Ref. 183-745

Acute Effects from Overexposure...

Extremely irritating/corrosive to eyes and gastrointestinal tract. May cause irreversible tissue damage to the eyes, including blindness. Inhalation of mist or vapors may be severely irritating to nose, throat and lungs. May cause skin irritation.

Chronic Effects from Overexposure...

There are reports of limited evidence of carcinogenicity of hydrogen peroxide to mice administered high concentrations in their drinking water (IARC Monograph 36, 1985). However, the international agency for research on cancer concluded that hydrogen peroxide could not be classified as to its carcinogenicity to humans (Group III carcinogen).

(Note: Effects considered include: Sensitivities, Carcinogenicity, Teratogenicity, Synergistic Products, and any Medical Conditions generally recognized as being aggravated by exposure.)

12. Ecological Information

Environmental Fate...

H₂O₂ in the aquatic environment is subject to various reduction or oxidation processes and decomposes into water and oxygen. H₂O₂ half life in freshwater ranged from 8 hours to 20 days, in air from 10-20 hrs. And in soils from minutes to hours depending upon microbiological activity and metal contaminants.

Environmental Effects...

Channel catfish: 96 hr LC₅₀ = 37.4 mg/L
Fathead minnow: 96 hr LC₅₀ = 16.4 mg/L
Daphnia magna: 24 hr EC₅₀ = 7.7 mg/L
Daphnia pule: 48 hr LC₅₀ = 2.4 mg/L
Physa sp.: 96 hr LC₅₀ = 17.7 mg/L (freshwater snail)

For more information refer to ECETOC "Joint Assessment of Commodity Chemicals, No.22, Hydrogen Peroxide." ISSN-0773-6339, January 1993

13. Disposal Considerations

Waste Disposal Method...

An acceptable method of disposal is to dilute with a large amount of water and allow the hydrogen peroxide to decompose followed by discharge into a suitable treatment system in accordance with all regulatory agencies. Because acceptable methods of disposal may vary by location and because regulatory requirements may change, the appropriate regulatory agencies should be contacted prior to disposal.

14. Transport Information

DOT Proper Shipping Name...

Hydrogen peroxide, aqueous solutions with not less than 20 percent but not more than 40 percent hydrogen peroxide.

IATA...

Hydrogen peroxide, aqueous solutions with not less than 20 percent but not more than 40 percent hydrogen peroxide.

IMDG...

Hydrogen peroxide, aqueous solutions with not less than 20 percent but not more than 40 percent hydrogen peroxide.

DOT Classification...

5.1 (Oxidizer)

DOT Labels...

Oxidizer, corrosive

- DOT Marking... Hydrogen peroxide, aqueous solutions with not less than 20 percent but not more than 40 percent hydrogen peroxide. UN 2014
- DOT Placard... 5.1 (Oxidizer)
- UN Number... UN 2014
- Hazardous Substance / RQ... Not applicable
- 49 STCC Number... 4918776
- Precautions to be Taken in Transportation... Protect from physical damage. Keep drums in upright position. Drums should not be stacked in transit. Do not store drums on wooden pallets.
- Other Shipping Information... Aluminum tanks, drum/DOT 42D, Packing group II

15. Regulatory Information

OSHA Exposure Limits...

Substance(s)
OSHA: Hydrogen Peroxide

PEL-TWA	1 ppm
STEL	Not applicable
Ceiling	Not applicable
Skin Designation	Not applicable

ACGIH:

TLV-TWA	1 ppm
STEL	Not applicable
Ceiling	Not applicable
Skin Designation	Not applicable

- Target Organ Effects... Sensory irritation, eyes and lungs
- Carcinogenic Potential... Hydrogen peroxide
- Regulated by OSHA
Listed on NTP Report
IARG Group 1, 2a, 2b
No
No
No

U.S. EPA Requirements...

Release Reporting
CERCLA (40 CFR 302)
Not listed

Listed Substance(s)
RQ No
Characteristic Not applicable
RCRA Waste No. Not applicable
Not applicable

Unlisted Substance(s)
RQ Hydrogen peroxide 20-40%
Characteristic 100 lbs
RCRA Waste No. Ignitability, Corrosivity
D001, D002

SARA Title III Sec. 313...

(40 CFR 372)
Listed Toxic Chemical Not listed
Not listed

Inventory Reporting
SARA Title III, Sec 311/312
(40 CFR 370)...

Substance(s)
Hazard Category Hydrogen peroxide 20-40%
Planning Threshold Fire hazard, Immediate (acute) health hazard
Conc. < 52% (10,000 lbs)

Emergency Planning
SARA Title III, Sec 302/303
(40 CFR 355)...

Listed Substance(s)
RQ Not applicable
Planning Threshold Not applicable
Not applicable

U.S. TSCA Status... Listed

Canada Ingredient Disclosure
List...

Substance(s)
Controlled Product Hydrogen peroxide
Hazard Symbols Yes
Hazard Class & Division Corrosive, Oxidizing, Materials causing other toxic effects
Product Ident. No. Class C, Class D, Div. 2, Subdiv. B, Class E
Domestic Substance 2014
List Listed
CEPA Priority List Not listed

Carcinogenicity
ACGIH Appendix A Not listed
A1 - Confirmed Human Not applicable
A1 - Suspected Human Not applicable

IARC Group 1 or 2 No

**Label Language
(U.S. / Canada)...**

Health

Danger. Corrosive to eyes. Direct eye contact may cause reversible tissue damage including blindness. Inhalation of mist or vapor could cause irritation of lungs, nose and throat, usually subsides after exposure ceases. Do not ingest. Corrosive to gastrointestinal tract. May be fatal if swallowed.

Physical

Oxidizer. Initiates combustion in other materials by causing fire through release of oxygen.

Handling and Storage

Keep container in cool place (avoid excessive heat), away from combustibles such as wood, paper, oils, etc. Store only in vented containers. Storage should conform to standards in NFPA bulletin 43a. Avoid contamination - contamination could cause decomposition and generation of oxygen which may result in high pressures and possible container rupture. Do not return unused material to the original container. Wear cup type chemical safety goggles and/or full face mask. Use only suitable protective clothing, e.g., rubber, neoprene or synthetic fibers (avoid cotton, wool and leather). Use glass, stainless steel, aluminum or plastic materials when handling hydrogen peroxide. Empty drums should be triple rinsed with water before discarding.

First Aid

In case of contact, immediately flush eyes or skin with plenty of water for at least 15 minutes while removing contaminated clothing and shoes. See a physician. Wash clothing before reuse. If swallowed, drink plenty of water to dilute. Do not induce vomiting. See a physician immediately.

State Regulations...

Proposition 65 - California

Safe Drinking Water and Toxics Enforcement Act of 1986 requires The government of California to develop a list of carcinogens (a) and reproductive toxins (b). No persons doing business shall knowingly expose any individual to a chemical on this list. FMC's 70% hydrogen peroxide contains the indicated concentration(s) of Listed chemicals: cadmium (a) 0.1%; chromium (a) less than 0.2% and lead (b) less than 0.5%.

(Note: Percentages less than 70% hydrogen peroxide would contain proportionately less.)

16. Other Information

Product Uses...

Durox (TM) 35% REG & LR meets food chemical codex requirements for aseptic packaging and other food related applications.

Oxypure (R) 35% certified by NSF to meet ANSI/NSF Std. 60 requirements for drinking water treatment.

Standard 27.5 & 35% grade most suitable for industrial bleaching, processing, pollution abatement and general oxidation reactions.

Semiconductor REG & SEG 31% conform to ACS and semi specs. For wafer etching and cleaning and applications requiring low residues.

Super D (R) 25 & 35% complies with pharmacopoeia specifications suitable for preparing dilute solutions for pharmaceutical and/or cosmetic applications.

Technical 35% essentially free of inorganic metals, suitable for chemical synthesis.

Hybrite (R) 32.5% used for metal treating

Chlorate grade 20% specially formulated for use in chlorate manufacture or processing.

•
NFPA 704...

Health	2
Flammability	0
Reactivity	1
Special Hazard	OX (where degree of hazard: 0 = no hazard and 4 = severe hazard)

•
**Hazardous Materials
Identification System (HMIS)...**

Health	2
Flammability	0
Reactivity	1
Personal Protection Index (PPI)	H (safety goggles, gloves, apron, and vapor respirator)

The contents and format of this MSDS are in accordance with OSHA hazard communication standard and Canada's workplace hazardous information system (WHMIS).

[\[Back to Material Safety Data Sheets List\]](#)



[Home](#) [Email Us!](#) [Join Our Mailing List!](#) [Search](#) [What's New](#) [Links](#)

Copyright © H2O2.com

MATERIAL SAFETY DATA SHEET (MSDS)

Click here for the French version / Appuyer ici pour la version française

Material Safety Data Sheet

Section 1. Product and Company Identification

Product Name	Ethylene Glycol	Product Code	EX0565
Manufacturer	EM Science A Division of EM Industries P.O. Box 70 480 Democrat Road Gibbstown, N.J. 08027	Effective Date	10/29/2001
For More Information Call	856-423-6300 Technical Service Monday-Friday: 8:00 AM - 5:00 PM	In Case of Emergency Call	800-424-9300 CHEMTREC (USA) 613-996-6666 CANUTEC (Canada) 24 Hours/Day, 7 Days/Week
Synonym	GLYCOL; 1,2-ETHANEDIOL		
Material Uses	Analytical reagent.		
Chemical Family	Polyalcohol		

Section 2. Composition and Information on Ingredients

Component	CAS #	% by Weight
ETHYLENE GLYCOL	107-21-1	100

Section 3. Hazards Identification

Physical State and Appearance	Liquid.
Emergency Overview	WARNING! MAY BE FATAL IF SWALLOWED. CAUSES DAMAGE TO THE FOLLOWING ORGANS: RESPIRATORY TRACT, SKIN, CENTRAL NERVOUS SYSTEM, EYE, LENS OR CORNEA. MAY BE HARMFUL IF INHALED OR ABSORBED THROUGH SKIN. MAY CAUSE RESPIRATORY TRACT, EYE AND SKIN IRRITATION.
Routes of Entry	Absorbed through skin. Dermal contact. Eye contact. Inhalation. Ingestion.
Potential Acute Health Effects	Eyes May be hazardous in case of eye contact (irritant). Skin May be hazardous in case of skin contact (permeator, irritant). Skin inflammation is characterized by itching, scaling, reddening, or, occasionally, blistering. Inhalation May be hazardous in case of inhalation (lung irritant). Ingestion Extremely hazardous in case of ingestion. May be fatal if swallowed.
Potential Chronic Health Effects	Carcinogenic Effects This material is not known to cause cancer in animals or humans. Additional information See Toxicological Information (section 11)
Medical Conditions Aggravated by Overexposure:	Repeated exposure to a highly toxic material may produce general deterioration of health by an accumulation in one or many human organs.

Section 4. First Aid Measures

Eye Contact	Check for and remove any contact lenses. In case of contact, immediately flush eyes with plenty of water for at least 15 minutes. Cold water may be used. Get medical attention.
Skin Contact	In case of contact, immediately flush skin with plenty of water. Cover the irritated skin with an emollient. Remove contaminated clothing and shoes. Cold water may be used. Wash clothing before reuse. Thoroughly clean shoes before reuse. Get medical attention.
Inhalation	If inhaled, remove to fresh air. If not breathing, give artificial respiration. If breathing is difficult, give oxygen. Get medical attention.
Ingestion	If swallowed, do not induce vomiting unless directed to do so by medical personnel. Never give anything by mouth to an unconscious person. Loosen tight clothing such as a collar, tie, belt or waistband. Get medical attention immediately.

Section 5. Fire Fighting Measures

Flammability of the Product	May be combustible at high temperature.
Auto-ignition Temperature	399.9°C (751.8°F)
Flash Points	OPEN CUP: 110.9°C (231.6°F).
Flammable Limits	LOWER: 3.2% UPPER: 15.3%
Products of Combustion	These products are carbon oxides (CO, CO ₂).

Fire Hazards in Presence of Various Substances	Not available.
Explosion Hazards in Presence of Various Substances	Risks of explosion of the product in presence of static discharge: No. Risks of explosion of the product in presence of mechanical impact: No.
Fire Fighting Media and Instructions	SMALL FIRE: Use DRY chemical powder. LARGE FIRE: Use water spray, fog or foam. Do not use water jet.
Protective Clothing (Fire)	Be sure to use an approved/certified respirator or equivalent.
Special Remarks on Fire Hazards	Not available.
Special Remarks on Explosion Hazards	Not available.

Section 6. Accidental Release Measures

Small Spill and Leak	Dilute with water and mop up, or absorb with an inert dry material and place in an appropriate waste disposal container.
Large Spill and Leak	Stop leak if without risk. Do not get water inside container. Do not touch spilled material. Use water spray to reduce vapors. Prevent entry into sewers, basements or confined areas; dike if needed. Eliminate all ignition sources. Call for assistance on disposal. Finish cleaning by spreading water on the contaminated surface and allow to evacuate through the sanitary system. Be careful that the product is not present at a concentration level above TLV. Check TLV on the MSDS and with local authorities.
Spill Kit Information	No specific spill kit required for this product.

Section 7. Handling and Storage

Handling	Avoid prolonged contact with eyes, skin, and clothing. Do not ingest. Avoid breathing vapors or spray mists. Keep container closed.
Storage	Keep container in a cool, well-ventilated area.

Section 8. Exposure Controls/Personal Protection

Engineering Controls	Provide exhaust ventilation or other engineering controls to keep the airborne concentrations of vapors below their respective threshold limit value. Ensure that eyewash stations and safety showers are proximal to the work-station location.
Personal Protection	Eyes Splash goggles. Body Lab coat. Respiratory Vapor respirator. Be sure to use an approved/certified respirator or equivalent. Wear appropriate respirator when ventilation is inadequate. Hands Gloves. Feet Not applicable.
Personal Protection in Case of a Large Spill	Splash goggles. Full suit. Vapor respirator. Boots. Gloves. A self-contained breathing apparatus should be used to avoid inhalation of the product. Suggested protective clothing might not be sufficient; consult a specialist BEFORE handling this product.
Product Name	Exposure Limits

ETHYLENE GLYCOL

AUVA (Austria, 1995). Skin
 PEAK: 52 mg/m³ 8 times per shift, Period: 5 minute(s).
 PEAK: 20 ppm 8 times per shift, Period: 5 minute(s).
 MAK: 26 mg/m³
 MAK: 10 ppm
 Belgium Minister of Labour (Belgium, 1998).
 CEIL: 101 mg/m³
 VCD: 101 mg/m³
 BAUA (Germany, 1997). Skin
 PEAK: 26 mg/m³
 PEAK: 10 ppm
 MAK: 26 mg/m³
 MAK: 10 ppm
 DK-Arbejdstyrelsen (Denmark, 1996). Skin
 GV: 26 mg/m³
 GV: 10 ppm
 Tyterveystilaites (Finland, 1998).
 STEL: 190 mg/m³
 STEL: 75 ppm
 TWA: 130 mg/m³
 TWA: 50 ppm
 INRS (France, 1996).
 VLE: 125 mg/m³
 VLE: 50 ppm
 National Authority for Occupational Safety/Health (Ireland, 1999).
 OEL: 10 mg/m³
 Arbeidsinspectie (Netherlands, 1999).
 TGG 8 uur: 26 mg/m³
 TGG 8 uur: 10 ppm
 N-Arbejdstyrelsen (Norway, 1996).
 AN: 25 ppm
 AFS (Sweden, 1996). Skin
 KTV: 50 mg/m³
 KTV: 20 ppm
 NGV: 25 mg/m³
 NGV: 10 ppm
 EH40-OES (United Kingdom (UK), 1997).
 MEL: 10 mg/m³
 ACGIH (United States, 1995).
 CEIL: 100 mg/m³
 OSHA Final Rule (United States, 1989).
 CEIL: 125 mg/m³
 CEIL: 50 ppm

Section 9. Physical and Chemical Properties

Odor	Odorless.
Color	Colorless.
Physical State and Appearance	Liquid.
Molecular Weight	62.08 g/mole
Molecular Formula	C ₂ H ₆ O ₂
pH	Not available.
Boiling/Condensation Point	197.05°C (386.7°F)
Melting/Freezing Point	-12.95°C (8.7°F)
Specific Gravity	1.1135 (Water = 1)
Vapor Pressure	Not available.
Vapor Density	2.14 (Air = 1)
Odor Threshold	Not available.
Evaporation Rate	0.01 compared to (n-BUTYL ACETATE=1)
LogKow	Not available.
Solubility	Soluble in water.

Section 10. Stability and Reactivity

Stability and Reactivity	The product is stable.
Conditions of Instability	Not available.
Incompatibility with Various Substances	Reactive with oxidizing agents, acids.
Reincompatibility	Not available.
Hazardous Decomposition Products	Not available.
Hazardous Polymerization	Will not occur.

Section 11. Toxicological Information

Ethylene Glycol

KW2975000

Toxicity	Acute oral toxicity (LD50): 4700 mg/kg [Rat].
Chronic Effects on Humans	Not available.
Acute Effects on Humans	May be hazardous in case of eye contact (irritant). May be hazardous in case of skin contact (permeator, irritant). Skin inflammation is characterized by itching, scaling, reddening, or, occasionally, blistering. May be hazardous in case of inhalation (lung irritant). Extremely hazardous in case of ingestion. May be fatal if swallowed.
Synergetic Products (Toxicologically)	Not available.
Irritancy	Draize Test (Rabbit): Eyes: 500mg/24h. Reaction: Mild.
Sensitization	Not available.
Carcinogenic Effects	This material is not known to cause cancer in animals or humans.
Toxicity to Reproductive System	Tests on laboratory animals for reproductive effects are cited in Registry of Toxic Effects on Chemical Substances (RTECS).
Teratogenic Effects	Not available.
Mutagenic Effects	Tests on laboratory animals for mutagenic effects are cited in Registry of Toxic Effects of Chemical Substances (RTECS).

Section 12. Ecological Information

Ecotoxicity	Not available.
BOD5 and COD	Not available.
Toxicity of the Products of Biodegradation	The products of degradation are less toxic than the product itself.

Section 13. Disposal Considerations

EPA Waste Number	Not available.
Treatment	Material does not have an EPA Waste Number and is not a listed waste, however consultation with a permitted waste disposal site (TSD) should be accomplished. Always contact a permitted waste disposal (TSD) to assure compliance with all current local, state, and Federal Regulations.

Section 14. Transport Information

DOT Classification	Not available.
TDG Classification	Not available.
IMO/INIDG Classification	Not available.
ICAO/IATA Classification	Not available.

Section 15. Regulatory Information

U.S. Federal Regulations	TSCA 8(b) inventory: ETHYLENE GLYCOL SARA 302/304/311/312 extremely hazardous substances: No products were found. SARA 302/304 emergency planning and notification: No products were found. SARA 302/304/311/312 hazardous chemicals: ETHYLENE GLYCOL SARA 311/312 MSDS distribution - chemical inventory - hazard identification: ETHYLENE GLYCOL: Immediate (Acute) Health Hazard, Delayed (Chronic) Health Hazard SARA 313 toxic chemical notification and release reporting: ETHYLENE GLYCOL Clean Water Act (CWA) 307: No products were found. Clean Water Act (CWA) 311: No products were found. Clean air act (CAA) 112 accidental release prevention: No products were found. Clean air act (CAA) 112 regulated flammable substances: No products were found. Clean air act (CAA) 112 regulated toxic substances: No products were found. Class D-2B: Material causing other toxic effects (TOXIC).
WHMIS (Canada)	CEPA DSL: ETHYLENE GLYCOL
International Regulations	
EINECS	ETHYLENE GLYCOL 203-473-3
DNCL (EEC)	R22- Harmful if swallowed.
International Lists	Australia (NICNAS): ETHYLENE GLYCOL Japan (MITI): ETHYLENE GLYCOL Korea (TCCL): ETHYLENE GLYCOL Philippines (RA6969): ETHYLENE GLYCOL China: No products were found.
State Regulations	Pennsylvania RTK: ETHYLENE GLYCOL: (environmental hazard, generic environmental hazard) Massachusetts RTK: ETHYLENE GLYCOL: New Jersey: ETHYLENE GLYCOL California prop. 65: No products were found.

Section 16. Other Information

National Fire
Protection Association
(U.S.A.)

Health	1	Fire Hazard
	1	0
		Reactivity
		Specific Hazard

Changed Since Last Revision +

Notice to Reader

The statements contained herein are based upon technical data that EM Industries believes to be reliable, are offered for information purposes only and as a guide to the appropriate precautionary and emergency handling of the material by a properly trained person having the necessary technical skills. Users should consider these data only as a supplement to other information gathered by them and must make independent determinations of suitability and completeness of information from all sources to assure proper use, storage and disposal of these materials and the safety and health of employees and customers and the protection of the environment. **EM INDUSTRIES MAKES NO REPRESENTATION OR WARRANTY OF ANY KIND, EXPRESS OR IMPLIED, INCLUDING MERCHANTABILITY OR FITNESS FOR A PARTICULAR USE, WITH RESPECT TO THE INFORMATION HEREIN OR THE PRODUCT TO WHICH THE INFORMATION REFERS.**

CERTIFICATE OF ANALYSIS (CofA)

EM SCIENCE

CERTIFICATE OF ANALYSIS

NAME: Ethylene Glycol
ITEM NUMBER: EX0565, EX0565/1, EX0565/1, EX0565/11, EX0565/11, EX0565/11, EX0565/20, EX0565/20, EX0565/20, EX0565/3, EX0565/3, EX0565/3, EX0565/5, EX0565/5, EX0565/5, EX0565/5, EX0565/901
LOT NUMBER: 40306124
FORMULA: HOCH₂CH₂OH
FORMULA WT: 62.07
Data Order No: 00057978

PROPERTY	LIMITS		RESULTS	UNITS
	Min.	Max.		
Assay (GC)	98		99.8	%
Color (APHA)		20	<10	
Form			Passes test	
Infrared spectrum			Conforms	

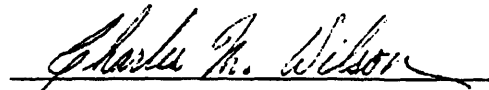

Charles M. Wilson,
 Quality Assurance Manager
 Analysis Date: 11/9/00 11:04:38 AM

EM SCIENCE, An Affiliate of Merck KGaA, Darmstadt, Germany



1 PRODUCT AND COMPANY IDENTIFICATION

Fluorochemicals
2000 Market Street

Philadelphia, PA 19103

Information Telephone Numbers

Product Information

Product Name Forane (R) 22
Product Synonym(s)

Chemical Family Hydrochlorofluorocarbons

Chemical Formula CHClF2

Chemical Name Chlorodifluoromethane

EPA Reg Num

Product Use Refrigerant

EMERGENCY PHONE NUMBERS:

Chemtrec: (800) 424-9300 (24hrs) or (703) 527-3887

Medical: Rocky Mountain Poison Control Center
(303) 623-5716 (24Hrs)

Phone Number

800-245-5858

Available Hrs

8:00 am - 5:30 pm (Eastern)

2 .COMPOSITION / INFORMATION ON INGREDIENTS

Ingredient Name	CAS RegistryNumber	Typical Wt. %	OSHA
Chlorodifluoromethane	75-45-6	100%	Y

The substance(s) marked with a "Y" in the OSHA column, are identified as hazardous chemicals according to the criteria of the OSHA Communication Standard (29 CFR 1910.1200)

This material is classified as hazardous under Federal OSHA regulation.

The components of this product are all on the TSCA inventory list.

3 HAZARDS IDENTIFICATION

Emergency Overview

Colorless liquified gas with faint ether odor.

WARNING!

LIQUID AND GAS UNDER PRESSURE, OVERHEATING AND OVERPRESSURIZING MAY CAUSE GAS RELEASE OR VIOLENT CYLINDER BURSTING. MAY DECOMPOSE ON CONTACT WITH FLAMES OR EXTREMELY HOT METAL SURFACES TO PRODUCE TOXIC AND CORROSIVE PRODUCTS. VAPOR REDUCES OXYGEN AVAILABLE FOR BREATHING AND IS HEAVIER THAN AIR. HARMFUL IF INHALED AND MAY CAUSE HEART IRREGULARITIES, UNCONSCIOUSNESS OR DEATH. LIQUID CONTACT WITH EYES OR SKIN MAY CAUSE FROSTBITE.

Potential Health Effects

Skin contact and inhalation are expected to be the primary routes of occupational exposure to this material. As with most liquefied gases, contact with the rapidly volatilizing liquid or cold vapor can cause frostbite to any tissue. Based on single exposure animal tests, this material is considered to be practically non-toxic if inhaled. However, exposure to gas of this material at high concentrations may effect the nervous system and produce a rapid anesthetic effect. The dense vapor of this material can reduce the oxygen available for breathing and produce symptoms such as headache, dizziness, drowsiness, cyanosis and lack of muscle control followed by collapse. Prolonged exposure to an oxygen-deficient atmosphere may be fatal. Inhalation of this material may cause an increase in the sensitivity of the heart to adrenaline, which could result in irregular heart beats and reduced heart function. Workers with heart disease or

compromised heart function should limit exposure to this material.

4 FIRST AID MEASURES

IF IN EYES, immediately flush with plenty of water. Get medical attention if irritation persists.

IF ON SKIN, Flush exposed skin with lukewarm water (not hot), or use other means to warm skin slowly. Get medical attention if frostbitten by liquid or if irritation occurs.

IF SWALLOWED, Not applicable - product is a gas at ambient temperatures.

IF INHALED, remove to fresh air. If not breathing, give artificial respiration. If breathing is difficult, give oxygen. Get medical attention. Do not give adrenaline, epinephrin or similar drugs following exposure to this product.

5. FIRE FIGHTING MEASURES

Fire and Explosive Properties

Auto-Ignition Temperature	NA	
Flash Point	NA - GAS	Flash Point Method
Flammable Limits- Upper	NA	
Lower	NA	

Extinguishing Media

Use extinguishing media appropriate to surrounding fire conditions.

Fire Fighting Instructions

Stop the flow of gas if possible. Use water spray on person making shut-off. Fire fighters and others who may be exposed to products of combustion should wear full fire fighting turn out gear (full Bunker Gear) and self-contained breathing apparatus (pressure demand NIOSH approved or equivalent). Fire fighting equipment should be thoroughly decontaminated after use.

Fire and Explosion Hazards

May decompose on contact with flames or extremely hot metal surfaces to produce toxic and corrosive products. Liquid and gas under pressure, overheating or overpressurizing may cause gas release and/or violent cylinder bursting. Container may explode if heated due to resulting pressure rise. Some mixtures of HCFCs and/or HCFs, and air or oxygen may be combustible if pressurized and exposed to extreme heat or flame.

6 ACCIDENTAL RELEASE MEASURES

In Case of Spill or Leak

Use Halogen leak detector or other suitable means to locate leaks or check atmosphere. Keep upwind. Evacuate enclosed spaces and disperse gas with floor-level forced-air ventilation. Exhaust vapors outdoors. Do not smoke or operate internal combustion engines. Remove flames and heating elements.

7 HANDLING AND STORAGE

7 HANDLING AND STORAGE

Handling

Avoid breathing gas. Avoid contact with eyes, skin and clothing. Keep container closed. Use only with adequate ventilation. Do not enter confined spaces unless adequately ventilated.

Storage

Do not apply direct flame to cylinder. Do not store cylinder in direct sun or expose it to heat above 120 F. Do not drop or refill this cylinder. Keep away from heat, sparks and flames.

8 EXPOSURE CONTROLS / PERSONAL PROTECTION

Engineering Controls

Investigate engineering techniques to reduce exposures below airborne exposure limits. Provide ventilation if necessary to control exposure levels below airborne exposure limits (see below). If practical, use local mechanical exhaust ventilation at sources of air contamination such as open process equipment.

Eye / Face Protection

Where there is potential for eye contact, wear chemical goggles and have eye flushing equipment available.

Skin Protection

Wear appropriate chemical resistant protective clothing and chemical resistant gloves to prevent skin contact. Consult glove manufacturer to determine appropriate type glove material for given application. Rinse contaminated skin promptly. Wash contaminated clothing and clean protective equipment before reuse. Wash skin thoroughly after handling.

Respiratory Protection

Avoid breathing gas. Use NIOSH approved respiratory protection equipment appropriate to the material and/or its components (full facepiece recommended) when airborne exposure limits are exceeded (see below). Consult respirator manufacturer to determine appropriate type equipment for a given application. Observe respirator use limitations specified by NIOSH or the manufacturer. For emergency and other conditions where exposure limit may be significantly exceeded, use an approved full face positive-pressure, self-contained breathing apparatus or positive-pressure airline with auxiliary self-contained air supply. Respiratory protection programs must comply with 29 CFR § 1910.134.

Airborne Exposure Guidelines for Ingredients

Exposure Limit	Value
Chlorodifluoromethane	
ACGIH TWA	1000 ppm 3540 mg/m3

-Only those components with exposure limits are printed in this section.

-Skin contact limits designated with a "Y" above have skin contact effect. Air sampling alone is insufficient to accurately quantitate exposure. Measures to prevent significant cutaneous absorption may be required.

Forane (R) 22
-Material Safety Data Sheet-
Elf Atochem North America, Inc.

9 PHYSICAL AND CHEMICAL PROPERTIES

Appearance/Odor	Colorless liquified gas with faint ether odor.
pH	NE
Specific Gravity	1.17 @ 30/0 C
Vapor Pressure	136 PSIA @ 21 C/70 F
Vapor Density	2.98 at 1 atm
Melting Point	NE
Freezing Point	-160 C (-256 F)
Boiling Point	-40.8 C (-41.4 F)
Solubility in Water	Slight
Molecular Weight	86.48

10 STABILITY AND REACTIVITY

Stability

This material is chemically stable under specified conditions or storage, shipment and/or use. See HANDLING AND STORAGE section of this MSDS for specified conditions.

Incompatibility

Avoid contact with strong alkali or alkaline earth metals, finely powdered metals such as aluminum, magnesium or zinc and strong oxidizers, since they may react or accelerate decomposition.

Hazardous Decomposition Products

Thermal decomposition products include hydrogen fluoride, hydrogen chloride, carbon monoxide, carbon dioxide and chlorine.

11 TOXICOLOGICAL INFORMATION

Toxicological Information

Single exposure (acute) studies indicate:

Inhalation - Practically Non-Toxic (2 hr-LD50 = 300,000 (rat), 390,000 ppm (mouse))

Inhalation - Rat 10 min-EC50 = 140,000 ppm (CNS Effects)

Eye Irritation - Slightly Irritating to Rabbits (5-30 sec. exposure to gas spray)

Skin Irritation - (Moderate) Irritating to Rabbits (liquefied gas with patch applied)

There have been several accidental deaths associated with exposure to this material or mixtures with other fluorocarbons. Death was generally attributed to oxygen deficiency. Microscopic examination of the tissues of some of the victims showed effects on the lungs and fatty deposits in liver cells. An increase in the incidence of heart palpitations have been claimed by individuals occupationally exposed. Monitoring of workers during occupational exposure showed no connection to exposure and cardiac arrhythmia or neurologic disorders. Other epidemiological studies have reported similar results.

Repeated daily application of a 10 second spray caused reddening and slight swelling of the skin and a delay in hair growth. Skin allergy was not observed in guinea pigs following repeated exposure. Inhalation causes an initial stimulation and then depression of the central nervous system (CNS). Symptoms in animals include loss of equilibrium, tremors, convulsions and narcosis and death, usually attributed to asphyxiation. At levels that caused anesthesia, dogs exhibited convulsions. Exposure by inhalation at 300,000 to 400,000 ppm for 10-15 minutes was fatal to rabbits, also causing hemorrhages and effects on the liver. Following inhalation exposure

11 TOXICOLOGICAL INFORMATION

to 50,000 ppm for 1 month, no effects were reported in guinea pigs, rats, dogs and cats; 60,000 ppm for 2-3 months elicited mild liver effects in rabbits; 5,000 ppm for 3 months caused no effects in dogs; 15,000 ppm for 4 months, produced no neurotoxic effects in rats; 14,000 ppm for 10 months produced effects on the lungs, CNS, heart, liver, kidney, spleen of rats, mice and rabbits, while at 2,000 ppm no effects were reported in rats and mice. An increase in malignant tumors of the salivary glands was reported in male rats but not in female rats or mice of either sex after inhalation exposure to 50,000 ppm 5 hr/day, 5 day/wk for 21 months. Long term inhalation of 5,000 ppm was not carcinogenic to rats and mice. Oral dosing for 52 weeks produced no adverse effects in rats. Inhalation at levels up to 50,000 and 100,000 ppm, produced no adverse effects on male reproductive performance in rats and mice respectively. Eye malformations were reported in rats exposed by inhalation during pregnancy at 50,000 ppm. In rats at 1,000 ppm or in rabbits exposed at levels up to 50,000 ppm. In rabbits, rats and humans, a small portion of inhaled material was distributed into the brain, heart, lungs, liver, kidneys and fat. It was rapidly eliminated from the body in the inhaled air. No significant metabolism occurs in humans or rats. The results of the tests for genetic changes were mixed. Studies with mice, dogs, rats, rabbits, cats and monkeys have shown that inhalation exposure can cause cardiac arrhythmias. The NOEL for cardiac sensitization in dogs is 25,000 ppm.

12 ECOLOGICAL INFORMATION

Ecotoxicological Information

No effects were reported on the growth of aerobic and anaerobic microorganisms over a 24 hour period, including gram-positive and gram-negative species, from exposure to a media containing this material at 5 mg/ml.

Chemical Fate Information

Chlorodifluoromethane

The octanol/water partition coefficient (log Pow) was reported to be 1.08.

13 DISPOSAL CONSIDERATIONS

Waste Disposal

Recover, reclaim or recycle when practical. Dispose of in accordance with federal, state and local regulations. Note: Chemical additions to, processing of, or otherwise altering this material may make this waste management information incomplete, inaccurate, or otherwise inappropriate. Furthermore, state and local waste disposal requirements may be more restrictive or otherwise different from federal laws and regulations.

14 TRANSPORT INFORMATION

DOT Name	Chlorodifluoromethane
DOT Technical Name	(R-22)
DOT Hazard Class	2.2
UN Number	UN 1018
DOT Packing Group	PG NA
RQ	

15 REGULATORY INFORMATION

Forane (R) 22
-Material Safety Data Sheet-
Elf Atochem North America, Inc.

Hazard Categories Under Criteria of SARA Title III Rules (40 CFR Part 370)

Immediate (Acute) Health	Y	Fire	N
Delayed (Chronic) Health	N	Reactive	N
		Sudden Release of Pressure	Y

The components of this product are all on the TSCA inventory list.

Ingredient Related Regulatory Information:

SARA Reportable Quantities

CERCLA RQ

SARA TPQ

Chlorodifluoromethane

NE

SARA Title III, Section 313

This product does contain chemical(s) which are defined as toxic chemicals under and subject to the reporting requirements of, Section 313 of Title III of the Superfund Amendments and Reauthorization Act of 1986 and 40 CFR Part 372. See Section 2

Chlorodifluoromethane

Massachusetts Right to Know

This product does contain the following chemical(s), as indicated below, currently on the Massachusetts Right to Know Substance List.

Chlorodifluoromethane

New Jersey Right to Know

This product does contain the following chemical(s), as indicated below, currently on the New Jersey Right-to-Know Substances List.

Chlorodifluoromethane

Pennsylvania Environmental Hazard

This product does contain the following chemical(s), as indicated below, currently on the Pennsylvania Environmental Hazard List.

Chlorodifluoromethane

Pennsylvania Right to Know

This product does contain the following chemical(s), as indicated below, currently on the Pennsylvania Hazardous Substance List.

Chlorodifluoromethane

16 OTHER INFORMATION

Revision Information

Revision Date	17 JUL 1999	Revision Number	1
Supersedes Revision Dated	New Document		

Revision Summary

Initial Entry

Key

NE= Not Established NA= Not Applicable (R) = Registered Trademark

Forane (R) 22
-Material Safety Data Sheet-
Elf Atochem North America, Inc.

Elf Atochem North America, Inc. believes that the information and recommendations contained herein (including data and statements) are accurate as of the date hereof. **NO WARRANTY OF FITNESS FOR ANY PARTICULAR PURPOSE, WARRANTY OF MERCHANTABILITY, OR ANY OTHER WARRANTY, EXPRESSED OR IMPLIED, IS MADE CONCERNING THE INFORMATION PROVIDED HEREIN.** The information provided herein relates only to the specific product designated and may not be valid where such product is used in combination with any other materials or in any process. Further, since the conditions and methods of use are beyond the control of Elf Atochem, Elf Atochem expressly disclaims any and all liability as to any results obtained or arising from any use of the product or reliance on such information.

CARUS CHEMICAL COMPANY

Material Safety Data Sheet

CARULITE® 200 Low Temperature Oxidation Catalyst

Section 1 Chemical Product and Company Identification

CARULITE® 200 Low Temperature Oxidation Catalyst

MANUFACTURER'S NAME: CARUS CORPORATION	TELEPHONE NUMBER FOR INFORMATION: (815) 223-1500
MANUFACTURING FACILITY: Carus Chemical Company 1500 Eighth Street P. O. Box 1500 LaSalle, IL 61301	CHEMTREC TELEPHONE NO.: (800) 424-9300 EMERGENCY TELEPHONE NO.: (800) 435-6856

Section 2 Composition and Information on Ingredients

SYNONYMS: None			
CLASS: Inorganic oxides			
HAZARDOUS MATERIALS IDENTIFICATION SYSTEM (HMIS):			
Health Hazard	1		
Flammability Hazard	0		
Reactivity Hazard	0		
Personal Protection Index	E		
<u>Hazardous Ingredients</u>			
<u>Material or Component</u>	<u>CAS No.*</u>	<u>%</u>	<u>Hazard Data</u>
Manganese Dioxide	1313-13-9	60-75 %	PEL** C**** 5 mg Mn per cubic meter of air TLV-TWA*** 0.2 mg Mn per cubic meter of air
Copper Oxide	1317-38-0	11-14 %	PEL** 1 mg Cu per cubic meter of air TLV-TWA*** 1 mg Cu per cubic meter of air
Aluminum Oxide	1344-28-1	15-16 %	TLV-TWA*** 10 mg per cubic meter of air
* Chemical Abstract Service Number			
** OSHA Permissible Exposure Limit, manganese compounds (as Mn), copper dusts and mists (as Cu), 29 CFR 1910.1000 Table Z-1.			
*** American Conference of Governmental Hygienists, 1998. TLV-TWA = the time weighted average concentration for a normal 8-hour workday and a 40-hour work week, to which nearly all workers may be repeatedly exposed, day after day, without adverse effect.			
**** Ceiling Exposure Limit or maximum exposure concentration not to be exceeded under any circumstances.			

CARUS CHEMICAL COMPANY

Section 3 Hazards Identification

ROUTES OF EXPOSURE

1. Inhalation
May cause severe respiratory irritation.
2. Skin Contact
May cause skin irritation or burns.
3. Eye Contact
Contact may cause eye irritation or burns.
4. Ingestion
Irritating to mouth, throat, and stomach.

EFFECTS OF ACUTE AND CHRONIC EXPOSURE

1. Acute Exposure
May cause respiratory tract and eye irritation.
2. Chronic Exposure
Prolonged inhalation of manganese compounds above the ceiling exposure limit may cause lung irritation and central nervous system disorders. The symptoms simulate Parkinson's disease.
3. Carcinogenicity
NTP: not listed IARC Monographs: not listed OSHA Regulated: not listed
4. Medical Conditions Generally Aggravated by Exposure
Dust or fine powder may further irritate mucous membranes or open wounds.

Section 4 First Aid Measures

EMERGENCY AND FIRST AID PROCEDURES

1. Eyes
Immediately flush eyes with large amounts of water for at least 15 minutes holding lids apart to ensure flushing of the entire surface. Seek medical attention if irritation persists.
2. Skin
Flush contaminated areas with large amounts of water. Remove contaminated clothing. Wash clothing before reuse.
3. Inhalation
Remove person to fresh air. If breathing is difficult, administer oxygen. Seek medical attention.
4. Ingestion
Never give anything by mouth to an unconscious or convulsing person. If conscious, give large quantities of water. Do not induce vomiting. Seek medical attention.

Section 5 Fire Fighting Measures

The material itself is noncombustible but may accelerate the burning of combustible material

FLASHPOINT None

FLAMMABLE OR EXPLOSIVE LIMITS Lower: Nonflammable Upper: Nonflammable

EXTINGUISHING MEDIA Use extinguishing medium appropriate for surrounding materials.

SPECIAL FIREFIGHTING PROCEDURES None

UNUSUAL FIRE AND EXPLOSION HAZARDS Should not be heated or rubbed in contact with organic matter or other oxidizable substances. Keep away from heat and flammable materials. Potentially strong oxidizer.

carus CHEMICAL COMPANY

Section 6 Accidental Release Measures

STEPS TO BE TAKEN IF MATERIAL IS RELEASED OR SPILLED

Clean up spills immediately by scooping CARULITE[®] catalyst into a metal drum. Deactivate by soaking with water. Cover loosely. Flush contaminated floors with abundant quantities of water into sewer, if permitted by federal, state, or local regulations.

Section 7 Handling and Storage

Store in a cool, dry area in closed container. Segregate from easily oxidizable materials, peroxides, chlorates, and acids. Protect containers against physical damage.

Section 8 Exposure Controls and Personal Protection

VENTILATION REQUIREMENTS

Provide sufficient mechanical and/or local exhaust to maintain exposure levels below ceiling exposure limit.

RESPIRATORY PROTECTION

In cases where high dust exposure may exist, the use of NIOSH-MSHA dust and mist respirator or an air supplied respirator is advised. Engineering or administrative controls should be implemented to control dust.

EYE PROTECTION

Primary eye protection (safety glasses or goggles).

GLOVES

Rubber or plastic gloves should be worn.

OTHER PROTECTIVE EQUIPMENT

Normal work clothing is sufficient.

Section 9 Physical and Chemical Properties

BOILING POINT, 760 mm Hg Not applicable	VAPOR PRESSURE (mm Hg) Not applicable
SOLUBILITY IN WATER % BY SOLUTION	Insoluble
SPECIFIC GRAVITY 4.7	PERCENT VOLATILE BY VOLUME Not volatile
BULK DENSITY 1.0 g/cm ³	
MELTING POINT Starts to decompose with evolution of oxygen at 454°C (850°F)	
APPEARANCE AND ODOR Black extruded, granulated, or powdered solid; odorless	

Section 10 Stability and Reactivity

STABILITY Stable under normal conditions. Moisture may reduce catalytic activity.
CONDITIONS TO AVOID Contact with incompatible materials or heat (454°C/850°F)
INCOMPATIBLE MATERIALS Contact with peroxides and chlorates may cause violent reaction under certain conditions, such as elevated temperature or friction. May ignite organic material, especially organic solvents. May initiate polymerization of monomers. May form unstable acetylides in contact with acetylene.
HAZARDOUS DECOMPOSITION PRODUCTS None
CONDITIONS CONTRIBUTING TO HAZARDOUS POLYMERIZATION Material is not known to polymerize.

carus CHEMICAL COMPANY

Section 11 Toxicological Information

Most diagnosed cases of manganese toxicity in humans have been reported following exposures to airborne concentrations of manganese above the ceiling exposure limit. The usual form of chronic manganese toxicity involves the central nervous system.

Reports of adverse effects in humans from ingestion of manganese are rare.

Section 12 Ecological Information

Inorganic manganese compounds have negligible vapor pressures but exist in air as suspended particulate matter which settle under the influence of gravity.

The transport of manganese in water is influenced by the solubility of the form present. Insoluble forms, such as manganese dioxide, are transported as sediments.

The biomagnification of manganese in the food chain does not appear to be significant.

Section 13 Disposal considerations

Carulite[®] 200 is not considered a hazardous waste under 40 CFR 261. Dispose of deactivated Carulite[®] in a landfill approved to accept chemical waste, after verifying that it is not contaminated with hazardous substances through usage.

Section 14 Transport Information

Proper Shipping Name:	Manganese dioxide compound
ID Number:	Not regulated by DOT
Product R.Q. (lb.)	None

Section 15 Regulatory Information

Carulite[®] 200 Low Temperature Oxidization Catalyst contains manganese compounds (CAS Reg. No. N/A) and copper compounds (CAS Reg. No. N/A) as part of the mixture and is subject to the reporting requirements of Section 313 of Title III Superfund Amendments and Reauthorization Act of 1986 and 40 CFR Part 372.

Components of this product are listed on the TSCA Inventory.

Manganese dioxide and copper oxide are considered hazardous chemicals by definition of Hazard Communication Standard (29CFR 1910.1200).

Section 16 Other Information

MSDS Status:	Revised April 1999.
Supersedes Date:	Sept 1997
Form Number:	CL 170-3 Revision 2

carus CHEMICAL COMPANY

The information contained herein is accurate to the best of our knowledge. However, data, safety standards and government regulations are subject to change and, therefore, holders and users should satisfy themselves that they are aware of all current data and regulations relevant to their particular use of product. CARUS CHEMICAL COMPANY DISCLAIMS ALL LIABILITY FOR RELIANCE ON THE COMPLETENESS OR ACCURACY OR THE INFORMATION INCLUDED HEREIN. CARUS CHEMICAL COMPANY MAKES NO WARRANTY, EITHER EXPRESS OR IMPLIED, INCLUDING, BUT NOT LIMITED TO, ANY WARRANTIES OF MERCHANTABILITY OR FITNESS FOR PARTICULAR USE OR PURPOSE OF THE PRODUCT DESCRIBED HEREIN. All conditions relating to storage, handling, and use of the product are beyond the control of Carus Chemical Company, and shall be the sole responsibility of the holder or user of the product.

CARUS CHEMICAL COMPANY IS A DIVISION OF CARUS CORPORATION,
315 5TH STREET, PERU, ILLINOIS 61354

Telephone: (800) 435-6856
(815) 223-1500
Fax: (815) 224-6697

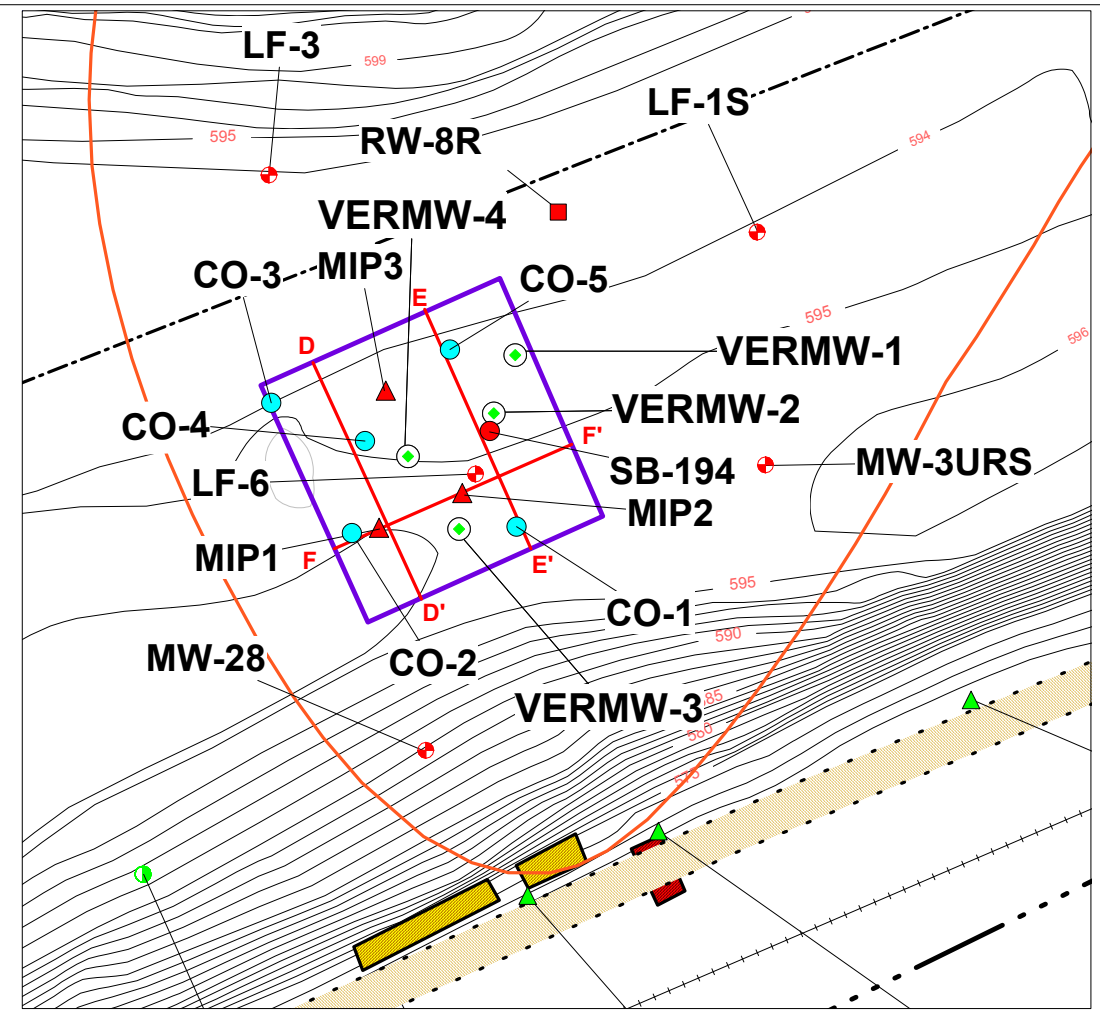
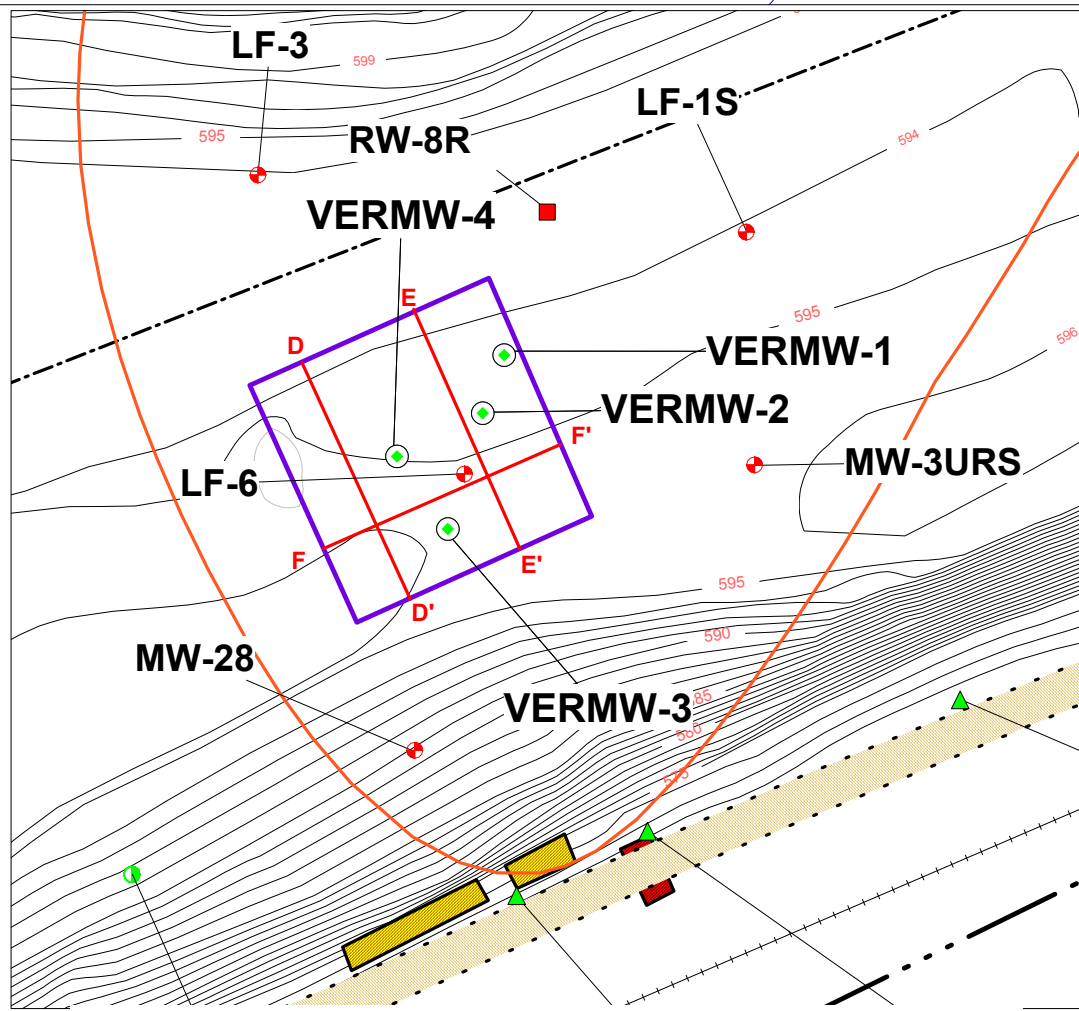
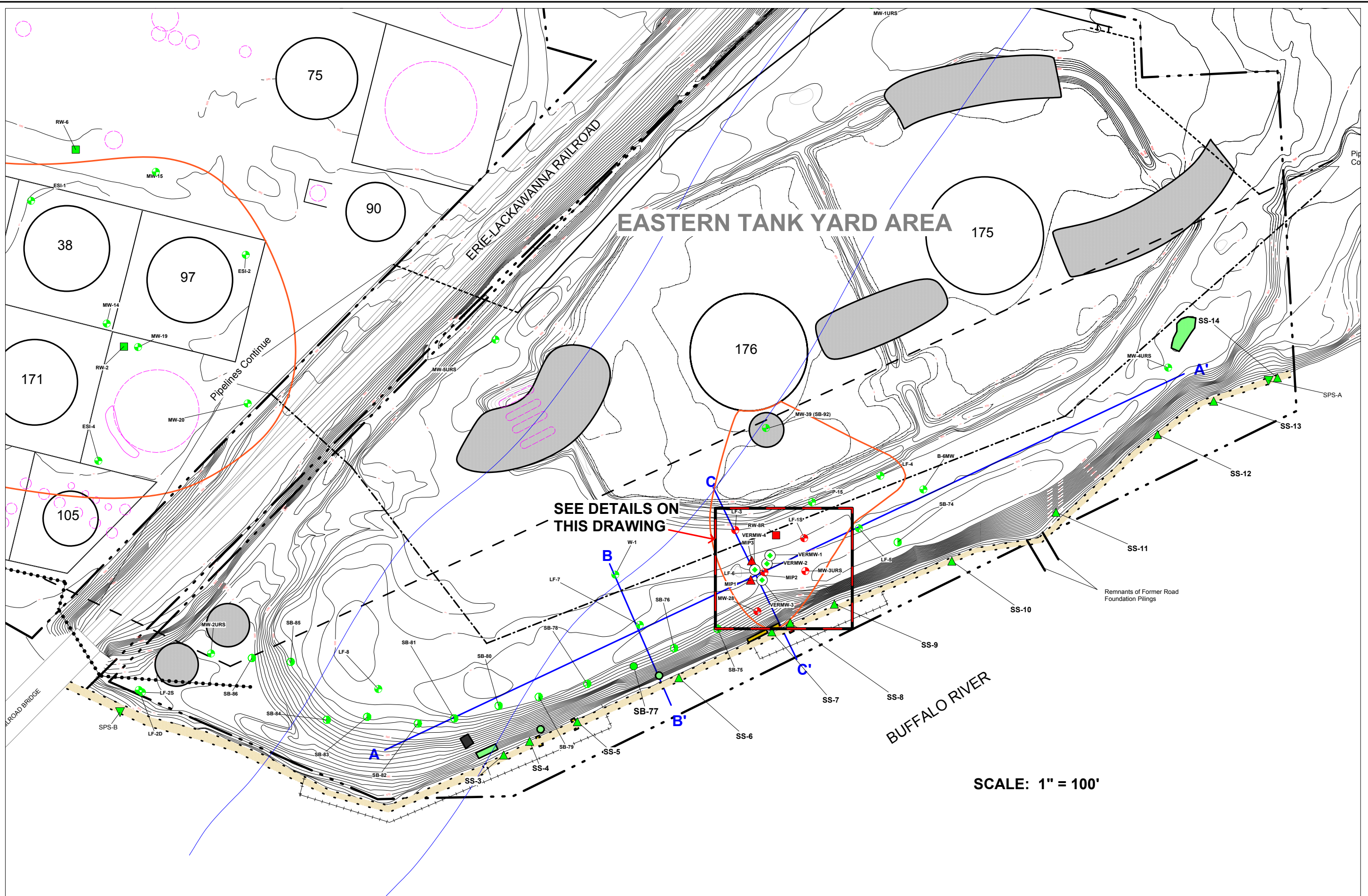

LEGEND

- | | | | |
|--|--|--|--|
| <ul style="list-style-type: none"> ● EXISTING SOIL BORING/ MONITORING WELL ● EXISTING MONITORING WELL ■ EXISTING RECOVERY WELL ● EXISTING SOIL BORING LOCATION ▼ PHASE II INVESTIGATION SEDIMENT SAMPLE LOCATION ▲ APRIL 2001 SEDIMENT SAMPLE LOCATION --- PORTION OF EXXON MOBIL CORP.'S BURIED PRODUCT PIPELINE THAT IS ABANDONED (Line purged and abandoned in place) ----- PORTION OF EXXON MOBIL CORP.'S BURIED PRODUCT PIPELINE THAT IS ACTIVE — EXXON MOBIL CORP.'S ACTIVE ABOVEGROUND PRODUCT PIPELINE --- LAKEHEAD PIPELINE CO.'S, BURIED PRODUCT PIPELINE (Line reportedly purged and filled with nitrogen in 1982) --- APPROXIMATE EXXON MOBIL CORP.'S PROPERTY LINE | <ul style="list-style-type: none"> ● PILOT TEST CHEMICAL INJECTION WELL ● 2-INCH PILOT TEST MONITORING POINT (USED FOR BOTH PILOT TESTS) ▲ PILOT TEST MEMBRANE INTERFACE PROBE LOCATION ● EXISTING MONITORING WELL MODIFIED AND USED AS A MONITORING POINT ■ EXISTING RECOVERY WELL MODIFIED AND USED AS A MONITORING POINT ● PILOT TEST SOIL BORING LOCATION — A—A' LOCATION OF HYDROGEOLOGIC CROSS SECTIONS A-A', B-B' AND C-C' — D—D' LOCATION OF HYDROGEOLOGIC CROSS SECTIONS D-D', E-E' AND F-F' IN THE PILOT TEST AREA | <ul style="list-style-type: none"> ● WELL POINT SYSTEM ■ AREAS OF PRODUCT/IRON STAINING (proportions exaggerated for clarity) ■ AREA OF PRODUCT SEEPAGE OBSERVED ON OCTOBER 26, 2000 (proportions exaggerated for clarity) --- LIMITS OF SHORELINE INSPECTED IN OCTOBER 2000 AND JUNE 2003 (width exaggerated for clarity) — LIMITS OF CURRENT/HISTORICAL SEPARATE-PHASE PRODUCT OBSERVED IN MONITORING WELLS | <ul style="list-style-type: none"> --- LIMITS OF CONTAINMENT BOOM (proportions exaggerated for clarity) ● HISTORICAL WASTE HANDLING AREAS ■ DRUM REMNANTS (proportions exaggerated for clarity) ■ ASPHALT MATERIAL (proportions exaggerated for clarity) — APPROXIMATE COURSE OF FORMER BUFFALO RIVER CHANNEL |
|--|--|--|--|



Title: VACUUM ENHANCED RECOVERY AND CHEMICAL OXIDATION PILOT TEST AREA LAYOUT AND MONITORING WELL NETWORK

Prepared For: EXXONMOBIL OIL CORPORATION

Compiled by: NC	Date: 11/30/04
Prepared by: NC	Scale: AS SHOWN
Project Mgr: NC	Office: NY
File No: MCS224101.WOR	Project: 17252Y06

PLATE 1

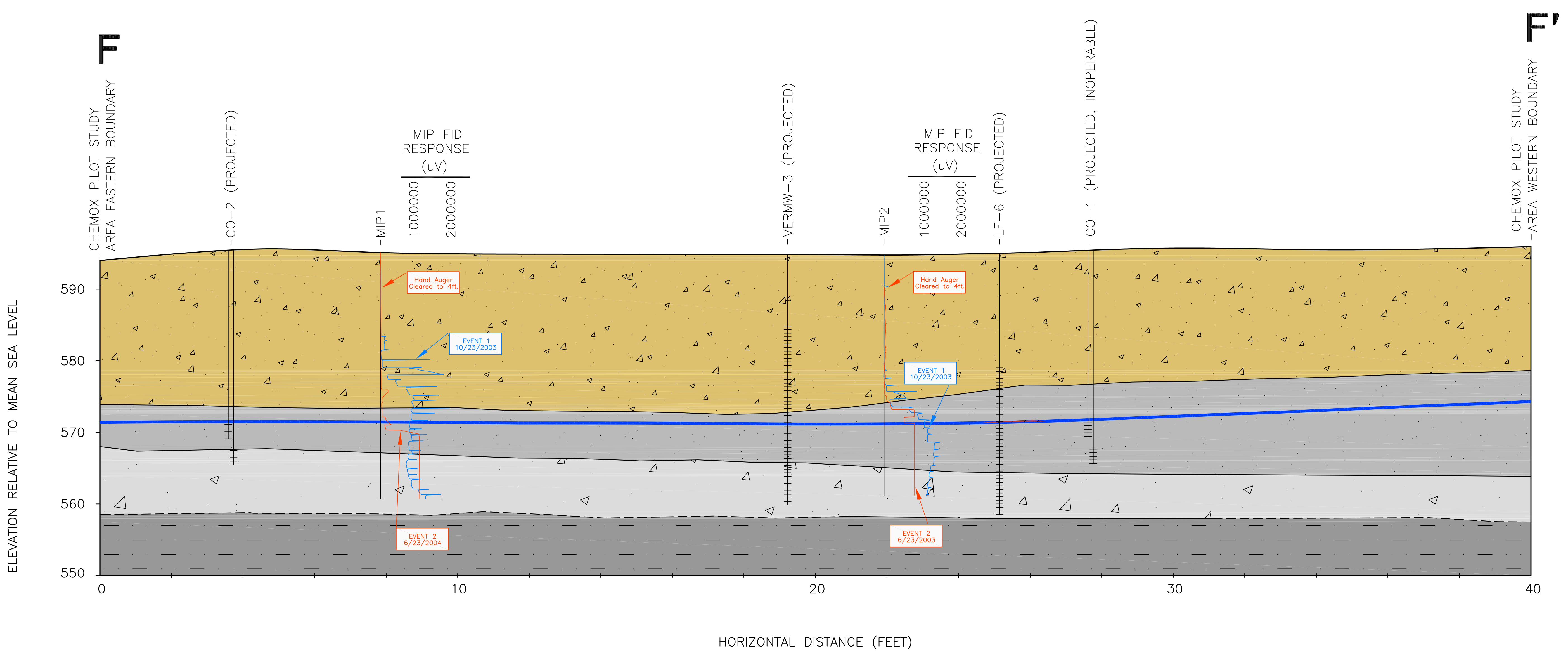
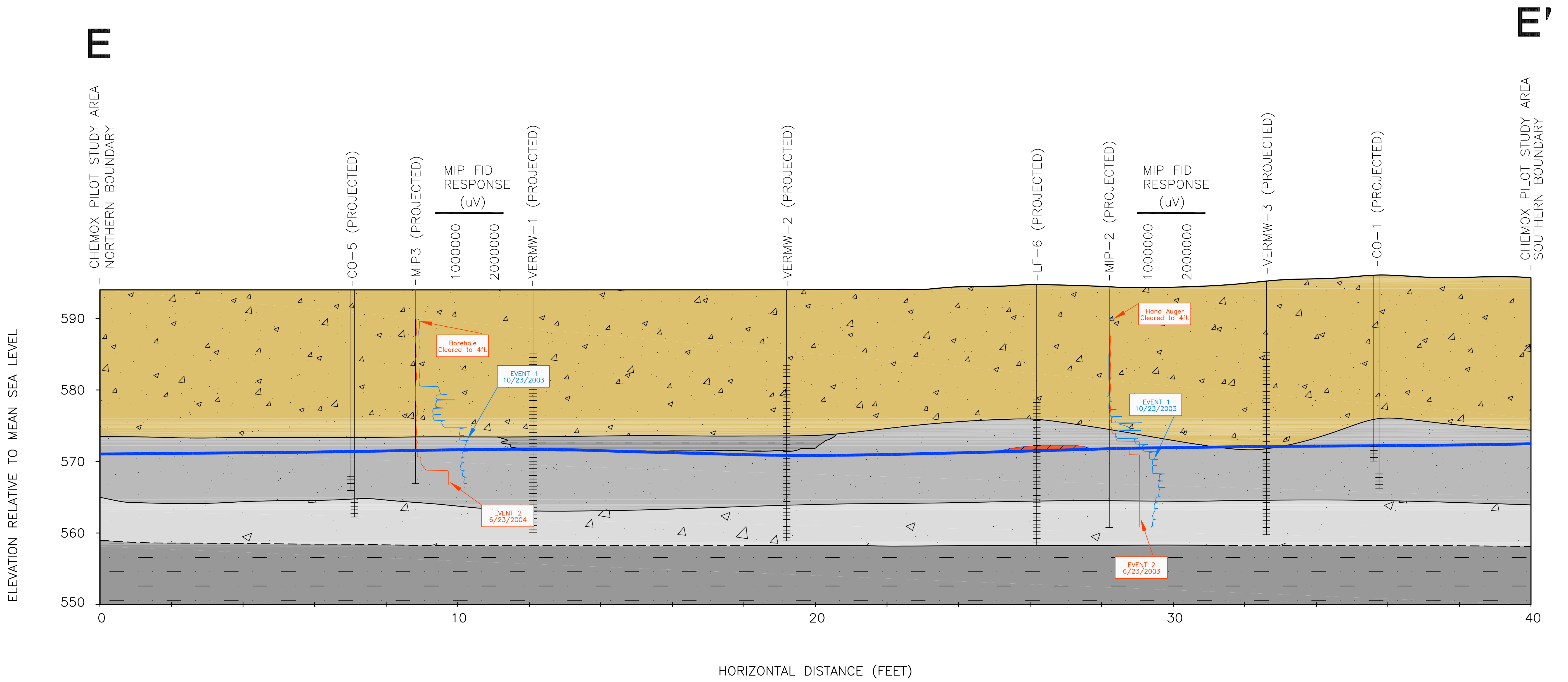
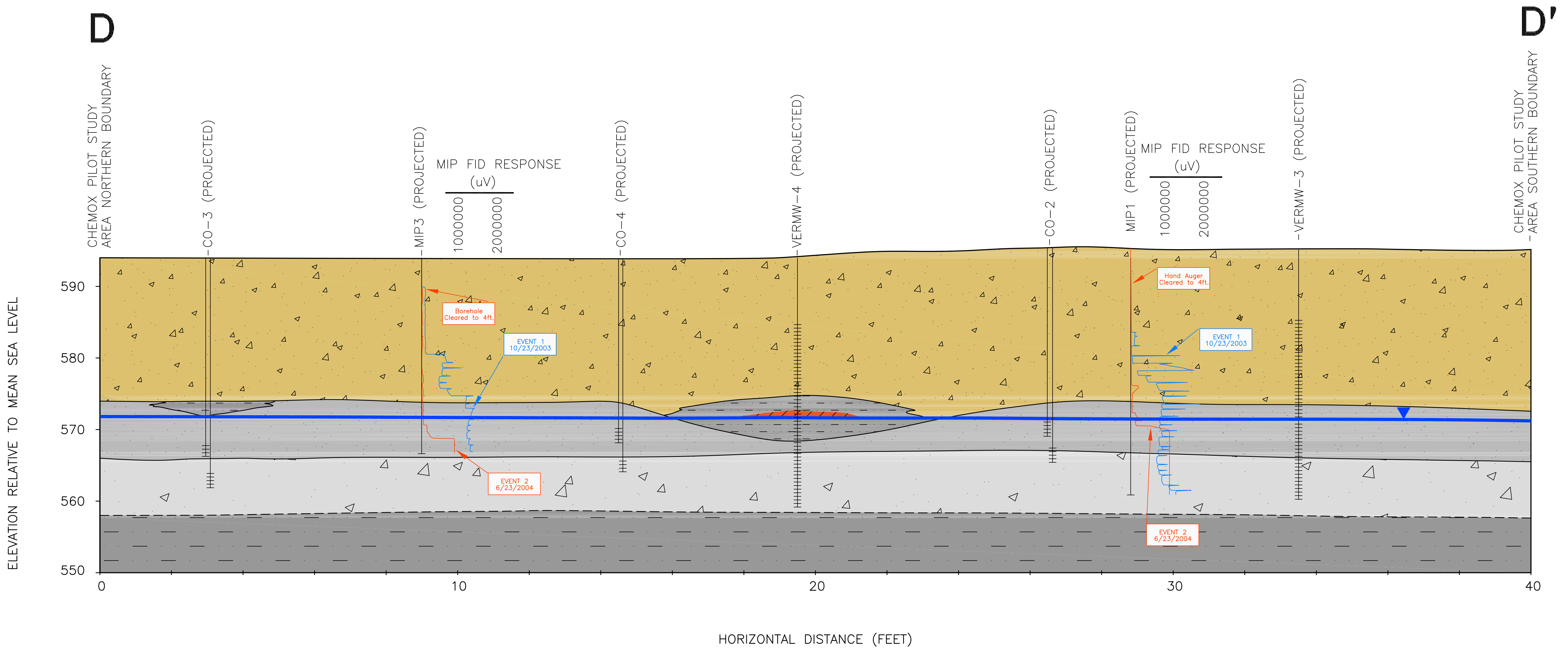

LEGEND

- WATER-TABLE ELEVATION IN FEET ABOVE MEAN SEA LEVEL
- INDICATES MONITORING WELL SCREENED INTERVAL
- INDICATES MIP LOCATION
- FILL MATERIAL CONSISTING OF BLACK CINDERS, CONCRETE, BRICK, GLASS, SLAG, WOOD, SILT, GRAVEL AND SAND
- ALLUVIAL DEPOSITS (SAND, SAND AND SILT, SAND AND GRAVEL, SILTY SAND, SILT)
- ALLUVIAL DEPOSITS (SAND AND GRAVEL)
- CLAY (INCLUDES CLAY AND SILT AND CLAY)
- APPARENT THICKNESS OF SEPARATE PHASE PRODUCT OBSERVED IN MONITORING WELLS

- NOTES:**
1. FOR LOCATION OF SECTION LINES SEE PLATE 1.
 2. LAND SURFACE SHOWN IS ALONG THE SECTION CUT LINE, NOT NECESSARILY AT THE WELL/BORING LOCATIONS IF WELL/BORING IS PROJECTED ONTO THE LINE.
 3. LINES SEPARATING CLAY LAYER FROM SAND AND GRAVEL LAYER ARE SHOWN DASHED WHERE INFERRED.
 4. DEPTH TO THE LOWER CLAY LAYER IS BASED ON DATA FROM LF-6 AND OTHER WELLS OUTSIDE THE PILOT TEST ARE BOUNDARIES.
 5. MIP FID RESPONSE DURING EVENT 1 (10/23/2003) AND IMMEDIATELY AFTER THE PILOT TEST (EVENT 2 ON 6/23/2004) IS SHOWN AS MICRO VOLTS (uV) ON A SCALE FROM 0 TO 2,000,000 uV.

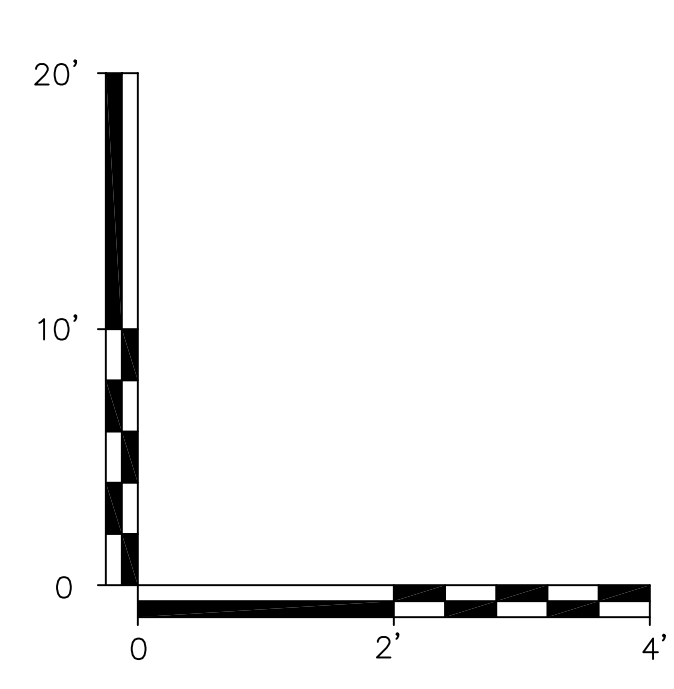

Title: **GENERALIZED HYDROGEOLOGIC CROSS SECTIONS D-D', E-E' AND F-F' WITH BASELINE WATER TABLE ELEVATION AND PRODUCT THICKNESS DATA (APRIL 7, 2004)**
 BUFFALO TERMINAL, BUFFALO, NEW YORK

Prepared For: **EXXONMOBIL OIL CORPORATION**

	Compiled by: N.C.	Date: 25AUG04	PLATE 2
	Prepared by: R.K.	Scale: AS SHOWN	
	Project Mgr: N.C.	Office: NY	
	File No: MC5224104	Project: 17252Y06	

X:\PROJECTS\MCT\27\MCS241\MCS2241.DWG

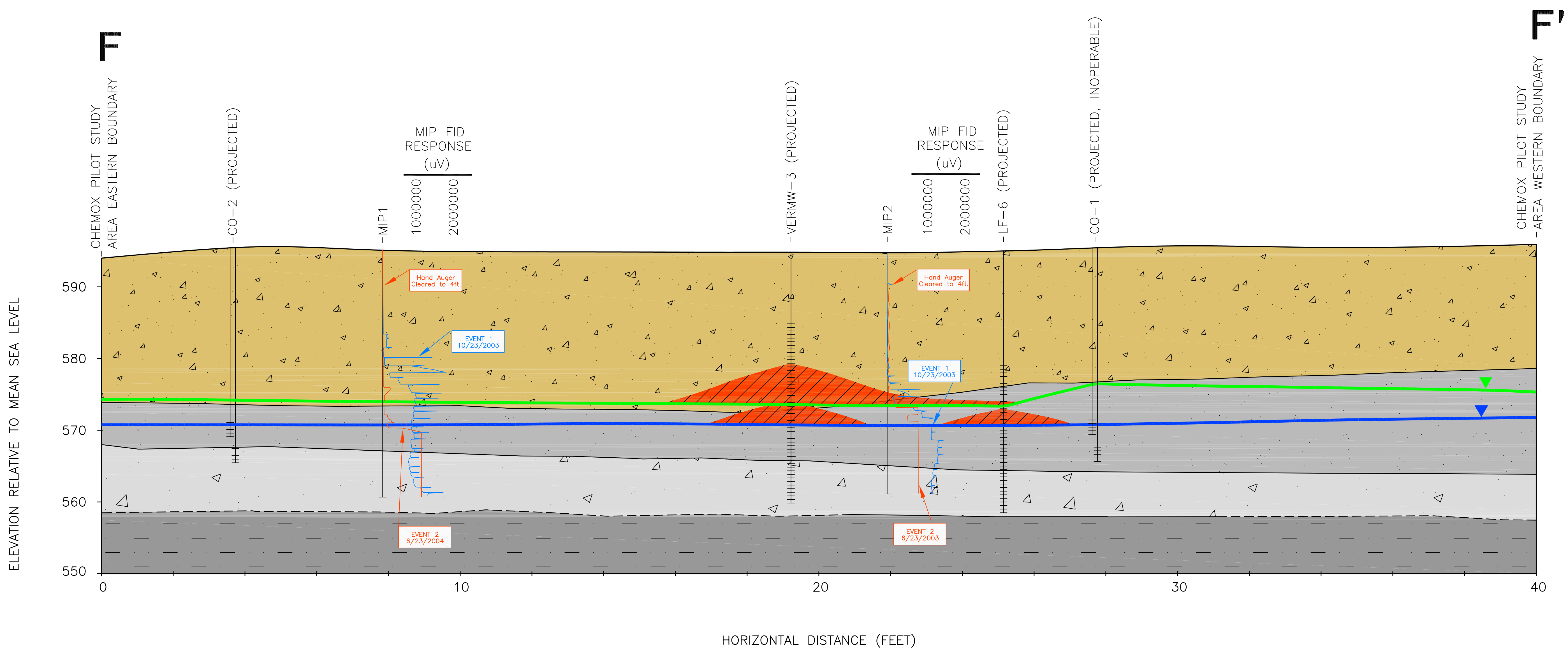
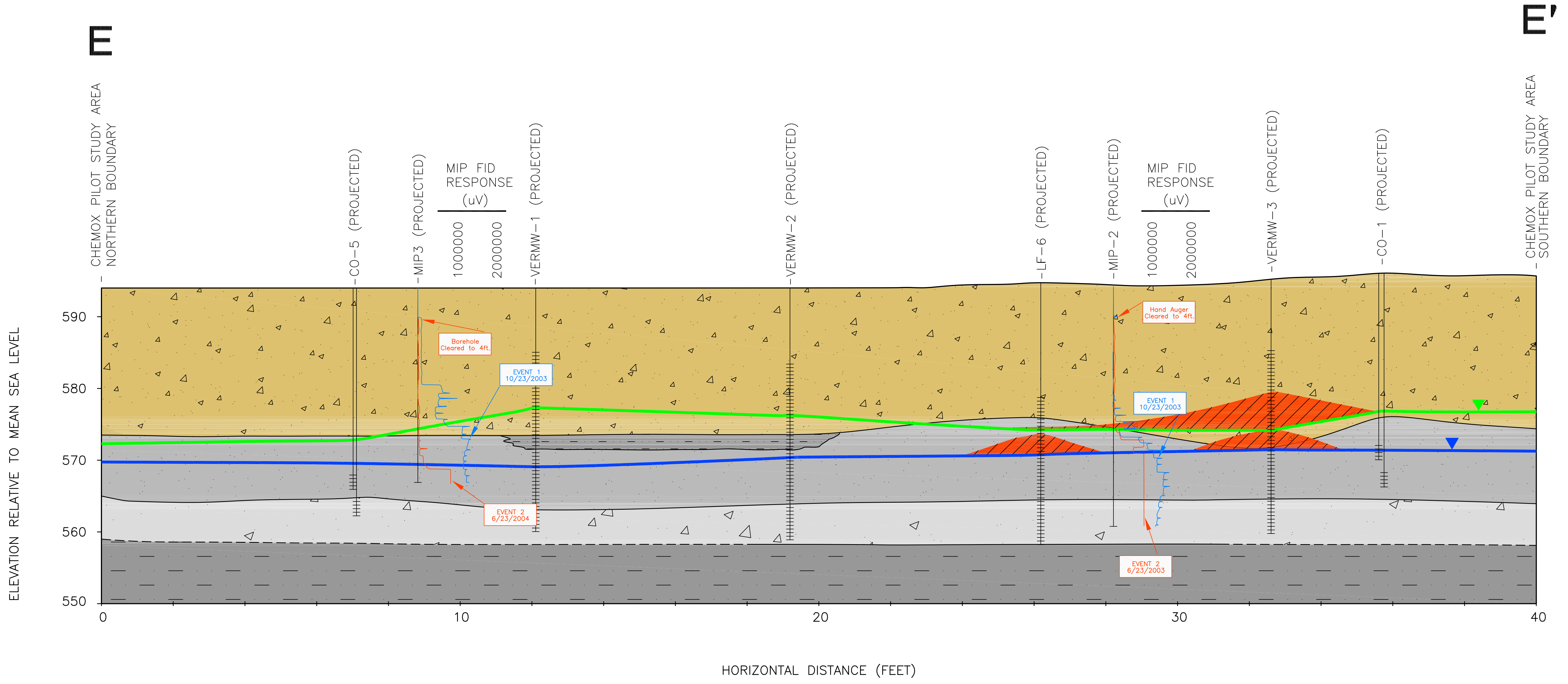
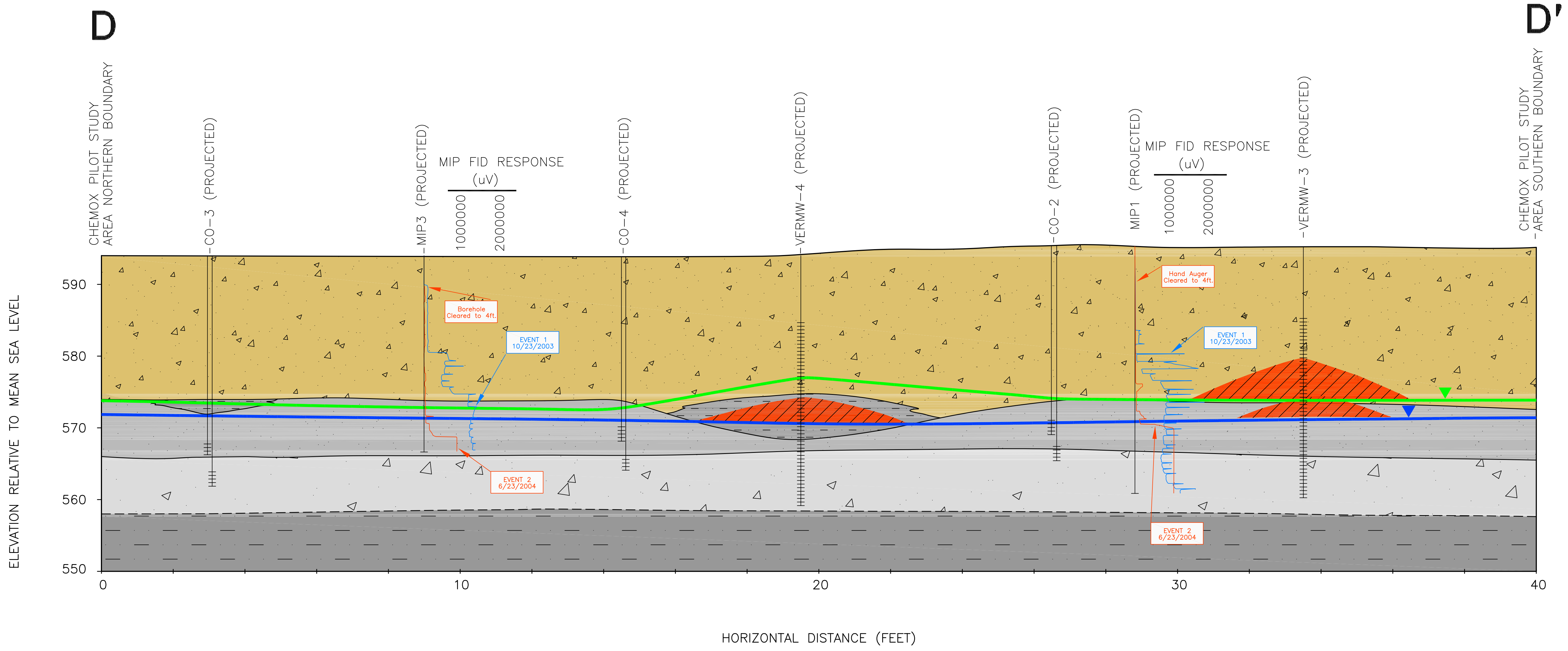

- LEGEND**
- LOWEST WATER-TABLE ELEVATION IN FEET ABOVE MEAN SEA LEVEL
 - HIGHEST WATER-TABLE ELEVATION IN FEET ABOVE MEAN SEA LEVEL
 - INDICATES MONITORING WELL SCREENED INTERVAL
 - INDICATES MIP LOCATION
 - FILL MATERIAL CONSISTING OF BLACK CINDERS, CONCRETE, BRICK, GLASS, SLAG, WOOD, SILT, GRAVEL AND SAND
 - ALLUVIAL DEPOSITS (SAND, SAND AND SILT, SAND AND GRAVEL, SILTY SAND, SILT)
 - ALLUVIAL DEPOSITS (SAND AND GRAVEL)
 - CLAY (INCLUDES CLAY AND SILT AND CLAY)
 - APPARENT THICKNESS OF SEPARATE PHASE PRODUCT OBSERVED IN MONITORING WELLS

- NOTES:**
1. FOR LOCATION OF SECTION LINES SEE PLATE 1.
 2. LAND SURFACE SHOWN IS ALONG THE SECTION CUT LINE, NOT NECESSARILY AT THE WELL/BORING LOCATIONS IF WELL/BORING IS PROJECTED ONTO THE LINE.
 3. LINES SEPARATING CLAY LAYER FROM SAND AND GRAVEL LAYER ARE SHOWN DASHED WHERE INFERRED.
 4. DEPTH TO THE LOWER CLAY LAYER IS BASED ON DATA FROM LF-6 AND OTHER WELLS OUTSIDE THE PILOT TEST AREA BOUNDARIES.
 5. MIP FID RESPONSE DURING EVENT 1 (10/23/2003) AND IMMEDIATELY AFTER THE PILOT TEST (EVENT 2 ON 6/23/2004) IS SHOWN AS MICRO VOLTS (uV) ON A SCALE FROM 0 TO 2,000,000 uV.
 6. DATES FOR THICKEST SEPARATE PHASE PRODUCT OBSERVED VARY.

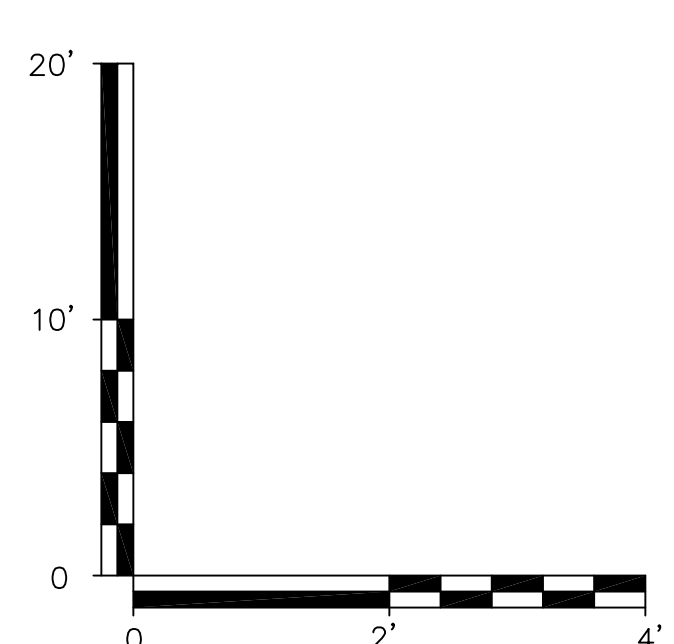

GENERALIZED HYDROGEOLOGIC CROSS SECTIONS D-D', E-E' AND F-F' WITH HIGHEST AND LOWEST WATER TABLE ELEVATIONS AND CORRESPONDING SEPARATE PHASE PRODUCT THICKNESS
 BUFFALO TERMINAL, BUFFALO, NEW YORK

Prepared For: **EXXONMOBIL OIL CORPORATION**

	Compiled by: N.C.	Date: 25AUG04	PLATE
	Prepared by: R.K.	Scale: AS SHOWN	
	Project Mgr: N.C.	Office: NY	
	File No: MC5224105	Project: 17252Y06	

3

N:\PROJECTS\MCT72F\MCS241\17252Y06.DWG

D

D'

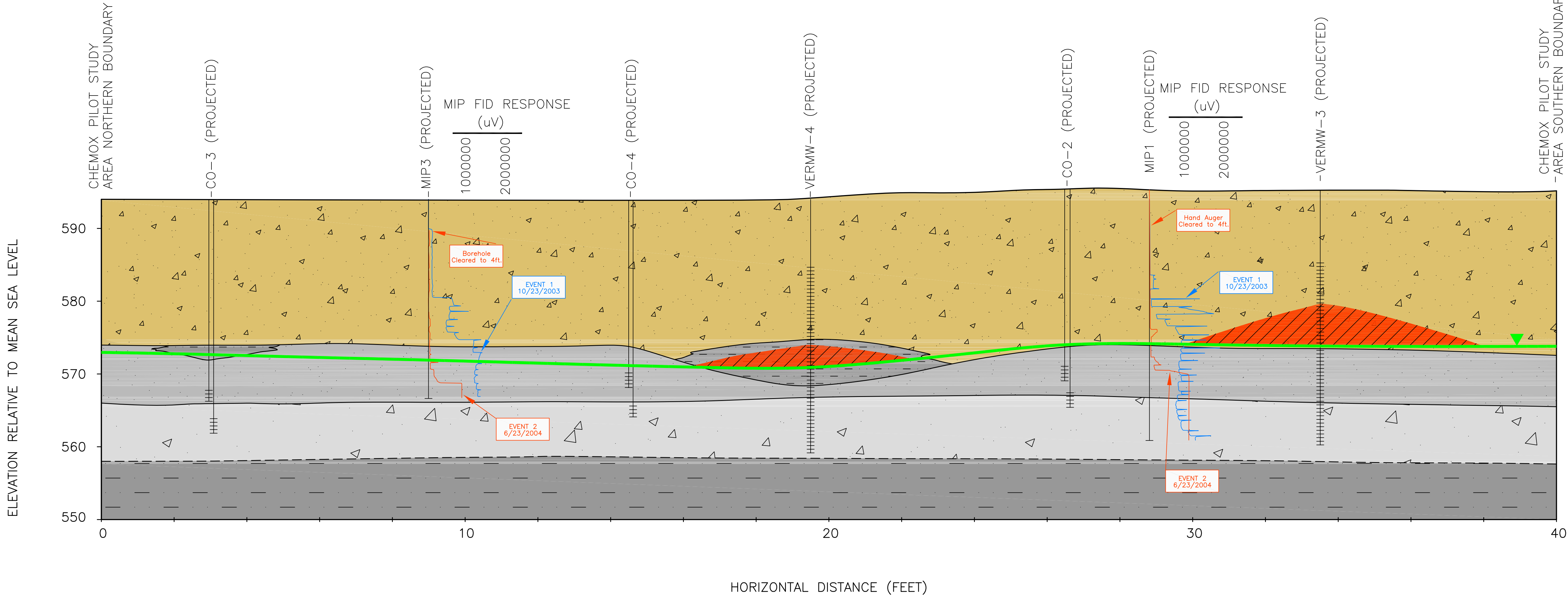

E

E'

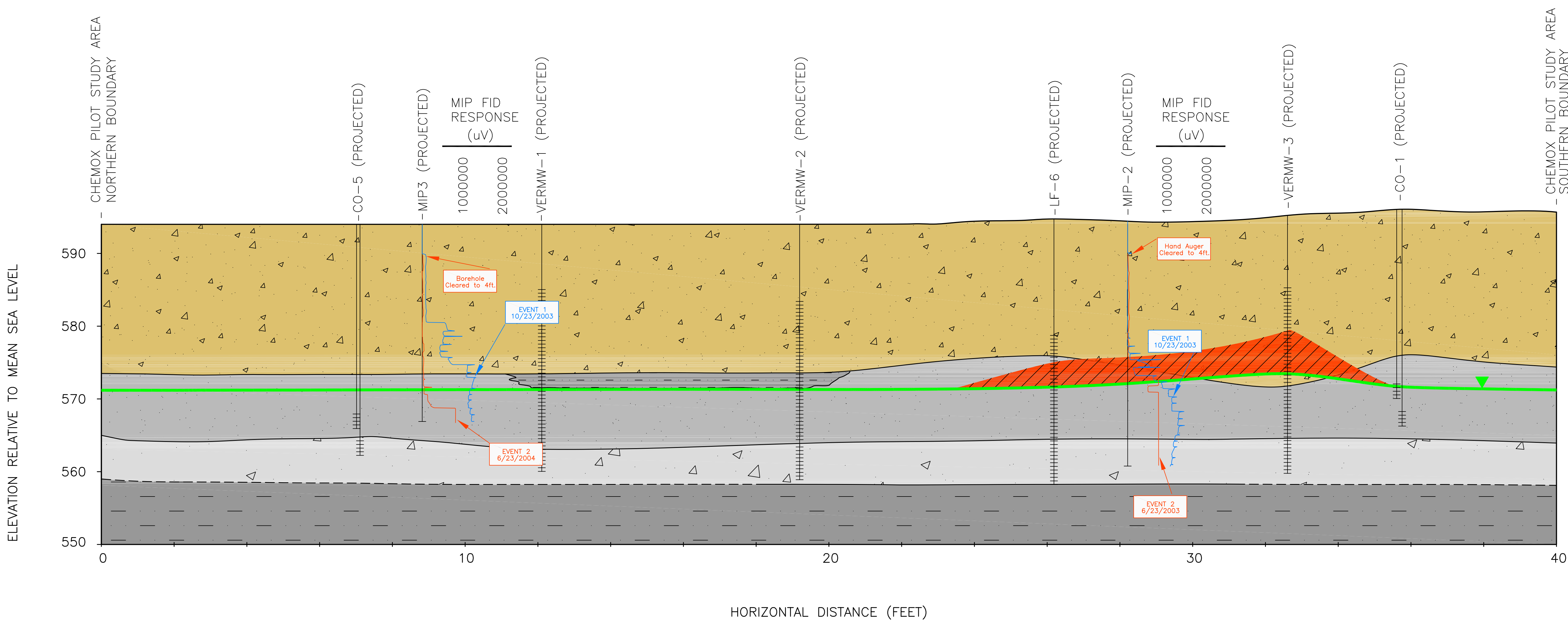

F

F'

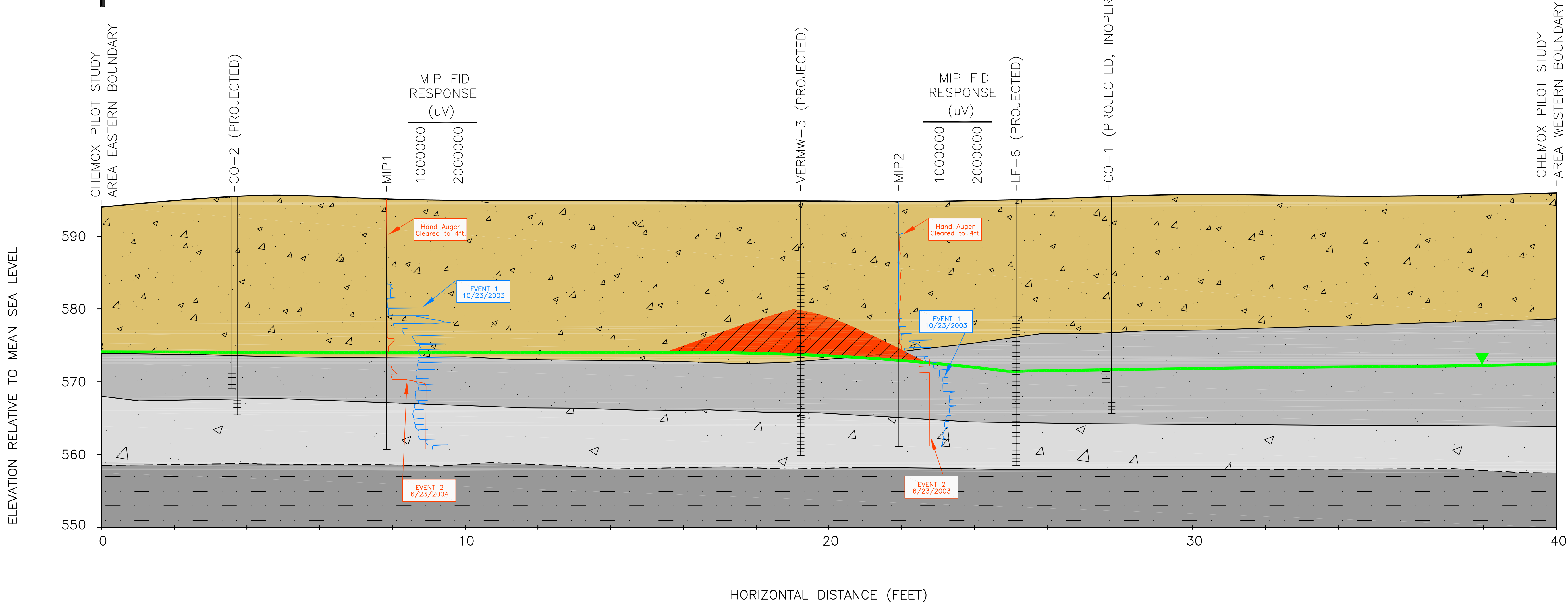

LEGEND

- WATER-TABLE ELEVATION IN FEET ABOVE MEAN SEA LEVEL
- INDICATES MONITORING WELL SCREENED INTERVAL
- INDICATES MIP LOCATION
- FILL MATERIAL CONSISTING OF BLACK CINDERS, CONCRETE, BRICK, GLASS, SLAG, WOOD, SILT, GRAVEL AND SAND
- ALLUVIAL DEPOSITS (SAND, SAND AND SILT, SAND AND GRAVEL, SILTY SAND, SILT)
- ALLUVIAL DEPOSITS (SAND AND GRAVEL)
- CLAY (INCLUDES CLAY AND SILT AND CLAY)
- APPARENT THICKNESS OF SEPARATE PHASE PRODUCT OBSERVED IN MONITORING WELLS

NOTES:

1. FOR LOCATION OF SECTION LINES SEE PLATE 1.
2. LAND SURFACE SHOWN IS ALONG THE SECTION CUT LINE, NOT NECESSARILY AT THE WELL/BORING LOCATIONS IF WELL/BORING IS PROJECTED ONTO THE LINE.
3. LINES SEPARATING CLAY LAYER FROM SAND AND GRAVEL LAYER ARE SHOWN DASHED WHERE INFERRED.
4. DEPTH TO THE LOWER CLAY LAYER IS BASED ON DATA FROM LF-6 AND OTHER WELLS OUTSIDE THE PILOT TEST AREA BOUNDARIES.
5. MIP FID RESPONSE DURING EVENT 1 (10/23/2003) AND IMMEDIATELY AFTER THE PILOT TEST (EVENT 2 ON 6/23/2004) IS SHOWN AS MICRO VOLTS (uV) ON A SCALE FROM 0 TO 2,000,000 uV.
6. DATES FOR THICKEST SEPARATE PHASE PRODUCT OBSERVED VARY.

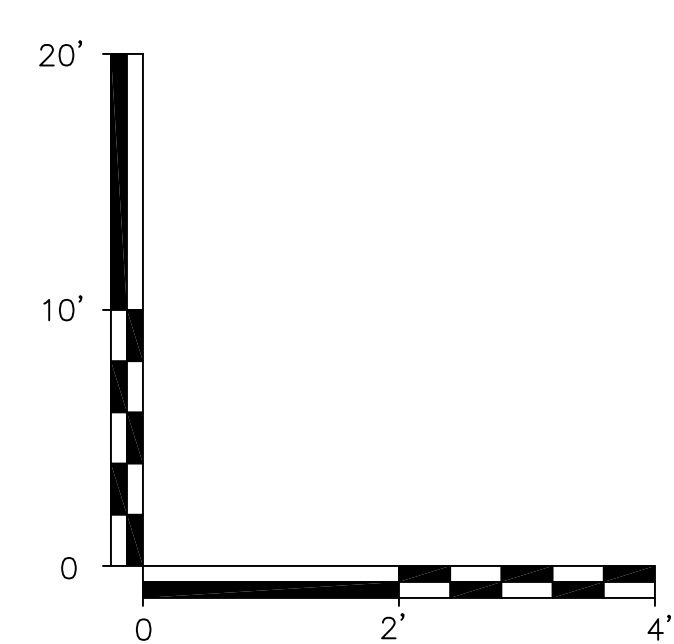

Title: **GENERALIZED HYDROGEOLOGIC CROSS SECTIONS D-D', E-E' AND F-F' WITH WATER TABLE ELEVATIONS CORRESPONDING TO THICKEST OBSERVED APPARENT PRODUCT THICKNESS**
 BUFFALO TERMINAL, BUFFALO, NEW YORK

Prepared For: **EXXONMOBIL OIL CORPORATION**

	Compiled by: N.C.	Date: 25AUG04	PLATE
	Prepared by: R.K.	Scale: AS SHOWN	
ROUX ASSOCIATES, INC. <i>Environmental Consulting & Management</i>	Project Mgr: N.C.	Office: NY	4
File No: MC5224106	Project: 17252Y06		

N:\PROJECTS\MCT\27\M25241\241\M25241106.DWG