

TECHNICAL
RESOURCE MATERIAL

TRANSPORT AND STORAGE VESSELS

NOTES

Transport and Storage Vessels

GUIDANCE SUMMARY-AT-A-GLANCE

- # When you arrive at the scene of an incident involving a transport or storage vessel, one of your first concerns will be the need to control the release or fire. Even so, **it is not your responsibility (nor are you equipped) to perform the hands-on emergency response activities needed to physically control the release or fire.** Instead, you will be there to ensure that the appropriate first responders are at the scene and that they are adequately protected to perform their work safely. We have included some common sense guidelines for what to look for when approaching and working on the scene of a leaking or burning transport or storage vessel. **This manual is not, however, a substitute for proper training and experience in conducting first-response actions for fires, leaks, or spills involving transport and storage vessels.**

- # While BSPR personnel are not to attempt to control a release or fire themselves, it is still important that you have some knowledge of how these actions are performed properly for different types of transport and storage vessels. Enough information has been provided in this section for you to understand the basic features of transportation and storage vessels. Refer to the materials and illustrations provided and note the locations of valves and other connections where leaks can occur.

- # The U.S. Department of Transportation (USDOT) has strict regulations governing the transport of hazardous materials. These regulations can help you, as a spill responder, identify the various types of transport vessels that you may encounter and the materials they may carry. These regulations appear in the Code of Federal Regulations (CFR), Title 49.

- # Incidents involving aircraft or air cargo are rare, but possible, and the types of hazardous materials potentially present could be virtually unlimited. More common are spills from airport bulk fuel storage tanks (located either above and/or below ground), fuel pipelines, and the tanker trucks that carry gasoline, aviation fuels, and various additives. Note that for spills that occur at Kennedy International Airport and La Guardia Airport, the U.S. Coast Guard 3rd District has federal jurisdiction at these locations since these airports are located in coastal areas.

- # Spills from barges and other marine vessels into waterways are more likely than on-board spills. Spills at waterfront and marine terminals will most likely occur during transfer operations as barges and ships load and/or off-load their materials. Bulk storage areas at marine terminals may also be

NOTES

GUIDANCE SUMMARY-AT-A-GLANCE (continued)

the source of a spill. Recognize that the U.S. Coast Guard (USCG) has jurisdiction over incidents involving spills on navigable waters and at waterfront terminals as well as special knowledge and experience to deal with marine incidents; you should coordinate your response with them.

- # Emergency incidents along railways may involve liquid, gaseous, or bulk solid spills from freight cars, rail tank cars, or locomotives. A spill may involve a wide variety of hazardous materials and petroleum products carried by rail as well as the fuels, oils, and lubricants used in operating the rail equipment. Federal or State DOT rail safety inspection personnel are usually on the scene and available to offer assistance. **The initial inspection of a derailed or damaged tank car should be performed by experienced railroad personnel only.** The dome and bottom valves of the tank car are the most likely areas to leak.

- # Releases from trucks transporting bulk and containerized petroleum products and hazardous materials over the highway are common. Normally, the first responders to a truck accident will be the local fire department, medical personnel, and local or state police. Coordinate response actions with these agencies, but **remember you do not have first-response responsibility.** Identify the material by obtaining the shipping papers and checking the placarding and the truck specification information. Consult the cargo tank manufacturer, shipper, carrier, and/or the chemical manufacturer if additional information is necessary during an emergency response.

- # A wide variety of petroleum and hazardous material products are stored in both underground and aboveground storage tanks at various temperatures and pressures. An equally diverse number of facilities can own and operate anywhere from one to many hundreds of tanks ranging in size capacity from 100 gallons to millions of gallons. Valves, hoses, connections, pipelines, and the tanks themselves can leak both liquid and gaseous products to the air, to surface waters, to the ground, and to the subsurface. These facilities may be located in rural, urban, or industrial settings and may be located near waterways. You may find, therefore, that releases associated with storage vessels present the largest diversity of situations to investigate and remedy.

- # Cylinders containing liquified or non-liquified compressed gases may be involved in incidents. Cylinders can leak or fail due to stresses caused by impact, heat, corrosion, abuse, or other means. When leaking or stressed, the cylinders become extremely dangerous because of their pressurized contents and the inherent chemical and/or physical hazards of the material. It is, therefore, important that BSPR personnel learn about cylinder design, markings, and associated hazards and how to handle incidents involving cylinders.

NOTES

3.2 Transport and Storage Vessels

Oil and hazardous materials are transported throughout New York State by various modes of transportation, including railcars, trucks, ships, aircraft, and through pipelines. Therefore, you may respond to an oil or hazardous material incident at an airport terminal, along a railroad line, in or adjacent to a river, at a fuel storage facility, or on the highway. The guidance material in this section has been developed to help familiarize BSPR personnel with the types and features of different transport and storage vessels.

1. There Are Limits to Your Responsibilities

When you arrive at the incident scene, your first concern will often be to control the release of oil or hazardous material from the transport or storage vessel. Even so, **it is not your responsibility (nor are you equipped) to perform the hands-on emergency spill response activities needed to physically control the release or fire** (i.e., do not place yourself in a hazardous situation). You are there to ensure that the right people (i.e., those properly trained and equipped) are called upon to control the release or fire, that they are adequately protected to perform their work safely, and that appropriate decisions are made regarding clean-up operations. If these individuals were hired by the state, you are responsible for supervising their efforts. Otherwise, your role is limited to consulting with the response agency who hired these individuals or who is conducting the work with their own personnel.

Remember, BSPR personnel should not attempt to control a leak from a damaged or stressed container. It is still important, however, that you have knowledge of proper responses to spills and leaks from the different types of transport and storage vessels. Enough information has been provided in this subsection for you to understand the basic features of railcars, tank trucks, and containers that carry and store different types of hazardous materials. We have also included some common sense guidelines for what to look for when approaching and working at the scene of spill or leak from a transport or storage vessel. **This manual is not, however, a substitute for proper training and experience in conducting first-response actions for fires, leaks, or spills involving transport and storage vessels.**

2. Transportation of Hazardous Materials

The U.S. Department of Transportation (USDOT) and New York State have strict regulations governing the transport of petroleum products and hazardous materials. In part, these regulations make it possible for you, as a spill responder, to identify the type of transport vessel involved in an incident and what substance it may carry.

The New York Code of Rules and Regulations, Title 7, Part 507, addresses the transportation of hazardous materials. The regulation states, basically, that New York has adopted by reference the 1987 version of Title 49 (Transportation) of the Code of Federal Regulations, Parts 171-179, Parts 390-393, and Parts 396-397. Thus, the State regulations are identical to these particular federal

NOTES

regulations. Exhibit 3.2-1 provides a listing of the titles of these specific regulations. Review these regulations to understand placarding, labeling, and other requirements for transporting petroleum and hazardous material products. Brief descriptions of some of these requirements are provided in the subsections that follow.

3. Types of Transport Vessels

a. Aircraft

Spills and leaks involving aircraft or air cargo are rare, but such incidents are possible.¹ The types of hazardous materials potentially present as cargo are virtually unlimited. Approach each spill or leak investigation/response with caution until you are sure of the type of material involved and the nature of the threat to human health and the environment. Spills and leaks in the cargo areas may involve drums and various types of other containers holding petroleum and chemical products and sometimes hazardous wastes. Check the markings and labels for identification of the containerized materials, but **remember that the labels may not be correct.**

More common at airports are spills associated with the fuel storage and distribution systems. Most airports have bulk fuel storage tank farms (located either above and/or below ground), fuel pipelines, and tanker trucks that carry gasoline, aviation fuels, and various additives. You may encounter, therefore, spills in sumps, overflow from containment areas, leaks from pump seals and other pipeline equipment, tank leaks, and leaks from quick-disconnect couplers.

Note that for oil or hazardous material spills at Kennedy International Airport and La Guardia Airport, the U.S. Coast Guard 3rd District has federal jurisdiction at these locations since these airports are located in coastal areas. If you respond to a spill at these airports, coordinate your response with the On-Scene Coordinator from the U.S. Coast Guard. At other airports located in New York State, your role is expanded, as NYSDEC will likely be the lead agency. Coordinate your response with on-scene airport personnel, local firefighters, local officials, and state and local police. The U.S. Environmental Protection Agency (EPA) will exercise its federal jurisdiction if requested.

¹ The USDOT regulations (Sections 175.1 through 175.705) govern the transport of hazardous materials by aircraft. In addition, airport operations and aircraft are regulated by the National Transportation Safety Board (NTSB) and the Federal Aviation Administration (FAA).

Exhibit 3.2-1

U.S. DOT Regulations Title 49 -- Relevant Hazardous Material and Safety Regulations

Subchapter C - Hazardous Material Regulations

Part 171	General Information, Regulations, and Definitions
Part 172	Hazardous Materials Tables and Hazardous Materials Communication Regulations
Part 173	Shippers - General Requirements for Shipments and Packaging
Part 174	Carriage by Rail
Part 175	Carriage by Aircraft
Part 176	Carriage by Vessel
Part 177	Carriage by Public Highway
Part 178	Shipping Container Specifications

Federal Motor Carrier Safety Regulations

Subpart 390	Federal Motor Carrier Safety Regulations: General
-------------	---

See the following Appendices for more detailed information:

Appendix R	Hazardous Materials Definitions
Appendix S	Hazardous Materials Warning Placards
Appendix T	Guide for Markings
Appendix U	Hazardous Materials Shipping Papers
Appendix V	DOT Specification Cylinders Shipping Containers

NOTES

b. Marine Vessels and Terminals

Marine vessels include barges and ocean-going vessels.² Types of barges include open-hopper, covered dry cargo, tank barge, and independent pressure tank barges. Ocean-going vessels include tankers, liquified natural gas (LNG) carriers, ocean-going barges, container ships and roll-on/roll-off vessels. Attachment 3.2-3 illustrates typical layouts of barges and sea-going tankers. Spills from these vessels into waterways are more likely than on-board spills.

Spills at shore-based or near-shore waterfront and marine terminals happen during transfer operations as barges and ships load and off-load their materials. Bulk storage areas associated with the overall operation of the terminal may also be the source of a spill. Most spills at loading and unloading terminals are caused as a result of barge, tanker, and storage tank overfills. Spills also occur from hose quick connect/disconnect coupling operations, as a result of damaged loading/unloading connections or when valves are left open.

Be aware that inclement weather can make a spill cleanup at a waterfront shipping terminal or on a waterway virtually impossible. Heavy rains, high winds or tides, fog, and freezing temperatures can cause a spill to spread quickly or to overtop the containment structure, or may just make the clean-up operation very difficult on equipment and personnel.

Recognize that the U.S. Coast Guard (USCG) has jurisdiction over incidents involving spills on navigable waters and at waterfront terminals. The USCG also has special knowledge and experience to deal with marine spill incidents; you should coordinate your response with them. Their jurisdiction, as well as that of EPA is authorized under the National Oil and Hazardous Substances Pollution Contingency Plan (NCP). The NCP implements the response powers and responsibilities created by the Comprehensive Environmental Response, Compensation, and Liability Act (CERCLA) and the authorities established by section 311 of the Federal Water Pollution Control Act, Public Law 92-500. The NCP is in effect for discharges or substantial threats of discharges of oil to or upon the navigable waters of the United States and adjoining shorelines, for the contiguous zone, and the high seas.³ While the NCP was developed to direct federal agencies, it also calls for the division and specification of

² *Transportation of hazardous materials by vessel must comply with the regulations in 49 CFR and in the International Maritime Organizations' Dangerous Goods Code. Materials loaded on vessels must be segregated according to the "Segregation and Separation Chart of Hazardous Materials" presented in 49 CFR 176.83. These regulations contain additional information on shipping and marine terminal facilities that may be of help to you. The U.S. Coast Guard regulates oil transfer procedures under the "Oil Pollution Prevention Regulations," 33 CFR, Sections 155, 156, and 157. Section 155.720, "Regulations for Vessels," provides information on procedures and plans required by vessels in the event of an oil spill.*

³ *Beyond the contiguous zone, the Outer Continental Shelf Lands Act or the Deepwater Port Act of 1974 also pertain.*

NOTES

responsibilities among the federal, state, and local governments in response actions, and defines appropriate roles for private entities. Therefore, as a state spill response agency, BSPR has responsibilities under the NCP. Become familiar with the NCP, our involvement through the Regional Response Team, and Section 311 of the Clean Water Act.

c. Railcars

Emergency response incidents along railways may involve leaks, spills or fires involving liquid, gaseous, or bulk solid materials from freight cars, rail tank cars, or locomotives. An incident may involve a wide variety of hazardous materials and petroleum products carried by rail as well as the fuels, oils, battery acids, and lubricants used in operating the rail equipment (e.g., diesel locomotives carry several thousand gallons of fuel). Releases can occur as the result of fuel line/hose ruptures, leaks in transport tanks or piping systems, or as a result of rail accidents where loaded railcars have been punctured or derailed. The derailment of railcars loaded with hazardous materials represents a significant potential for large releases.

There are both state regulations and federal regulations (49 CFR, Subpart 174) covering the transport of materials by rail that describe both carrier and shipper responsibilities. Through an examination of the specification markings required by these regulations, BSPR personnel can identify the type of rail car involved in an incident and determine the car's contents. These markings provide precise information concerning the class designation, tank test pressure, the material of construction, separator character, type of weld, car features (i.e., fittings, linings, etc.), and authorizing agency.

The class or specification marking is found stencilled on the right side of the car, generally above the wheel sets. There are several tank car classes: non-pressure tank cars; pressure tank cars for chemicals such as chlorine, sulfur dioxide, liquefied petroleum gases, and anhydrous ammonia; and cryogenic liquid tank cars. Attachment 3.2-1 (at the end of this section) provides diagrams of several different types of common rail tank cars. Note the location of valves and fittings where leaks can occur.

Although tanks cars often present the greatest potential for large-scale incidents, other types of railcars also carry hazardous materials. These include box cars, hopper cars, and high pressure tank cars. The latter resembles an open-sided box car with cross bracing that is used for transporting tube-shaped high pressure (3500-5000 psi) gas cylinders. The car is the rail equivalent of the compressed gas trailer used on highways and holds 25 to 30 seamless steel cylinders that are permanently attached to the car.[1]

Box cars can carry a wide variety of containerized or packaged hazardous materials. Some cars may carry several classes of hazardous materials at the same time; a "Dangerous" placard may be displayed as an indication.

NOTES

Although relatively few are in service, there also exists a "boxed tank type (XT)" cryogenic liquid tank car. The car is, basically, a cryogenic tank and jacket secured within a box car. Covered hopper cars are also used by the railroad industry to transport bulk solids such as fertilizers and dry caustic soda.[2]

Exercise extreme caution when approaching the scene of a railcar/release and in moving around the site. There can be many potential chemical hazards and fire, explosive, and other physical hazards. As with all releases, **stay upwind and keep a safe distance away from the site.** Avoid low-lying areas where vapors can accumulate and reach explosive or life-threatening levels. Stay away from pools of liquid as they may contain hazardous substances such as strong acids or bases. Bring along adequate portable lighting as the site may be located in a remote area without a power source.

The **initial inspection of the derailed or damaged tank car itself should be performed by experienced railroad personnel only.** Federal or state rail safety personnel are also generally available at the scene to evaluate the condition of rail equipment. They will check for dents, cracks, and punctures, and evaluate many complex factors affecting the structural integrity of tanker cars. They can evaluate the stability of the tank cars after an accident. Techniques have been developed by the railroad industry to evaluate failure conditions, scores and gouges, wheel and rail burns, and temperature conditions. You should defer to their experience and remain at a safe distance from the leaking/spilled products.

Railroad personnel will inspect the railcar to determine where the leak has occurred. If the car or tanker is partially embedded in the ground or otherwise unexposed, it may take some time to assess the situation, especially if close visual inspection is not possible. The dome and bottom valves of the tank car are the most likely areas to leak, but there are numerous other fittings that should also be inspected for signs of leaks.

Investigating the situation from a distance may be necessary depending on the severity of the incident, the chemical involved, the projected time frame for cleanup, and the proximity of the incident site to area populations. Aerial photography can be reviewed to determine if the cars are dented, to identify hot spots, twisting, and bulging, and to check conditions of external valving, piping, and appurtenances that are not buried.

Realize that this initial inspection is very important. An incorrect assessment of the situation may mean placing people at risk. It is better to take the time to investigate the situation thoroughly.

For additional information regarding railcar design, operation, and identification, consult the following references:

NOTES

- # *GATX Tank Car Manual*, Fifth Edition, General American Transportation Corporation, Chicago, Illinois, 1985.
- # *Understanding Railroad Tank Cars*, Union Pacific Railroad, 1987.
- # *Guide to the Identification of Tank Cars and Fittings Utilized for the Transportation of Hazardous Materials*, Bureau of Explosives, Washington, D.C., 1985.
- # *Manual of Standards and Recommended Practices*, Section C-Part III, Specifications for Tank Cars, Association of American Railroads, Washington, D.C., 1982.
- # *Tank Car Bank*, Union Tank Car Company, Chicago, Illinois.

d. Tanker and Other Cargo Trucks

Spills and leaks from tanker trucks transporting petroleum and hazardous materials over the highway are common. These trucks, like railcars, can carry many different kinds of petroleum and chemical products presenting an equally diverse number of health and safety hazards for the spill responder. Spills/leaks can occur as a result of flow valves breaking or cracking in an accident, cracks and pinhole leaks in the welds and seams of the bulkhead, problems in the operation of gate valves on the cargo tanks, or any of several other problems.

Normally, the first responders to a truck accident will be the local fire department, emergency medical personnel, and local or state police. Coordinate response actions with these agencies, but **remember you do not have first-response responsibility**. Identify the released material by interviewing the driver, obtaining the shipping papers, and checking the placarding and the truck specification information, as applicable. (See Appendices R, S, T, and U for information and explanations on placards, labels, container markings, shipping papers, etc.) Remember the visible placarding may be incorrect. Consult the shipper, the carrier, the chemical manufacturer, and/or CHEMTREC if additional information is necessary during an emergency response.

Attachment 3.2-2 illustrates some of the different types of tanker and other trucks that carry petroleum and other hazardous materials. Note the locations of valves and other connections where leaks can occur.

Cargo Tankers and Trailers

There are several types of cargo tank trucks for transporting hazardous products. All cargo tank trucks must have a certificate indicating that the cargo tank has been designed, constructed, and tested in accordance with the applicable specifications. A Manufacturer's Certificate (MC) is issued

NOTES

and signed by the manufacturer of the cargo tank. Exhibit 3.2-2 provides brief descriptions of the different types of cargo tanks and their appropriate MC Specification Numbers. In addition, Attachment 3.2-2 provides diagrams of several of the cargo trucks. Review Section 177 in the USDOT regulations (49 CFR Subpart 177) for more information. Federal and state regulations also cover the requirements for general shipping papers; driver, carrier, and shipper responsibilities; and the requirements for the loading of materials, marking them, and placarding the vehicle for shipment.

Tractor-Trailers/Furniture Vans

Tractor-trailer or furniture van type trucks are normally about 45 feet in length. They can carry a wide variety of hazardous materials in drums or boxes. Approach the scene of a tractor-trailer accident with caution. Take special care when entering the interiors of these trucks as vapors may have accumulated to explosive and/or life-threatening concentrations. Federal and state regulations describe shipping container specifications and testing procedures for a wide variety of packing materials and containers that may be transported in these types of trailers. Refer to 49 CFR 173 and 49 CFR 178 for further information.

Semi and Straight Truck Vans

Semi and straight truck vans range in size from 12 to 22 feet. They may carry drums or boxes of hazardous materials or mixed (i.e., hazardous and non-hazardous) freight. Shippers are required to provide certain packaging and to label packages of hazardous materials under certain circumstances. Be aware that placards are not required for "Limited Quantity" shipments (generally less than 1,000 pounds) and, in many instances, packages shipped as "Limited Quantity" may not have a label. Keep in mind, however, that any transport vehicle carrying any quantity of materials that meet the criteria of the following USDOT hazard classes must be placarded: Class A Explosives, Class B Explosives, Poison A, Flammable Solid, Radioactive Materials. Under most circumstances, however, the shipping

Exhibit 3.2-2

Cargo Tanker Profiles (by MC Specification Number)

MC 306

These cargo tanks are certified to carry liquids that are transported at atmospheric pressure such as flammable and combustible liquids (e.g., gasoline, jet fuel, diesel fuel, methanol, ethyl alcohol) and Class B Poisons. The tanks are usually single-shell and constructed of aluminum. They have an oval/elliptical cross-section and generally carry up to 9,000 gallons of product. The tanks have overturn protection that serves to protect the fittings and valves on the top of the cargo tank in the event of a rollover accident. A fusible vent is designed to melt at a predetermined temperature, thereby permitting closure of the product discharge valve (internal valve). Also, a baffle system within the cargo tank compartment reduces the surge of the liquid contents and provides circumferential reinforcement. These tanks also have an internal shutoff valve near the gate valves, a manhole assembly to access the tank, and rear-end protection.

MC 307

These cargo tanks are certified to carry chemicals that are transported at low pressure (3-25 psi) such as flammable liquids, combustible liquids, mild corrosives, etc. The tanks are normally of double-shell construction with insulation. They usually have a round cross-section, one or two compartments, and generally carry up to 7,000 gallons of product. The 307 tanker includes the same safety features as the MC 306.

MC 312

These cargo tanks are certified to carry strong corrosive materials such as sulfuric acid. The tanks usually have a circular cross-section and are smaller in diameter than the MC 307. They may also have double-shell construction. The MC 312 tanker normally has a 6,000-gallon capacity. These tanks include many of the safety features mentioned above for MC 306 and MC 307 tanks plus a rupture disk and external ring stiffeners that are welded to the tank to increase its strength. They also have an outlet shutoff valve on the top of the tank and a bottom washout chamber for cleaning and decontamination purposes.

MC 331

These cargo tanks are built to carry compressed gases, including flammable gases such as propane, butane, and liquified petroleum gas, as well as non-flammable gases such as anhydrous ammonia. The tanks are single-shell, non-insulated, and have rounded ends and a circular cross-section. The MC 331 has a capacity ranging between 2,500 and 11,500 gallons, and the upper two-thirds of the tank is painted with a reflective color (usually white). These types of cargo tanks have remote shutoff valves at both ends of the tank, internal shutoff valves, a rotary gauge to determine product pressure, and two top-mounted vents.

Exhibit 3.2-2

Cargo Tanker Profiles (continued)

MC 338

These cargo tanks are built to carry cryogenic liquids such as liquid oxygen, liquid nitrogen, liquid argon, etc. They are well insulated (designed much like a thermos bottle, with double shells), and have flat ends and relief valves. A refrigeration unit is located at the rear of the trailer to cool the tank's contents to well below 0°F.

Compressed Gas Trailer

These trailers are designed to hold cylinders that are stacked and manifolded together, the manifold being at the rear of the trailer. The cylinders store gases with pressures ranging from 3,000-5,000 psi, such as hydrogen, nitrogen, etc.

Note: On occasion, BSPR personnel may run across older models of some of the above tanker trucks. These older models (i.e., MC 300-305, MC 310, MC 311, and MC 330) were built prior to 1968; therefore, there should be few of these on the highways.

NOTES

papers carried by the driver should be your best source of information on the contents of the shipped freight. The driver should also know what he or she is transporting. If neither the driver nor the shipping papers are available, try to contact the shipper for information or assume the materials are extremely dangerous until determined otherwise.

Refrigerated Box Trailers

Chemicals with low flash points are often transported in refrigerated box trailers. Organic peroxides, for example, which have flash points near ambient temperature, are usually transported by refrigerated box trailers. Should the refrigeration unit malfunction, these chemicals can decompose, resulting in fire or explosion. Evacuation may be necessary in cases where hazardous materials are released into the atmosphere.

For additional information regarding truck design and identification, consult the following references:

- # *Transportation of Hazardous Materials*, Office of Technology Assessment, Washington, D.C., 1986.
- # *Hazardous Materials: Managing the Incident*, Noll, Hildebrand, and Yvorra, Fire Protection Publications, Oklahoma State University, Stillwater, Oklahoma, 1988.
- # *Handling Hazardous Materials*, American Trucking Association, Department of Safety.
- # *Transporting Hazardous Waste*, American Trucking Association.
- # *Federal Motor Carrier Safety Regulations*, ATA.

4. Storage Tanks

A wide variety of petroleum and hazardous material products are stored in both underground and aboveground storage tanks at various temperatures and pressures. An equally diverse number of facilities can own and operate anywhere from one to many hundreds of tanks ranging in size capacity from just a few hundred to millions of gallons. Valves, hoses, connections, pipelines, and the tanks themselves can leak both liquid and gaseous products to the air, to surface waters, to the ground surface, and to the subsurface. These facilities may be located in rural, urban, or industrial settings and may be located very near waterways. You may find, therefore, that storage tank releases present a diverse number of situations to investigate and remedy.

NOTES

a. Aboveground Storage Tanks

What to look for when responding to an aboveground tank release depends on the tank's construction, as well as its size and shape, the contents of the tank, the size of the release, whether there was a containment structure surrounding the tank, and the nature and features of the surrounding area. The contents of the tank may be indicated by markings such as the chemical name stenciled on the tank or symbols associated with the NFPA 704 or Military marking systems. Spills and leaks from aboveground storage tanks can occur when tanks are overfilled accidentally, when seams and welds rupture, and when the tank walls or valves crack or develop pinhole leaks due to corrosion or because of some fault in the tank materials. Pumps and their associated connecting pipe joints and fittings can also crack, break, or wear out. Leaks from compressed gas tanks can occur due to overfill, cracks, corrosion, open valves, faulty valves, rupture, etc. Leaks may occur in piping as well as in the tanks themselves. Exhibit 3.2-3 discusses, in greater detail, the types of leaks that can occur.

Aboveground storage tanks for liquids are found at most commercial and industrial sites, including airports, marine terminals, and other transportation facilities. Aboveground storage tanks are placed vertically on the ground or horizontally on steel or concrete pilings. They range in size capacity from 100 gallons up to 1,000,000 gallons at some of the larger petroleum bulk storage facilities. Aboveground storage tanks have several standard features. Larger tanks will have platforms, ladders, and stairways. There will be a fill pipe, some type of liquid-level indicator to measure the amount of material in the tank, and an overflow connection. Vent standpipes to regulate pressure changes caused by uneven heating of liquids in the tank are standard. There will be a pipeline outlet connection, either to transfer material from one storage tank to another or to a tanker truck or railcar. Usually a manhole is located on the top or side of the tank to allow easy access for repair work or for cleaning out solids or sludge remaining in the tank.

Drain pipes are usually located at the base of most aboveground tanks. All aboveground liquid storage tanks should have primary and secondary containment as a spill control measure. Containment may consist of berms, dikes, and concrete containment walls and sumps.

Most aboveground liquid storage tanks fall into two broad categories: atmospheric and low-pressure tanks. Atmospheric tanks are designed to operate at atmospheric pressure. Within these tanks, the gas or vapor phase above the liquid phase in the tank is pressurized from atmospheric to approximately 0.5 pounds per square inch (psig). Atmospheric tanks are often constructed of carbon or alloy steel (especially if installed before 1960) and are either of welded or bolted construction.

Exhibit 3.2-3

**Types of Leaks from Bulk Storage
and Handling Facilities**

Bulk Storage Facilities - Tank Farms and Tankage

1. Leaks and overfilling of tanks
2. Rupture of tanks
3. Leaks in pipe, valves and fittings
4. Leaks in containment dikes
5. Inadequate dike volume to hold contents of leaking tanks
6. Product flow from dike area through open dike valve
7. Leaks from pump seals and maintenance
8. Level instrument failure allowing tank overfilling
9. Piping damage by collision with mobile equipment
10. Spills from water drawoff from storage tanks
11. Spills from tank bottom cleanout and sludge disposal
12. Improper disposal of samples
13. Overflow of wastewater treatment systems by rainfall flooding
14. Poor maintenance of pipe, valves and fittings
15. Plugging of drainage system by debris
16. Wastewater treatment systems with insufficient capacity to remove product
17. Inadequate secondary containment devices
18. Spills from line flushing
19. Spills from pipe and tankage changes
20. Possible sabotage
21. Improper installation

Bulk Handling Facilities - Terminals, Pipelines

1. Spills from quick-connect coupling operation
2. Overfilling tank trucks, tank cars, barges, tankers, etc.
3. Lack of curbs, drains and spill collection system
4. Improper operation of product water separators
5. Leaks from loading arms, especially joints and gaskets
6. Leaks from underground storage tanks
7. Improper disposal of sludge from product filters
8. Insufficient sump capacity (should be equal to volume of largest compartment of tank truck or rail car)
9. Leaks from damaged loading connections
10. Operators incorrectly setting loading meters and tanks overfilling
11. Level instrument and subsequent sump pump failure on oil sumps
12. Leaks from heating coils in heavy fuel tanks
13. Possible sabotage
14. Improper installation

Source: Technology for the Storage of Hazardous Liquids: A State-of-the-Art Review, New York State Department of Environmental Conservation, Revised, March 1985.

NOTES

You may encounter the older riveted type tanks, as well. Other construction materials include fiberglass-reinforced plastic (FRP) or a variety of olefin plastics such as polyvinyl chloride (PVC) and polypropylene. Atmospheric tanks are used for the storage of low-level volatile materials such as crude oils, heavy oils, furnace oils, naphtha, and gasoline.

Low-pressure storage tanks are designed to operate at pressures in excess of atmospheric pressure, but not exceeding 15 psig. Low-pressure tanks are used to store liquid chemicals that have higher vapor pressures such as some gasoline blending stock, light naphtha, and pentane.

Aboveground storage tanks for storing liquified and non-liquified compressed gases and cryogenic liquids are also found at most commercial and industrial facilities that manufacture, use, store, or handle hazardous materials. Tanks that store these materials are designed and built for high pressures. There are three standard types of high-pressure tanks.

The high-pressure horizontal tank is usually a single shell, non-insulated tank with rounded ends. Its size capacity can vary from 1,000 to cover 30,000 gallons, and it is painted in a reflective color such as white. The tank can store liquid petroleum gases, anhydrous ammonia, and flammable liquids with high vapor pressures.[3]

The high-pressure spherical storage tank is a single shell, non-insulated tank used for storing liquid petroleum gases. It is painted a reflective color such as white and may hold up to 600,000 gallons.[3]

The cryogenic liquid storage tank has an insulated "thermos bottle" type design for storing extremely cold liquids such as liquid oxygen, liquid nitrogen, liquid carbon dioxide, etc. These tanks have capacities up to 400,000 gallons and above. They are primarily found at hospitals, gas-processing facilities, and industrial sites.[3]

High-pressure storage tanks can develop leaks within their tank walls, fill pipes, valves, piping systems, tank connections, and appurtenances. The chemical hazards associated with the leaking product will present dangers to response personnel as will the physical hazards such as the high-pressure gases, flammability, extreme cold, etc. associated with these products.

Exhibit 3.2-4 presents a list of different types of tanks, and Exhibits 3.2-5 and 3.2-6 illustrate some of the various types of aboveground tanks. As a general rule, tanks less than 12 to 15 feet in diameter are shop-fabricated; those tanks larger than 15 feet in diameter were usually built on site. Bulk storage tanks may have several compartments for storing different liquids, or they may be double-walled with the outer wall acting as secondary containment. Exhibits 3.2-7 and 3.2-8 illustrate

Exhibit 3.2-4

Types of Storage Tanks

Atmospheric Tanks	Low-Pressure Tanks	High-Pressure Tanks
Coned-roof	Horizontal cylindrical	Horizontal (with rounded ends)
Domed-roof	Hemispheroidal	Spheroidal
Floating-roof # Open # Open with geodesic dome # Covered	Spheroidal	Cryogenic liquid
Breather-roof	Noded hemispheroidal	
Lifter-roof	Noded spheroidal	

Sources: *Technology for the Storage of Hazardous Liquids - A State-of-the-Art Review*. New York State Department of Environmental Conservation, Division of Water, Bureau of Water Resources. January 1983.

Hazardous Materials: Managing the Incident, Noll, Hildebrand, and Yvorra, Fire Protection Publications, Oklahoma State University, Stillwater, Oklahoma, 1988, pp. 65 and 66.

Exhibit 3.2-5

Types of Atmospheric and Low-Pressure Tanks

(graphic)

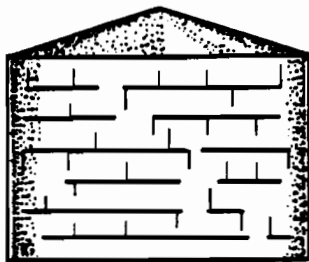

CONED ROOF TANK

- Simplest type of atmospheric tank
- Usually large, field-erected structure; can reach 300 feet in diameter and 64 feet in height
- Used for storage of liquids with low volatility

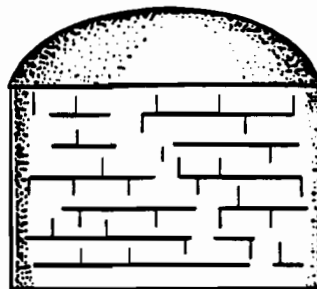

HEMISPHEROID TANK

- Low pressure tank
- Usually large, field-erected structure
- Used for storage of volatile liquids

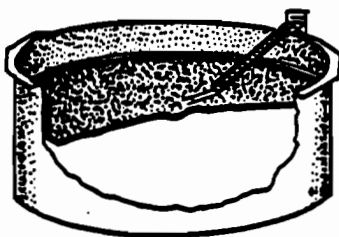

FLOATING ROOF TANK

- Atmospheric tank
- Usually large, field-erected structure
- Designed to reduce evaporation losses and increase protection from fire



CYLINDRICAL TANK

- Low pressure tank
- Usually shop-erected and thus restricted to transportable sizes (e.g. 11-12 feet in diameter and 60 feet in length)

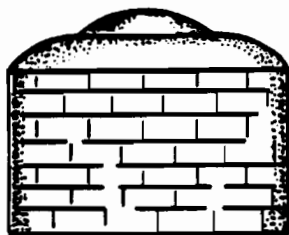

NODED HEMISPHEROID TANK

- Low pressure tank
- Usually field erected structure
- Used for storage of volatile liquids

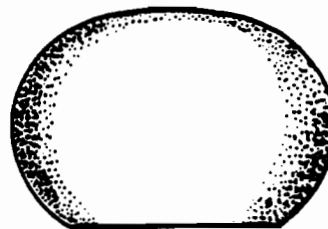

SPHEROID TANK

- Low pressure tank
- Usually large, field-erected structure, can reach 90 feet in diameter
- Used for storage of volatile liquids under pressure

Source: Technology for the Storage of Hazardous Liquids - A State-of-the-Art Review, New York State Department of Environmental Conservation, Revised, March 1985.

Exhibit 3.2-6

TYPES OF HIGH PRESSURE STORAGE TANKS

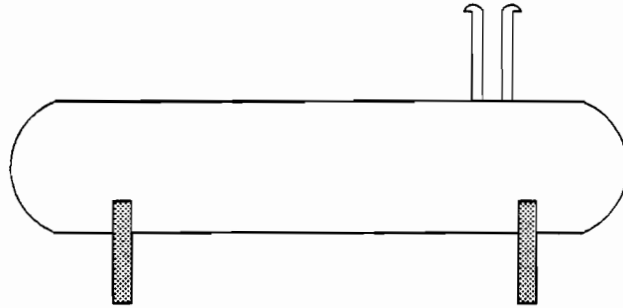

**HIGH PRESSURE
HORIZONTAL TANK**

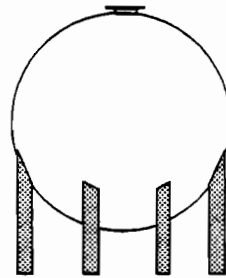

**HIGH PRESSURE
SPHERICAL STORAGE TANK**

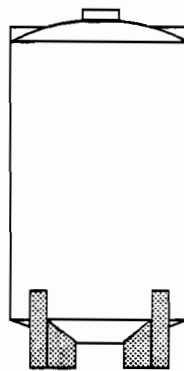

**CRYOGENIC LIQUID
STORAGE TANK**

Exhibit 3.2-7

insert graphics - Selected Components of an Aboveground Storage Facility

This figure shows some of the components of an aboveground storage facility. In this case, the product is assumed to be a petroleum derivative. The product recovery system and contaminated runoff treatment system are therefore presented as a slop tank and a gravity separation tank respectively. The items shown in the tank truck loading rack area include:

- ① curb and runoff collection ditch, ② impervious surface, such as concrete sandwiched around an impermeable synthetic membrane, ③ a product collection sump for tank cleanout and rapidly recovered spills, ④ tank truck, ⑤ truck loading arms, ⑥ contaminated runoff conveyance line (to separation tank or other treatment system), and ⑦ vehicle access ramp.

The items shown in the storage tank area include:

- ⑧ storage tanks, ⑨ manways, ⑩ level detection devices connected to a high level alarm, ⑪ fill lines, ⑫ product draw-off lines, ⑬ product pump for conveyance to loading area, ⑭ tank water draw-off (cleanout) lines directed to small separation tank, ⑮ separation tank for storage tank cleanout, ⑯ cleanout separation tank water discharge, ⑰ product recovery line from cleanout separation tank, ⑱ dike around storage area, ⑲ spill and runoff collection ditch, ⑳ collection sump, ㉑ impervious floor in storage area and on dike wall, ㉒ vehicle access ramp.

Other items shown include the following:

- ㉓ facility separation tank, ㉔ contaminated runoff line leading separation tank, ㉕ separation tank water discharge line, ㉖ product recovery line leading to slop tank from loading rack area, ㉗ slop tank, ㉘ slop tank water draw-off pump, ㉙ flop tank product recovery pump.

— Please note that this figure is not drawn to scale —

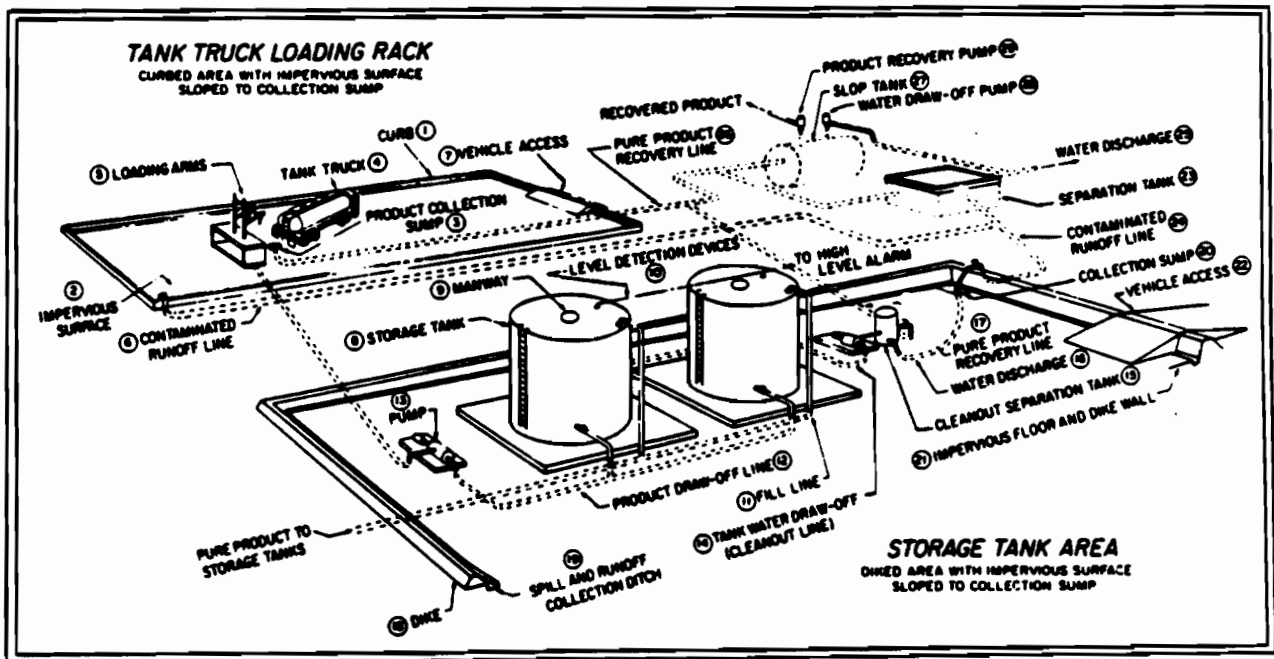

Source: Technology for the Storage of Hazardous Liquids - A State-of-the-Art Review, New York State Department of Environmental Conservation, Revised, March 1985.

Exhibit 3.2-8

Aboveground Tank Connections

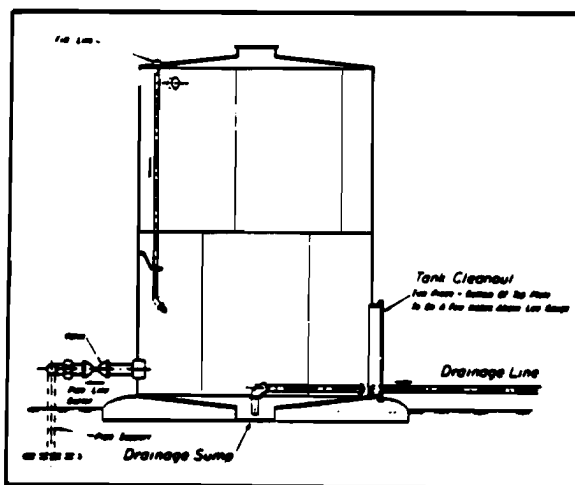

a) Side view showing the fill connection, pipe line outlet connection, drain connection, drainage sump, and tank cleanout.

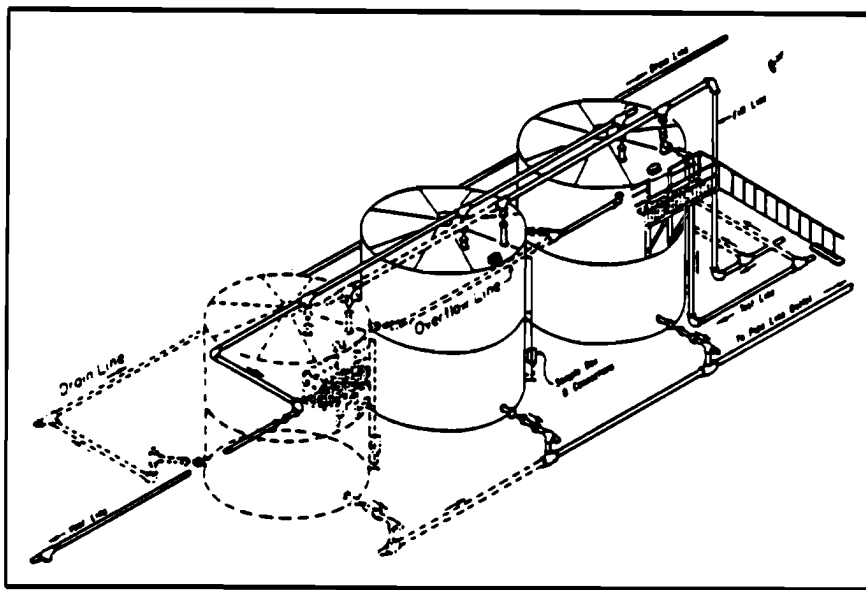

b) Perspective drawing showing the fill connection, pipe line outlet connection, drain connection, overflow connection, and vent connection.

Source: API RP 12Ra. *API Recommended Practices for Setting, Connecting, Maintenance and Operation of Lease Tanks*. 1981.

Source: Technology for the Storage of Hazardous Liquids: A State-of-the-Art Review, New York State Department of Environmental Conservation, Revised, March 1985.

various components of aboveground storage tanks, while Exhibit 3.2-9 presents characteristics of the various types of aboveground storage tanks.

b. Underground Storage Tanks

Leaks and spills from underground storage tank (UST) systems (i.e., the tank and piping) represent a growing fraction of the workload for the spill response program. Any tank that has at least 10 percent of its volume below ground, inclusive of piping, is considered an underground storage tank.⁴ An underground tank system may, therefore, have a considerable portion of the tank and/or piping system located aboveground; you should remember to check both the above- and belowground portions of the UST system for leaks. Exhibit 3.2-10 is an illustration of a typical underground storage tank installation, featuring a cylindrical tank. Exhibit 3.2-11 shows a spherical-shaped fiberglass-reinforced plastic tank.

The majority of underground storage tanks, especially tanks ten years or older, are made of bare steel or carbon steel. Unless these tanks have been protected against the effects of corrosion, these older tanks are the most likely to leak. This is not a hard-and-fast rule, however, as even new tanks can leak if installation was poor. In addition, studies and surveys sponsored by EPA have shown that it is often the piping system and not the tank itself that is the source of the release. Again, poor installation practices are a major cause, but corrosion and movement of the piping joints (due to settlement of backfill, frost upheaval, truck and traffic loading on poorly protected piping) are other significant causes of leaks from piping. Areas in piping where leaks are common include the elbows, couplings, and joints. You can find more information on UST systems and the causes of leaks in the preamble to both the proposed (April 17, 1987) and the final (September 23, 1988) federal UST rules. Exhibit 3.2-12 presents characteristics of various types of underground storage tanks.

The type of pumping system for product delivery is also a factor in the size of release if there is a leak in the piping. There are two basic types of pumping systems: remote pressurized pumping systems and suction pumping systems.

Remote pressurized pumping systems employ submerged, explosion-proof, centrifugal pumps and are found immersed in the product storage tank. They pressurize the product delivery line (positive pressure) and move the product or chemical to the aboveground dispenser. Remote pumping systems are usually

⁴ In Region 1, especially in New York City, the fire department had, at one time, required that tanks be partially buried as a preventative measure to decrease the chance of a major fire. These tanks were called "mounded tanks." Mounded tanks should be treated in the same manner as you would treat an underground tank.

Exhibit 3.2-9
Characteristics of Various Types of Aboveground Storage Tanks

Type of Tank	Pressure Service	Resistance to Corrosive Attack	Protective Coatings and Linings	Relative Costs	Remarks
	(atm and or pressure)	(chemical compatibility)			
Carbon steel (bolted)	Atmospheric	Compatible with petroleum products and caustic soda but not compatible with mineral and oxidizing acids such as dilute sulfuric acid and concentrated hydrochloric, phosphoric or nitric acids.	Coatings and linings may be applied for corrosion resistance to both the tank and its support foundation.	Low	Tanks may be horizontal or vertical and are generally large. Vertical tanks require concrete pads and horizontal tanks are generally mounted on steel or concrete saddles.
Carbon steel (welded)	Atmospheric and low pressure	Same as above.	Same as above.	Low	Smaller shop-assembled tanks are generally welded. Newer low-pressure tanks are welded.
Stainless steel	Atmospheric and low pressure	Better corrosion resistance than carbon steel, depending on grade.	Generally not used.	Medium to high depending on grade of steel.	Stainless steel is used in lieu of coatings when the temperature of the liquid store exceeds 200°F. Stainless steel is also used in storage situations where product purity is important, such as in the food industry.
Fiberglass-reinforced plastic	Atmospheric low-pressure tanks available as special orders from some manufacturers.	Compatible with a wide range of organic and inorganic chemicals.	Not required.	Comparable to coated steel.	Fiberglass tanks have high corrosion resistance but, lack the structural strength, performance at elevated temperatures (above 200°F), or impact resistance of steel tanks. Available in capacities of 400-33,000 gallons. OSHA regulations prohibit the use of FRP for above-ground storage of flammable or combustible liquids.
Plastic	Atmospheric	Varies depending on the type of plastic.	Not applicable.	Low	Plastic materials include polyethylene, polypropylene, polyvinylchloride (PVC), and acrylonitrile butadiene styrene polymers (ABS). While these materials are used to manufacture portable and process tanks under 3000 gallons, they are generally not used for bulk storage tanks because of their low structural strength. OSHA regulations prohibit the use of plastic for aboveground storage of flammable or combustible liquids.
Concrete	Atmospheric	Subject to deterioration by corrosive chemicals.	Coatings may be applied for corrosion resistance to both interior and exterior of tank.	High	Concrete tanks are generally not used for the storage of petroleum and chemical products.
Aluminum	Atmospheric and low-pressure	High resistance to atmospheric conditions, industrial fumes and vapors, and fresh, brackish or salt water. Attacked by mineral acids, but can be used with concentrated nitric acid (above 82%) and sulfuric acid (99%). Cannot be used with strong caustic solutions. Compatible with most organic acids.	Coatings may be applied to both interior and exterior of tank for chemical resistance. Bonding coatings to aluminum is difficult.	Low	Aluminum tanks lack the structural strength of steel. Aluminum rapidly loses its structural strength at temperatures above 300°F. Aluminum retains its structural strength well at low temperatures; it can be used down to -420°F.

Source: Technology for the Storage of Hazardous Liquids: A State-of-the-Art Review, New York State Department of Environmental Conservation, Revised, March 1985.

Exhibit 3.2-10

Elements of an Underground Storage Tank Installation

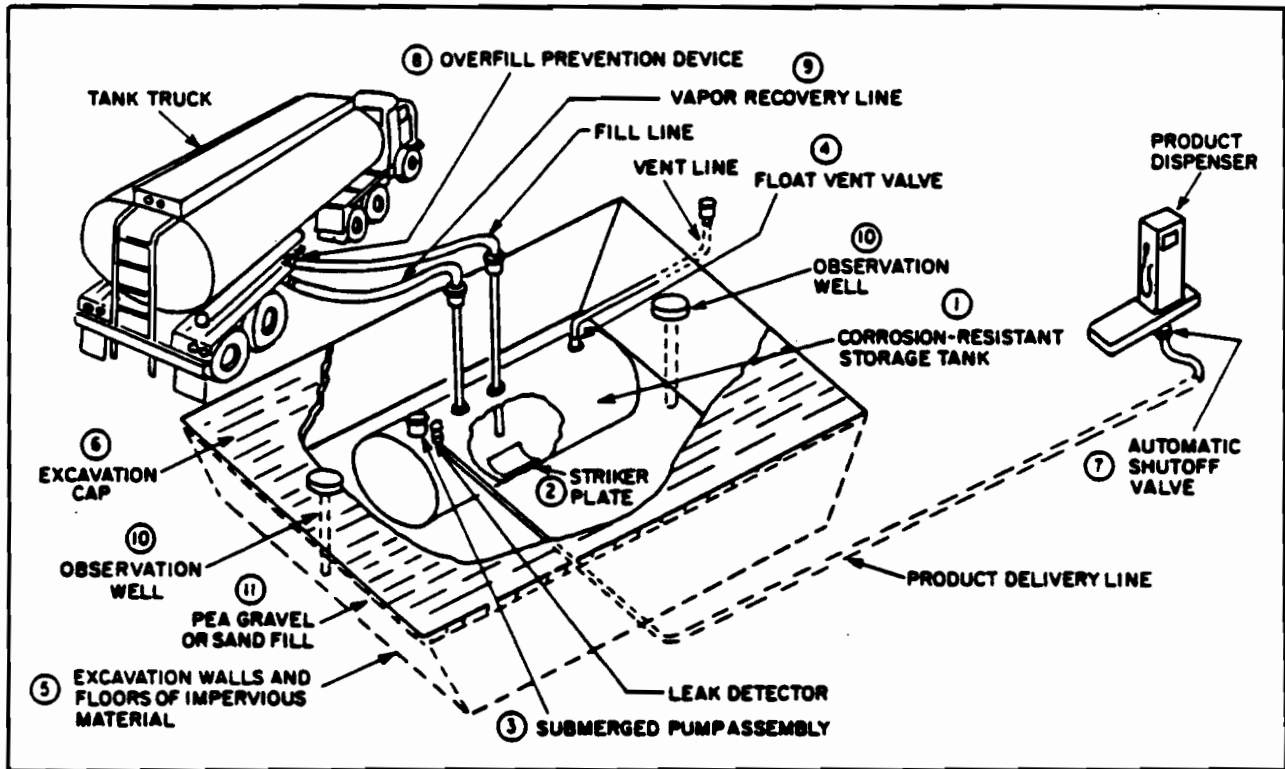

Well designed underground storage systems usually contain the following:

- 1) corrosion resistant tank; 2) striker plate under tank fill line; 3) submerged pump with leak detector on product delivery line; 4) float vent valve in tank vent line; 5) excavation walls and floor of impervious material; 6) asphalt or concrete excavation cap; 7) automatic shutoff valve on delivery line at pump island; 8) overfill prevention device at fill line on tank truck; 9) vapor recovery in tank truck during filling operation; 10) observation wells located inside excavation boundaries; 11) pea gravel or sand fill for excavation.
- These are all important aspects of a good underground storage system.

Source: Technology for the Storage of Hazardous Liquids - A State-of-the-Art Review, New York State Department of Environmental Conservation, Revised, March 1985.

Exhibit 3.2-11

Fiberglass-Reinforced Plastic Double-Walled Tank with Built-In Leak Detection

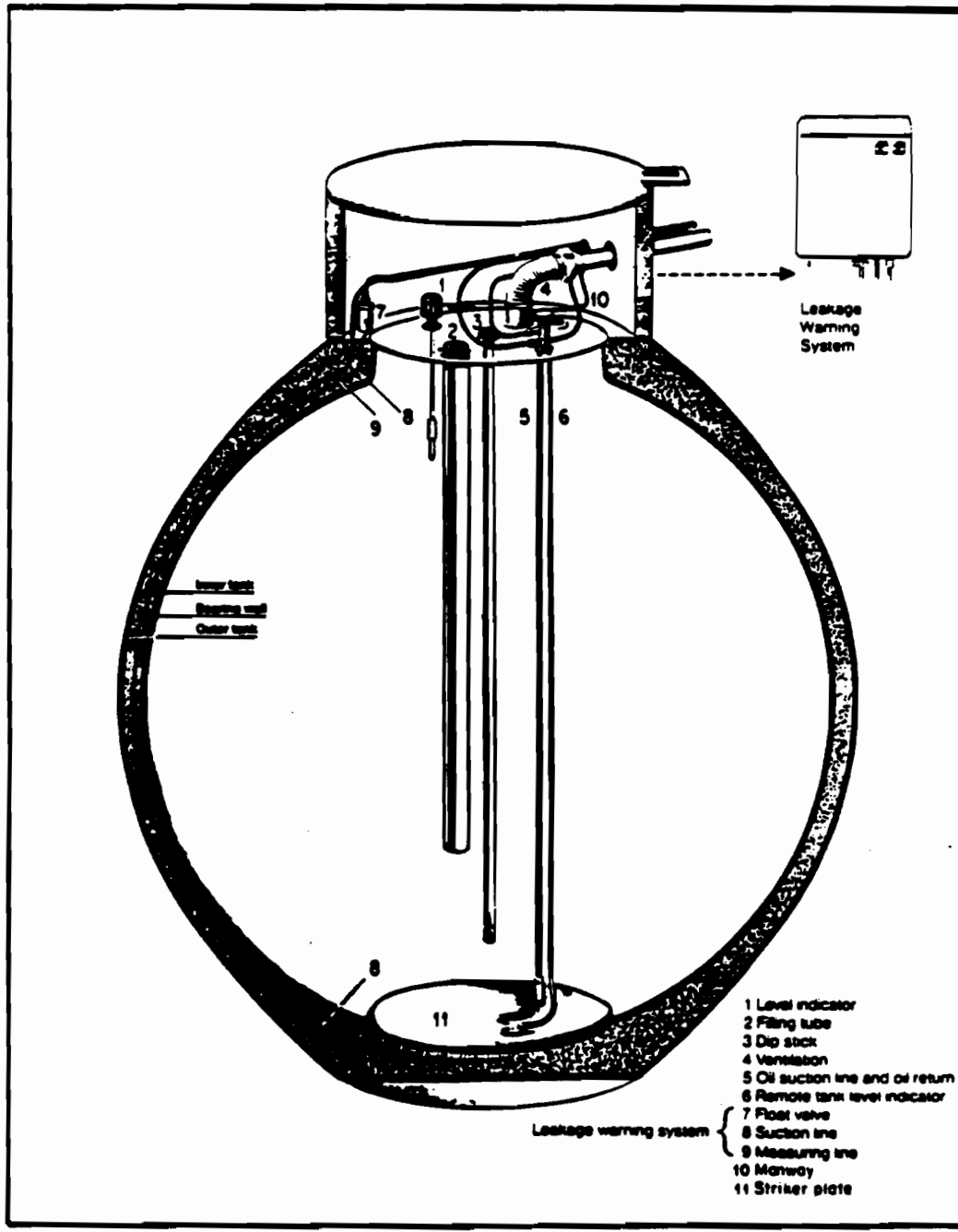

Source: Betco Associates

Source: Technology for the Storage of Hazardous Liquids: A State-of-the-Art Review, New York State Department of Environmental Conservation, Revised, March 1985.

Exhibit 3.2-12

Characteristics of Underground Storage Tanks

Characteristics of Underground Storage Tanks						
Type	Description	Applications*	Types of Soil Suitable	Major Causes of Leaks	Relative Costs	Remarks (advantages and disadvantages)
Bare steel	Carbon steel	Compatible with fuels and a number of other chemical products. Not compatible with corrosive liquids such as acids.	Not compatible with corrosive soil.	Corrosion	Low	Fifty percent of the bare steel tanks leak after 15 years. Life expectancy is dependent on soil corrosivity and method of installation.
Coated/lined steel	Carbon steel with exterior coating and/or interior lining.	Generally compatible with corrosive chemicals such as alkalis and organic and inorganic acids if internal lining is applied.	Generally compatible with corrosive soil if external coating is applied.	Corrosion due to defects in coating or lining.	Low	Coating lining must be properly applied and free of defects (holidays). The effectiveness of the coating/lining will vary with the type of coating. Internal lining can increase life span of tanks.
Pre-engineered cathodically protected steel tanks-galvanic protection (e.g. St-P) and B-10 tanks)	Steel tank with pre-engineered corrosion protection consisting of sacrificial anodes, protective coating and electrical isolation.	Compatible with gasoline, diesel fuel, kerosene, bunker oil and a number of other chemical products.	Can withstand corrosion in soils with resistivities greater than 2000 ohm-cm (26).	Internal corrosion	Medium	Life expectancy of these tanks is difficult to predict but the record for the fifteen years that the tank has been available is impressive.
Cathodically protected steel tanks-impressed current	Steel tanks to which a constant supply of electric current is applied.	Petroleum products and a number of other chemical products.	Will withstand highly corrosive soil if properly designed.	Internal corrosion	Medium	Good life expectancy if the cathodic protection is properly maintained.
Vaulted tank	Tanks are installed in concrete vaults to provide secondary containment of leaks. Vaults sometimes have interior coatings and external polyethylene wrapper to prevent permeation through concrete.	Frequently used for secondary containment of highly hazardous chemicals.	Generally resistant to soil corrosion.	Low risk of leaks	High	Poorly designed concrete vaults are susceptible to cracking and chemical attack by salts and acids. Porosity of concrete is a problem.

**Exhibit 3.2-12
(continued)**

Characteristics of Underground Storage Tanks

Impermeable liners	Involves the use of an impermeable liner as secondary containment in the tank excavation. Examples include membrane, clay, and bentonite liner.	See Part II, Chapter 4	See Part II, Chapter 4	Low risk of leaks	Medium	Care must be taken to insure that lining material is compatible with stored material. Should include a leak detection system within the confines of the liner containment area.
Relined tanks	Existing steel tank relined with corrosion resistant material.	Petroleum products and corrosive chemicals. Used to extend the lifespan of underground tanks.	Bare steel tanks with interior liners will continue to corrode in corrosive soil.	Defects in lining	Low	Condition of the tank is a key consideration. It is important that the relining material be compatible with the material to be stored and that workmanship be according to the API standards.
Fiberglass reinforced plastic (FRP)	Plastic resins reinforced with glass fiber.	Petroleum and a number of other chemical products.	Suitable in highly corrosive soils.	Tank rupture	Medium	FRP tanks cannot withstand loads as does steel and may easily be damaged if dropped, mishandled or subjected to excessive loads because of improper installation.
FRP/steel	Outer FRP layer fused to an inner layer of steel by a polyester resin bond.	Petroleum products and a number of other chemical products.	Resistance to soil corrosion is comparable to that of fiberglass tanks.	Low risk of leaks, but tank is susceptible to internal corrosion.	Medium	Combines strength of steel with corrosion resistance of fiberglass.
Double-walled	Tank within a tank with a vacuum or pressurized space between the inner and outer walls. Currently manufactured double-walled tanks are composed of either steel (with coating and galvanic cathodic protection on outer wall) or FRP.	Applications are dependent upon the materials of construction. See descriptions of FRP and coated, galvanically protected steel tanks above.	Suitable in highly corrosive soils, depending on the materials of construction.	Low risk of leaks	High	Some models only available in capacities up to 4000 gallons. These tanks usually include a built-in leak detection system located between the inner and outer walls.

Source: Technology for the Storage of Hazardous Liquids: A State-of-the-Art Review, New York State Department of Environmental Conservation, Revised, March 1986.

NOTES

more efficient than the suction pumping systems and can service several dispensers simultaneously. However, a major drawback with this system is that the pressures employed for pumping out the product can easily overcome even quite a large leak in the delivery lines. Therefore, a leak or crack in the piping can go undetected for some time since there is no interference with the product flow. The result is often a large loss of product before the leak is discovered, especially if inventory monitoring is performed infrequently. Another problem with remote pumps that can lead to product loss is the failure of O-ring seals.

Suction pumping systems employ pumps located at a dispenser unit to draw liquid out of the underground storage tank(s). These systems are used less frequently today as remote pumping systems have become more sophisticated. From a release detection standpoint, however, suction pumps have a built-in leak detection feature. If there is a break or even a small leak in the transfer line, the pump will experience a loss of prime and will sputter, hesitate, or not work at all. These operating problems are often quickly (but not always) noticed before much product is lost to the subsurface. Exhibit 3.2-13 illustrates piping systems and associated pumps for underground storage tanks.

Overfilling an underground tank also leads to both surface and subsurface spills unless there are overfill prevention and spill containment measures taken. Leaks and spills can also be caused by improper connections and handling of product transfer, leaks at joints or fittings, rupture of the hose due to excessive internal pressures, and abrasive wear. You will find that many surface spills are the result of problems with the transfer hoses.

Determining which of these situations -- tank leak, piping leak, or overfill - - has occurred and where it has occurred, however, can be a tough task for a spill responder (except in cases of obvious overfills). Often, the spill itself is not visible or detectable without considerable effort, i.e., it is below ground. Other times you may have visible or otherwise detectable evidence of the spill and its effects (e.g., vapors in a homeowner's basement, free product in a sewer line, or petroleum odors in tapwater), but you are faced with multiple potential sources of the spill and/or considerable backtracking to isolate the source. UST spills, therefore, can require more sophisticated investigation methods to isolate the location and extent of the spill. Cooperation from the potential spiller(s) is key in order to review inventory records and/or conduct tightness tests of the tank and piping or to allow you access to the site to do the same to pinpoint the probable source. Recognize that inventory monitoring and tank tightness methods, even when they are employed properly, can still misidentify an UST system as a non-leaker (and, in some cases, as a leaker). On occasion, a positive determination of the likely source can only be obtained by excavating down to the UST system to be

Exhibit 3.2-13

Piping Systems for Underground Storage

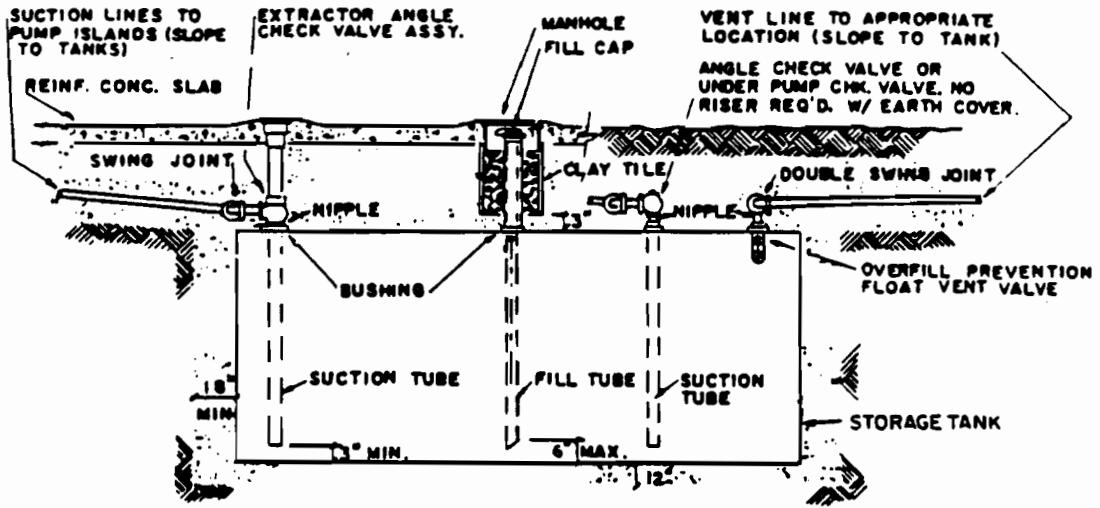

SYSTEM WITH SUCTION PUMPING

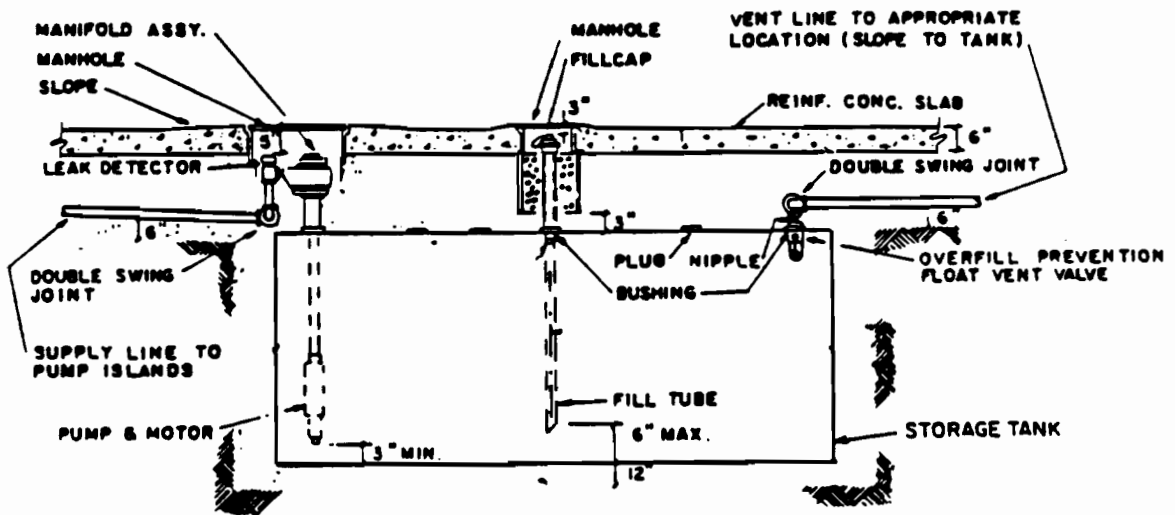

SYSTEM WITH SUBMERGED PUMP

Source: API Publication 1615. *Installation of Underground Petroleum Storage Systems*. 1979.

Source: Technology for the Storage of Hazardous Liquids: A State-of-the-Art Review, New York State Department of Environmental Conservation, Revised, March 1985.

NOTES

able to detect contamination in the surrounding soils and/or free product or to remove the tank. Never inspect the condition of an **underground storage tank by entering the interior of the tank** unless the tank has been completely vented of vapors and cleaned thoroughly. Part 1, Section 4, contains more guidance on the proper investigation of UST spills.

There are many reference materials available concerning the design, installation, and operation of aboveground and underground storage tanks. These include publications prepared by the American Petroleum Institute (API), the Underwriters Laboratories (UL) Inc., the American Society of Mechanical Engineers (ASME), the American National Standards Institute (ANSI), the American Iron and Steel Institute (AISI), the National Fire Protection Association (NFPA), the American Welding Society (AWS), and numerous publications and articles prepared by various federal, state, and local agencies. BSPR personnel should also refer to the following NYSDEC publications:

- *Technology for the Storage of Hazardous Liquids*, March 1985;
- *Recommended Practices for Underground Storage of Petroleum*, August 1985.

Several Technical Operating Guidance Series (TOGS) also address Division of Water technical requirements for underground petroleum storage systems. TOGS 4.1.4 (July 20, 1987) identifies acceptable inventory monitoring practices at metered facilities, unmetered facilities, existing storage systems, new storage systems, and action levels that trigger follow up of suspected leaks. TOGS 4.1.3 (December 7, 1987) provides guidance on acceptable designs and materials for installing secondary containment for underground petroleum storage systems as required by 6 NYCRR Section 614.4. TOGS 4.1.6 (August 17, 1987) provides guidance on acceptable overfill prevention equipment for petroleum storage tanks, both underground and aboveground tanks, per the requirements of 6 NYCRR Section 613.3 and Section 614.14(g)(1) and (2).

c. Inventory Control Requirements

Traditionally, inventory record keeping has involved recording data on the quantity of product purchased, quantity withdrawn, and identifying differences between the two. Typically, these measurements are made by sticking the tank and checking a tank capacity chart for volumetric conversion. Differences are due to one or more of the following:

- theft;
- short deliveries;
- meter miscalibration;
- vaporization losses;
- contraction or expansion of product;

NOTES

- spillage or leakage; or
- inaccurate readings.

Where good records are kept, losses of 75 gallons per throughput of 10,000 gallons can be detected. Where records are poor or where a conscientious effort to reconcile discrepancies has not been made, losses of several hundred gallons of petroleum can occur without detection.

In a recent survey of gasoline retail facilities in the Nation (see EPA Report "Underground Motor Fuel Storage Tanks -A National Survey, May 1986), EPA reached these conclusions about inventory record keeping practices.

"It is very difficult to obtain accurate, and usable inventory data. Owners and operators had trouble following even simple procedures. -- It is not that inventory control does not work, it is just that the successful execution of it is difficult to achieve."

EPA observed in their survey that only 40 percent of the service stations kept meaningful inventory records.

At non-retail facilities, additional factors may come into play to make traditional inventory monitoring practices impractical or impossible. Withdrawals from the tank may be unmetered. Tanks may be unattended except for weekly inspection. Openings for sticking the tank may not exist. Typical of these tanks are home heating oil tanks, industry or utility owned tanks containing petroleum for standby generators, farm tanks, manifolded tank systems where the capacity rating may be difficult to determine, and inaccessible tanks such as those buried beneath buildings.

A wide variety of these storage system situations exist in New York State and each situation may require a different inventory control method. Depending on the system layout, presence of metering equipment, data gathering and statistical skills of the operator, traditional inventory record keeping can be either effective or, ineffective as a leak detection method.

The inventory monitoring requirements are different for new and existing metered and unmetered storage systems.

(1): Existing Metered Storage Systems

Existing metered storage systems must use one of the following for meeting the inventory monitoring requirement:

- Traditional stick monitoring; and
- In-tank monitoring.

NOTES

Traditional Stick Monitoring. Four steps are followed with this procedure.

Step #1. In step #1, the level of product in the tank is measured with a measuring stick at the beginning and end of each day. Stick readings are converted to gallons of storage using a tank capacity chart. Losses or gains are calculated by subtracting the ending volume from the beginning volume.

Step #2. In step #2, the volume delivered (from delivery invoices) and volume dispensed (from meter readings) are recorded and the difference between the two readings is calculated.

Step #3. In step #3, the difference calculated in step #1 is compared with the difference calculated in step #2. These differences should equal, but rarely is this the case. Discrepancies may be due to meter miscalibration, theft, leakage, a short delivery, vaporization, or product contraction or expansion. All of these factors contribute to inaccuracy, thus complicating interpretation.

Step #4. Reconcile records by summing differences. If there is a recurring accumulation of water, or losses or gains greater than 0.75 percent of the tank volume or 7.5 gallons per 1000 gallons delivered in any ten day period the reason must be investigated. If, within 48 hours, the cause cannot be explained by inaccurate record keeping, temperature variations, or other factors not related to leakage, the operator must notify the owner and the nearest Regional Office of the Department or the DEC Spill Hotline at 1-800457-7362, must take the tank out of service in accordance with 6 NYCRR Section 613.9(a) and inspect and/or perform a tightness test.

Checking the level of water in the bottom of the tank is a quick way of detecting a leak. If water levels increase between deliveries, it is likely that ground water is seeping into the tank through a hole.

NOTES

Article 17 Title 10 of the Environmental Conservation Law and Section 613.4 of Petroleum Bulk Storage (PBS) Regulations require operators of all underground petroleum storage tanks to keep and reconcile daily inventory records for the purpose of leak detection. Records must be kept for each individual storage system and shall include: measurements of bottom water levels; sales; use; deliveries; inventory on hand; and losses or gains. Reconciliation of records must be kept current, must account for all variables that could affect an apparent loss or gain, and must be in accordance with generally accepted practices. Inventory monitoring records must be maintained and made available for Department inspection for a period of not less than five (5) years. Failure to maintain and reconcile such records constitutes cause for Department ordered tests and inspections of the facility at operator expense.

The Department and NYS Association of Service Stations have developed an inventory form and procedures for inventory monitoring (see Exhibits 3.2-14 and 3.2-15). It is our policy to encourage the use of the form and procedure to standardize inventory monitoring;

Other sources of information on inventory record keeping practices include:

API Publication 1621 "Recommended Practices for Bulk Liquid Stock Control at Retail Outlets, American Petroleum Institute, 2101 L Street Northwest, Washington, D.C. 20037

"More About Leaking Underground Storage Systems. A Background Booklet for the Chemical Advisory" October 1984, EPA, Office of Toxic Substances, Washington, D.C. 20460

"Inventory Reconciliation Systems," Warren Rogers Associates (401) 8464747.

Exhibit 3.2-14

Line-By-Line Explanation

- NOTE 1: It is up to the individual owner/operator whether to use one sheet for the whole station or to use one sheet for each product. This will depend on station size and number of dispensers.
- NOTE 2: If the tanks are manifolded, add the appropriate "F" lines into one column, on line "M".
- NOTE 3: We strongly suggest that you verify exactly which dispensers pump from which tanks. This will result in more accurate records.

Physical Stock Inventory. Fill out this section using one column per tank.

- A. Stick Today (inches) -- Read dipstick measurement to the nearest 1/8 inch.
- B. Last Stick (gals.) -- Write down the number of gallons on hand yesterday.
- C. Deliveries since (B) -- Add any deliveries since the last stick reading.
- D. Total (B + C) -- Add yesterday's gallons plus deliveries. (Add Line C to Line B.)
- E. Stick Today (gals.) -- Refer to API Bulletin 1621 to find out the method to convert inches of product to gallons.
- F. Gone from Tank (D-E) -- Subtract Line E from Line D. This is the number of gallons gone from the tank today.

Sales. Write down meter readings one reading per column. Add up the amount sold for each tank in one of the columns.

- G. Today's Meter -- Write down the meter reading for each meter.
- H. Last Meter Reading -- Write down the meter reading from yesterday.
- I. Meter Sales (G-H) -- Subtract Line H from Line G. The difference is the amount sold.

Balance. Subtract the amount Gone from Tank (Line F) from Total Sales (Line K) and then subtract Line L Test Gallons. This is the total difference. A leak will show up as a negative amount. Add (or subtract if negative) to last Line Q.

- J. Meter Totals -- Put all the meters pumping from the same tank or tanks into one column to make it easier to add.
- K. Total Sales -- Add each column and put the total under each column.
- L. Test Gallons -- If pump proving is done, these gallons will be registered on the meters but returned to storage so there will be this much extra in the tanks. So to compensate, test gallons must be subtracted from the meter totals.
- M. Subtract Test Gallons (K-L)
- N. Gone from Tank (Line F) -- Transfer Line F into the space provided.
- O. Difference (M-N) -- Subtract Line N from Line M. Note: This will sometimes come out a positive number, but sometimes will be negative. Be sure to follow the + or - sign.
- P. Yesterday's Cumulative difference -- Transfer the number from Line O yesterday.
- Q. Cumulative Difference -- Add Line O and Line P. Be sure to remember the + and - signs.

IF: Water levels rises more than one inch on a day with no deliveries.

IF: The limit of unexplained losses is exceeded for the period.

IF: Weekly loss from storage is more than 0.0075 x weekly amount of product sold.

THEN: Call the Regional Office of the NYS Department of Environmental Conservation, and the appropriate County office.

**Exhibit 3.2-15
INVENTORY FORM**

STOCK INVENTORY	TANK NO.	PRODUCT TYPE						
A. Stick Today (Inches)								
B. Last Stick (Gals.) (Yesterday's Line E)								
C. Deliveries Since (B)								
D. Total (B + C)								
E. Stick today (Gals.) Convert Line (A) to Gals.								
F. Gone from Tank (D-E)								
SALES								
G. Today's Meter								
H. Last Meter Reading (Yesterday's Line G)								
I. Meter Sales (G-H)B)								
BALANCE								
J. Meter Totals								
(Total all meters pumping from the same tank system)	1							
	2							
	3							
	4							
	5							
	6							
K. Total Sales								
L. Amount of Test Gallons								
M. Subtract Test Gals. (K-L)								
N. Gone from Tank (Line F)								
O. Difference (M-N)								
P. Last Line Q								
Q. Cumulative Difference (O + P)								

WATER TEST (INCHES)

COMMENTS:

NOTE: A supply of the form is available at a cost of \$5.00 by requesting the "Inventory Record Book" from the Gasoline Retailers Association (phone 518-434-6102) at 8 Elk Street, Albany, NY, 12207.

NOTES

In-Tank Monitoring. In-tank monitoring systems are electronic systems that automatically measure tank inventories and continuously record changes. These systems supply all the information needed to perform daily reconciliation with the pumps. Records are kept in a manner similar to that of traditional stick monitoring.

It is our policy to inspect inventory records on all leaking tank systems to determine if the leak could have been detected earlier. It is also our policy to spot check record keeping practices at other facilities, if time permits, to help educate operators on correct record keeping procedures. If there is continuous noncompliance, then enforcement is appropriate.

2. Existing Unmetered Storage Systems

We are taking a flexible approach to inventory record keeping for unmetered storage systems. We recognize any one of the following as an acceptable method of inventory monitoring for the purpose of leak detection for unmetered systems:

- # Annual standpipe tests;
- # Sticking of standby storage and home heating oil tanks; or
- # A method acceptable to the Regional Water engineer.

Annual Standpipe Testing. We recognize that there may be circumstances when none of the methods for metered systems can be used. We will, therefore, accept an annual standpipe test or tightness test for detecting inventory leakage. The method for performing a standpipe test is described in "Standpipe Testing of Underground Storage Tanks," January 1987. As with other inventory monitoring methods, records of the test must be maintained by the operator and be able to withstand scrutiny as a meaningful leak detection test.

NOTES

Sticking of Standby Storage and Home Heating Oil Tanks. The operator of an unmetered tank that is not used regularly may stick the tank weekly to determine if there is inventory loss. This would be the case for a heating oil tank during the off season. As long as the tank is

not being used, the amount of product in the tank should remain constant. If the sticking of the tank shows that there is a loss, then this is probably due to a leak.

3. New Storage Systems (Metered or Unmetered)

The PBS Law requires daily inventory monitoring at all facilities whether they do or do not comply with 6 NYCRR Part 614, "Standards for New Construction." However, we know that inventory monitoring records are kept correctly at few facilities and then, at best, will only detect a leak in excess of 100 gallons a month (EPA found 75 gallons per throughput of 10,000 gallons). At new or modified facilities, therefore, a leak monitoring system is required. As these systems can detect leakage before contamination can occur and as each of these systems is as accurate or better than traditional inventory monitoring, it is our policy to allow new storage systems to use the leak monitoring system as an acceptable inventory monitoring method. The leak monitoring system may consist of one of the following:

- In-tank monitoring;
- Wells in conjunction with secondary containment; or
- Monitoring of the interstitial space of a double-walled tank.

In-Tank Monitoring. In-tank monitoring systems are electronic systems designed to activate an alarm or print out a warning when the tank is leaking at a rate of 0.2 gallons .per hour or larger. To measure this leakage rate, the in-tank system requires that

NOTES

the tank system remains inactive for up to six (6) hours. This monitoring must be done at least weekly and the printouts kept on file.

Wells in Conjunction with Secondary Containment. Monitoring wells installed in a secondary containment system are capable of detecting inventory leakage. These wells must be monitored at least weekly and records of monitoring activity maintained. Monitoring wells will not be acceptable for inventory monitoring without a device capable of detecting 1/64th of an inch of petroleum floating on the water surface.

Monitoring of the Interstitial Space of Double-Walled Tanks. Adequate inventory monitoring for double-walled tanks will consist of monitoring of the interstitial space for breaches in either the inner or outer wall. Records of the monitoring activities must be maintained.

4. Exclusions From Inventory Monitoring

No Inventory Monitoring is required for:

- An underground tank storing No. 5 or No. 6 fuel oil; or where
- The operator can demonstrate to the satisfaction of the Department that it is technically impossible to perform inventory monitoring for the purpose of leak detection.

d. Secondary Containment Systems

All new underground petroleum storage tanks must be installed with secondary containment systems. The requirements for secondary containment are defined in 6 NYCRR Section 614.4, "Standards for New and Substantially Modified Petroleum Storage Facilities."

To assist tank owners, installers, and engineers with the installation of secondary containment systems, the Department has prepared a manual entitled "Recommended Practices for Underground Storage of Petroleum." Chapter 4 of that manual is

NOTES

devoted to recommendations for secondary containment. We strongly recommend that owners and installers follow the manual. The regulations currently recommend minimum requirements, which are addressed below in the form of responses to four questions frequently asked by tank installers, buyers, and local officials. The regulations currently do not make a distinction on separate or more stringent requirements in aquifer areas.

1. What methods of secondary containment are acceptable to the Department under 6 NYCRR Section 614.4?

Under the Department's petroleum storage regulations, tank owners have a number of secondary containment options, including the use of:

- a double-walled tank;
- a vault;
- cut-off walls; or
- an impervious underlayment such as a trough liner

These requirements pertain to secondary containment for tanks, not pipelines. While secondary containment in pipe trenches is strongly recommended, especially in aquifer areas, they are currently not required by the PBS Regulations.

The range of options permitted by the PBS regulations allows an "engineered approach" to underground storage system design. An acceptable design is one where the secondary containment and monitoring systems (required by 6 NYCRR Sections 614.4 and 614.5) work together to confine leaked product and allow its detection before it escapes to the environment outside of the excavation area. Department experience is that there are many types of secondary containment which are used effectively in New York State. Hence, New York State regulations allow considerable latitude in meeting the above objective.

2. What are the advantages and disadvantages of each secondary containment system?

NOTES

Double-walled tanks are pre-engineered systems that include an outer wall for secondary containment and a monitoring device for the interstitial space. These tanks are suitable for use under a wide variety of site conditions and require a minimum of engineering oversight. Although double-walled tanks are a fairly new product in the United States and do not have a proven track record, they appear to be a reliable and simple way of achieving secondary containment and offer the ease of installation of a single-wall tank. Double-wall tanks have been very effective in Europe.

Vaults are of two types; encasement vaults or the walk-in type. Encasement vaults are used extensively in New York City and in England and, although they are expensive to install, they appear to provide satisfactory secondary containment. Walk-in vaults are used more for chemical storage than petroleum storage. The vaults have concrete walls and bottom slabs to which the tanks are anchored. Encasement vaults have fill material surrounding the tank, while walk-in vaults permit access to the vault through manholes to inspect or recover any leaked or spilled product. They provide satisfactory secondary containment when coated or provided with an outside vapor barrier to prevent vapor migration. Vaults which permit access to the interior are often chosen because of the advantages of being able to perform tank maintenance and inspection, but vaults are expensive and may crack or leak if not properly designed and constructed. The PBS regulations (6 NYCRR Section 614.4(b)(2)) require chemical resistant water stops at any joint and no drain connections or entries to vaults except top entry manholes.

Cut-off walls of clay or synthetic material, when installed properly, are effective in preventing migration of spilled or leaked products. They are used around tanks installed in groundwater to confine product floating within the walled-off excavation area. They may be installed with a bottom or, if geologic studies show that the groundwater table does not recede below the tank bottom elevation,

NOTES

without a bottom. Their permeability rate to water must be equal to or less than 1×10^{-6} cm/sec. Experience in Suffolk County with cut-off walls is that they work effectively when thorough geologic studies of groundwater fluctuations are made and the secondary containment system is carefully engineered and installed. Installation is a particularly difficult task so, unless an owner can find an installer with skill and experience in cut-off wall construction, a doublewalled tank is a more satisfactory solution to the requirement for secondary containment.

Clay soils at the site may act as a natural barrier to migration of spilled or leaked product from the excavation. When tanks are installed in clay soils, the native clay will satisfy the Department's secondary containment requirement. For these installations, sand or pea backfill must be used to provide structural support for the tank. Because this backfill will fill with water, anchoring of the tank is required to prevent floatation.

If clay liners are used, the clay must have a permeability to water of less than 1×10^{-6} cm/sec. It must be uniform so that there are no "windows" where product can escape. Pace Report No. 79-2 (Sections 4.8 and 4.9) provides the standard methods that DEC will accept. The clay should be laid down in two 3 to 6 inch lifts and compacted between layers. A minimum of 6 inches in depth is recommended.

Impervious underlayment must also have a permeability rate to water of less than 1×10^{-6} centimeters per second (6 NYCRR Section 614.4(b)(4)). Trough liners of clay or synthetic material may be used effectively underneath tanks where ground water is below the tank's bottom elevation and the soils are well drained. Trough liners create a table that will delay the movement of leaked product to the groundwater table. It is also necessary to conduct studies of groundwater fluctuations and carefully design and install trough liners if they are to perform their intended function. It is necessary to monitor the system regularly, provide an impervious

NOTES

cover, and remove water from the trough when it collects by pumping or by using a water draw-off valve. Trough liners provide less security from accidental groundwater releases than double-walled tanks.

3. What liner materials are acceptable?

The problem that liner materials must overcome are many. Characteristics of good liner materials are:

- Chemical compatibility;
- Longevity;
- Durability;
- Construction ease; and
- Thickness.

Chemical compatibility with petroleum products and additives is extremely important. Gasoline is particularly aggressive. Aromatic compounds in gasoline are good solvents and attack many liner materials. Until recently, high density polyethylene (HDPE) was the only synthetic material that could stand up to gasoline and its additives. There are now several liner materials that are gasolineresistant.

The chosen liner material has to be compatible with the product that is going to be stored in the tanks. While there may be other materials which are compatible with certain petroleum products, the material used for petroleum products should be compatible with gasoline as the liner must be dependable if an owner desires to convert a tank to the storage of gasoline.

Longevity of the liner material must be comparable with the life expectancy of the storage system.

Today's state-of-the-art tanks are designed to last 30 years or more, so liner materials must have a similar life expectancy. A liner must be installed by a qualified contractor who can place and seam the liner in accordance with the manufacturer's instructions and regulatory requirements (6 NYCRR Section 614.4(b)(3)).

Synthetic liners should always be at least 30 mils thick. That is the minimum acceptable thickness.

NOTES

The following liner materials are acceptable to the Department of Environmental Conservation:

- Bentonite Clay
- Fueltane (urethane coated polyester fabrics)
- Hytrel (Polyester coated fabric)
- High Density Polyethylene
- Herclor (epichlorohydrin rubber)
- Enviromat

4. What are the costs for secondary containment?

The following estimates were taken from an EPA survey of underground storage facility costs. As can be seen, costs range from zero to as much as \$10,800 depending on the particular site and type of secondary containment desired. Cost by itself is not a good indicator of the best choice of a secondary containment system. As discussed earlier, some methods of secondary containment, while lower in costs, may be more difficult to maintain or may not provide the most fail-safe protection of the environment.

	<u>Cost per Tank^a</u>
Double-Walled Tank (sti-P3) ^b	\$ 3,160
Concrete Vault ^c	10,800
Cut-off Wall ^c	7,130
Trough Liner ^c	2,350
Native Impermeable Soils	0

^aTank size is 5,000 gallons.. Costs are from EPA cost survey, Dave O'Brien, May 1986.

^bThese are the added cost of purchasing a doublewalled tank over a single-walled tank. There are no significant added costs for installing a double-walled tank over a single-walled tank.

^cIncludes cost of installation. Costs are per tank but based on a three tank installation.

e. Overfill Prevention Equipment

The Petroleum Bulk Storage Regulations, 6 NYCRR Section 613.3 describe DEC's requirements for overfill prevention during the handling and storage of petroleum. EPA's Underground Storage Tank regulations that require overfill prevention and spill control equipment are in 40 CFR 280.20(c).

1. Underground Tanks

NOTES

Overfilling of underground tanks and product transfer spills occur in commercial and industrial settings if storage tanks are filled without an automatic means to prevent overfilling. Frequently, a tank may become so full that there is no room to drain the delivery hose prior to disconnection, leading to a product spill of up to 25 gallons. Even if there is enough room in the tank, there may be spills from the delivery hose if a driver bypasses standard operating procedures.

The most obvious way to eliminate the problem of overfill is to train delivery personnel so that they never spill anything. The Department encourages the idea of rigorous training to minimize overfill incidents. However, even with a good training program, accidents can and will occur.

The basic overfill and spill prevention strategy is: (a) prevent overfills from occurring, and (b) control product so that no disconnect spills occur.

The operator or carrier supervising any product transfer must follow proper practices for preventing any transfer spills and accidental discharges. Prior to the transfer, the operator or carrier must determine that the tank has available capacity to receive the volume of petroleum to be transferred (e.g., sticking the tank). The operator or carrier must monitor every aspect of the delivery and take immediate action to stop the flow of petroleum when the working capacity of the tank is reached or if there is an equipment failure or other emergency.

Note the emphasis on operator or carrier responsibility. If the operator is not on the premises or not in control of the petroleum transfer, the carrier is responsible for transfer activities. (6 NYCRR Section 613.3) This is particularly the case of homeowners who may not be present during a delivery or determined incorrectly that a delivery was needed. The carrier or operator of the transfer activities is responsible for determining the tank can take the fuel.

2. Aboveground Tanks

To reduce the chances that a transfer will be attempted to a tank that is full or lacks adequate receiving capacity, DEC's petroleum bulk storage regulations (6 NYCRR Section 613.3(c)(3)) require that existing aboveground tanks be equipped with a level gauge by December 27, 1990. New tanks must be built and installed with automatic gauges. The regulations state that all aboveground petroleum tanks must be

NOTES

equipped with a gauge that accurately shows the level of product in the tank. The gauge must be accessible to the carrier, and must be installed so it can be read conveniently. The design capacity, working capacity, and identification number of the tank must be marked clearly on the tank and at the gauge. A high level warning alarm, a high level liquid pump cutoff controller, or equivalent device may be used in lieu of the gauge required above.

To reduce the possibility of backflow following - product transfer, the regulations :3 NYCRR Section 613.3(c)(4)) also require that existing aboveground tanks be equipped with a check valve by December 27, 1990. All new tanks must have these valves. The regulations require fill pipes leading to pumpfilled petroleum tanks to have check valves or equivalent devices which provide protection against backflow when the piping arrangement is such that backflow from the receiving tank is possible.

The regulations also require that the owner or operator must keep all gauges, valves, and other equipment for spill prevention in good working order.

3. Overfill Prevention Equipment

An overfill prevention device is a piece of equipment that stops product flow, diverts the flow to another tank or in some way alerts the delivery person of an impending overfill and ultimately prevents any spill of product to the environment.

Discussed below are four types of overfill prevention equipment that provide warning or shutoff when a tank reaches its working capacity:

Float Vent Valves. This is a simple device that operates on the principal of buoyancy. It is installed in the tank vent line to protrude partially into the tank. As the liquid level in the tank rises, the ball floats up and seats itself in the vent line at about 95% of tank capacity. This shuts off the vapor return to the tanker which slows the flow of product into the tank. This allows adequate time for the operator to become aware that the flow of product has been reduced and to close the truck valve. Enough room remains in the tank to permit the delivery hose to be drained into the tank without spillage. (6 NYCRR Section 614.14(g)(2)) requires that tanks with float vent valves be gravity filled.)

NOTES

There are a number of drawbacks to float vent valves:

- The float obstructs the vent line and may permit the tank to become overpressurized.. If a tank with a float vent valve is accidentally filled by pump, pressure can increase and the tank can rupture. This happened in Suffolk County where a gravity-filled diesel tank was switched to pump-filled kerosene. The tank was overpressurized; it ruptured and released 8,000 gallons.
- They must be installed with an extractable tee (6 NYCRR Section 614.14(g)(2)) as the valve must be removed before the tank can be tightness tested.
- The operator must realize that the flow has slowed, close the truck valve, and wait for the hose to drain to avoid a spill.
- They should be used only with submerged pump systems, not suction pump systems. In systems with suction pumps, product will continue to rise in the dispensing line until equilibrium is reached. This can lead to an overflow at the pump or at the fill pipe, and space may be inadequate to drain the delivery hose.
- They must close at or before the product level in the tank reaches 95% of capacity. In certain cases (Owens-Corning double-walled fiberglass tanks), the float vent valve does not extend far enough into the tank, and does not close until the tank is 100% full. This may be remedied easily by adding an extender pipe to the float valve.

In summary, float vent valves are simple and reliable, but have shortcomings as overflow prevention devices as they rely heavily on driver recognition to prevent overfills and are acceptable for use only in systems which have submerged pumps and use gravity fill. If a float vent valve is used, a permanent label must be affixed to the fill port warning against pump filling. DEC accepts but does not recommend float vent valves.

NOTES

Venturi-Type Automatic Shutoff. This device works on the same proven principle that the metal gasoline-dispensing nozzles use. When liquid covers a venturi opening, the valve snaps shut stopping delivery at the top of the fill pipe. Liquid remaining in the hose can then be drained into the space left in the tank.

At present, this device can only be used when there is a straight drop tube. An initial drop in the fill line of greater than 32 inches is needed to account for the height of the assembly, and another straight access to the tank is required. It can be used with gasoline, kerosene, and #2 fuel oil tanks. The manufacturer is investigating the feasibility of applying this device to remote fill lines.

This device, since it completely stops product flow, requires very little, if any, operator awareness. It is also applicable to all types of pumping systems. The system is strongly recommended.

High-Level Alarms. High-level alarms come in a wide variety of configurations which are simple and proven. They can be as simple as a float switch and bell or light, part of another system such as an inventory monitoring system, or consist of an automatic shutoff system combined with audible and visual alarms. Any of the devices is acceptable if the alarm is located near the delivery point to alert the driver that a high-level has been reached.

Dedicated Delivery Systems. There are dedicated delivery systems that interconnect delivery trucks and unloading racks. These systems measure the liquid level, initiate an alarm, and delivery is shut off at the truck. Very little operator awareness is required. These systems are acceptable, but are expensive.

4. Transfer Spill Control Equipment

Associated with the overfill prevention equipment are certain devices which can prevent the release of product to the environment if a disconnect spill or overfill occurs. They do not prevent overfills. Some of these are:

Containment Manholes. The manholes will catch overfills and slop, and prevent it from percolating down into the soil. Some have a cartridge of imbibitor beads at the bottom which are supposed to permit water and prevent spilled material from passing. DEC has received reports of the beads not

NOTES

working properly so users should be cautioned about this possibility. DEC has also received accounts of these receptacles accumulating water, which freeze during the winter. Operators have combatted the problem by dumping rock salt into the manhole, a practice which should be discouraged as it corrodes the fill pipe and may eventually affect the tank. The manholes are recommended by DEC as they can prevent any spillage from entering the ground and permit easy cleanup.

Dry-Disconnect Couplings. These are the best couplings available for preventing product spill while disconnecting hoses. The couplings are equipped with a spring-loaded valve that is normally closed until the coupling is attached and the valve is opened manually. "Dry breaks," as they are called, are heavy and bulky, but prevent disconnect spills. They are recommended for use in all product transfer operations..

5. Color-Coding

Color coding of fill ports can reduce both the potential for an overflow, and the financial loss associated with any product mixing resulting from improper product transfer. For example, a spill occurred in New York City when a carrier stuck an unleaded storage tank, found it to be empty, and then proceeded to fill a leaded gasoline tank which was already near its full capacity. The result was an overflow of over 200 gallons.

6 NYCRR Section 613.3(b) describes the requirements for color coding. By December 27, 1990, the owner or operator of tanks must permanently mark all fill ports to identify the product inside the tank. These markings must be consistent with the color and symbol code of the American Petroleum Institute (see Exhibit 3.2-16). The marking may be as simple as spray-painting the appropriate symbol and color on the fill port or may include a more recommended method such as permanently affixing (by welding or embedding in concrete) a printed symbol and product name plate at the fill port.

Another requirement for spill prevention is that all monitoring wells must be permanently marked and identified as a "monitoring well." (6 NYCRR Section 614.5(d)(2)) Compliance reduces the chance of a monitoring well being confused with a fill pipe and being filled accidentally with product.

API EQUIPMENT MARKING COLOR-SYMBOL SYSTEM

GASOLINE

Leaded

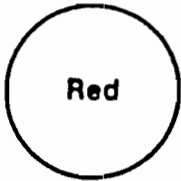

Higher Gasoline

Unleaded

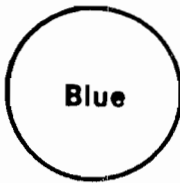
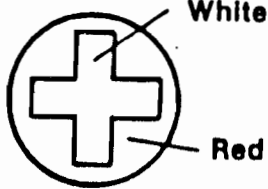

Middle Gasoline

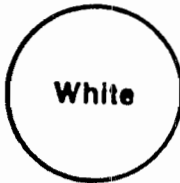
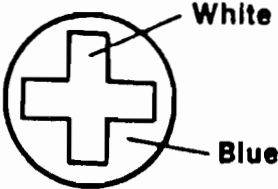

Lower Gasoline

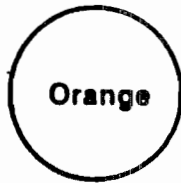
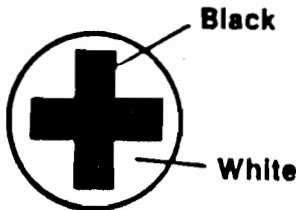

Vapor Recovery

(EXAMPLE)



*Unleaded extender ring
same color as cross*

DISTILLATES



Diesel

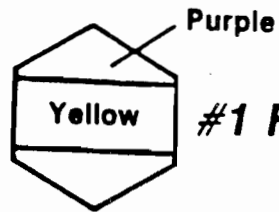

#1 Fuel Oil



#2 Fuel Oil

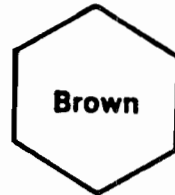

Kerosene

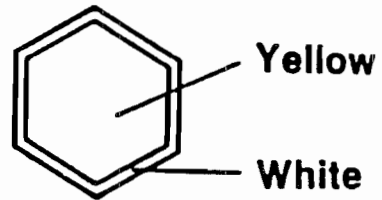

NOTES

e. Permanent Closure of Petroleum Storage Tanks

As a consequence of the regulations governing tanks for bulk storage of petroleum, there have been numerous questions concerning closure and removal of tanks. These procedures should be followed to comply with federal and state regulations regarding the permanent closure, removal, and disposal of petroleum tanks and any waste products removed from them. The procedures are specific to underground gasoline storage tanks, but oil storage tanks should be treated the same way except as noted.

1. Notification Requirement

The owner of a petroleum tank or facility who intends to take it out-of-service permanently must notify the Department within thirty (30) days prior to permanent closure and comply with the requirements of 6 NYCRR 613.9(b).

2. Safety

Flammable Vapors Tanks that contain gasoline residues are explosive. Petroleum vapors are heavier than air and will "hang" in the tank. Therefore, all sources of ignition must be controlled, and the tank's interior volume must be made inert.

Tank Entry Tank entry to remove residual sludge of heavy fuel oils and closure of tanks are very dangerous procedures. Tanks should only be entered if: (1) personnel are properly trained and equipped, (2) there is positive ventilation, and (3) standby personnel are present outside the tank.

Static Charges Tanks and nozzles used to introduce inert gas should be grounded. Inert gas should be slowly introduced into tanks to avoid build up of static charge and ignition of flammable vapors.

Tank Vent After a tank is removed from the excavation and plugged, provide a 1/8 inch hole into the tank to permit equalization of pressure between the interior and exterior of the tank caused by temperature changes.

3. Preparations for Removal of Underground Tanks

Remove Product Remove all product to its lowest draw-off point.

Drain and- Flush Pining Drain and flush piping into the tank (one or two gallons of water should be enough)

Pump Out Liquid Pump out all liquid, including any remaining product layer, that remains below the draw-off point using a vacuum or hand pump. This liquid ("tank bottom") consists of water, sediments, and a floating layer of product. It is usually about six inches in depth and will contain about 150 gallons in a typical 4000 gallon tank. In its research, EPA found the median volume of residuals found in gasoline and diesel USTs before cleaning was slightly below 100 gallons. EPA also found some USTs contained several thousand gallons, consisting either of abandoned fuel and/or water which leaked into the UST. EPA has found that 70-100% of gasoline and diesel residuals consist of product of unknown purity. The remaining 0-30% consists primarily of water with

NOTES

numerous dissolved constituents, product related residuals such as gum, sediments, and tar, and a small, but important, mass of microorganisms. The petroleum product can be reclaimed later through physical separation.

If these wastes are removed from the site, they must be transported by a Part 364 permitted waste hauler to a facility which is permitted by the Department or is exempt from permitting. All applicable parts of Parts 360 and 364 should be followed. A small quantity waste transporter exemption may be applicable under the following condition: any person who transports less than 500 pounds of non-hazardous industrial/commercial waste in any single shipment is exempt from Part 364.

Expose the Tank Dig to the top and then expose the upper half of the tank.

Disconnect Piping Remove the fill tube and disconnect the fill, gauge, product and vent lines.

Plug Openings Cap or plug the ends of lines which are not going to be used any longer. Temporarily plug all tank openings.

Excavation Options There are several alternative approaches at this point:

- Complete the excavation, remove the tank and place it in a secure location on site with blocks to prevent movement; or
- An alternative which may be safer would be: complete the excavation, remove and cap the tank, plug all corrosion holes, but leaving a 1/8 inch hole for pressure relieve, and haul the tank to a secure area where it can be safely purged. *This alternative should be used only when a check with an explosion meter indicates that the atmosphere in the tank is either rich (above the upper explosive limit) or below the LEL (lower explosive limit).* The tank should also be clearly marked, "NOT GAS FREE". Note: U.S. Department of Transportation regulations require that tanks which have not been purged but are being transported, must be properly placarded on the ends and sides with a "Flammable" placard with the appropriate UN Number (1203 or 1993) attached. (49 CFR Section 172.500 et seq.), and an empty product tank which has not been properly cleaned is considered a regulated waste. *Therefore, a part 364 permit is required for transportation;* or
- Leave the tank in place and purge it prior to removal from the excavation, if desire. If this option is selected, the vent line must remain connected and open until the purging procedure is complete.

4. Removal of Flammable Vapors

Purge the Tank of Flammable Vapors During any purging operations, all ignition sources must be controlled.

Purging Methods Use one of the following methods to render the tank safe. In all methods, the tank atmosphere should be checked to make sure that the tank atmosphere is inert and that flammable vapors have been satisfactorily purged

NOTES

from the tank. If the tank atmosphere was purged prior to removal from the excavation, one must also carefully check *the excavation* for flammable vapors to insure that they have been satisfactorily removed.

- Add 1.5 pounds of crushed dry ice per 100 gallons of tank capacity. The dry ice should be distributed evenly over the greatest possible area of the tanks interior. As the dry ice vaporizes, flammable vapors will be forced out of the tank; therefore, observe all safety precautions regarding flammable vapors; or
- Introduce CO₂ directly into the tank (via the fill line) using a minimum of one 75 pound cylinder of CO₂ gas per 2000 gallons of tank capacity. In addition to observing other safety precautions concerning the flammable vapors displaced from the tank, ground the nozzle or hose and prevent the build-up of static charge by slowly introducing the CO₂; or
- Introduce nitrogen gas to inert the tank. Use an amount of nitrogen gas equal to or greater than the volume of the tank to displace vapors in the tank. Take safety precautions concerning the flammable vapors displaced from the tank. Bonding or grounding of the nozzle is recommended and slowly introduce the nitrogen into the tank to prevent the build up of static charge.
- Positive ventilation using an air eductor is another method of purging flammable vapors from a tank. This is a very *dangerous* procedure and is not recommended for *on-site* purging of flammable vapors especially in high density urban areas.

Test the Tank Atmosphere Test the tank atmosphere to ensure that the tank is safe. If the tank is not safe, the purging or inerting process must continue until the tests indicate it is safe.

If either CO₂ or nitrogen were used to inert the tank, the tank should be tested with an oxygen meter. The oxygen meter will give a meter reading of percent oxygen per volume. The meter should read 6-7% for a safe condition.

If an air eductor was used to purge the tank, the tank interior should be tested with a CGI or an explosion meter. The explosion meter will give a reading of percent lower explosive limit (LEL). The reading should be 10-20% LEL for a safe condition.

5. Moving Excavated Tanks Which Have Been Purged

Either move the tank to a tank storage yard for cleaning or clean the tank on site (See 7. below). If the tank is going to be moved to another site prior to cleaning, it must be moved by a waste transporter licensed under 6 NYCRR Part 364.

Plug Holes Before moving the tank, plug or cap all holes. Use screwed (boiler) plugs to plug any corrosion leak holes. One plug should have a 1/8 inch vent hole to prevent development of excessive pressure differences between the interior and exterior of the tank caused by extreme temperature changes.

NOTES

Secure the Tank The tank should be secured to a truck for transportation to a disposal or temporary storage site with the vent hole at the uppermost point of the tank.

6. Storage of Tanks

Tanks should be stored only long enough to clean them and cut them up or otherwise process them for final disposition. It is recommended that tanks not be stored for a period greater than ninety days prior to final disposition.

7. Cleaning and Disposal of Tanks

When properly emptied (Empty is defined in 6 NYCRR Section 371.1(f)(2)(i)), and cleaned, petroleum tanks are not a hazardous waste, and, therefore, may be disposed of at a landfill permitted under Part 360 or at a scrap yard.

Tank Cleaning To make the tank acceptable for disposal at a scrap yard or sanitary landfill, or if the tank is going to be used for some other purpose (such as a holding tank) the tank interior should be cleaned by a high-pressure spray rinse. (Water collected from this operation should be disposed of in the same manner as tank bottoms.) This method is acceptable for all storage tanks except large #5 or #6 fuel oil storage tanks. The tar and sludge remaining in these tanks must be removed by manual cleaning methods. (Any residues or solid wastes should be collected and disposed of in accordance with solid and/or hazardous waste regulations.)

Protective clothing, auxiliary air and masks are required to enter the tank for cleaning. If leaded fuel was stored, particular attention should be given to API publication 2015a.

Discarding Tanks A tank which is being discarded should then be cut into several pieces to make it acceptable for disposal at a sanitary landfill or scrap yard.

8. Tank Abandonment in Place

The following is a safe method for abandoning underground tanks in place. This may be less costly than removal, but not necessarily when proper procedures for abandoning tanks are carefully followed. *We strongly encourage tank removal over abandonment in place.*

Prohibitions Several conditions may prohibit abandoning underground tanks in place:

- Local regulations specify tank removal.
- You suspect that the tank has leaked as a result of documented evidence such as inventory records and/or tank test results.
- Product or product contaminated soil is discovered during the closure

NOTES

process. The tank may have to be removed to investigate the site and cleanup contaminated soil.

If the tank is going to be abandoned in place, then the following steps must be taken:

Initial Steps Follow the applicable parts of headings above:

- 1 - Notification Requirement
- 2 - Safety
- 3 - Preparations for Removal of Underground Tanks.
- Remove the fill drop tube. Disconnect the fill, gauge, and product lines. Cap or plug the open ends of lines which are not going to be used further. The vent line should remain connected until the tank is filled.
- Purge the tank as described in 4 - Removal of Flammable Vapors.
- As soon as the petroleum vapors are satisfactorily purged from the tank, cut one or more large holes in the tank top. This can be accomplished by drilling a hole into the tank and then using a backhoe to tear a larger "three-point" hole.

Clean the Tank Clean the interior with a high pressure rinse using as little water as possible to remove loose scale, corrosion and residual product. In fuel oil storage tanks where large amounts of tar and sludge have accumulated, it may be necessary to enter the tank and manually remove these wastes. All safety precautions noted earlier should be taken: *protective clothing .auxiliary air and masks are required to enter the tank for cleaning. If leaded fuel was stored, particular attention should be given to API publication 2015a.* The wastes should be recovered and drummed for proper disposal.

Inspect the Interior Visual inspection of the interior of the tank should be made to determine if there are any holes. If any holes are discovered, then a soil sample should be taken from under the tank near the hole to examine for the presence or absence of petroleum. If petroleum is present, a spill report must be made to the Department within two hours. In addition, one or more groundwater monitoring/recovery wells or removal of the tank may be required as part of the remedial action to clean up the site, if there is petroleum present.

Introduce Inert Material Introduce a suitable, solid, inert material through the hole in the top of the tank until it is full. Sand or a concrete slurry is acceptable.

Disconnect Line Disconnect and remove the vent line.

Records The owner of the tank should keep a permanent record of the tank location, the date of abandonment, and the method of conditioning the tank for abandonment.

9. Classification of Wastes From a Tank Closure

NOTES

Wastes associated with permanent closure of petroleum storage tanks are industrial/commercial wastes and possibly hazardous wastes. Solid Wastes associated with tank removal consist of the tank itself (and any associated piping which was removed), unusable product, sludge and sediments, and any contaminated soil removed from the excavation. The liquid waste is the tank bottoms and wash water associated with emptying and cleaning the tank. The classification of the wastes as either hazardous or non-hazardous should be based on the following:

Empty Product Tank The tank is considered a regulated, non-hazardous, industrial-commercial waste if it has been emptied using practices commonly employed to remove product from that type of storage tank.

Tank Bottoms and Rinse Water Virgin #2, #4, #6, or lubricating oil, gasoline, kerosene, jet fuel, and diesel fuel tank bottoms are not considered to be a hazardous waste.

Contaminated Soils (Also see Part 1, Section 6 Corrective Action - Soil Remediation) Soils contaminated with virgin fuel oils, diesel fuel, and lubricating oils are considered a non-hazardous, industrial solid waste.

Soils contaminated with gasoline, kerosene, and jet fuel should be assumed to be hazardous if they are ignitable and may exceed the standard for lead if they were contaminated with leaded fuels. These soils must be treated or disposed of in accordance with Department policy.

Recovered or Reclaimed Product Any product recovered directly from the tank or any usable product reclaimed from the tank bottom, if intended for commercial use, is considered a product and is not regulated as a waste.

10. Transportation Permit Requirements

The wastes resulting from permanent closure and/or removal of a petroleum storage facility must be transported in accordance with state and federal regulations. The following criteria should be considered:

Empty Tank There is a distinction between tanks that have only been emptied and those which have been emptied and cleaned. An empty tank is a regulated industrial commercial waste under 6 NYCRR Part 364. Therefore, a Part 364 permit is required for transportation. An empty tank that has been properly cleaned would be considered scrap metal and would, therefore, be exempt from the requirements of Part 364 (6 NYCRR Section 364.1(e)(2)(vi)).

Tank Bottoms and Rinse Waters These wastes must be transported by a Part 364 waste hauler to a facility which is permitted by the Department or which is exempt from permitting. All applicable requirements of Parts 360 and 364 should be followed. A small quantity waste transporter, any person who transports less than 500 pounds of non-hazardous industrial/commercial waste in any single shipment, is exempt from Part 364.

NOTES

Contaminated Soil Petroleum contaminated soils and debris must be transported as follows:

- Soils contaminated with virgin #2, #4, #6 oils, diesel fuel and lubricating oil are considered a non-hazardous industrial solid waste which must be transported by a person licensed under Part 364.
- Soils contaminated with gasoline, kerosene, or jet fuel must be transported by a person licensed under Part 364. If the soil qualifies as a hazardous waste (e.g., failing an ignitability test or having a lead content greater than 5 ppm), the shipment must be accompanied by a hazardous waste manifest.

Recovered or Reclaimed Petroleum Product This is considered to be product. Therefore, a licensed waste hauler is not required. However, any applicable DOT requirements must be complied with while transporting the material.

11. Waste Disposal Options

Empty Tank Final disposition of any tank that is not going to be reused shall be at a scrap yard or at a Part 360 permitted sanitary landfill.

Tank Bottoms and Rinse Waters These may be treated or separated to remove hydrocarbons and to concentrate the solids to at least 20 percent. Concentrated solids must be tested for EP-toxicity to determine if they are hazardous. Note: EPA published a Toxicity Characteristic rule on March 5, 1990 that applies to all hazardous wastes. The regulations take effect within one year for small quantity generators and within 6 months for generators that produce 2,200 pounds or more in any one month, and it uses a Toxicity Characteristic Leaching Procedure (TCLP) which is a modified form of the old Extraction Procedure (EP).

If hazardous, the solids must be placed in drums and transported to a permitted hazardous waste disposal facility. If non-hazardous, the solids can be disposed of at a sanitary landfill designated by the Regional Solid Waste Engineer as being capable of accepting the wastes. Disposal of tank bottoms at sanitary landfills as bulk liquids should not be allowed under any circumstances as landfills are designed to handle only solid wastes.

Tank bottoms and any wash water or waste water contaminated with product can be treated at a facility which can treat tank bottoms and which has been issued a SPDES permit that specifies the discharge of treated tank bottom waste waters. Product can be separated and recovered for use as a fuel or lubricant and the remaining water should be subjected to additional treatment prior to discharge. The SPDES permit should contain limits on BTX, heavy metals (lead), and any other limits determined by the Bureau of Wastewater Facilities Design.

Water can also be discharged from an oil-water separator to a Public Owned Treatment Works (POTW) only under the following conditions:

- Prior approval has been obtained from the plant operator and DEC.

NOTES

- The POTW has a valid SPDES permit in effect which contains limitations for BTX and heavy metals (lead).
- The discharged water is mixed with domestic sewage prior to its arrival at the POTW (therefore, the POTW is not a TSDF and does not need to comply with any RCRA regulations).
- The POTW has sufficient capacity to accept the contaminated water without impairing the treatment process and will not result in a violation of permit effluent limits.
- The POTW has implemented a local pretreatment program or has the authority under local laws to regulate the quantities accepted. A permit or contract with the POTW would be required and sampling may be required prior to the discharge to the POTW.
- The contaminated water should not contain gasoline or petroleum in amounts that create a fire or explosion hazard in the POTW. The pollutants must not be prohibited by national pretreatment standards 40 CFR Part 403.5.

Contaminated Soil Petroleum contaminated soils shall be treated or disposed of in accordance with Department policy (See Part 1, Section 6 Corrective Action - Soil Remediation). If off site disposal is required, the following guidelines should be followed:

- Soils contaminated with virgin #2, #4, or #6 fuel oils are considered a non-hazardous industrial solid waste which may be disposed of in a sanitary landfill designated by the Regional Solid Waste Engineer as capable of accepting such wastes.
- Gasoline, kerosene, jet fuel, diesel fuel contaminated soils may be hazardous wastes due to the characteristic of ignitability or toxicity. These soils must be disposed of in a manner consistent with the Department policy for disposal of oil spill debris. The existing policy requires that hazardous contaminated soil should be disposed of at a permitted, secure land burial facility or at a permitted incineration facility.

Some contaminated soils can be spread to permit the contamination to volatilize. If the soil is no longer hazardous then it could be disposed of at a sanitary landfill. This may not apply to soils contaminated with leaded gasoline which would should also be tested for lead.

Note: The department is in the process of reviewing other alternatives for treating contaminated soils.

NOTES

5. Cylinders

Hazardous materials are often stored and transported in cylinders of various capacities ranging from a few pounds up to 1-ton. According to the DOT Specification the term "cylinder" means a "pressure vessel designed for pressures higher than 40 psia ... and having a circular cross section. It does not include a portable tank, multiunit tank car tank, cargo tank, or tank car." Cylinders are fabricated in accordance with regulations and specifications of the U.S. Department of Transportation (DOT) in the United States and the Canadian Transport Commission (CTC) in Canada. Prior to April 1, 1967, cylinders in the U.S. were fabricated in accordance with regulations and specifications of the Interstate Commerce Commission (ICC). BSPR personnel may often see cylinders with ICC markings that are still in service.

Regulations cover the service pressure for which a cylinder must be designed, safety devices (i.e., fusible plugs, pressure relief valves), the type of gas or group of gases that it can hold, and requirements for in-service testing and requalification. Specifications cover such criteria as metal composition, wall thickness, nature of openings, heat treatments, proof testing, and markings. DOT and CTC regulations, in themselves, apply only to cylinders in transportation; however, many state and local codes extend applicable components of these regulations to use and storage at facilities and consumer sites.[4]

Despite being built to specifications and tested at regular intervals, cylinders can leak or fail due to stresses caused by impact, heat, corrosion, abuse, or other means. Cylinders can develop leaks at welded seams and at the valve; however, the greatest leak potential is with the valve which can occur at the valve threads, valve stem, valve outlet, or safety device. Repairs should not be attempted in the field because of the dangers involved.

Leaks at the valve outlet can sometimes be remedied by tightly closing the valve or by tightening the screw plugs, if present.[5] Any remedial actions that are attempted are dangerous and should only be performed by trained personnel using appropriate personal protective equipment and tools. Repair of leaking cylinders should not be attempted in the field. A cylinder that has leaked must not be used until it has been properly repaired and requalified.

Because its contents are under high pressure, any leaking cylinder is hazardous, regardless of the nature of its contents. In addition, each type of contained product presents its own unique hazards. Leaking flammable gases present fire and explosion hazards, and oxidizers can intensify fires that are already burning or cause fires to occur due to reactions with hypergolic materials. Poisonous or toxic materials leaking from a cylinder present extreme health hazards. Corrosive materials, in addition to creating health hazards, may cause the leak in the cylinder or cylinder valve to increase in size due to corrosion or reaction with atmospheric water vapor. Cryogenic materials will be extremely hazardous to human tissue due to their low temperature. Also keep in mind that certain pressurized materials may present multiple hazards such as flammability/toxicity or corrosivity/toxicity. In addition, any gas, whether toxic or not, will displace oxygen in a confined area, thus, creating a respiratory hazard regardless of any additional toxicity hazard.

Appendix V contains a variety of useful information regarding cylinders. The attachment is a DOT publication entitled "DOT Specification Cylinders Shipping Containers," which covers general qualifications, cylinder markings, pressure relief devices, and safety guidelines.

NOTES

For additional information on cylinders and compressed gases, refer to the following publications:

- *Handbook of Compressed Gases*, 2nd Edition, Compressed Gas Association, Inc., Arlington, Virginia, 1981.
- (P-1) "Safe Handling of Compressed Gases in Containers," CGA, Inc., 1984.
- (S B-2) "Oxygen-Deficient Atmospheres," CGA, Inc., 1983.
- (SB-10) "Correct Labeling and Proper Fittings on Cylinders/Containers," Compressed Gas Association, Inc.
- (C-7) "Guide to the Preparation of Precautionary Labeling and Marking of Compressed Gas Containers," CGA, Inc., 1983.
- *Haz Mat Response Team Leak and Spill Guide*, Fire Protection Publications, Oklahoma State University, 1984, Parts V and VI.

REFERENCES

1. Understanding Railroad Tank Cars, Union Pacific Railroad, October 1987, p. 21.
2. See Reference 1, pp. 20 and 22.
3. Hazardous materials: Managing the Incident, Noll, Hildebrand, Yvorra, Fire Protection Publications, Oklahoma State University, 1988, p. 66.
4. Fire Protection Handbook, 14th Edition, National Fire Protection Association, Boston, Massachusetts, 1976.
5. "Emergency Action in Handling Leaking Compressed Gas Cylinders," (Safetygram-11), Air Products and Chemicals, Inc., Allentown, Pennsylvania, April 1986.

Attachment 3.2-1

Rail Tank Cars

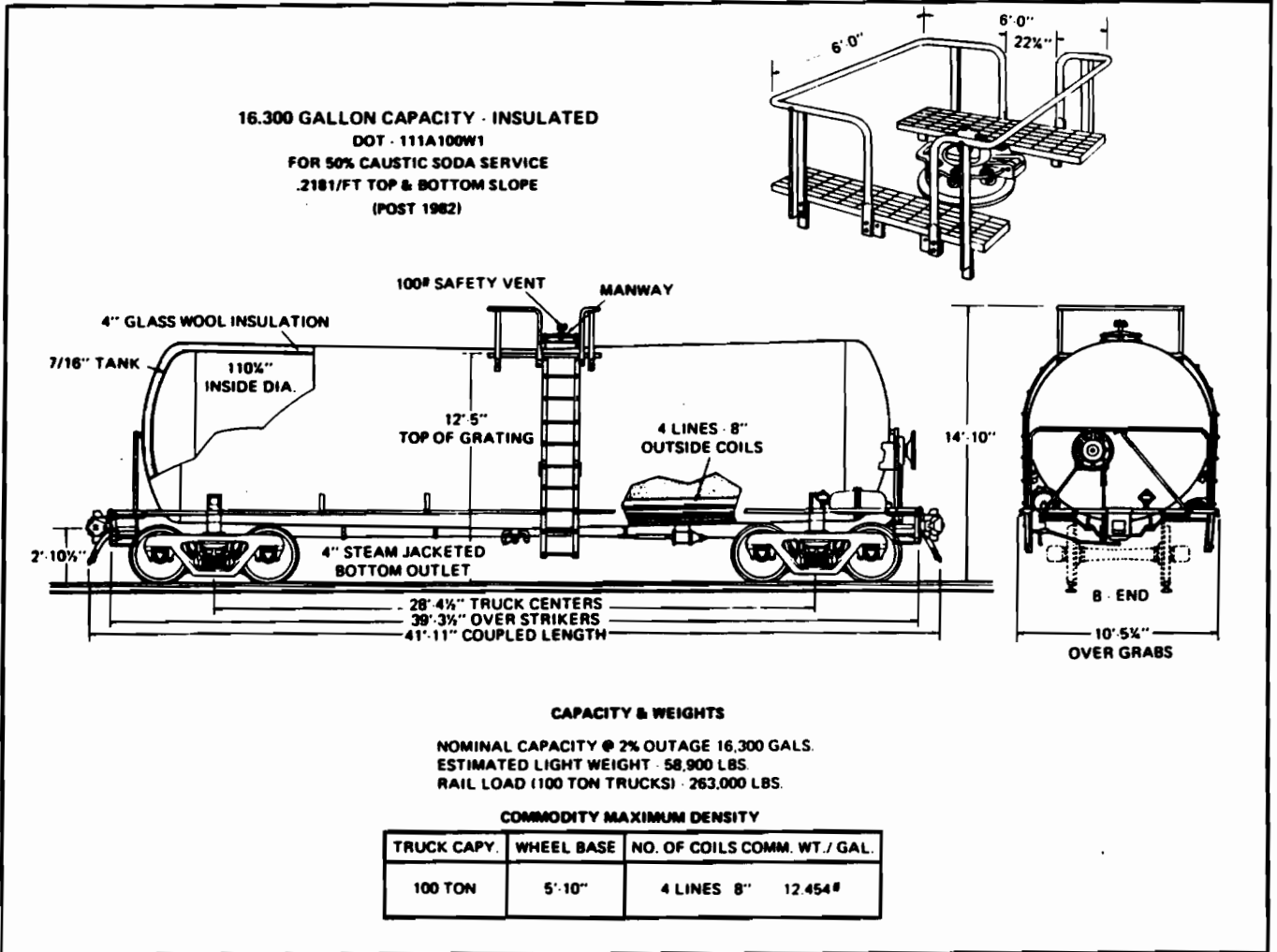

Attachment 3.2-1

Rail Tank Cars
(continued)

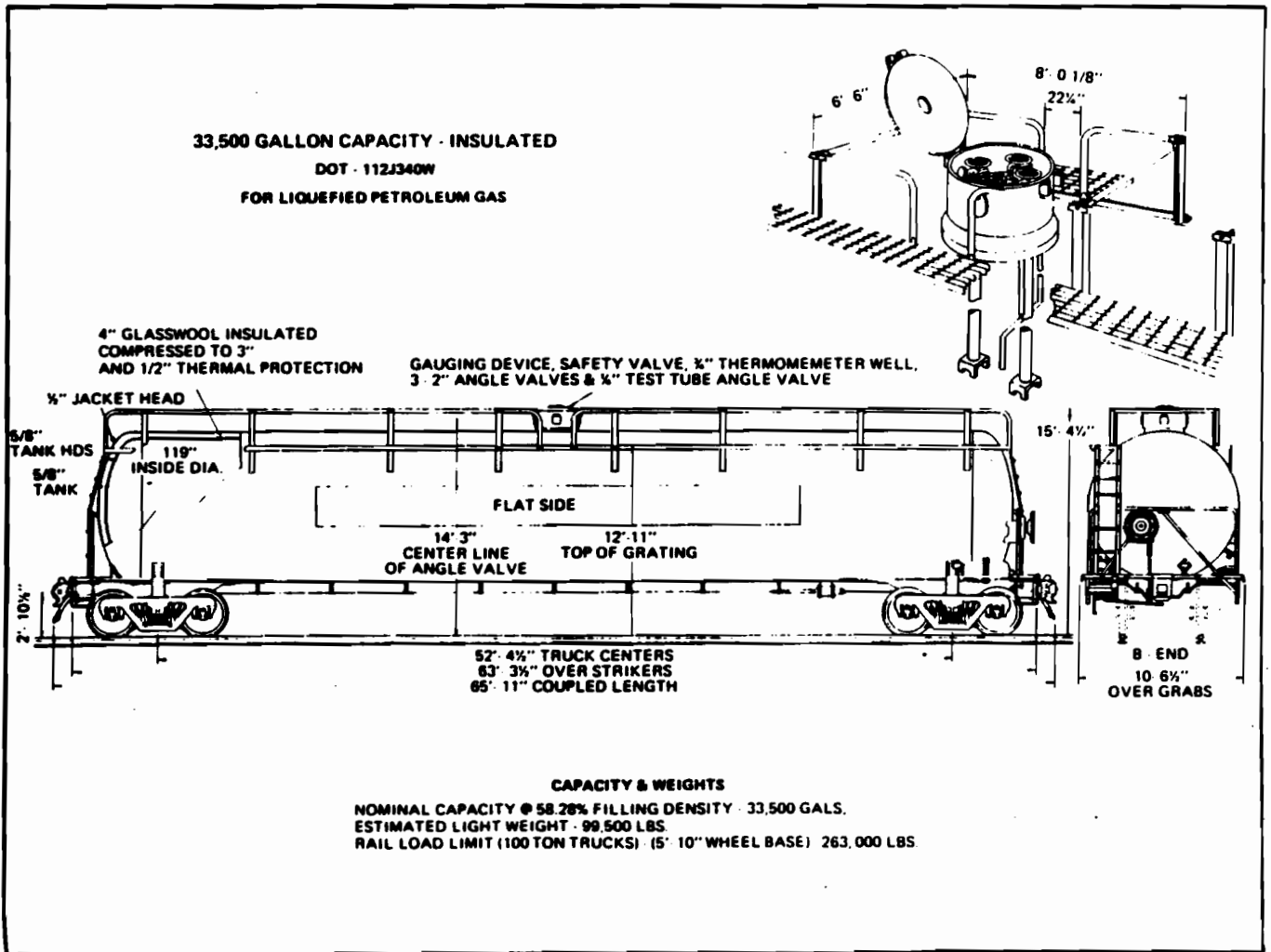

Attachment 3.2-1

Rail Tank Cars
(continued)

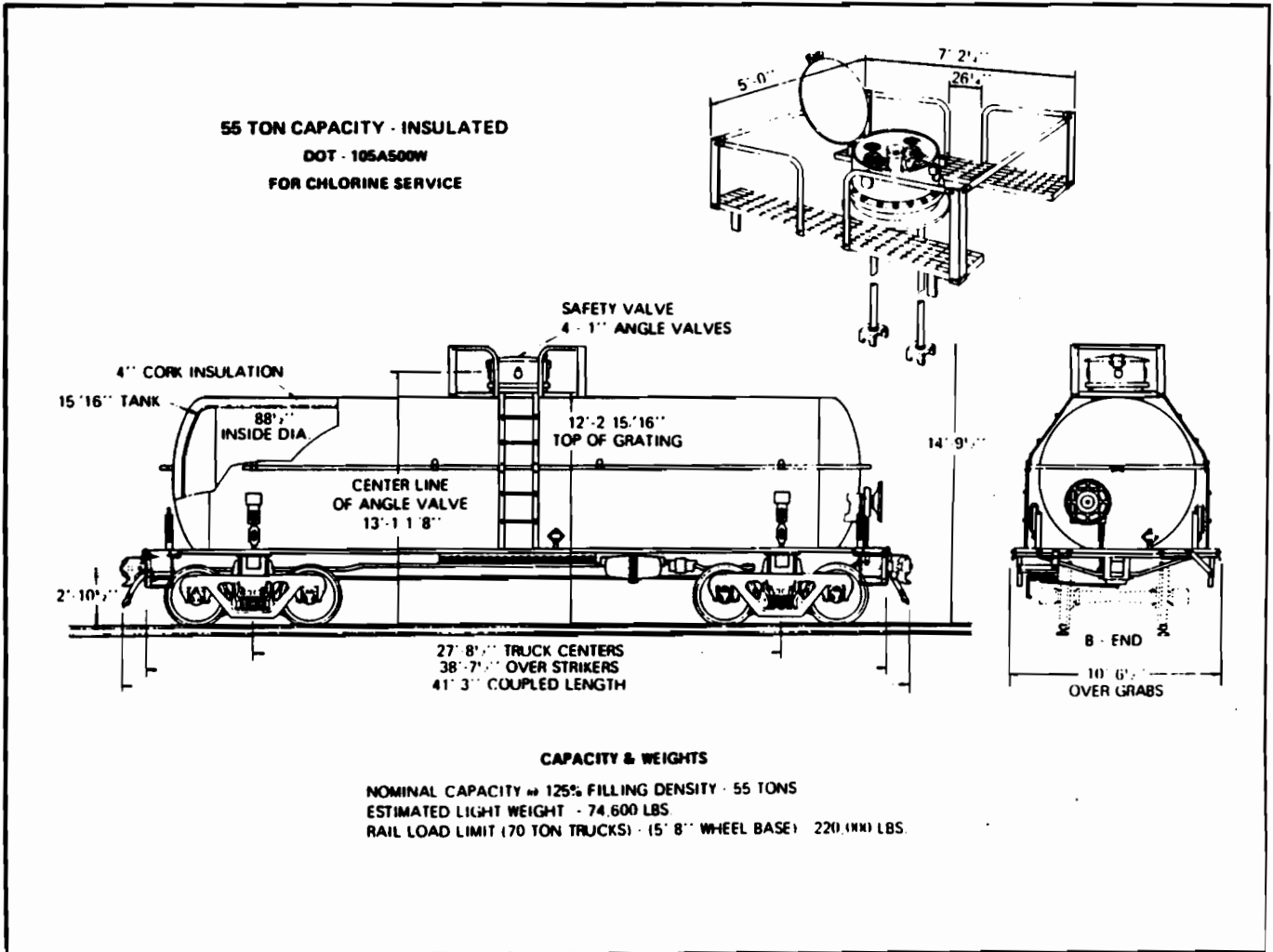

Attachment 3.2-1

Rail Tank Cars
(continued)

20,000 GALLON CAPACITY - NON INSULATED
DOT - 111A100W5
FOR HYDROCHLORIC ACID SERVICE
(POST 1982)

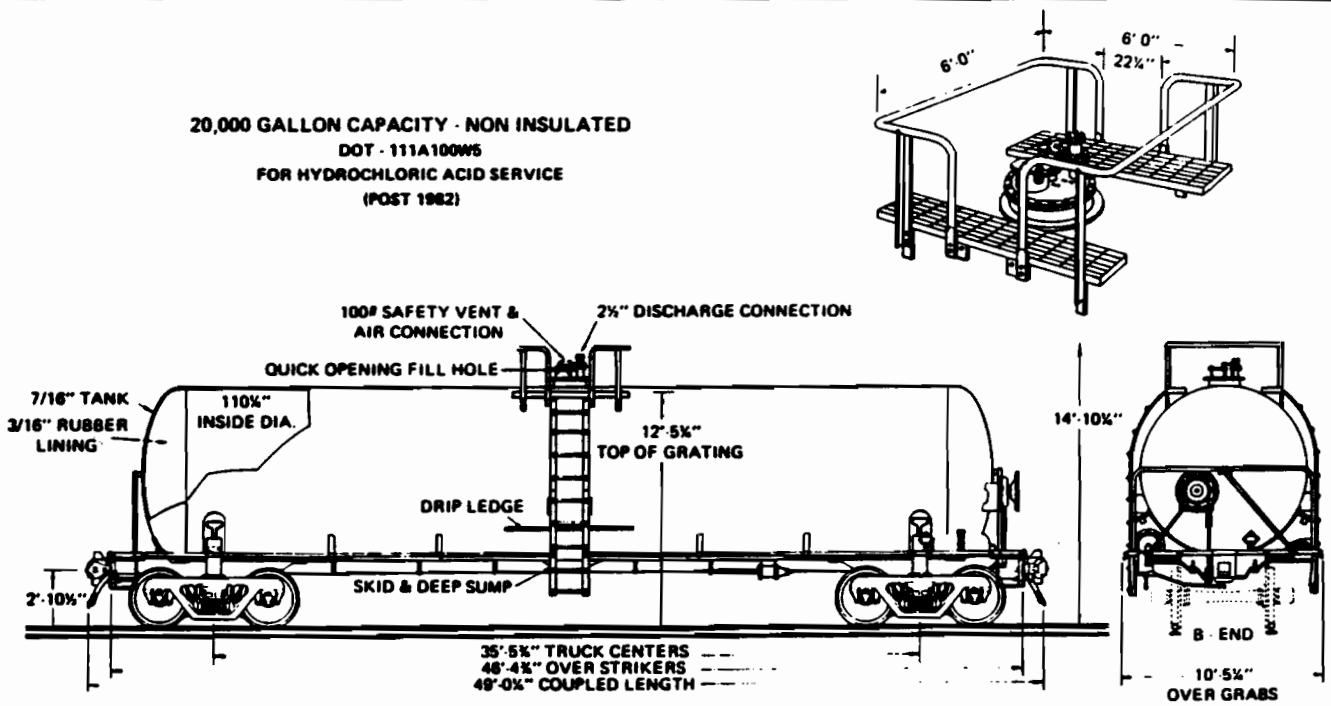

CAPACITY & WEIGHTS

NOMINAL CAPACITY @ 2% OUTGAGE - 20,000 GALS.
ESTIMATED LIGHT WEIGHT 58,600 LBS.
RAIL LOAD LIMIT (100 TON TRUCKS) - 263,000 LBS.

COMMODITY MAXIMUM DENSITY

TRUCK CAPY.	WHEEL BASE	NON-COILED COMM. WT./GAL.
100 TON	5'-10"	10.198#

Attachment 3.2-1

Rail Tank Cars
(continued)

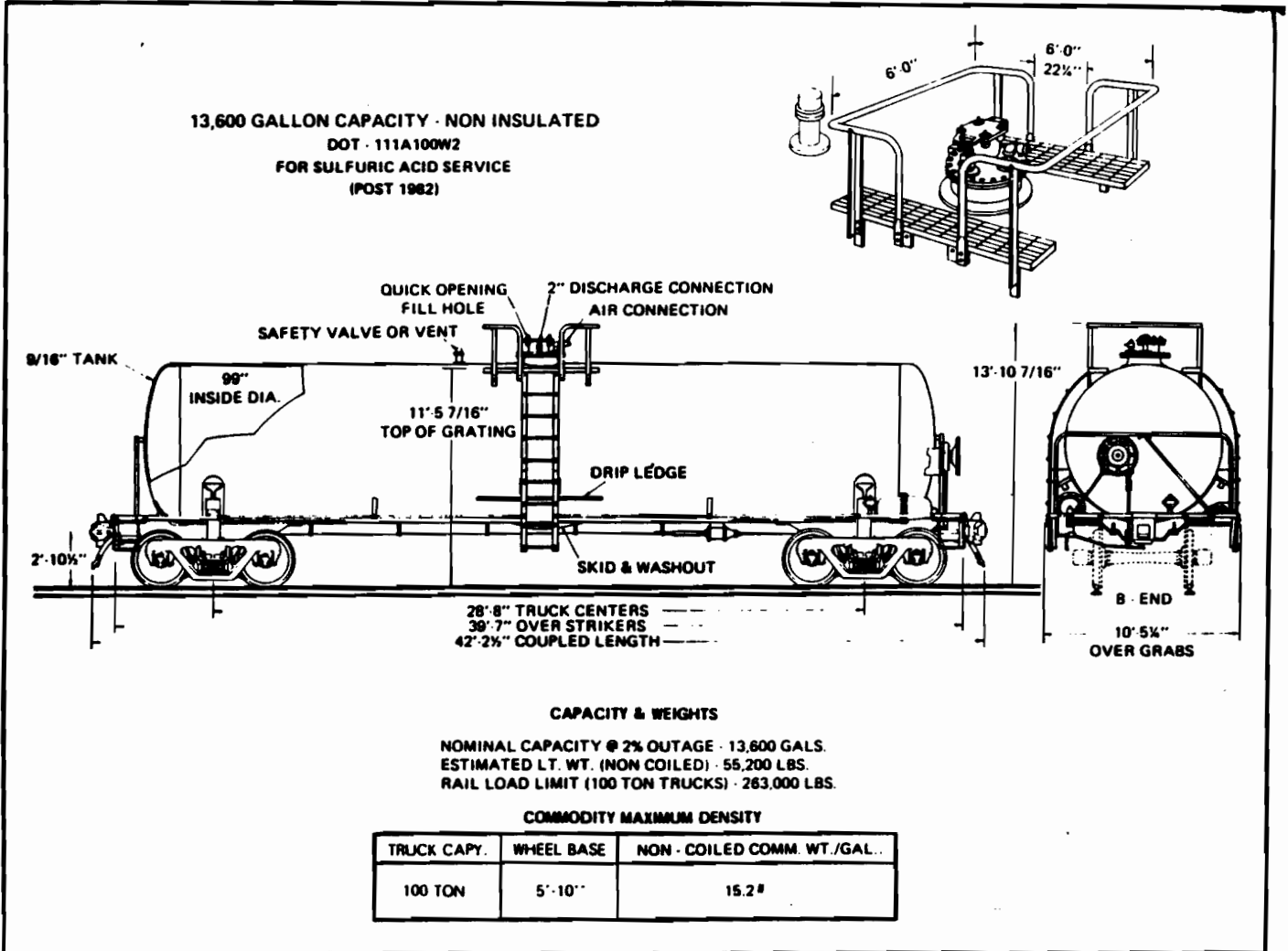

Attachment 3.2-1

Rail Tank Cars
(continued)

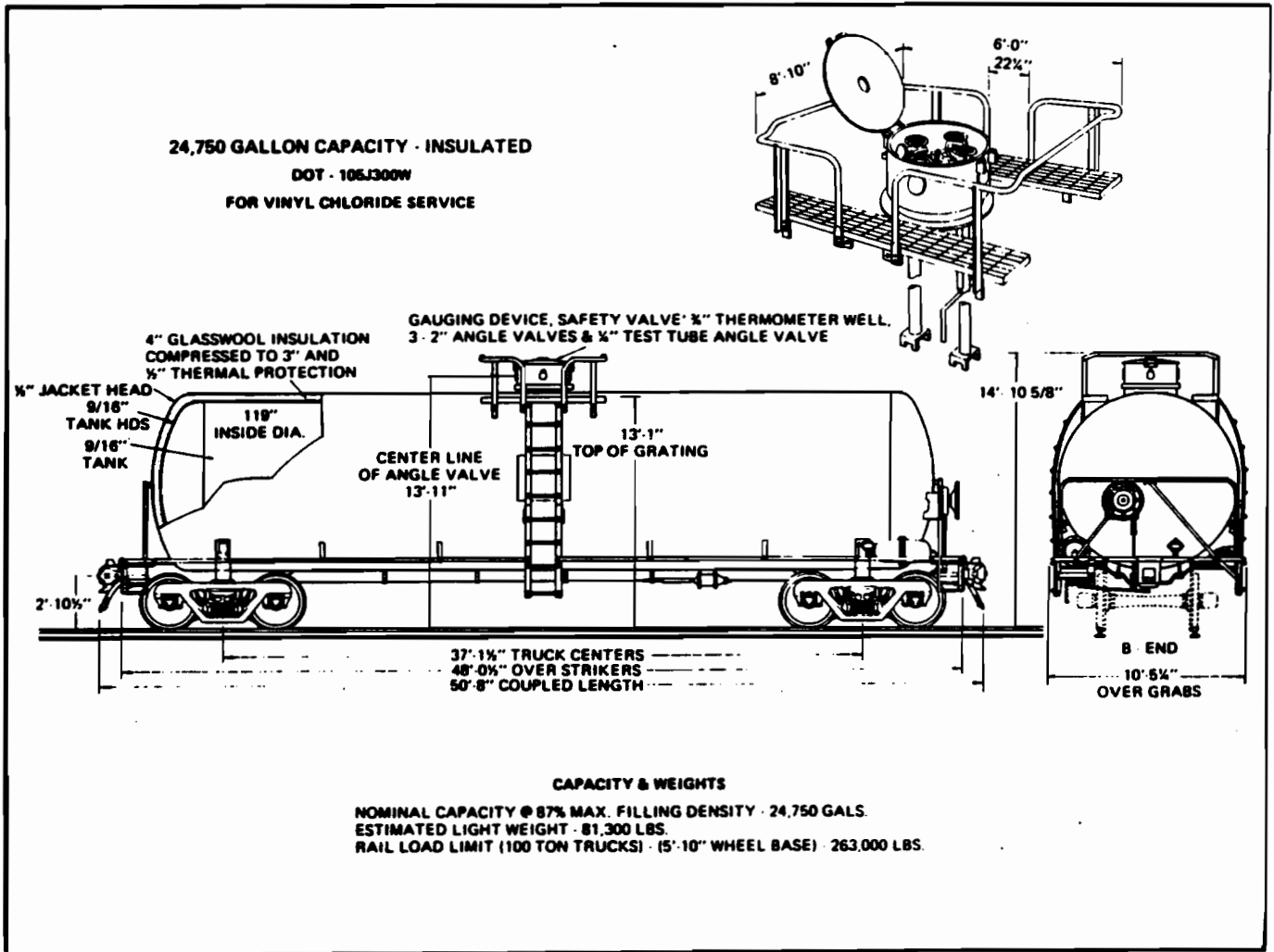



U.S. Department of Transportation
Federal Highway Administration

CARGO TANK INSPECTION GUIDE

MC 306

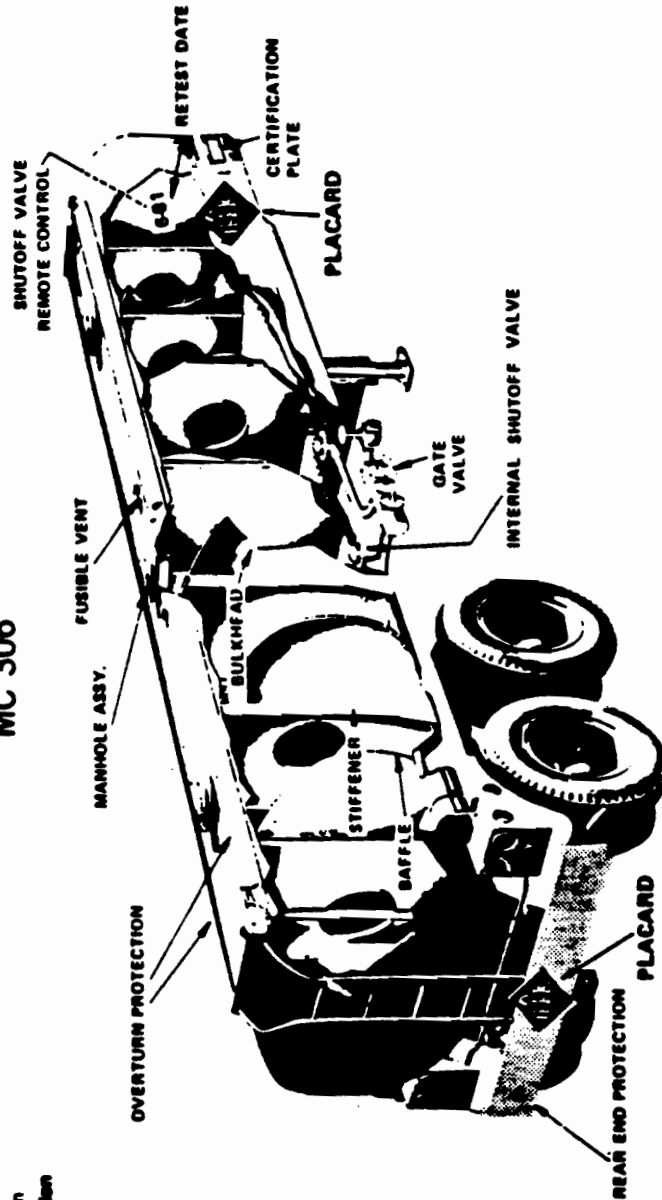

Attachment 3.2-2 Cargo Trucks and Tankers

LEFT SIDE

Sidemarkers lights-393.14
Reflectors-393.14
Tires and wheels-393.75
Placard-177.823
ID Nos.-177.823

REAR

Tail lights-393.14
Stop lights-393.14
Turn signals-393.14
4-way flasher-393.19
Clearance lights-393.14
Identification lights-393.14
Reflectors-393.14
Rear end protection-393.86 & 178.340-8
Placard-177.823
ID Nos.-177.823

RIGHT SIDE

Sidemarkers lights-393.14
Reflectors-393.14
Tires and wheels-393.75
Placard-177.823
Specification plate-178.340-10
Date of retest-177.824
ID Nos.-177.823

FRONT

Shutoff valve remote control -178.341-5
Placard-177.823
Clearance lights-393.14
ID Nos.-177.823

TOP

Manhole Assembly-177.341-3
Vents-178.341-4
Overturn protection-178.340-8

Cargo Trucks and Tankers
(continued)

CARGO TANK INSPECTION GUIDE
MC 307

US Department of Transportation
Federal Highway Administration

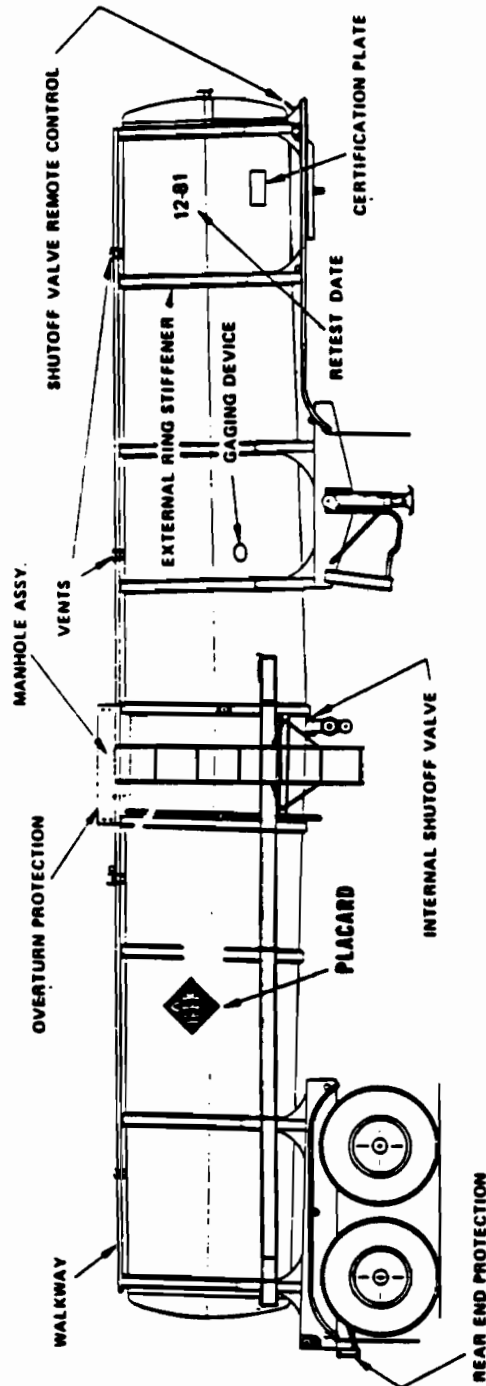

LEFT SIDE

- Sidemarket lights-393.14
- Reflectors-393.14
- Tires and wheels-393.75
- Placard-177.823
- ID Nos. - 177.823

REAR

- Tail lights-393.14
- Stop lights-393.14
- Turn signals-393.14
- 4-way flasher-393.19
- Clearance lights-393.14
- Identification lights-393.14
- Reflectors-393.14
- Placard-177.823
- ID Nos. - 177.823
- Rear end protection-393.86 & 178.340-8

NOTE: Not necessarily external rings

RIGHT SIDE

- Sidemarket lights-393.14
- Reflectors-393.14
- Tires and wheels-393.75
- Placard-177.823
- Certification plate-178.340-10
- Retest date-177.824
- Gaging device-178.342-6
- ID Nos. - 177.823

FRONT

- Shutoff valve remote control-178.342-5
- Placard-177.823
- Clearance lights-393.14
- ID Nos. - 177.823

TOP

- Vents-178.342-4
- Manhole-178.342-3

Cargo Trucks and Tankers
(continued)

CARGO TANK INSPECTION GUIDE
MC 312

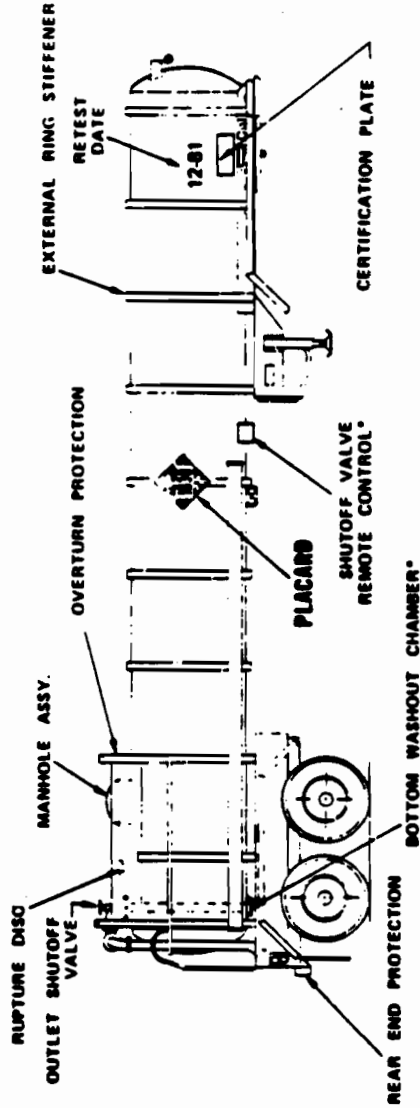

*AFTER 1/1/76 TANKS MUST BE EQUIPPED WITH INTERNAL SHUTOFF VALVE IF BOTTOM UNLOADED. (178.343-6)

LEFT SIDE

- Sidemarket lights-393.14
- Reflectors-393.14
- Tires and wheels-393.75
- Placard-177.823
- ID Nos.-177.823

REAR

- Tail lights-393.14
- Stop lights-393.14
- Turn signals-393.14
- 4-way flasher-393.19
- Clearance lights-393.14
- Identification lights-393.14
- Reflectors-393.14
- Rear end protection-393.86 & 178.310.R
- Placard-177.823
- ID Nos.-177.823

Bureau of Motor Carrier Safety 1/82

RIGHT SIDE

- Side marker lights-393.14
- Reflectors-393.14
- Tires and wheels-393.75
- Placard-177.823
- Certification plate-178.340-10
- Retest Date-177.824
- Washout chamber-178.343-5
- ID Nos.-177.823

FRONT

- Placard-177.823
- Clearance lights-393.14
- ID Nos.-177.823
- Remote discharge control - 178.343-5

TOP

- Manhole assembly-178.343-3
- Vent or rupture disc-178.343-4

Attachment 3.2-2

Cargo Trucks and Tankers
(continued)

MC 310, MC 311, MC 312 CORROSIVE MATERIALS

EXAMPLE - CHEMICALS, ACIDS

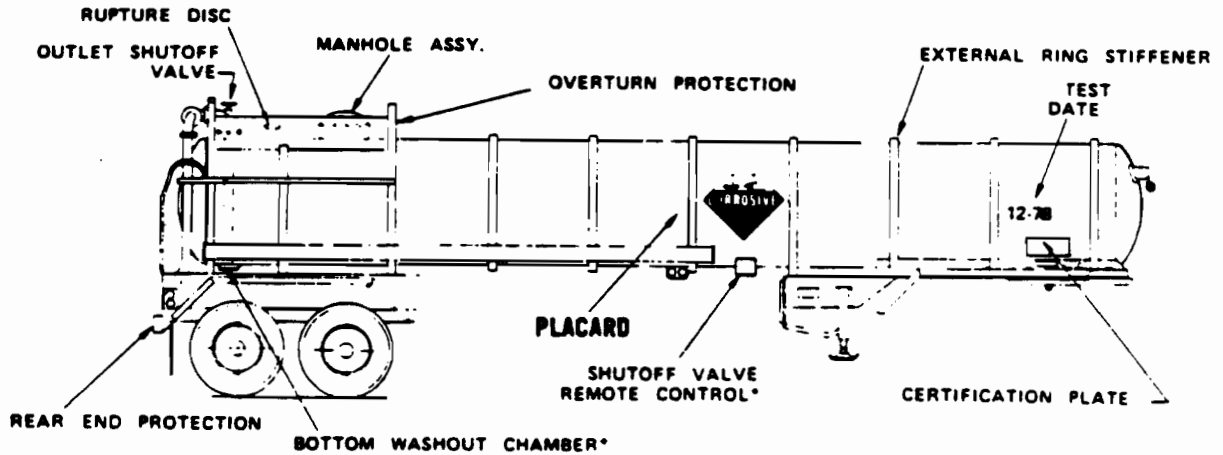

* MC312 CARGO TANKS MANUFACTURED AFTER JANUARY 1, 1974 MUST BE EQUIPPED WITH INTERNAL SHUTOFF VALVE IF BOTTOM UNLOADED.

MC 330, MC 331 COMPRESSED GAS

EXAMPLE:

FLAMMABLE: PROPANE, BUTANE, LP GAS
NON-FLAMMABLE: ANHYDROUS AMMONIA

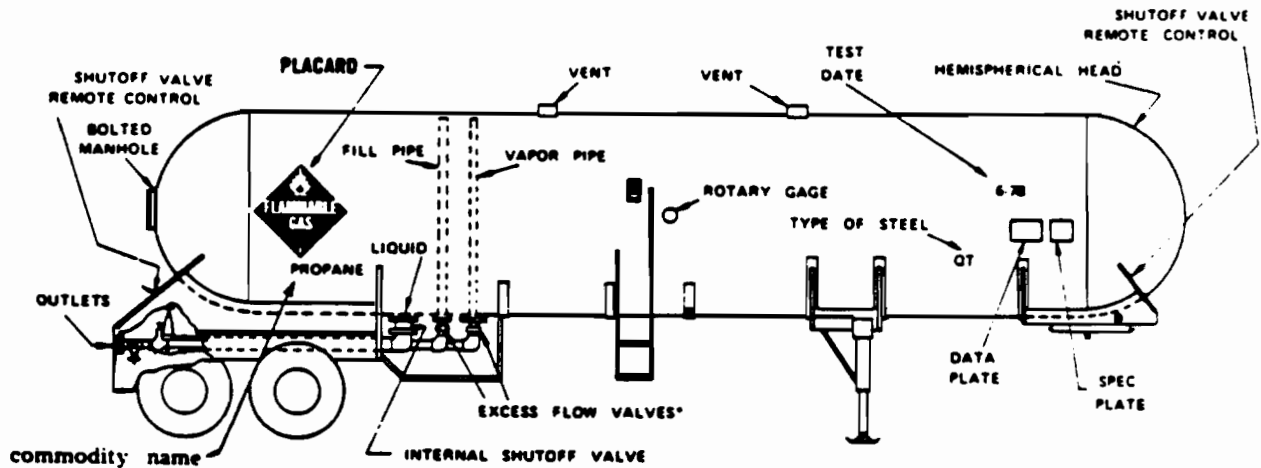

*MC 331 CARGO TANKS MANUFACTURED AFTER MARCH 31, 1974 MUST HAVE INTERNAL SHUTOFF VALVES AT LIQUID AND VAPOR DISCHARGE OPENINGS. MC 330 CARGO TANKS MUST BE RETROFITTED WITH INTERNAL SHUTOFF VALVES AT LIQUID DISCHARGE OPENINGS BY MARCH 31, 1980

Source: Department of Transportation, Transportation Safety Institute.

Attachment 3.2-2

Cargo Trucks and Tankers
(continued)

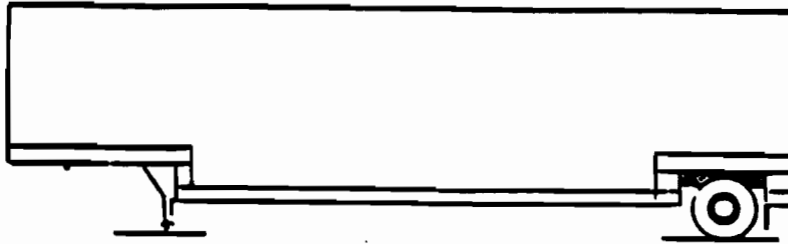

FURNITURE VAN

**MAY BE HAULING ANY PRODUCT FOUND IN THE HOME, OFFICE OR WAREHOUSE,
THAT MAY OR MAY NOT BE HAZARDOUS MATERIAL.**

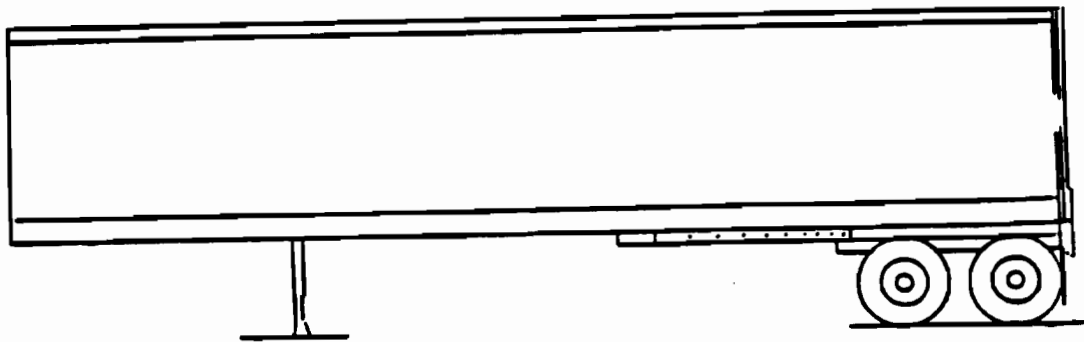

SEMI AND STRAIGHT TRUCK VAN

**BOTH OF THESE VEHICLES SHOULD BE APPROACHED WITH EXTREME CAUTION AS THEY
MAY CONTAIN MOST ANY TYPE OF HAZARDOUS MATERIAL.**

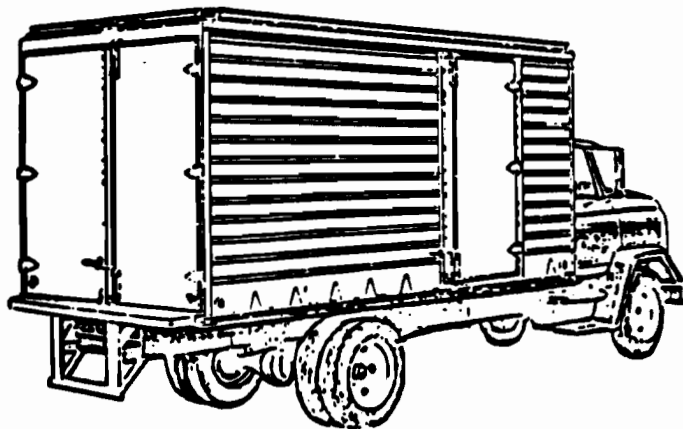

FAR AC 88-01424

Source: Department of Transportation, Transportation Safety Institute.

Attachment 3.2-3

Types of Barges and Sea-Going Tankers

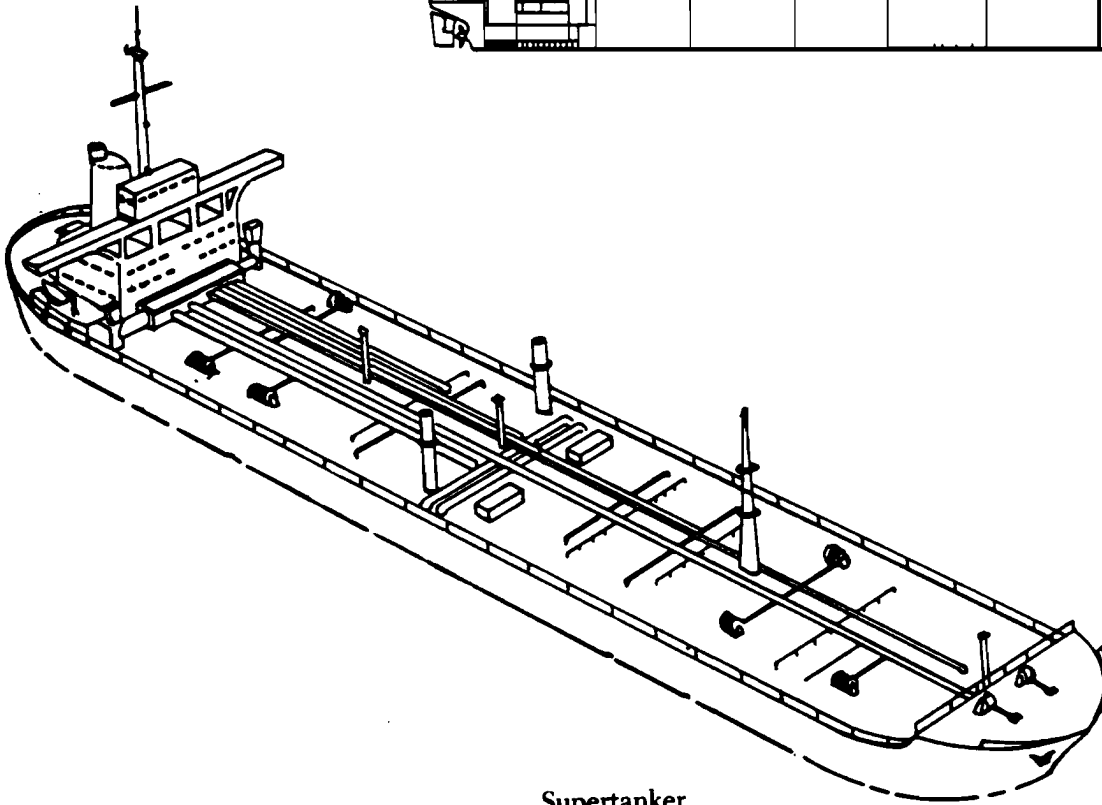
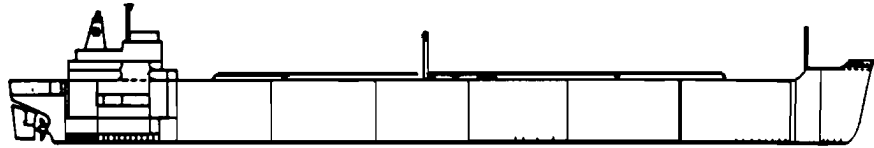

Supertanker.

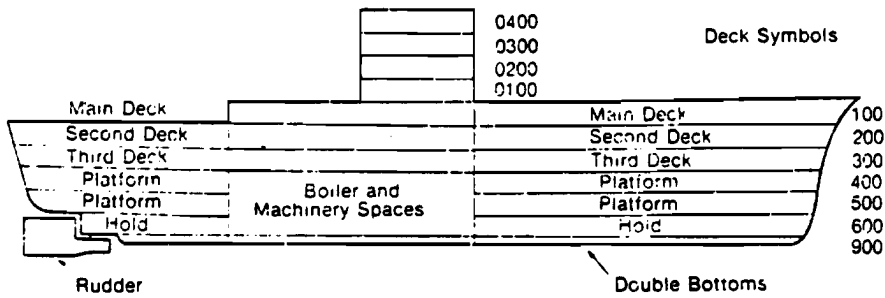

- The system of naming and numbering decks of a ship.

Attachment 3.2-3

Types of Barges and Sea-Going Tankers
(continued)

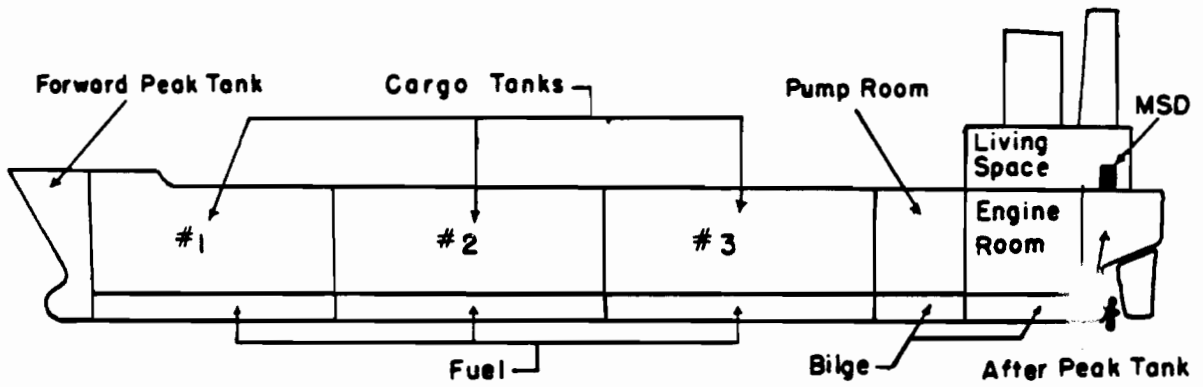

- Cargo tank layout.

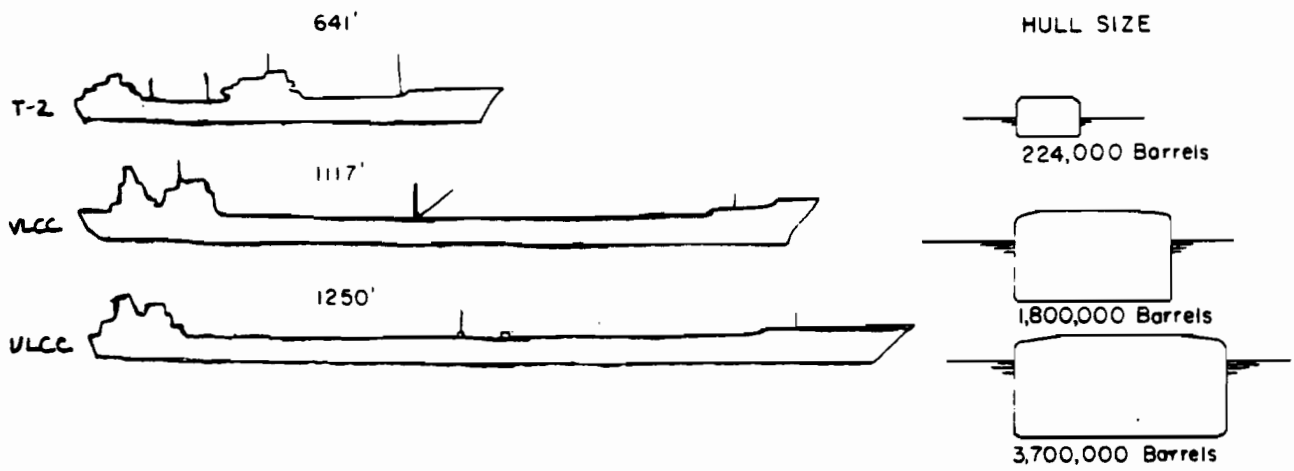

- Tank vessel comparison.

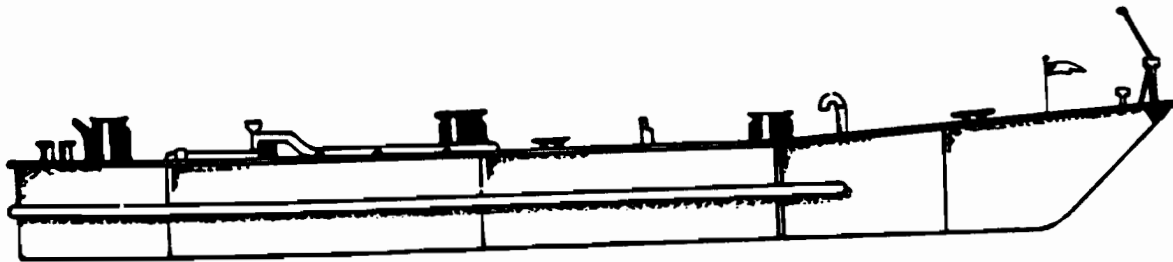

- Typical Tank Barge.

Attachment 3.2-3

Types of Barges and Sea-Going Tankers
(continued)

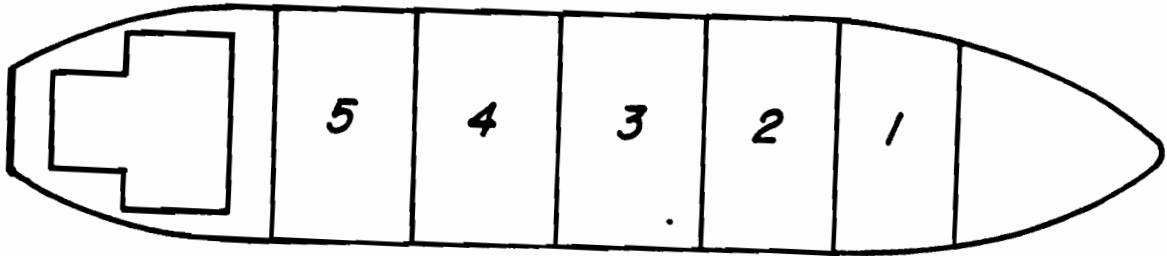

Tank Ship Holds.

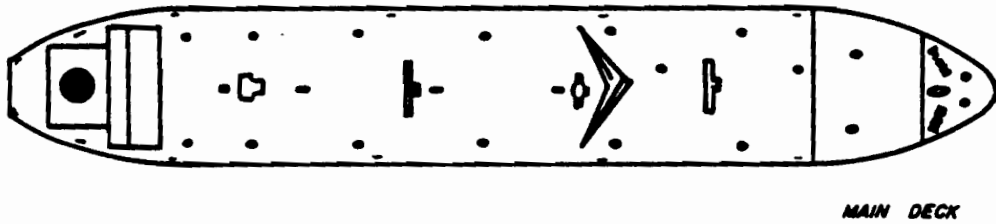
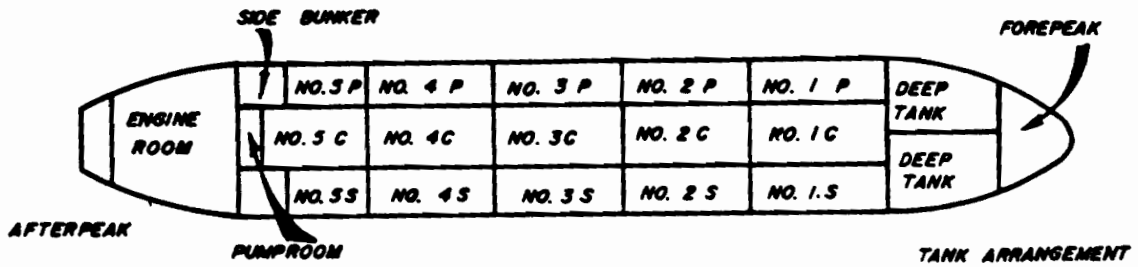
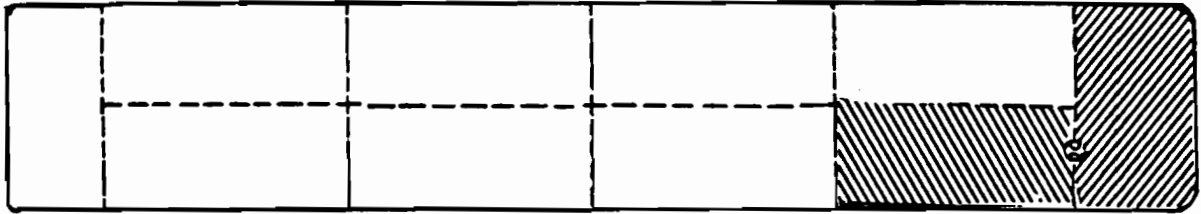

Figure 2-4. - Tank Ship Design.

Attachment 3.2-3

Types of Barges and Sea-Going Tankers
(continued)



TYPE I BARGE -

Must retain positive buoyancy & stability after being holed in way of transverse watertight bulkhead

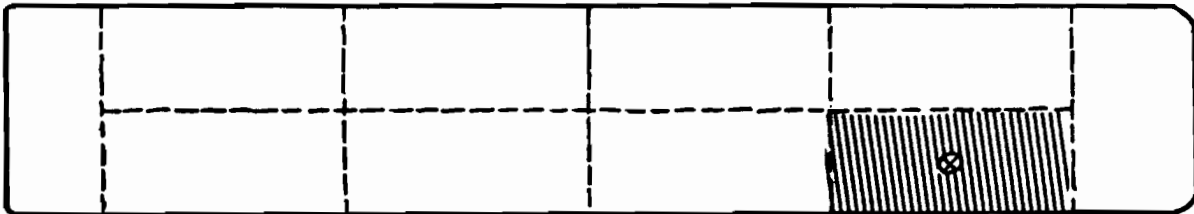
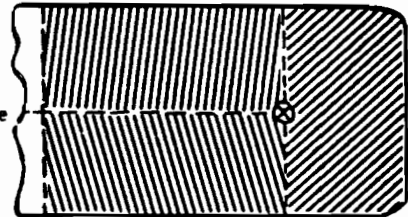

TYPE II BARGE -

Must retain positive buoyancy & stability after being holed anywhere **EXCEPT** in way of a transverse watertight bulkhead

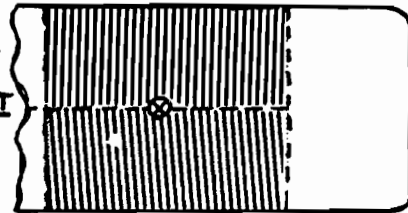

Buoyancy and stability criteria for types I and II barges.

Attachment 3.2-3

Types of Barges and Sea-Going Tankers
(continued)

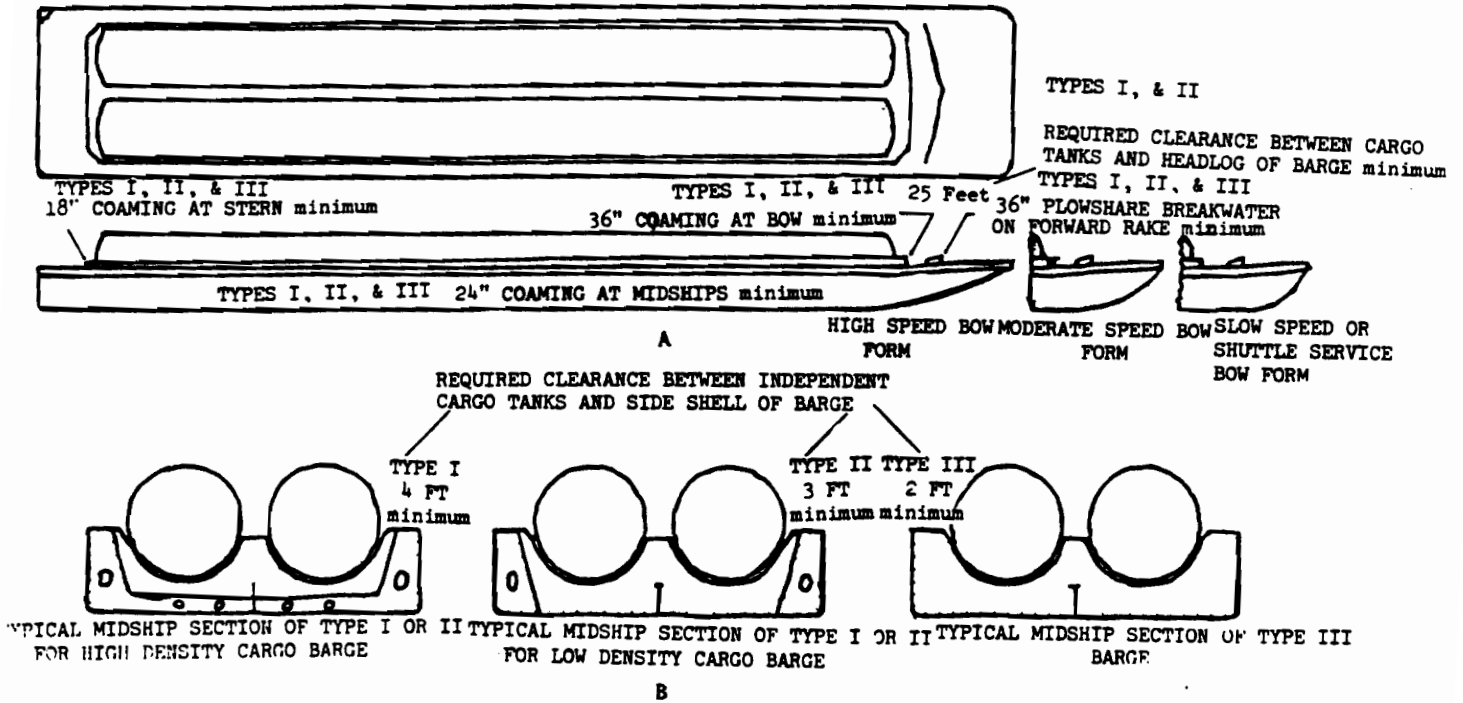

Typical arrangements of types I, II, and III barges carrying dangerous cargoes.