

---

**NEW YORK STATE**  
**DESIGN STANDARDS FOR**  
**INTERMEDIATE SIZED**  
**WASTEWATER TREATMENT SYSTEMS**

**MARCH 5, 2014**

---



**New York State**  
**Department of Environmental Conservation**  
**Division of Water**  
**625 Broadway**  
**Albany, New York 12233-3505**



Andrew M. Cuomo, Governor

Joe Martens, Commissioner

---

Photos on cover courtesy of: Lenning, D., T. Banathy, D. Gustafson, B.J. Lesikar, S. Wecker, D. Wright. 2005. Technology Overview Module. in (D.L. Lindbo and N.E. Deal eds.) Model Decentralized Wastewater Practitioner Curriculum. National Decentralized Water Resources Capacity Development Project. North Carolina State University, Raleigh, NC.

The technologies shown on the cover are from other States and may not conform to these Design Standards. In the case of any conflict between the apparent installation of a technology from any of the cover photos and the specifications in the figures, tables or text of these Design Standards, the Design Standards shall be used.

## Foreword

The Clean Water Act (CWA) was enacted to restore and maintain the chemical, physical, and biological integrity of the nation's surface waters. This was to be done by reducing direct pollutant discharges into waterways, financing municipal wastewater treatment facilities, developing technology necessary to eliminate the discharge of pollutants, and by managing polluted runoff.

In New York State, Article 17 of the Environmental Conservation Law (ECL), "Water Pollution Control," was enacted to protect and maintain both surface and groundwater resources. It authorized the creation of the State Pollutant Discharge Elimination System (SPDES) Program to protect New York's water resources. On-site Wastewater Treatment Systems (OWTS) may discharge to either surface water or groundwater.

Pursuant to Article 17 Title 7 of the ECL all OWTSs, without the admixture of industrial or other waste, and with a groundwater discharge of 1,000 gallons per day or greater or a surface water discharge of any size, must be covered by a SPDES permit issued by the New York State Department of Environmental Conservation (NYSDEC).

Design standards for large Publicly Owned Treatment Works (POTWs) have been updated independently by the Great Lakes-Upper Mississippi River Board of State and Provincial Public Health and Environmental Managers (GLUMRB) and the New England Interstate Water Pollution Control Commission (NEIWPCC). Design standards for small individual residential systems are updated by the New York State Department of Health (NYSDOH), local county health departments, or watershed organizations. These Design Standards for Intermediate Sized Wastewater Treatment Systems (Design Standards) are being updated by NYSDEC to meet the needs not addressed by the large and small systems design standards (refer to Appendix A for the applicable technical standard). Over the last 20 years OWTS technologies have increased in the level of treatment provided and in complexity of design and operation. It is appropriate that the Design Standards are updated now to remain current with the needs of the wastewater treatment system design professionals.

Numerous references to the GLUMRB's *Recommended Standards for Wastewater Facilities, (Ten States Standards), 2004* and NEIWPCC's *Guides for the Design of Wastewater Treatment Works -Technical Report-16, 2011 (TR-16)*, appear in this manual. *Ten States Standards* has been adopted by NYSDEC as New York State's official standards for municipal wastewater treatment and collection facilities according to 6 NYCRR Part 750-2.10.g.1. *Ten States Standards* may be viewed at: <http://10statesstandards.com>, and

is available in print from Health Education Service, Inc., P.O. Box 7126, Albany, New York 12224, 518-439-7286. Health Education Services (HES) may be accessed online at <http://www.healthresearch.org>. *TR-16* is also an acceptable design standard for municipal systems of any size, or any nonmunicipal, intermediate sized systems that treat only sanitary wastewater. *TR-16* addresses standards for alternative collection systems such as vacuum sewers, low pressure/grinder pump sewers, septic tank effluent (pump) and septic tank effluent (gravity) sewers (STEP/STEG).

NYSDOH regulations for residential wastewater treatment systems discharging less than 1,000 gpd are entitled “*Appendix 75-A, Wastewater Treatment Standards – Residential Onsite Systems.*” Design guidance for residential onsite systems are published under the title *Residential Onsite Wastewater Treatment Systems Design Handbook*. The NYSDOH Design Handbook is available from HES, Inc. (<http://www.healthresearch.org>). Both documents are on the NYSDOH website.

# Table of Contents

Foreword.....	i
List of Acronyms .....	viii
List of Tables .....	xiii
List of Figures.....	xiv
Disclaimer.....	xv
Introduction.....	Intro - 1
Purposes of These Design Standards:.....	Intro - 1
How to Use These Design Standards:.....	Intro - 2
A. Facility Planning and Permitting.....	A - 1
A.1 Introduction.....	A - 1
A.2 Planning and Permit Application Process.....	A - 1
A.3 Obtaining a SPDES Permit for a Wastewater Discharge.....	A - 3
A.4 State Environmental Quality Review (SEQR).....	A - 5
A.5 Asset Management.....	A - 5
B. Project Evaluation.....	B - 1
B.1 Introduction.....	B - 1
B.2 Site Evaluation.....	B - 1
B.3 Separation Distances.....	B - 1
B.4 Soil Evaluation for Subsurface Discharge.....	B - 5
B.4.a Deep Soil.....	B - 7
B.4.b Percolation Testing.....	B - 8
B.5 Locating Facility Relative to Flood Plains.....	B - 10
B.6 Design Criteria.....	B - 12
B.6.a Wastewater Characterization.....	B - 12
B.6.b Design Flow.....	B - 15
B.6.c Infiltration, Inflow, Non-Sanitary and Prohibited Flows.....	B - 20

B.6.d	Treatment Considerations and Effluent Limits .....	B - 211
B.7	Groundwater Monitoring and Monitoring Well Requirements for Systems Greater than 30,000 gpd .....	B - 24
C.	Sewers and Sewage Pumping Stations.....	C - 1
C.1	Introduction.....	C - 1
C.2	Building Sewers .....	C - 1
C.3	Conventional (solids handling) Gravity Sewers, Manholes and Pump Stations.....	C - 2
C.3.a	Conventional Gravity Sewers .....	C - 2
C.3.b	Conventional Sewer Manholes .....	C - 4
C.3.c	Sewage Pumping Stations.....	C - 5
C.4	Effluent Sewers.....	C - 9
C.4.a	Septic Tank Effluent Gravity (STEG) Sewers.....	C - 13
C.4.b	Septic Tank Effluent Pump (STEP) Sewers.....	C - 15
C.4.c	Septic Tank Effluent Manholes and Cleanouts.....	C - 16
C.5	Conventional Force Mains.....	C - 17
C.6	Small Diameter Solids Carrying Sewers: Low-Pressure Grinder Pump (minimum 2" diameter) and Vacuum (minimum 3" diameter) Sewers.....	C - 19
C.6.a	Grinder Pump (Low-Pressure) Sewers.....	C - 19
C.6.b	Vacuum Sewers.....	C - 24
C.7	Water Supply Line and Sewer Separation .....	C - 255
C.8	Creek Crossings .....	C - 266
C.9	Instruction Manuals .....	C - 27
D.	Preliminary and Primary Treatment, Flow Measurement and Appurtenances .....	D - 1
D.1	Introduction.....	D - 1
D.2	Preliminary Treatment Devices .....	D - 1
D.3	Flow Equalization.....	D - 1
D.4	Flow Measurement.....	D - 2
D.5	Fats, Oils and Grease (FOG) Removal and Grease Interceptors.....	D - 3

D.6	Septic Tanks.....	D - 13
D.7	Effluent Screens / Filters (for septic tanks and grease interceptors).....	D - 21
D.8	Dosing Stations .....	D - 22
D.9	Distribution Boxes / Flow Splitters.....	D - 22
D.10	Wastewater Dumping Station .....	D - 23
D.11	Holding Tanks.....	D - 24
D.12	Source Separation and Graywater Irrigation Systems .....	D - 25
E.	Subsurface Treatment and Discharge .....	E - 1
E.1	Introduction.....	E - 1
E.2	Application Rates.....	E - 2
E.3	Nitrate Advisory for Groundwater Discharge.....	E - 5
E.4	Distribution Networks.....	E - 5
E.5	Pressurized Distribution System .....	E - 10
E.6	Design of Dosed Distribution Systems (pump to gravity) .....	E - 12
E.7	Reserve Area.....	E - 15
E.8	Absorption Trenches/Beds.....	E - 17
E.9	Shallow Absorption Trenches .....	E - 21
E.10	Aggregate and Alternative Aggregate.....	E - 23
E.11	Gravelless (Aggregate-Free) Absorption Systems.....	E - 24
E.11.a	Allowance for Reduction in Field Size for Renovations on Existing Properties .....	E - 24
E.11.b	Specifications for Gravelless (Aggregate-Free) Absorption Systems.....	E - 24
E.12	Cut-and-Fill Systems .....	E - 26
E.13	Raised Systems .....	E - 29
E.14	Mound Systems.....	E - 33
E.15	Artificially Drained Systems.....	E - 39
E.16	Seepage Pits .....	E - 42
E.17	Pressurized Shallow Narrow Drainfields (PSND).....	E - 46
E.18	Drip and Other Low-Profile Dispersal Systems.....	E - 47

F.	Secondary Treatment .....	F - 1
F.1	Introduction.....	F - 1
F.2	Media Filtration and Alternative Media.....	F - 4
F.2.a	General.....	F - 4
F.2.b	Single-Pass Sand Filters.....	F - 7
F.2.c	Recirculating Sand/Media Filters (RSF).....	F - 12
F.3	Rotating Biological Contactor (RBC).....	F - 19
F.4	Media Bio-Towers .....	F - 21
F.5	Activated Sludge.....	F - 22
F.6	Sequencing Batch Reactor (SBR).....	F - 25
F.7	Oxidation Ditches .....	F - 27
F.8	Lagoons (Wastewater Treatment Ponds).....	F - 29
G.	Tertiary Treatment .....	G - 1
G.1	Introduction.....	G - 1
G.2	Granular Media Filters: High-Rate or Low-Rate Secondary Effluent Filtration .....	G - 4
G.3	Physical-Chemical Unit Processes.....	G - 5
G.3.a	Colloid (Suspended Solids) Removal .....	G - 5
G.3.b	Physical-Chemical Phosphorus Removal .....	G - 7
G.3.c	Membrane Processes and Membrane Bio-Reactors (MBRs).....	G - 9
G.4	Biological Nutrient Removal .....	G - 10
G.4.a	Biological Nitrogen Removal .....	G - 11
G.4.b	Biological Phosphorus Removal (BPR).....	G - 12
G.5	Constructed Wetlands .....	G - 12
H.	Innovative Systems .....	H - 1
I.	Disinfection and Reoxygenation.....	I - 1
I.1	Introduction.....	I - 1
I.2	Disinfection and Dechlorination .....	I - 1
I.2.a	Disinfection.....	I - 1



I.2.b	Chlorination .....	I - 1
I.2.c	Dechlorination.....	I - 2
I.2.d	Ultraviolet Disinfection.....	I - 3
I.3	Effluent Reoxygenation .....	I - 5
I.3.a	General.....	I - 5
I.3.b	Diffused or Mechanical Aeration.....	I - 5
I.3.c	Cascade Aeration .....	I - 5
I.4	Outfalls.....	I - 6
I.5	Controlled Release .....	I - 7
J.	Operation, Maintenance, and Control .....	J - 1
J.1	Introduction.....	J - 1
J.2	Systems Requiring a Certified Operator .....	J - 2
J.3	Wastewater Treatment System Operation and Effluent Quality Control.....	J - 2
J.4	Notification Requirements for Emergency Repair and Rehabilitation .....	J - 2
J.5	Remote Telemetry, Instrumentation and Alarms .....	J - 3
J.6	Residuals Hauling and Disposal (6 NYCRR Parts 364 and 360) .....	J - 3
Appendix A	Wastewater Treatment System Regulatory Framework in New York State	Appendix A- 1
Appendix B	Conversion Factors .....	Appendix B - 1
Appendix C	Sewer and Manhole Leakage Tests.....	Appendix C - 1
Appendix D	Reserved.....	Appendix D - 1
Appendix E	Design Examples for Pressure Distribution; Guidance for Mound Systems and Alternative Distribution Systems.....	Appendix E - 1
Appendix E.1	Pressure Distribution Design Example .....	Appendix E - 1
Appendix E.2	Mound Design Example.....	Appendix E - 14
Appendix E.3	Pressurized, Shallow, Narrow Drainfield (PSND) Systems .....	Appendix E - 23
Appendix E.4	Drip and Low Profile Dispersal Systems .....	Appendix E - 30
Appendix F	Single Pass and Recirculating Filter Performance .....	Appendix F - 1
Glossary	.....	Glossary - 1

## List of Acronyms

ABS.....	Acrylonitrile Butadiene Styrene
ACI.....	American Concrete Institute
AgNPs.....	Silver nanoparticles
ANSI.....	American National Standards Institute
AOP.....	Advanced Oxidation Processes
APA.....	Adirondack Park Agency
ASPE.....	American Society of Plumbing Engineers
ASTM.....	ASTM International (formerly known as the American Society for Testing and Materials)
AWWA.....	American Water Works Association
BAF.....	Biologically Active Filters
BNR.....	Biological Nitrogen Removal
BOD.....	Biochemical Oxygen Demand
BPR.....	Biological Phosphorus Removal
BUD.....	Beneficial Use Determination
CIDWT.....	Consortium of Institutes for Decentralized Wastewater Treatment
COD.....	Chemical Oxygen Demand
CSA.....	Canadian Standards Association
CWA.....	Clean Water Act
Department.....	New York State Department of Environmental Conservation
DFU.....	Drainage Fixture Units
DIP.....	Ductile Iron Pipe
DO.....	Dissolved Oxygen
EAF.....	Environmental Assessment Form
EBPR.....	Enhanced Biological Phosphorus Removal
ECL.....	Environmental Conservation Law
ELAP.....	Environmental Laboratory Approval Program
EO.....	Enforcement Officer
EPA.....	United States Environmental Protection Agency
EPRI.....	Electric Power Research Institute
ES.....	Effective Size (of aggregate)
ETU.....	Enhanced Treatment Unit
ETV.....	Environmental Technology Verification
FEMA.....	Federal Emergency Management Agency
FOG.....	Fats, Oils and Grease

FRP .....	Fiberglass Reinforced Plastic
FWS .....	Free Water Surface
GLUMRB .....	Great Lakes - Upper Mississippi River Board
GPCD .....	Gallons per Capita per Day
GPD .....	Gallons per Day
GPM .....	Gallons per Minute
GRD .....	Grease Removal Device
HCR .....	Hydrograph Controlled Release
HDPE .....	High Density Polyethylene
HES .....	Health Education Services <sup>1</sup>
H-O-A .....	Hand-Off-Auto
HSG .....	Hydrologic Soil Group
IAPMO .....	International Association of Plumbing and Mechanical Officials
IF .....	Intermittent Flow
IPC .....	International Plumbing Code
LDR .....	Lateral Discharge Rate
LHD .....	Local Health Department
LLR .....	Linear Loading Rate
MBAS .....	Methylene Blue Active Substances
MBR .....	Membrane Bioreactors
MCRT .....	Mean Cell Residence Time
MF .....	Microfiltration
MGD .....	Million Gallons per Day
MLE .....	Modified Ludzack-Ettinger
MLSS .....	Mixed Liquor Suspended Solids
MOP .....	Water Environment Federation Manual of Practice
MOU .....	Memorandum of Understanding
MPI .....	Minutes per Inch
MSD .....	Marine Sanitation Device
NDR .....	Network Discharge Rate
NEC .....	National Electric Code
NEIWPC .....	New England Interstate Water Pollution Control Commission

---

<sup>1</sup> Health Education Services is a division of Health Research, Inc, a not for profit corporation affiliated with the New York State Department of Health.

NEMA.....	National Electrical Manufacturers Association
NF .....	Nanofiltration
NJDEP .....	New Jersey State Department of Environmental Protection
NOWRA .....	National Onsite Wastewater Recycling Association
NPCA.....	National Precast Concrete Association
NSF .....	NSF International (formerly National Sanitation Foundation)
NYCDEP .....	New York City Department of Environmental Protection
NYCRR.....	New York Codes, Rules and Regulations
NYSDEC .....	New York State Department of Environmental Conservation
NYSDOH .....	New York State Department of Health
NYSDOT .....	New York State Department of Transportation
NYSEDRA.....	New York State Energy Research and Development Authority
O&M.....	Operation and Maintenance
OSHA.....	Occupational Safety and Health Administration
OWTS .....	Onsite Wastewater Treatment System
PCANY .....	Precast Concrete Association of New York
PCI.....	Private, Commercial, and Institutional
PCNYS.....	Plumbing Code of NYS
PDI.....	Plumbing and Draining Institute
POTW .....	Publicly Owned Treatment Works
PSI.....	Pounds per Square Inch
PSM .....	A type of PVC drainage pipe
PVC.....	Poly Vinyl Chloride
RAS.....	Return Activated Sludge
RBC .....	Rotating Biological Contactor
RME.....	Responsible Management Entity
RO.....	Reverse Osmosis
RSF .....	Recirculating Sand Filters
RV .....	Recreational Vehicle
SBR .....	Sequencing Batch Reactor
SCFM.....	Standard Cubic Feet per Minute
SDC.....	Sewage Disposal Corporation
SDG .....	Small Diameter Gravity
SDR.....	Standard Dimension Ratio (ratio of pipe diameter to wall thickness)
SDWA.....	Safe Drinking Water Act

SEQR .....	State Environmental Quality Review
SF .....	Subsurface Flow
SPDES .....	State Pollutant Discharge Elimination System
SSWMP .....	Small Scale Waste Management Project (Wisconsin)
STA .....	Soil based Treatment Area
STEG .....	Septic Tank Effluent Gravity
STEP .....	Septic Tank Effluent Pump
STS.....	Soil based Treatment Systems
SWC.....	Sewage Works Corporation
TCL.....	Transportation Corporations Law (of NYS)
TDA .....	Tire Derived Aggregated
TDH.....	Total Dynamic Head
TDS.....	Total Dissolved Solids
TFS.....	Technology Fact Sheet (EPA OWTS Manual 2002)
TKN .....	Total Kjeldahl Nitrogen
TMDL .....	Total Maximum Daily Load
TN .....	Total Nitrogen
TOC .....	Total Organic Carbon
TOGS.....	Technical & Operating Guidance Series
TP.....	Total Phosphorus
<i>TR-16</i> .....	<i>Technical Report-16</i> (by NEIWPCC)
TSS.....	Total Suspended Solids
TVA .....	Tennessee Valley Authority
UC .....	Uniformity Coefficient
UF .....	Ultra-filtration
UIC.....	Underground Injection Control
UL .....	Underwriters Laboratories, Inc
UPA .....	Uniform Procedures Act
UPC.....	Uniform Plumbing Code
USDA.....	United States Department of Agriculture
USGS .....	United States Geological Society
UVT .....	Ultraviolet Transmittance
VSB.....	Vegetated Submerged Beds
VF .....	Vertical Flow
WEF.....	Water Environment Federation

WERF ..... Water Environment Research Foundation  
WPA..... Watershed Protection Agency  
WQBEL ..... Water Quality Based Effluent Limits  
WTP..... Water Treatment Plant  
WWTP ..... Wastewater Treatment Plant

## List of Tables

B-1 Recommended Minimum Aerial Separation Distance (in feet) from Treatment Facility.....	B-3
B-2 Minimum Horizontal Separation Distance (in feet).....	B-4
B-3 Typical Per-Unit Hydraulic Loading Rates.....	B-16
B-4A Typical Effluent Limits for Non-Intermittent Streams .....	B-22
B-4B Typical Effluent Limits for Intermittent Streams.....	B-23
C-1 Minimum Size of Sewer Appurtenances .....	C-5
C-2 Comparison of Commonly Used Pipe Materials for STEP/STEG Systems .....	C-10
C-3 Quick Comparison of Collection Alternatives.....	C-12
D-1 Gravity (Type II) Grease Interceptor Sizing Based on Grease-Laden Building Sewer Flowing Half Full .....	D-6
D-2 Septic Tank Sizing (effective volume) for Multi-Home Dwellings, Private, Commercial and Institutional Applications.....	D-14
E-1 Recommended Sewage Application Rates.....	E-4
E-2 Recommended Site Characteristics for Mounds .....	E-34
E-3 Recommended Lateral Lengths Based on Hole-Spacing and Hole Diameter.....	E-38
E-4 Sidewall Areas of Circular Seepage Pits (square feet).....	E-43
F-1 Suggested Treatment Methods to Meet Treatment Objectives.....	F-2
G-1 Per Capita Mass Loading of Nitrogen and Phosphorus .....	G-1
G-2 Conceptual Process Selection for Nutrient Removal .....	G-3
G-3 Typical Media Sizes and Minimum Depths .....	G-5
G-4 MBR Typical Performance Data .....	G-9

## List of Figures

B-1 Soil Percolation Test Arrangement .....	B-9
D-1 Type II Grease Interceptor and Septic Tank Building Sewers Discharging to a Soil-Based Treatment System (STS) .....	D-4
D-2 Double Compartment (Type II) Grease Interceptor.....	D-7
D-3 Double Compartment Septic Tank .....	D-16
D-4 Single Compartment Septic Tanks in Series.....	D-16
D-5 Graywater Irrigation Chambers .....	D-26
E-1 Drop Box Distribution Network.....	E-8
E-2 Serial Distribution Network .....	E-9
E-3 Monitoring and Cleanout Ports .....	E-11
E-4 Typical Valving for Three Bed or Three Field Soil-based Treatment Systems .....	E-16
E-5 Full field Reserve Area .....	E-16
E-6 Conventional Absorption Trench .....	E-18
E-7 Conventional Absorption Bed .....	E-19
E-8 Shallow Absorption Trench .....	E-22
E-9 Cut & Fill System.....	E-27
E-10A Raised System Plan View .....	E-30
E-10B Raised System Section View .....	E-31
E-11 Mound Configuration.....	E-37
E-12 Horizontal and Vertical Wastewater Travel in a Mound .....	E-38
E-13 Subsurface Drainage Methods .....	E-41
E-14 Seepage Pit .....	E-45
E-15 Pressurized Shallow Narrow Drainfield (cross-section) .....	E-46
E-16 Drip Dispersal Diagram .....	E-48
F-1 Single Pass Sand Filter – Buried Filter.....	F-9
F-2 Open Single-Pass Sand Filter .....	F-12
F-3 Recirculating Sand/Media Filter.....	F-13
F-4 Rotating Biological Contactor (RBC) .....	F-19



## Disclaimer

This is a guidance document for designing and constructing wastewater treatment systems. It is the design engineer's responsibility to ensure the treatment system is designed and constructed so it can be properly operated to comply with regulatory requirements. Use of this manual does not guarantee the proper function or performance of a wastewater treatment system. Furthermore, this manual does not imply or claim to address safety-related issues associated with the design, construction/installation, or testing of the components of the system, or abandonment of the system.

## Introduction

With increasing development of rural and suburban areas, the need for wastewater treatment systems has grown. In many cases, the cost of a centralized municipal system may be prohibitive. On-site Wastewater Treatment Systems (OWTS) have been gaining recognition as viable wastewater management alternatives that can provide reliable service at a reasonable cost while still preserving environmental quality. In addition, acknowledgment of the impacts of OWTS discharges on both surface water and groundwater quality has increased interest in optimizing the design, construction, monitoring, operation and maintenance of these systems. Using small-diameter gravity, pressure or vacuum sewers may provide an affordable alternative to conventional gravity sewers with the public benefit of not having to manage individual onsite soil based systems. The remaining tasks of septic tank pump out and maintenance would become part of the municipal responsibilities of maintaining the sewer system.

### Purposes of These Design Standards:

This manual provides licensed professional engineers, owners, operators, and others with guidance on the design, operation and maintenance of intermediate-size wastewater treatment facilities. The manual's purposes are to protect the waters of the state, encourage system designers to include water conservation, energy efficiency, and life cycle cost evaluation in the design of facilities, and reduce project review and processing time by the appropriate regulatory agencies.

It is anticipated that the information will aid designers in preparing complete project submissions (maps, plans and reports) which will result in wastewater treatment systems that meet these purposes. These Design Standards offer:

- Prescriptive and performance based design standards for systems serving private, commercial and institutional (PCI) facilities with discharges to Soil based Treatment Systems (STS).
- Prescriptive and performance based design standards for municipal systems using alternative collection systems or discharging to STS.
- Prescriptive and performance based design standards for surface water discharges.
- Select and preferred references for additional design guidance.

## How to Use These Design Standards:

This manual provides engineering design standards for a variety of wastewater treatment systems that can be used to treat sanitary sewage generated at private, institutional, commercial and multi-home facilities (without the admixture of industrial or other waste as defined in 6 NYCRR Part 750-1). These systems may discharge to surface water, or to groundwater through a subsurface Soil based Treatment System (STS). A septic tank followed by soil absorption, in many cases, provides the most cost effective, long term solution for wastewater treatment. Proper design, operation, and maintenance of these systems are essential to their viability. Secondary and tertiary treatment options are also included because the physical characteristics of the site or chemical composition of the wastewater may be such that a more complex system is necessary to meet public health and environmental criteria, and discharge limitations.

Lack of description or criteria for a particular process is not intended to suggest that such a system should not be used, but only that consideration by the reviewing agency will be on the basis of information submitted with the design (See Section H). It is incumbent on the design engineer to fully demonstrate that the process or equipment is capable of achieving the treatment objectives outlined herein.

This manual is organized in sections as follows:

---

### Section A. Facility Planning and Permitting

---

This section provides a short description of the process for planning, locating and designing a wastewater treatment system according to the state's SPDES and SEQR processes. Other related permits that may be required are also addressed.

---

### Section B. Project Evaluation and Design Criteria

---

This section discusses site evaluation criteria and soil evaluation recommendations, flood protection recommendations, wastewater characterization, and design flows based on the type of establishments served (residential, commercial, institutional, recreational, food service or other private business). Non-contaminated flow diversion and other treatment considerations are briefly discussed and typical effluent limits for surface water discharges are given.

---

Section C. Sewer Systems and Sewage Pump (Lift) Stations

---

This section describes requirements for building sewers referencing the state building and plumbing code. Both conventional sewers and alternative collection systems are covered. Additional info is given for the construction of conventional gravity sewers, manholes, pipe material, and dry wells and wet wells comprising pump or lift stations.

Effluent, vacuum and pressure sewer details and criteria are provided from the Water Environment Federation's (WEF) Manual of Practice (MOP) FD-12, *Alternative Sewer Systems*, 2008.

---

Section D. Preliminary and Primary Treatment, Flow Measurement and Appurtenances

---

This section provides information on components that precede secondary treatment units like septic tanks, effluent filters, grease interceptors, distribution boxes and flow splitters, discharges to a STS, or that serve as alternatives to conventional onsite treatment. Flow equalization recommendations are given as an alternative means of providing additional storage volume. Flow measurement requirements are given based on three ranges of facility design flow.

---

Section E. Subsurface Treatment and Discharge

---

This section addresses the application of pretreated wastewater to the soil. Application rates are given in Table E-1. Options for distribution networks are discussed, and design methods and calculations are given for pressure distribution and dosing systems.

---

Section F. Secondary Treatment

---

This section includes fixed film (attached growth) and suspended-growth activated sludge sections, and technologies that use both. For fixed film systems, media filtration includes sand filters, as well as fabric, gravel, peat and other materials. The design guidance for Rotating Biological Contactors (RBC) has also been updated. Bio-towers have also been added as an example of an integrated biological treatment system.

For suspended-growth systems, the design standards provide activated sludge design criteria for extended

aeration and contact stabilization modes and sequencing batch reactor designs. Oxidation ditch, and lagoon or pond systems design guidance is also given.

---

Section G. Tertiary Treatment

---

This section is divided into four subsections: granular media filtration, physical-chemical treatment systems, biological nutrient removal systems, and constructed wetland systems. The *Ten States Standards* tertiary treatment technology selection is limited to phosphorus removal by chemical treatment and high rate effluent filtration, so *TR-16* has been cited for the majority of this section due to its dedication of an entire chapter to advanced treatment. Many tertiary treatment processes can provide sufficient pollutant removal on their own; others may require a certain level of pre-treatment or post-treatment (filtration, clarification, or disinfection) to meet the effluent limitation. Constructed wetlands are included as treatment units that can provide additional pollutant removal when receiving secondary effluent.

---

Section H. Innovative Systems

---

This section is the Department's procedure for new technology review. It provides a process for a design engineer to propose a proprietary technology to a review engineer by demonstrating how it meets or exceeds the design criteria of a similar design in these Design Standards. New or innovative designs, not included here may also follow this procedure to gain site-specific approval.

---

Section I. Disinfection and Reoxygenation

---

This section is divided into two subsections:

The disinfection section has design guidance for chlorination and dechlorination. Updated information on ultraviolet disinfection and references for additional UV design criteria are provided.

The effluent re-oxygenation section was renamed to accommodate the terminology of the Water Environment Federation Manual of Practice (MOP) Number 8, "*Design of Municipal Wastewater Treatment Plants*," and includes diffused/mechanical and cascade aeration, outfall specifications, and controlled-release requirements.

---

Section J.      Operation, Maintenance, and Control

---

This section provides information on 6 NYCRR Part 650 regarding the requirement of certified operator(s) for wastewater treatment facilities. It also discusses regulatory requirements for the handling of bio-solids pursuant to 6 NYCRR Part 360. Operation and effluent control and the emergency repair and rehabilitation subsections of this document are based on 6 NYCRR Part 750. The remote telemetry, instrumentation and alarms section includes integral components of systems with technologies that need to be remotely monitored by the manufacturer, trained service providers, or an operator.

---

Appendix A    Wastewater Treatment System Regulatory Framework in New York State

---

This is a table that provides the distribution of responsibility between NYSDEC and NYSDOH based on the 1984 Memorandum of Understanding, (MOU), and according to system size and type (residential, private, commercial or institutional).

---

Appendix B    Conversion Factors

---

This is a table of conversion factors useful for designing of systems in English or S.I. units.

---

Appendix C    Sewer and Manhole Leakage Tests

---

This appendix provides testing standards and criteria from *Ten State Standards*, ASTM and AWWA.

---

Appendix D    Reserved

---

---

Appendix E    Design Examples for Pressure Distribution; Guidance for Mound Systems and Alternative Distribution Systems

---

This appendix provides design, installation, operation, monitoring, and maintenance recommendations for drip dispersal and pressurized shallow, narrow drainfield systems, as well as design examples for pressure distribution and mound systems.

This appendix provides case study information on the performance of both single pass and recirculating sand filters gathered by the EPA. This and further information on design, application and management is from 2002 EPA Technology Fact Sheets TFS-10 and TFS-11, respectively.

## **A. Facility Planning and Permitting**

### **A.1 Introduction**

This section describes the planning and permitting process components which include permit or management requirements, permit type (individual or general), proximity to environmentally sensitive areas, proximity to public water supply watersheds, and additional permits that may be required. Replacement, modification or expansion of POTW facilities occurs as communities grow and facilities age. Design and construction of wastewater treatment infrastructure should include asset management considerations to provide for these additional needs. Asset management is detailed below in Section A.5.

### **A.2 Planning and Permit Application Process**

Construction of a new or modified wastewater treatment system requires regulatory authorization. (See Appendix A “Wastewater Treatment System Regulatory Framework in New York State”) The first step in the process should be to contact the Regional Permit Administrator to arrange a preapplication conference. Typically, the initial consultation with NYSDEC should be with the Division of Environmental Permits’ Regional Office serving the county where the project is proposed. Applicants find this meeting helpful for explaining a proposed project to NYSDEC and other interested agencies. Preliminary answers to questions about project plans, and permit application procedures are typically provided to the applicant at this conference. In this conference issues such as garbage grinder use in an onsite system is addressed (and should be accounted for in septic tank sizing per Section D.6).

A complete submission for a project should include SEQR documentation (see Section A.4); an engineering or wastewater facilities report including detailed engineering plans that demonstrate compliance with applicable design standards, a SPDES permit application (see A.4 below); a location map (1:24,000 scale topographic); and a site plan showing existing structures, roads, watercourses, two- foot (2’) contours to facilitate slope calculations, and specific features such as drainage channels, low areas and changes in slope. Additional specific mapping/site plan requirements (with appropriate scale(s)) may be negotiated at the preapplication meeting and could include some or all of the following:

- Soils
- Slopes
- Surface structures (roads, parking lots, structures of all types)



- Subsurface structures
- Areas of special environmental concern
- Areas of special historical concern
- Depth to groundwater
- Recharge areas
- Primary and principal aquifers
- Wetlands and buffers
- Streams and buffers

While developing the site plan, among other references, the applicant should consult the NYSDEC's interactive online maps, especially the Environmental Resource Mapper, to avoid sensitive or protected resources. These interactive online maps can be accessed at <http://www.dec.ny.gov/pubs/42937.html>.

---

#### Sewage Disposal Corporations

---

Where there is potential for a facility to be used in the future as part of a sewage disposal corporation (formed pursuant to Article 10 of the Transportation Corporations Law) or a municipal system (Publicly Owned Treatment Works), New York State's standards for municipal wastewater treatment and collection facilities (*Ten States Standards* or *TR-16*) should be consulted. NYSDEC regions may review any wastewater treatment systems proposed for operation by a sewage disposal corporation. There is no sewage disposal corporation exemption for home owner associations, unlike the exemption that exists for water works. Formation of a sewage disposal corporation may be required in accordance with Part 750-1. Information on requirements for certified operators for a WWTP facility can be found in Section J. of this document.

---

#### Effluent Quality

---

As part of a pre-application meeting with NYSDEC, wastewater treatment facility discharge limitations may be discussed to provide the applicant preliminary information regarding expected effluent quality. This discussion may inform the applicant whether the discharge should be directed to surface water or groundwater.

---

#### Underground Injection Control (UIC)

---

In addition to existing state and local oversight, decentralized wastewater treatment systems that discharge

subsurface and serve more than 20 people may be subject to regulation under the United States Environmental Protection Agency (EPA) Underground Injection Control (UIC) Program. The Safe Drinking Water Act (SDWA) authorizes EPA to establish minimum federal requirements for state and tribal UIC programs to protect underground sources of drinking water from contamination caused by injection activities, e.g., large-capacity septic systems, laundromats without dry cleaning facilities, food processing disposal, or aquaculture. Protection includes oversight of construction and operation, and closure of injection wells. In most cases, if a SPDES permit is issued by NYSDEC, EPA will not require a UIC permit also (the discharge is considered to be covered “by rule”).

### **A.3 Obtaining a SPDES Permit for a Wastewater Discharge**

NYSDEC may issue an individual (site specific) SPDES permit or an applicant may apply for permit coverage under the SPDES Private, Commercial, and Institutional (PCI) General Permit (SPDES General Permit) for existing and proposed discharges. The SPDES PCI General Permit authorizes discharges to groundwater between 1,000 and 10,000 gallons per day (gpd) of treated sanitary wastes only, without the admixture of industrial waste, from onsite wastewater treatment systems (OWTS) serving private multi-family dwellings, or other private, commercial, or institutional facilities. Note that subsurface discharges under 1,000 GPD of sanitary waste, without the admixture of industrial wastes, do not require a SPDES permit from NYSDEC. Refer to Appendix A for regulatory jurisdiction and technical standards for subsurface discharges under 1,000 gpd or over 10,000 gpd, surface discharges of any flow, and non-sanitary discharges of any flow.

---

#### SPDES Regulations

---

Regulations governing the issuance of SPDES permits can be found in Title 6 of the New York Code of Rules and Regulations (6 NYCRR Part 750-1 & 750-2). SPDES Regulations Part 750-1 provides information regarding eligibility criteria for facilities to be covered by a SPDES permit and the process of obtaining a SPDES permit. Part 750-2 contains general facility operating and maintenance requirements, as well as facility closure requirement.

6NYCRR Part 750-2 requires that prior to construction the permittee submit to the Department approvable engineering reports, plans, and specifications that have been prepared by a licensed professional engineer in the State of New York in accordance with design standards accepted by the department.

6NYCRR Part 750-2 lists the following design standards as being acceptable:

- *Ten States Standards* for use in designing POTWs that discharge to surface water and their collection systems
- These Design Standards for use in designing wastewater treatment systems and their collection systems which treat only sanitary sewage from:
  - POTWs that discharge to groundwater
  - Private, commercial and institutional facilities
- Other acceptable design standards (e.g., *TR-16, Water Environment Federation Manuals of Engineering Practice (MOP)*).

---

## General Permit Application Process and Exclusions

---

Facilities applying for subsurface discharges under the SPDES General Permit also need approval from the appropriate city health department, county health department, or district office of the New York State Department of Health before a treatment system can be built. Other NYSDEC permits or approvals from other agencies may also be required. Engineering plans submitted with a SPDES General Permit application must be certified by a professional engineer licensed in New York State.

The SPDES General Permit is not applicable for facilities located in Kings, Nassau, Suffolk or Queens Counties that were not previously issued under GP 95-01, nor in the following environmentally sensitive areas:

- Special (100-year) flood hazard area as defined in 42 United States Code 4001
- Freshwater wetlands or adjacent area as defined in Environmental Conservation Law (ECL) Article 24
- Tidal wetlands and adjacent area as defined in ECL Article 25
- Coastal erosion hazard area as defined in ECL Article 34
- Wild, scenic, and recreational river corridors as defined in ECL Title 27, Article 15

Facilities located in these areas require project-specific review and must apply for an individual SPDES permit. Pursuant to 6 NYCRR Part 750-2, engineering plans and specs for an individual SPDES permit must be approved by NYSDEC before construction can begin. If you have questions regarding your facility location in these environmentally sensitive areas, please contact your NYSDEC Regional Permit Administrator.

Construction inspection and certification is also part of the SPDES rules and regulation under 6 NYCRR Part 750-2, for both individually permitted systems and facilities eligible for coverage under the SPDES General Permit. Construction inspection must be conducted by a licensed professional engineer who supervised the construction and must include inspections during the course of construction at critical installation points to insure the treatment system is installed as specified in the design plans.

#### **A.4 State Environmental Quality Review (SEQR)**

Provisions of the Uniform Procedures Act (UPA) require that applications for NYSDEC permits be considered incomplete unless certain requirements of SEQR have been met. This initially involves the applicant filing a completed Environmental Assessment Form (EAF) and other NYSDEC permits in accordance with portions of the law and can be accessed on NYSDEC's website.

Other permits issued by federal or local agencies may also be required. For the best approach to meeting these permit requirements, contact NYSDEC's Division of Environmental Permits' regional office serving the county where the project is proposed.

A sequential discussion of the SEQR process is presented in *The SEQR Cookbook*. This book and the *SEQR Handbook* (and Q & A about SEQR) can be accessed on NYSDEC's website. For further information on SEQR, and UPA timetables and permits, contact the Division of Environmental Permits' regional office serving the county where the project is proposed.

#### **A.5 Asset Management**

An asset is a component of a facility with an independent physical and functional identity and age (e.g., pump, motor, sedimentation tank, main buildings and staff). Asset management is a process for maintaining the assets of wastewater collection and treatment facilities at the desired level of service to meet user needs, public safety, environmental protection, and permit requirements at the lowest lifecycle cost. The lowest lifecycle cost is determined not just for initial capital costs, but for all costs incurred over the life of the system, including optimum costs for rehabilitating, repairing or replacing an asset. Accounting for the lifecycle cost of the entire wastewater collection, treatment and dispersal systems now will enable future

generations to meet their needs.

Energy-efficient system components contribute to a lower lifecycle cost. The New York State Energy Research and Development Authority's (NYSERDA) may be contacted for energy efficiency recommendations and information about technical assistance can be found on their website at <http://nyserda.ny.gov>. NYSDERDA's *Water and Wastewater Energy Management Best Practices Handbook* contains a section with 21 management practices for wastewater treatment plants.

Asset management is implemented through an asset management plan. Asset management is applicable to centralized, decentralized and onsite wastewater collection and treatment systems. Complexity of the asset management plan varies depending on the size of the system.

These Design Standards determine how the system or component could or should be designed. Asset management needs are determined by the type of system or the system component to be designed. Optimally, design choices consider the technical and managerial capacity of the owner/operator to operate and maintain the facility. Asset management is a process of caring for the system and keeping it operating at or exceeding the intended level of service.

Typical components of a basic asset management plan and implementation process include:

- Taking inventory to identify the current performance of assets. This first step involves identifying, locating, and evaluating a system's assets. It includes reporting each asset's condition and remaining useful life.
- Prioritizing assets is done by determining assets that are critical to current operational performance. The asset's significance to the rest of the system is an important factor in maintaining the required level of service the wastewater collection and treatment system needs to provide. Level of service includes protection of public health and meeting SPDES permit limits. Assets critical to providing these should be given a higher priority.
- Developing a capital improvement program. After ranking priorities, permittees and managers need to plan for future rehabilitation and/or replacement of assets. This phase formulates a capital improvement plan. A fiscal strategy should be developed to set money aside each year to fund a capital improvement reserve. Facility operations, maintenance, and capital investment strategies should be integrated and coordinated to sustain performance at the lowest total cost of ownership

(lifecycle cost).

- Implementing the plan. This step requires a detailed budget and financial forecasting of revenues typically on a five-year basis/cycle through the design life of system components. It may involve finding additional funding sources and/or increasing customer rates.
- Reviewing and revising the plan. The plan should be reviewed each year and updated to reflect changes in asset inventory, criticality rankings, and the capital improvement program necessary to sustain reliable operation of the system.

## **B. Project Evaluation**

### **B.1 Introduction**

To design an effective, environmentally acceptable onsite wastewater treatment system, it is necessary to evaluate the physical characteristics of a site to determine whether adequate conditions exist to treat and discharge wastewater on a long-term basis. A comprehensive site evaluation provides the necessary information to select an appropriately sized, cost-effective treatment system from a wide range of design options.

### **B.2 Site Evaluation**

Points to be considered when evaluating a site for location of an on-site wastewater treatment system include identification of flood-prone areas; proximity of dwellings (both permanently and periodically inhabited) and other structures; location of nearby utilities including water supplies and water lines; proximity to surface waters, wetlands and other environmentally sensitive areas; terrain and other surface characteristics; subsurface conditions; prevailing winds and odor control; area for system replacement and/or expansion; and assimilative capacity of any potential receiving stream. Existing easements and rights of way should also be considered. Site characteristics may recommend one type of wastewater treatment system over another. Local temperature extremes may make it necessary to enclose the facilities to maintain treatment efficiency.

Consideration of an area for system replacement or expansion necessitates that a reserve area be taken into account. For reserve area options, refer to Section E.7.

### **B.3 Separation Distances**

---

#### Airborne Separation

---

Wastewater treatment systems with open-air, odor-producing units should be located as far as possible from human habitation or public use or gathering areas. Table B-1 contains a list of minimum separation distances that should be maintained between treatment facilities and dwellings or property lines to provide some attenuation of airborne nuisances such as aerosols, pathogens, odors and noise. Special designs or considerations may warrant a reduced distance. Buffer areas should be permanent, with the intent to

preserve future use and enjoyment of adjacent properties, and not be subject to later development that can create nuisance conditions. Deed covenants can keep the buffer intact regardless of ownership changes.

Operation of various unit processes is known to be adversely affected by wind and temperature extremes. Possible effects should be analyzed and prevented or controlled by appropriate design considerations (e.g. windbreaks, high freeboard, equipment or process enclosure, etc.). If enclosures are used to preserve treatment efficiency in colder portions of the state, care should be taken to protect units from condensation, subsequent corrosion, or operational problems such as freezing of the system. For example, eliminating the insulating snowpack using an unheated pole barn with no walls in northern New York has resulted in frozen sand filters.

If there is concern that the separation provided is insufficient for avoiding odorous nuisance conditions, steps should be taken to minimize odors. Such steps may include chemical addition, consideration of prevailing winds, odor control systems, and covering or enclosing facilities. Sludge processing, storage, and disposal units are not included in Table B-1. For purposes of these Design Standards, it is assumed that solids are hauled off site. If these facilities are proposed to be on site, *Ten States Standards* should be referred to for odor control and location criteria/requirements.

To mitigate odor or aerosol concerns, prevailing wind direction should be determined by on-site data. Local weather station records may be used if they are demonstrated to be applicable. Attention should be paid to both moderate and high-speed winds because the latter often have a prevailing direction different from that of moderate winds. A windbreak should be considered as an option.



**Table B-1 Recommended Minimum Aerial Separation Distance (in feet) from Treatment Facility**

<b>Treatment Type</b>	<b>Radial Distance to Existing Downwind Dwellings (On or Off the Property)</b>	<b>Distance to Property Line from Treatment Unit</b>
Wastewater Treatment Processes Open to the Atmosphere e.g. Open Sand Filter, and Oxidation Ditches	400	350
Wastewater Treatment Processes Enclosed <sup>2</sup> in a Building, and Buried or Covered Sand Filters	200 <sup>3</sup>	150
Facultative and Aerated Lagoons	1,000	800
Effluent Recharge Bed	750	550

---

Horizontal Separation Distances from Existing Features

---

Table B-2 provides both requirements and guidance for the minimum horizontal separation distances that should be met for subsurface soil-based treatment and dispersal systems to protect water supply facilities, and to avoid sewage contamination and nuisance conditions. Factors such as system elevation, ground slope, and direction of groundwater flow, well pumping rates, and existence of impervious barriers affect necessary separation distances. For fill pads greater than two feet above native soils, separation distances should be measured from the toe of the fill material slope. Increased horizontal separation distances may be required if warranted by local conditions. Horizontal separation distance between water supply and sewer lines is discussed further in Section C.7.

---

<sup>2</sup> Enclosed building design requires consideration of ventilation, safety, operation and maintenance access, and odor and noise control devices. See *Ten States Standards* and *TR-16*. Mechanical forced-air ventilation may increase the required separation distance for odors.

<sup>3</sup> Non-residential structures located on the same parcel may qualify for lesser distances.

**Table B-2 Minimum Horizontal Separation Distance (in feet)**

<b>Existing Feature</b>	<b>Watertight Septic Tank</b>	<b>Sewer Line</b>	<b>Absorption Field or Unlined Sand Filter (Including Replacement Area)</b>	<b>Absorption Field Located in Gravel Soils (Including Replacement Area)</b>	<b>Seepage Pits (Including Replacement Area)</b>
<b>Required Minimum Horizontal Separation Distances per Public Health Law</b>					
Drilled Well – Public water system <sup>4</sup>	100	50	200	200	200
Drilled Well – Private water system <sup>5</sup>	50	50	100	200	150
Water Line (Pressure) <sup>6</sup>	10	10	10	10	10
<b>Recommended Minimum Horizontal Separation Distances</b>					
Water Line (Suction)	50	50	100	100	150
Dug Well / Spring <sup>7</sup>	75	50	150	200	150
Surface Water <sup>8</sup>	50	25	100	100	100
Reservoir (water supply) – Private <sup>9</sup>	50	50	100	100	100
Reservoir (water supply) – Public <sup>9</sup>	100	100	200	200	200

<sup>4</sup>Refer to Public Health Law Part 5-1, Appendices 5-B & 5-D

<sup>5</sup>Refer to Public Health Law Part 5-1, Appendix 5-B

<sup>6</sup>Refer to Public Health Law Part 5-1, Appendix 5-A

<sup>7</sup>When wastewater treatment systems are located up-gradient and in the direct path of surface runoff to a well, the closest part of the treatment system should be at least 200 feet away from the well.

<sup>8</sup>If there is a direct discharge to surface water, use the Surface Water separation distances; if a water supply use the Reservoir (water supply) distances.

<sup>9</sup>Refer to local watershed rules and regulations for possible superseding specifications.

Interceptor Drain/Open Drainage Diversion to Groundwater	25	25	50 <sup>10</sup>	50 <sup>10</sup>	50 <sup>10</sup>
Stormwater Infiltration Management Practice	25	25	50 <sup>10</sup>	50 <sup>10</sup>	50 <sup>10</sup>
Stormwater Management Practice Discharging to Surface Water <sup>10</sup>	50	25	100	100	100
Culvert (Tight Pipe)	25	10	35	35	35
Culvert Opening	25	25	50	50	50
Catch Basin	25	N/A	50	50	50
Swimming Pool In Ground	20	10	35	35	50
Foundation	10	N/A	20	20	20
Property Line	10	10	10	10	10
Top of Embankment	25	25	50	50	50
Wetland (NYSDEC) <sup>11</sup>	100	100	100	100	100

#### **B.4 Soil Evaluation for Subsurface Discharge**

Soil profile observations should be made on all sites proposed for soil absorption systems. A preliminary soil evaluation and site investigation should be done prior to design and installation of a treatment system on any property.

Some factors to be evaluated for all soil absorption systems are:

---

<sup>10</sup> Separation distance may be reduced to 35' if the bottom of the drain is above the finished grade of the subsurface soil treatment system, keeping the drain water and wastewater separate.

<sup>11</sup> A reduced separation distance, if any, is determined through the permit review process.

- Thickness of layers or horizons
- Texture (USDA), consistence, and structure of soil layers
- General color and colored mottling (i.e., an indication of a seasonally high groundwater table). This should be done using Munsell color charts in natural light only
- Depth to water (if observed) and depth to estimated or observed seasonally high groundwater level
- Depth to bedrock if observed
- Other prominent features such as visible pores, stoniness, roots, or animal traces

Soil evaluation should be based on finished elevations of the site, and should consider proposed site modifications that could affect subsurface conditions such as cutting and filling, storm water infiltration practices installed, preconstruction soil stockpiling, and post-construction topsoil placement/depth. Proposed cut or fill work to be done should be accounted for when determining the suitability of the site for soil absorption systems.

The first preference for conventional absorption trench or bed systems is to install trenches/beds in native soil. Protecting the site from compaction should be a high priority. Flag, or otherwise designate, the absorption field so it is not used as a staging area, parking lot, or pathway for heavy equipment.

Groundwater mounding may occur under an absorption system in the presence of an impervious layer or over a zone of saturation. Potential for groundwater mounding should be investigated during site evaluation. Operational problems and groundwater contamination may result if groundwater approaches the base of the system. Special consideration of horizontal separations per Table B-2 should be given to sites incorporating storm water infiltration practices.

A mathematical analysis should be performed to predict the extent of groundwater mounding that would occur when the absorption system is in operation. Depending on system size and site conditions, the Reviewing Engineer may require a site/system specific hydrogeologic evaluation by a hydrogeologist.

In general, greater recharge from the absorption system, wider application widths, and slower horizontal saturated conductivities result in formation of higher groundwater mounds. An aerated zone of two feet for an absorption field and three feet for seepage pits is desirable between the base of the system and the top of the groundwater mound.

## **B.4.a Deep Soil**

A primary objective of the deep soil pit test is to ensure adequate vertical separation between the bottom of the STS and the seasonally high groundwater table, bedrock, and impervious layers. Therefore, soil pits should be dug to enable accurate description of soil types and horizons, while soil borings may be used to determine soil variability over a large area. A minimum of one deep soil pit test should be conducted in the primary area, and one deep-soil pit test in the reserve area. Multiple pits may be necessary if the evaluation finds several different soil conditions, or if the absorption field footprint is over 2,000 square feet. Soil pits should generally be a minimum of six to eight feet deep to enable observation of the soil at least five feet below the bottom of the proposed absorption system or to groundwater. They should be wide enough to enable natural sunlight to shine directly on the exposed face of the pit wall, and, if at all possible, should be dug at the perimeter of the expected soil absorption area.

The bottom of a conventional absorption field should be at least 2 feet above the seasonally high water table, and 4 feet above bedrock or impervious strata. The bottom of a seepage pit should be at least 3 feet above the seasonally high water table, and 4 feet above bedrock or impervious strata.

The Reviewing Engineer may require greater depths (vertical separation) in rapidly permeable soils to ensure necessary treatment is provided. If these distances cannot be met, use of a fill or mound system should be considered before a surface water discharge is considered.

---

### Deep Soil Pit Entry

---

Prior to performing any subsurface soil investigation, New York State law requires the design engineer or contractor contact DIG SAFELY NEW YORK or another underground locating service provider.

Before entering the pit, make sure it is safe to enter and that all safety regulations are being met. The pit should be constructed properly with a step-type configuration to enable safe entry and exit. It should have no sidewall slumps or any other indications for a potential cave-in. Be sure that no heavy equipment or large objects (such as rocks or boulders) are resting on the surface immediately adjacent to pit sidewalls. Excavations should be fenced or backfilled to avoid falls or unauthorized entry. To avoid unsafe conditions that might violate Occupational Safety and Health Administration (OSHA) safety standards, variation in required depth or manner of observation may be allowed when a deep seepage pit is proposed. Federal OSHA construction standards applicable to excavations and trenches can be found at their Safety and Health Topics web page.

## **B.4.b Percolation Testing**

Hydraulic conductivity can be estimated using soil percolation tests. Tests should be run during spring, as system failure is more likely in wet months. In addition to percolation test results, soil evaluation information may be required by the approving jurisdiction (see Appendix A) and could include some or all of the following:

- Description of percolation test procedure
- Depth of percolation hole(s) (should be based on the finished grade elevation of the area)
- Record of thickness of soil horizons, soil types, texture (USDA), consistence, and color
- Elevation/depth of the seasonally high groundwater level or record of colored mottling
- Elevation/depth of soils to bedrock or impervious strata and other prominent features such as visible pores, stoniness, roots, or animal traces.
- Number of percolation test holes dug
- Percolation rate (mpi) - stabilized
- Sewage application rate (gal/day/sq. ft.)
- Deep-soil test pit and percolation hole locations shown on-site plan

For a conventional trench or bed system, the percolation test should be performed at the depth of the proposed system based on the proposed finished grade elevation of the site. Percolation tests should be run in an area immediately adjacent to or in between, areas proposed for absorption trenches. At least two percolation tests for every 1,000 sq. ft. of absorption area should be performed in holes spaced uniformly throughout the site. If soil conditions are highly variable, more tests may be required. For larger systems, i.e. greater than 5,000 gpd where soil maps and confirming observational data indicate uniform soils over a large area, fewer percolation tests may be approved by the Reviewing Engineer.

If a seepage pit is under consideration, percolation tests should be done at least at one-half the final depth and at full depth of the seepage pit. If different soil layers are encountered when digging the test hole for a seepage pit, a percolation test should be performed in each layer with the overall percolation rate being the weighted average of test results based upon the depth of each layer. Test pit soil layers (for seepage pits) with percolation rates slower than 30 minutes per inch (mpi) should be excluded from these calculations.

For mound systems, percolation tests on native soil should be performed just within the estimated

boundary of the basal area of the mound. Percolation tests should be performed at a depth of 20 inches in slowly permeable soil, 12 inches in shallow soil over bedrock, and 16 inches if the high water table is within 20 inches of the ground surface.

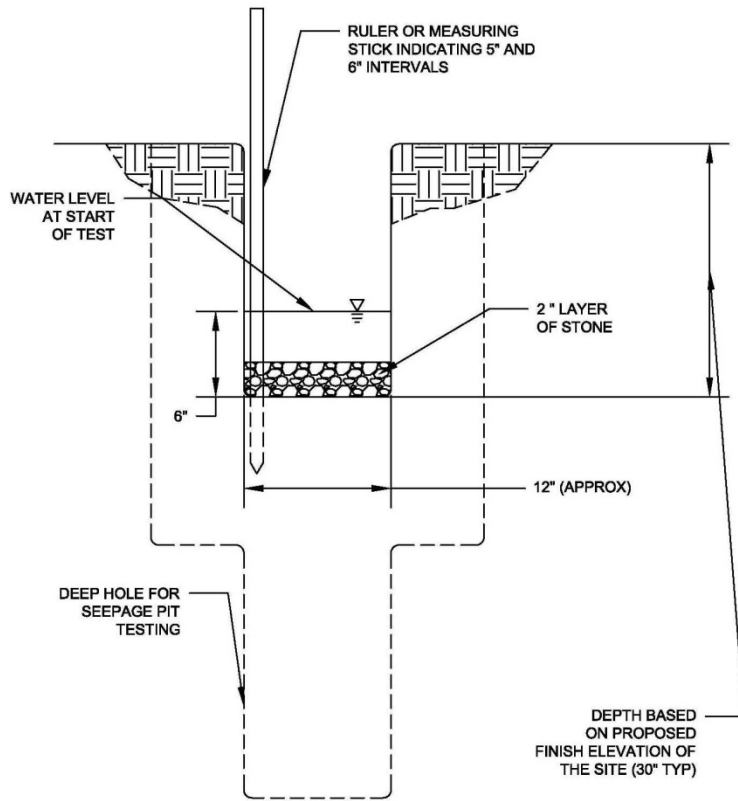

**Figure B-1 Soil Percolation Test Arrangement**

The procedure noted below should be followed when performing a percolation test:

- 1) Dig a round hole with vertical sides having a diameter of approximately 12 inches, or a square hole having sides of approximately 12 inches. Scrape or scarify sides and remove loose soil from the bottom of the hole. For seepage pits, a larger excavation should be made for the upper portion of the hole with the actual test hole in the bottom (see Figure B -1).
- 2) Install a measuring stick. Place two inches of  $\frac{1}{2}$ -to- $\frac{3}{4}$ -inch washed gravel in the hole to protect the bottom from scouring action when water is added.
- 3) Pre-soak: Fill the test hole with water and allow it to completely seep away. This pre-soaking should be done continuously for at least four hours before the test. Soils with high clay content should be pre-soaked overnight. In sandy soils, soaking is not necessary. Instead, after filling the

hole twice with 12 inches of water, if the water seeps away completely in less than ten minutes, the test may proceed immediately. After the water has seeped away, remove any loose soil that has fallen from the sides of the hole.

- 4) Pour clean water into the hole, with as little splashing as possible, to a depth of six inches.
- 5) Observe the time in minutes required for the water to drop one inch (from the six-inch mark to the five-inch mark), and record the results on a Percolation Test Data sheet.
- 6) Repeat the test a minimum of three times until the time for the water to drop one inch for two successive tests is approximately equal. The last seepage rate measured (mpi) will then be taken as the stabilized rate for percolation. If different percolation test results are obtained from separate soil pits in the same general area, the slowest percolation rate is used in design.
- 7) A percolation test whose results are inconsistent with the deep soil test pit evaluation should be disregarded, and the percolation test(s) performed again.

## **B.5 Locating Facility Relative to Flood Plains**

If feasible, on-site waste disposal systems should be located to avoid impairment to them or contamination from them during flooding.

Most communities in New York State participate in the National Flood Insurance Program. As such, they have local laws at least as restrictive as federal regulations governing floodplain development found in 44 CFR 60.3 “Flood Plain Management for Flood Prone Areas”. Any project that encroaches on a floodplain, as shown on federal flood insurance rate maps, requires a permit from the local community.

The following are recommendations for design elevations to protect facilities and their critical equipment from flood damage, to avoid or minimize flood damage to waste disposal facilities:

- Buildings should be anchored to prevent flotation, collapse, or lateral movement during the 100-year flood. This requirement is in addition to applicable state and local anchoring requirements for resisting wind forces.
- The lowest floor of a building, including basement or cellar, should be elevated two feet or more above the 100-year flood elevation, or to the 500-year flood elevation, whichever is higher. This is consistent with the 2010 Building Code of New York State.



- Electrical components should be elevated in accordance with the 2010 Building Code of New York State.
- Collection and treatment equipment, including all manholes, access ports, lift stations and pump houses, should be flood-proofed so that the structure is watertight up to two feet above the 100-year flood elevation, or to the 500-year flood elevation, whichever is higher, with walls substantially impermeable to the passage of water. All structural components located below the 100-year flood elevation should be capable of resisting hydrostatic and hydrodynamic loads and the effects of buoyancy.
- If the structure is to be flood-proofed, a licensed professional engineer or architect should develop and/or review structural design specifications and plans for construction. The engineer also should certify the design and methods of construction are in accordance with accepted standards of practice and provide a copy of that certification to the local floodplain administrator.
- New and replacement sanitary sewage collection systems should be designed to minimize or eliminate infiltration of flood waters. Sanitary sewer and storm drainage systems for buildings that have openings below the base flood elevation should be provided with automatic backflow valves or other automatic back flow devices installed in each discharge line passing through a building's exterior wall.

Federal or state governments each have their own requirements for locating facilities such as wastewater treatment plants in the floodplain. When a project developer seeks funding from either of these governmental entities, those requirements should be consulted.

## **B.6 Design Criteria**

Typically an OWTS is designed based on an expected or known hydraulic loading rate and a determined soil acceptance rate or application rate for a filter media. However, a hydraulic loading rate does not take into consideration the effect of elevated organic and solids loading on the soil or filter media. Therefore, to design an effective OWTS, raw wastewater should be accurately characterized, and the daily wastewater flow volume, and flow rate over the significant delivery period(s) should be reliably estimated.

### **B.6.a Wastewater Characterization**

Raw wastewater from commercial and institutional facilities can generally be divided into two types; residential (average strength) and nonresidential (high strength).

Residential wastewater is typically generated by water using activities such as personal hygiene, food preparation and cleaning. Wastewater is discharged from various plumbing fixtures and appliances such as toilets, sinks, bathtubs and clothes washers from the following intermediate-sized facilities:

- Cluster housing and multi-home developments
- Apartment buildings
- Mobile home parks
- Other facilities that generate wastewater similar in characteristics to residential wastewater

Traditionally, the most important wastewater characteristics to consider when designing residential OWTS are biochemical oxygen demand or BOD (organic loading), total suspended solids or TSS (solids loading), and fats, oils and grease (FOG) levels. In specific cases, total phosphorus (TP) or ammonia (NH<sub>4</sub>) discharges may need to be considered. Typical influent concentrations of these parameters in residential wastewater may range as follows:

<b>Parameter</b>	<b>Concentration, mg/L<sup>12</sup></b>
BOD <sub>5</sub>	155 – 286
TSS	155 – 330
FOG	70 – 105
TP	6 – 12
NH <sub>4</sub>	4 – 13

Commercial and institutional facilities may generate nonresidential (high strength) wastewater from activities such as garbage disposal use, food preparation, food service, hair care, on-site linen service or sanitary dump stations. Nonresidential wastewater typically has higher concentrations of BOD, TSS and FOG than those listed above. High strength wastewater is generated by many types of facilities, including:

- Hospitals, nursing homes, and other medical institutions
- Hotels, motels, schools, and prisons
- Kennels, veterinary clinics, and animal shelters
- Sanitary dump stations serving roadside rest areas, campgrounds, or other recreational facilities
- Food-service establishments
- Laundromats or facilities with on-site linen laundry
- Supermarkets, butcher shops, and bakeries

The facilities listed above may generate other waste streams deserving special consideration due to elevated concentrations of wastewater constituents, toxics, or hazardous substances. Some typical activities include:

- Floor stripping<sup>13</sup>
- Cleaning and disinfecting<sup>13</sup>

---

<sup>12</sup> EPA 625/R-00/008-Chapter 3, Table 3-7, 2002.

<sup>13</sup> Frequency of floor stripping and type and frequency of disinfection of surfaces in institutional facilities is often mandated by law.

- Disposing of waste pharmaceuticals<sup>14</sup>
- Disposing of sanitary wastes from people receiving medical care (e.g., chemotherapy) <sup>14</sup>
- Disposing of food wastes with FOG concentrations two to five times that of residential (various cuisine types) <sup>15</sup>

Any of these components can interfere with the normal biological processes most on-site treatment systems use. These characteristics can vary daily or hourly and can have a major impact on system performance. It may be appropriate to provide pretreatment (grease interceptors or septic tank effluent filters) or advanced treatment (aerobic treatment units, or filtration) of the wastewater or reduce the effective hydraulic loading rate of the treatment system (by requiring time dosed pressure distribution) to compensate for toxic effects, elevated organic and/or solids loading in the influent.

Commercial and institutional facilities often generate a majority of their daily wastewater over significant delivery periods depending on the nature of the business, and also may not have a continuous base flow. For example, schools have high flows during only a few hours of the day, and no flow is present in the late afternoon and at night. Peak hourly flows generated during these times of the day should be accounted for in the design of the system components. Solids buildup and anaerobic conditions due to low flows should also be considered. If subsurface disposal is to be used, the treatment process should remove nearly all settleable solids and floatable grease and scum to enable efficient operation of the soil-based treatment and dispersal system.

Some facilities within the scope of this document may generate industrial wastes due to the nature of their activities. For example, schools may generate industrial waste from sinks or drains installed in science labs, auto repair, art, hair care or other vocational training. These wastes should be separated from the on-site wastewater treatment system. The separated wastes can then either be transported to a facility approved to treat the waste, or directed to an individual SPDES-permitted industrial wastewater treatment

---

<sup>14</sup> NYSDEC does not encourage disposal of any unused prescriptions into any wastewater treatment system. Information on proper disposal of household prescriptions and over-the-counter drugs can be found on NYSDEC's website.

<sup>15</sup> Studies (R.L. Siegrist, CO; B. Lesikar, TX; B. Stuth, WA; and J.C. Converse, WI) show that wastewater from a restaurant is typically 2.7 and 2.8 times higher for BOD<sub>5</sub> and TSS, respectively, than residential wastewater. The influence of other factors such as a self-serve salad bar, types of oil used, dishwashing procedures, and restroom use should be considered.

system. The design of an industrial waste treatment facility is outside the scope of this document.

## **B.6.b Design Flow**

The design flow rate is typically based on the flow rates determined using one of the following three methods:

- Using the typical per-unit hydraulic loading rates provided in Table B-3
- Obtaining metered daily wastewater flow data from existing and similar facilities
- Obtaining metered daily water usage data from existing and similar facilities

### Method 1: Typical Per-Unit Hydraulic Loading Rates (Table B-3)

The flow rate determined by using Method 1 with the maximum expected operational conditions (i.e. maximum occupancy) is an acceptable design flow rate for septic tank or subsurface absorption systems. Typical per-unit hydraulic loading rates are presented in Table B-3. When an establishment includes several different types of uses from the table, each use should be computed separately. Except for the 110/130/150 gpd per unit values, the per-unit hydraulic loading rates in Table B-3 may be reduced by 20 percent for establishments equipped with water saving plumbing fixtures. A combination of high and low flow fixtures can also be considered on a pro-rata basis. Fixtures that use even less water are available and the reduction of wastewater flow attributable to these and other new technologies should be considered. The reduction allowance should depend in part upon the ability of the builder or owner to ensure adequate maintenance and/or replacement in-kind when necessary.

When using either Method 2 or Method 3, the design engineer should consider the average daily flow rate as well as the maximum daily flow rate, expressed in volume per unit time for determination of this system design flow rate.

### Method 2: Wastewater Flow Data

A minimum of one year of data collected during similar operational conditions may be required by the Reviewing Engineer. If sufficient measured wastewater flow rate data is not available, Method 2 should not be used. The average of the daily (24-hour) flow over the duration of the data collection period is an acceptable method for determining the average daily flow rate. The largest daily (24-hour) measured volume during the same period expressed in volume-per-unit time is an acceptable method for determining the maximum day flow rate. The analysis should account for operational variations (e.g. peak seasonal, weekends, special events, delivery period,

etc.) and exclude extraneous data. There should be a reasonable explanation for the operational variations and any extraneous data excluded.

**Method 3: Water Usage Data**

A minimum of one year of data collected during similar operational conditions may be required by the Reviewing Engineer. If sufficient measured water usage data is not available, Method 3 should not be used. The average of the daily (24-hour) flow over the duration of the data collection period is an acceptable method for determining the average daily flow rate. The largest daily (24-hour) measured volume during the same period expressed in volume per unit time is an acceptable method for determining the maximum day flow rate. The analysis should account for operational variations (e.g. peak seasonal, weekends, special events, delivery period, etc.) and exclude extraneous data. There should be a reasonable explanation for operational variations and any extraneous data excluded.

For each of these methods, the peak hourly flow rate (largest hourly volume expressed in volume per unit time) should also be identified. When variation in the wastewater flow rate is expected to be substantial, it is necessary to examine the significant delivery period of the wastewater and base the system design upon this information to prevent an excessive rate of flow through wastewater collection and treatment systems. Flow equalization prior to treatment units should be considered to avoid hydraulic overloading of treatment units during peak loading periods (peak hourly flow and maximum daily flow).

**Table B-3 Typical Per-Unit Hydraulic Loading Rates**

***Residential***

<i>Type of Use</i>	<i>Unit</i>	<i>Gallons per Day</i>
Apartment	Per Bedroom	110/130/150 <sup>16</sup>
Mobile Home Park	“Single-Wide” Home	220
	“Double-Wide” Home	330
Single Family Residence	Per Bedroom	110 / 130/ 150 <sup>17</sup>

<sup>16</sup> 110 gpd for post 1994 plumbing code fixtures; 130 gpd for pre 1994 fixtures; and 150 gpd for pre 1980 fixtures. Homes over 1,000 gpd, community systems, or lodging establishments with high flow fixtures must account for any higher peak flow periods.

<sup>17</sup> For individual household systems under 1,000 gpd, use design flows in the NYSDOH’s *Wastewater Treatment Standards Residential Onsite Systems - Appendix 75- A*.

**Campgrounds**

<i>Type of Use</i>	<i>Unit</i>	<i>Gallons per Day</i>
Day Camp	Per Person	15
	Add for Shower	5
	Add for Lunch	5
Campground	Per Unsewered Site <sup>18</sup>	55(includes showers)
	Per Sewered Site – with water hookups	100
	Per Sewered Site – without water hookups	55
Campground Day Use	Per Person	5
Dumping Station <sup>19</sup>	Per Unsewered Site	10
	Per Sewered Site	5

**Institutional**

<i>Type of Use</i>	<i>Unit</i>	<i>Gallons per Day</i>
Assisted Living Facility/Complex	Per Bed <sup>20,21</sup> – add 10 gpd for in room kitchen	110/130/150
Group Home (residential-style building)	Per Bed <sup>20</sup> - add 150 gpd per house for garbage grinder	110/130/150
Nursing Home (hospital care)	Per Bed <sup>20,21</sup>	175
Hospital	Per Bed <sup>20,21</sup>	175
	Per Outpatient	30
Church	Per Seat <sup>20</sup>	3
Church Hall/Fire Hall	Per Seat <sup>21</sup>	10

<sup>18</sup> Additional wastewater flow due to food service or laundry shall be accounted for. Structures available for overnight occupancy other than those meeting the definition of a camping unit shall be based on 150 gpd / unit for design flow purposes, pursuant to NYSDOH – *Chapter 1 State Sanitary Code Subpart 7-3 Campgrounds*.

<sup>19</sup> The addition of flow for dump station sewage may be prorated by using an estimated percentage of sites suited for RV use based on historical data. No reduction for low flow fixture usage should be applied here.

<sup>20</sup> Add 15 gpd per employee

<sup>21</sup> Add for Food Service (e.g. 24-hour restaurant; refer to Food Service Operations Table)





Drive-In Theater	Per Car Space <sup>25</sup>	5
Factory / Distribution Warehouse	Per Employee/shift; add for showers	15 10
Fairgrounds	Per Visitor <sup>25</sup>	5
Health Club	Per Patron	20
Highway Rest Area	Per Traveler <sup>25</sup> Per Dump Station Vehicle	5 7
Hotel	Per Sleeping Unit <sup>25</sup> add for banquet hall, night club, pool/spa, theatre, etc.	110/130/150
Kennel	Per Kennel/Run/Cage	50
Laundromat	Per Machine	580
Marina	Per Slip <sup>25</sup> with shore side restroom facilities including shower; add per slip for dump station	20 7
Migrant Worker Housing	Per Person	50
Motel	Per Sleeping Unit; add for in-room kitchen; add for in-room jacuzzi/spa	110/130/150 10 20
Office Building	Per Employee <sup>25</sup> ; add for showers	15 5
Service station/Convenience store	Per Toilet <sup>25</sup>	400
Shopping Center / Grocery Store / Department Store	Per Sq. Ft. <sup>25,26</sup> ; add for deli, bakery, butcher	0.1
Swimming Pool / Bath House	Per Swimmer	10
Veterinary Office	Per Veterinarian	200

---

guidance referencing the 2002 law.

<sup>25</sup> Add for Food Service (e.g. 24-hour restaurant; refer to Food Service Operations Table)

<sup>26</sup> Add 15 gpd per employee/shift

### *Food Service Operations*<sup>27</sup>

<i>Type of Use</i>	<i>Unit</i>	<i>Gallons per Day</i>
Ordinary Restaurant	Per Seat	35
24-Hour Restaurant	Per Seat (for cafeterias: pro rate flow in proportion to the hours)	50
Fast Food Restaurant	Per Seat	25
	Per Drive-Up Window	500
Lounge, Bar	Per Seat	20
Drive-In	Per Car Space	50
Banquet Hall	Per Seat	10
Restaurant along Freeway	Per Seat	75

### **B.6.c Infiltration, Inflow, Non-Sanitary and Prohibited Flows**

Cooling water, roof drains, footing, sump and basement floor drains should not be discharged to the treatment system. Clean water from ice machines, water cooled refrigerators or coolers should also be excluded. Undetected leaks from plumbing fixtures, typically toilets and faucets, can waste significant amounts of water and subsequently increase the volume of wastewater to be treated. Simple repairs and routine operation and maintenance of plumbing fixtures can save water and increase the efficiency of wastewater treatment system.

Similarly, leaking sewer joints, pipe tank seals, tank riser seals, cracks in treatment tanks and manhole covers that are not watertight can be significant sources of infiltration of the system. These extraneous flows can cause periodic hydraulic overloads and affect treatment performance which can lead to system failure. Exfiltration from the system can have a negative impact on groundwater quality.

The discharge of swimming pool filter backwash wastewater should not be directed to a septic tank

---

<sup>27</sup> Garbage grinder use should be evaluated in the design phase of the project and accounted for in tank sizing per Section D.6 Septic Tanks.

intended as the primary treatment unit for sanitary sewage. In areas served by on-site wastewater treatment systems, the design engineer should consult local regulations for discharge of filter backwash wastewater. It may be permissible that smaller backwash or recharge discharges be directed to a grassed or vegetated area and larger discharges to a stone-filled trench, dry well or infiltration gallery to contain the discharge within the property limits. Discharges within 250 feet of a stream, pond, lake or wetland may be prohibited or require a SPDES permit.

---

#### Water Softener Discharge

---

Studies by soil scientists have found the volume or chemical composition of wastewater from the regeneration cycle (backwash, recharge, rinse) of a properly operated and maintained household-sized water softener is not harmful to a septic tank that is properly designed, operated and maintained. It was noted, however, the volume of wastewater can be reduced by:

- Activating the regeneration cycle based on need (not on a timer)
- Using a water softener with a large mineral tank
- Employing water conservation measures to reduce flow to be treated by the softener system

However, some proprietary enhanced treatment system manufacturers (e.g., aerobic treatment units) have warranties that are voided by the discharge of water softener wastewater due to problems cited in septic tanks/aerobic tanks with elevated chloride content (up to 100 times the normal non-softened concentration of 50 mg/L). The change in density caused by brine has caused discharge of solids from primary treatment tanks into secondary treatment units disrupting flocculation and settling.

The discharge of water softener recharge/regeneration wastewater to septic tanks, or aerobic or enhanced treatment units is not recommended for wastewater treatment systems treating more than 1,000 gpd. If softener backwash is to be added to any wastewater system with a design flow over 1,000 gpd, the design engineer will need to provide data showing the effluent will meet applicable water quality standards, or include design details for a treatment process that does. Alternatively, a dedicated soil absorption system may be designed by the engineer if it is deemed necessary or appropriate.

#### **B.6.d Treatment Considerations and Effluent Limits**

Acceptability of any discharge is contingent upon the ability of the proposed OWTS to meet applicable

water quality standards and criteria. The minimum degree of treatment required for the discharge of sanitary wastewater into nonintermittent surface waters is effective secondary treatment. Typical effluent limits are shown in Table B-4A below:

**Table B-4A Typical Effluent Limits for Non-Intermittent Streams**

<b>Parameter</b>	<b>Type</b>	<b>Limitation</b>	<b>Units</b>
BOD <sub>5</sub> <sup>28</sup>	30 -Day Arithmetic Mean	30	mg/L
BOD <sub>5</sub>	7-Day Arithmetic Mean	45	mg/L
TSS <sup>29</sup>	30-Day Arithmetic Mean	30	mg/L
TSS	7-Day Arithmetic Mean	45	mg/L
Settleable Solids	Daily Maximum	0.3/0.1 <sup>29</sup>	ml/L
pH	Range	6.0 – 9.0	SU
Fecal Coliform <sup>30</sup>	30-Day Geometric Mean	200	No. of colonies per 100 ml
Fecal Coliform <sup>30</sup>	7-Consecutive Day Geometric Mean	400	No. of colonies per 100 ml
Total Residual Chlorine	Daily Maximum	<sup>30, 31</sup>	mg/L
Ammonia	30-Day Arithmetic Mean	<sup>31</sup>	mg/L as NH <sub>3</sub>
Total Phosphorus	Site specific	<sup>31</sup>	mg/L as P

In all instances, a waste assimilative capacity analysis and allocation for setting water quality-based effluent limits is conducted. Such limits represent additional treatment, beyond secondary, to ensure that all applicable water quality standards and criteria are met.

An intermittent stream is defined as:

1. Any stream that periodically goes dry at any point downstream of the proposed point of discharge
  - a. OR
2. Any stream segment below the proposed point of discharge in which the MA7CD10

<sup>28</sup> The 30 days average percent removal shall not be less than 85 percent, per 40 CFR 133.102.

<sup>29</sup> No Sand Filtration = 0.3 mg/L, Sand Filtration = 0.1 mg/L.

<sup>30</sup> Monitoring of these parameters only required during the period when disinfection is required.

<sup>31</sup> Limitation may be required depending on-site specific conditions.

stream flow is less than 0.1 cubic feet per second as estimated by methods other than continuous daily flow measurements

Discharge to an intermittent stream typically requires more stringent effluent limitation. Other methods of disposal should be considered first before proposing to discharge to an intermittent stream. Data should be supplied to show the discharge from any wastewater treatment facility would not contravene water quality standards. Typically, discharges to intermittent streams are required to meet the limits shown in Table B-4B.

**Table B-4B Typical Effluent Limits for Intermittent Streams<sup>32</sup>**

<b>Parameter</b>	<b>Type</b>	<b>Limitation</b>	<b>Units</b>
BOD <sub>5</sub>	Daily Maximum	5	mg/L
TSS	Daily Maximum	10	mg/L
Settleable Solids	Daily Maximum	0.1	ml/L
Total Residual Chlorine	Daily Maximum	0.02	mg/L
Ammonia <sup>33</sup>	Daily Maximum or Average	2.2 in winter 1.5 in summer	mg/L as NH <sub>3</sub>
Dissolved Oxygen	Daily Minimum	≥ 7.0	mg/L
pH	Range	6.0 – 9.0	SU
Total Phosphorus	Site-specific	Site-specific	mg/L as P
Coliform, fecal, when disinfecting	30-day geometric mean	200	Number of colonies per 100 ml
Coliform, fecal, when disinfecting	7 consecutive-day geometric mean	400	Number of colonies per 100 ml

Direct discharge of effluent from an OWTS to a receiving stream may be allowed contingent upon the design of the treatment system to meet applicable water quality standards and the applicant applying for and being issued a SPDES permit by NYSDEC. When deriving a water quality based SPDES permit effluent limitation from a surface water standard or guidance value, contributing factors like analytical

<sup>32</sup> Operational experience indicates a single-pass intermittent sand filter alone may not provide sufficient treatment to meet intermittent stream effluent limits.

<sup>33</sup> Consistently effective nitrification cannot be expected from buried sand filter treatment systems that operate on a seasonal basis.

detectability, treatability, natural background levels and waste assimilative capacity of the receiving stream are considered.

Preliminary effluent limitations can be obtained by contacting the Department prior to initiating design. An engineering report that addresses the capability of the treatment system to meet proposed effluent limitations should be included with the submission of design plans.

## **B.7 Groundwater Monitoring and Monitoring Well Requirements for Systems Greater than 30,000 gpd**

Subsurface disposal is frequently the choice for smaller systems (30,000 gpd or less). Groundwater monitoring is required for systems discharging over 30,000 gpd to soil absorption systems. Surface discharges are more often selected for larger systems due to a lack of suitable soils of adequate depth or breadth.

Depending on the results of the site evaluation and what was agreed upon at the pre-application meeting with regional NYSDEC staff, groundwater monitoring and monitoring-well requirements may be necessary for the project. The following specifications and monitoring frequency should be discussed with the Reviewing Engineer. There also may be local requirements in some areas of the state, e.g. Suffolk County Department of Health Services, Nassau County Department of Health.

---

### Monitoring Well Installation

---

Monitoring wells are to be designed to meet site-specific conditions of geology and hydrology with special considerations given to:

- Characteristics of soil and rock formation at the site;
- Depth to water table, bedrock, and any impervious layer;
- Aquifer thickness
- Rate and direction of groundwater flow;
- Seasonal variations in flow, depth and direction of flow;
- Potential for mounding of groundwater and its effects;
- Presence of and distance to nearby surface water;
- Presence of and distance to nearby water supply wells; and
- Other relevant site-specific considerations.

In general, monitoring well construction should follow the requirements for solid waste facilities as per 6 NYCRR Part 360-2 and the guidelines listed below:

- The well's inside diameter should be at least 2 inches
- The screen length should be at least 5 feet, but not more than 20 feet long
- The depth and length of the screen should be such that annual fluctuations of the water table do not result in a dry well.

Deviations from these requirements may require NYSDEC approval prior to construction. If there are any questions regarding these guidelines, or they are in conflict in some manner, please consult the Reviewing Engineer.

---

#### Driller's Log

---

A well driller's log should be submitted to the Department for each permanent monitoring well constructed, and may also need to be submitted to other agencies, such as counties that have their own well regulations. Well-completion logs should contain a diagram of the completed well, all pertinent details on well construction, a description of the materials used, and elevations of all well features and include:

- Monitoring well identification number and location
- Type of drilling equipment, driller, and drilling company
- Method of drilling, including size of borehole
- Type, size and placement of casing, including amount of casing above grade
- Type, size and placement of well screen
- Type, size and placement of filter pack
- Type, size and placement of annular seal
- Description of materials penetrated
- Depth to water table, and date and time measured
- Monitoring well development details

A site map should be provided at appropriate scale showing monitoring well locations in relation to the subsurface disposal system as designed. The number and location of wells should be determined in conjunction with the Reviewing Engineer.

---

#### Water Level Measurement

---

Water level measurements for each monitoring well should be related to a permanent reference point on the well casing. Locations and elevations of all monitoring wells should be surveyed to obtain their precise location and plotted on a map. The vertical location of the ground surface and the water-level measurement reference mark of each monitoring well should be accurately measured to the nearest 10<sup>th</sup> foot using a common datum, preferably the NAD83 datum. Static water levels should be measured to the nearest tenth foot.

---

#### Water Quality Sampling

---

- Proper sampling procedures should be followed to prevent contamination of the wells or collected samples
- Analysis must be conducted by ELAP-certified labs using analytical methods in compliance with 40 CFR Part 136 -*Guidelines Establishing Test Procedures for the Analysis of Pollutants*
- Sampling should be conducted by properly trained individuals
- Appropriate QA/QC procedures should be followed
- Appropriate sampling chain-of-custody record keeping should be followed
- Obtain static water level for each well and sampling event
- Thorough decontamination rinsing of pumping/bailing equipment is necessary prior to use in each well
- Up-gradient monitoring wells should be sampled first.
- An amount of water equal to at least three times the volume of water standing in the well should be removed prior to sampling.
- The well should be allowed to recover to at least 75 percent of the static water level prior to sampling.
- The water taken from each well should be held or discharged on the ground far enough away from the well such that it will not affect sampling results. Soil erosion should also be avoided.



---

## Sampling Parameters

---

### Baseline (first round) Sampling:

The following lists contain parameters typically required for groundwater monitoring of a SPDES permitted discharge larger than 30,000 gpd. Sampling and analysis for these parameters should be conducted using the method best able to monitor at or below the effluent limitations and in compliance with 40 CFR Part 136-*Guidelines Establishing Test Procedures for the Analysis of Pollutants*. The parameters that may be required are:

- Static Water Levels
- Specific Conductance
- pH
- Chloride
- Alkalinity
- Total Hardness as CaCO<sub>3</sub>
- Field Observations (colors, odors, surface sheens, etc.)
- Ammonia
- Total Kjeldahl Nitrogen (TKN)
- Nitrate
- Nitrite
- Sulfate
- Total Dissolved Solids (TDS)
- MBAS (methylene blue active substances - an indicator of foaming agents)
- Fecal Coliform

### Subsequent (Routine) Monitoring:

Monitoring frequency is determined by the Reviewing Engineer. The parameters that may be required are:

- Well Static Water Levels
- Specific Conductance
- pH
- Field Observations (colors, odors, surface sheens, etc.)
- Chloride
- Nitrate

- Nitrite
- TKN
- Total Dissolved Solids
- MBAS (methylene blue active substances – an indicator of foaming agents)
- Fecal Coliform

The Department may modify either list as necessary. Where Total is used, all species in the groundwater that contain this element are included.

## **C. Sewers and Sewage Pumping Stations**

### **C.1 Introduction**

Most municipal collection systems built under the federally funded Construction Grant Program, or since 1990, funded via the Clean Water State Revolving Fund, used conventional gravity sewers to convey wastewater. Gravity sewers may not be practical where there is low density of residences, adverse grades or soil conditions, high groundwater, or high rock elevations. Alternative systems such as septic tank effluent, grinder pump, and vacuum sewers can be proposed in these instances. Septic tank effluent sewer systems may be either a pump or gravity system. Cost analysis results (capital plus operation and maintenance over the life of the system) have shown that alternative collection systems are at times more cost effective than conventional gravity systems. Alternative systems can:

- Significantly reduce the peak quantity of wastewater which needs to be treated, greatly reducing the capital and operating costs of the treatment system
- Have much smaller pipe sizes, shallower depths, and fewer manholes
- Be used in combination with conventional gravity and pump station systems

Sewer systems have been designed for the estimated future tributary population, which included maximum anticipated capacity of institutions, industrial parks, etc. However, in some cases projected populations have not been attained, or retrofitted low-flow fixture use has resulted in wastewater velocities staying below scour velocity long enough to generate odors and destructive atmospheres in pipes and pump stations. Therefore, site-specific water use rates, existing treatment capacity, and flow meter data (if available) should be used for design of sewer extensions or collection systems.

### **C.2 Building Sewers**

---

#### Building drain

---

The New York State Uniform Fire Prevention and Building Code defines a building drain as a pipe extending from the interior plumbing to a point 30" outside the building wall. Thereafter, piping to the point of disposal is defined as the building sewer. The code specifies requirements for both building drains and building sewers.

---

## Venting

---

Where required locally, the New York State Uniform Fire Prevention and Building Code allows traps to be installed inside or outside the building, and requires a relief vent or fresh air intake on the inlet side of the trap. The design of any sewage collection system should account for the location of the house/building trap and vent. The system should be constructed to prevent freezing, and be compatible with the venting requirements of the sewage collection system.

---

## Building Sewer

---

The building sewer connects the building drain to on-site treatment facilities, or the municipal sewer. A second building sewer is required to convey non-petroleum grease laden wastewater to a grease interceptor (see Section D.5). Building sewers should have a minimum diameter of four inches and should be laid on a firm foundation with a minimum grade of  $\frac{1}{4}$  inch per foot and straight alignment, for gravity flow. The building sewer should be installed at the shallowest depth possible to ensure effective treatment by the STS, or to minimize excavation cost for the municipal collection system.

At least one cleanout should be provided for all building sewers. If bends of 45 degrees or more are necessary, an accessible cleanout fitting should be provided for each bend. Building sewers greater than 100 feet long should be fitted with additional cleanouts at intervals of about 100 feet.

### **C.3 Conventional (solids handling) Gravity Sewers, Manholes and Pump Stations**

#### **C.3.a Conventional Gravity Sewers**

---

##### Piping Material Specification

---

The piping material selected should be adapted to local conditions, such as character of wastes, possibility of septicity, soil characteristics, exceptionally heavy external loadings, and abrasion. Maximum benefit can usually be achieved with non-metallic materials such as polyethylene, fiberglass reinforced plastic (FRP), and PVC. Other acceptable pipe materials are ABS (acrylonitrile butadiene styrene), concrete, ductile iron and fiberglass/polyester composite. Sewer pipe materials such as vitrified clay, bituminous fiber (commonly known as Orangeburg), asbestos cement, steel, cast iron, and other metals which are typically found in older systems, should not be used in the design of new systems.

All sewers should be designed to prevent damage from superimposed loads. Structural reinforcing may be necessary for gravity sewers installed at depths of less than four feet. Proper allowance for loads on the sewer due to the width and depth of the trench should be made. All flexible pipes (PVC, FRP, etc.) should undergo alignment, deflection, and leakage testing after installation according to *Ten States Standards*, or *TR-16* (also see Appendix C “Sewer and Manhole Leakage Tests”).

Relevant ASTM standards include:

- ASTM D1785 for schedule 40, 80 and 120 pipe
- ASTM D2729 for polyvinyl chloride sewer pipe and fittings
- ASTM D2852 for styrene rubber plastic drain pipe
- ASTM D3034 for PSM polyvinyl chloride sewer pipe and fittings

---

## Pipe Sizing

---

- The gravity sewer pipe should be designed based on peak hourly flow. The minimum pipe diameter and slope of solids-carrying gravity sewers for most municipal collection systems should comply with the guidelines prescribed by the *Ten States Standards*, or *TR-16*. For small municipalities or cluster developments, no public gravity sewer conveying raw sewage should be less than 8 inches (20 cm) in diameter. Such sewer systems using 8 inch (20 cm) or larger diameter pipe are recommended by *Ten States Standards* and *TR-16*.

Exceptions to using *Ten States Standards* or *TR-16* for pipe sizing for institutional, commercial and private facilities are as follows:

- Sewer systems conveying raw sewage may use a 6 inch (15 cm) minimum diameter collector sewer with a minimum slope of 1/8-inch per foot (1.0 percent).
- Trunk sewers should be a minimum of 8 inch diameter with a minimum 0.4 percent slope.
- In very small installations, 4-inch diameter sewers may be used for raw sewage if a minimum slope of 1/4-inch per foot (2 percent) is maintained and a velocity of at least 2 feet/second is achieved when the sewer is flowing full. The use of smooth interior pipe is recommended.

---

## Sewer Installation

---

Sewers should be sufficiently deep to prevent freezing. Where freezing conditions could occur, and sufficient depth cannot be accomplished, insulation or a raised earthen berm should be provided.

Excavations must meet OSHA requirements and conform to standard accepted practices.

All pipes should be properly bedded in accordance with standard accepted practice for the type of pipe being installed. Backfilling should be performed in steps. Backfill should be placed to avoid disturbing alignment of the pipe, and should be slightly mounded to allow for settling. Where velocities greater than 15 fps are expected, or on slopes of 20 percent or greater, special provisions should be made to protect against displacement.

Conventional gravity sewer lines two feet or under in diameter should be laid on straight alignment and uniform slope between manholes using the minimum slopes given in the *Ten States Standards*.

Sewer joints should be designed to minimize infiltration and to prevent the entrance of roots throughout the life of the system. All sanitary sewers, manholes and cleanouts need to be tested for leakage (see Appendix C “Sewer and Manhole Leakage Tests”).

### **C.3.b Conventional Sewer Manholes**

Manholes should be placed on large-pipe raw-sewage gravity sewers (8" minimum) at the junction of two or more sewer lines; all points of change of grade, size or alignment; at the end of all lines; and at distances not to exceed 400 feet between manholes.

If the topography is very uneven and frequent changes in alignment and slope are necessary, a limited number of inspection pipes may be substituted for manholes. Not more than one inspection pipe should be placed between two successive manholes.

For gravity sewers conveying raw sewage, cleanouts may be substituted for “end of line” manholes only where the length of run to a manhole does not exceed 150 feet.

Drop manholes (90°) should be used for all conventional gravity sewers entering at an elevation of 24 inches or more above the manhole invert. Where the difference in elevation between the incoming sewer and manhole invert is less than 24 inches (61 cm), the invert should be filleted to prevent solids deposition.

Sizing for manholes and other sewer appurtenances is given in Table C-1. Nonstandard manholes may be used on small diameter sewers (4 and 6 inch) if the system will not be dedicated as a portion of a municipal system. A smooth channel should be formed on the bottom, and pipe entrances should be properly grouted.

Manholes should be of pre-cast or poured-in-place concrete, and should be waterproofed on the exterior. Exterior waterproofing may be omitted for precast manholes when information proving watertightness is provided. Inlet and outlet pipes should be joined to the manhole with a watertight connection that allows for differential settlement between the manhole and the sewer pipe. Covers should be above grade or made watertight and of sufficient weight or design to prevent unauthorized entry.

**Table C-1 Minimum Size of Sewer Appurtenances**

Fixture	Diameter
Drop Manholes	60 inch
Standard Manholes	42 inch
Nonstandard Manholes	24 inch
Inspection Pipes	24 inch
Cleanouts	8 inch <sup>34</sup>

**C.3.c Sewage Pumping Stations**

1. Design Considerations for Pump Stations

Sewage pumping stations should not be subject to flooding as described in Section B of this document. A suitable superstructure is desirable to enable convenient access under all weather conditions. Below-grade dry pit pumping stations should have a sump pit and sump pump capable of removing any water from the dry pit well.

For gravity sewers and pump stations, the expected wastewater flow rate used for design should be the design peak hourly flow. In general, pump installation should be designed to handle a design flow of four times the average daily flow. Certain applications may require a higher peaking factor. Design of components downstream of a pump station should consider the pump capacity as well as any additional

<sup>34</sup> Cleanouts (sized for maintenance purposes) may be under 8 inches if the pipe diameter is under 8 inches.

flow from build-out analysis.

Where applicable, with due consideration given to the particular wastewater characteristics or pump station design, the pump should be preceded by readily accessible bar racks with clear openings not exceeding 1½ inches. Exceptions may be allowed if pneumatic ejectors are used or if special devices are installed to protect pumps from clogging or damage. Consideration should be given to duplicate racks or a suitable emergency bypass for rack cleanout. Where racks are located below ground, convenient facilities should be provided for rack cleanout.

Except where grinder or cutter pumps are used, 3-inch pumps handling raw sewage should be capable of passing spheres of at least two inches in diameter. Larger pumps should comply with New York's official standards for municipal wastewater treatment and collection facilities. Pumps should be so placed that under normal operating conditions, they will operate under a positive suction head except for self or vacuum-priming pump systems.

Electrical equipment in wet wells or in enclosed spaces where explosive gases may accumulate or where there is risk of being submerged, must be designed and installed in strict conformance with the latest edition of the National Electrical Code (NEC).

At least two pumps or pneumatic ejector compressor/tank assemblies should be provided except for unusual circumstances which should be reviewed individually. In the case where only two units are provided, each should be capable of handling the peak hourly flow and the two pumping units should be identical. If three or more pumps are used, they should be designed such that with any one unit out of service, remaining units will have the capacity to handle the peak hourly flow.

Suitable shutoff valves should be placed on the suction line of each pump. A shutoff and a check valve should be placed on the discharge line of each pump. There should be shutoffs on both sides of the check valve for maintenance purposes. Check valves should be placed on the horizontal portion of discharge piping except for ball check valves, which may be placed in the vertical run.

In the case of submersible pumps, a shut-off valve for each pump should be located outside the pump station unless it is accessible from grade without the need to enter the wet well. Where the wet well nonworking or reserve volume is inadequate for emergency periods, consideration should be given to an easy bypass connection in the piping to connect an emergency pump.



---

## 2. Types of Pumps

---

Categories of sewage pumping units include; submersible pumps, dry pit pumps, pneumatic ejectors, vertical wet pit pumps, suction lift pumps and systems, and airlift pumps.

Submersible pumps should be readily removable and replaceable without the need for personnel to enter the wet well and without interrupting the normal operation of the other pump(s). Vortex type, open impeller, and cutter/grinder pumps are acceptable. Submersible pump stations should meet the requirements outlined in *Ten States Standards* or *TR-16*, except where alternative collection systems are used (see Section C.4 Effluent Sewers).

Underground pump station structures constructed of steel should be coated with an acceptable corrosion-resistant material. The structure should be supplied with two properly sized anodes for cathodic protection to be buried on opposite sides of the structure and electrically connected to the structure by heavy copper wire. To prevent corrosion, connectors should be compatible with the type of wire used. Pneumatic receiver pressure vessels should be rated for 150 percent of the maximum pressure achievable in the station.

Suction lift sewage pumping stations should meet the requirements outlined in the *Ten States Standards* or *TR-16*. The design should be confirmed with the pump manufacturer.

---

## 3. Alarm Systems

---

Alarm systems should be provided for all pumping stations and dosing systems to alert the system operator in cases of power failure, pump failure, unauthorized entry, high liquid level exceeded or other cause of pump station malfunction. Stations not visited daily and not equipped with running time meters should signal an alarm upon operation of the lag pump or spare pump. If the alarm system is connected via phone line to a remote location (remote telemetry), a separate alarm should be provided to signal failure of the communication link.

---

## 4. Emergency Operation Provisions for Pump Stations

---

Provision for emergency operation should be made whenever there is a possibility of discharge other than through the force main. Emergency procedures include a second-source electrical supply, a portable pump or generator and adequate emergency overflow storage capacity. Where the wet well non-working or

reserve volume is inadequate for emergency periods, consideration should be given to an easy bypass connection in the piping to connect an emergency pump. Time delay and operator requirements should be considered when planning emergency options.

---

## 5. Overflows

---

The provision of a wet-well overflow should be evaluated and consideration should be given to an adequately sized overflow/detention tank, which should empty to the wet well when pumping operations resume. No discharge onto the ground is permitted. A wash-down system should be provided for the detention tank.

---

## 6. Dry Wells

---

For dry pit sewage pumping stations, consideration should be given to providing pumps with a watertight motor drive.

Suitable and safe means of access should be provided to dry and wet wells containing either bar screens or mechanical equipment. Access hatches should have handgrips. Hatches also should be located directly over ladders or manhole steps and equipped with two hold open devices.

Personnel should be provided adequate positive or forced-air ventilation in dry pits or spaces, requiring entry. These areas should meet the minimum ventilation requirements of *Ten States Standards*, or of *TR-16*. The method of meeting ventilation and air flow requirements depends upon the type of pumping station, configuration, location, and other pertinent parameters. All intermittently operated ventilation equipment should be interconnected with the lighting system for the space, as a safety feature.

---

## 7. Wet Wells

---

Wet-well size, configuration, and control setting should be such that heat buildup in the pump motor due to frequent starting and septic conditions due to excessive detention time are avoided. Generally, a holding period of between 10 and 30 minutes for the maximum design flow is recommended.

If it is judged that grit will be a problem, pumps for raw sewage should be preceded by grit removal equipment. Where it may be necessary to pump sewage prior to grit removal, the design of the wet well should receive special attention and the discharge piping should be designed to prevent grit settling in

discharge lines of pumps not operating.

All electrical splices, junction boxes, or connections for sewage wet wells should be designed and installed in strict conformance with the latest edition of the National Electrical Code (NEC). Structures should be classified as to the hazard of explosion or ignition. If a hazard classification cannot be determined, such structures should be given a “Class 1-Group D” hazard classification. All electrical wiring, connections, devices, equipment and enclosures within or connected to classified locations must comply with the appropriate sections of the National Electrical Code. All control panels should be NEMA-4 (National Electrical Manufacturers Association) rated for weather, water and dust resistance, or NEMA-4X rated for corrosive environments (in addition to the above conditions). All control panels should have a thermostatically controlled heater to prevent condensation.

On smaller installations where an operator is not on site at all hours, remote telemetry is recommended for pump chambers not equipped with submersible electrical connections.

Level controls (float bulbs, bubbler tubes, wires, transducers, etc.) should be located so as not to be unduly affected by turbulence from incoming flows and pump suction. In stations with duplicate pumps, provisions should be made to automatically alternate between the pumps in use, and consideration should be given to the use of running time meters.

Covered wet wells should have provisions for ventilation or air displacement to the atmosphere such as an inverted J-tube or similar device. If personnel are required to enter the wet well for maintenance purposes, the well’s design should meet the minimum requirements of *Ten States Standards*, or of *TR-16*.

## **C.4 Effluent Sewers**

Septic Tank Effluent Pump/Gravity (STEP/STEG) sewers convey anaerobic septic tank effluent which is corrosive to a treatment system and odorous. Pipe, pumping equipment and septic tanks should be manufactured of appropriate materials to withstand or control these adverse conditions.

ASTM-designated materials include ABS (ASTM F628), PVC (ASTM D2729), high-density polyethylene (HDPE), or fiberglass/polyester composite (ASTM D3754) are materials that are conventionally used. Piping made of other ASTM designations may be allowed if it can be shown to be adequate both structurally and chemically for the proposed conditions. Table C-2 provides a comparison of the benefits of HDPE versus PVC as used for piping material.

**Table C-2 Comparison of Commonly Used Pipe Materials for STEP/STEG Systems**

(Table 4.3 of *WEF's Alternative Sewer Systems*, MOP FD-12, 2008 and *Guidance Manual for the Evaluation of Effluent Sewer Systems* by Electric Power Research Institute [EPRI], et al., 2004)

	PVC		Polyethylene (HDPE)	
	Solvent weld	Elastomeric	Drain, waste, vent	
<b>Commonly used types</b>	Iron pipe size Schedule 40: 10 cm (4 in.) diameter SDR 21: 5 cm (2 in.) diameter	Iron pipe size SDR 21	Sewer dimensions SDR 35	SDR11(1,100 kPa [160 psi]) SDR 9 (1,380 kPa [200 psi])
<b>Typical uses</b>	STEG or STEP; Service lines; Small mains	STEG or STEP; Mains	STEG or STEP; Building sewers only (recommended)	Water crossing; Borings; Cold zone mains
<b>Advantages</b>	Readily available	Easy to join; Enables thermal movement	Readily available	Seamless; Enables continuous trenching
<b>Disadvantages</b>	More difficult to join in cold temperatures, wet conditions, dust, and mud	Joining rings may not be available for small sizes	Thin wall (Not recommended for pressurized mains)	Cost of heat fusion joining equipment
<b>Relative costs</b>	Medium	Medium	Low	Medium

Because septic tank effluent is considered partially treated wastewater, the cost for the design and construction of treatment works should be compared to those of conventional gravity sewerage and determined within the confines of the design criteria below. Septic tank effluent pump (STEP) and/or septic tank effluent gravity (STEG) system proposal costs are often less when associated with a small community, or urban areas with shallow bedrock or seasonally high groundwater.

For both STEP and STEG systems, effort should be made to establish septic tank maintenance districts for cleaning procedures in conjunction with the facility planning and design phases. The key to successful operation of these systems is retention of solids in the septic tank. Sewer use ordinances and/or local health codes, therefore, should include adequate provisions to ensure proper operation, use, connection to, and construction of such small diameter sewers.

In designing small diameter septic tank effluent sewer systems, additional consideration should be given to protect against freeze-ups due to construction at shallow depths susceptible to frost penetration. The piping from septic tank outlets is normally shallower than that of conventional gravity building sewers, which is often at or below the basement floor level.

To evaluate whether STEP/STEG sewer is an appropriate design choice for a specific application, Table C-3 contains design parameters to consider. It also compares small diameter sewer systems with conventional gravity sewers. For further information, see the *WEF's Alternative Sewer Systems*, MOP FD-12, 2008.

**Table C-3 Quick Comparison of Collection Alternatives** (TABLE 1.1 of WEF MOP FD-12, 2008)

Issue	Effluent Sewer		Grinder Pump Pressure (GP)	Vacuum Sewer	Conventional Sewer (CS)
	STEG	STEP			
	<b>Annual inspections - suggested preventative maintenance</b>				
	Yes	Yes	Yes	Yes	No
	<b>Septage pumping from on- lot septic tank, as required</b>				
	Yes	Yes	No	No	No
	<b>On- lot electrical connection required?</b>				
	No	Yes	Yes	No	N/A
	<b>Discharge wastewater characteristics:</b>				
<b>Strength Reason</b>	Low STE	Low STE	High Undiluted	High Undiluted	Medium Diluted
<b>Flow Reason</b>	Low Low infiltration and inflow	Low Low infiltration and inflow	Low Low infiltration and inflow	Low Low infiltration and inflow	High High infiltration and inflow
<b>Corrosion/odor Potential Reason</b>	High Sulfides from septic tank	High Sulfides from septic tank	Low to high Function of line length	Low Aeration of volatile solids	Low to high Function of force mains
<b>FOG (mg/L)</b>	Low	Low	High	High	Medium
	<b>Terrain effects:</b>				
<b>Discharge above surface</b>	No	Yes	Yes	Yes	Yes, with lift stations
<b>Discharge below source</b>	Yes	No	No	Yes	Yes
<b>Undulating terrain</b>	Yes, use a mix of both		Yes, with CS	Yes	Yes, with GP
	<b>Discharge to:</b>				
<b>Conventional sewer Notes:</b>	Yes Extra design concerns	Yes Extra design concerns	Yes N/A	Yes N/A	Yes N/A
<b>Biological treatment</b>	Yes	Yes	Yes <sup>35</sup>	Yes <sup>35</sup>	Yes
<b>Constructed wetlands</b>	Yes	Yes	Yes <sup>35</sup>	Yes <sup>35</sup>	Yes

<sup>35</sup> Pretreatment is necessary.

## C.4.a Septic Tank Effluent Gravity (STEG) Sewers

Septic tank effluent gravity (STEG) sewer systems are small diameter gravity (SDG) sewers conveying partially treated wastewater. All STEG systems should be designed with properly sized, watertight tanks at each home that discharges filtered effluent. STEG systems are not prone to inflow and infiltration, or to the gross solids associated with conventional gravity sewers, TSS is typically under 60 mg/L and oils and grease under 25 mg/L. STEG effluent is anaerobic and prone to odors and corrosion from turbulence in concrete manholes exposed to free atmosphere. Therefore, cleanouts are preferred over manholes.

STEG/SDG systems generally maintain a continuous positive grade to convey partially treated wastewater to a centralized location for further treatment. STEG systems can be designed with variable or inflective vertical and horizontal gradients, which can minimize the extent of excavation necessary to install the system. With the use of inflective grades, both positive and negative, some pipe sections may be permanently full of septic tank effluent. It may be necessary for some facilities to incorporate pumps and check valves into their system design to prevent backflow from the collection system. Air release valves or ventilated cleanouts may be necessary at high points of the sewer main to prevent air binding.

---

### Small Diameter Gravity Sewer Pipe Sizing and Slopes

---

The smallest recommended lateral, collector, or main pipes is 4 inches for STEG systems, and the recommended minimum slopes for STEG/SDG sewer pipe installations should be adequate to convey peak hourly flows. Neither the *Ten States Standards* nor *TR-16* stipulates minimum slopes for pipe diameters under 8 inches in diameter. The minimum slopes given are for pipes conveying raw sewage only, not settled sewage.

The hydraulic design for STEG systems may be based entirely on open channel flow, like conventional raw sewage gravity system designs, or based on the use of variable or inflective gradients. Decreased width and depth of trenches can minimize property damage resulting from construction excavation. Design features of these two alternatives are as follows:

1. Continuous Gradient
  - a. Continuous negative gradient throughout the system
  - b. Open channel flow
  - c. Minimum of 1 ft/sec flow velocity at half-full conditions
  - d. Curvilinear horizontal alignment

## 2. Variable Gradient

- a. Flat or undulating profile with overall fall
- b. Full pipe sections depressed below the Hydraulic Gradient Line
- c. Minimum of 0.5 ft/sec flow velocity in flooded sections during daily peak flows
- d. Curvilinear horizontal and vertical alignments

For variable gradient hydraulic design, air release valves or ventilated cleanouts may be necessary at the high points of the main to prevent air binding. Where full pipe conditions occur, design changes should be made for any resulting surcharged service connections. Either eliminate the downstream flow restriction causing the surcharged service connections or incorporate pumped effluent sewer connections.

The purpose of maintaining a minimum flow velocity when the pipe is flowing full is to minimize the septicity of the sewer effluent in the pipe, and not adversely impact the treatment process downstream. It is imperative that adequate septic tank maintenance procedures be established to ensure the retention of solids in septic tanks.

---

### STEG System Design Factors

---

STEG sewer systems should be designed in accordance with the standards given below or in accordance with design guidance such as the *WEF's Alternative Sewer Systems*, MOP FD-12, 2008, or other states' guidance.

- All wastewater and gray water sources should be served, including collecting wastewater from sources located within basements.
- Watertight septic tanks should be sized, constructed and maintained per Section D.6
- Septic tank effluent filters should be used per Section D.7.
- Include a check valve in each building's service connection if back flooding is possible.
- Net positive gradient for sewer main is required (variable grade segments allowed).
- Minimum Hazen-Williams roughness coefficient  $C = 120$ .
- Flushing connections are recommended.
- A vertical drop from the sewer line carrying septic tank effluent to a manhole should be avoided to minimize odor release due to turbulence. A 45-degree sloping approach to the manhole should be used to minimize this nuisance.



## C.4.b Septic Tank Effluent Pump (STEP) Sewers

A Septic Tank Effluent Pump (STEP) system is a sewer system in which effluent from a user's septic tank is pumped through a small-diameter pipe system that either transfers the effluent directly to treatment components or to a central collection point for transfer to treatment components. The effluent pump is located in a pump chamber -inside the tank or next to it in a chamber dedicated to it. Piping in STEP collection systems can be laid to follow grade, making these systems suitable for areas where there is undulating ground, rock close to the surface, or high groundwater levels.

STEP systems are often used in combination with STEG systems. The STEP system can be used as a tributary sewer, pumping up from low-lying areas into the main STEG system. Where the STEP sewer discharges into the STEG sewer, odors from turbulence or excessive velocities should be anticipated and the system designed to prevent any problems or nuisances.

---

### STEP System Design Factors

---

STEP sewer systems should be designed in accordance with the standards given below, the *WEF's Alternative Sewer Systems*, MOP FD-12, 2008, or other states' guidance.

- All components of the effluent pump system should be resistant to corrosion.
- Because the effluent is relatively free of solids, the service lateral (pump discharge pipe to collector main) can be as small as 1.25" in diameter.
- All wastewater and gray water sources can be served, including collecting wastewater from sources within basements.
- Duplex pumps, 24 hour storage volume, emergency generator with automatic cutover during power loss, or a solenoid shutoff valve for the water supply line with manual override should be considered to prevent sewage backups due to pump or power failure.
- Watertight septic tanks should be constructed and maintained per Section D.6.
- Septic tank effluent filters should be used per Section D.7.
- Isolation valves and redundant check valves should be used at each building's sewer service connection.
- Typical 2"-pipe diameter for force mains
- Tracer wire should be installed with all force mains.
- Isolation valves should be placed at intersections.

- Minimum velocity of 1 foot/s
- Minimum Hazen-Williams surface roughness coefficient (C) of 120
- All pumps should be sized to avoid overloading
- Flushing connections should be spaced every 500- 1,000 feet along the forcemain.
- Air release valves should be installed at high points; odors may have to be controlled.
- Careful placement of air release valves should be considered when incorporating centrifugal pumps.

Where velocities greater than 15 feet per second are expected, or slopes greater than 20 percent, special provisions must be made to protect against displacement by erosion or shock.

---

#### Pump Selection for STEP

---

For general purposes, the total head of a pump system is the sum of the static head plus friction losses in the system. Wastewater flow for single-family dwellings typically ranges from 40 to 60 gallons per capita per day (gpcd); 50 gpcd is a commonly used minimum value. A per capita design flow of 50 to 70 gpcd is recommended for most residential-only systems, depending on local variables (water source quality and quantity water pressure, affluence, low-flow fixtures and attitude toward conservation).

Design flows for effluent sewers serving private, commercial or institutional establishments should be taken from Table B-3. The flow rate, when pumping from a tank, should be slow enough to allow maximum settlement of solids, adequate fat, grease and oil retention, and an efficient power rating, but not so slow that the pump's runtime is excessive.

High-quality submersible turbine type pumps are common in STEP systems because of their extreme resistance to corrosion, high cycle life (250,000), light weight (30 lbs.) and their ability to pump 5 to 20 gpm at discharge heads greater than 200 feet. Another advantage is their ability to operate for extended periods when the discharge line is blocked and back pressure builds beyond the maximum "shutoff" head.

#### **C.4.c Septic Tank Effluent Manholes and Cleanouts**

Hydraulic cleanouts are normally considered superior to manholes for pipes conveying settled sewage and are used exclusively for standalone STEP-STEG systems. However, manholes may be necessary at the junctions of two or more small-diameter gravity sewer lines or at the junction of a small-diameter sewer with a conventional gravity sewer. Specification of watertight manhole covers at such locations is highly

recommended to prevent infiltration, and grit from entering the system. Manholes should be located where they will be least susceptible to damage from snowplowing.

Gases generated in the septic tank under anaerobic conditions may be toxic and odorous. Any turbulence in the system enhances the release of gases from the septic tank effluent. To minimize the release of toxic or odorous gases, use of a 90° drop inlet for a manhole, inspection port, or pump station should be avoided, and a 45° sloping drop should be used instead.

The use of cleanouts (pigging ports) for line cleaning is common practice for small diameter sewer systems. Line cleaning (pigging) of the waste system should be done just before the system is put into service to clear any restrictions/blockages from construction debris or to restore normal functioning if the system becomes plugged.

## **C.5 Conventional Force Mains**

---

### Design Factors

---

At maximum design flow, a sewage velocity of at least 2 feet per second should be maintained in the force main. Consideration should be given to achieving a solids pickup velocity of 4 feet per second. Velocity calculations should be based on the actual inside pipe diameter.

Force mains in systems located above the frost line and that operate on a seasonal basis should have the capability of being drained to avoid freezing problems. The drained sewage should be disposed in compliance with all applicable laws and regulations. Additionally, insulation should be considered for the force main above the frost line. The design of the sewer should consider a lower Hazen-Williams coefficient than a year-round system. This is due to the likelihood that solids will accumulate in a force main that does not operate continuously, increasing the roughness of the line.

In general, 3-inch diameter pipe should be the smallest used for raw sewage force mains. However, use of grinder pumps or similar equipment may enable use of smaller pipe.

It is recommended that automatic air relief valves be installed in manholes at high points in the force main to prevent air locking. Those relief valves may need to be drained on a regular basis. Valves with hose connections for regular flushing and freeze prevention and that are readily accessible to the ground surface should be used.

Installation of a pressure gauge calibrated in feet of water and equipped with a snubber, and a spring loaded shutoff valve located on the force main after the valves should be considered.

---

#### Pressure Testing of Force Mains

---

Pressure tests should be made only after completion of backfilling operations and at least 36 hours after the concrete thrust blocks have been cast. All tests should be conducted under the supervision of the design engineer.

The duration of pressure tests should be 1 hour, unless otherwise directed by the engineer. The test pressure should be no less than 50 psi, with a recommended pressure of 2-1/2 times the maximum system operating pressure.

The pipeline should be slowly filled with water. Before applying the specified pressure, all air should be expelled from the pipeline by making taps at the point of highest elevation. The specified pressure, measured at the lowest point of elevation, should be applied by means of a pump connected to the pipe in a manner satisfactory to the design engineer. After completion of the test, the taps should be tightly plugged.

---

#### Termination of Force Mains

---

Force mains should enter a gravity sewer at a point no more than 2 feet above the flow line of the receiving manhole. Force mains and pressure sewer trunks should terminate in manholes using the following construction procedures:

1. The discharge should be to the bottom of the manhole, in line with the flow if possible.
2. Where piping is installed to bring the discharge to the bottom of the manhole, it should be adequately braced to prevent movement, and vented on the top. Access should be provided to the force main for cleaning purposes.

## **C.6 Small Diameter Solids Carrying Sewers: Low-Pressure Grinder Pump (minimum 2" diameter) and Vacuum (minimum 3" diameter) Sewers**

---

### Construction Considerations for Grinder Pump and Vacuum Sewers

---

A sand bed, or other suitable bedding material, should be prepared at least 4 inches deep but not less than 1 pipe diameter to provide proper support for the sewer pipe. Bedding should be smooth and compacted prior to pipe installation.

The excavation should be backfilled to a depth of 18" above the pipe with sand, or other suitable bedding material. Bedding material should contain no rock greater than 1" in diameter. Native material may be used for the remainder of the backfill.

---

### Materials

---

Many types of pipe may be used for pressure sewers. The main factors to consider, in selecting the type of material used are:

- Corrosion resistance
- Ability to withstand pressures
- Durability
- Pipe wall smoothness (i.e. high Hazen-Williams coefficient)

Maximum benefit can usually be achieved with non-metallic materials such as polyethylene, fiberglass-reinforced plastic, and PVC. ASTM D2241 is the standard for PVC pressure pipe.

### **C.6.a Grinder Pump (Low-Pressure) Sewers**

Grinder pump systems macerate raw sewage and pump the material, under pressure, through small-diameter pipes to treatment components.

---

## Design Factors

---

Grinder pump sewer systems should be laid out in a branched or tree configuration to avoid flow splitting at branches. The required pipe size should be determined on the basis of three principal criteria

- Adequate velocities to assure scouring
- Sufficient pipe diameter to handle the required flow rate
- Minimal head loss

Design should be for peak sewage flow rates and negligible infiltration. A velocity of two to five feet per second (2 to 5 fps) should be achieved at least once and preferably several times per day based on design flows. Additionally:

- All wastewater and gray water sources should be served, including collecting sewage from sources within basements.
- Watertight low -pressure sewer pump vaults are highly recommended.
- Duplex pumps, 24-hour storage volume, emergency generator with automatic cutover during power loss, or a solenoid shutoff valve for the water supply line with manual override should be considered to prevent sewage backups due to pump or power failure.
- Minimum 1.25" building service laterals are recommended.
- Isolation valves and redundant check valve at each building connection are recommended.
- Minimum 2" pipe diameter for force mains is recommended.
- Tracer tape/wire should be installed with all force mains.
- Isolation valves should be placed at intersections.
- Minimum velocity of 2 feet/second is recommended.
- Minimum Hazen-Williams surface roughness coefficient (C) of 120 is recommended.
- Flushing connections for cleanout of the sewer are recommended.
- Air release valves should be installed at high points.

---

## Grinder Pump System Arrangement

---

All pressure sewer pipes should be installed at a depth sufficient to protect against freezing and mechanical damage.

Consider the necessity for providing automatic air release valves at inflection points where the liquid flow

velocity is insufficient to purge air bubbles in the pipeline. Pressure and/or flow control valves should be installed at the end of all critical surge pipe runs to maintain a full pipe system and eliminate pump station flooding or plant washout.

---

### Grinder Pump System Pressures

---

Operating pressures in general should be in the range of 40 to 60 psi. Provisions should be made in both the system and grinder pumps to protect against creation of any long-term high-pressure situations.

---

### Service Connections

---

Building service connection laterals from individual grinder pumps to collectors should be a minimum of 1-1/4 inch PVC or HDPE pipe, and include a full ported valve (such as a corporation stop or “u” valve) located in the service line to isolate the pump from the main. Check valves specifically suited to wastewater service should be provided at or near the pump and at a convenient location in the pressure service line before it enters the main.

---

### Cleanouts and Fittings

---

Pressure systems should have cleanouts at intervals of 500 to 1,000 feet of straight pipe runs (over 500 feet only where known O&M procedures can effectively clear the lines), at major changes of direction, where one collector main joins another main, and at terminal ends of pressure mains. Access for cleaning should be provided at the upstream end of each main branch. Cleanouts should be located and configured so that one can clean in either direction.

Cleanouts should include an isolating valve, and a capped sanitary T or sanitary Y fitting located on each side of the isolating valve, pointed both upstream and downstream for access during maintenance procedures. All appurtenances and fittings should be compatible with the piping system and should be full bore, with smooth interior surfaces to eliminate obstructions and keep friction loss to a minimum.

---

## Grinder Pump Equipment

---

The pumping equipment should be appropriately designed for wastewater service, and be manufactured of corrosion-resistant materials. In addition it should meet all applicable safety, fire, and health requirements for its intended use in or near residential buildings.

Proper system design and installation should assure each grinder pump will adequately discharge into the piping system during all normal flow situations, including peak design flow. During peak design flows, combined head losses (static, friction, and miscellaneous) should be maintained below the recommended operating head of any pump unit on the flow path.

Pumps should have a head capability high enough to operate efficiently over the entire range of conditions anticipated in the system. The head capacity design point should not be more than 85 percent of the maximum attainable pressure by the pump.

Pump units should be capable of operating under temporary loads above the normal recommended system design operating pressure without a serious reduction of flow or damage to the motor. The pump should be of flooded suction design to assure it will be positively primed. The pressure sewer system should contain integral protection against back siphonage.

Outside installations are preferable and should be located at least ten feet from the building in an area readily accessible to service personnel. Outside installations should be provided with access from the surface, suitably graded to prevent entrance of surface water and equipped with a vandal-proof and child-proof cover for safety. Inside installations should be examined for freedom from noise, odors, and electrical hazards.

Electrical portions of non-submersible grinder/macerator pumps should be protected from water. This may require a motor “breather” be run from the interior of the motor and control compartment to a protected location higher than the maximum anticipated water or snow level. The wiring compartment should be tamper proof and either water proof or contain waterproof wiring connections. Grinder pump equipment must comply with the National Electrical Code and applicable local electrical inspection requirements.

If installed inside a building, grinder pumps should operate at an acceptable noise level. Generally, this should be no louder than other motor-operated devices normally found in homes (furnace blowers, sump pumps, etc.).



---

## Grinder Pump Types

---

Both stable-curve centrifugal and progressing cavity semi-positive displacement pumps may be used in pressure sewer systems.

The stable-curve centrifugal pump, with maximum head at no flow, may be considered for its ability to compensate with reduced or zero delivery against excessive high pressure, and its ability to deliver at a high rate during low-flow situations, thus enhancing scouring during low-flow periods.

The progressing cavity semi-positive displacement pump may be considered for its relatively constant rate of delivery. The semi-positive displacement pump has no significant increase in delivery against low-flow conditions.

---

## Grinder/Macerator

---

Grinding pump equipment should include an integral grinder capable of handling any reasonable quantity of foreign objects which normally find their way into the building sewer. The grinder should be able to macerate foreign objects without jamming, stalling, or overloading the pump, or creating undue noise. The particle size produced by the grinder should be small enough to insure processed solids will not clog the grinder, pump, or any part of the discharging pipe system. The grinder should provide a positive flow of solids into the grinding zone. Open shafts should not be exposed in raw waste passageways because it will cause cloth, string, etc. to become wrapped around the blades or shaft.

---

## Grinder Pump Tank

---

The pump tank should be made of corrosion-resistant materials, suitable for contact with sewage and direct burial below grade without deterioration over the projected lifetime.

The pump tank also should be furnished with integral level controls which reliably turn the pump on and off at appropriate and predictable levels. The level control and high-level alarm should be as trouble free as possible, with little care required for proper calibration. Float, pressure, or probe type switches are acceptable. An alarm unit with visible and audible alarms should be provided on a separate electrical circuit or a self contained power supply to indicate pump failure.

In addition, the tank should have a 50 gallon minimum capacity and be able to accommodate normal peak flows. The volume between the on and off levels in the tank should be based on a compromise between excessive unit operation and efficient removal of raw sewage. All connections to the tank from the building sewer should be water tight. In areas in which the groundwater table is high, tanks should be securely anchored to avoid floating.

The geometry of the tank bottom, and pump suction currents generated when the grinder pump is in operation, should be adequate to scour solids from the bottom of the tank so there is no significant long-term accumulation of settleable solids on the tank bottom.

The tank should be vented so air space above the wastewater is always at atmospheric pressure. Separate venting may be necessary, but normally the influent piping connected to the building drain will provide adequate venting. If the grinder pump is downstream of the building trap, separate venting will be necessary.

### **C.6.b Vacuum Sewers**

Vacuum sewers are small diameter sewer systems that operate from a central pumping station that uses negative pressure to draw sewage from multiple locations. Typically a vacuum sewer system is used for small communities of 75 to 500 customers.<sup>36</sup>

---

#### Design Factors

---

Design should be for an operating vacuum range of 15 to 22 inches of mercury at mean sea level. Adjustments should be made for the altitude of the site.

Solvent-welded or vacuum suitable bell and spigot joints should be used on all plastic piping. Double O-ring slip joints should be considered to provide for temperature stresses. Solvent-welded pipe should be checked for temperature expansion allowance before covering. Bituminous fiber pipe (Orangeburg) should not be used.

Gravity sections of vacuum sewer systems should have a minimum slope of 0.20 percent regardless of pipe size. Grease interceptors may be necessary to prevent system malfunctions. Also, to reduce potential for

---

<sup>36</sup> *WEF's Alternative Sewer Systems*, MOP FD-12, 2008

sewer clogging, it is recommended that two 45-degree bends be used in lieu of 90-degree bends, or if not possible use long sweep 90 degree bends.

Isolation valves should be provided at every branch connection and at intervals no greater than 2,000 feet on main lines. Isolation valves should also be provided between the vacuum collection tank, vacuum pump(s), influent line, and raw sewage discharge pumps. Resilient wedge gate valves or plug valves should be used to form a positive pressure seal. Gauge taps should be installed downstream from each isolation valve to enable trouble shooting of the system vacuum.

Air vents should be located adjacent to the building and be protected from freezing, snow, and flooding.

---

#### Vacuum Valve Pits

---

Vacuum valve pits should be designed to prevent entrance of water, although vacuum valves should be capable of operating when submerged under water or ice conditions. Electronically controlled vacuum valves should be avoided. A pneumatic/mechanical controller and sensor are recommended for vacuum valve operation. A 24-hour repair time for either replacement or repair is strongly recommended.

Refer to *WEF's Alternative Sewer Systems*, MOP FD-12, 2008 for further details regarding recommended vacuum valve and valve pit design and construction.

---

#### Central Collection Station

---

A vacuum pump should be designed to cycle not more than six times in one hour during average daily flow conditions. A minimum running time of one minute per cycle is recommended. A standby pump should be provided to handle peak loadings, as well as an emergency backup generator in case of power outage.

### **C.7 Water Supply Line and Sewer Separation**

For new construction, sewers must be laid at least 10 feet horizontally from any existing or proposed water supply line, measured edge to edge.<sup>37</sup>

---

<sup>37</sup> NYSDOH Regulation Subpart 5-1 Appendix 5-A

For replacement, retrofitting, or where local conditions prevent a lateral separation of 10 feet, a sewer may be laid closer than 10 feet from a water main if:

- a) It is in a separate trench with an 18-inch vertical separation (water main invert 18 inches above the crown of the sewer)

OR

- b) It is in the same trench with the water main located at one side on a bench of undisturbed earth (water main invert 18 inches above the crown of the sewer).

A sewer line and water main may cross if a minimum vertical distance of 18 inches between the outside of each line is maintained. This is the case whether the water main is above or below the sewer line, though preference is given to the water main being located above. At these crossings, the joints of the sewer line must be equidistant from the water main, and should be a minimum of 10 feet from it. When the sewer line is above the water main, the sewer line should be adequately supported to maintain line and grade.

Whenever sewers must cross a water main, and a minimum 18 inch vertical separation between the outside of the water main and sewer cannot be met, the section of the sewer line crossing the water line must be constructed of slip-on or mechanical joint pressure-rated water works grade 150 psi pipe meeting AWWA standards. This sewer line section must be pressure tested to assure watertightness.<sup>38</sup>

There must be no physical connection between a public or private potable water supply system and a sewer, or appurtenance thereto, which would render possible the passage of any sewage or polluted water into the potable water supply.<sup>39</sup> No water pipe may pass through or come in contact with any part of a sewer manhole.

## **C.8 Creek Crossings**

Permits may be required for crossing or working adjacent to certain streams, as outlined in Section A. In the event that no stream crossing permit is required, the crossing should be made in such a manner as to minimize disturbance of the streambed.

---

<sup>38</sup> NYSDOH Regulation Subpart 5-1 Appendix 5-A

<sup>39</sup> NYSDOH Regulation Subpart 5-1 Appendix 5-A

## **C.9 Instruction Manuals**

The equipment for new conventional pump stations, STEG and STEP pump chambers, grinder pump or vacuum sewer system pump stations, etc. should be furnished with complete detailed wiring diagrams, suggested piping installations, and detailed instructions for use by the contractor at the time of installation. A complete instruction manual should be provided to the owner of the system. Manufacturer's requirements, and any conflicts with these design standards, should be discussed at the pre-application conference (Section A.2).

## **D. Preliminary and Primary Treatment, Flow Measurement and Appurtenances**

### **D.1 Introduction**

Wastewater pre-treatment varies with site conditions and the proposed type of final treatment and discharge system. Pre-treatment components remove contaminants from the wastewater to provide an effluent that can be more effectively handled by downstream components like soil-based treatment and dispersal systems. Combinations of various pretreatment methods and/or multiple pre-treatment units may be needed to precede the treatment methods listed in Sections E, F and G. Pre-treatment units should remove most settleable solids and floatable fats, oils and greases (FOG).

When designed in accordance with the criteria presented, pretreatment units like septic tanks and grease interceptors, flow measurement, flow control and septic tank effluent screening devices allow the biological and physical-chemical treatment processes discussed in Sections E, F and G to operate more efficiently and increase their operating life.

### **D.2 Preliminary Treatment Devices**

To protect pumps and other equipment, coarse screens, trash racks, or coarse bar racks should be provided where sewers deliver wastewater to a treatment facility. Comminutors may be used instead of screening devices to protect equipment where stringy substance accumulation on downstream equipment could be a substantial problem. Design criteria for these devices are presented in the *Ten States Standards*, and *TR-16*.

Wastewater from a building sewer or a small-diameter sewer pipe flowing into a septic tank does not require coarse screens or trash racks because small diameter pipe does not convey appreciable amounts of trash into the septic tank. A trash tank may be used prior to an aerobic treatment unit or other enhanced treatment units (ETU) or may be an integral part of the unit.

### **D.3 Flow Equalization**

Flow equalization should be provided for all treatment systems with significant delivery periods, with the exception of septic tanks, single-pass sand filters, and lagoons. The design of flow equalization units should evaluate minimum and peak design flows when determining the equalization volume needed. Distribution of effluent from an equalization tank to a subsurface soil treatment system should use timed

dosing.

Flow equalization can be provided by the storage volume in a:

- Dedicated equalization (surge) tank
- Siphon or a pump/dosing tank
- Trash tank (prior to or integral to the design and manufacture of an ETU). Depending on the facility, site or receiving water and the size of the integral trash tank, the reviewing engineer may require a septic tank prior to the ETU.

The minimum storage volume of a flow equalization unit should be sized to handle the flow during the significant delivery period of any given day.

#### **D.4 Flow Measurement**

Flow measurement for wastewater treatment systems should be considered for efficient system operation and maintenance and provide improved performance of daily unit processes. Therefore, some means of wastewater flow measurement or estimation should be provided for all wastewater treatment facilities as follows:

- All wastewater treatment systems with a design flow over 30,000 gpd are recommended to install a flow measuring device (i.e., weir, flume, etc.) with the ability to record and totalize (with a meter) the daily discharged flow.
- For smaller plants (more than 10,000 and less than 30,000 gpd), a flow measuring device (i.e., weir, flume, etc.) is recommended to obtain at least a manual instantaneous effluent daily flow with the ability to install a continuous recording device, if necessary. A totalizing water meter may also be acceptable for this size plant.
- For private, commercial and institutional (PCI) systems with design flows between 1,000 gpd and 10,000 gpd, flow measurement is strongly recommended. For all other installations, some means of measuring water use or wastewater generation is recommended. Systems with pressure distribution or some other dosing device should employ dose counters or time-lapse meters.

Time-lapse meters or dose counters may be used where the waste is pumped. Where applicable, the wastewater flow may be estimated by use of a totalizing water meter on the water supply servicing establishment(s) tributary to the OWTS.

## **D.5 Fats, Oils and Grease (FOG) Removal and Grease Interceptors**

FOG can cause sewer system blockage as well as treatment unit failure. All facilities that have potential to discharge FOG are required to install a FOG removal device, in accordance with state law. Nonpetroleum FOG treatment, intercepting and removal devices include:

- Hydro-mechanical (Type I) grease interceptors, sometimes combined with:
  - Grease removal devices (both manual and automatic GRDs) or
  - FOG disposal systems, and
- Gravity (Type II) grease interceptors (tanks).

---

### Codes and Jurisdiction

---

Specification of non-petroleum FOG-laden plumbing fixtures and grease interceptors (of all kinds) for use on the premises of buildings is under the jurisdiction of the Department of State, Codes Division and the NYS Uniform Fire Prevention and Uniform Codes. Type I grease interceptors are required by the PCNYS, and are installed as close to the FOG source as practical. Code enforcement officials enforce these codes, which are based on a modification of the International Plumbing Code (IPC). A Type II grease interceptor external to the food service area may also be required due to local conditions or by NYSDEC or NYSDOH, where on-site wastewater treatment systems are used.

Local health units review plans and specifications for Type II grease interceptors according to the Public Health Law, Part 14 “Food Service Establishments” and the 1984 MOU with NYSDEC, using these Design Standards.

---

### Sewer Use Ordinances

---

For all grease interceptors discharging to sewers, the local sewer district or authority should be contacted for their requirements for Type II grease interceptors. NYSDEC defers to PCNYS and municipal sewer use ordinances for all FOG control devices discharging to municipal sewers. This manual provides design standards for Type II grease interceptor tanks discharging to an OWTS.



Waste fats, oils and greases (FOG) are generated in various PCI facilities, including restaurants, bakeries, various catering halls, hospitals, nursing homes, schools, correctional facilities, churches and grocery stores. FOG-laden fixtures of kitchen/food service areas of the above facilities should be served by a separate sewer line and plumbed to a Type II grease interceptor upstream from the septic/aerobic tank (see Figure D-1).

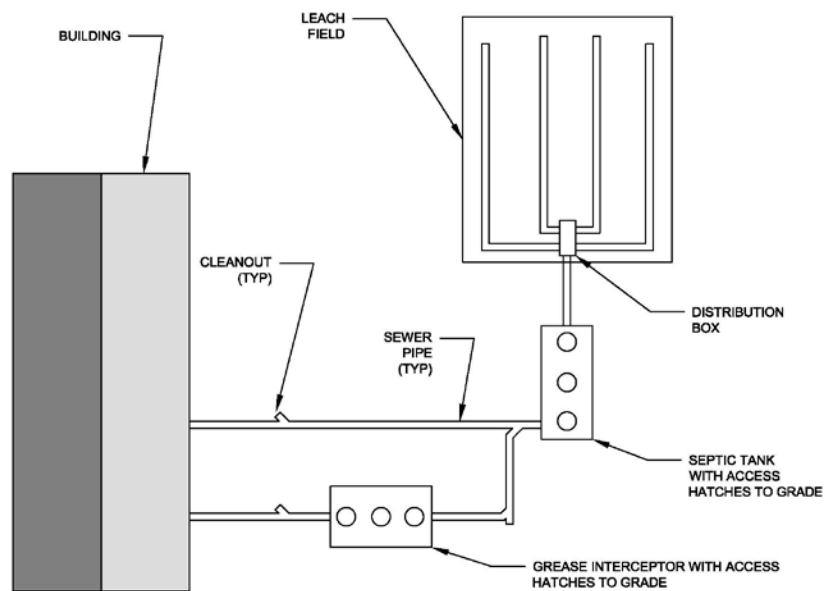

**Figure D-1 Type II Grease Interceptor and Septic Tank Building Sewers Discharging to Soil-Based Treatment Systems (STS)**

The grease interceptor should be a gravity grease interceptor (Type II), and a certified tank, unless a Type I grease interceptor installed per the PCNYS and its associated O&M plan is deemed adequate locally.

Several factors can affect the performance of a gravity grease interceptor: wastewater temperature, solids concentrations, retention time, and maintenance practices. Facilities such as grocery stores may have multiple sources of FOG-laden wastewater (bakery, meat department, deli counter, take-out counter, hot

food buffet and in-house eating area). It is incumbent on the design engineer to provide effective FOG removal systems for any and all FOG sources within the facility.

The most cost effective way to minimize the negative impact of FOG on on-site wastewater treatment components is to implement a FOG Best Management Practices plan (refer to O&M subsection). Ground garbage, discharge from ice machines, wastewater from on-site linen service, and black water should NOT be directed to the grease removal/recovery system but directly to the septic tank.

---

#### Hydro-mechanical (Type I) Grease Interceptors

---

Where the FOG-generating fixtures upstream of a proposed Type I grease interceptor can be identified and sized, the hydro-mechanical interceptor (1) must be sized according to the PCNYS, (2) must be plumbed into the dedicated FOG piping. Annually, or more frequently, maintenance for the Type I grease interceptor may be required locally.

---

#### Gravity (Type II) Grease Interceptors

---

Type II grease interceptors are most often necessary where an OWTS is used to protect the soil-based treatment and dispersal system. For other treatment technologies, grease removal is recommended to protect the efficacy of the treatment train. FOG-laden wastewater should flow to the grease interceptor by gravity. The underground interceptor tank should be placed as shallow as possible to minimize the effect of groundwater pressure on the tank system. The location should be chosen to insure easy access for maintenance, and be installed near the building so grease does not solidify before reaching the grease interceptor. Maintenance includes periodic pump out of the grease interceptor by a pumper truck.

---

#### Capacity of Gravity Grease Interceptors

---

For FOG-laden discharges to nonresidential, single lot Onsite Wastewater Treatment Systems, or small-scale collection sewers discharging to privately, commercially, or institutionally owned treatment systems, Type II grease interceptors should be sized using Table D-1 or actual measurements of the FOG-laden wastewater flow.

For buildings with an unknown equipment layout but known discharge pipe size, Table D-1 is recommended. Based on standard engineering calculations using half full pipe gravity flow, with a ¼" pitch per foot (2 percent slope) and a Manning's n of 0.012, the maximum flow rate and the interceptor

volume is given in nominal increments. The Table D-1 method assumes the design flow would be conveyed through a half-full pipe with gravity flow. This method is recommended for newly designed facilities with known FOG-laden sewer outlet pipe size, but unknown equipment layout.

**Table D-1 Gravity (Type II) Grease Interceptor Sizing Based on Grease-Laden Building Sewer Pipe Flowing Half Full**

<b>Grease Interceptor Inlet Pipe Size (inches)</b>	<b>Flow (GPM)</b>	<b>Nominal Interceptor Volume (Gallons) (based on 30-minute settling time)</b>
2"	10	500
3"	30	1,000
4"	65	2,000
5"	115	3,500
6"	188	6,000

For buildings with known equipment layout, it is recommended the peak waste flow be measured for the FOG-laden sewer outlet. The grease interceptor is then sized on a 30-minute retention time, so the peak flow is multiplied by 30 minutes, giving an overall volume for the Type II grease interceptor.

The use of bigger tanks is not always better. If gravity grease interceptors (Type II) are sized by both flow and expected retained solids, they will be larger, ostensibly needing less frequent cleaning. However, actual field experience has now shown that oversizing, along with poor venting and infrequent pumpouts can result in the generation of hydrogen sulfide gas and sulfuric acid, destroying the interceptor and drainage system. Sound engineering judgment should be applied to each system design, followed by timely and adequate inspections and pumpouts.

---

Compartments of Type II Grease Interceptors

---

New gravity grease interceptor (Type II) designs should incorporate two or more compartments (Figure D-2) or two single tanks in series, with a minimum effective capacity of 500 gallons. Multiple grease interceptors, in series, are recommended if the required effective capacity is greater than 2,000 gallons.

The inlet compartment or tank should have a capacity of 65 to 75 percent of the total capacity. For a two compartment tank, the dividing wall should extend from the tank bottom to six inches above the flow line and should not extend to the roof interior without adequate venting. The transfer port or horizontal slot between compartments should be located in the middle 25 percent of the distance between the tank floor

and the waterline, and be a minimum area of 50 square inches.

---

## Inlet and Outlet

---

Inlet and outlet pipes should be connected to the tank with watertight sealed, flexible joints. These connections should conform to the American Society for Testing and Materials' "Standard Specification for Resilient Connectors between Reinforced Concrete On-site Wastewater Tanks and Pipes – C1644 (latest edition)" to accommodate tank and/or pipe movement. The inlet and outlet pipes should be constructed of PVC pipe SDR 35 minimum or equivalent. When any portion of these pipes will be subject to vehicular traffic, they should be constructed of Schedule 40 PVC or equivalent.

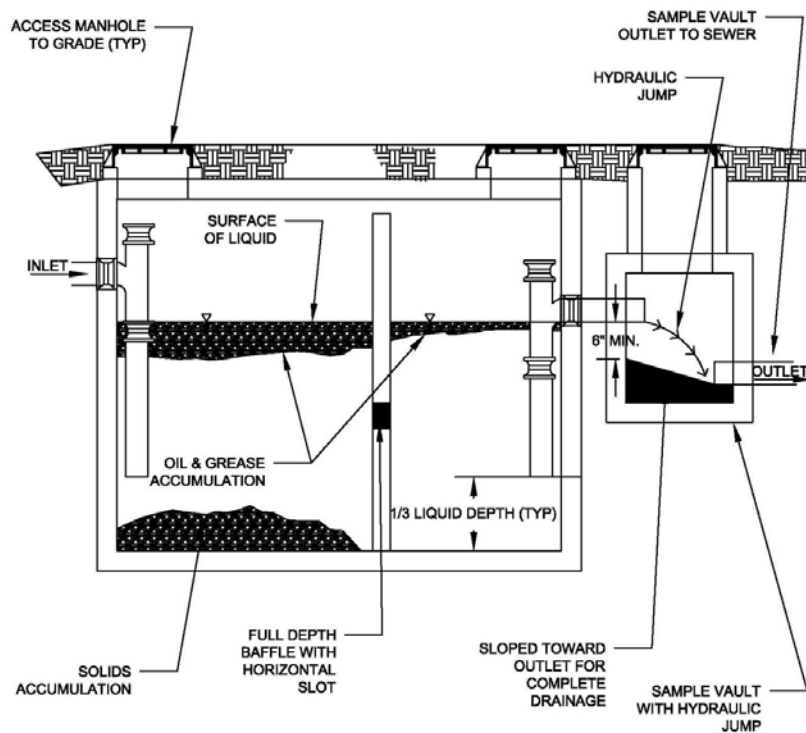

**Figure D-2 Double Compartment (Type II) Grease Interceptor**

Gravity grease interceptor tanks should have an inlet and outlet sanitary tee. Sanitary tees should be installed vertically on the inlet and outlet pipes. Sanitary tees should be the same size as the inlet and outlet piping, but not less than 4" in diameter (6" is recommended for the outlet, to reduce the exit velocity of the tank). The tees should be minimum SDR 35 PVC or equivalent. A pipe nipple with an open top should be installed in the top of the tees and should terminate 6" above the waterline.

The inlet pipe invert elevation should be 2" to 4" above the elevation of the outlet pipe invert; the same

elevation drop should be used for each tank in a series. The inlet pipe vertical drop should extend down to the mid-depth of the tank. Inlet pipe designs by the Water Environment Research Foundation (WERF) minimize short circuiting and maximize grease retention.

The outlet tee should have a vertical pipe rise 6" above the flow line and pipe drop extending down to typically the bottom third of the tank, but no closer than 12" from the tank floor to avoid creating suction, turbulence or short circuiting. An effluent filter, specifically designed for grease interceptor applications, is recommended on the outlet of a new grease interceptor in lieu of a sanitary tee. The outlet tee or filter should be located no farther than 6" from the outlet end wall. Tees or filters should be located directly under access manholes.

- Effluent filters/screens should be sized upon peak hydraulic loading and rated capacity of the device per the manufacturer's specification. Effluent filters can be placed in a separate tank/chamber/vault. If this is done, an outlet tee should also be installed on the grease interceptor tank.
- A high-level alarm system should be provided on a tank that includes an effluent filtering system.

Type II gravity grease interceptor effluent should be discharged to a pipe which discharges to a septic tank or other treatment unit to minimize turbulence in the receiving unit due to multiple input streams.

---

#### Effluent Sampling

---

A sample port/vault should be installed just downstream of the (final) grease trap to facilitate sampling of the discharge (See Figure D-2). Sampling may be required by SPDES Permit conditions, a sewer use ordinance, or to indicate proper operation or need for maintenance.

---

#### Access Openings

---

Gravity grease interceptor tanks should have an access opening/manhole with a 20-inch minimum dimension over the influent tee and effluent tee or filter; a 24-inch opening/manhole is recommended. The access opening should be of sufficient size to allow for tank pumping and removal of the filters. All access openings/manholes should be extended to finished grade. Where risers are required, they should be watertight. Tanks longer than 15 feet should have an additional manhole located just upstream of the

dividing wall. Access covers should be of sufficient weight (59-pound minimum) or mechanically fastened, or provided with a lock system to prevent unauthorized entry. The cover and frame assembly should be watertight (gasketed).

Optimum dimension of the grease interceptor should be such that the depth is equal to the width or the diameter and the length is greater than the width. Cylindrical tanks should be positioned with the longest dimension oriented horizontally. The liquid depth of the tank should be between 36" to 72". The effective volume should be based on a maximum 60" depth with any additional depth used for sludge storage.

Designs for multiple interceptor tanks in series should include the following:

- The tanks should be vented for positive air/gas displacement.
- The outlet tee on the first tank should be at least 6" in diameter and should extend to at least (1/3) of the depth, but no less than 12", above the tank floor.
- The connector pipe between tanks should be at least 6" in diameter and sloped at 1/8-inch per foot.
- The inlet tee on the second tank should be at least 6" in diameter and should extend to the mid-depth of the tank.
- The outlet on the second tank should be at least 6" in diameter. The outlet pipe should extend typically to the bottom third of the tank, but no closer than 12" from the tank floor to avoid creating suction, turbulence or short circuiting. An effluent filter is recommended (see Section D.7 Effluent Filter below).

---

## Venting

---

The grease interceptor must be vented in accordance with requirements of the manufacturer and the PCNYS (typically back through the inlet plumbing and to a roof vent). Proper venting prevents buildup of gases in the grease interceptor. Venting of hydrogen sulfide gas will minimize formation of sulfuric acid and resulting disintegration of concrete and corrosion of metal parts, e.g., re-bar.

Grease interceptors should be watertight. Components of the system should be constructed of durable materials not subject to corrosion, decay, frost damage, deformation or cracking. Typically, gravity grease interceptor tanks are constructed of pre-cast or poured-in-place concrete. Poured-in-place tanks should be designed and certified by a licensed professional engineer. Protection against sulfuric acid damage above the waterline may be provided in varying degrees determined by local conditions, and may include properly venting the tank, and coating the interior of the concrete tank or specifying medium and high-strength sulfate-resistant concrete mixes. Precast concrete grease interceptors may be coated with a bituminous coating inside and out to ensure watertightness and prevent deterioration when deemed necessary by the design engineer or the manufacturer due to specific site conditions.

For concrete tanks, refer to the National Precast Concrete Association, or the Precast Concrete Association of New York (PCANY). For FRP or HDPE tanks, refer to IAPMO (International Association of Plumbing and Mechanical Officials)/ANSI (American National Standards Institute) Z1001 *Prefabricated Gravity Grease Interceptors*, or ASTM F2649 (latest version) *Standard Specification for Corrugated HDPE Grease Interceptor Tanks*.

All grease interceptor tanks should be certified tanks. When a Type II gravity grease interceptor tank is installed under a driveway or parking lot, or where there is heavily saturated soil or an area subject to heavy loading, the tank should be designed to withstand an H-20 wheel load.

Pre-cast concrete grease interceptor tanks should conform to the American Society for Testing and Materials “Standard Specification for Precast Concrete Grease Interceptor Tanks C1613,” and be a certified tank (i.e., a tank that has been certified under the PCANY Certification Program). The joints for horizontal seam and vertical seam concrete tanks should conform to the American Society for Testing and Materials “Standard Specification for Joints for Concrete Pipe, Manholes, and Precast Box Sections Using Preformed Flexible Joint Sealants C990 (latest edition).”

Poured-in-place Type II grease interceptors should meet the specifications for cast in place concrete given in ACI318 Building Code Requirements for Structural Concrete (also see ASTM C1227 [latest version]) and be designed and inspected by a licensed professional engineer.

High-density polyethylene (HDPE) and fiberglass-reinforced plastic (FRP) tanks should be factory assembled, with any proposed baffles in place. Care should be taken during installation and backfilling to avoid damaging the walls. After backfilling, the tanks should be inspected, and, if any damage is present, the tank should be repaired or replaced. When these tanks are installed in areas of high ground water levels, flotation collars or other buoyancy control method as recommended by the manufacturer should be used to prevent flotation when the tank is pumped.

Resistance to the hydrostatic and hydrodynamic forces of groundwater, backfill, tank filling and tank evacuation is accounted for in the structural design of concrete tanks. High density polyethylene and fiberglass-reinforced plastic (FRP) tank manufacturers require their installation procedures be strictly followed to prevent tank damage at installation and to account for high groundwater conditions and tank filling and pumpouts. For fiber-reinforced polyester (FRP) tank standards, see UL Standard 1316 *Glass Fiber Reinforced Plastic Underground Storage Tanks for Petroleum Products, Alcohols, and Alcohol-Gasoline Mixtures*, or ANSI/AWWA D120-02 *Thermosetting Fiberglass Reinforced Plastic Tanks*.

Metal tanks are prohibited for new installations unless prior written approval is granted by the Reviewing Engineer. They will be considered only if they are constructed and coated in accordance with the provisions of the Underwriters Laboratory Standard UL-70.

---

## Installation

---

Care should be taken during placement of bedding, installation and backfilling to prevent damage to the tank system. The grease interceptor manufacturer's installation instructions should be strictly followed. Tanks should not bear on large boulders or rock ledges. The tank should be placed on a minimum 4" level layer of sand or pea gravel. Underlying soils and bedding materials should be adequately compacted to eliminate later settlement. When a tank is installed in an area where high groundwater levels may be present, an evaluation should be made to determine whether flotation collars or other buoyancy control methods as recommended by the manufacturer are necessary to prevent flotation.

All Type II gravity grease interceptor tanks and related appurtenances (inlet and outlet pipe seals, risers, covers, etc.) should be (vacuum or water-pressure) tested in accordance with CIDWT 2009 *Installation of Wastewater Treatment Systems - Appendix G.- Septic Tank Watertightness Testing* and certified to be watertight prior to backfilling (see ASTM Standards C1613 for grease interceptors).



---

## Backfill

---

There should be no pipe connections such as joints, splices or fittings within the “over dig” portion of excavation surrounding the grease interceptor tank. Backfill should be placed and compacted in uniform layers less than 24" thick and should be free of large stones (> 3" in diameter) or other debris. After backfilling, the tank should be inspected, and if any damage is present, the tank should be repaired or replaced. Surface water should be directed away from tank openings.

---

## Operation and Maintenance

---

Grease interceptor additives should not be used, as some products claiming to “clean” grease interceptors contain compounds which provide temporary relief, but may also result in permanent damage to the disposal field and cause premature clogging.

FOG is not a stable compound to be stored for a prolonged period in a grease interceptor due to the formation of hydrogen sulfide as a result of anaerobic conditions. The Plumbing and Drainage Institute recommends the grease interceptor be inspected monthly, pumped out as necessary, and a log kept. Scum and sludge should be measured in the first compartment of a two-compartment tank or in the first tank of a multiple-tank system. Tanks should be pumped when the bottom of the scum layer is within 3" of the bottom of the outlet baffle or tee, or when the sludge level is within 8" of the outlet device. This is to ensure the minimum hydraulic retention time and required available hydraulic volume is maintained to effectively intercept and retain FOG discharged to the sewer system. The tank should be refilled with water to counter buoyancy in high ground water installations (if possible). The tank should not be disinfected, washed, or scrubbed. Proper venting should be present to minimize sulfuric acid damage of concrete tanks.

Interior Type I hydro-mechanical grease interceptors should be inspected frequently, based on usage and manufacturer’s instructions. Pumped-out grease interceptors often contain toxic gases. Only qualified personnel should attempt to enter or repair a grease interceptor.

---

## FOG Best Management Practices for Commercial/Institutional Facilities

---

To minimize FOG from entering the grease interceptor, the following practices should be employed:

- Train kitchen staff in FOG-handling practices.

- Hang FOG-handling posters in the kitchen.
- Use strainer baskets in sinks to catch food waste.
- Food waste should be disposed of in the trash, not in the sanitary sewer system.
- Provide ample paper towel dispensers for dry wiping grease from spills, pots, frying and grilling equipment.
- Identify grease recycling containers (these large buckets of grease should only be recycled, never disposed of in the drain system).
- Contract with FOG haulers, recyclers and rendering companies to recycle grease.
- Direct all drains from FOG-producing sources to properly sized grease interceptors.
- Avoid food grinders. If grinders are approved, discharge them to a solids interceptor upstream of a grease interceptor.
- Have a copy of recommended grease interceptor cleaning procedures on-site.

## **D.6 Septic Tanks**

Septic tanks receive sewage from the building sewer, small-diameter collection sewer main, or from the grease interceptor clear zone. It is typically followed by a subsurface soil-based treatment system for groundwater discharges. A secondary or tertiary/enhanced treatment system is required prior to surface water discharge. Septic tanks should be placed as shallow as possible to minimize the effect of groundwater pressure on the tank system (see Installation subsection below). Such placement also enables the septic tank effluent to discharge by gravity flow to a subsurface aerobic soil-based treatment system.

---

### Design and Sizing

---

Table D-2 shows the calculations that should be used to determine minimum effective tank capacity for commercial/institutional and multi-home wastewaters. Tanks larger than this minimum will show enhanced performance. No tanks should have a capacity less than 1,000 gallons. For multi-home purposes, calculated flows should be based upon maximum occupancy of the homes. For commercial/institutional purposes the tank should be able to treat continuous wastewater flows for 8 to 16 hours per day, as well as expected peak loadings. The daily flow in Table D-2 is the treatment system's daily design flow developed in Section B.6.b. Anticipated sludge and scum accumulations should be considered when determining the required effective capacity to prevent an excessive rate of flow through the system.

**Table D-2 Septic Tank Sizing (effective volume) for Multi-Home Dwellings<sup>40</sup>, Private, Commercial, and Institutional Applications**

Daily Flow, Q (gpd)	Minimum Effective Tank Capacity (gal)
Under 5,000	1.5Q
5,000 to 15,000	3,750 + 0.75 Q
Greater than 15,000	Q

To prevent excessive rate of flow through the system, it may be necessary to increase tank size (effective volume) when a commercial or institutional facility has a significant delivery period. In that situation, Table D-2 is not used. As the significant delivery period gets shorter, tank volume should increase proportionately, providing flow equalization and a 24-hour detention time for the wastewater generated during that period. This increase in volume compensates for turbulence due to the high flow rate and minimizes scouring of septic tank sludge and scum and carryover of solids into the absorption system. For example, consider a facility that discharges 2,000 gallons over a 6-hour delivery period:

$$\text{i.e., } \frac{2,000 \text{ gal}}{6 \text{ hours}} = \frac{\text{volume of septic tank required (gals)}}{24 \text{ hours}}$$

Proportionately, the volume of septic tank required = 8,000 gallons. <sup>41</sup>

Garbage grinders are not recommended for facilities served by on-site wastewater treatment systems. Where garbage grinders are used or proposed, tank capacity should be increased by 1/3 to accommodate the increased volume of solids, and an effluent filter is recommended. For facilities (houses, motels, spas etc.) with high-flow plumbing fixture(s) such as in-room jacuzzis, septic tank capacity should be increased by each high-flow fixture's corresponding volume. Additional septic tank capacity should be considered for apartment-type buildings with multiple washing machines in a common laundry area.

---

<sup>40</sup> For one and two family homes with daily flows less than 1,000 gpd, refer to NYSDOH's *Wastewater Treatment Standards –Appendix 75-A*.

<sup>41</sup> *Environmental Engineering – 5<sup>th</sup> edition – Salvato, Nemerow and Agardy* (©2003 by John Wiley) p. 580

---

## Sewage Pumped to Septic Tanks

---

NYSDEC discourages the use of raw sewage pumping stations, or sewage ejector systems, when the discharge is directly to a septic tank. If such a pump system is used, the effective capacity of the septic tank should be calculated based on the pumping rate (gallons per minute). The ejector or pump station should discharge into the sanitary waste line prior to the septic tank. This will alleviate shock loads to the septic tank. Two septic tanks in series may be necessary, as agitation or mixing may occur in the first tank due to high pump rates. The second tank then provides a quiescent zone to promote solids separation.

---

## Shape and Dimensions

---

Optimum dimensions calls for a depth approximately equal to the width of a rectangular tank. The liquid depth of the tank should be between 36" to 72". The effective volume should be based on a maximum 60" depth with any additional depth used for sludge storage. Shallower tanks may be used if local codes allow or require.

Surface area of the liquid in the tank may range from 2.6 to 5.3 sq. ft. per 100 gallons of tank capacity. Tanks with greater surface area-to-depth ratio are preferred. The ratio of inside tank length to width at the liquid surface should be in the range of 2:1 to 4:1. Minimum inside tank length, from inlet to outlet, should be 6 feet. Tanks with greater length to width ratios are more effective in solids retention. Cylindrical tanks may also be used.

---

## Compartments

---

Septic tanks for new facilities should have two compartments (Figure D-3). Two single compartment septic tanks in series (Figure D-4) may be used in lieu of a two compartment tank. The inlet chamber or tank should have a capacity of approximately  $\frac{2}{3}$  of the total capacity. An appropriate sized effluent filter is also recommended. Septic tanks in parallel are strongly discouraged. For a two-compartment tank the dividing wall should extend from the tank bottom to 6" above the flow line. The wall should have a horizontal slot at mid-depth to allow the passage of liquid from the first compartment to the second. The slot should be at least 4" high with a minimum area of 50 square inches.

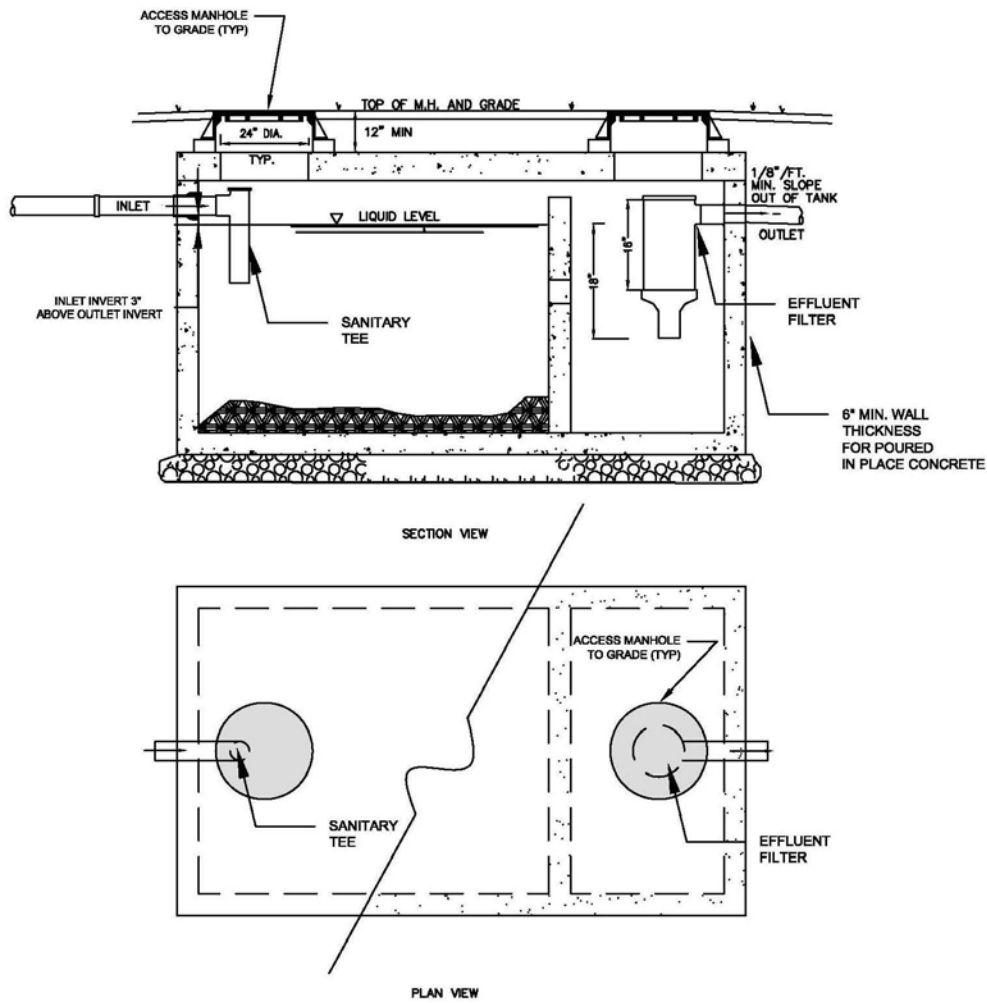

Figure D-3 Double Compartment Septic Tank

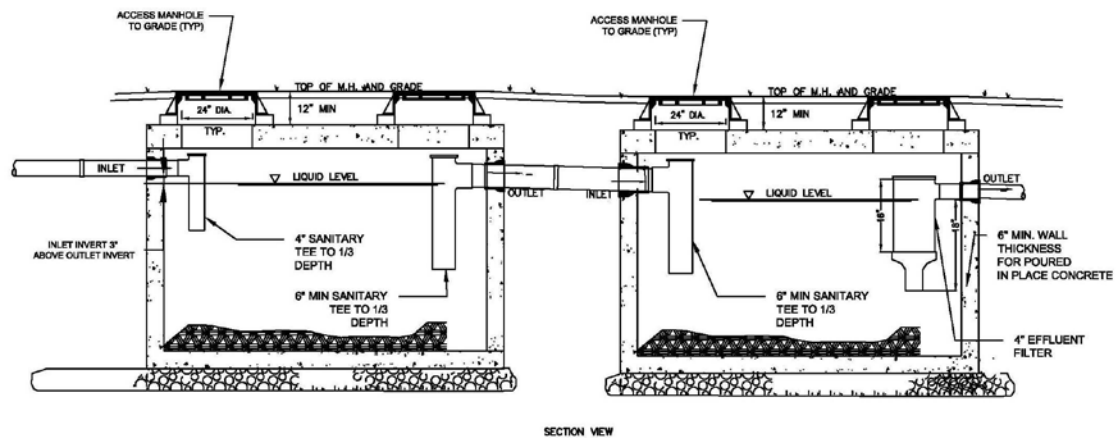

Figure D-4 Single-Compartment Septic Tanks in Series

---

## Two Tanks in Series (see Figure D-4)

---

Tanks plumbed in series may be used to provide the minimum effective tank capacity or as noted above for pumped raw wastewater. Designs for multiple septic tanks should include the following:

- No more than 2 septic tanks should be placed in series.
- The inlet tank should have a capacity of approximately 2/3) of the total capacity.
- The outlet tee on the first tank should be at least 6" in diameter and should extend down 1/3 of the liquid depth.
- The connector pipe between tanks should be at least 6" in diameter and sloped at 1/8-inch per foot (1 percent slope).
- The inlet tee on the second tank should be at least 6" in diameter and should extend down 1/3 of the liquid depth.
- The outlet on the second tank should be at least 4" in diameter and provided with an effluent screen or filter (6" is recommended to reduce the exit velocity of the tank).

---

## Construction and Materials for Septic Tanks

---

Septic tanks should be watertight. All tanks and components of the tank system should be constructed of durable materials resistant to corrosion, frost damage, deformation (cracking or buckling) due to settlement or soil pressures. Tanks may be constructed of properly cured, precast or poured-in-place concrete, high-density polyethylene (HDPE) or fiberglass-reinforced plastic (FRP).

All tanks should be able to withstand burial to 3' over the top of the tank without loss of volume or change in shape after being pumped completely empty under saturated soil conditions. Septic tanks of materials other than concrete should still meet the minimum structural design requirements of ASTM C1227 – latest revision. All septic tanks should be certified tanks. When a septic tank is installed under a driveway or parking lot, or in heavily saturated soil or other area subject to heavy loading, the tank should be designed to withstand an H-20 wheel load.

Precast concrete septic tanks should conform to ASTM C1227, and be certified (i.e., a tank that has been certified under the PCANY Certification Program is a certified tank). The joints for horizontal seam and vertical seam concrete tanks should conform to the ASTM “Standard Specification for Joints for Concrete Pipe, Manholes, and Precast Box Sections Using Preformed Flexible Joint Sealants C990 (latest edition)”. Precast concrete septic tanks may be coated with a bituminous coating inside and out to ensure

watertightness and prevent deterioration when deemed necessary by the design engineer or the manufacturer due to specific site conditions. Concrete septic tanks may also be constructed to ASTM Specification C150 Type II for moderately sulfate resisting cement, or by the addition of appropriate additives.

Poured-in-place septic tanks should meet the specifications for cast in place concrete given in ACI 318 Building Code Requirements for Structural Concrete (also see latest version of ASTM C1227). They also should be designed and inspected by a licensed professional engineer.

High-density polyethylene (HDPE) and fiberglass-reinforced plastic (FRP) tanks should be factory assembled, with any proposed baffles in place. Care should be taken during installation and backfilling to avoid damaging the walls. After backfilling, the tank should be inspected, and, if any damage is present, the tank should be repaired or replaced. When these tanks are installed in areas of high ground water levels, flotation collars or other buoyancy control methods as recommended by the manufacturer should be used to prevent flotation when the tank is pumped.

Resistance to the hydrostatic and hydrodynamic forces of groundwater, backfill, tank filling and tank evacuation is accounted for in the structural design of concrete tanks. High-density polyethylene and FRP tank manufacturers require their installation procedures be strictly followed to prevent tank damage at installation and to account for high groundwater conditions and tank filling and pumpouts.

Metal tanks are prohibited for new installations unless prior written approval is granted by the Reviewing Engineer. They will be considered only if constructed and coated in accordance with the provisions of the Underwriters Laboratory Standard UL-70.

---

#### Inlet and Outlet

---

All new septic tanks should have an inlet sanitary tee and an outlet effluent screen or filter (see Section D.7). Sanitary tees and effluent filters should be installed vertically on the inlet and outlet pipes, respectively. Tees and effluent filter connections should be the same size as inlet and outlet piping, but not less than 4" in diameter (larger outlets reduce the exit velocity of the tank). A pipe nipple with an open top should be installed in the top of the inlet tee and should terminate 6" below the roof of the tank. The inlet tee should rise 6" above the flow line and extend down to the middle 25 percent of the liquid level. Tees should be minimum SDR 35 PVC or equivalent.

There should be a 2 to 4-inch drop in elevation between inverts of the inlet and outlet of the tank (and of each tank in series). The outlet effluent filter should have a pipe drop extending to the middle 25 percent of the liquid level. Tees or filters should be located directly under access manholes. The outlet filter should be located no further than 6" from the outlet end wall. When effluent filters are being used, tank depth and flow rate should be considered, along with the manufacturer's recommendations for the model to be installed (see Section D.7).

There should be no connections such as joints, splices or fittings within the "over-dig" portion of the excavation surrounding the septic tank. Inlet and outlet pipes should be connected to the tank with a watertight, flexible joint/connector. For concrete tanks, specifications for flexible joint connections are in the *ASTM Standard Specification for Resilient Connectors between Reinforced Concrete On-site Wastewater Tanks and Pipes - C1644 (latest edition)*. The inlet and outlet pipes should be constructed of PVC pipe SDR 35 minimum or pipe of equivalent strength. When any portion of these pipes will be subject to vehicular traffic, they should be constructed of Schedule 40 PVC or equivalent.

---

#### Access Openings

---

Septic tanks should have an access opening/manhole with a 20" minimum dimension over each influent tee and effluent tee or filter. A 24" opening/manhole is preferred. For tanks that have more than one effluent filter, the access opening should be of sufficient size to enable tank pumping and removal of filters. The opening/manhole should be extended to finished grade. Where (a) riser(s) is/are required, it/they should be watertight. Two compartment tanks longer than 15' should have an additional manhole located just upstream of the dividing wall. Access covers should be of sufficient weight (59-pound minimum), mechanically fastened, or provided with a lock system to prevent unauthorized entry. The cover and frame assembly should be watertight (gasketed).

Where more than one inlet is necessary for multiple building sewers or when the sewer enters at the side of the tank, the inlet pipe(s) should be extended to the center manhole (for access and inspection), or the tank should be manufactured or modified with additional manholes.

---

#### Installation

---

Tanks should not bear on large boulders or rock ledges. Concrete septic tanks should be placed on a minimum 4" of leveled #2 stone or smaller aggregate, such as sand or pea gravel, to provide adequate bedding. Underlying soils and bedding materials should be adequately compacted to eliminate later



settlement.

Vertical seam (culvert type) precast concrete tanks should be installed in accordance with the manufacturer's instructions which may include a minimum 4"-thick mud slab to aid in assembly of the sections. When a tank is installed in an area where high groundwater levels may be present the design engineer should determine whether modifications of the tank design or installation are necessary to counteract buoyancy forces. An evaluation of HDPE, FRP and metal tanks should be made to determine whether flotation collars (or other buoyancy control methods) are necessary to prevent flotation.

Resistance to the hydrostatic and hydrodynamic forces of groundwater, backfill, tank filling and tank evacuation is accounted for in the structural design of concrete tanks. HDPE and FRP tank manufacturers require their installation procedures be strictly followed to prevent tank damage at installation and to account for high groundwater conditions and tank filling and pump outs.

When a septic tank system is installed under a driveway, in a parking lot, or heavily saturated soil, or another area subject to heavy loading, the tank should be designed to withstand an H-20 wheel load. All risers and access openings should be at finished grade for ease of maintenance.

---

#### Performance Testing

---

Protection from water infiltration and exfiltration is a critical element in the design, installation and construction of tanks used in on-site wastewater treatment systems (NPCA). All septic tanks and related appurtenances (inlet and outlet pipe seals, risers, covers, etc.) should be vacuum-pressure tested or water-pressure tested and certified to be watertight after installation and prior to backfilling (see ASTM Standards C1227 for septic tanks). Also see Appendix G of *Installation of Wastewater Treatment Systems* by the Consortium of Institutes for Decentralized Wastewater Treatment (CIDWT), latest version.

---

#### Backfill

---

Backfill and bedding of all tanks should strictly follow manufacturer's written recommendations. For tanks other than concrete, special care should be given to follow the manufacturer's recommendations. Backfill should be placed in uniform layers less than 24" thick and should be free of large stones (> 3" in diameter) or other debris. After backfilling, the tank should be inspected again, and if any damage is present, the tank should be repaired or replaced. Surface water should be directed away from tank openings.

The use and discharge of septic tank wastewater treatment chemicals and additives into a sewer is prohibited unless prior written approval is granted by the Department.

Environmental conditions such as temperature can affect the frequency of septic tank pump out and composition of solids in the tank. Exceptionally cold weather can result in septic tank temperatures where little or no anaerobic digestion occurs, so settled sludge and scum accumulates faster than it would at more moderate temperatures.

Septic tanks often contain toxic gases and are considered confined spaces by the Occupational Safety and Health Administration (OSHA). As such, septic tanks should not be entered by anyone UNLESS they have OSHA-certified training and proper equipment for doing so.

The local municipality or watershed authority may impose additional operation and maintenance requirements through sewer district rules or watershed rules and regulations.

#### **D.7 Effluent Screens / Filters (for septic tanks and grease interceptors)**

Septic tanks and grease interceptor tanks for new construction should have properly sized effluent filter (according to the manufacturer) installed at the outlet of the tank in lieu of or contained within the sanitary outlet tee. Tank effluent filters or screens are also recommended for existing septic tanks and grease interceptors. These filters and screens protect downstream treatment units from excessive solids buildup. For buildings with laundry service, lint traps, filters or screens should also be installed on the discharge line of washing machines to remove non-biodegradable solids, such as cloth fibers, sand, hair and pet fur.

Effluent filters should be sized based upon peak hydraulic loading and rated capacity of the device per the manufacturer's specification. Effluent filters can be placed in a separate tank or chamber/vault. If this is done, an outlet tee should also be installed on the grease interceptor tank, or the septic tank outlet. A high-water alarm is recommended to keep water out of the building and where a dedicated operator or service provider can respond. NYSDEC recommends the use of filters/screens certified by NSF, International Standard 46.

When multiple filters are installed in a tank, it is imperative the access opening be of adequate size for filter removal and maintenance. Filters should be inspected on a monthly basis to observe the characteristic solids accumulation rate of the filter.

## **D.8 Dosing Stations**

A dosing system provides for periodic discharge of a calculated volume of pretreated wastewater to a soil based treatment and dispersal field or secondary treatment unit for either subsurface or surface discharge. Dosing uses the principle of wetting and resting. A resting period is important for maintaining aerobic conditions. A dose rest cycle is based either on when the dosing station fills (demand dosing) or on a time basis (time dosing). Dosing may be accomplished with a pump, siphon, or float-style dosing mechanism. Sections E.5 and E.6 provide more details.

## **D.9 Distribution Boxes / Flow Splitters**

---

### Distribution Boxes

---

A distribution box is a device used to provide uniform flow to multiple distribution lines within a soil based treatment system. The box should have a cover that is vandal resistant, childproof and removable, and a riser that extends to grade for inspection and access that also serves as a permanent location marker. When deemed necessary by the design engineer or the manufacturer due to specific site conditions, concrete distribution boxes may be coated with a bituminous coating inside and out to ensure watertightness and prevent deterioration. Concrete distribution boxes may also be constructed to ASTM Specification C150 Type II for moderately sulfate resisting cement, or by the addition of appropriate additives. Concrete distribution boxes treating wastewater high in sulfur or sulfate should be adequately vented. Manufactured plastic or fiberglass distribution boxes designed to be used for wastewater effluent application may also be used. Distribution boxes of any material should be designed to withstand earth pressures.

The box should be installed on level ground, with a layer of sand or pea gravel 12" deep below the box, and around the sides. A slope of at least 1/8" per foot should be maintained for the connecting pipe, from the pretreatment unit to the box.

The invert of all outlet pipes from the distribution box should be at the same elevation and located at least 2" below the invert of the inlet pipe to the distribution box. If all outlet pipes are not at the same elevation, or if uneven settlement or frost heaving has resulted in unequal flow to lateral lines, adjustments should be made to reestablish equal flow. Several devices may be used, including adjustable weirs or leveling devices that can be inserted into each outlet pipe and rotated so the flow is equally distributed. Outlet distribution lines should all be laid at an equal slope of no more than 1/16" per foot until reaching the header pipe or laterals. There should be one outlet for each effluent distribution line. It is recommended that outlet inverts be placed at least 2" above the floor of the box to provide space for solids deposition.

The box should have an internal baffle or splash plate extending to 1" above the outlet invert elevation to dissipate the velocity of the influent and prevent short circuiting.

---

### Flow Splitters

---

A flow-splitting device is another option that can be operated from above ground enabling fields to be alternated for longer service life and should be installed, operated, and maintained according to the manufacturer's instructions. Flow splitting may be accomplished by special distribution boxes, alternating siphons, alternating pumps, float-based outlet devices, or specially designed and operated valves.

## **D.10 Wastewater Dumping Station**

Dump station wastes are typically generated from users of recreational vehicles (RVs), travel trailers and recreational water craft. Dump stations can be found at campgrounds, roadside rest areas and marinas. The design of a wastewater treatment system for these facilities including the minimum effective capacity of the septic tank should take the following into account:

- RV operators are generally considered conservative with water usage which results in wastewater with high organic and solids loading being discharged into the dump station.
- The typical mode of introducing waste into the receiving station (dumping) is not conducive to the steady flow needed for optimal biological treatment.
- The effect of various amounts and types of chemical additives used for odor control or seasonal dumping of winterizing fluids (antifreeze, formaldehydes, etc.), may kill or prohibit growth of anaerobic bacteria, the main biological treatment mechanism in the septic/primary treatment tank.

- Several peak-use periods (Sundays, days after holidays) can be expected.
- Required effective septic tank capacity is significantly more than indicated by typical hydraulic capacity designs used for treating domestic wastewater. Wide variations in daily flows have been noted. Familiarity with a facility's pattern of use is recommended.
- Chemical analyses of RV holding tanks (blackwater) have noted BOD<sub>5</sub> ranges of 1,600 to 12,000 mg/L (excluding wash down water). Similar wastewater characteristics should be expected from sewage holding tanks on recreational watercraft. RV holding tank contents should be blended or mixed with other sanitary wastewater sources to reduce organic strength prior to treatment. In situations where blending or mixing is not an option, holding and hauling the contents of the dump station's tank may be necessary.
- A septic tank serving a dump station requires more frequent pumping due to an increase in solids loading and reduction in solids digestion or breakdown because of chemical additives.
- The soil-based treatment and dispersal area and sand filter sizing should be based on organic loading.

## **D.11 Holding Tanks**

Holding tanks are not considered treatment units and are generally not allowed for year-round usage on a permanent basis. However, holding tanks may be approved on a case-by-case basis for seasonal operations or temporary usage while building or repairing permanent treatment facilities. Evidence of an agreement with a professional hauler for disposal of waste (see Section J.6. of this document) may be necessary prior to approval of holding tank installation. If holding tank waste is to be treated at a wastewater treatment plant, the treatment plant must be permitted by the Department to accept septage. The holding tank should have a capacity equal to at least twice the volume of waste to be generated between anticipated removal dates, with a minimum volume of 1,000 gallons. Installation of a high-level alarm positioned to allow storage of at least three days' volume of waste after activation is recommended. A cover over the tank or another method of odor control may be necessary. If winter usage is planned, the tank should be protected from freezing.

## D.12 Source Separation and Graywater Irrigation Systems

Graywater is defined as wastewater discharged from clothes washers, bathtubs, showers, dishwashers, and sinks (including kitchen sinks without garbage disposal units), but excludes “blackwater,” fats, oils and greases (FOG), and industrial wastewater containing toxic or hazardous materials. For graywater irrigation systems, discharged wastewater should be restricted to wastewater with low levels of pathogens. Graywater irrigation systems will require NYSDEC approval before discharge is allowed.

Residential graywater treatment systems with design flows under 1,000 gpd should be designed according to Appendix 75-A, and approved by a local health unit (county or district).

---

### Graywater Irrigation System Description:

---

The following descriptions pertain to graywater irrigation systems discharging to subsurface soil treatment systems on-site. Primary applications are where there is facility management and maintenance and some control over fixture usage.

Graywater, because of its low nitrogen (less than 10 percent of typical sanitary wastewater stream) and other pollutant concentrations (typically 50 percent of the BOD and 25 percent of the TSS found in sanitary wastewater) can be assimilated biologically within the topsoil (top 2 to 10 inches) without pre-treatment using subsurface drip or dosed irrigation.

Graywater irrigation systems are used most frequently in areas trying to conserve fresh water. They are also used in situations where there is a desire to reduce hydraulic and pollutant loading of existing on-site sewage treatment systems to increase system life.

Graywater irrigation systems should not be used at facilities discharging wastewater containing higher concentrations of pathogens from the washing of heavily soiled or potentially infectious laundry, such as diapers or similarly soiled garments.

Rinsing or discarding any hazardous chemicals, synthetic organics or petroleum byproducts from oils, paints, and solvents into a graywater irrigation system is not allowed, and facilities should have signage to ensure proper disposal or treatment of any industrial wastes.

Subsurface drip or dosed irrigation to shallow topsoil is the preferred design for a subsurface graywater

irrigation system. It provides greater uptake of nutrients and assimilation of other pollutants found in graywater, as compared to discharge typical of traditional on-site treatment systems. This technique also leads to reduction in the need for fresh water use for irrigation.

Towns, cities, or counties may ban or further limit the use of graywater described in this section by rule or ordinance. These systems are not allowed for residential facilities under 1,000 gpd (see Appendix 75-A for graywater treatment), and typically are not approved for any residential systems.

---

### Graywater Irrigation Systems Design

---

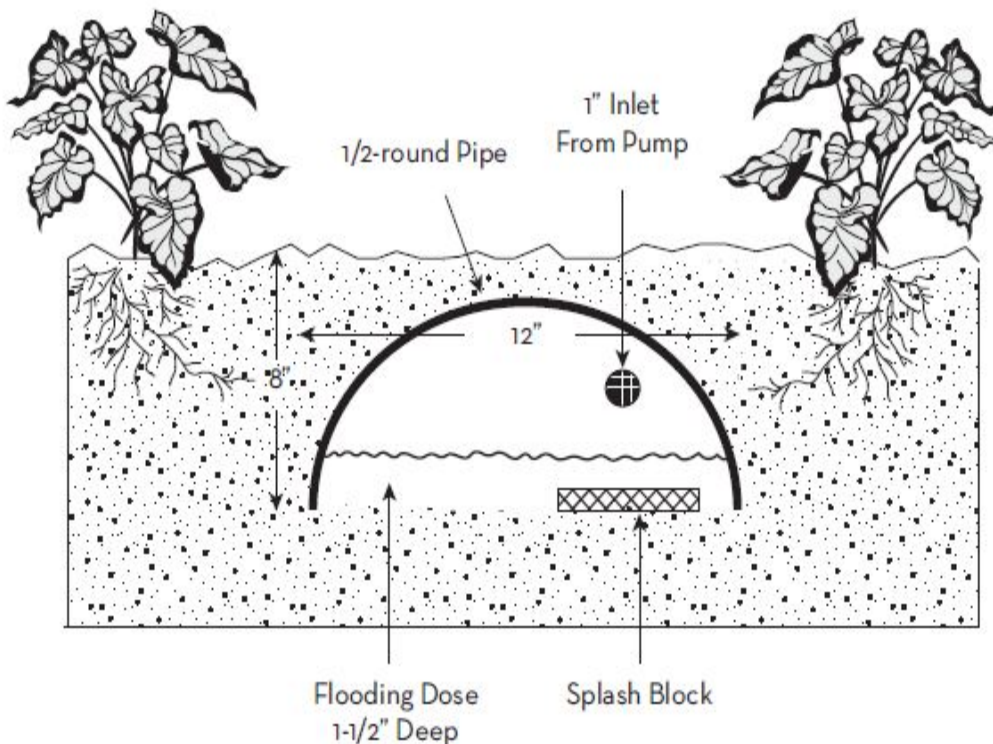

**Figure D-5 Graywater Irrigation Chambers**

*(Clivus-Multrum, Inc. Lawrence, MA. "Graywater System" fact sheet, November 2009)*

The following criteria should be followed when designing a graywater irrigation system:

- Avoid human contact with graywater and soil irrigated by graywater (using signage, fencing, landscaping, etc.).
- Graywater originating from a building or dwelling units and discharged is contained within the property limits for on-site garden, lawn, golf course, or landscape irrigation.

- Graywater should not be used for irrigation of food plants where it could come in contact with edible portion of these plants.
- Systems with design flows over 5,000 gpd should provide a groundwater mounding analysis.
- Systems with design flows over 30,000 gpd should provide ground water monitoring.
- The graywater irrigation system should be sited outside a floodway (i.e., not used for drainage).
- The depth of a graywater treatment bed or trench bottom should be no more than 12" below ground level. An 8" depth is recommended. Shallow percolation tests or a soil evaluation is required to properly size the treatment area.
- Graywater irrigation systems should maintain a minimum vertical separation distance of at least 2' from the point of graywater distribution (trench or bed bottom) to the top of the seasonally high groundwater table, unless a smaller vertical separation distance is approved by the Reviewing Engineer.
- Refer to Table B-2 using "Absorption Field or Unlined Sand Filter (Including Replacement Area)" column values for recommended minimum horizontal separation distances between listed features and the graywater irrigation system. Towns, cities, or counties may have more restrictive horizontal separation distances than those recommendations listed above and would take precedent.
- The graywater irrigation system should be designed and installed so that if blockage, plugging, or backup of the system occurs, the subsurface irrigation system can be serviced and repaired. The system may include a means of filtration to reduce plugging and extend its lifetime with required maintenance.

A graywater dosing basin or chamber is the collection point of all graywater. A dosing basin stores graywater until a sufficient dose has collected in the basin to flood the full length of the irrigation chambers to an approximate depth of 1.5". Regardless of stored volume, it must be discharged to the irrigation chambers within 48 hours to prevent septic conditions. Where a water-saving device is used, a maximum of 24-hour dosing basin residence time should be used. Any graywater dosing basin should be covered and secured/locked to restrict unauthorized access and to eliminate habitat for mosquitoes or other vectors.

Application rates are based on the soil type and soil structure, and are listed in Table E-1 "Recommended Sewage Application Rates" (Section E.2). Effluent is pumped to irrigation chambers via an effluent pump or gravity siphon where sufficient slope is available. If gravity feed to distribution beds is not sufficient to overcome slope and friction losses, a pump can be included in the system. Any pressure piping (or valves or faucets) used in a graywater irrigation system should be clearly labeled to indicate the piping does not



carry potable water.

Irrigation chambers (Figure D-5) consist of half round pipe 8 to 12" in diameter, usually 30' in length, set horizontally along the contour, several inches below the surface of the soil so the base of the half pipe rests on the soil at 8" of depth. Effluent is sent into the chamber through 1" pipe inlets set inside the chamber but above the base of the chamber to prevent freezing. Irrigation should be managed to prevent standing water on the surface, for example, by splitting the flow, using moderate application rates (from Table E-1) and mulching generously.

The aerobic and biologically active top 2 to 10" of soil are an extremely effective medium for rapidly stabilizing "fresh" graywater. After an excessive period of graywater storage, the available oxygen will be depleted, and the stored water will become anaerobic. For this reason septic tanks are not desirable for the described system. Any type of settling tank will cause the graywater to become septic and lead to foul smelling effluent the topsoil will take longer to stabilize.

For replacing a conventional septic tank STS with a blackwater source separation system and a graywater irrigation system, the minimum area requirements for trenches or beds may be reduced by 50 percent. Minimum setback distances may be reduced by 75 percent from the combined wastewater requirements. This reflects both the hydraulic load reduction (no flush toilet, no garbage grinder) and the pollutant load reduction (no human body excreta or garbage grinder food waste).

---

#### Graywater Irrigation Systems in Addition to Conventional Wastewater Treatment Systems

---

When using an onsite wastewater treatment facility for combined black water and graywater treatment and disposal, the added use of a graywater irrigation system does not reduce the design, capacity, or reserve area requirements for the facility. The wastewater system is designed to ensure it can handle the combined black water and graywater flow if the graywater irrigation system fails or is not used.

Graywater diverter valves that provide the option of sending graywater to the irrigation system or to the OWTS or municipal sewer should be downstream from traps and vents provided for the facility's internal plumbing.

## **E. Subsurface Treatment and Discharge**

*NYSDEC categorizes treatment technologies in Chapters E, F, and G of these design standards as either standard or alternative technologies. Standard technologies are systems that have been applied successfully in New York State for a long time with a good record of reliability and effectiveness. Alternative technologies are treatment systems that have not been widely used in New York State, but have been successfully applied in other parts of the country.*

*The following technologies covered in this chapter are considered standard technologies:*

- *Absorption Trenches/Beds*
- *Shallow Absorption Trenches*
- *Gravelless (Aggregate-Free) Absorption Systems*
- *Cut-and-Fill Systems*
- *Raised Systems*
- *Seepage Pits*

*The following technologies covered in this chapter are considered alternative technologies:*

- *Alternative Aggregate*
- *Mound Systems*
- *Pressurized Shallow Narrow Drain Fields*
- *Drip and Other Low-Profile Dispersal Systems*

### **E.1 Introduction**

Subsurface discharge via a conventional soil based treatment system (STS) is not recommended if required depths of usable soil as given in Section B of this document are not available. Cut-and- fill, raised, and mound systems may be used to achieve the necessary vertical separation (Sections E.12 through E.14).

The minimum pretreatment required prior to an STS is settling in a septic tank. A greater degree of treatment may prolong the life of the soil-based treatment system and may be necessary for wastewater with elevated organic loading. All surface runoff should be diverted away from the soil-based treatment area (STA) both during and after construction. Roof, foundation, cellar, garage floor, and groundwater drainage should be diverted from the STA.

Planting lawn grass and other shallow rooted plants over the STA is recommended. Trees and deep-rooted shrubs should not be planted over an STA. Grazing of livestock on an STA is not recommended.

Unavoidable compaction and possible overgrazing of the area are destructive to its function.

Staking out an STA prior to other site development activities (building locations, well drilling, material deliveries, etc.) is necessary to protect it from compaction or changing the nature of the in-situ soil. Pre-application meetings or pre- and post- construction meetings should be used to prevent any destructive or compacting actions over the STA from occurring. Landscaping activities following construction can also be a source of compaction or unintentional excavation or excessive fill being placed over the STA.

Buildings, impervious surfaces (including driveways and parking lots), vehicles (cars, tractors, trucks) or heavy equipment should not be placed upon an STA. These items also should be avoided down slope from the STA, where system failure from soil compaction or effluent day lighting may occur. Discharge of septic tank effluent to a system under a paved or otherwise compacted surface is not recommended. If existing housing density precludes a properly designed STS and a system installation is proposed for under impervious areas (e.g., pavement or parking lots), septic tank effluent should be further treated biologically using advanced technologies from Sections F or G, and possibly disinfected. Venting of this type of installation may be required. Disposal under an impervious area may require review and approval by the Department.

The level of treatment will be determined at the preapplication meeting described in Section A.2. Advanced treatment systems require active management (on-site visits and remote telemetry) to maintain treatment levels and properly operate and maintain the system.

## **E.2 Application Rates**

Design of soil-based treatment systems should be based on the results of the site and soils evaluation as outlined in Section B. Recommended maximum sewage application rates for various percolation rates are shown in Table E-1. The soil types listed in Table E-1 are included as a guide to likely percolation rates, although local factors such as soil structure and surface topography may cause actual percolation rates to differ from this ideal.

The lowest level of technology tends to be more reliable and require less maintenance, and allowing soils to do most of the treatment is preferred. The use of more sophisticated technology to justify increased application rates and decreased vertical or horizontal separation distances, increases environmental and public health risks, and requires more oversight.

When replacing a failed STS, adding secondary or tertiary treatment to reduce STS field size (increase in application rate) may be allowed by the Reviewing Engineer. To prevent hydraulic overloading of an STS due to the increased application rate, the soil must be evaluated for the horizontal flow component. The linear loading rate (LLR) is based on hydraulic conductivity and the horizontal flow component of each soil horizon. The LLR should be calculated by a design engineer familiar with soils science, a hydrogeologist or a soil scientist to determine how the applied wastewater will move through the soil matrix. The STS should be designed based on both vertical absorptive capabilities and horizontal hydraulic conductivities, with the longest dimension of the distribution system parallel with the contours of the site. Dosing or pressure distribution and alternating fields are highly recommended to maximize uniform distribution of wastewater over the entire STA.

To protect the STA from becoming anaerobic due to sealing off by high concentrations of fats, oils and greases (FOG) in certain facilities as specified in Sections D.5 – D.7, pre-treatment using a grease interceptor in addition to a septic tank and septic tank effluent filter is recommended. Regular and thorough maintenance of these treatment components should assure that minimal FOG concentrations are discharged to the soil treatment area. Dosing or pressure distribution and possibly alternating fields or trenches may also be used for high FOG effluents.

Conventional soil-based wastewater treatment systems (absorption trenches or beds) preceded solely by septic tanks should not be used for rapidly permeable soils (less than 1 minute per inch) because the treatment provided may not be sufficient to protect nearby water supplies from contamination by nitrates, pathogens, detergents, or other chemicals that cannot be effectively removed by this type of soil. A combination of both an acceptable percolation rate and depth of soil is needed provide necessary detention time in the soil for treatment. If amending or replacing native soil, the percolation rate and replacement procedure must be documented by the design engineer and it may require approval by the Department. If the percolation rate or soil consistency is unacceptable for a conventional subsurface system, or the soil amendment process fails, a raised, mound, or sand filter system, or a surface discharge may be required instead.

Conventional soil-based treatment systems should be avoided if the percolation rate is slower than 60 mpi for trenches or 30 mpi for beds, especially if other difficult factors are present, such as steep slopes, depressions, or high groundwater or bedrock. In these cases, the linear loading rate (LLR) should be calculated by the design engineer familiar with soils science, a hydrogeologist or a soil scientist to determine how applied wastewater will move through the soil matrix. The STS should be designed based on both vertical absorptive capabilities and horizontal hydraulic conductivities, with the longest dimension of the

distribution system parallel with the contours of the site. Dosing or pressure distribution and alternating fields are highly recommended for maximizing uniform distribution of wastewater over the entire STA

**Table E-1 Recommended Sewage Application Rates**

<b>Percolation Rate (mpi)</b>	<b>Typical Soil Type</b>	<b>Application Rate (gal /day/sq. ft.)</b>
< 1	Gravel, Coarse Sand	Not suitable <sup>42</sup>
1-5	Coarse Medium Sand	1.20
6-7	Fine Sand, Loamy Sand	1.00
8-10	Fine Sand, Loamy Sand	0.90
11-15	Fine Sand, Loamy Sand	0.80
16-20	Sandy Loam, Loam	0.70
21-30	Sandy Loam, Loam	0.60
31-45	Loam, Porous Silt Loam	0.50
46-60	Loam, Porous Silt Loam	0.45
61-120	Silty Clay Loam, Clay Loam	0.20 <sup>43,44</sup>
> 120	Clay	Not Suitable

---

Percolation rates faster than 10 mpi and overlying aquifers

---

The application rates given in Table E-1 may not be sufficient to protect groundwater in soils with percolation rates faster than 10 mpi which overlie aquifers designated by New York State as Primary Water Supply Aquifers and Principal Aquifers. In these areas, extra protection may be required to prevent degradation of groundwater quality, in addition to the general recommendation for dosing or pressurized distribution in Section E.4, with design details described in Section E.5.

---

<sup>42</sup> These soils may be suitable if a modified soil-based treatment system, pressure distribution, or enhanced treatment prior to discharge is used.

<sup>43</sup> Careful site analysis is necessary to show these soils will transmit the flow of wastewater. Extreme caution should be used to avoid damage to the site during construction, or the system will fail. Surface discharge of treated wastewater may be preferable in certain cases.

<sup>44</sup> Certain jurisdictions may restrict or prohibit the use of STSs in soil with percolation rates slower than 60 mpi.

To be protective of groundwater where soils are unconfined and wastewater will flow through quickly or soil is shallow, a conventional STS should not be used. Additional protective action should be implemented, either with soil fill that will slow the percolation rate for more effective treatment or pretreating wastewater to protect public and private drinking water supplies.

### **E.3 Nitrate Advisory for Groundwater Discharge**

The application rates given in Table E-1 may not be sufficient to protect groundwater in soils with percolation rates faster than 10 mpi overlying Long Island aquifers, or New York State designated Primary Water Supply aquifers, and Principal aquifers. In these areas, extra protection may be required to prevent degradation of groundwater quality. When design population density exceeds 2 to 4 dwelling units/acre (6 to 11 persons/acre), recharge water to the aquifer from conventional subsurface disposal systems probably will exceed the nitrate standard for drinking water. Although NYSDEC does not make zoning regulations, it is recommended that population densities be kept below this level unless local factors indicate that the project will not result in groundwater degradation alone, or in combination with other discharges (including fertilizers and pesticides leached from the ground surface). If population density exceeds 11 persons per acre, absorption system design should be modified to provide enhanced treatment of the wastewater by the soil system, or additional treatment should be provided prior to subsurface discharge. Average population density is based upon the total land area of the development. For example, in addition to land that dormitories are on, playing fields would be included when determining the average population density for a boarding school.

### **E.4 Distribution Networks**

---

#### Methods of Distribution

---

There are three primary methods of distributing pre-treated wastewater to subsurface treatment and disposal networks: by gravity, under pressure, or a combination of both.

Gravity distribution, or trickle flow, is the most commonly used method for small systems. Gravity conveys wastewater downstream from treatment components to infiltrative surfaces (trench/bed bottom and sidewalls) through pipes or gravelless chambers laid in trenches or beds. Gravity distribution can be used on level and sloped sites.

Pressure distribution uses a pump to distribute the effluent through pressurized orifices. Pressure distribution provides a more uniform application of wastewater throughout the soil-based treatment area (STA), than gravity distribution. Pressure distribution permits rapid distribution of septic tank/aerobic unit effluent throughout the soil-based treatment system followed by a rest period during which no effluent enters. A pressurized distribution system description follows the Gravity Distribution Network Types subsection below.

Dosed distribution (including “pump to gravity”) combines the forces of pressure and gravity. Effluent is collected in a siphon, float/tipping device, or pump chamber and a predetermined volume is discharged through the trench, bed piping or gravelless chambers by gravity.

Pressurized distribution or dosed distribution is recommended for:

- Wastewater flows in slowly permeable soils (i.e. 61 mpi to 120 mpi)
- Alternative systems (e.g.: raised systems, mounds, and sand or media filters) with wastewater flows where even distribution is critical to the performance of the system (e.g.: sloped sites)
- Site conditions where a gravity system cannot provide even distribution (e.g.: rapidly permeable soils with percolation rates faster than 10 mpi)
- Systems with a total absorption trench length exceeding 500 feet or if laterals are over 100 feet long

Dosing the STS with pressurized distribution or dosed distribution should be considered for all soil treatment and dispersal systems because it promotes improved treatment of wastewater and system longevity as compared to gravity-flow systems. If duplicate pumps are not provided, the pump chamber should have a reserve capacity above the active dosing volume equal to one day’s average flow.

---

#### Materials and Construction

---

For nonpressurized systems (gravity distribution and dosing), 4"perforated plastic pipe is recommended. A wide variety of PVC (ASTM D2665) or ABS (ASTM D2661) pipe designated by ASTM as sewer or drainpipe may be considered.

A pressurized system should use 1 to 3" PVC (ASTM D1785, ASTM D2241) or HDPE pipe. A minimum in-line pressure of 2.5' will allow for deviations from level up to 3 percent. Pressurized system should be placed so the laterals and manifold drain after every dose.

- Single-line networks (single pipe or chamber with capped ends [not looped]) can be used in trenches with gravity flow or dosing. If the line is greater than 100-feet long, the inlet from the pre-treatment unit should be at the midpoint of the line. No line should be longer than 200 feet. Dosing is recommended for lines over 60 feet and highly recommended for 100-foot lines or greater (see Section E.8 Absorption Trenches/Beds).
- Closed-loop networks can be used for bed or trench systems when the infiltrative surface is all at one elevation. Spacing between lines should be at least 3'. Dosing of these systems is highly recommended (see Section E.8 Absorption Trenches/Beds).
- Distribution boxes can be used for gravity flow or dosing in multi-trench or bed systems but should be restricted to sites with slopes less than 5 percent. Distribution boxes should not be used with pressure distribution. See Section D.9, Distribution Boxes and Flow Splitters, for distribution box dimensions and installation.
- Drop boxes or relief-line systems using sloped piping are recommended for gravity distribution, or dosing, on slopes greater than 5 percent. These approaches are less likely to result in surface breakout than distribution boxes. The inlet invert of the drop- box should be at the same level or above the outlet crown. The invert of the outlet should be a minimum of 1" above the invert of the distribution lateral, which should be at the bottom of the drop box.
- If relief lines are used to direct flow from the higher distribution lines to the next lower trench and distribution line, the relief line is connected to both distribution lines with a tee. From the higher line, the relief line is plumbed up and out of the trench before being directed to the lower trench. The invert of the first relief line at its high point should be at least 4" lower than the invert of the septic tank outlet for gravity flow.



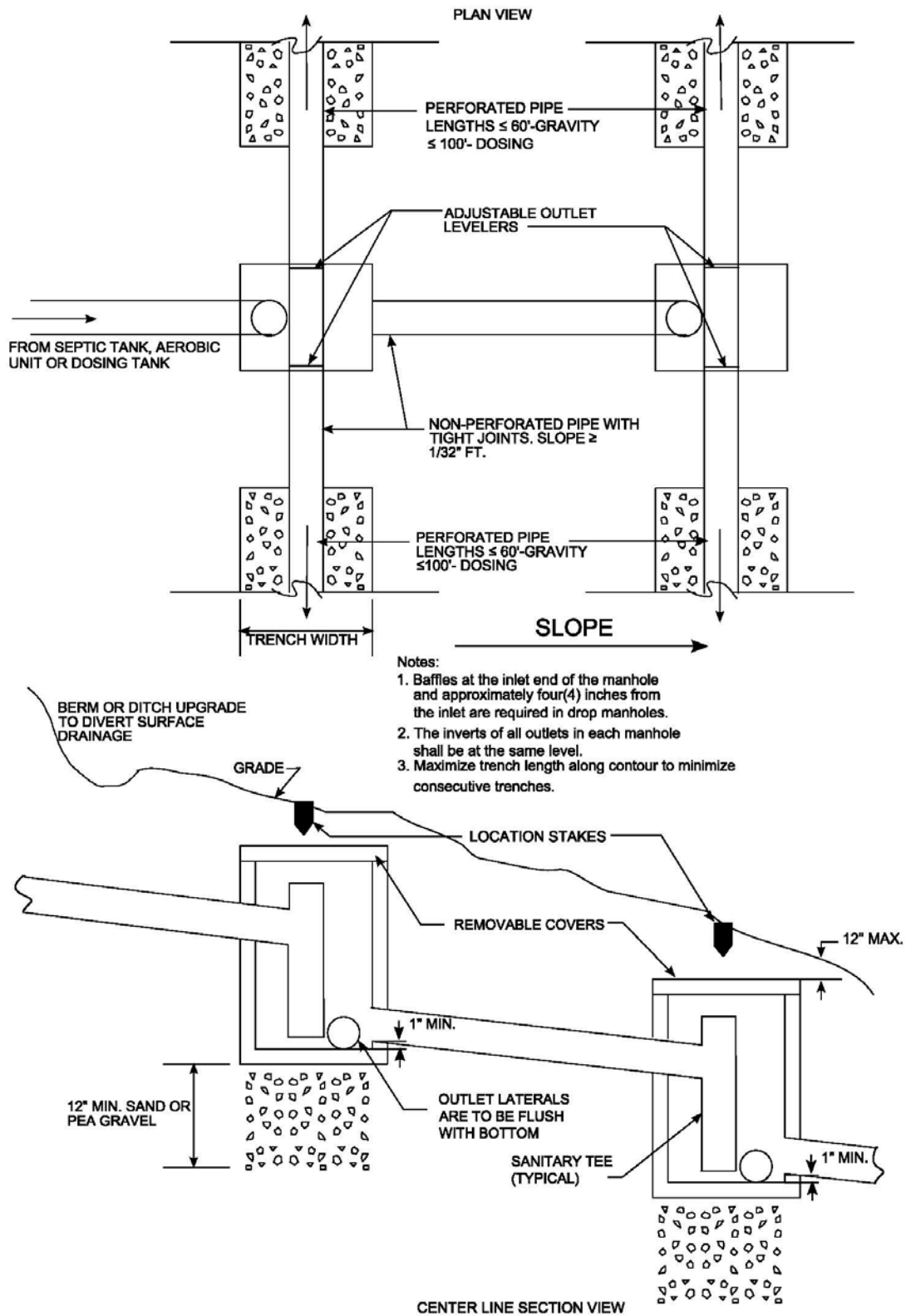

Figure E -1 Drop Box Distribution Network

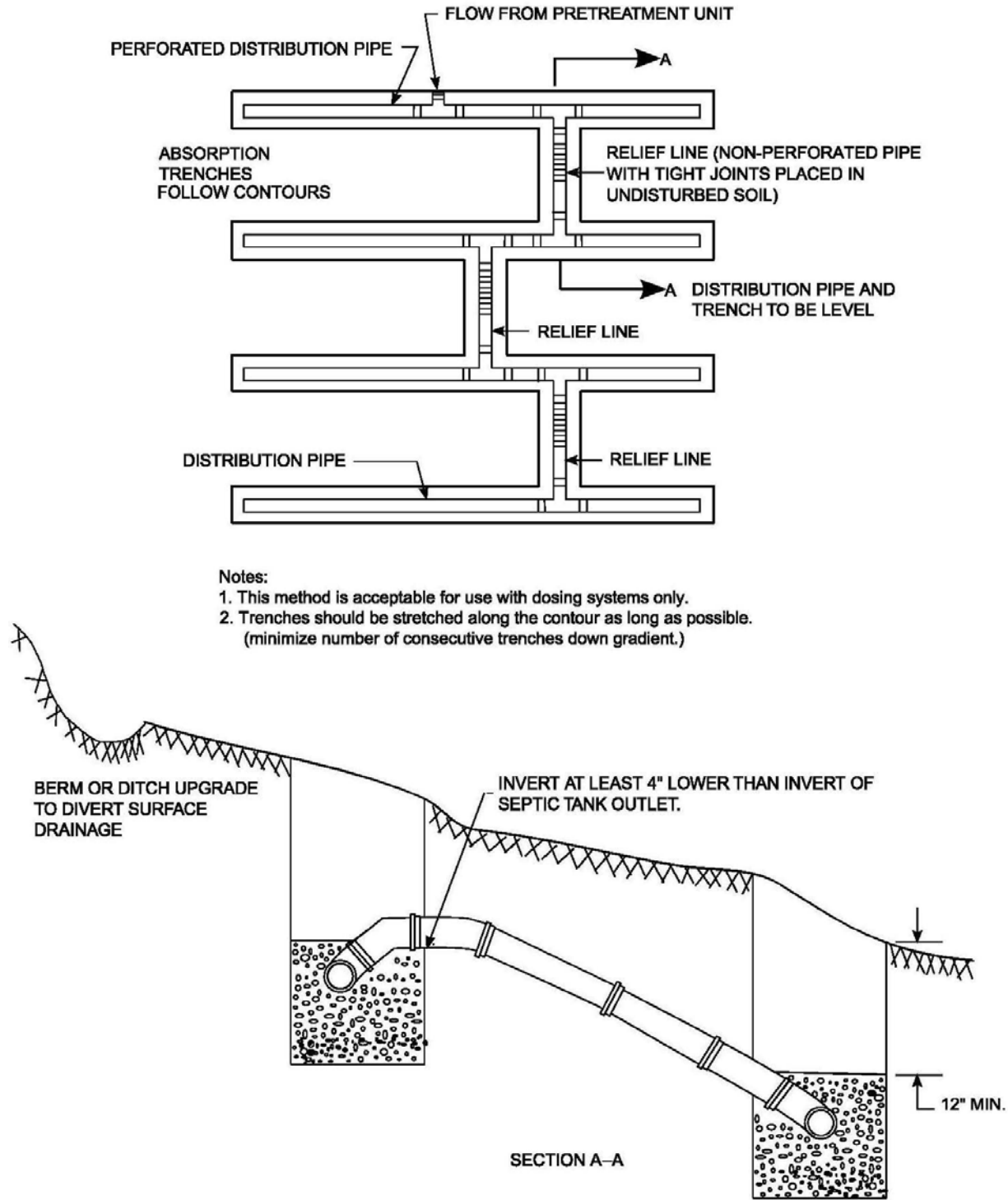

Figure E -2 Serial Distribution Network

## E.5 Pressurized Distribution System

The piping network used with pressurized distribution differs from those used with gravity distribution and nonpressurized dosing in that it uses smaller diameter piping with smaller perforations or specialized orifices. The volume of water that flows out each hole should be approximately equal. This requires that 75 to 85 percent of the head loss in the network be lost when water passes through the holes. On sloped sites, the difference in total head between laterals at different elevation should be considered. On level sites, lateral spacing should be approximately equal to perforation spacing, and holes on adjacent laterals should be staggered so they lie on the vertices of equilateral triangles. A “squirt test” should be used prior to backfilling.

Hole-size should be within the range of 1/8" to 5/8"; the maximum allowable hole spacing is 10', but no more than 6' is recommended. One-eighth-inch holes depend on a well maintained effluent filter and all burrs removed from drilled holes. A small perforation at the end of each lateral should be drilled horizontally in the end cap near the crown of the pipe to facilitate venting.

Root penetration may be reduced and soil aeration increased by orienting orifices to spray upwards into orifice shields or inverted half pipes, or by “sleeving” the small diameter pipe into a 4" perforated pipe with one row of perforations directed to the 6 o'clock position. Monitoring and cleanout ports also need to be used with pressurized distribution networks.

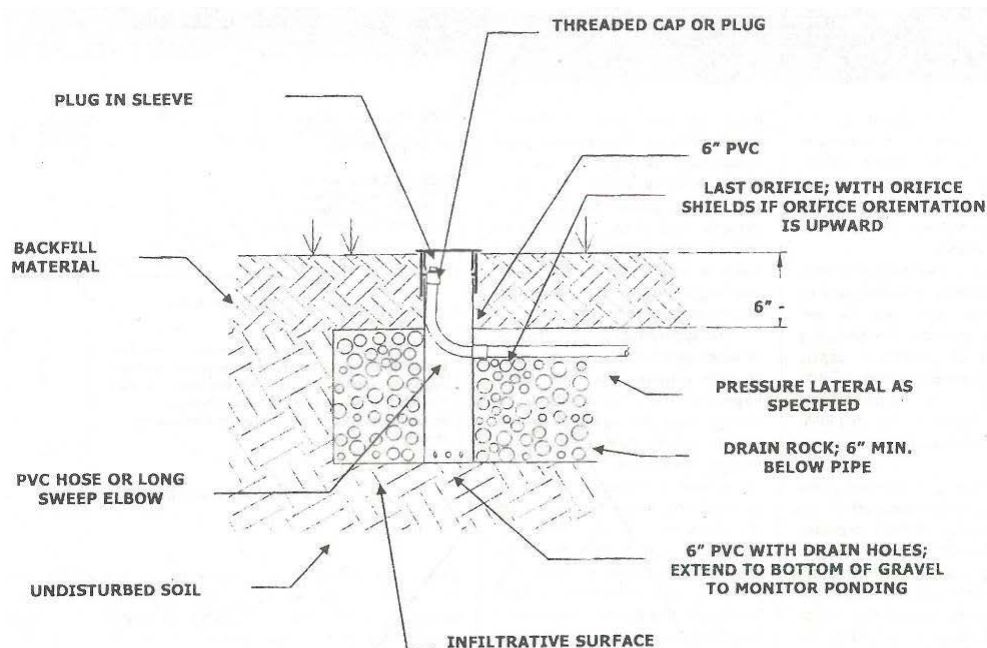

**MONITORING PORT DETAIL I**

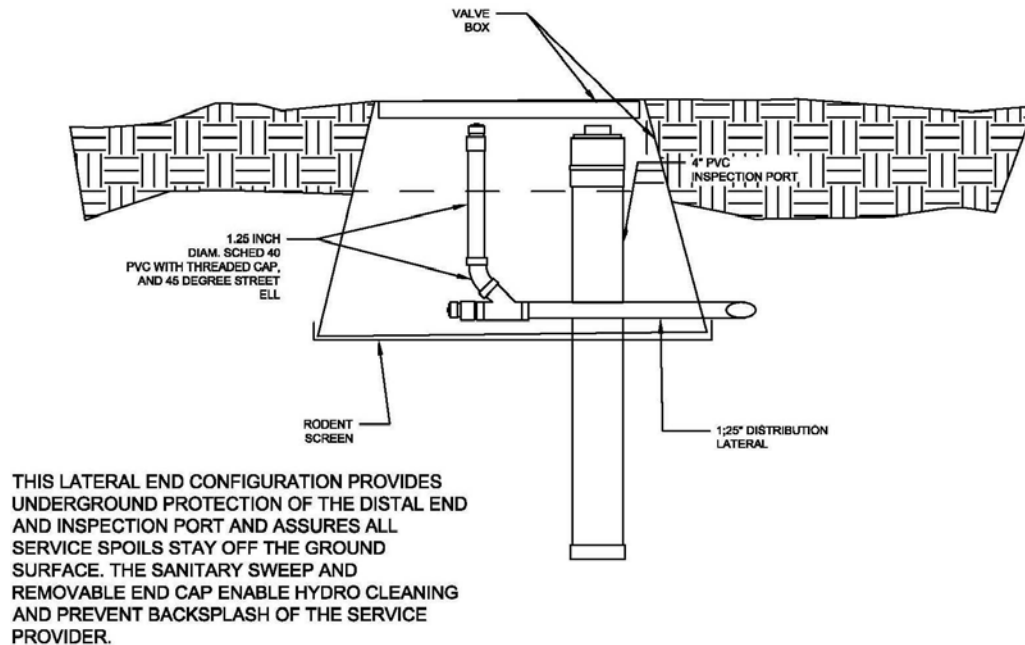

### MONITORING PORT DETAIL II

**Figure E -3 Monitoring and Cleanout Ports**

---

#### Pressurized Distribution System Design Procedure

---

Below is a simplified design procedure for rigid pipe pressure networks as presented by Richard J. Otis (1982) as cited in the 2002 EPA OWTS Manual, page 4-27.

1. Lay out the proposed network.
2. Select the desired orifice size and spacing. Maximize the density of orifices over the infiltration surface, remembering the dosing rate increases as orifice size increases and orifice spacing decreases.
3. Determine the appropriate lateral pipe diameter compatible with the selected orifice size and spacing using a spreadsheet, or sizing charts from Otis (1982).
4. Calculate the lateral discharge rate using the orifice discharge equation <sup>45</sup>  $Q = 0.8 (11.79 d^2 h_d^{1/2})$ ,

---

<sup>45</sup> Note: Per EPA/625/R-00/008 page 4-26, the orifice equation that Otis' assumption of an orifice coefficient of .6 yielded an overestimation of the maximum lateral length. Therefore, the rate is decreased by 20% to account for that overestimation.

where “Q” equals the discharge in gallons per minute per orifice, “d” equals the orifice diameter in inches, and “h” is the operating pressure in feet of water.

5. Determine the appropriate manifold size based on the number, spacing, and discharge rate of the laterals using a spreadsheet, or sizing table from Otis (1982).
6. Determine the dose volume required. Use either the minimum dose volume equal to five times the network volume or the expected daily flow, divided by the desired dosing frequency, whichever is larger.
7. Calculate the minimum dosing rate (multiply lateral discharge by the number of laterals).
8. Select the pump based on the required dosing rate and the total dynamic head (sum of the static lift, friction losses in the force main to the network, and network losses, which are equal to 1.3 times the network operating pressure).

Refer to Appendix E.1 for a design example of Pressurized Distribution Systems.

## **E.6 Design of Dosed Distribution Systems (pump to gravity)**

In dosed distribution systems, effluent may be collected in a siphon, float/tipping device, or pump chamber, and a predetermined volume is discharged through the trench or bed piping or gravelless chambers by gravity. Pumps can deliver effluent on a timed-dose basis or a demand dose basis. Siphons and tipping/float devices deliver only doses on demand, i.e. when the critical tank volume is reached.

Following is general design guidance for dosed systems:

- The dosing siphon (or pump, or other dosing device) should have a capacity sufficient to fill at least 75 percent of the interior volume of the distribution lateral lines being dosed.
- A dosing device should have a minimum discharge capacity of 125 percent (preferably 200 percent) of the maximum rate of inflow to the dosing chamber.
- Pump and power failure contingencies should be comparable to those in Section C.3.c for pump stations. Where public water is supplied, a solenoid shutoff valve for the water supply line with manual override should be considered to prevent water from flooding the system.
- Dosing siphons, pumps, tanks and devices should be arranged for convenient access and inspection. If possible, dosing devices should be designed to function by gravity in case of mechanical or power failure.

- If multiple dosing devices are used, valves and fittings should be provided to enable each section of the system to be dosed by any one of the devices.
- Dosed systems should have provisions to prevent the flow of wastewater out of vents in the piping network.
- High-level alarm systems should be considered for all dosing chambers. Where dosing chambers are located at a remote distance from the system, remote telemetry should be considered.

The design of dosing tanks for domestic-type sewage must conform to the design standards of a septic tank (see Section D.6).

---

#### Dosing Chamber Capacity Requirements

---

The dosing network reserve capacity requirements should be based on the type of facility being served and whether or not dual pumps are used. With a duplex pump system, the reserve capacity is less critical. With a single pump system, it is recommended the reserve capacity be not less than 25 percent of the daily average flow. The volume below the working level (and reserve capacity) should include an allowance for the volume of all drainage which may flow back to the chamber when pumping has ceased.

The pump dosing chamber should be large enough to accommodate the following parameters (Fig. A-5 in *Pressure Distribution Network Design*):

- Dose volume
- Volume of the pump and any supporting materials (e.g., concrete blocks)
- A few inches of freeboard for floats
- Reserve capacity ( $\geq$  25 percent of the average daily flow)

The “maximum rate of inflow to the dosing chamber” means the peak flow being delivered to the dosing chamber by the preceding system device e.g., a septic tank, an equalization tank, a polishing filter following an RBC or a filter for BOD removal. The design engineer needs to determine what the flow entering the dose chamber would be. This usually is in gallons per minute (gpm), not peak gallons per hour, over the significant delivery period. Dosing chamber capacity should exceed that volume delivered over the significant delivery period to prevent it from being flooded. The outflow rate of the dose (distribution rate) has to be significantly larger than the inflow (or delivery) rate.

---

## Dosing Chamber Design Example

---

A children's camp has a daily design flow of 5,000 gallons and a peak flow of 2,000 gallons over a one hour period. What is the maximum rate of inflow?

Inflow rate = 2,000 gallons/60 minutes = 33 gpm

For a peaking factor = 1.25, the maximum rate of inflow =  $1.25 \times 33 \text{ gpm} = 42 \text{ gpm}$

For a peaking factor = 2.00, the maximum rate of inflow =  $2.00 \times 33 \text{ gpm} = 66 \text{ gpm}$

Using the given example, 2,000 gals over an hour equals 33 gpm. Therefore, the dosing rate has to be at least 42 gpm preferably 66 gpm assuming the 33 gpm flow actually is the rate going to the chamber. If there are septic tanks or some other unit ahead of the dosing chamber, flow peaks may be attenuated and a lower inflow figure used. The device that removes wastewater from the dosing chamber should always be able to remove it faster than it comes in. If the maximum inflow rate is "x" gallons per minute, the outflow pump should be able to distribute at least 1.25 times "x" gallons per minute to the soil treatment area.

---

## Dosing Soil Treatment Systems

---

Dosed Distribution for absorption trenches:

- Maximum length of each absorption trench should be 100 feet.
- Absorption trenches totaling over 500 feet -pressure-dosed gravity distribution is recommended.
- Absorption trenches totaling over 1,000 feet - alternating pressure-dosed gravity distribution is recommended.

Alternating Dosed Distribution for absorption trenches:

- Absorption systems using 1,000 feet of total trench length should be constructed in two or more sections such that no one section contains over 1,000 feet of trench.
- The capability to dose each section in an alternating manner should be provided.

Dosed Distribution for absorption beds:

- The maximum lateral length should be 75'.
- The minimum dosing of 3 times per day is recommended.
- The dose volume should be equal to 75 percent to 85 percent of the volume of the lateral pipes.

Either Dosed Distribution or Pressure Distribution is recommended for cut-and-fill systems, and raised systems. Pressure Distribution is highly recommended for all mound systems to ensure equal distribution of effluent throughout the sand media of the STS. See Sections E.12, E.13 and E.14 for further information on cut-and-fill, raised, and mound systems respectively.

---

## Dosing Systems

---

For Dosed Distribution using pumps, the design engineer should work with pump manufacturers for pump selection based on the system (flow vs. head) curve. For proprietary float/tipping devices, the design engineer should consult with the manufacturer. Due to design variations, care should be taken in sizing dosing siphons. Siphons have discharge rates ranging from 25 to 3,000 gpm. The pipe network receiving the dose from the siphon should be at an elevation 4' lower than the siphon. *Evaluation of Siphon Performance and Pressure Distribution for On-site Systems* (Falkowski, G.M., Otis, R.J., and Converse, J.C. 1988) discusses siphon performance and design.

When designing a distribution network, attention should be given to sizing of the perforations (or orifices) to ensure an even distribution throughout the network.

### **E.7 Reserve Area**

Consideration should be given to constructing the absorption area in three sections, with each section capable of handling 50 percent of the design flow. The third section should be alternated into service on a semi-annual or annual schedule. This will extend the life of the STS and provide a standby unit in case of failure. A valving system for a three-bed or three-field soil-based treatment system is shown in Figure E-4. Additional valving is required to isolate pumps, siphons or floating/tipping effluent delivery systems.

If the three-section option is not chosen, then the full field (100 percent) replacement area (Figure E-5) is required. Any area set aside for replacement should not be used for future expansion. This option is intended for all STSs, unless noted otherwise in the applicable section.



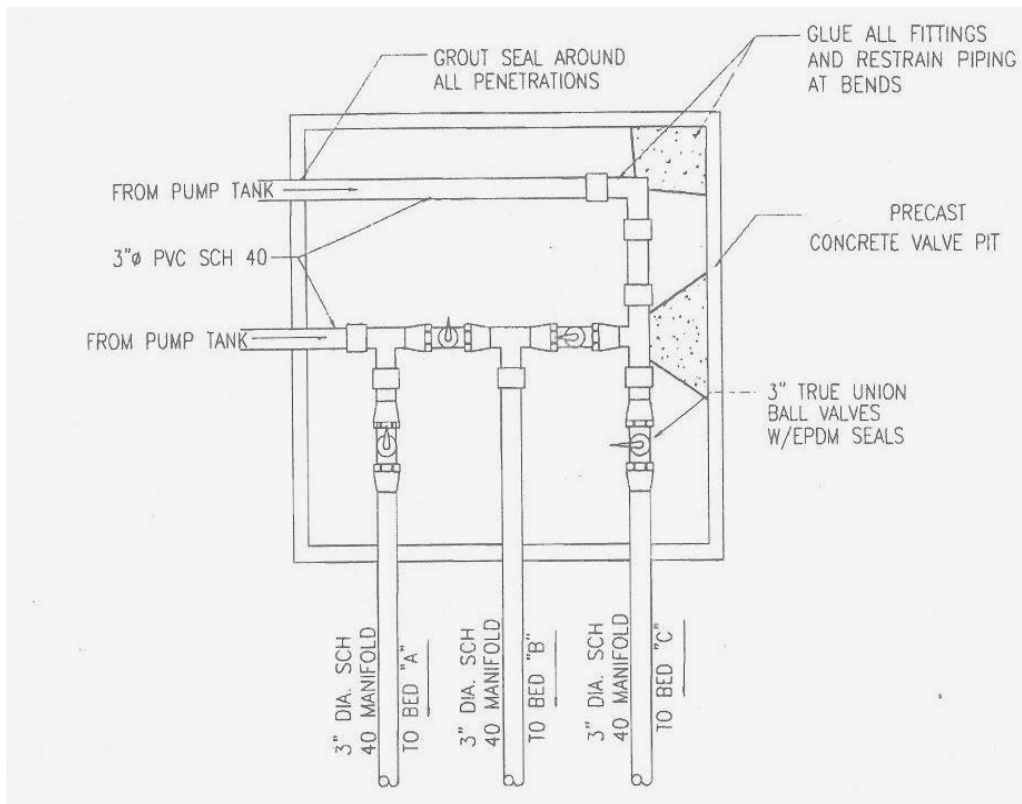

**Figure E-4 Typical Valving for Three Bed or Three Field Soil-based Treatment Systems**

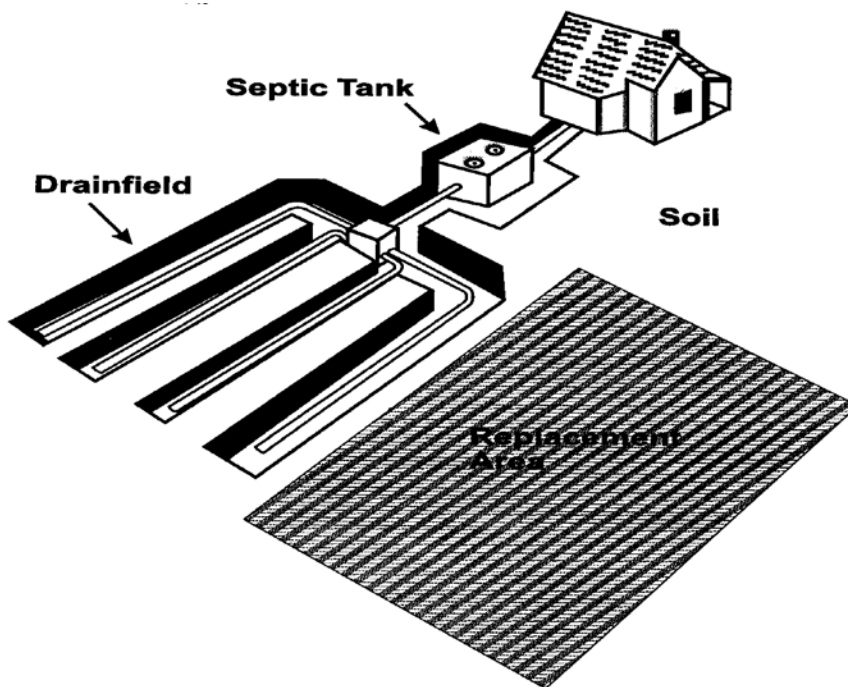

**Figure E-5 Full field Reserve Area**

## **E.8 Absorption Trenches/Beds**

Absorption trenches/beds are used to distribute sewage over a wide area to enhance treatment and dispersal by seepage into the ground. A typical absorption trench layout is shown in Figure E-6. Absorption beds are similar, except that they are wider and contain more than one distribution lateral, as shown in Figure E-7.

Trenches are strongly recommended instead of beds, especially in soils with clay content or where groundwater flow patterns are horizontal. Subsurface flow in clay soils has a greater horizontal flow component relative to other soil types. Increased horizontal flow combined with minimal side-wall absorption area in beds as compared to trenches, results in a higher probability of a breakout of sewage to the ground surface.

In any soil type, as the site slope or a limiting layer below the STS causes the horizontal flow rate of wastewater to approach the vertical flow-rate component, groundwater mounding increases proportionately. The lack of a side-wall area of a bed further increases groundwater mounding and results in a loss of vertical separation between the bed and groundwater. Treatment under a bed system in this scenario is likely to become anaerobic, as the vadose zone becomes saturated with wastewater and soil resting periods are precluded.

For sloping sites greater than 5 percent, distribution laterals should be spaced to avoid groundwater mounding. This can be accomplished with a few but long distribution laterals parallel to the site contour, or short trenches parallel to the site contour with increased spacing between trenches. For well-drained soils that demonstrate the necessary assimilative capacity, trenches may be placed on sites with a maximum slope of 20 percent. For poorly drained soils, trenches may be placed on sites with a maximum slope of 15 percent. Beds should be limited to sites with slopes of no greater than 5 percent.

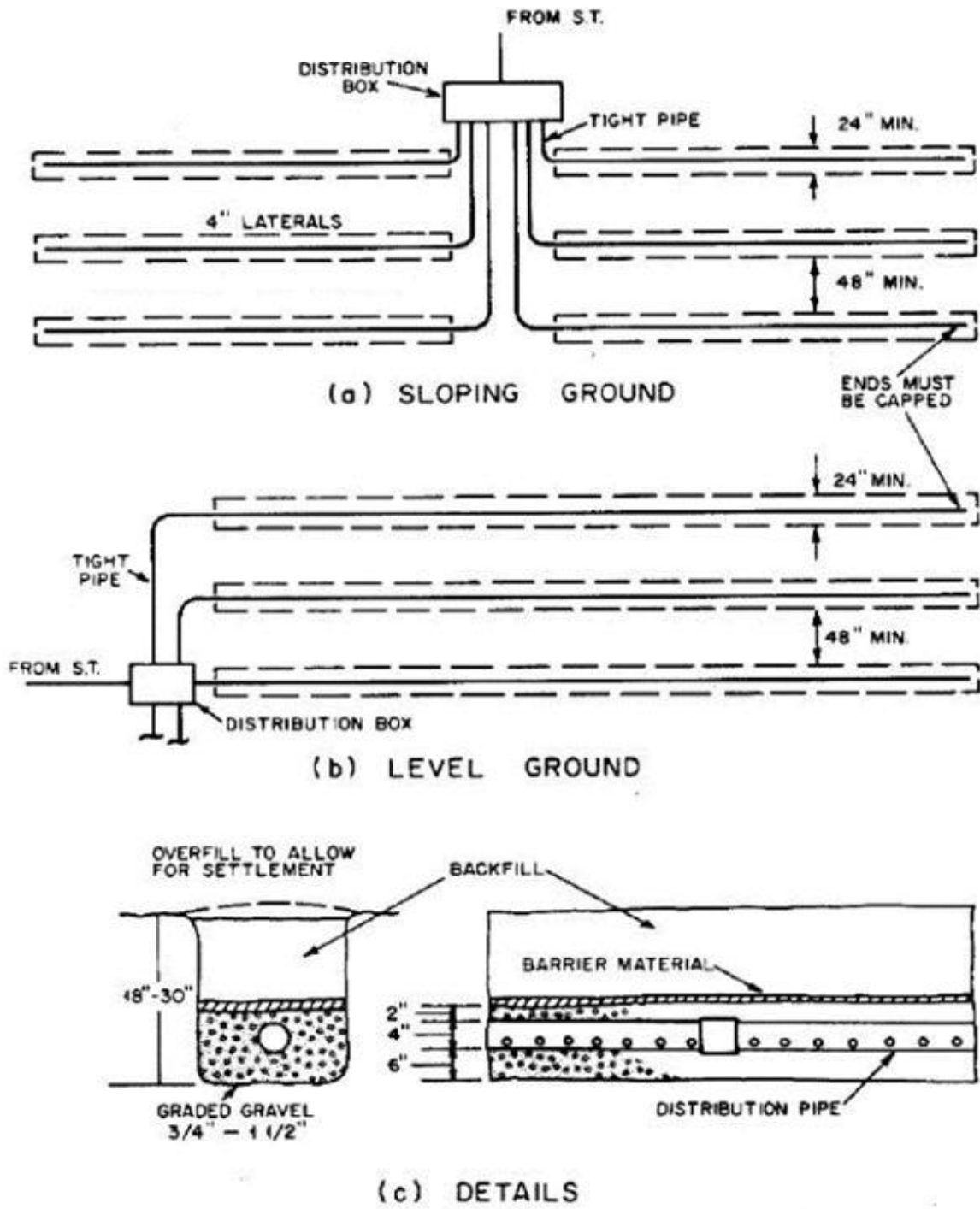
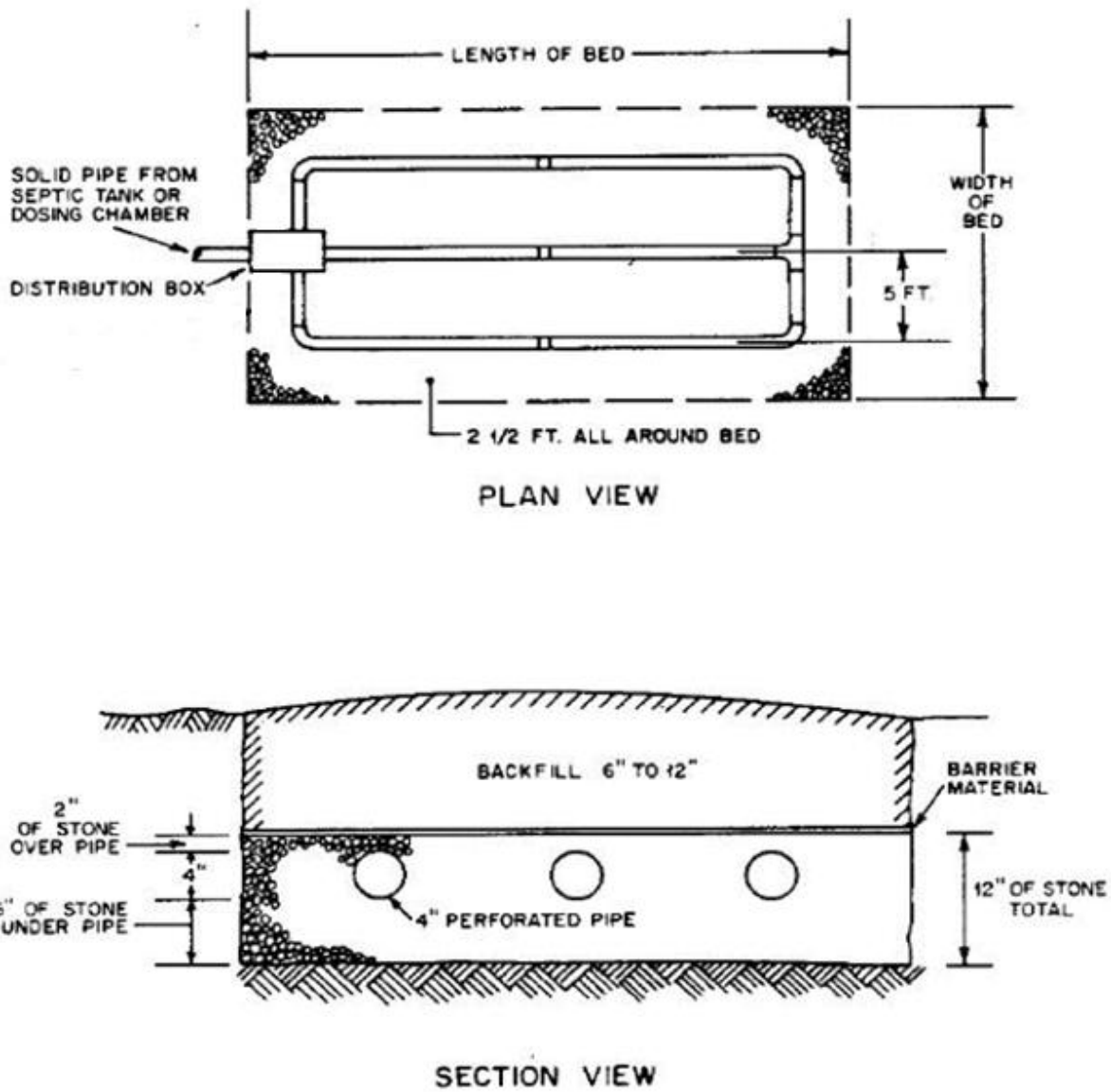

Figure E-6 Conventional Absorption Trench



**Figure E-7 Conventional Absorption Bed**

Total trench length should be sized in accordance with the application rates given in Table E-1 above and the design flow of the treatment system.

Application rates for absorption beds should be no more than 75 percent of the application rate given in Table E-1. Figure E-7 shows a looped distribution system in a conventional absorption bed. It is highly recommended that absorption bed systems be dosed.

The effective area for wastewater application will be the bottom area (only) of trenches or beds.

The design trench width should be 2', while the design bed width should be a minimum of 3'. The maximum width of an absorption bed should be 10' to 15', depending on soil characteristics. Soil types that hold more water reduce soil re-aeration pathways and increase groundwater mounding potential. Both of these tendencies combine to decrease the size and aerobic treatment capacity of the vadose zone between the bottom of the bed and the induced groundwater table, creating undesirable anaerobic conditions. Therefore, soils with smaller particles and more absorbent structures, such as silt or clay, require a more narrow maximum bed width, while soils with larger particles and less absorbent structures, such as sand, allow for a larger maximum bed width. Trench depth should be between 18" and 30"; in most cases, depths of less than 24" are preferred. Bed depth should be between 18" and 24".

Because it has been shown that the aggregate actually transmits wastewater, laterals up to 100' are acceptable. Longer lengths may be permitted if site conditions allow. Pressurized distribution or dosing are recommended if laterals are longer than 60', and are strongly recommended if laterals are longer than 100'.

The minimum distance between walls of adjacent trenches should be 4'. Separations of 6' are desirable to provide additional aerated soil for the horizontal flow component of sewage between trenches. Trenches should be laid out parallel to site contours. When stepped trenches are used, it is important that the first length of all distribution lines leading from the distribution box to the trenches be laid with the same slope. The bottom of the trench should be dug level in longitudinal and transverse directions and should be raked prior to placement of washed gravel or crushed stone. In a dosed or pressurized trench system, distribution lines should be level; otherwise a slope of between 1/32" /foot and 1/16" /foot (0.25 to 0.5 percent) should be maintained. The ends of laterals should be capped.

For beds, center-to-center spacing of distribution pipes should be 3' to 5'. The floor of the bed and the distribution lines should be level and the ends of the laterals should be interconnected. Distribution systems should be hand-leveled. At least 6" of graded gravel should be placed beneath the distribution pipes, and an additional 2" should be placed above the pipes. A barrier material should be placed above the stone to prevent backfill from clogging the aggregate. This material may be synthetic drainage fabric (permeable geotextile) or for systems under 1,000 gallons per day, untreated building paper. Backfill over the barrier material should be at least 6" and no more than 12" deep, and should consist of natural soil.

Absorption trenches/beds should not be built under paved areas. Staking/taping off of the site during and prior to construction will help keep the soil below and adjacent to trenches/bed undisturbed, aiding long-term operation of the STS. Also, every effort should be made during construction to avoid smearing or

compacting of the bottom area or side walls. Backfilling should be done carefully to avoid pipe breakage or deformation.

## **E. 9 Shallow Absorption Trenches**

---

### Shallow Absorption Trenches

---

Shallow absorption trenches are particularly useful in areas where permeable soil is present above moderately high groundwater, bedrock, and/or an impermeable layer. The site evaluation (see Section B) should show there will be sufficient depth to these boundary conditions from the bottom of the proposed system. Construction and sizing should be the same as for conventional absorption trenches, except the trench should be only 6" to 12" deep as shown in Figure E-8. Backfill above the system should be of, or similar to, the native soil. Side slopes of the resulting hummock should be no steeper than 3' horizontal to 1' vertical. Horizontal separation distance is measured from the toe of the slope. If enhanced treatment or enhanced treatment with disinfection is provided, the Reviewing Engineer may allow the separation to be measured from the edge of trench.

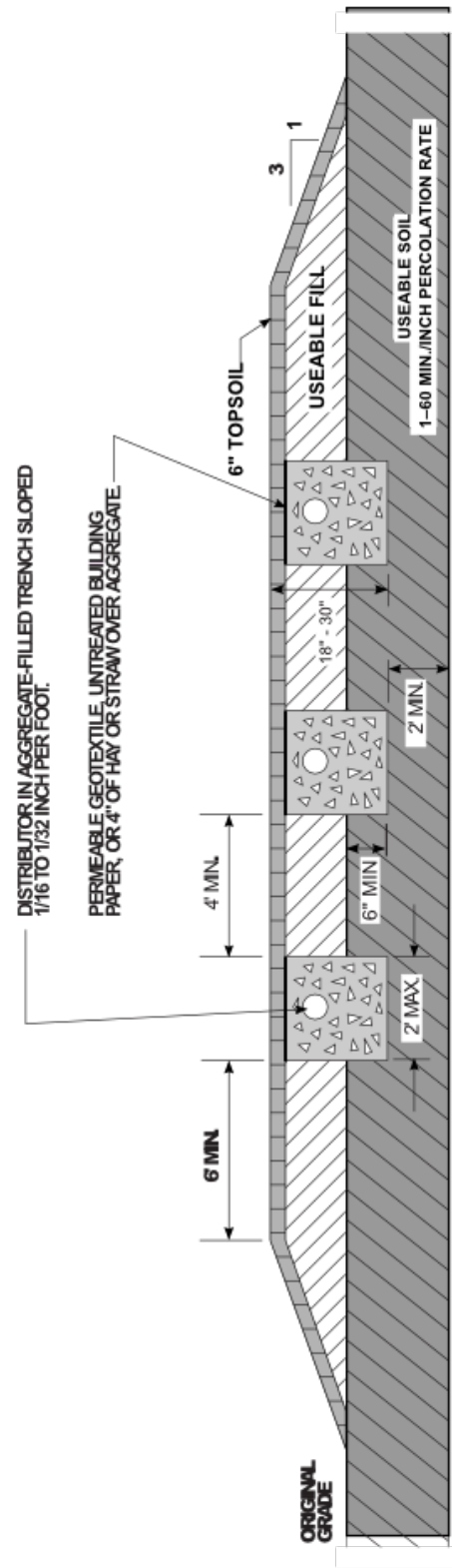

- NOTES:**
1. Bottom of all trenches shall not be above original useable soil and should preferably be at least 6" below original grade.
  2. Useable fill should have a percolation rate similar to but not faster than the useable soil percolation rate.
  3. Maximum depth of useable fill plus six (6) inches of topsoil shall not exceed 30 inches.
  4. Trench bottoms shall be level. Trenches shall be parallel to ground contours.
  5. On sloped sites, a diversion ditch shall be constructed uphill from the fill to prevent surface runoff from entering the fill.
  6. Extend fill at least six (6) feet beyond ends of trenches before starting 1 on 3 edges of fill.
  7. Heavy equipment shall be kept out of the absorption area.
  8. Fill material is carefully placed within the absorption area.
  9. 4" vertical separation from bottom of trench to bedrock or impermeable strata is required.

Figure E-8 Shallow Absorption Trench

## E.10 Aggregate and Alternative Aggregate

Aggregate provides sidewall support, wastewater storage, and void space allowing oxygen to reach the infiltrative surface. Though traditional systems have used conventional aggregate, alternative aggregates are being introduced in the wastewater treatment industry. Common to both traditional and alternative aggregates is the filter fabric used to encapsulate the aggregate and prevent migration of backfill material into void spaces.

Aggregate is defined as washed gravel or crushed stone  $\frac{3}{4}$ " to 1- $\frac{1}{2}$ " in diameter. Larger diameter material and bank run gravel are unacceptable. Fines passing the #200 sieve should be less than 5 percent by volume; less than 3 percent is preferred.

Alternative aggregates may be manufactured or recycled solid waste. The alternative aggregate used must provide at least the equivalent soil infiltration area and storage volume as conventional gravel or stone aggregate. It may be used to substitute conventional gravel or stone aggregate on a one-to-one volumetric basis.

- Manufactured alternative aggregate must be made using materials that are inert with respect to waste water.
- Alternative aggregate made from recycled solid waste must be approved by NYSDEC and have a written beneficial use determination (BUD) from NYSDEC that allows a manufacturer to produce and offer for sale alternative aggregate to be used in onsite wastewater treatment systems. The alternative aggregate must be used in accordance with the specifications of the BUD.
- Tire-Derived Aggregate (TDA) is a recycled solid waste that may be used an alternative aggregate when the TDA manufacturer has a written BUD from NYSDEC. Properly manufactured tire chips have physical characteristics similar to conventional gravel or stone aggregate. The TDA must be used in accordance with the specifications of the BUD.

The aggregate (alternative or conventional) should be covered with a material that prevents soil from entering after backfilling, yet permits air and liquid to pass through. The preferred material for covering the aggregate is a permeable geotextile. Untreated building paper is acceptable only for systems under 1,000 gpd. Polyethylene and treated building paper are relatively impervious and should not be used.



## **E.11 Gravelless (Aggregate-Free) Absorption Systems**

Gravelless absorption systems are designed to receive wastewater from a septic tank or other treatment unit and transmit it into the soil for additional treatment and dispersal. All requirements of Sections E.1 through E.3, Section E.7, and the Advisory for Fast Soils in Specific Aquifers are applicable to all gravelless absorption systems. Allowable soils for gravelless absorption systems include those soils suitable for conventional, shallow trench, or shallow narrow (pressurized) drainfields with the specified degree of pre-treatment. All gravelless systems should be capable of withstanding typical construction equipment and residential-use loads without deformation.

No reduction in field size is allowed for gravelless wastewater distribution products used for new construction. For gravelless wastewater distribution products, septic tank effluent should be filtered.

### **E.11.a Allowance for Reduction in Field Size for Renovations on Existing Properties**

Certain instances may arise such that a reduction in field size is necessary due to space constraints for an existing failing system. Under these circumstances, the Department may approve a reduction in field size pending the Reviewing Engineer's approval. To approve a reduction of field size, the Department requires the septic effluent to receive secondary or greater treatment before discharging to the gravelless wastewater distribution system. The percent of field size reduction should be in accordance with the manufacturer's recommendation for that specific gravelless wastewater distribution product. The Department should be contacted prior to construction regarding the acceptability of specific products for use as a gravelless distribution system, as well as the allowable percent reduction in field size. Gravelless wastewater distribution products used to serve facilities where a reduction in field size may be allowed must still meet the design, sizing, material and construction specifications of Section E.11.b of these Standards, or an equivalent design must be provided by the design engineer.

### **E.11.b Specifications for Gravelless (Aggregate-Free) Absorption Systems**

The use of gravelless absorption system technology has increased since the last update of these Design Standards. The technology is easier to install compared to other more traditional technologies.

- A. Site requirements: These systems should be used on sites that have been classified as having a design percolation rate of 1 to 60 mpi and meet statewide vertical separation distances and

horizontal separation distances found in Table B-2 of these Standards.

## B. Design Criteria

1. Open-bottom gravelless chambers or galleys may be installed without aggregate backfill. One linear foot of these products is equivalent to one linear foot of conventional (24"wide) absorption trench. The product should have:
  - a. Open-bottom infiltration area of 1.6 square feet per linear foot
  - b. Volumetric capacity of 7.5 gallons per linear foot
  - c. Open side-wall area for aeration and infiltration.

In fine granular soils, chambers or galleys may need a water-permeable, geotextile fabric draped over the chamber or galley to prevent infiltration of backfill soils into the void space below.

2. Gravelless, media-wrapped, corrugated pipe, sand-lined systems may be installed. One linear foot of these products is equivalent to one linear foot of conventional (24" wide) absorption trench. The product should be:
  - a. Made of corrugated plastic pipe with a minimum diameter of 12"
  - b. Wrapped in a media that allows wastewater dispersal and prohibits sand infiltration  
AND
  - c. Installed with a minimum of 6" of washed concrete sand surrounding the pipe or pipe assembly (Sand that meets ASTM specification C33 is recommended.)
3. Gravelless geotextile "sand" filters may be installed. Pressurized distribution is recommended for these systems. Soil treatment area designs may use a trench bottom sizing criteria of 6 square feet per linear foot of trench when the product demonstrates the following features and criteria:
  - a. Unit width of 3'
  - b. Unit storage capacity of 12 gallons per linear foot
  - c. Six inches of sand installed below and on the sides of each unit (Sand that meets ASTM specification C33 is recommended.)

## C. Construction requirements:

1. Gravelless trench sidewalls should be separated by a minimum of 4' of undisturbed soil. For absorption bed applications, follow requirements and recommendations of Section E.2

Application Rates and E.8 Absorption Trenches and Beds in these Standards, and manufacturer recommendations.

2. All gravelless trenches should be equal in length. Total trench length should be increased if necessary.

## **E.12 Cut-and-Fill Systems**

---

### Cut-and-Fill System Design Considerations

---

A Cut-and-Fill STS may be used only for sites where:

- Slowly permeable soils (slower than 60 mpi percolation rate), such as clay or clay loam, overlie more permeable useable soils (1 to 60 mpi)  
OR
- Soils are so rapidly permeable (1 mpi percolation rate or faster) that insufficient treatment occurs before wastewater reaches bedrock or groundwater.

For sites with slowly permeable soils overlying more permeable useable soils, the design should provide for removal of the overlying unusable soil and replacement with fill soil having a percolation rate and texture comparable to the underlying usable soil. The site evaluation (see Section B, including groundwater mounding analysis) should show the:

- Required depth of usable soil exists below the unusable soil
- Minimum required vertical clearance exists between the bottom of the proposed bed and seasonally high groundwater
- Minimum required vertical clearance exists between the bottom of the proposed bed and the bedrock, or impermeable layer

Refer to Figure E-9, Cut-and-Fill System.

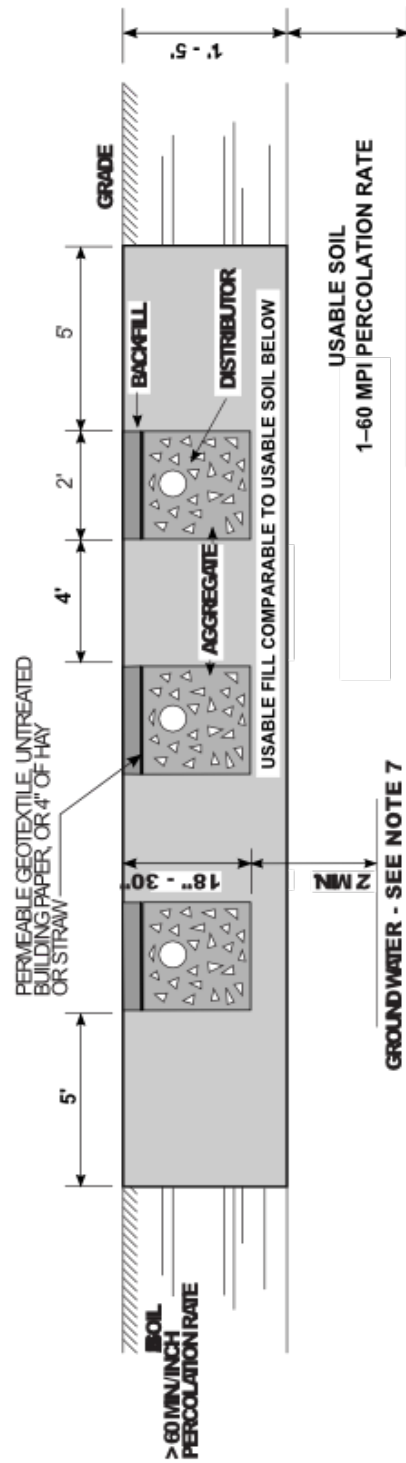

- NOTES:**
1. On sloped sites, a diversion ditch should be constructed uphill from the fill and trench area to prevent surface runoff from entering the absorption area.
  2. A Soil Layer with a percolation rate slower than 60 minutes per inch, such as clay or clay loam, overlays a useable soil with a percolation rate between 1 and 60 mpi.
  3. The design and construction of the system should provide for the removal of the overlying unusable soil and replacement by soil having a percolation rate comparable with the underlying soil.
  4. The required length of absorption trench is based upon the percolation of the underlying soil or the fill material, whichever has the slower percolation (lower permeability).
  5. The area excavated and filled must provide at least a five (5) foot buffer in each direction beyond the trenches.
  6. Original unuseable soil should not be used as backfill above the trenches.
  7. A minimum of 4" vertical separation from bottom of trench to bedrock or impermeable strata is required.
  8. If the bottom of all trenches are not in or at the permeable underlying soils (i.e. the bottoms are in fill), the fill should undergo stabilization and testing prior to constructing the trenches.

Figure E-9 Cut-and-Fill System

The necessity of installing curtain drains, under drains, or vertical drains to prevent the flow of water into the filled area from shallow, laterally flowing groundwater or perched water tables should be investigated. Figure E-13 shows some examples of these drainage methods. These systems are generally used where the impermeable overlaying soil is 1' to 5' deep. Conventional absorption field systems may be used when the overlaying impermeable soil is no more than 1' deep and usable soil is placed above the aggregate.

For sites with rapidly permeable soils, replacement fill material should have a percolation rate of 10 to 30 mpi and should extend to a depth of at least 2' below the bottom of the proposed trench. The filled area should extend at least 5' in each direction from the sidewalls of the proposed trenches as shown in Figure E-9 above, to allow some lateral movement of wastewater.

Horizontal separation distances should be maintained as described in Table B-2 of these Design Standards. Minimum vertical separation distance to groundwater and bedrock or impermeable layer should be as described in section B.4a.

---

#### Cut-and-Fill System Construction

---

If the fill depth is greater than 4', the fill should be allowed to settle (stabilize) before construction. Depending on fill type and depth, as much as a full year may be necessary for natural settling. To avoid a delay in construction, fill material (if it is granular sand or sandy loam) may be spread in 6" lifts and mechanically compacted, but care should be taken to avoid creating layers of different density.

Coarse sands and gravels (up to a maximum size of 1-½") should settle to at least 85 percent of the standard proctor density. Fine sands, silty sand, sandy clay, and sandy loam should settle to at least 90 percent of the standard proctor density. The percent standard proctor density can be determined by measuring the in-place dry density of the fill (using ASTM Test Method D1556) and dividing the result by the maximum dry density of the fill (ASTM Test Method D698). An alternative testing method for soil density (as specified by ASTM) may be acceptable if it can be shown to be more appropriate to local conditions.

A Cut-and-Fill system should be constructed as follows:

- The area excavated and filled should provide at least a 5' buffer in each direction beyond the trenches.
- Careful excavation is necessary to assure the usable underlying soil is not made unusable through compaction, and impermeable overburden does not remain in the bottom of the excavation (i.e., on top of the permeable underlying soil).

- Construction and sizing of the trenches in the fill should be the same as for conventional absorption trenches.
- A conventional absorption field system (i.e., trenches with distribution lines and aggregate or gravelless distribution components) is constructed in the upper 18" to 30" of the permeable fill/underlying soil. The required length of absorption trench is based upon the percolation rate of the underlying soil or the fill material, whichever has the slower percolation rate (lesser permeability).
- Material placed above trenches should have the same percolation rate as the imported usable fill. Original surface material with a percolation rate slower than the fill should not be used as backfill above trenches.
- The surface area of the fill system should be graded to enhance runoff of rainwater from the system and seeded to grass. On sloped sites, a diversion ditch or berm should be constructed on the uphill side of the fill area to prevent entrance of surface runoff

---

#### Cut-and-Fill System Distribution

---

Dosing or pressure distribution is highly recommended for all Cut-and-Fill systems to achieve uniform distribution throughout the absorption area and thus ensure adequate treatment of wastewater. If the percolation rate of the fill is between 1 and 10 mpi, dosing or pressure distribution is required.

### **E.13 Raised Systems**

---

#### Raised System Design Considerations

---

A Raised System is an absorption trench system constructed in fill material with acceptable permeability placed above the natural soil on a building lot. This system relies on treatment in both the fill material and the natural soil. A Raised System designed as shown in Figures E-10A & E-10B should have the following design attributes:

- Vertical separation between the bottom of the proposed trench and any impermeable soil layer or bedrock should be 4'.
- Vertical separation between the bottom of the proposed trench and the seasonal high groundwater level should be at least 2'.
- Existing site slope should not exceed 15 percent.

- Pressure distribution of effluent is highly recommended for a raised system to enable more uniform distribution of effluent in the fill material, where potentially uneven compaction may occur during construction.

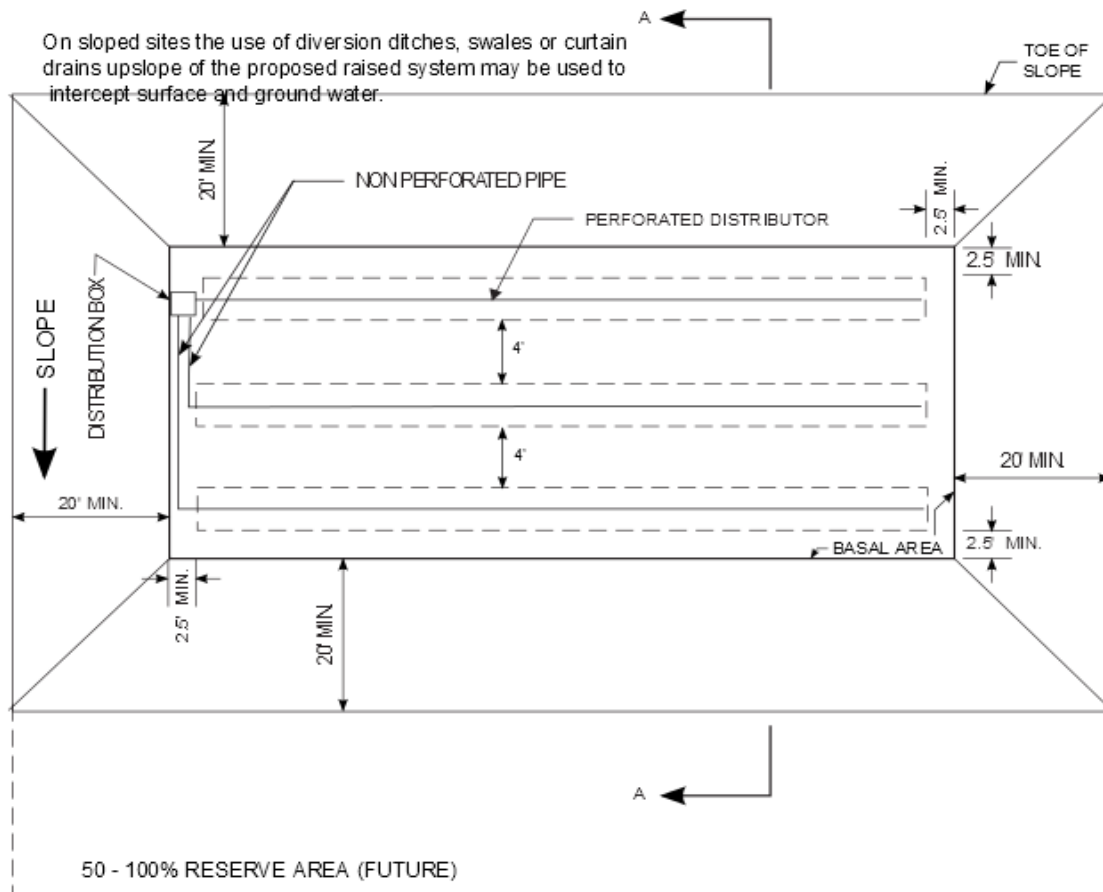

- NOTES:**
1. There is at least one foot of original soil with faster than 60 minutes percolation rate, above any impermeable soil layer or bedrock, but not more than two feet.
  2. The maximum high groundwater level must be at least one foot below the original ground surface.
  3. Slopes shall not exceed 15%.
  4. Fill material with a percolation rate of between 5 - 30 min/in. with a sand or sandy loam 5 - 10 min/in. preferred.

**Figure E-10A**

**Raised System Plan View**

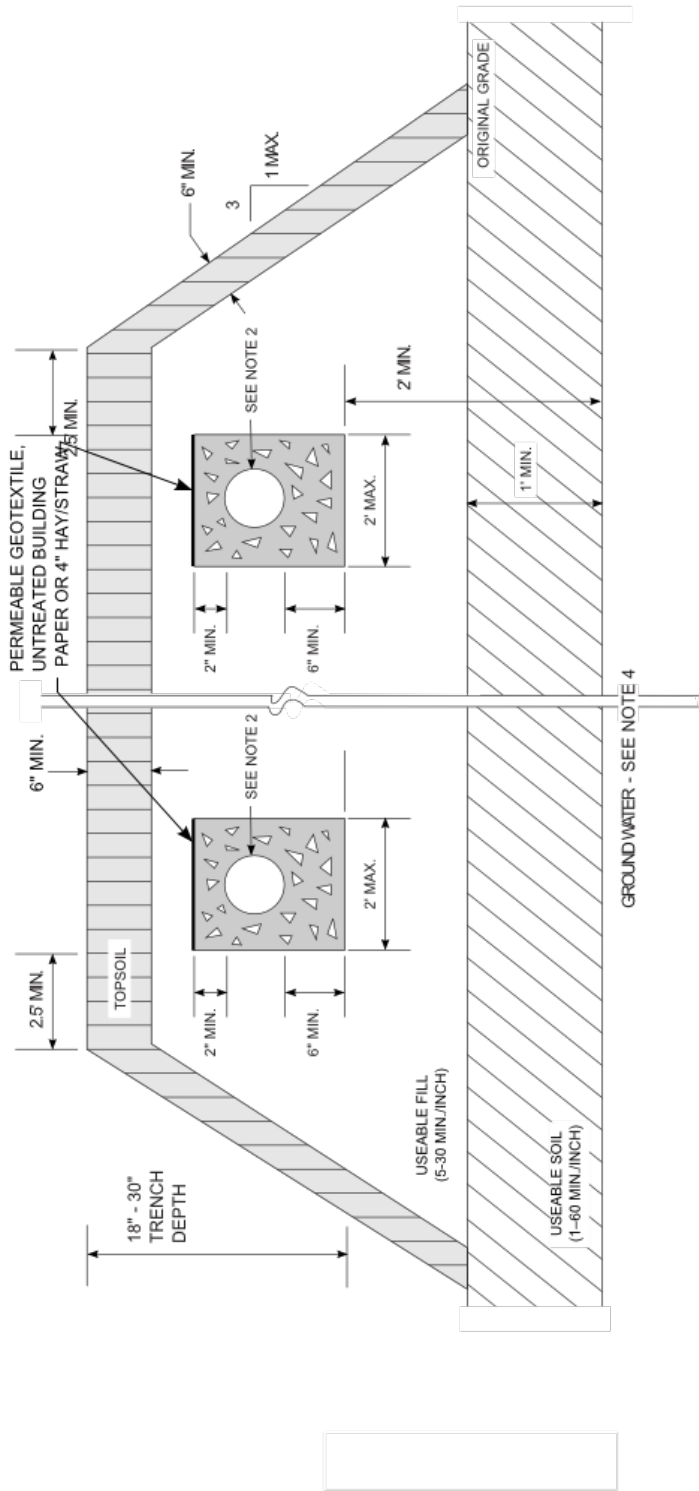

Figure E-10B

Raised System Section View



A raised system should be designed as follows:

- Percolation tests should be conducted in the fill material at the borrow pit and after placement and settling at the construction site. The slower percolation rate of these tests should be used for design purposes.
- Sufficient fill material with a percolation rate of between 5 and 30 mpi is needed to maintain at least 2' separation between the proposed bottom of the trenches and the seasonal high groundwater level, and 4' of separation between the proposed bottom of the trenches and bedrock, clay or other relatively impermeable soil or formation.
- The total area beneath the absorption trenches, extending 2.5' in all directions from the outer edge of all trenches, is defined as the basal area. The minimum size of the basal area of the raised system should be calculated based upon an application rate of 0.2 gpd/sq. ft. A conventional absorption trench system as described in Section E.8 should be designed using the percolation rate of the fill material. The use of slowly permeable soils for the fill material will result in a trench system that will have a basal area larger than the minimum area calculated by using 0.2 gpd/sq. ft. No reduction of the minimum size of the basal area of a raised system may be claimed based upon use of a treatment system providing secondary or tertiary treatment.
- The edge of the fill material should be tapered at a slope no greater than one vertical to three horizontal, with a minimum 20' taper.
- Horizontal separation distances should be measured from the outside edge of the taper.

---

#### Raised System Construction

---

Raised systems should be constructed as follows:

- Raised systems should not be constructed during wet conditions or in wet fill.
- Heavy construction equipment should not be allowed within the area of the system. The underlying soil should be undisturbed, although the surface may be plowed with the furrow turned upslope.
- A system should not be built in unstabilized fill material. The fill material should be allowed to settle naturally for a period of at least six months to include one freeze-thaw cycle, or may be stabilized by mechanical compaction in shallow lifts if fill material consisting of only a granular sand or sandy loam is used.
- Absorption trenches are to be constructed in the fill material.
- The entire surface of the system including the tapers should be covered with a minimum of six

inches of topsoil, mounded to enhance the runoff of rainwater from the system and seeded to grass.

- On sloping sites, a diversion ditch or curtain drain should be installed uphill to prevent surface water runoff from reaching the raised system area. Curtain drains should be upslope from the system and at least 20' from the toe of the soil-fill slope.

## **E.14 Mound Systems**

A mound is a soil absorption system elevated above the natural soil surface in fill material. While a Raised System relies upon both fill material and existing natural soil for treatment, a mound system relies on only fill material to provide treatment and existing natural soil for wastewater dispersal. Mounds may be used when conditions preclude the use of a conventional absorption system. These conditions include slowly permeable soils, shallow soils over bedrock, and soils with high water tables. Using mounds is discouraged. They should be used only when no other method of subsurface disposal is feasible. For the mound system design, approval by the Reviewing Engineer may be necessary.

The design of a mound is complicated and should be done only by a licensed professional engineer experienced in designing mounds. The services of a qualified hydrogeologist or other soil scientist may also be necessary. Guidelines provided by the University of Wisconsin Small Scale Waste Management Project<sup>46</sup> should be considered when designing a mound, although requirements and allowances herein should supersede them.

Failure or success of a mound is highly dependent on construction quality. It is strongly recommended the design engineer provide for continual surveillance of construction activities. Certain jurisdictions may restrict or prohibit the use of mound systems.

---

### Site Evaluation

---

Table E-2 recommends site characteristics for mound systems. Systems less than 5,000 gpd are small mound systems. Systems greater than 5,000 gpd are large mound systems and require more detailed design considerations.

---

<sup>46</sup> James C. Converse and E. Jerry Tyler, 2002. *Wisconsin Mound Soil Absorption System: Siting, Design and Construction Manual*, Small Scale Waste Management Project Guidance Document #15.24; University of Wisconsin-Madison

Soils and site testing should be sufficient to characterize the hydraulic capacity of the site to treat and transmit flow, determine the ultimate destination of groundwater (wells, surface water, etc.), and demonstrate that groundwater and its ultimate use will not be adversely impacted. For small mound systems, at least two percolation tests for every 1,000 sq. ft. of basal area should be performed in holes spaced uniformly. At least one backhoe pit should be dug to accurately establish the nature of the subsurface layers and maximum groundwater level. If soil strata are variable across the site, core samples may be required to verify soil conditions in the backhoe pit(s). Section B.4 also has specific percolation test depths for mounds.

For large mound systems, an extensive site evaluation is recommended. It should be sufficient to establish infiltration rate, vertical and horizontal saturated hydraulic conductivity, zones of permanent and perched water tables, and groundwater conditions for each soil horizon present.

**Table E-2 Recommended Site Characteristics for Mounds**

Parameter	Criteria
Recommended range of native soil percolation rate	60 mpi to 120 mpi
Depth to high water table from existing ground surface	12 inches
Depth to bedrock or impermeable layer from existing ground surface	3 feet <sup>47</sup>
Maximum site slope	15%

---

Mound Construction Materials

---

The aggregate should be ¾" to 2½" non-deteriorating rock or crushed gravel. Geotextile drainage fabric is preferred as a barrier material for all mounds. Untreated building paper may also be used for small systems. Cap soil should be a finer-grained permeable material such as topsoil, silt loam, or clay loam. Good quality

---

<sup>47</sup> Less than 3' may be allowed for very small facilities (under 2,000 gpd) if the design engineer provides substantial proof that the site has the hydraulic capacity to treat and transmit the flow.

topsoil should be used to cover the entire mound. Percolation tests for the fill material should be conducted at the borrow pit in areas representative of the soil to be obtained. Following is a recommended fill specification for mounds. A sieve analysis is recommended and may be necessary to verify compliance with soil specifications.

<b>RECOMMENDED MOUND FILL SPECIFICATIONS</b>	
Percolation rate	5 to 30 mpi (5 to 10 mpi preferred)
Fine material (silt, clay)	Less than 10 % by weight (#200 sieve)
Course material (stone, gravel)	Less than 15 % by weight (½ inch mesh sieve)
Medium to Course Sand	At least 25 % by weight (#35 sieve to #10 sieve)
Effective Grain Size	0.15 to 0.30mm
Uniformity Coefficient	4 to 6

---

#### Mound Design General

---

Beds or trenches should be oriented along the site contour or along the contour of the bedrock if it is shallow and sloped differently from the ground surface. Trench/bed bottoms should be level. Figure E-11 shows the configuration of a typical mound. Figure E-12 shows one possible subsurface flow pattern.

Fill should be placed to maintain a minimum of 3' of unsaturated soil depth for treatment. This distance should be increased to 4' over the impermeable layer.

To form the absorption area, at least 6" of aggregate should be placed below the distribution pipe, and at least 2" should be placed above the pipe. The size of the absorption area should be based on daily wastewater flow and the recommended infiltration rate of the fill material. The width of the absorption area should not exceed 15'.

Permeable barrier material (cap and topsoil) should be placed above the fill and aggregate. The cap and topsoil should be at least 1.5' thick at the center of the absorption area, and at least 1' deep over the edges of the absorption area. Topsoil should be at least 6" deep over the entire mound. Mound slopes should be no steeper than 3 horizontal to 1 vertical.

Use of groundwater monitoring wells and observation vents in the gravel bed should be considered for monitoring system performance.

---

## Mound Design - Small Systems

---

The important design feature is the basal area, which is the total area beneath the mound for level sites ( $L \times W$ ) and the down slope area for sloped sites ( $B \times [A + I]$ ). See Figures E-11 and E-12. The required basal area should be determined by the infiltration rate of natural soil, but may need to be increased to maintain appropriate side slopes. Recommended loading rates from Table E-1 should be used for sizing the basal area.

---

## Mound Design - Large Systems

---

Large system design is based on determining maximum vertical and horizontal hydraulic acceptance of the land, and designing within this limit. Major steps to be followed are to:

1. Evaluate the site to identify predicted wastewater flow zones in the soil.
2. Establish the horizontal and vertical boundaries of the system, and determine the boundary acceptance rates.
3. Determine vertical wastewater application width based on vertical and horizontal boundary acceptance rates.
4. Determine the linear loading rate based on vertical and horizontal acceptance rates. This is the maximum acceptance rate per linear foot and should not be exceeded.
5. Determine the basal width of each horizon beneath the mound based on the linear loading rate and the vertical acceptance rate of each horizon. The basal width of the surface horizon will determine placement of the mound toe. The STA should be constructed so ground surface around the mound diverts any runoff away from it. Also, there should be no other construction within the footprint of the mound, including such things as driveways, foundations or ditches.
6. Determine absorption trench/bed width based on the linear loading rate and mound fill infiltration rate.
7. Determine trench/bed length based on the design flow rate and the linear loading rate.

Refer to the *Wisconsin Mound Soil Absorption System: Siting, Design and Construction Manual* (2000) for more detailed information and Appendix E.2 for a design example from the same document.

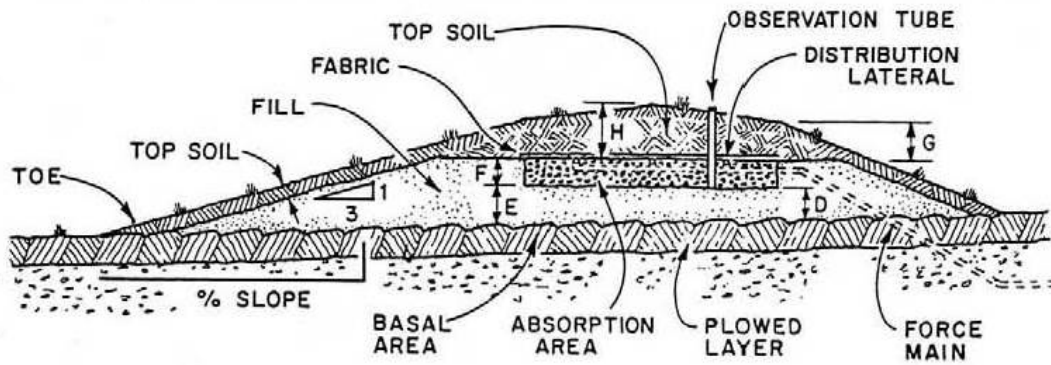

**Section View**

*(Side and slope are not drawn to scale)*

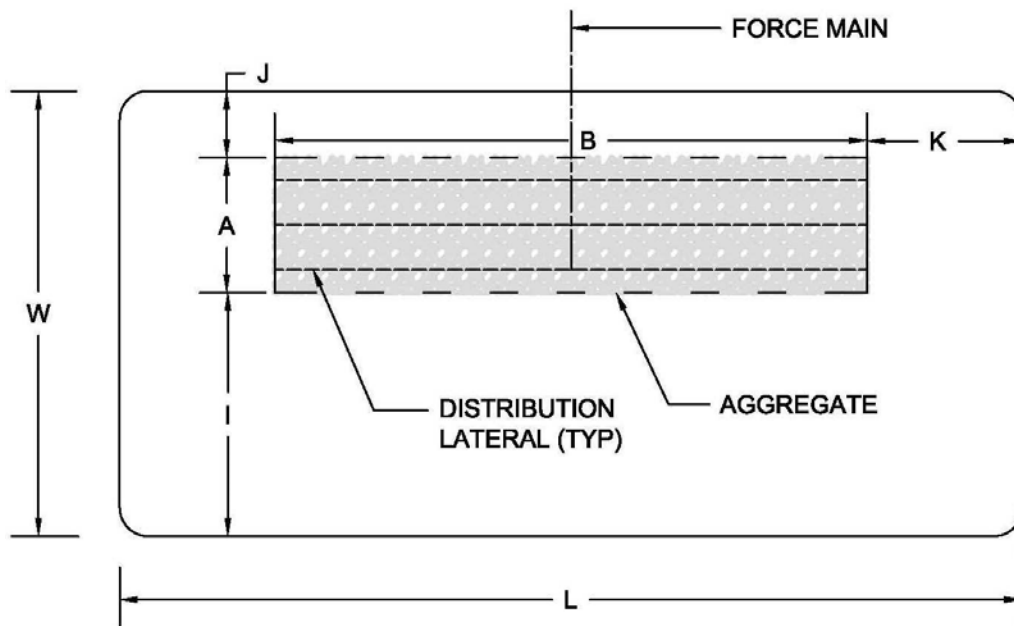

**Plan View**

**Figure E-11**

**Mound Configuration**

**Figure E-12 Horizontal and Vertical Wastewater Travel in a Mound**

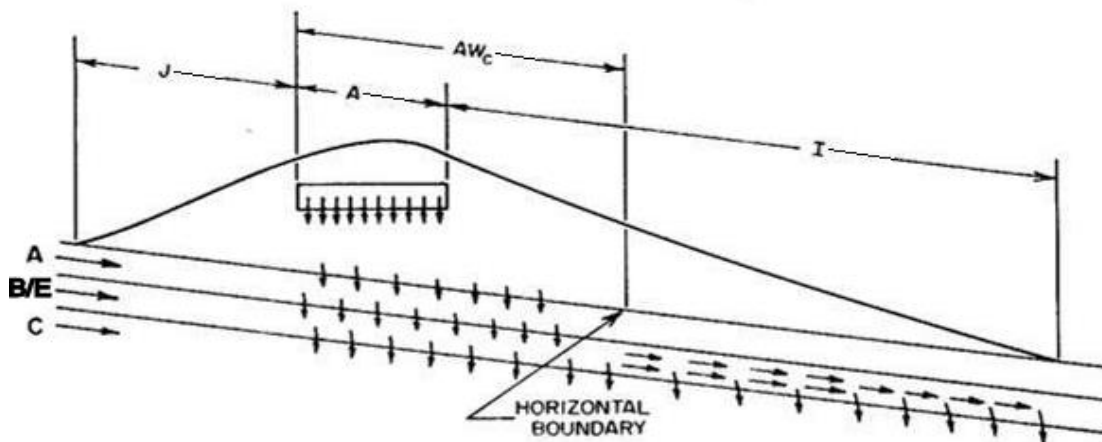

---

Distribution Systems in Mounds

---

Pressure distribution networks are recommended for all mound systems, and are strongly recommended for large systems. The pump should be able to provide 2' of head at the distal end of the laterals.

Table E-3 lists recommended lateral lengths for several pipe diameters and hole-spacing. There should be one lateral per trench, and no more than three laterals per bed.

Mounds should be dosed as frequently as practicable to ensure uniform distribution without hydraulic overloading. Dosing volume should be at least five and up to ten times the total lateral pipe volume.

**Table E-3 Recommended Lateral Lengths Based on Hole-Spacing and Hole Diameter**

Hole Spacing	Hole Diameter	Pipe Diameter		
		1"	1¼"	1½"
Inches		Lateral Length (feet)		
30	3/16	34	52	70
	7/32	30	45	57
	¼	25	38	50
36	3/16	36	60	75
	7/32	33	51	63
	¼	27	42	54

Soil moisture at about 7" depth should be checked before construction. If the soil can be rolled into a ribbon between one's hands, it is too wet, and construction should be postponed.

Trees should be cut to the ground, leaving stumps in place. Excess vegetation should be mowed.

The mound site should be plowed along the contour with a mold board or chisel plow to a depth of 7" to 8". Rototillers should not be used except on sandy soils.

Fill should be placed on the upslope and side edges of the mound site. Immediately after the site is plowed, fill should be pushed into place using a small track-type tractor with a blade. A minimum of 6" of fill should be kept beneath the tracks at all times to minimize soil compaction.

Fill should be placed to the desired depth and the side slopes shaped. The trench/bed can then be formed with the tractor blade. The bottom of the absorption area should be hand leveled before aggregate is placed.

Every effort should be made to minimize traffic on the construction site, especially on down slope areas. No truck wheels should be allowed on the plowed area. For further guidance on construction of mounds, refer to the *Wisconsin Mound Soil Absorption System: Siting, Design and Construction Manual* (2000).

### **E.15 Artificially Drained Systems**

Artificial drainage lowers high water tables and allows the use of subsurface disposal techniques. Successful design depends on correct diagnosis of a drainage problem. Four general types of drainage problems are possible: 1) free water tables, 2) water tables over leaky artesian aquifers, 3) perched water tables, 4) lateral groundwater flow. The initial site evaluation should be extensive enough to distinguish among these problems. Drainage of an artesian-fed water table should not be attempted.

Shallow, lateral flow problems are the easiest to correct. Curtain drains or vertical drains can be used for this situation. Perched water problems can be corrected using vertical drains or curtain drains. Vertical drains should be used only when the restrictive soil layer is thin and overlies permeable soil. Vertical drains are not generally recommended because of concerns about groundwater quality of deeper aquifers. Figure E-13 shows some examples of these drainage methods.



It is recommended a drainage system be installed and its effectiveness tested prior to approval of sewerage plans. Effectiveness should be tested during spring months because the water table is typically highest then due to spring runoff and snow melt. Effectiveness testing of artificial drainage can be accomplished by monitoring the depth to the groundwater table at the STS site. The drainage system is effective when the perceived groundwater elevation is at least 2' below the bottom of the proposed trench.

Minimum horizontal separation distances given in Table B-2 for interceptor drains should be maintained between the drain and the absorption system for larger private, commercial and institutional systems where significant delivery periods, high flows and 24-hour operation are likely. Nonresidential OWTs with daily flows under 1,000 gpd may use 20' separations.

Drain outlets should be protected from entry by small animals and should prevent entrance of floodwaters where submergence may occur. Outlets should be designed to prevent erosion.

Porous media such as gravel should be placed in drains to a level above the high water table. Fill material at the ground surface should be fine textured to prevent entrance of surface water. A geotextile layer should be used between gravel and fill material. Surface inlets via pipes should be avoided.

It may be necessary to surround drainage pipes with an envelope filter to prevent clogging. The envelope filter may be an aggregate (gravel and/or sand) filter or a geotextile (fabric filter). Aggregate size or pore size for the geotextile is critical to the functioning of the filter. Also, geotextiles should be chemically compatible with local conditions.

Relief pipes and/or breathers may be necessary on long curtain drains or underdrains.

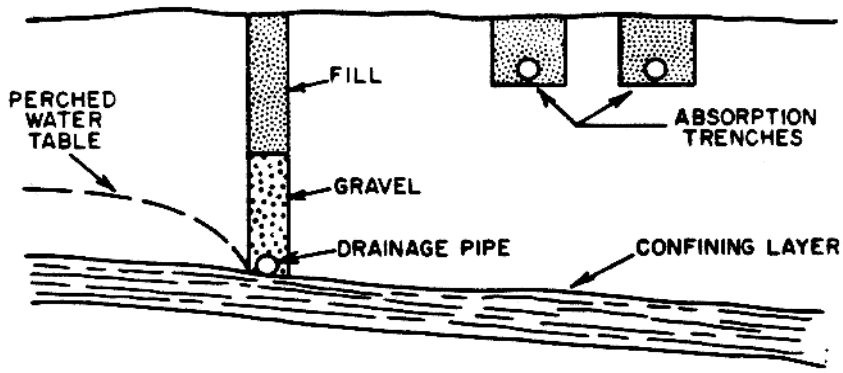

A) CURTAIN DRAIN

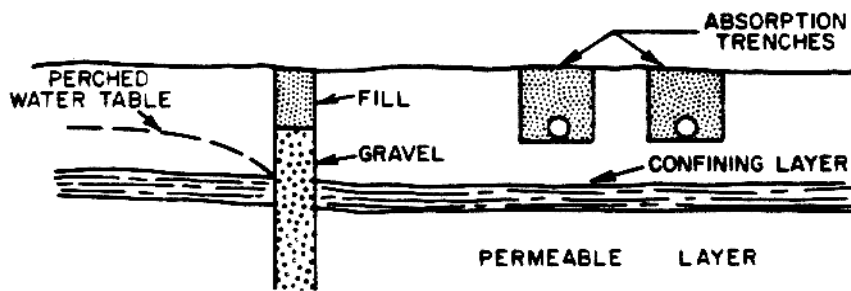

B) VERTICAL DRAIN

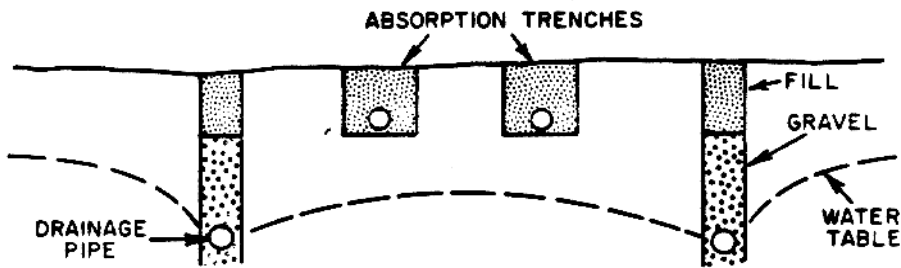

C) UNDERDRAINS

Figure E-13

Subsurface Drainage Methods

## E.16 Seepage Pits

Seepage pits are the least preferred STS, especially for larger facilities. Trenches are preferred for all systems where land is available. Seepage pits can be used for subsurface disposal of sewage where the soil below a depth of 2' or 3' is more porous than above this depth, and where the subsoil is fairly well drained. Seepage pits should be preceded by treatment at least equivalent to a septic tank. Figure E-17 shows a typical seepage pit.

Seepage pits should not be used where drinking water is obtained from shallow wells or where the percolation rate is slower than 30 mpi. If the percolation rate is faster than 5 mpi, seepage pits should not be allowed unless extensive pre-treatment is provided. Required pre-treatment may include biological treatment, de-nitrification and disinfection. Certain jurisdictions may restrict or prohibit use of seepage pits.

The site evaluation should show it is possible to maintain required depths (see Section B) to seasonally high groundwater, bedrock and/or an impermeable layer beneath the proposed system.

It is recommended that pits have an effective diameter at least equal to the depth of the pit. Effective diameter should not be under 6' in diameter. Only the sidewall area of the pit structure may be used for sizing the absorption area. Application rates for sizing the necessary sidewall area are given in Table E-1. Soil layers with percolation rates slower than 30 mpi should be excluded from the effective depth. The greater flow range of private, commercial and institutional flows, plus the possibility of significant delivery periods and 24-hour operation results in a preference for a greater infiltration rate, enhanced treatment requirements may be needed to protect groundwater. Table E-6 lists the effective absorption area of pits of various dimensions.

Where more than one seepage pit is required, pits should be arranged in groups running generally parallel to the site contour lines. The separation distance from sidewall to sidewall between seepage pits should be at least equal to three times the diameter of the largest pit. Piping from the septic tank should be so arranged as to distribute sewage uniformly among pits. Use of a distribution box with separate laterals each feeding no more than two pits is recommended. Pits may not be dosed in series, although an equalization pipe between them is considered desirable. Equalization pipes should be laid level and should be located in the lower half of the pit.

**Table E-4**

**Sidewall Areas of Circular Seepage Pits (square feet)**

Effective Strata Depth Below Inlet (feet)										
Diameter of Seepage Pit (feet)	1	2	3	4	5	6	7	8	9	10
3	9.4	19	28	36	47	57	66	75	85	94
4	12.6	25	38	50	63	75	88	101	113	126
5	15.7	31	47	63	79	94	110	126	141	157
6	18.8	38	57	75	94	113	132	151	170	188
7	22.0	44	66	88	110	132	154	176	198	220
8	25.1	50	75	101	126	151	176	201	226	251
9	28.3	57	85	113	141	170	198	226	254	283
10	31.4	63	94	126	157	188	220	251	283	314
11	34.6	68	104	138	173	207	242	276	311	346
12	37.7	75	113	151	188	226	264	302	339	377

For depths greater than 10', find the area by adding sections.

Example: Area of 15' deep pit = Area of 10' pit + Area of 5' pit.

All seepage pits should meet the following construction requirements:

- During excavation, smearing and compaction of the sidewall should be avoided.
- A layer of coarse gravel 6" to 12" deep should be placed in the bottom of the pit prior to placement or construction of the chamber.
- Precast concrete rings with large perforations are preferred for pit lining. Thickness of the seepage pit lining should be at least 8".
- Below the inlet pipe the space between the pit lining and the earth wall should be filled with clean crushed stone or washed gravel to a thickness of at least 12"; stone should be 1½" to 2½" in diameter. Any area between the lining and the wall that is filled with media smaller than 1½" should not be

included as part of the effective diameter. A layer of synthetic drainage fabric or untreated building paper should be placed on top of the gravel before soil is backfilled.

- The cover for the seepage pit, and walls above the inlet should be watertight. The cover should have the strength to support soil cover and any anticipated load, and should extend at least 12" horizontally beyond the excavation. Access to the pit should be provided via a locking watertight manhole extending to the ground surface.

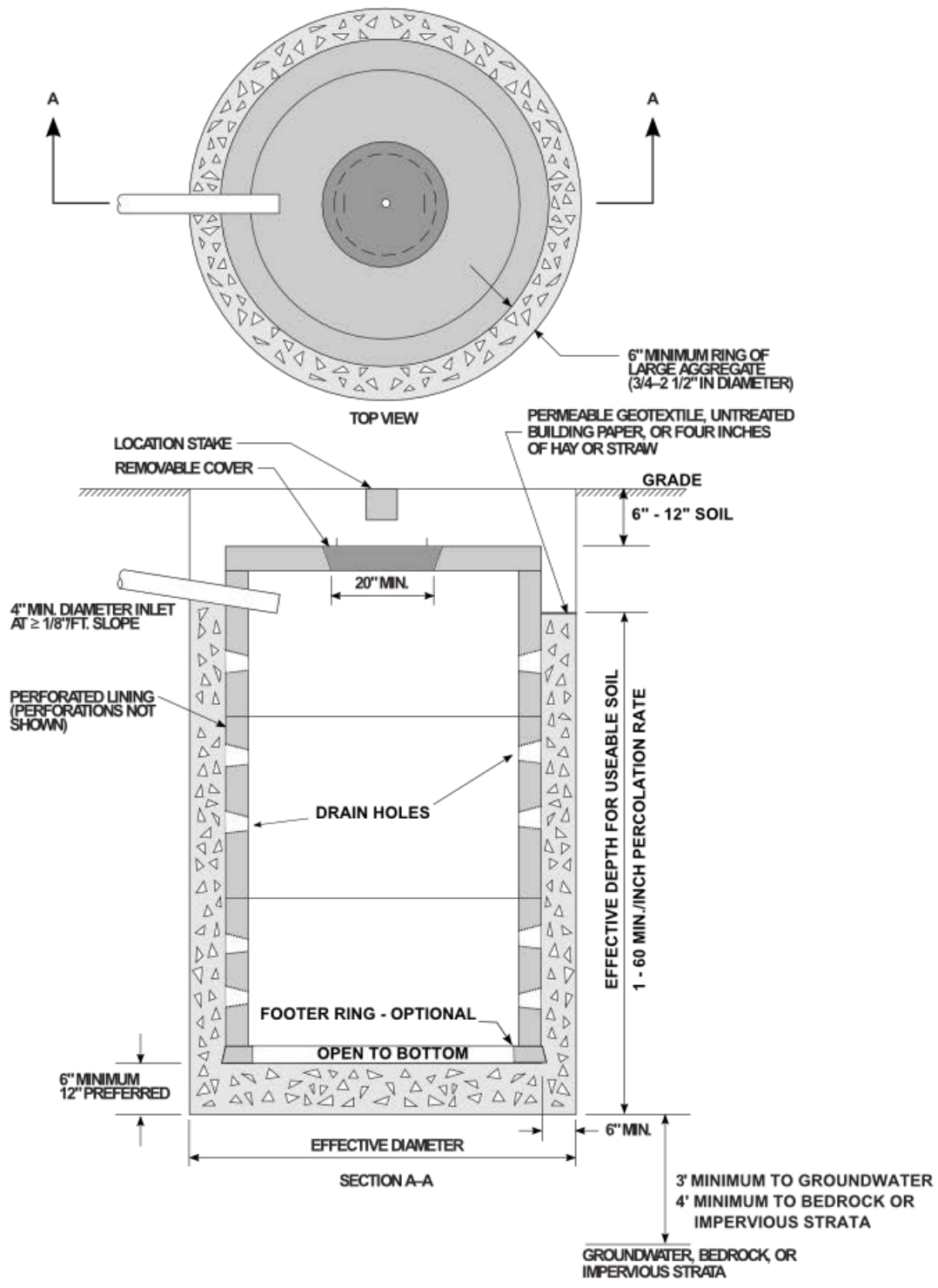

Figure E-14

Seepage Pit

## E.17 Pressurized Shallow Narrow Drainfields (PSND)

Where the size of the site precludes installation of a conventional STS using either an absorption trench or bed, a Pressurized Shallow Narrow Drainfield system may be used, provided the following design and construction criteria are followed. The PSND system shown in Figure E-15 is a viable technology for providing nutrient uptake and metabolizing other organic wastewater constituents. Vertical separation to the seasonal high water table is 2' statewide, and separation to the bedrock or impervious layer is 4' statewide.

- Wastewater must be treated by a secondary system, equivalent to a Single-Pass Sand Filter, as discussed in Section F that meets effluent quality of 30 mg/L BOD<sub>5</sub> and 30 mg/L TSS, and the FOG concentration is controlled by effluent screen(s).

AND

- Effluent that is then discharged to the Shallow Narrow Drainfield using pressure distribution, or dosing, at the same hydraulic loading rate given for the percolation rate of the soil in Table E-1.

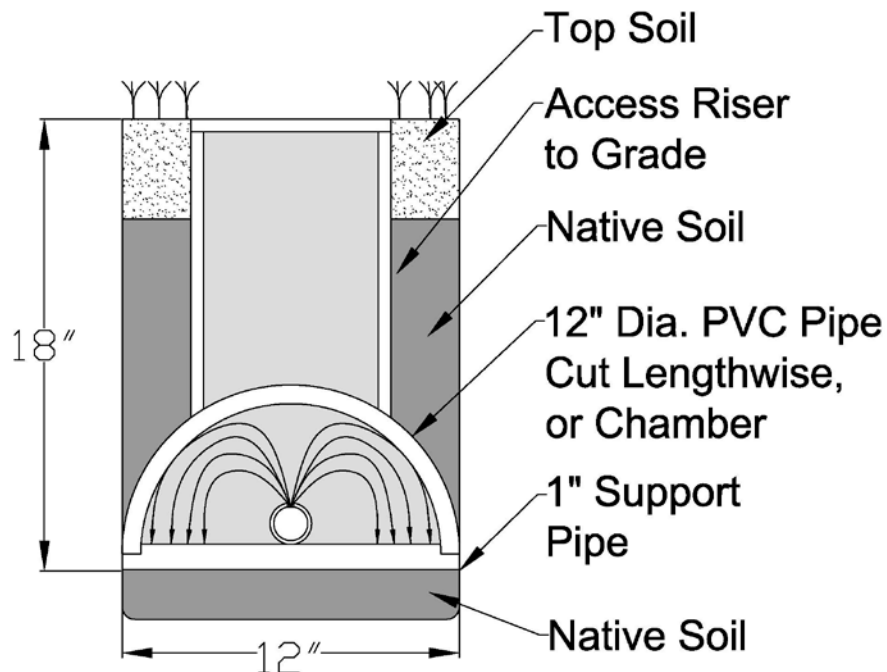

Figure E-15 Pressurized Shallow Narrow Drainfield Section (cross-section)

Appendix E.3 includes detailed design guidance in support of what is given here, as well as information on the installation, operation, maintenance and monitoring of PSND systems. Several reference documents are also listed at the conclusion of Appendix E.3.

## **E.18 Drip and Other Low-Profile Dispersal Systems**

Drip dispersal subsurface systems consist of a pre-treatment unit, a pump tank, filtration system, subsurface drip tubing, and controller. Other low-profile dispersal systems operate similarly but differ in the type of conduit and orifice size, shape and spacing. The design professional should consult with the manufacturer of the specific product being considered. The pre-treatment unit selected is based on the component equipment used, characteristics of the wastewater, and the receiving environment. Primary settling or septic tank treatment is the minimum level of pre-treatment necessary. Additional pre-treatment to remove specific pollutants, such as FOG, which may adversely impact the soil or receiving environment or foul the drip dispersal system, may be necessary. Any further pre-treatment will be dictated by site constraints or final discharge limits. A likely additional benefit may be extended life of the dispersal system.

Appendix E.4 includes detailed design guidance for drip dispersal and other low-profile dispersal systems. In addition, information is given in Appendix E.4 on the installation, operation, maintenance and monitoring of drip dispersal systems specifically; several reference documents are also listed. Similar guidance applies to other low-profile dispersal products and may be obtained from manufacturers. *TR-16* also refers to the National Onsite Wastewater Recycling Association's (NOWRA) *Recommended Guidance for the Design of Wastewater Drip Dispersal Systems*, 2006, as its primary reference.

For drip dispersal systems, the pump tank stores effluent until the controller turns on the pump to dose pre-treated wastewater through a filtering system into the soil. The filtration system removes solids from the effluent and flushes them back to the pretreatment device. Drip tubing is placed directly into the soil without the use of trenches. The system relies on specially designed emitters to apply effluent uniformly to the STA. Drip tubing is typically placed approximately 2' apart in the landscape so emitters are on a grid pattern within the existing landscape. Drip lines are buried relatively shallow so the soil can provide treatment, landscape plants can use the nutrients and water, and the system can maximize evaporation.

Manufacturers of dripper line or other low-profile dispersal systems should be consulted for recommendations regarding specifications for maximum particle size that can be discharged through the filtering device to adequately protect the emitters. Pre-treatment may include sand/gravel or media filtration. In addition, an in-line filter on the discharge side of the pump may also be required by the drip dispersal



manufacturer to keep emitters free from clogging solids. Any screens or filters should be cleaned periodically and the residuals returned to the pre-treatment unit. Both manual and automatic cleaning methods are used. Providing adequate access to the filtering device in the design of the system is required for routine servicing. The drip dispersal system typically includes the components shown below in Figure E-19.

---

Design Flow

---

A demand analysis of water use at the building(s) to be served should be conducted to estimate average daily flow, expected daily peak flows and diurnal and weekly variations. See Table B-3 Typical Per-Unit Hydraulic Loading Rates, in Section B.6.b Design Flow. Flow estimates obtained from using unit values from Table B-3 represent design flow rate. While most dispersal systems should be designed to distribute the maximum expected peak flows, drip dispersal systems are usually designed to distribute the average daily flow, with peak flows controlled by flow equalization (storage, timed dosing or alternating zones).

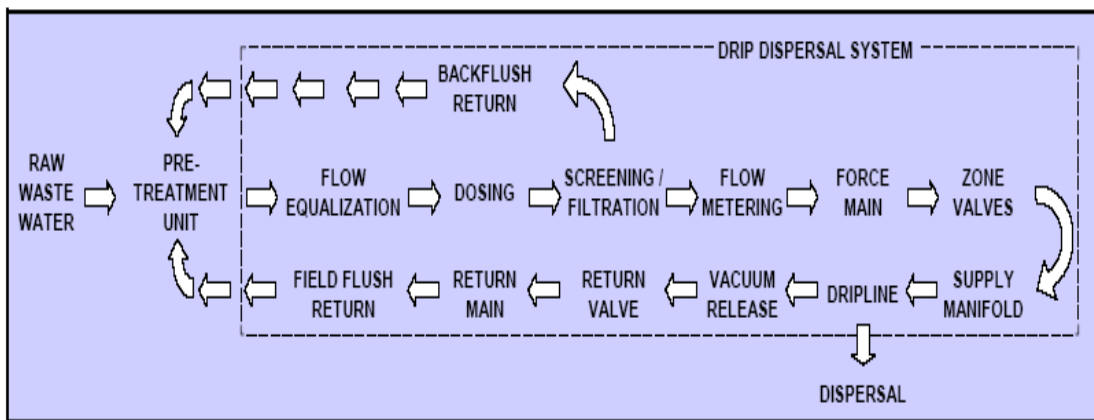

**Figure E-16 Drip Dispersal Diagram**

All components of the drip arrangement should work together for the successful, long-term, reliable operation of a drip dispersal system. The function of each component of the system, in regard to flow rates and pressures, should be appropriately integrated and designed to meet the design requirements given in Appendix E.4. Additional components may be used as deemed appropriate by the manufacturer or designer to treat and evenly disperse wastewater to prevent emitter clogging, prevent physical damage, monitor operation, or otherwise enhance system performance.

## **F. Secondary Treatment**

*NYSDEC categorizes treatment technologies in Chapters E, F, and G of these design standards as either standard or alternative technologies. Standard technologies are systems that have been applied successfully in New York State for a long time with a good record of reliability and effectiveness. Alternative technologies are treatment systems that have not been widely used in New York State, but have been successfully applied in other parts of the country. This entire chapter consists of alternative technologies.*

### **F.1 Introduction**

Following the planning and permit application process outlined in Section A and the project evaluation process in Section B will bring the design engineer to a point of deciding on what treatment options to use to meet permit limits. This section discusses treatment methods to produce secondary treated effluent.

Preliminary and primary treatment by a septic tank or similar unit(s) is required prior to secondary treatment systems. If the preliminary and primary treatment is pre-designed into a package plant, the design engineer should demonstrate that adequate volume and dimensioning for grit removal, solids separation and solids storage is provided. Flow equalization should be provided for all treatment modes with the exception of septic tanks, single-pass sand filters, and lagoons. If flow equalization is not proposed for the system, the engineering report should specify why it is not being proposed.

Treated effluent from a secondary treatment unit should meet SPDES permit limits. Typical permit limits for surface discharge are provided in Tables B-4A and B. For systems discharging to an STS with a design flow range of 400 to 1,500 gpd, NYSDEC strongly recommends the use of filters/screens and enhanced treatment units certified by NSF International Inc.'s Standards 46 and 40, respectively, or by an equivalent certification system. For systems discharging greater than 1,500 gpd to an STS, multiple NSF-certified systems or another treatment technology chosen from these Design Standards, *Ten States Standards* or *TR-16* may be used.

The Table F-1 reprint of the 2002 EPA *Onsite Wastewater Treatment System (OWTS) Manual Table 4-1* (EPA page 4-3) presents secondary and tertiary treatment methods. The EPA website provides access to EPA's *1980 Design Manual* and *2002 OWTS Manual* (link to "Guidance, Manuals and Policies") and to other information about on-site wastewater treatment systems from federal and state environmental agencies, universities, and industry professionals.

**Table F-1 Suggested Treatment Methods to Meet Treatment Objectives**

(Reprinted from 2002 EPA *OWTS Manual* Table 4-1, page 4-3)

Treatment	Treatment process	Treatment methods
<b>Suspended solids removal</b>	Sedimentation	Septic Tank Free water surface constructed wetland Vegetated submerged bed
	Filtration	Septic tank effluent screens Packed bed media filters (incl. dosed systems): Granular (sand, gravel, glass, bottom ash), peat, textile or foam. Soil infiltration
<b>Soluble carbonaceous BOD and ammonium removal</b>	Aerobic suspended-growth Reactors (Activated Sludge)	Extended aeration Fixed film activated sludge Sequencing batch reactors (SBRs)
	Fixed film aerobic bioreactor	Soil infiltration Packed bed media filter (incl. dosed systems): Granular (sand, gravel, glass), peat, textile or foam Tricking filter Fixed film activated sludge Rotating biological contactors (RBCs)
	Lagoons	Facultative and aerobic lagoons Free water surface constructed wetlands
<b>Nitrogen transformation</b>	Biological Nitrification (N) Denitrification (D)	Activated sludge (N) Sequencing batch reactors (N) Fixed film bio-reactor (N) Recirculating media filter(N,D) Fixed film activated sludge (N) Anaerobic up-flow filter (N) Anaerobic submerged media reactor(D) Vegetated submerged bed (D) Free water surface constructed wetland (N,D)

	Ion exchange	Cation exchange (ammonium removal) Anion exchange ( nitrate removal)
<b>Phosphorus removal</b>	Physical/Chemical	Infiltration by soil and other media Chemical flocculation and settling Iron-rich packed bed media filter
	Biological	Sequencing batch reactors (SBRs)
<b>Pathogen removal (bacteria, viruses, parasites)</b>	Filtration/Predation/Inactivation	Soil infiltration Packed bed media filters: Granular (sand, gravel, glass, bottom ash), peat, textile or foam
	Disinfection	Hypochlorite feed Ultraviolet light
<b>Grease removal</b>	Flotation	Grease interceptor Septic tank
	Adsorption	Mechanical skimmer
	Aerobic biological treatment (incidental removal will occur; overloading is possible)	Aerobic biological systems

Responsibility for the process to achieve the needed level of treatment rests with the design engineer. For some commercial wastewaters, grease removal may be required (see Section D.5) or tertiary treatment techniques, such as physical-chemical treatment (see Section G), may be more appropriate than biological secondary treatment alone. The maximum FOG concentration discharged to an STS should be controlled by effluent screens filtering for both the grease interceptor and septic tank/treatment tank effluent.

Conventional technologies that use soil for most of the treatment and have been successfully employed in New York State for many decades should be considered first. These designs have a track record of reliability with low maintenance. New and alternative technologies have potential risk and may require a higher level of oversight. The level of treatment should be determined at the pre-application meeting described in Section A.2. Most secondary treatment systems require active management (on-site visits and remote telemetry) to properly manage and maintain the treatment levels of the system.

## F.2 Media Filtration and Alternative Media

### F.2.a General

Sand filters and alternative media filters should be preceded by properly designed settling facilities. A septic tank with an effluent filter is usually sufficient. Aeration of septic tank effluent will extend the life of either the sand or media filter. Post filtration aeration and/or disinfection may be necessary prior to discharge to surface waters. Distribution piping for sand filters may be of a variety of materials, although perhaps the most common is PVC (ASTM D3034).

Single-pass sand filters can be buried or open. Open filters may be single-pass or re-circulating. Single-pass sand filters can be used where soil is impermeable, or where highly polished effluent is desired. Discharge is generally to surface waters but may be to a soil-based treatment system.

Refer to Appendix F for a compilation of case study data of influent levels and resultant effluent levels after treatment for BOD, TSS, TKN, TN and fecal coliform.

---

#### Sand/Gravel Filtration

---

Sand filtration is a well-established method of wastewater treatment. Single-pass sand filters operating by siphon dosing to gravity are preferred as being least costly and requiring the least maintenance. Where a gravity system can be used, single-pass sand filters (SPSFs) provide reduced energy costs. However, re-circulating sand filters (RSFs) that have additional operator control may cause fewer odor problems, may result in a more consistent effluent quality than single-pass filters, and will have a smaller footprint than single-pass filters. Re-circulating sand filters may require up to three pumps: to the filter, to recycle, and to the soil-based treatment system (STS).

In general, without re-circulation, smaller media sizes ( $d_{10}$ ) combined with low loading rates will result in both a high-quality effluent and enhanced nitrification. A properly operated filter (i.e., not overloaded) should be able to achieve nitrification of at least 80 percent of the applied ammonia. From the 2010 *Rhode Island Sand Filter Guidance* Introduction: “Sand filters when designed, installed, and operated in accordance to this guidance will provide effluent BOD<sub>5</sub> and TSS levels of less than 10 mg/L. Sand filters are efficient nitrifying units, and can reduce septic tank effluent ammonia-nitrogen levels from 35 to 55 mg/L to less than 5 mg/L by passage through a single pass sand filter, providing 86 to 91 percent removal.”

Additional performance data is given in the 2002 EPA *OWTS Manual* Technical Fact Sheets 10 and 11.

---

## Liners

---

The sand or media filter should be evaluated for the need of a liner, curtain drain, or other appropriate measures where high groundwater levels, bedrock, and soils with fast percolation rates are present to prevent infiltration of groundwater or exfiltration of wastewater. If the natural/native soil has a percolation rate faster than 60 mpi it is strongly recommended the sand or media filter have a liner, especially where groundwater contamination is a concern.

An impermeable liner is highly recommended for sand or media filter systems with design flows over 1,000 gpd. Liners should be 30 mil per ASTM D751 (for thickness), ASTM D412 (for a tensile strength of 1,100 lb., and an elongation of less than 200 percent), ASTM D624 (for a tear resistance of 150 lb./in), and ASTM D471 (for water adsorption range of +8 to -2 percent mass). The liner should be ultraviolet resistant with a geotextile fabric or 3" of sand below it to protect the liner from puncture.

---

## Flow Rates

---

In general, open filters are preferred over buried filters when the wastewater flow rate exceeds 30,000 gpd. Open filters generally can be used for wastewater flows up to 200,000 gpd.

---

## Resting Filters

---

When multiple single-pass filter beds are used, a resting period of at least 60 days for every six months of operation is recommended to oxidize the clogging mat and increase the filter's lifetime. The total surface area of multiple filter beds in service should be adequate for handling the recommended design for hydraulic and organic loading even with the largest filter bed at rest. See Section F.2.b. Single Pass Sand Filters for seasonal use and resting of single-bed filters

Winter startup of filters should be avoided. Open re-circulating sand or gravel filters can be designed to avoid formation of a surface-clogging mat and the resulting required maintenance.

---

## Filter Media Alternatives

---

Sand, pea gravel and graded gravel are most often used in the construction of sand/gravel filters. Using crushed stone should be avoided unless it is washed to remove all fine materials that could clog the filter. Only sand and gravel loading specifications are given in these design standards; other media require approval under Section H.

Other granular media that have been used include bottom ash, expanded clay, expanded shale, and crushed glass. These media should remove BOD and TSS similar to sand and gravel for similar effective sizes, uniformity, and grain shape. Newer commercial media, such as textile materials, open-cell foam, and peat, have had limited testing. Based on early testing data, these materials are expected to perform as well as sand and gravel. Alternative media may be contained in "pods," tanks or containers sized by design flow or "per bedroom" for residential use. Larger containers designed to handle commercial/small municipal wastewater facilities are also available.

Any media should be evaluated based on design loading rates, durability, performance and cost. It is not feasible to provide design data for every material. The design engineer should require the manufacturer to provide sufficient documentation regarding the performance under expected on-site conditions (such as sewage strength, ambient temperature and desired effluent quality).

---

#### Sand/Gravel Media Sizing and Specification

---

The following subsections will focus on the use of sand or gravel media. This type of media should be durable, insoluble in water, have rounded grains, and an organic content of less than 1 percent. Only washed material should be used. Fine particles passing the U.S. No.200 sieve (less than 0.074 mm) should be limited to less than 3 percent by weight. The largest particle size should be 3/8".

A statement from a certified laboratory and/or from the source operator indicating a sample has been analyzed, and the indicated sand/gravel media is the material that will be supplied, should be provided to the design engineer prior to construction, and should also be provided for every load delivered. Sufficient media should be supplied for a minimum filter depth of 24". Ongoing monitoring of media quality during construction is strongly encouraged to assure the proper media is installed. Sample sieve size specifications are shown below.

<b>Example Sand Media Gradation</b>		
<i>US Standard Sieve</i>	<i>Particle Size (mm)</i>	<i>Percent Passing the Sieve</i>
3/8	9.5	100
4	7.8	95 to 100
8	2.4	80 to 100
16	1.2	45 to 85
30	0.60	15 to 60
50	0.30	3 to 15
100	0.15	0 to 4
200	0.075	0

Ranges of media sizes are recommended for the different types of sand/gravel filters in the discussion to follow. The effective size (ES or  $d_{10}$ ) of the media refers to the sieve size in millimeters that permits 10 percent by weight to pass. The Uniformity Coefficient (UC or  $d_{60}/d_{10}$ ) is the ratio between the sieve size that will pass 60 percent by weight and the effective size.

---

#### Wastewater Distribution

---

Gravity distribution of wastewater resulting in trickle flow to sand filters should not be allowed. System dosing, via siphons, floating outlet dosing devices, or pumps should be provided for all media filters. Provision should be made to prevent the flow of wastewater out through any vents when the system is being dosed.

#### **F.2.b Single-Pass Sand Filters**

Single pass filters can be used as a secondary treatment method or for effluent polishing following a package plant treatment process. Single-pass sand filters typically provide insufficient treatment for intermittent stream effluent limits. Single-pass sand filters can be buried or open. Because a sand filter should be maintained by removal of biomat that forms on the filter surface from time to time, an open sand filter design would facilitate this cleaning process. Therefore, the Department encourages installation of open sand filters.



Buried single-pass sand filters are constructed below grade in a lined or unlined excavation and covered with soil material. The design limits operator access to the filter. These filters should not be used directly after package aerobic treatment plants because an upset in the aerobic unit may cause clogging of the filter. Using an effluent filter in a separate tank following the aerobic treatment unit would prevent solids carryover to the buried sand filter if properly installed, operated and maintained.

A buried sand filter should be constructed in accordance with Figure F-1. Multiple filter beds are strongly recommended when filters are of the buried type to allow for resting of beds, and redundancy. Steps should be taken to divert rainfall and runoff away from buried filters. Due to the inaccessible aspect of the buried sand filter, no preventive maintenance can be performed. Buried sand filter design is not recommended for large installations, because once the sand filter is clogged, the facility loses filtration capability until the system is replaced, which could be very costly.

**Media:** The recommended effective media size (ES) range is 0.25 to 1.0 mm, and the uniformity coefficient (UC) should be less than 4. If nitrification is not required, effective media size range should be 0.5 to 1.0 mm. Media with lower UCs are preferred as they are less likely to clog but more difficult to obtain or are more expensive.

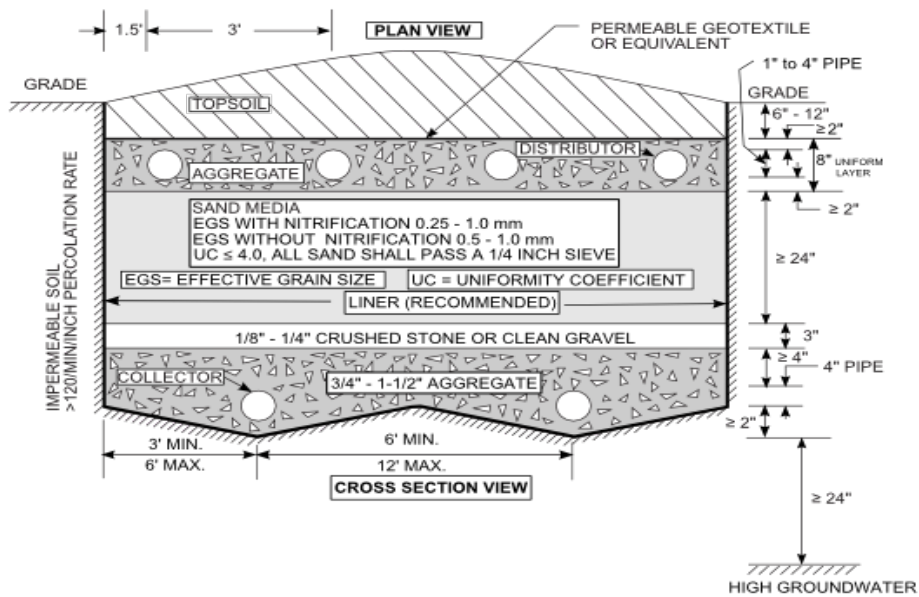
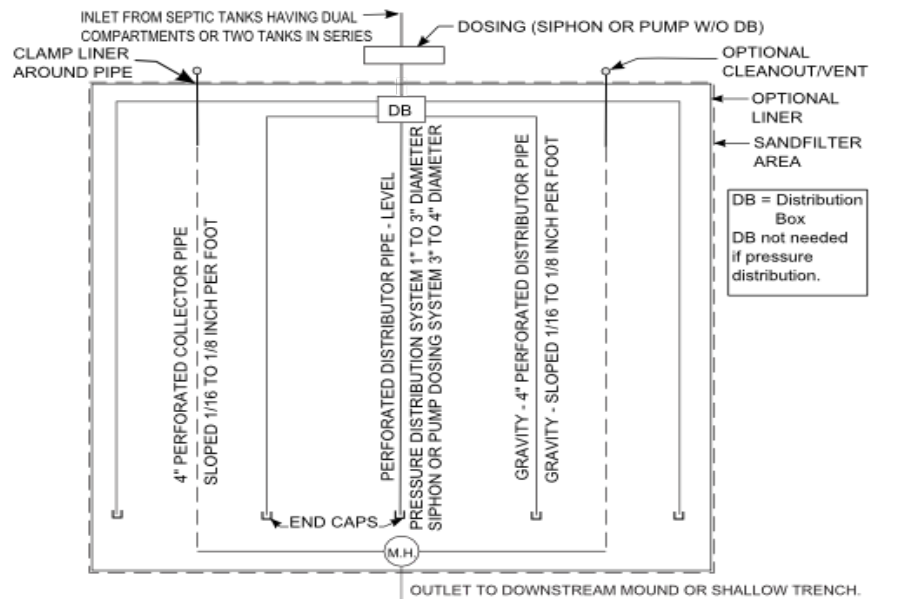

**NOTES:**

1. A Single Center Collector may be used when the filter width does not exceed 12 Feet.
2. Collector lines to be centered between distributor lines.
3. Gravity distribution may be used to apply effluent to small filters having less than 300 lineal feet of distributor or less than 900 square feet of filter area.

Figure F-1

Single-Pass Sand Filter- Buried Filter

Loading: Hydraulic - The hydraulic application rate for buried filters in continuous operation should be no more than 1.0 gpd/sq. ft. of bed surface area for filters. If a bed is operated seasonally such that it will rest for an amount of time equal to or greater than its time in use (on a yearly basis), application rates up to 2.0 gpd/sq. ft. may be allowed.

Loading: Organic – Long-term organic loading should be less than 0.005 lbs. BOD/day/sq. ft. of bed surface area.

Loading: Nitrification - When nitrification is required, the hydraulic application rate should not exceed 1.0 gpd/sq. ft. of bed surface area; a lower organic loading is recommended (e.g., 0.003 lbs. BOD/day/sq. ft. of bed surface area).

Filters operating on a seasonal basis are less efficient at nitrifying wastewater, thus recirculation is recommended.

Dosing: This type of single-pass buried filter should be flooded at least twice per day, and the volume of each dose should be at least 75 percent of the volume of the distribution lines. Distribution boxes should be used to direct sewage flow. Pressurized distribution systems that provide 2' of head at the distal end of the distribution system are strongly recommended.

Base: Approximately 2" of gravel should be placed above and below the distribution lines and the underdrain of the filter. Gravel size around the under drains and distribution lines should be  $\frac{3}{4}$ " to 1½". Size of the crushed stone or clean gravel between the sand media layer and the base aggregate layer should be 1/8" to ¼". The ground beneath the filter should be sloped to the trenches in which the underdrains are laid.

Arrangement: Underdrain pipes should not be placed on greater than 12' centers, and at least two underdrain pipes should be provided. Underdrain pipes should be sloped to the outlet. Distribution lines should not be placed on greater than 3' centers. For installations with more than 800' of distribution lines, the filter should be constructed in two or more sections such that no section contains more than 800' of distribution lines. Dual siphons or pumps should be provided to alternate the flow to different sections. Venting of underdrains is also required.

Construction: The filter should be settled by flooding with clean water before distribution lines are placed at final grade. Before backfilling, a barrier material should be placed above the graded gravel. Barrier material should be a synthetic drainage fabric (permeable geotextile). Untreated building paper is permitted

only for SPSFs with design flows under 1,000 gpd. Backfilling should be done carefully to avoid compaction of the filter and protect distribution piping from deflection or deformation. Use of heavy machinery should be avoided.

Approximately 6" of topsoil should be mounded over the site, with a 3 to 5 percent slope to direct rainwater away from the filter.

---

### Single-Pass Sand Filters Open Design

---

Open single-pass sand filters are constructed above or below grade in a lined or unlined excavation, and are accessible from the surface for maintenance and other purposes. The SPSF can be used as a secondary treatment method or for effluent polishing following secondary treatment. A typical open single-pass filter is shown in Figure F-2.

Media, organic loading, dosing, base and arrangement recommendations are the same as those listed above for the buried single-pass sand filter.

Hydraulic loading rate: Open single-pass sand filters are limited to a range of 2 to 5 gpd/sq.ft. Decreased loading rates are recommended when nitrification is required.

Distribution: Pressurized distribution is the preferred method of dosing for an open SPSF design because it provides for more even distribution of wastewater over the entire sand filter. However, pressurized distribution does require routine maintenance to maintain its efficacy such that it is better suited for open SPSF design than the buried variation. Pressurized distribution delivers a pre-determined volume of effluent to the sand filter by spraying the effluent through orifices over or into the sand filter surface area. Lower hydraulic loading rates and greater dosing frequencies allow for smaller pumps and discharge lines and require less energy to operate. Refer to Appendix E.1 for a pressurized design example.

Cover: It is often necessary to provide a cover for a filter surface because the surface of a fine medium exposed to sunlight can be fouled with algae. Also, there may be concerns about odors, cold weather impacts, precipitation, leaf and debris accumulation, and snow melt. In addition, the cover must provide ample fresh air venting. Reaeration of the filter medium primarily occurs from the filter surface.

Construction: The filter should be settled by flooding with clean water before distribution lines are placed at final grade.

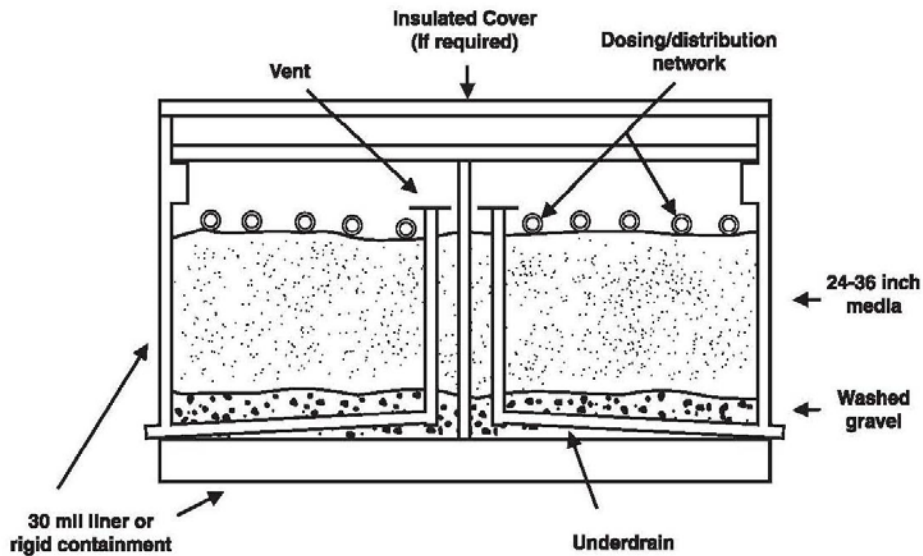

**Figure F-2 Open Single-Pass Sand Filter**

Walls: Provision must be made to prevent soil or stormwater from washing onto beds. Walls exposed directly to the air in cold climates should be insulated. Walls also prevent creeping weed growth from entering the filter area.

Maintenance: Winter startup in any location should be avoided. Open sand filters must be raked and weeded as needed. The distribution network should be flushed annually, and the dosing pump should be calibrated at least annually. Multiple filter beds should be provided to allow for maintenance, except for very small facilities. Regular filter bed rotation is also recommended for resting (draining and re-aerating).

### **F.2.c Recirculating Sand/Media Filters (RSF)**

Recirculating filters can be used as a secondary treatment method or for effluent polishing following package plants. Depending on the design, an effluent filter may be required to prevent occasional solids carryover from some aerobic treatment units that may precede the sand or media filter. A typical recirculating filter is shown in Figure F-3. Note that Technology Fact Sheet 11 in EPA's 2002 *OWTS Manual* has diagrams, general design guidance, design parameter and media specification ranges, recirculation method and component guidance, and pollutant removal performance examples.

---

## Recirculating Sand/Media Filters - General Design Considerations

---

Most RSFs are constructed aboveground with an open filter surface; however, in cold climates, they can be placed in an in-ground excavation to prevent freezing. Walls preventing eroded soil or stormwater from entering the filter should be constructed. Walls should be insulated in cold climates. Pressure distribution is highly recommended for this type of design to provide equal distribution of wastewater over time onto the sand filter. It is often necessary to provide a cover for a filter surface because the surface of a fine medium exposed to sunlight can be fouled with algae. Also, there may be concerns about odors, cold weather impacts, precipitation, leaf and debris accumulation, and snow melt. In addition, the cover must provide ample fresh air venting. Reaeration of the filter medium primarily occurs from the filter surface.

Use of a weir box for recirculating is highly recommended for visual flow confirmation and determination of the quantity of recirculating flow. For systems under 1,000 gpd, a distribution box with a riser may be used for splitting flow to the STS, discharge or to the pump tank.

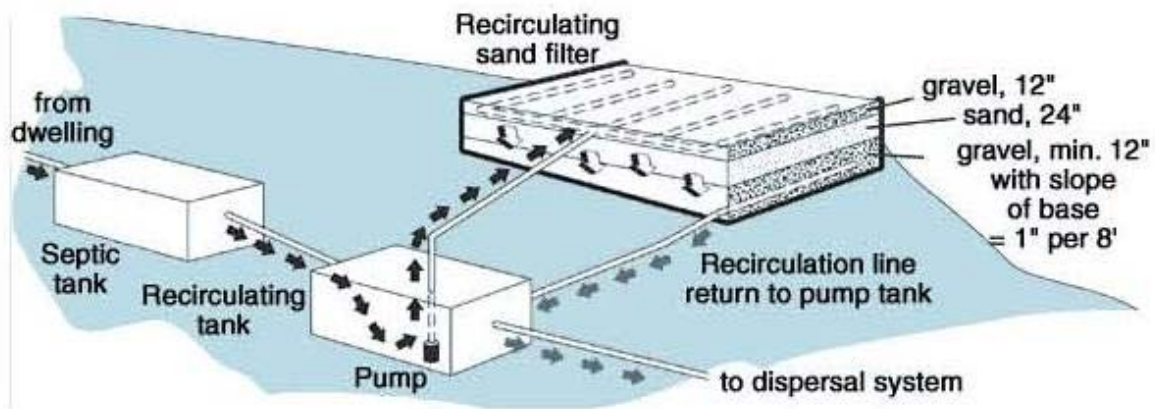

**Figure F-3 Recirculating Sand/Media Filter**

*University of Minnesota Extension Innovative Onsite Sewage Treatment Systems - Recirculating Media Filter (<http://www.extension.umn.edu/distribution/naturalresources/dd7670.html>)*

---

## Recirculation Tank Sizing

---

In many types of commercial systems, daily flow variations can be extreme. In such systems, the recycling ratio necessary to achieve the desired treatment may not be maintained unless the recirculation tank is sized properly. During prolonged periods of high influent flows, the recirculation ratio can be reduced to the point

that treatment performance is not maintained unless the recirculation tank is sized to provide a sufficient reservoir of recycled filtrate to mix with the influent during high-flow periods.

To size the tank appropriately for the application, assess the water balance for the recirculation tank using the following procedure:<sup>48</sup>

1. Select the dosing frequency based on the wastewater strength and selected media characteristics.
2. Calculate the dose volume based on the average daily flow ( $Q_{\text{average daily}}$ ):

$$V_{\text{dose}} = [(\text{recycle ratio} + 1) \times Q_{\text{average daily}}] \div (\text{doses/day})$$

$$Q_{\text{dose}} = V_{\text{dose}} \div (\text{dose period})$$

where  $V_{\text{dose}}$  is the flow volume per dose,  $Q_{\text{dose}}$  is the flow rate per dose, the dose period is the time length between doses, and the recycle ratio is typically between 3:1 and 5:1. Adjust the dose volume if the calculated volume is less than the required minimum dose volume for the distribution network.

3. Estimate the volumes and duration of influent peak flows that are expected to occur from the establishment.
4. Calculate the necessary recirculation tank “working” volume by performing a water balance around the recirculation tank for the peak flow period with the greatest average flow rate during that peak period:

$$\text{Inputs} = Q_{\text{inf}} \times T + Q_{\text{recycle}} \times T = Q_{\text{inf}} \times T + (Q_{\text{dose}} - Q_{\text{eff}}) \times T = V_{\text{inf}} + V_{\text{recycle}}$$

$$\text{Outputs} = V_{\text{dose}} \times (T \div \text{dose period})$$

where T is the peak flow period duration

If the inputs are greater than the outputs, then  $Q_{\text{eff}} = Q_{\text{dose}}$  and the peaks are stored in the available freeboard space of the recirculation tank. If the inputs are less than the outputs, then  $Q_{\text{eff}} = Q_{\text{inf}}$ .

---

<sup>48</sup> *Onsite Wastewater Treatment Systems Manual – TFS 11 p. TFS-65* (EPA/625/R-00/008 February 2002)

To provide the necessary recycle ratio, sufficient filtrate must be available to mix with the influent septic tank effluent. The filtrate is provided by the return filtrate flow and the filtrate already in the recirculation tank.

$$\text{Recycle ratio} \times Q_{\text{inf}} \times T \leq Q_{\text{recycle}} \times T + \text{minimum tank working volume}$$

$$\text{Where minimum tank working volume} = \text{Recycle ratio} \times (Q_{\text{inf}} - Q_{\text{recycle}}) \times T$$

5. Calculate the necessary freeboard volume for storage of peak flows when the influent volume is greater than the dosing volume during the peak flow period.

$$\begin{aligned} \text{Freeboard volume} &= Q_{\text{inf}} \times T + Q_{\text{recycle}} \times T - Q_{\text{dose}} \times T \\ &= Q_{\text{inf}} \times T(Q_{\text{dose}} - Q_{\text{eff}}) - Q_{\text{dose}} \times T \end{aligned}$$

6. Calculate the minimum total recirculation volume.

$$\text{Total tank volume} = \text{minimum tank working volume} + \text{freeboard volume}$$

---

#### Design Criteria for Recirculating Sand/Media Filters Using Pressure Distribution:

---

**Recirculation:** The Recirculation Ratio is the ratio of the return filtrate flow to the flow splitting device to the effluent (average design) wastewater flow or “forward flow.” Adjustable recirculation ratios covering 3:1 to 5:1 should be available to the system operator. Recirculation may be maintained by using weir boxes, flow splitter boxes, moveable gates, check valves, or the float valve arrangement. Hydraulic loading of the sand filter surface will be four to six times the forward flow because the forward flow from the pre-treatment unit combines with the filtrate recirculation volume. The storage capacity of the recirculation tank should provide enough freeboard to accommodate power outages and servicing of the system.

**Dosing:** Filters should be pressure dosed every 30 to 60 minutes using programmable timers. Small, regular (intermittent) doses of one to two gallons per orifice provide uniform distribution- a better environment for treatment.

Pumps should be sized to provide a minimum of 5' of head (water pressure) at the distal end of each distribution lateral in the filter. The pump dosing the sand filter should be located in the recirculation tank



that follows the septic tank and should be placed in a screened pump vault.

Flow from the septic tank to the recirculation tank is typically by gravity. All effluent should be pre-screened using an effluent filter/screen before it is dosed onto the sand filter. This screen/filter assembly helps protect the pump and sand filter surface from excessive solids.

**Media:** The effective size of the media should be 1.0-5.0 mm with a uniformity coefficient under 2.5. Washing is required to remove fine material (fines) from the media before installation in the sand filter. Using larger media size within the given range is preferred because it extends longevity of the filters and reduces operator maintenance time. Smaller media may provide better treatment (pathogen removal); however increasing recirculation can help address pathogen removal and treatment efficiency with larger size media. In addition, adequate resting time provides the necessary aerobic conditions for better treatment. UV disinfection may also be added to reduce pathogens.

**Loading: Hydraulic -** Wastewater from septic tanks is applied at loading rates of 2- 5 gpd/sq. ft. based on forward flow when sand media is used in RSFs providing secondary treatment. Where gravel media is used, hydraulic loading rates range between 10- 15 gpd/sq. ft. With a recirculation ratio of 3:1 to 5:1 at the flow-splitting device, the actual wastewater loading rate on the sand filter surface can be four to six times the forward flow from the pre-treatment unit. RSFs provide nearly complete nitrification, resulting in removal of 50 percent of the Total Nitrogen (TN). Design variations of RSFs to further reduce TN using denitrification are given in the EPA Technology Fact Sheet 9 *Enhanced Nutrient Removal – Nitrogen*.

Wastewater from package activated sludge plants equipped with effluent filters to prevent solids carryover, or from trickling filters, may be applied at loading rates up to 10 gpd/sq. ft. when sand media filters are used as low-rate polishing filters. Refer to Section G.2 for further information on low-rate granular media filters.

**Loading: Organic -** Long term organic loading should be under 0.005 lbs. BOD/day/sq. ft. If nitrification is required, a lower organic loading of 0.003 lbs BOD/day/sq. ft. is recommended.

**Base:** Graded gravel should be placed at a depth of at least 10" around the underdrains, and should be ¾" to 1½" in size. This should be covered with at least 3" of pea gravel, which is 1/8" to 3/8" in size.

**Arrangement:** Multiple filter units should be provided to allow for maintenance, except for very small

facilities (flow under 2,000 gpd). Rectangular beds should be considered to provide more complete coverage during dosing.

**Distribution:** Using large media size eliminates the option of flooding the filter. PVC pipelines with drilled orifices or spray nozzles may be used for distribution of settled sewage over the filter surface. 1" to 1½" Class 200 PVC manifolds should deliver wastewater to a distribution pipe grid of ¾" to 1" Schedule 40 PVC pipe.

Temperate climate systems typically drill upward-facing orifices, with every fifth orifice drilled at both the 6 and 12 o'clock positions. Systems in colder climates typically have all orifices pointing down, with slotted orifice shields providing free drainage. An alternative to orifice shields is to use 3" to 6" PVC or corrugated plastic foundation drainage pipe as an outer sleeve to allow free drainage and prevent filter media blockage of orifices.

Orifice spacing is determined by dosing requirements. RSFs should receive 24 to 48 equal doses of wastewater per day. Grid dimensions (created by the pipe centering and orifice spacing) should be 2' to 2½'.

The discharge pipe to the distribution system should be a 1¼" to 2" PVC (Class 200 minimum) pipe, the actual size depending upon such factors as distance, pump head, friction loss, and desired pressure at distal orifices. The discharge pipe should be drained between doses to prevent frost damage. This can be done by providing a drain line from the distribution line back to the recirculation tank, or by providing small weep holes in the discharge pipe. At least 18" of sand should be present below the weep holes. For a pumped system, the discharge pipe can be sloped back to the dosing chamber and the check valve at the pump eliminated. In this case the dosing volume should be sized to account for backflow.

Distal ends of laterals in an RSF, which are readily accessible by pushing aside a small amount of pea stone, do not need sweep elbows (turn-ups). These lateral ends should have threaded ball valves onto which a distal head measurement pipe can be attached. Lateral cleaning will occur through ball valves .

**Underdrains:** Four inch diameter Schedule 40 PVC slotted underdrain collection pipes should be sloped to the outlet and should not be placed on greater than 10' centers. The underdrain may lay level or on a maximum slope of 0.5 percent. Slots should be oriented upwards, sized ¼" by 2½", and spaced 4" apart.

At least two underdrains should be provided with venting. Venting should be provided by bringing the distal end of the underdrain pipe to the surface of the filter and supplied with a removable cap. In addition

to venting, the pipe to the surface can be used as a cleanout and an observation port.

The underdrain pipe should leave the concrete or lined filter enclosure via a watertight, sealed penetration.

A minimum of 4" of  $\frac{1}{2}$ " to  $\frac{3}{4}$ " clean washed stone should be placed between and over underdrain pipes. If a plastic liner is used, sharp, angular stone should be avoided to prevent liner punctures.

Eight inches of  $\frac{3}{8}$ " clean washed pea stone should be placed carefully over underdrains and drainage stone to assure the filtering media is not washed down into the underdrain.

**Walls:** Provision should be made to prevent soil from washing onto beds. Walls exposed directly to the air in cold climates should be insulated. Walls also prevent creeping weed growth from entering the filter area.

**Cover:** For an RSF, cover the filter with  $\frac{3}{8}$ " pea stone to a level of 2" to 4" over the top of the lateral (distal) end ball valve. (No topsoil cover should be placed over the pea stone.)

**Maintenance:** Winter startup should be avoided. Regular rotation with resting is also recommended.

### F.3 Rotating Biological Contactor (RBC)

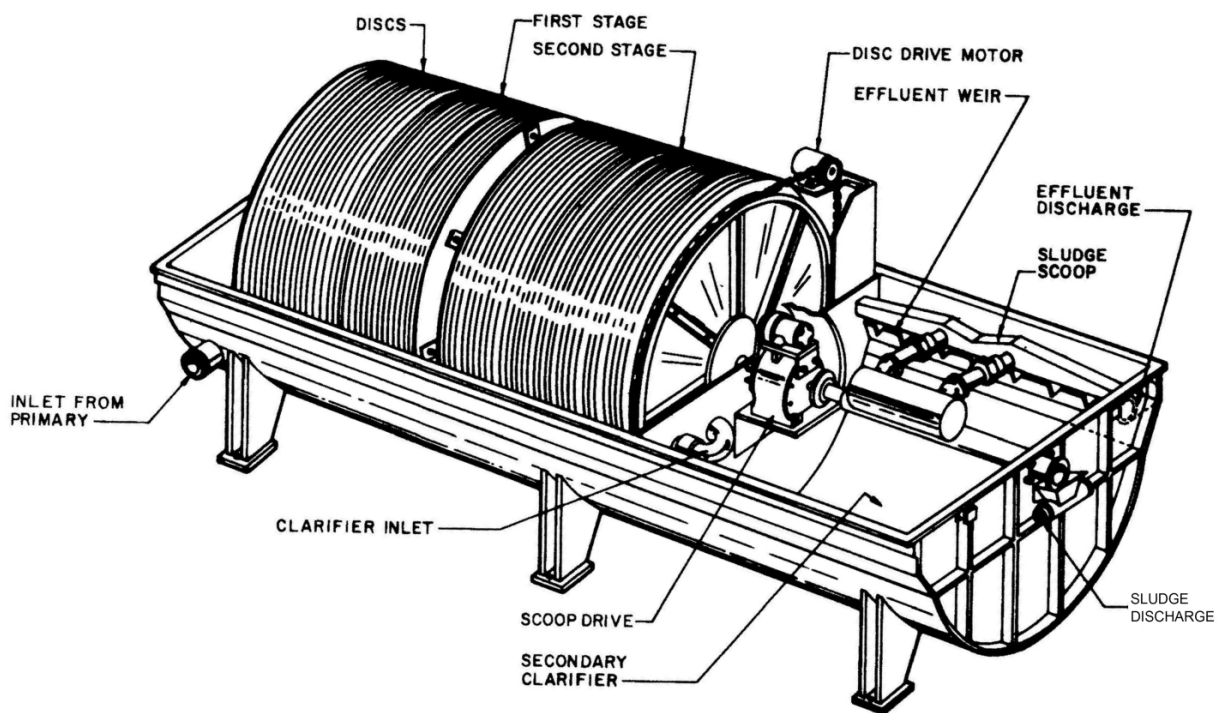

**Figure F-4 Rotating Biological Contactor (RBC) Schematic**

A rotating biological contactor is a biological process used in the treatment of wastewater following primary treatment. The primary treatment process removes grit and other solids through a screening process, followed by a period of settlement. The RBC process allows wastewater to come in contact with a biological medium to remove pollutants before discharge of the treated wastewater. The process involves a series of closely spaced, parallel discs mounted on a rotating shaft which is supported just above the surface of the waste water. Microorganisms grow on the surface of the discs where biological degradation of wastewater pollutants occurs. *TR-16* addresses pre-treatment requirements, media selection, unit sizing, designing for operational flexibility, and weather protection for RBC design. *TR-16* design criteria serve as New York State's standards for RBCs, as supplemented below:

1. Staging - For small installations, up to four stages can be provided on a single shaft by installing inter stage baffles in the tank, with the direction of flow parallel to the shaft.
2. Nitrification - Four or more stages are usually necessary when nitrification is desired in addition to BOD removal, because maximum nitrification rates will not be obtained until the level of soluble BOD<sub>5</sub> drops to 10 mg/L or less. For design purposes, the average maximum removal rate should

not exceed 0.3 lb NH<sub>3</sub> - N/day/1,000 sq. ft. of media. Where large and/or frequent peaks in flow or organic loading are anticipated, consideration should be given to providing either additional media or flow equalization to ensure consistently low ammonia nitrogen levels. The temperature of the system should be maintained at or above 55°F. If this is not possible, additional media should be provided to compensate for reduced removal rates. The system pH should be held between 7.1 and 8.6. If the wastewater is poorly buffered, the system should have the capacity for the addition of alkaline chemicals.

3. Pilot Plant Studies - When possible, full-scale diameter media should be used for pilot plant studies. If small diameter units are used, each stage should be loaded at or below the oxygen transfer capability of a full-size diameter unit to minimize scale-up difficulties.
4. Shaft weight monitoring - Load cells for measuring total shaft weight should be provided for the first stage of the standard-density and the high-density shafts, at a minimum. Electronic strain gauges are preferable, but hydraulic load cells may also be used. Dissolved oxygen levels should be monitored in at least the first stage of the RBC system. Supplemental air should be provided in the original design to allow operational flexibility when higher oxygen demand is required. Supplemental air helps increase DO levels, control filamentous bacteria growth, and can be used to strip excess growth from an RBC and may increase treatment efficiency.
5. Equipment - Drive systems should be variable speed and may be mechanical or air driven, although mechanical systems are preferred. In that air-driven systems are powered by diffused aeration that directs air on an array of cups peripherally attached to rotating disks, they should have positive airflow metering and control to each RBC unit. Aeration of an RBC system that is mechanically driven may increase treatment efficiency. Bearing units should be self-aligning and should be located outside media covers to allow easy access for lubrication and maintenance. Provision for auxiliary power during power outages is recommended as structural overloads of the shaft may occur when the discs do not rotate.
6. Design/Configuration - Operation and maintenance requirements (including bio-film control, drive train and radial support arm maintenance and repair, and media/shaft repair and replacement) should be considered in the design and layout of RBC treatment systems. Provision should be made for positive flow control to each stage, allowing flexibility in feeding influent and recycling or discharging RBC effluent. Tank depth/configuration should be such that solids are not deposited in the tank. Also, provision should be made for draining the tank. Large installations with closely

spaced RBC units may need a crane for shaft/media removal. System layout should account for crane reach and size. Wastewater flow perpendicular to the shaft should be encouraged to develop uniform loading over the entire length of the shaft.

7. Flexibility - Overloads generally can be avoided if flexibility is designed into the RBC system to strip excessive bio-film growth from the media or to even the organic load to all stages. Flexibility can be achieved by having variable rotational speed, the ability to reverse rotational direction, supplemental aeration, or the potential for chemical addition. The ability to increase surface area in the affected stage should also be considered. The process should include the ability to step feed, bypass and isolate individual RBC stages. If the first stage is overloaded, these provisions will allow a portion of the flow to be diverted to alternative lower density/growth stages.
8. Settling - Final settling should provide a detention time not less than 90 minutes, with maximum surface settling rate of 600 gpd/sq. ft. and weir overflow rate not greater than 5,000 gpd/linear feet. Higher surface settling and weir overflow rates may be used if the contactor is to be followed by tertiary treatment. Surface settling rates of the final clarifier(s) following the RBC process should be based on peak hourly flow rates.

#### **F.4 Media Bio-Towers**

A media bio-tower is a housing in which an attached biomass builds up over time on either redwood or plastic media. Wastewater is treated by the biological activities of the microorganisms in the attached biomass layer, using the nutrients in the wastewater as a food source. As a fixed-growth treatment unit, bio-tower media provide surface area where microorganisms grow and then eventually slough off to be recycled to the head of the treatment process, or discharged as waste sludge. Non-soluble solids should be removed by physical pre-treatment means, e.g., settling, flotation, screening.

The media bio-tower serves as a high-rate filter which provides roughing of the effluent's BOD and TSS. Roughing filters are for treating particularly strong or variable organic loads, allowing them to be treated by conventional secondary processes. Media bio-towers are designed to allow high hydraulic loading and a high level of aeration. On larger installations, air is forced through the media using blowers. *TR-16*, "Integrated Biological Treatment" contains further information on the application of bio-towers for wastewater treatment.

The media bio-tower can also be effective for secondary treatment of BOD and TSS due to biological oxidation and nitrification occurring in the bio-tower. With this aerobic oxidation and nitrification, organic solids are converted into coagulated suspended mass, which is heavier and bulkier than wastewater, and is wasted or recycled. Bio-tower effluent may be sent to a secondary clarifier or settling tank for further solids removal.

*Operation of Municipal Wastewater Treatment Plants WEF Manual of Practice No. 11 Sixth Edition* provides design information on bio-towers.

## **F.5 Activated Sludge**

The activated sludge process may be used to remove suspended solids as well as carbonaceous and/or nitrogenous oxygen demand and nutrients (nitrogen and phosphorus). The chosen process will be influenced by the degree and consistency of treatment required, type of waste to be treated, proposed plant size, anticipated degree of operation and maintenance, local factors, and operating and capital costs. Designs should maximize process flexibility while maintaining design intent, process reliability, and effluent quality. The process requires competent operating supervision, including routine laboratory control and proper control of waste and return sludge.

*Ten States Standards* provides design criteria based on standard modes of activated sludge. *TR-16* provides guidelines for several variations of the activated sludge process that are also presented in other references, including plug flow, complete mix, step feed, contact stabilization, and extended aeration. In addition to criteria for various modes of activated sludge, *TR-16* includes the use of aerobic, anoxic and anaerobic selectors. Integrated biological treatment (IBT) processes that combine fixed-growth systems with activated sludge (suspended growth) systems are also described in *TR-16*. The design engineer may follow either of the above guidance documents based on the selected mode or use of selectors. For smaller treatment systems using extended aeration or contact stabilization modes, a few design criteria are provided below.

Pure oxygen activated sludge systems are beyond the scope of both *TR-16* and the *Ten States Standards*. These systems require site specific approval by the Reviewing Engineer using the review considerations in Section H.

---

### Pretreatment

---

For all activated sludge modes, both *Ten States Standards* and *TR-16* provide pretreatment guidance, with

or without the use of primary settling tanks. Without primary settling tanks, screening devices with clear openings of ¼" or less should be provided as preliminary treatment prior to discharge to activated sludge unit. Grease removal should also be provided to prevent fouling of equipment and treatment components, and creating anaerobic conditions.

When primary settling tanks are provided, bypassing is recommended by *Ten States Standards* for plant startup and initial stages of a facility's design life. If the treatment train uses only one activated sludge tank, then primary treatment/settling tanks are recommended. If denitrification is included in the treatment plant design, removal of particulate carbon should be considered in contrast to the need for supplemental carbon when denitrifying.

*TR-16* also includes design provisions for floating material removal and control of foam-causing microorganisms by chlorinating foam on tank surfaces or in pumped lines.

---

#### Design Criteria

---

- Redundancy: *Ten States Standards* and *TR-16* both recommend two or more tanks to hold the total aeration tank volume. Exceptions to tank volume and arrangements are given below under Extended Aeration and Contact Stabilization.
- System Components: Aeration tank dimensions and design standards for diffusers, blowers, return activated sludge, wasting activated sludge, final settling, and sludge holding tanks are the same as those listed in *Ten States Standards* and *TR-16*.
- Final Settling: Final or secondary settling tank (clarifier) design criteria are given in the Settling section of *Ten States Standards*, and in the Section following Activated Sludge in *TR-16*. In *Ten States Standards*, surface overflow rates of final clarifiers are given for the various modes of activated sludge. Peak solids loading rates for the same modes are also given. *TR-16* provides information on the use of selectors in activated sludge systems. These selectors reduce the amount of sludge going to the final clarifiers.
- Sludge Handling: *Ten States Standards* provides sludge-handling design criteria in a separate chapter entitled, "Sludge Processing, Storage, and Disposal" *TR-16* provides similar information



in a chapter entitled, “Residuals Treatment and Management.” For smaller systems, the following guidelines for sludge storage may be used:

**Sludge Holding Tank:** A sludge holding tank, preferably with supernatant decant capability, should be provided. A minimum 1,000 gallon capacity per 15,000 gallons design flow is recommended. There should be access to the sludge draw-off piping. Sludge generation and wasting is very site-specific and could be necessary every 3 to 12 months, more frequently with phosphorus removal.

A sludge holding tank should be aerated to reduce odors, stabilize the sludge, and reduce its volume. Dispersal of waste sludge should be in accord with currently accepted practice as described in Section J.6, Residuals Hauling and Disposal (6 NYCRR Parts 364 and 360) of this document.

---

## Extended Aeration

---

*Ten States Standards* provides some specific design criteria for the extended aeration mode of activated sludge treatment. They are supplemented below for intermediate-sized systems.

- **Startup and Use Restrictions:** The extended aeration process can be used where a highly nitrified effluent is required. Its use should be governed by the realization that it is a delicate biological process subject to distress caused by surge loadings, variations in organic content, and periods of low or no flow. It takes approximately three months from start-up to stabilization of effluent quality within design parameters. Therefore, it is not recommended that extended aeration facilities be used for schools or seasonal facilities.
- **Flexibility of Operation:** Duplicate units are not mandatory, but piping should be arranged to permit at least primary sedimentation in the event any treatment units must be taken out of operation. Additional flexibility should be built into the system to allow switching to the contact stabilization mode of operation, particularly if the wastewater flow rate or quality will have significant seasonal variations.

*Ten States Standards* provides some specific design criteria for the contact stabilization mode of activated sludge treatment. They are supplemented for intermediate-sized systems as follows:

- **Startup and Use Restrictions:** Contact stabilization should be considered only when the design flow is at least 50,000 gallons per day. Efficiency of the activated sludge process in contact stabilization mode is questionable when wastewater is either too dilute or the soluble BOD concentration is too high, or the system has significant delivery periods of non-uniform flow.
- **Tank Volume:** Total contact tank plus sludge re-aeration tank volume should provide not less than 1,000 cubic feet per 50 pounds of BOD<sub>5</sub> applied to aeration tanks on a daily basis, or a total volume equivalent to six hours of detention time based on rated design capacity, whichever results in the greater volume.
- The number of tanks and flow patterns should be such that two-thirds of the total volume will be available for sludge re-aeration and one-third for contact with sewage at the design rate.
- **Flexibility:** Tank duplication requirements will be satisfied by three tanks arranged so that any one may be dewatered for service while one remaining tank is used for sludge re-aeration and one is used for sewage contact. Additional flexibility should be built into the system to allow switching to the extended aeration mode of operation, particularly if the wastewater flow rate or quality will have significant seasonal variations.

## **F.6 Sequencing Batch Reactor (SBR)**

Sequencing batch reactors (SBR) are activated sludge processing tanks using a fill-and-draw or batch-type mode to treat wastewater. There is no typical SBR design configuration; however, a pre-SBR flow equalization basin followed by two SBR batch-flow units with the capacity to exchange return sludge is a minimum design plan that provides redundancy and allows for flexibility of operation. This suspended growth activated sludge process provides secondary treatment in a single tank using the following steps: fill, treat, settle, decant and draw.

In the treatment step, wastewater is aerated in the tank to reduce BOD. While there are several configurations of SBRs, the basic process is similar. Minimum installation consists of at least two

identically equipped tanks with a common inlet, which can be switched between them. While one tank is in settle/decant mode, the other is in aerating and filling mode. At the inlet is a section of the tank known as the bio-selector, or selector. This selector consists of a series of walls or baffles which direct flow either from side to side of the tank or under and over consecutive baffles. This helps mix influent with returned activated sludge, beginning the biological digestion process before the liquor enters the main part of the tank.

SBRs are aerobic growth reactors that can also provide advanced treatment removals of phosphorus and nitrogenous compounds. Additional information on nutrient removal can be found in Section G “Advanced Treatment” of this document and in *TR-16*.

Design and operation of the SBR should provide treatment quality equal to that of the continuous flow-through modes of the activated sludge process. Supplemental treatment units (e.g., disinfection) may be required to meet applicable effluent limitations and reliability guidelines. *Ten State Standards* provides some specific design criteria and redundancy requirements for sequencing batch reactors. *TR-16* provides design guidance for SBR systems that includes preliminary and primary treatment requirements, SBR component processes, and downstream unit considerations.

*Ten State Standards* and *TR-16* both describe flow equalization requirements. SBRs may require both pre- and post-equalization tanks. Pre-equalization is important for plants that denitrify, and basins should provide sufficient volume to accommodate a single SBR batch at the peak flow expected over the duration of an SBR fill phase. The need for post-equalization of SBR discharge flows will be determined by downstream treatment units, if any. *TR-16* recommends post equalization of a minimum volume of one full SBR batch at facilities where filtration or UV disinfection is required.

Both documents should be used for intermediate-sized systems in addition to the supplemental information provided below:

- Preliminary treatment should be done with fine screening less than ¼", rather than shredding, to keep larger solids completely out of treatment units.
- More than two tanks should be provided. If a two-tank system is proposed, the engineering justification should be documented and approved by the Reviewing Engineer.

- The requirements of Ten State Standards and TR-16 for blower design should be consulted for varying the volume of air delivered in proportion to the load demand of the plant. Blowers with variable frequency drive can deliver the desired amount of air based on in-basin dissolved oxygen probes to prevent over or under aeration. Aeration equipment should also be easily adjustable in increments and should maintain solids suspension within these limits.
- Plant design should include the ability to chlorinate for filament control.
- A sludge holding tank, preferably with supernatant decant capability, should be provided. A minimum 1,000 gallons capacity per 15,000 gallons design flow is recommended. There should be access to the sludge draw-off piping. Sludge wasting from the sludge holding tank is very site-specific and may be necessary every 3 to 12 months, more frequently with phosphorus removal.
- Sludge holding tanks should be aerated to reduce odors, stabilize the sludge, and reduce the volume of settled sludge. Disposal of waste sludge should be in accord with currently accepted practice as described in Section J.6 of this document.

EPA 2002 *Onsite Wastewater Treatment Systems Technology Fact Sheet 3* (TFS- 3) describes both Intermittent Flow (IF) SBRs (that use a true “batch treatment” scheme) and Continuous Flow (CF) SBRs. The “Performance” section of TFS-3 gives ranges of pollutant levels in effluent expected for both intermittent flow and continuous-flow SBR systems. The EPA website provides access to the 2002 *OWTS Manual* and the 1980 *OWTS Design Manual*, and other information about on-site wastewater treatment systems to state and local governments, and industry professionals.

## **F.7 Oxidation Ditches**

An oxidation ditch is a modified activated sludge biological treatment process that uses long solids retention times to remove biodegradable organics. When operated in an extended aeration mode as a single sludge nitrogen removal system, *TR-16* recommends a 12 to 24-hour retention time.

While oxidation ditches are typically complete mix systems, they can be modified to approach plug flow conditions. (Note: As conditions approach plug flow, diffused air must be used to provide enough mixing. In addition, the system will no longer operate as an oxidation ditch). Typical oxidation ditch treatment systems consist of a single or multi-channel configuration within a ring, oval, or horseshoe-shaped basin. As a result, oxidation ditches are called “racetrack type” reactors. Horizontally or vertically mounted

aerators provide circulation, oxygen transfer, and aeration in the ditch. *Ten States Standards* provides no specific design criteria for oxidation ditches. The only applicable guidance is limited to generally applying the extended aeration mode of activated sludge treatment. The *TR-16* standard provides design guidance on using oxidation ditches for Biological Nitrogen Removal (BNR). For further design guidance, refer to EPA's *Wastewater Technology Fact Sheet: Oxidation Ditches (EPA 832-F-00-013)*. Below is a list of additional design considerations for oxidation ditches:

- Raw sewage should be comminuted or fine-screened prior to flowing into the oxidation ditch. Primary settling is not required.
- Design of the ditch or ditches should be based upon 24-hour retention of the design flow or 1,000 cubic feet per 10 pounds of BOD<sub>5</sub> applied to the oxidation ditch, whichever results in greater volume.
- Duplicate units are not mandatory.
- Aerators are usually of the partially submerged rotating brush type. When provided with this type of aeration, submergence should be adjustable, and at least two complete units should be provided (either located in the ditch or stocked as a spare unit). Alternative aeration schemes may be acceptable, but only upon demonstration of proper aeration and mixing capabilities by the design engineer.
- Aerators should: maintain a minimum of 2.0 mg/L of dissolved oxygen in the mixed liquor at all times throughout the aeration tank; maintain all biological solids in suspension by maintaining a velocity of at least 1.0 fps; meet maximum oxygen demand and provide for varying amounts of oxygen transferred in proportion to the load demanded; provide motors, gear housing, bearings, and grease fittings that are easily accessible; be provided with equipment replacement parts that will suffice as duplication of the unit.
- Final settling should be designed to provide a detention time of not less than four hours, a weir overflow rate not greater than 10,000 gpd/linear ft., and a surface settling rate not greater than 1,000 gpd/sq. feet.
- Pumps or airlifts may be used for return sludge. Pumps should have at least 2½" inch suction and

discharge openings. Return piping should be at least 3" in diameter. Airlifts should be at least 3" in diameter. Return sludge rates should be between 50 to 200 percent of plant design flow.

- Provisions should be made for rate regulation and measurement.
- Waste sludge storage for at least six months volume should be provided.
- A sludge holding tank, preferably with supernatant decant capability, should be provided. A minimum 1,000 gallon capacity per 15,000 gallons design flow is recommended. There should be access to the sludge draw-off piping. Sludge generation and wasting is very site- specific and could be necessary every 3 to 12 months, more frequently with phosphorus removal.
- Sludge holding tanks should be aerated to reduce odors, stabilize the sludge, and reduce its volume. Dispersal of waste sludge should be in accord with currently accepted practice as described in Section J.6, "Residuals Dispersal (Part 360)," of this document.

## **F.8 Lagoons (Wastewater Treatment Ponds)**

Lagoons (wastewater treatment ponds) have many forms, but the facultative lagoon is the most widely used. Aerated lagoons are often preferred because of their smaller size requirements. In some areas, lagoons must be lined according to codes which further limit their application. Facultative lagoons are large, perform best when segmented into at least three cells, obtain necessary oxygen for treatment by surface re-aeration from the atmosphere, combine sedimentation of particulates with biological degradation, and produce large quantities of algae, which limits the utility of their effluent without further treatment. Aerated lagoons use mechanical equipment to enhance and intensify the biodegradation rate. They do not produce the intense algal load on downstream processes and have smaller areal requirements than facultative systems.

*Ten States Standards* provides specific design criteria for three types of wastewater treatment ponds. *TR-16* standards provide similar design criteria for the same three types: aerated- facultative, flow-through, and controlled discharge from wastewater treatment pond systems, and their components. Lagoons should be designed and constructed in accordance with standard engineering practice, and should have an engineered overflow structure to provide for controlled release during wet weather events. Guidance regarding controlled releases is in Section I.3.d. Both design standards may be used for intermediate-size systems as supplemented below:

- A comminutor or bar screen should be provided upstream from the influent line conveying raw sewage or waste into an aerated pond system. Primary treatment is not required.
- Minimum separation from habitation or other occupied area for an aerated pond should be 1,000 feet. Also, see Table B-2 for separation distance in developing areas.
- Multiple cells design to permit both series and parallel operation are recommended for all aerated ponds. For un-aerated ponds, series operation is preferable to parallel operation.
- For very small installations, a dike top width of under 8' may be considered.
- Influent lines or interconnecting piping to secondary cells of multiple-celled ponds operated in series may consist of pipes through separating dikes.
- Use of multiple inlets/outlets, baffles, and dikes is encouraged to prevent short circuiting. Influent lines to rectangular ponds should extend no further than one-third the length of the pond if only a single inlet or outlet is provided.
- For un-aerated ponds, interconnecting piping for multiple unit installations operated in series should be valved or provided with other arrangements to regulate flow between structures and permit flexible depth control. Interconnecting pipe to the secondary cell should discharge horizontally near the lagoon bottom to minimize the need for erosion control measures and should be located as near the dividing dike as construction permits.
- Control manholes or other such flow-splitting facilities should be provided between cells of aerated ponds to provide a positive visual means of directing and controlling flow.
- Overflow structures should consist of a manhole or box so designed that flow from the pond during ice free periods could be taken from below, but near, the water surface to select for release the best quality effluent available and insure retention of floating solids.
- For un-aerated ponds, the draw-off lines or an adjustable overflow device should permit pond operation at depths of 2' to 5', with the lowest draw off 12" above the bottom to control eroding velocities and avoid pickup of bottom deposits.

- A locking device should be provided to prevent unauthorized access to and use of the level control facilities. Wherever possible, the outlet structure should be located on the windward side to prevent short circuiting. All structures should be designed to protect against freezing and ice damage.
- Stream hydrograph controlled release lagoons (HCRs) discharge effluent according to the current assimilative capacity of the stream. Release is usually based on stream flow, but water quality and temperature also may be considered. A review of site specific stream information and predicted effluent quality is necessary to determine at what stream flow rates a discharge will be allowed.
- In a multiple-cell facility with a diffused air aeration system and submerged air headers, consideration should be given to arranging the overflow structure and piping to allow for independent drainage of each cell down to or below the level of the air header.
- Surface runoff should be diverted around ponds to protect pond embankments from erosion.



## G. Tertiary Treatment

*NYSDEC categorizes treatment technologies in Chapters E, F, and G of these design standards as either standard or alternative technologies. Standard technologies are systems that have been applied successfully in New York State for a long time with a good record of reliability and effectiveness. Alternative technologies are treatment systems that have not been widely used in New York State, but have been successfully applied in other parts of the country. This entire chapter consists of alternative technologies.*

### G.1 Introduction

Section G discusses advanced treatment methods that produce effluent of a quality greater than secondary and for wastewater constituents not addressed by secondary limits. Table F-1 listed secondary and tertiary treatment methods, or technologies, used to accomplish treatment objectives. Table F-1 may be referred to in determining tertiary treatment methods needed to accomplish necessary treatment goals. Some secondary treatment technologies can be used to achieve advanced or tertiary treatment levels and some are required as pre-treatment prior to tertiary treatment. Most tertiary treatment systems require active management (e.g., on-site visits and remote telemetry) to properly manage and maintain treatment levels of the system.

**Table G-1 Per Capita Mass Loading of Nitrogen and Phosphorus**

**Typical Data on the Unit Loading Factors and Expected Wastewater Contaminant Loads from Individual Residences** (from WI state regulations *Section A-83.43 (7) Commercial Facilities*, Comm 83 Appendix)

Contaminant	Unit Loading Factor lb/capita per day	Value		
		Unit	Range	Typical
BOD <sub>5</sub>	0.180	mg/L	216 - 540	392
SS	0.200	mg/L	240 - 600	436
NH <sub>3</sub> as N	0.007	mg/L	7 - 20	14
Organic N as N	0.020	mg/L	24 - 60	43
TKN as N	0.027	mg/L	31 - 80	57
Organic P as P	0.003	mg/L	4 - 10	7
Inorganic P as P	0.006	mg/L	6 - 17	12
Grease		mg/L	45 - 100	70

Tertiary treatment technologies may be considered for attaining more stringent water quality limits, or maintaining current water quality effluent standards on a smaller facility footprint (i.e., plant treatment capacity increase without physical footprint increase). Tertiary treatment may include suspended solids (colloid) and nutrient removal. Nitrogen removal can be accomplished with variations of secondary

treatment (Sections F and G.4) - primarily activated sludge processes, recirculating media filters, and other fixed film unit processes. Phosphorus removal can be accomplished both biologically and physically/chemically.

The Water Environment Federation (WEF) has developed a table that lists various advanced technologies for nutrient removal in *WEF Manual of Practice No. 8 – Vol. 2 – Fourth Edition – 1998 (Table 15.1)*. Below is the table (Table G-2), adapted from the manual. Consult the footnotes to Table G-2 for help in creating a conceptual design of an advanced treatment system for nutrient removal.

Section F.1 also discusses guidance on third party certification of certain technologies and additional management and maintenance required for secondary and tertiary treatment systems. NSF International Inc.'s standards development for tertiary systems is currently limited to NSF/ANSI Standard 245: *Wastewater Treatment Systems - Nitrogen Reduction*. NSF/ANSI Standard 245 applies to design flows of residential strength between 400 and 1,500 gpd. For systems discharging greater than 1,500 gpd to an STS, multiple NSF-approved systems, or another treatment technology chosen from these Design Standards, *Ten States Standards* or *TR-16* may be used.

*Ten States Standards* tertiary treatment technology selection provides information on “Phosphorus Removal by Chemical Treatment and High Rate Effluent Filtration.” *TR-16* devotes an entire chapter on “Physical and Chemical Processes for Advanced Treatment,” covering the following topics:

- Granular, media, disc and membrane filtration
- Chemical treatment
- Effluent reoxygenation
- Total organic carbon removal

These two standards together provide design guidance for advanced treatment systems. These Design Standards provide additional considerations that should also be referred to. Any conflicts between standards will be reviewed at the discretion of the Reviewing Engineer. Proprietary technologies will be approved according to the procedure in Section H.

Additional references include the Water Environment Federation's *1992 Manual of Practice No. 8*, and the *2002 EPA Onsite Wastewater Treatment Systems Manual*. The *OWTS Manual*, Technology Fact Sheet 8 “Enhanced Nutrient Removal of Phosphorus,” and Technology Fact Sheet 9 “Enhanced Nutrient Removal of Nitrogen” describe available technologies, design, operation, maintenance, and management/ cost considerations for nutrient removal systems.

**Table G-2 Conceptual Process Selection for Nutrient Removal**

Process	Effluent Quality <sup>49</sup>								
	Reference Documents <sup>50</sup>	Secondary <sup>51</sup>	5 mg/L BOD	5 mg/L TSS <sup>52</sup>	Nitrification 20 mg/L Nitrate Nitrogen	10 mg/L Nitrate Nitrogen (BNR)	3 mg/L Total Nitrogen <sup>52,53</sup>	1.0 mg/L Total Phosphorus <sup>52</sup>	0.5 mg/L Total Phosphorus <sup>52</sup>
Activated Sludge	8, 10, 34, TR	X	M	X	M				
Extended Aeration (e.g., oxidation ditch)	8, 10, 34, WQML, TR	X	M	X	X	M			
A/O <sup>TM</sup>	8, 34, WQML, TR	X	M	X	M			M	
Modified Ludzack-Ettinger (MLE)	8, 34,TR	X	M	X	X	X			
PhoStrip <sup>TM</sup>	8, 34, EPA-P	X	M	X	M	M		X	X
Trickling Filters	8,10, TR	X			M				
Bardenpho <sup>TM</sup>	8, 34,TR, WWE	X	M	X	X		M		
Sequencing Batch Reactors	8, 10, TR, EPA-SBR	X	M	X	M	X	M	M	
Chemical Addition (alum, lime, or iron salts)	8, 34, TR, EPA-P							X	X

<sup>49</sup> 'X' denotes process capable of producing effluent meeting indicated standard.

'M' denotes process should be capable of meeting indicated standard with proper design, acceptable influent characteristics, and/or tertiary filtration.

<sup>50</sup> '10' denotes 10 State Standard; 'TR' denotes TR-16 ; '8' denotes WEF MOP No. 8 - 2010; 'EPA-SBR' denotes EPA 832 R-92-002 "Sequencing Batch Reactors for Nitrification and Nutrient Removal"; 'EPA-P' denotes EPA 625 1-87-001 "Design Manual-Phosphorus Removal"; '34' denotes WEF MOP No. 34; 'WWE' denotes "Cut P and N without Chemicals"(Water & Wastes Engineering –July and August 1974 – Barnard, J.L.); 'WQML' denotes Water Quality Management Library "Design and Retrofit of Wastewater Treatment Plants for Biological Nutrient Removal-Vol. 5" – Randall, Barnard and Stensel (1992)

<sup>51</sup> 20-30 mg/L effluent BOD<sub>5</sub> and total suspended solids (TSS)

<sup>52</sup> Filtration is recommended to meet the indicated standard.

<sup>53</sup> Limit of Technology

## **G.2 Granular Media Filters: High-Rate or Low-Rate Secondary Effluent Filtration**

Granular media filters may be used for secondary treatment or as a tertiary/advanced treatment device for removal of residual suspended solids, nutrients and pathogens from secondary effluents. For example, granular media filters should be considered where final effluent concentrations of less than 20 mg/L of suspended solids and/or 1.0 mg/L of phosphorus are required by permit, or to obtain adequate turbidity reduction for urban water reuse.

A pre-treatment process such as chemical coagulation and sedimentation or other acceptable process should precede filter units where: (1) final effluent suspended solids requirements are less than 10 mg/L, (2) secondary effluent quality can be expected to fluctuate significantly, or (3) filters follow a treatment process that generates significant amounts of algae. *TR-16* has additional information on pre-treatment options specifically for post-secondary suspended solids removal.

---

### Low-Rate Granular Media Filters

---

Design requirements for intermittently loaded low-rate granular media filters, e.g., intermittent sand filters, are discussed under secondary treatment methods (Section F.2 in these Design Standards) but can also be used for tertiary treatment of secondary effluent from trickling filters or activated sludge processes to achieve nutrient and/or pathogen removal. Intermittently loaded low-rate granular media filters may also use recirculation to improve final effluent quality. When used in this situation, re-circulating sand filters may have secondary effluent applied at loading rates up to 10 gpd/sq. feet. One operational advantage of low-rate granular media filters is that they do not require backwashing, as high-rate granular media filters do.

---

### High-Rate Granular Media Filters

---

Both *TR-16* and *Ten States Standards* distinguish between high-rate “gravity filters” and high-rate “pressure filters” and provide design requirements for both. Design guidance for pressure filters (micro-filtration and ultra-filtration) is much more extensive in *TR-16*.

For high-rate granular media filtration processes, *TR-16* and *Ten States Standards* include design guidance for deep-bed stratified granular media units using single-, dual-, or multi-media filters with down flow regimes. Other high-rate filter units may be used if the design engineer has sufficient documented

experience or performance data to provide a sound basis for using them.

Because operation and maintenance requirements may be significant, high-rate filters should not be allowed for intermediate sized treatment facilities except where it can be demonstrated that required supervision will be provided.

The designer is responsible for selection of media to meet specific conditions and treatment requirements of the project under consideration. However, Table G-3 provides a list of typical media sizes and minimum media depths for intermittently backwashed, high-rate gravity filters.

**Table G-3 Typical Media Sizes and Minimum Depths**

	Single Media		Dual Media		Multi-Media	
	Size (mm)	Depth (inch)	Size (mm)	Depth (inch)	Size (mm)	Depth (inch)
Anthracite	-	-	1.0 to 2.0	20	1.0 to 2.0	20
Sand	1.0 to 4.0	48	0.5 to 1.0	12	0.6 to 0.8	10
Garnet or Similar	-	-	-	-	0.3 to 0.6	2

Note: For design considerations for High-Rate Granular Media Filters, refer to *10 State Standards* and *TR-16*.

### **G.3 Physical-Chemical Unit Processes**

A physical-chemical process is a unit operation that uses chemical reaction and/or physical separation to remove pollutants from wastewater, typically for nutrient removal. Physical-chemical processes are more effective in removing phosphorus than nitrogen. *TR-16* addresses “Physical-Chemical Phosphorus Removal and Chemical Precipitation for Phosphorus Removal.” Biological nutrient removal is covered in Section G.4 of these Design Standards, in *TR-16*; and in *Ten States Standards*.

#### **G.3.a Colloid (Suspended Solids) Removal**

Systems employing the physical-chemical mode of treatment in lieu of, or to compliment, biological treatment may include a combination of coagulation, settling, and filtration. Colloid removal using coagulation and settling may be used to remove phosphorus, suspended solids, or organic materials. *TR-16* provides additional guidance on both phosphorus and total organic carbon removal from wastewater.

1. Chemicals: Coagulation of solids may be accomplished through use of lime or aluminum or iron compounds (usually alum or ferric chloride). In the use of lime, neutralization of high pH may be required prior to discharge.

Polyelectrolytes (polymers) may be used alone as coagulants or as aids to other coagulants. Coagulant aids may be used to optimize floc growth and hasten settling and may allow the dosage of primary coagulant to be decreased. When polymer use is anticipated, potential solids generation and handling should be considered during design. Treatment systems should have flexibility to allow the use of polymer as a coagulant aid if necessary in the future.

The use of a liquid supply of metal salt instead of a dry form should be considered at small plants because handling requirements would be decreased, although transportation costs may be higher.

Safety equipment appropriate for the chemical type and form should be provided. This may include dust masks, respirators, goggles, face shields, and protective clothing for operators. If dry chemicals are used, it may be necessary to install dust collectors in storage and handling areas. Optimum chemical type and dosage should be determined by jar testing, preferably followed by pilot plant work. Dosage equipment should be sized to cover a range up to twice the recommended dosage and should be constructed of materials that will resist the caustic or corrosive nature of the chosen chemical.

Provision for a complete mix of the chemical with the sewage, as quickly as possible, should be included. Following complete mixing, gentle agitation should be provided for a period necessary to allow floc to form.

2. Settling: Detention time in the settling facilities after chemical coagulation should be long enough to allow floc to settle. Facilities should be designed to achieve a surface settling rate no greater than 800 gpd/sq. feet. Sludge withdrawal mechanisms should be designed to prevent disruption to or loss of the floc blanket. Inlets and outlets should be designed to dissipate velocity, to distribute and receive flow equally, and to prevent short circuiting. A baffle should be provided at the outlet end to retain oils, greases, and other floatable material.
3. Filtration: Filtration may be of either the high-rate or low-rate type. Filter criteria are presented in Section G.2 of this publication. Filter dosage may be up to 5 gallons per minute/sq. ft. for high-rate

filters (Section G.2) and 10 gpd /sq. ft. for the open low-rate type (see Section F.2).

### **G.3.b Physical-Chemical Phosphorus Removal**

1. Chemicals: Aluminum compounds (salts), iron compounds (salts) or lime react with orthophosphate to form insoluble phosphate colloids. Alum is generally preferred as lime may generate excessive sludge and high pH, and iron compounds may result in iron leakage into the effluent (see safety concerns noted above).
2. Dosing: Chemical addition may occur prior to primary clarifiers (including septic tanks), secondary treatment tanks, or final clarifiers either in a separate mixing basin or in a turbulent portion of the system. *TR-16* recommends the addition of metal salts to both primary and secondary treatment facilities as the most cost-effective means of phosphorus removal by chemical precipitation. Ferrous salts may also be added prior to, or in, the secondary treatment (aeration) tank. Ferrous salt should be oxidized to the ferric state before it will precipitate out iron phosphate in the clarifier. Avoid adding ferrous chemicals to the final clarifier, as this will result in increased chlorine demand, increased suspended solids resulting in ineffective UV disinfection, and higher TSS and color in the plant effluent.

If nitrification is desired during biological treatment, dosing should occur prior to primary settling, to reduce BOD load on the biological system. If a high percentage of the total phosphorus is present as polyphosphate or organic phosphate, dosing should occur after biological conversion to orthophosphate. When high levels of detergents (polyphosphate) are present, dosing with aluminum or iron compounds should occur after biological treatment to avoid competing side reactions of the detergent with the metal ion.

*TR-16* provides additional information on chemical application points, where adequate turbulence will ensure complete mixing of the metal salt with wastewater. If there is an internal recycling stream in the treatment plant such as recycles from sludge treatment facilities, the application point should be downstream of the plant's internal recycle streams.

Jar tests for dosage estimation should simulate treatment plant conditions. Mixing speed should be adjusted to match the hydraulic regime in the plant, but the duration of mixing

should be the same as it is in the plant. To approximate settling conditions, the mechanism should not be motionless but should turn very slowly. If possible, jar tests should be followed by 30-day pilot plant or full scale tests.

Phosphorus levels show significant diurnal variations, so it is recommended the dosage be adjusted regularly (normally three to five changes in dose rate per day during initial phases of application). Flow equalization may be provided to reduce the number of necessary dosage adjustments.

Overdosing will prevent floc growth and settling, and can dangerously reduce the pH through formation of hydroxide salts. The addition of lime or sodium hydroxide may be needed to prevent this, especially if aeration is not provided in the aeration tank to oxidize ferrous chemicals to the ferric state.

3. Optimization: To maintain effluent quality, pH adjustment is necessary. Addition of metal salts or lime can be followed by addition of polyelectrolyte to improve settling. Multi-media filtration is recommended if consistently low phosphorus levels (below 1 mg/L) are necessary.
4. Sludge: During design, consideration should be given to the generation and disposal of additional sludge from chemical treatment.

*TR-16* recommends the use of chemical precipitation for phosphorus removal process be based on:

- Chemical analysis of influent wastewater
- Objective effluent criteria
- Capability of alternative wastewater treatment processes such as biological nitrogen and phosphorus removal processes

AND

- Overall economies of alternative processes

*TR-16* also provides recommendations for economic evaluation, discussion of the various forms of phosphorus in wastewater, a comment on the declining use of lime in comparison to metal salts, and the need to provide adequate alkalinity. *TR-16* gives recommendations



for chemical storage and feed facilities as well.

*Ten States Standards* provides both duplicative and complementary design guidance for phosphorus removal by chemical treatment (but not for biological removal). Design guidance and specifications from both *TR-16* and *Ten States Standards* should be followed.

### G.3.c Membrane Processes and Membrane Bio-Reactors (MBRs)

A Membrane Bio-Reactor (MBR) incorporates a membrane to replace the secondary clarifier in the activated sludge process and generates an effluent similar to that described in Table G-4. More guidance on MBRs can be found in *TR-16*.

**Table G-4 MBR Typical Performance Data<sup>54</sup>**

Effluent BOD	mg/L	<5
Effluent TSS	mg/L	<0.5
Effluent NH <sub>3</sub>	mg/L	<1
Effluent TN	mg/L	<10
Effluent turbidity	NTU	<1

*TR-16* provides filtration design guidance for advanced suspended solids removal, chemical phosphorus removal, and total organic carbon removal. *TR-16* also has guidance on four categories of filtration for removal of suspended or dissolved particles:

- Microfiltration: 0.1 to 10 microns (most bacteria, protozoans including cryptosporidium and giardia, some viruses)
- Ultrafiltration: 0.01 to 0.1 microns (most all viruses)
- Nanofiltration: 0.001 to 0.01 microns (metals, personal care product and pesticide constituents, charged organics including nitrates)
- Reverse osmosis: Less than 0.001 microns (water softening, water reuse as drinking water, pure water production for food beverage processing)

Note: The various ranges of particle sizes provided above are typical for the particular categories of filtration.

---

<sup>54</sup> Metcalf and Eddy, Fourth Edition 2003, pp. 1127, 1128

## G.4 Biological Nutrient Removal

Biological Nutrient Removal is the biological removal of nitrogen and phosphorus from wastewater through assimilation into the biomass during oxidation of organic compounds in the treatment process. For on-site wastewater treatment facilities discharging to Soil-based Treatment Systems (STS), biological nutrient removal can be accomplished using shallow soil absorption systems for nutrient uptake by the system's cover vegetation.

---

### Treatment Plant Unit Processes

---

For treatment plant unit processes, several types of treatment processes are available for biological removal of nitrogen and phosphorus from wastewater, including biological nitrogen removal processes, biological phosphorus removal processes, and biological processes for simultaneous removal of nitrogen and phosphorus. *Ten States Standards* does not discuss any tertiary biological treatment systems for either N or P. *TR-16* provides general guidance on design considerations, features, performance capabilities, and operating requirements. The biological nutrient removal systems in *TR-16* include four treatment systems that remove both nitrogen and phosphorus. When designing new plants, plant expansions, and retrofits of existing plants for nitrogen and phosphorus biological removal, the use of process simulators, EPA's 2010 *Nutrient Control Design Manual*, and other available information is recommended. The EPA's *Design Manual* also includes two tables that provide an excellent starting point for engineers and reviewers evaluating a biological nutrient removal (total nitrogen and phosphorus) design.

In selecting a process or combination of processes, the design engineer should consider the following criteria:

- Influent wastewater characteristics, including five-day Biochemical Oxygen Demand (BOD<sub>5</sub>), Chemical Oxygen Demand (COD), Total Kjeldahl Nitrogen (TKN), Total Phosphorus (TP), Alkalinity, and Temperature
- Seasonal variations in influent wastewater characteristics caused by institutional contributors, population changes, septage, and other factors where applicable
- Discharge limitations
- Existing treatment facilities at the plant site
- Cost

## G.4.a Biological Nitrogen Removal

In the first step of the two-step nitrification-denitrification process, ammonia and organic nitrogen present in the wastewater are oxidized to nitrite and then to nitrate by autotrophic nitrifying bacteria (*Nitrosomonas* and *Nitrobacter*) under aerobic conditions. In the second step, nitrates are reduced to nitrogen gas by heterotrophic bacteria under anoxic conditions. Nitrogen gas produced from the denitrification process escapes into the atmosphere, removing total nitrogen (TN) from the wastewater.

In suspended growth activated sludge systems, microbial growth occurs in mixed liquor kept in suspension by turbulence created by aeration or mechanical mixing devices. Suspended growth systems use selectors that can be anaerobic, anoxic, or aerobic.

Some suspended growth processes commonly used for biological nitrogen removal are single-sludge processes. The following are described in *TR-16*:

- Modified Ludzack-Ettinger (MLE) process
- Bardenpho process
- Cyclical aeration process
- Oxidation ditch process

In attached growth (fixed-film) systems, microbial growth occurs on fixed surfaces.

Fixed-growth systems can be configured using a number of stages, with more stages warranted as treatment requirements become more stringent.

Moving bed biofilm reactors use media supporting a biofilm growth that can be either aerobic (for carbonaceous removal and nitrification) or anoxic (for denitrification).

Biological filter processes include biologically active filters (BAF) that encompass both aerobic (nitrification) and anoxic (denitrification) filters.

Rotating biological contactor systems can be configured to accomplish total nitrogen removal, if sufficient aerobic and anoxic solids retention times are provided.

Sequencing batch reactors can provide a moderately high level of nitrogen removal by controlling overall cycle time and duration of steps in the SBR sequence of operation.

Integrated fixed film/activated sludge systems can incorporate media configured to work in an aerobic or anoxic environment, but the designer should understand the balance and synergy between the attached and suspended-growth biomass components. *TR-16* provides design information and details regarding anoxic and aerobic reactor design for nutrient removal. There is also design information on solids removal processes that may also be beneficial in achieving low TSS and nutrient limits.

Design guidance for secondary clarification is given in both *TR-16*, and in *Ten States Standards*. Either may be used for intermediate-sized systems.

#### **G.4.b Biological Phosphorus Removal (BPR)**

Biological phosphorus removal (BPR) or enhanced biological phosphorus removal (EBPR) is discussed in *TR-16*. EBPR is achieved by wasting sludge from a treatment system with an excess amount of phosphorus stored in the bacterial cells. The two most commonly used EBPR processes are:

- PhoStrip™ process (proprietary)
- A/O (Phoredox) process (*TR-16*)

The PhoStrip™ process uses the return sludge flow for phosphorus removal. In the A/O (Phoredox) process, phosphorus removal reactions occur as wastewater passes through units of the treatment system. The *Handbook of Biological Wastewater Treatment: Design and Optimisation of Activated Sludge Systems*<sup>55</sup> provides greater detail on biological phosphorus removal processes.

#### **G.5 Constructed Wetlands**

A constructed wetland is a treatment process typically used to remove nutrients, suspended solids, and organic matter. Designing a constructed wetland is complicated and should be done only by a licensed professional engineer experienced in their design. The services of qualified soil scientists and wetland biologists may also be necessary.

Table F-1 lists Vegetated Submerged Beds and Free Water Surface Constructed Wetlands as means for

---

<sup>55</sup>Adrianus C. van Haandel, J. G. M. van der Lubbe IWA Publishing, 2012

suspended solids removal by sedimentation. However, for carbonaceous BOD and ammonium removal and biological nitrification-denitrification, only Free Water Surface Constructed Wetlands are recommended. Vegetated Submerged Beds are recommended for biological denitrification only, following another unit process that provides nitrification.

The primary design reference for constructed wetlands is *Constructed Wetlands and Aquatic Plant Systems for Municipal Wastewater Treatment - Design Manual*.<sup>56</sup> TR-16 may be consulted for additional guidance on the use or selection of constructed wetlands.

The 2002 EPA Onsite Wastewater Treatment Systems Manual, Technology Fact Sheet (TFS) 5 describes vegetated submerged beds and other high specific surface anaerobic reactors, but no design standards are given. Vegetated submerged beds and subsurface flow constructed wetlands are equivalent. The 2002 EPA TFS-7 describes stabilization ponds, free water surface constructed wetlands, and other aquatic systems.

WEF's *Manual of Practice No.8, Design of Municipal Wastewater Treatment Plants* (1998) contains some information on the three most generally recognized types of constructed wetlands: free water surface, subsurface flow, and vertical flow. The vertical flow wetlands are only described briefly, and their construction is generally similar to either an intermittent sand filter (European) or a vegetated recirculating gravel filter (North American).

The EPA 1993 Report, *Subsurface Flow Constructed Wetlands for Wastewater Treatment: A Technology Assessment*<sup>57</sup>, evaluates only the subsurface flow (SF) systems.

WEF's *Manual of Practice No.8, Design of Municipal Wastewater Treatment Plants* (1998) and TR-16 both discuss reed beds as a sludge dewatering method, not as a constructed wetland for secondary treatment.

---

<sup>56</sup> *Constructed Wetlands and Aquatic Plant Systems for Municipal Wastewater Treatment Design Manual*, U.S. Environmental Protection Agency, Office of Research and Development, Center for Environmental Research Information, Cincinnati, OH, 45268, EPA/625/1 88/022, September 1988.

<sup>57</sup> EPA, *Subsurface Flow Constructed Wetlands for Wastewater Treatment: A Technology Assessment*, EPA 832 R 93 008. U.S. Environmental Protection Agency, Office of Water, Washington, D.C. 1993.

## **H. Innovative Systems**

An innovative system is any wastewater treatment system that is not in these Design Standards. It may be an entirely new technology, or one that has been accepted for use in other states or countries but is new to New York State, or that has proven effective in a field other than wastewater treatment.

The Department is open to development of any acceptable methods or equipment for treatment of wastewater. The absence of some types of wastewater treatment processes or equipment in these Design Standards should not be construed as precluding their use, only that site specific approval by the Reviewing Engineer will be necessary for use in New York.

Innovative technology review is applicable only to projects requiring an individual SPDES permit. The burden of proof is on the licensed professional engineer to demonstrate that a given process, or system of unit processes and equipment, will provide adequate, reliable and long-term treatment that complies with permit requirements, without excessive energy consumption or operator attention.

The following outlines NYSDEC's innovative technology review considerations:

1. The system designer needs to show NYSDEC that any system will work under various conditions, and can meet the SPDES permit requirements for receiving water:
  - Technical information from a sales brochure is insufficient. Site-specific and application-specific information is needed, and any applicable design criteria of these Design Standards or nationally recognized standards need to be met or exceeded.
  - Technical documentation should include calculations that demonstrate the unit's ability to provide the pollutant removals required by the SPDES permit for the specific facility's wastewater being treated.
2. To avoid confusing the roles of the manufacturer, design engineer and contractor to assure proper design, system and component specifications, and installation of parts and entire units, NYSDEC requires provisions that:
  - Prevent contractors from offering substitutions that attempt to meet "or equal" specs, but cause problems with the system operation
  - Assure availability of necessary equipment and parts should the manufacturer go out of business

- Prevent early failure of the system due to faulty design or specifications.
  - Indicate thorough review by the design engineer submitting the application
  - Indicate that appropriate steps for local review and approval have been secured.
3. NYSDEC requires contract and specification details supporting system longevity:
- Are there seemingly minor omissions that may lead to operational problems?
  - Is the system designed to last (i.e. durable construction materials, corrosion protection)?
  - Is availability of replacement parts or consumables necessary to the process?
4. Before NYSDEC accepts a design, a record of performance demonstrating reliability is required. The full-scale “reference” system should:
- Be in a similar climate and other conditions which may be encountered in the area of the proposed installation (including diurnal variations)
  - Have similar effluent limitations and operate under various ranges of influent strength
  - Have sampling results to show removal effectiveness – sets of composite samples over several months, including all seasons
  - Provide data appropriate for all permit parameters and flow rates, and other appropriate information
5. The design engineer should review details of the installation and indicate in the permit application that he or she (or his or her representative) will spend sufficient time during construction to make sure everything is properly installed, and that the wastewater treatment system owner will provide an appropriately certified operator, and adequate service time to manage and maintain the system once it is operational.
6. NYSDEC or another reviewing authority may require a contingency plan, including replacement of the innovative/alternative system should it fail to consistently meet discharge limits or if it creates a nuisance.
7. NYSDEC may ask for data on system performance over time. NYSDEC also may require appropriate testing at certain intervals and evaluations done under the supervision of a licensed professional engineer with expertise in the treatment process(es) proposed.

8. NYSDEC may require other permits besides the SPDES permit, so design engineers should be aware of site limitations, e.g., they should not use invasive species in a “polishing” wetland or in a sludge drying bed.



## **I. Disinfection and Reoxygenation**

### **I.1 Introduction**

Disinfection is a treatment process to remove pathogens in the wastewater being discharged. Disinfection design guidance is limited to chlorination, dechlorination, and ultraviolet disinfection. Other methods may be considered through the process described in Section H.

Effluent reoxygenation introduces additional oxygen into wastewater so the oxygen content in the discharge meets permit requirements. Design guidance is provided in WEF's *Manual of Practice No.8 Design of Municipal Wastewater Treatment Plants* (1998). The manual also includes diffused/mechanical and cascade aeration, outfall specifications, and controlled release requirements.

### **I.2 Disinfection and Dechlorination**

#### **I.2.a Disinfection**

The purpose of disinfection is to continuously reduce or eliminate harmful bacteria, viruses and pathogens from treated effluent for public health and water quality protection. The most common disinfection methods for on-site treatment systems are chlorination and ultraviolet light (UV). The use of UV is preferred as no residual byproducts are introduced into wastewater after disinfection. Advantages and disadvantages should be weighed when choosing a method of disinfection. Although the use of UV and chlorination are the only disinfection methods discussed herein, other methods, including ozonation may be considered under the process described in Section H of these standards.

Where New York State is a member of an interstate compact, it will conform to the interstate commissioner's rules on disinfection if they are more restrictive than New York's requirements.

#### **I.2.b Chlorination**

Chlorine disinfection is usually accomplished with liquid (sodium hypochlorite) or solid chlorine tablets (calcium hypochlorite). The chlorination method selected should be based on wastewater flow rates, application and demand rates, pH of wastewater, cost of equipment, chemical availability, required maintenance and safety concerns.

Chlorination feed equipment should be adequately sized to produce a concentration of chlorine to dependably and consistently reduce the pathogen concentration to that specified in the SPDES permit for the installation.

Chlorine feed systems can consist of stack-feed devices for chlorine tablets or solution feeders for sodium hypochlorite systems. Tablet feed systems may be preferable for small discharge systems (flow rate under 30,000 gpd). Liquid hypochlorite storage tanks should be constructed of a compatible material and provide ample volume for several weeks of operation. Positive displacement pumps capable of feeding a measured volume of hypochlorite solution during a specific period should be used in solution feeders. Liquid feed lines should be protected from freezing. Chlorination feed equipment typically is fixed to the inlet end of the chlorine contact tank.

Chlorine should be applied to wastewater in an area that can provide adequate mixing. After mixing, a minimum contact period of 15 minutes at peak hourly flow or maximum pumping rate should be provided in a chlorine contact tank.

Normally a 0.5 mg/L total chlorine residual present after 15 minutes of contact time is sufficient to reduce the coliform concentration to the acceptable level. Effluent monitoring will indicate whether higher concentration levels should be maintained. Other pathogen indicators may require a different concentration and/or contact time to achieve the desired level of disinfection.

The chlorine contact tank should be constructed with baffles to prevent short-circuiting flow and any floating material from leaving the tank. Over-and-under or end-around baffling should be provided for this purpose. Provision for draining the contact tank for cleaning should be included. The drain should be valved, and the tank bottom should taper to the drain or a sump to facilitate cleaning and draining.

Periodic analysis of both the chlorine residual after contact time and bacterial analysis prior to discharge are recommended and may be a permit requirement. Both *TR-16* and *Ten States Standards* provide design guidance for chlorination systems.

### **I.2.c Dechlorination**

De-chlorination of a chlorinated effluent discharge may be necessary to protect the receiving stream, and may be achieved by aeration, activated carbon, and chemical treatment. Sulfur dioxide has been the most common chemical used as a de-chlorinating agent, but other chemicals such as sodium bisulfite and sodium

metabisulfate may also be used. De-chlorination chemicals should be applied in an area where effluent flow is turbulent and short-circuiting is minimal, just prior to discharge. A contact period of one to five minutes should be sufficient for reaction to occur.

If the design of a dechlorination system is necessary for the treatment process, the guidelines outlined in *TR-16* or *Ten States Standards* should be followed.

#### **I.2.d Ultraviolet Disinfection**

An ultraviolet (UV) disinfection system uses UV radiation generated by an electrical current through a mercury vapor lamp to penetrate the genetic material of micro-organisms and interfere with their ability to reproduce. The optimum wavelength to effectively inactivate microorganisms is in the range of 250 to 270 nanometers (nm).

Effectiveness of a UV disinfection system depends on the characteristics of the wastewater, the intensity of the UV radiation, the amount of time the microorganisms are exposed to the radiation, and the reactor configuration. Therefore, the presence of excessive particulate matter, turbidity, dissolved compounds that adsorb UV, short circuiting of flow through the reactor, and accumulation of substances on the lamps, can all reduce the effectiveness of UV systems.

Ultraviolet transmittance (UVT) or absorbance properties of water are critical for UV to be effective. UV transmittance (UVT) should be 65 percent or greater, and total suspended solids less than 30 mg/L. Pretreatment by intermittent sand filtration is recommended if suspended solids are higher than 30 mg/L before the UV disinfection system. Several manufacturers produce in-line UV disinfection systems that can be used for disinfection of treated effluent. Septic tank effluent or effluent with high TSS would be difficult to disinfect adequately with UV and would not be considered an acceptable disinfection option by NYSDEC.

When designing UV disinfecting systems, both *Ten States Standards* and *TR-16* should be followed. *Ten States Standards* advises a case-by-case review, and gives design, safety and operational guidelines. A minimum operating UV dosage of 30,000 microwatts-second/cm<sup>2</sup> is required after accounting for typical energy absorption losses. *TR-16* includes additional specifications for lamp design and performance, configuration and specifications for open channel units, and recommendations for monitoring and cleaning systems.

Additionally, specific design conditions depend on the technology used and manufacturer's recommendations, and more important, the technology selected depends on the specific disinfection objectives (target pathogens and concentrations [MPN/100 mL], etc.), water quality characteristics, level and consistency of influent flow and treatment, and sampling requirements.

The main components of a UV disinfection system are mercury arc lamps, a reactor, and ballasts. To operate within SPDES permit limitations, the UV disinfection system should consist of multiple banks of lamp modules capable of continuously disinfecting peak flow with one bank out of service.

The UV unit should be protected from dust, excessive heat, and freezing temperatures. Adequate ventilation of heat-generating electrical components should be provided. A logbook of required maintenance should be kept. Smaller plants should maintain an inventory of spare lamps and modules on-site. In small systems, it may be just as effective to use a single bank of lamps (with spare lamps onsite) as to install a second bank of lamps as a backup unit. Once the operator is on-site, replacing a lamp or module is just as effective and nearly as quick as switching power to the backup unit.

UV systems require power to operate, so the availability of standby power is a critical measure of their reliability. Some standby power source is necessary in nearly all cases.

---

#### System Validation

---

UV system technologies should have independent third-party bioassay validation covering the proposed range of design conditions in accordance with the *EPA Design Manual - Municipal Wastewater Disinfection* (EPA/625/1-86/021). If wastewater recycling is the goal of the treatment system, then the *NWRI Ultraviolet Disinfection Guidelines for Drinking and Water Reuse* should be consulted.

### **I.3 Effluent Reoxygenation**

#### **I.3.a General**

Effluent reoxygenation may be used when the level of dissolved oxygen in the effluent must be higher than is available from the process and/or when the chlorine level must be reduced prior to discharge. Reoxygenation should be accomplished in its own unit and may not be combined with chlorination facilities. Effluent re-oxygenation is similarly addressed in *TR-16* and briefly in *Ten States Standards*.

#### **I.3.b Diffused or Mechanical Aeration**

A detention time of at least 30 minutes at peak flow should be provided to achieve the necessary level of dissolved oxygen concentration. Air should be provided at a minimum of 20 SCFM (Standard Cubic Feet per Minute) for each 1,000-gallon capacity of wastewater in the unit.

Three types of aeration units may be used: floating aerator, fixed aerator, or diffused air. Mechanical aeration requires a shallow tank with a larger surface area. Diffused air allows the use of deeper rectangular tanks. When using diffused air, a side roll is preferred over an end-roll effect.

The inlet should be raised sufficiently to allow for expansion created by the addition of air. The outlet should be properly baffled to minimize discharge of foam generated by aeration.

#### **I.3.c Cascade Aeration**

Step or cascade aerators are especially useful when the needed dissolved oxygen increment is small or moderate. Cascades consist of a series of weirs or concrete or metal steps over which effluent flows in a thin sheet. Edges of metal steps may have low weirs. The objective of a cascade is to maximize turbulence, thus increasing oxygen transfer.

The following equation may be used to obtain an estimate of aeration potential:

$$h = (r - 1) / [0.11ab (1 + 0.046 T)]$$

Where,

h = Height (in feet) through which water falls

r	=	Deficit ration = $(C_s - C_o) / (C_s - C)$
C <sub>s</sub>	=	DO saturation concentration of wastewater at temperature T, mg/L
C <sub>o</sub>	=	DO concentration of influent to cascade, mg/L
C	=	Required DO level after aeration, mg/L
T	=	Water temperature, degrees Celsius
a	=	Water quality parameter, equal to 0.8 for wastewater treatment plant effluent
b	=	Weir geometry parameters

Parameter “b” should be set equal to 1.0 for free weirs, 1.1 for concrete steps, and 1.3 for step weirs unless analysis of a particular design shows that individual characteristics justify use of a different value.

Head requirements generally vary from 3 to 10 feet, and effluent pumping may be necessary if the required head is not available. Normally less than 100 square feet of surface area is needed per MGD (Million Gallons per Day) of capacity. Also refer to WEF’s MOP 8: *Design of Municipal Wastewater Treatment Plants* (2010).

## **I.4 Outfalls**

Plant outfalls should be designed with a size and slope that will prevent surcharging and/or interference with preceding treatment processes when the receiving water is at its highest anticipated elevation, and should include diffusion facilities. Following are recommendations regarding outfall location:

- Discharge to a small cove, dead-end embayment, or poorly flushed back channel should be avoided.
- Surface discharge to a shallow near-shore area is discouraged in preference to a submerged outfall located in deep off-shore areas or water bodies.
- In extreme situations where shoreline outfalls are the only option, dispersion of the discharged wastewater should be established.

Diffusers should be:

- Located in the streambed so as to be submerged at low flow
  - Structurally protected against erosion, displacement, and sedimentation
- AND
- Designed to mix effluent and receiving waters thoroughly

Access to a suitable effluent sampling point should be provided to allow for permit compliance sampling.

## **I.5 Controlled Release**

---

### General

---

Controlled release may be employed when discharge is to a stream meeting the definition of an intermittent stream. Prior to holding and discharge, a minimum of secondary treatment should be provided, and the effluent must meet permit limits when discharged.

A controlled-release program should always include the use of stream flow gauging equipment. Mechanical or non-mechanical methods of stream gauging may be employed as long as their reliability is demonstrated in the engineering report.

---

### Design Parameters

---

Controlled release of treated effluent is typically used when sufficient stream assimilative capacity occurs intermittently. A long holding time for the treated effluent is often necessary, until the receiving stream has sufficient flow to assimilate the effluent discharge. A holding lagoon is typically used because it has ample storage capacity. The holding lagoon should be constructed in accordance with criteria in this Design Standard. Minimum holding capacity should be 200 days, with a recommended capacity of one (1) year. Proper baffling is necessary to prevent discharge of floating algae and duckweed. It is recommended the draw off be from the lower half of the liquid depth.

The valves used to allow discharge should be durable, protected from freezing, accessible, and capable of being secured to prevent discharge by unauthorized personnel. Redundant valves should be provided, and they should be able to close at any pressure situation. To ensure proper operation over time, valves should be exercised as part of a routine maintenance program. The discharge pipe should be secured by a headwall with splash plate. Energy dissipation may be required to prevent erosion.

## **J. Operation, Maintenance, and Control**

### **J.1 Introduction**

Operation and maintenance of treatment facilities is as important as proper design and construction. Therefore, where possible, the system requiring the least operation and maintenance should be given priority. Some operation and maintenance guidance/requirements are given in previous subsections of these Design Standards. O & M (Operation and Maintenance) for the treatment system overall is given here.

Designs should include ample clearance to remove and replace units and parts. To ensure proper operation and maintenance, an operating manual should be provided with all treatment plants.

Recommended contents of an operating manual:

- Approved Design Report
- Hydraulic Profile
- Basic Electrical Schematic
- Basic Plant Piping Schematic
- Unit Operating Theories and Procedures (Standard Operating Procedures)
- Recommended Operating Ranges
- Maintenance Check List (Operations and Maintenance Log)
- Program for Residuals Disposal
- Parts List
- Copies of All Warranties and Guarantees
- Trouble-shooting Guide
- Copy of SPDES Permit
- Compliance Monitoring and Sampling Procedure
- Laboratory (Process Control) Requirements and Testing Schedule
- Operator Requirements and Hours
- Emergency or Breakdown Procedures
- Health and Safety Plan.



## **J.2 Systems Requiring a Certified Operator**

State regulations require that certain sewage treatment plants must be under supervision of an approved operator at all times. According to 6 NYCRR Part 650.1 (c), only the following systems found in these Design Standards are not subject to this requirement:

- (1) Septic tanks followed by subsurface leaching facilities with eventual discharge to groundwater, regardless of the design capacity
- (2) Septic tanks followed by open or covered intermittent sand filters, with a designated capacity of less than 50,000 gallons per day

Grades of operators needed at various types of plants are listed in Table-1 “Chief and Assistant/Shift Operator Grade for Activated Sludge Facilities” and Table- 2 “Chief and Assistant/Shift Operator Grade for All Other Treatment Processes” in 6 NYCRR Part 650.

6 NYCRR Part 650 contains NYSDEC Wastewater Treatment Plant Facility Score Sheet Form. A copy of the form and other information on the NYSDEC Wastewater Treatment Plant Operator Certification Program is available on NYSDEC’s website.

## **J.3 Wastewater Treatment System Operation and Effluent Quality Control**

6 NYCRR Part 750-2.8 Disposal System Operation and Quality Control states requirements of the SPDES permittee in regard to preventive and corrective maintenance, written O & M procedures, maintaining effluent quality, bypasses, and upsets.

## **J.4 Notification Requirements for Emergency Repair and Rehabilitation**

6 NYCRR Part 750-2.6, Special Reporting for Dischargers that are not POTWs, gives requirements for notifying the Department regarding facility expansion and anticipated activities that may alter their wastewater characteristics.

6 NYCRR Part 750-2.7, Incident Reporting, gives requirements for “anticipated noncompliance”.

6 NYCRR Part 750-2.9, Additional Considerations Applicable to POTWs, gives requirements for POTWs with flows that exceed 95 percent of their design flows based on required annual compliance certification reports.

## **J.5 Remote Telemetry, Instrumentation and Alarms**

For cluster- developments, multi-home housing units, commercial and institutional, and small municipal facilities, design engineers should consider remote telemetry to better monitor treatment systems. Wireless, computer-based options are available to owners, operators and service providers to monitor alarm situations, performance of pumps, timers, and event counters associated with mechanized treatment systems. The EPA<sup>58</sup> and the National Onsite Wastewater Recycling Association (NOWRA) websites and publications provide more information.

Alarms (on site and remote) should be considered to alert homeowners and service providers that system malfunction might be occurring. In addition to simple float alarms, several manufacturers have developed custom-built control systems that can program and schedule treatment process events, remotely monitor system operation, and notify technicians by pager or over the Internet of possible problems.

## **J.6 Residuals Hauling and Disposal (6 NYCRR Parts 364 and 360)**

Residual solids from wastewater treatment facilities may contain pathogenic organisms, nutrients, and oxygen-demanding materials. Proper handling and disposal is necessary to protect public health and prevent degradation of groundwater and surface water quality.

For systems operating under a SPDES permit, 6 NYCRR Part 750-2.8(d) requires septic tanks be inspected annually and septage (solids and scum) pumped out when the combined sludge and scum layers equal 25 percent of the tank volume. For STEP or STEG systems, residential septic tanks should be pumped out every two to five years. If inspected annually, the pump-out schedule may be adjusted so long as the combined sludge and scum layers combined do not exceed 25 percent of the tank volume. The bottom of the scum layer should always be three inches or more above the bottom of the outlet device.

The septage from community septic tanks, aerobic biological treatment, or physical-chemical treatment should be removed periodically by a professional hauler. All haulers of sewage sludge must have a valid Part 364 permit. Information as to qualification and certification of haulers, along with the necessary application form, can be obtained at any Department of Environmental Conservation Regional Office. At aerobic or physical-chemical treatment facilities, storage should be provided for twice the volume of sludge

---

<sup>58</sup> 2002 EPA *Onsite Wastewater Treatment System Manual*, (EPA/625/R 00/008, February 2002)

to be generated between anticipated removal dates. Storage may be under either aerobic or anaerobic conditions, and provision should be included to control any possible odors. The sludge can be hauled to a larger sewage treatment plant, or disposed of in an approved manner such as land spreading, land filling, or composting.

If the sewage sludge is to be disposed of in a sanitary landfill, the sludge should be dewatered to at least 20 percent solids, and the sanitary landfill must be approved by NYSDEC. A Part 360 permit is necessary for land spreading or composting of sewage sludge. All land spreading or composting of sewage sludge requires a permit. NYSDEC's website provides more information on land application of organic waste. For bio-solids recycling, the same NYSDEC web page has fact sheets containing more information, definitions of terms, and references. The current list of Part 360 Permitted Land Application Facilities also can be found on NYSDEC's website.

For open sand filter treatment facilities, the scum or solids mat should be raked off the filter at least every six months. Disposal of this sludge must also be in an approved manner as described above.

## Appendix A Wastewater Treatment System Regulatory Framework in New York State

This table is meant as general statewide guidance. Questions regarding applicability of NYSDEC, local health department (LHD) or NYSDOH District Office policy should be referred to the appropriate NYSDEC, LHD or NYSDOH District Office.

System Type	Flow Range (gpd)	Jurisdiction	Technical Standard <sup>59</sup>	SPDES Permit Required?
<b>Residential</b> with subsurface discharge.	≤ 1,000	local health department (LHD), NYSDOH district office, or local code enforcement official (CEO) <sup>59</sup>	<ul style="list-style-type: none"> <li>• Appendix 75-A</li> <li>• Local sanitary codes</li> </ul>	No
<b>Residential</b> with subsurface discharge.	> 1,000 & < 10,000	NYSDEC	<ul style="list-style-type: none"> <li>• these Design Standards</li> </ul>	Yes, may qualify for SPDES General Permit GP 0-05-001.

<sup>59</sup> Under New York State Education Law, all wastewater treatment systems are to be designed by or under the supervision of a design professional. Rules and regulations of local watersheds, the New York City Department of Environmental Protection, or the Adirondack Park Agency may require additional design requirements beyond the minimum state standards (Appendix 75-A or Intermediate Design Standards). Also see NYSDOH Fact Sheet “Need for Licensed Design Professionals – Residential Onsite Wastewater Treatment Systems” available from local health departments (LHDs) or NYSDOH District Offices. Specific office location information can be found on NYSDOH’s website

<b>Existing Residential</b> applying for a surface discharge.	Any	Consult NYSDEC Regional Office (refer to TOGS 1.2.4 for flows less than 1,000 gpd).	<ul style="list-style-type: none"> <li>• these Design Standards</li> </ul>	Yes, may qualify for an individual SPDES Permit.
<b>Private, Commercial and Institutional</b> sanitary sewage (nonindustrial) with subsurface or surface discharge under a NYSDOH permit. <sup>60</sup>	< 10,000	NYSDOH/LHD  NYSDEC (SPDES) <sup>60</sup>	<ul style="list-style-type: none"> <li>• Appendix 75-A</li> <li>• these Design Standards</li> <li>• Ten States Standards (surface discharges only)</li> </ul>	<p>Yes, if subsurface systems are &gt; 1,000 gpd; may qualify for GP 0-05-001.</p> <p>All surface discharges require an individual SPDES permit.</p>

---

<sup>60</sup> Pursuant to the 1984 NYSDEC - NYSDOH MOU, NYSDOH is responsible for approval and regulatory activities regarding all new on-site [subsurface discharge] sewage treatment and dispersal systems with a design flow of 1,000 gpd or less from a residential dwelling which does not have the admixture of industrial wastes or other wastes as defined in Section 17-0701 of the Environmental Conservation Law of the State of New York. This also includes responsibility for plan approval and regulatory actions except SPDES permit issuance activities for all surface and sub-surface discharges of 10,000 gpd or less, and designated by DEC as non-significant at facilities permitted by NYSDOH under Parts 6 (Public Pools and Beaches), 7 (Temporary Residences), 14 (Food Service), 15 (Migrant Labor Camps) and 17 (Mobile Home Parks) of the State Sanitary Code except where written agreements are entered into by NYSDEC with a Federal, State or local governmental agency to perform this responsibility.

<p><b>Private, Commercial and Institutional</b> sanitary sewage (nonindustrial) with surface or subsurface discharge NOT under a NYSDOH permit.</p>	<p>&lt; 10,000</p>	<p>If &lt; 1,000 gpd, design professional, LHD, or CEO.<sup>59</sup> If ≥ 1,000 and &lt; 10,000 gpd, NYSDEC.</p>	<ul style="list-style-type: none"> <li>• Appendix 75-A</li> <li>• Local sanitary codes</li> <li>• these Design Standards</li> </ul>	<p>Not if subsurface discharge is &lt; 1,000 gpd. Otherwise, yes, and all surface discharges require an individual SPDES permit.</p>
<p><b>Private, Commercial and Institutional</b> Sanitary sewage (nonindustrial) with surface or subsurface discharge.</p>	<p>≥ 10,000</p>	<p>NYSDEC</p>	<ul style="list-style-type: none"> <li>• these Design Standards</li> <li>• Ten States Standards (surface discharges only)</li> </ul>	<p>Yes</p>
<p><b>Any System</b> discharging sanitary sewage with admixture of industrial wastes or other wastes, to surface or subsurface waters.</p>	<p>Any</p>	<p>NYSDEC</p>	<ul style="list-style-type: none"> <li>• Multiple references identified in 6NYCRR Part 750 Section 1.24</li> <li>• Ten States Standards (surface discharges only)</li> </ul>	<p>Yes</p>

**Appendix B**
**Conversion Factors**

<b>MULTIPLY</b>	<b>BY</b>	<b>TO OBTAIN</b>
Acres	43,560	Square Feet
Atmospheres	33.9	Feet of Water
Centimeters	0.3937	Inches
Cubic Feet	7.48052	Gallons
Cubic Feet	28.32	Liters
Cubic Feet/Second	449	Gallons/Minute
Cubic Meters	35.31	Cubic Feet
Cubic Meters	264.2	Gallons
Cubic Meters	10 <sup>3</sup>	Liters
Cubic Yards	27	Cubic Feet
Cubic Yards	202	Gallons
Feet	30.48	Centimeters
Feet	0.3048	Meters
Feet of Water	62.43	Pounds/Square Foot
Feet of Water	0.434	Pounds/Square Inch
Gallons	3785	Cubic Centimeters
Gallons	0.1337	Cubic Feet
Gallons	3.785	Liters
Gallons water	8.3453	Pounds of Water
Gallons/Minute	2.228 × 10 <sup>-3</sup>	Cubic Feet/Second
Gallons/Minute	1440	Gallons/Day
Gallons/Minute	0.06308	Liters/Second
Gallons/Day	6.944 × 10 <sup>4</sup>	Gallons/Minute
Gallons/Day/Square Foot	1.604	Inches/Day
Grams	2.205 × 10 <sup>3</sup>	Pounds
Grams/Liter	1,000	Parts/Million
Hectares	2.471	Acres
Horsepower	33,000	Foot- Pounds/Minute
Horsepower	0.7457	Kilowatts
Inches	2.54	Centimeters
Inches/Day	0.6234	Gallons/Day/Square Foot
Kilograms	2.205	Pounds
Kilowatts	1.341	Horsepower
Kilowatts - hours	2.655 × 10 <sup>6</sup>	Foot- pounds
Liters	103	Cubic Centimeters
Liters	0.03531	Cubic Feet
Liters	0.2642	Gallons
Meters	3.281	Feet
Milligrams/Liters	1	Parts/Million
Million Gallons/Day	1.54723	Cubic Feet/Second
Parts/Million	8.345	Pounds/Million Gallons
Pounds	453.5024	Grams
Pounds of Water	0.1198	Gallons
Pounds/Square Inch	2.31	Feet of Water
Pounds/Square Inch	2.036	Inches of Mercury
Temperature (°C) + 17.78	1.8	Temperature (°F)
Temp (°F) - 32	5/9	Temperature (°C)

---

### Low-Pressure Air and Vacuum Testing

---

The proper procedure for low-pressure air testing of sanitary sewers is described in ASTM C828 for vitrified clay pipe, ASTM C924 for concrete pipe, and ASTM F1417 for plastic pipe. The general procedure described in ASTM C828 for low-pressure air testing of vitrified clay pipe may be used for other sanitary sewer pipe material not mentioned above and is not limited to a maximum diameter of 12 inches. The parameter to be measured is the rate of air loss based on an average test pressure of 3.0 psig above any hydrostatic pressure due to any groundwater that may be over the pipe.

It is extremely important the various test plugs be properly installed and braced to prevent blowouts. It is also important to maintain adequate pressure relief valves to prevent over-pressurizing the system. A maximum relief pressure of 10 psi is suggested in most literature.

Although line testing may be done at any time during the construction phase, there are two time periods when testing is of special value:

- 1) Prior to placement of paving materials, to avoid unnecessary expense in locating and repairing leaks
- 2) After work has been completed and some settlement has had a chance to occur

This latter period is the appropriate time for the final line acceptance test, because significant damage can occur after backfill from subsequent settling.

All portions of a new sewerage system should be tested, including any building sewers that may be constructed in conjunction with the main lines.

Air testing for concrete sewer manholes should conform to either the test procedures described in ASTM C1244 - *Standard Test Method for Concrete Sewer Manholes by the Negative Air Pressure (Vacuum) Test Prior to Backfill* or the vacuum testing specifications given in *TR-16*. Manholes which cannot be properly air (vacuum) tested by the ASTM or *TR-16* procedure should be visually inspected and leakage tested using internal or external hydrostatic pressure.



---

## Hydrostatic Testing

---

All conventional gravity sewers, manholes and cleanouts should be tested by any standard method after being flushed and before being used. One procedure for hydrostatic testing of sanitary sewers is described in AWWA C600, *Hydrostatic Testing*. Depending upon the groundwater table elevation, either an infiltration or exfiltration method may be used. The maximum rate of infiltration/exfiltration should not exceed 100 gallons per inch diameter per mile per day, under a minimum positive head of two feet as given in *Ten States Standards*. Manholes should be constructed to be water tight and tested for tightness in accordance with *Ten States Standards or TR-16*.

For STEP systems, service line testing can be accomplished with an air compressor to bring the line to its test pressure; the test is a success if the pressure holds for 60 seconds or more. See AWWA for the allowable leakage rate. When the service line can be filled with water from the tank test, particularly if the service line is short and doesn't require a large volume to fill it, a small hand pump with pressure gauge can be employed for the pressure test.

This section reserved for future use.

## Appendix E Design Examples for Pressure Distribution; Guidance for Mound Systems and Alternative Distribution Systems.

### Appendix E.1 Pressure Distribution Design Example

---

#### Pressure Distribution System Design

---

The following is a design example for a pressurized distribution network for a mound treatment system as described in *Pressure Distribution Network Design*<sup>61</sup>. In this example, the absorption area is 113 feet long x 4 feet wide. The force main is 125 feet long, and the elevation difference between the pump and the mound treatment system discharge is 9 feet with three 90° elbows.

#### 1. Configuration of the network.

This is a narrow absorption unit on a sloping site.

#### 2. Determine the lateral length.

Using a center feed, the lateral length is:

$$\begin{aligned}\text{Lateral Length} &= (B/2) - 0.5 \text{ feet} && \text{Where: } B = \text{the length of the absorption area.} \\ &= (113 \text{ feet}/2) - 0.5 \text{ feet} \\ &= 56 \text{ feet}\end{aligned}$$

#### 3. Determine the perforation spacing and size.

Perforation spacing -

Each perforation covers a maximum area of 6 feet<sup>2</sup>. The absorption area is 4 feet wide.

---

<sup>61</sup> Converse, J.C., 2000. *Pressure Distribution Network Design, Small Scale Waste Management Project Guidance Document #9.14*; University of Wisconsin -Madison.

Option 1: Two laterals on each side of the center feed

$$\begin{aligned}\text{Spacing} &= (\text{area/orifice} \times \text{no. of laterals}) / (\text{absorption area width}) \\ &= (6 \text{ ft}^2 \times 2) / (4 \text{ feet}) = 3 \text{ feet}\end{aligned}$$

Option 2: One lateral down the center on each side of the center feed:

$$\text{Spacing} = \text{area per orifice} / \text{width of absorption area} = 6 \text{ ft.}^2 / 4 \text{ feet} = 1.5 \text{ feet}$$

Best Option:

Ideally, the best option is to position perforations to serve a square, but that may be difficult to do. In Option 1, each perforation serves a 2' by 3' rectangular area, while in Option 2 each perforation serves a 1.5' by 4' area. Because Option 1 most closely approximates a square, it is the better design.

Perforation Size:

Select from 1/8", 3/16" or 1/4". Use 3/16" per the following discussion in the "Design Procedure" section of *Pressure Distribution Network Design*:

"Determine the perforation size, spacing, and position. The size of the perforation or orifices, spacing of the orifices and the number of orifices must be matched with the flow rate to the network.

Size: The typical perforation diameter has been 1/4", but with the advent of the effluent filters placed in septic tanks to eliminate carry-over of large particles, smaller diameter orifices can be used. Orifices, as small as 1/8", are commonly used in sand filter design with orifice shields to protect the orifice from being covered with aggregate. There are also concerns about how well 1/8" orifices drain when located downward, especially if they have been drilled in the field. Shop drilling orifices under tight specifications reduces this concern. As a compromise, one might consider using 3/16"-diameter orifices which will allow for more orifices than 1/4"-diameter orifices. This example will use 3/16"-diameter orifices. A sharp drill bit drills a much more uniform orifice than a dull drill. Replace drill bits often. Remove all burrs and filing from pipe before assembling it.

Spacing: It is important to distribute effluent as uniformly as possible over the surface to increase effluent/soil contact time to maximize treatment efficiency. Typical spacing has been 30" to 36",

but some designers have set spacing further apart to reduce pipe and pump sizes. Typical spacing for sand filters has been  $6 \text{ ft}^2/\text{orifice}$  which this example uses.

Positioning: In cold climates, it is essential that laterals drain after each dose event to prevent freezing. In sand filters, orifices have been placed upward with the orifice protected by an orifice shield. Laterals are sloped back to the force main for drainage after each dose. Because longer laterals normally are encountered in mounds, orifices are typically placed downward for draining. This is because it is much more difficult to slope the lateral to the manifold/force main due to their greater length than what is found in sand filters. However it can be done. The designer/installer may want to consider sloping the pipe back to the manifold, placing orifices upward with orifice shields or placing a 3" or 4" half pipe over the entire length of the lateral. Another alternative is placing the lateral inside a 4" perforated pipe with orifices downward or with orifices upward and pipe sloped to the manifold."

4. Determine the lateral diameter.

Using Fig. A-2a & 2b (for  $3/16"$  orifices) in the "Design Procedure" section outline item A.3 of *Pressure Distribution Network Design*:

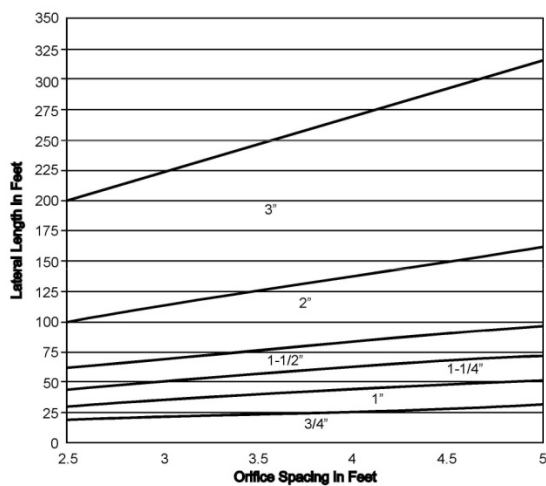

**Figure A-2a: Minimum lateral diameter based on orifice spacing for  $3/16"$  diameter orifices**

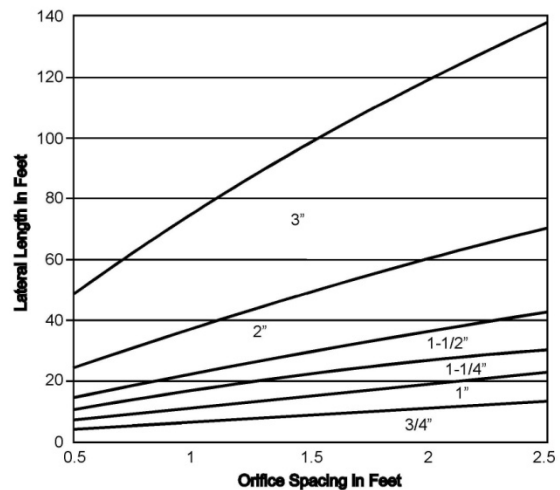

**Figure A-2b: Minimum lateral diameter based on orifice spacing for  $3/16"$  diameter orifices**

Option 1: For two laterals on each side of the center feed and lateral length of 56 feet and 3.0 feet spacing, lateral diameter = 1.5"

Option 2: For one lateral on each side of center feed and lateral length of 56 feet and 1.5 feet spacing, lateral diameter = 2".

5. Determine number of perforations per lateral and number of perforations.

Option 1: Using 3 feet spacing in 56-foot yields:

$$N = (p/x) + 0.5 = (56 / 3.0) + 0.5 = 19 \text{ perforations/lateral}$$

$$\text{Number of perforations} = 4 \text{ lateral} \times 19 \text{ perforations/lateral} = 76$$

Option 2: Using 1.5 feet spacing in 56-foot yields:

$$N = (p/x) + 0.5 = (56/ 1.5) + 0.5 = 38 \text{ perforations/ lateral}$$

$$\text{Number of perforations} = 2 \text{ laterals} \times 38 \text{ perforations/lateral} = 76$$

Check - Maximum of 6 sq ft / perforation =

$$\text{Number of perforations} = 113 \text{ feet} \times 4 \text{ feet} / 6 \text{ sq ft} = 75$$

which is less than 76, so design is acceptable.

6. Determine lateral discharge rate (LDR).

Using network pressure (distal) pressure of 3.5 feet and 3/16" diameter perforations,

**Table A-1 Discharge Rates from Orifices.**

Pressure	Orifice diameter (in.)				
	1/8	3/16	1/4	5/16	3/8
ft	gpm				
2.5	0.29	0.66	1.17	1.82	2.62
3.0	0.32	0.72	1.28	1.00	2.87
3.5	0.34	0.78	1.38	2.15	3.10
4.0	0.37	0.83	1.47	2.30	3.32
4.5	0.39	0.88	1.56	2.44	3.52
5.0	0.41	0.93	1.65	2.57	3.71
5.5	0.43	0.97	1.73	2.70	3.89
6.0	0.45	1.02	1.80	2.82	4.06
6.5	0.47	1.06	1.88	2.94	4.23
7.0	0.49	1.10	1.95	3.05	4.39
7.5	0.50	1.14	2.02	3.15	4.54
8.0	0.52	1.17	2.08	3.26	4.69
8.5	0.54	1.21	2.15	3.36	4.83
9.0	0.55	1.24	2.21	3.45	4.97
9.5	0.57	1.28	2.27	3.55	5.11
10.0	0.58	1.31	2.33	3.64	5.24

Values were calculated as:  $\text{gpm} = 11.79 \times d^2 \times h^{1/2}$  where  $d$  = orifice dia. in inches,  $h$  = head feet.

Table A-1 from *Pressure Distribution Network Design* gives a discharge rate of 0.78 gpm regardless of the number of laterals.

Option 1:  $\text{LDR} = 0.78 \text{ gpm/ perforation} \times 19 \text{ perforations} = 14.8 \text{ gpm}$

Option 2:  $\text{LDR} = 0.78 \text{ gpm/ perforation} \times 38 \text{ perforation} = 29.6 \text{ gpm}$

7. Determine the number of laterals.

This was determined in Steps 3 and 4.

Option 1: Two laterals on each side of center feed = 4 laterals spaced 2 feet apart.

Option 2: One lateral on each side of center feed = 2 laterals down center of absorption area.

8. Calculate the manifold size.

Option 1: The manifold is same size as force main as it is an extension of force main or it could be one size smaller. For larger systems, there is a table available by Otis, 1981 and in the Wisconsin Administrative Code.

Option 2: There is no manifold.

9. Determine network discharge rate (NDR),

Option 1:  $\text{NDR} = 4 \text{ laterals} \times 14.8 \text{ gpm/lateral} = 59.2 \text{ or } 60 \text{ gpm}$

Option 2:  $\text{NDR} = 2 \text{ laterals} \times 29.6 \text{ gpm/lateral} = 59.2 \text{ or } 60 \text{ gpm}$

Pump has to discharge a minimum of 60 gpm against a total dynamic head yet to be determined.

10. Total dynamic head

Sum of the following:

System head =  $1.3 \times \text{distal head (ft.)}$

=  $1.3 \times 3.5 \text{ feet}$

= 4.5 feet

Elevation head = 9.0 feet (Pump shut off to network elevation)

Head Loss in Force Main = > Use Table A-2 (below) for plastic pipe friction loss, and Table A-3 (below)

for friction losses through plastic fittings, in *Pressure Distribution Network Design*, for 60 gallons per minute and 125 feet of force main and 3 elbows.

**Table A-2 Friction Loss in Plastic Pipe.**

Flow (gpm)	Nominal Pipe Size						
	¾	1	1 ¼	1½	2	3	4
2							
3	3.24						
4	5.52						
5	8.34						
6	11.68	2.88	Velocities in this area are below 2 fps.				
7	15.53	3.83					
8	19.89	4.91					
9	24.73	6.10					
10	30.05	7.41	2.50				
11	35.84	8.84	2.99				
12	42.10	10.39	3.51				
13	48.82	12.04	4.07				
14	56.00	13.81	4.66	1.92			
15	63.62	15.69	5.30	2.18			
16	71.69	17.68	5.97	2.46			
17	80.20	19.78	6.68	2.75			
18		21.99	7.42	3.06			
19		24.30	8.21	3.38			
20		26.72	9.02	3.72			
25		40.38	13.63	5.62	1.39		
30		56.57	19.10	7.87	1.94		
35			25.41	10.46	2.58		
40			32.53	13.40	3.30		
45			40.45	16.66	4.11		
50			49.15	20.24	4.99		
60				28.36	7.00	0.97	
70				37.72	9.31	1.29	
80	Velocities in these areas exceed 10 fps, which is too great for various flows and pipe diameters,				11.91	1.66	
90					14.81	2.06	
100					18.00	2.50	0.62
125					27.20	3.78	0.93
150					5.30	1.31	
175					7.05	1.74	

Note: Table is based on Hazen-Williams formula:  $h = 0.002082L \times (100/C)^{1.85} \times (\text{gpm})^{1.85} / d^{4.8655}$  where h = feet of head, L = length in feet, C= Friction factor from Hazen-Williams (145 for plastic pipe), gpm = gallons per minute, d= nominal pipe size.



**Table A-3 Friction Losses through Plastic Fittings in Terms of Equivalent Lengths of Pipe.**  
*Pressure Distribution Network Design*

Type of Fitting	Nominal size fitting and pipe					
	1¼	1½	2	2½	3	4
90o STD Elbow	7.0	8.0	9.0	10.0	12.0	14.0
45o Elbow	3.0	3.0	4.0	4.0	6.0	8.0
STD. Tee (Diversion)	7.0	9.0	11.0	14.0	17.0	22.0
Check Valve	11.0	13.0	17.0	21.0	26.0	33.0
Coupling/ Quick Disconnect	1.0	1.0	2.0	3.0	4.0	5.0
Gate Valve	0.9	1.1	1.4	1.7	2.0	2.3

Equivalent length of pipe for fittings - Table A-3 (above)

Option A: 2" diameter force main = 3 elbows @ 9.0 feet each = 27 feet of pipe equivalent

Option B: 3" diameter force main = 3 elbows @ 12.0 feet each = 36 feet

Head Loss - Table A-2 (above) in *Pressure Distribution Network Design*

Option A: 2" diameter force main =  $7.0 (125 \text{ feet} + 27 \text{ feet})/100 = 10.6 \text{ feet}$

Option B: 3" diameter force main =  $0.97 (125 \text{ feet} + 36 \text{ feet})/100 = 1.6 \text{ feet}$

Total Dynamic Head (TDH)

Option A:  $TDH = 4.5 + 9 + 10.6 = 24.1 \text{ feet (2" force main)}$

Option B:  $TDH = 4.5 + 9 + 1.6 = 15.1 \text{ feet (3" force main)}$

## 11. Pump Summary

Option A: Pump discharges 60 gpm against a head of 24.1 with 2" force main

Option B: Pump discharges 60 gpm against a head of 15.1 feet with 3" force main

These are the calculated flow and head values. The actual flow and head will be determined by the pump

selected. A system performance curve plotted against the pump performance curve gives a better estimate of the flow rate and total dynamic head the system will operate under. The next section provides an example.

---

Design of the Force Main, Pressurization Unit, Dose Chamber and Controls

---

Steps of Design Procedure:

1. Calculate the system performance curve.

Use the following table from *Pressure Distribution Network Design* to develop a system performance curve (see full reference in Section E.6 for more on system curves). Follow procedures (a) through (g) listed below the table. The term orifice is synonymous with perforation. This example uses Option A. Option B can be calculated similarly.

**Pump System Curve Table**

<b>Total Flow (gpd)</b>	<b>Orifice Flow (gpd)</b>	<b>Elevation Difference (ft)</b>	<b>Force Main (ft)</b>	<b>Network Head (ft)</b>	<b>Total Head (ft)</b>
<b>40</b>	0.526	9.0	5.0	2.1	16.1
<b>50</b>	0.658	9.0	7.6	3.3	19.9
<b>60</b>	0.789	9.0	10.6	4.7	24.3
<b>70</b>	0.921	9.0	14.2	6.4	29.6
<b>80</b>	1.053	9.0	18.1	8.4	35.5

Procedure:

- a. Select five flow rates above and below the network discharge rate of 60 gpm.
- b. Calculate the orifice (perforation) flow rate for each of the flows. Do this by dividing the flow rate by the number of orifices in the network. For the 30 gpm and 76 orifices, the orifice flow rate is 0.395 gpm.
- c. The elevation head is the height the effluent is lifted.
- d. The force main head is the head loss in the force main for the given flow rate. Table A-2 in *Pressure Distribution Network Design* (above) gives the friction loss. Select a force main diameter.

For this example use 2" force main. For 60 gpm flow, the friction loss is 7.0 feet  $\times$  1.52 for head of 10.6 feet.

e. The network head is calculated by  $H = 1.3(Q/(11.79d^2))^2$ . Where:

H = network head (feet)

Q = orifice flow rate (gpm)

d = orifice diameter (inches)

1.3 = adjustment factor for friction loss in laterals

f. The total head is the sum of the elevation, force main and network heads.

2. Determine the force main diameter.

Force main diameter:

Option A = 2" (determined in Step 1 of Section B).

Option B = 3"

3. Select the pressurization unit.

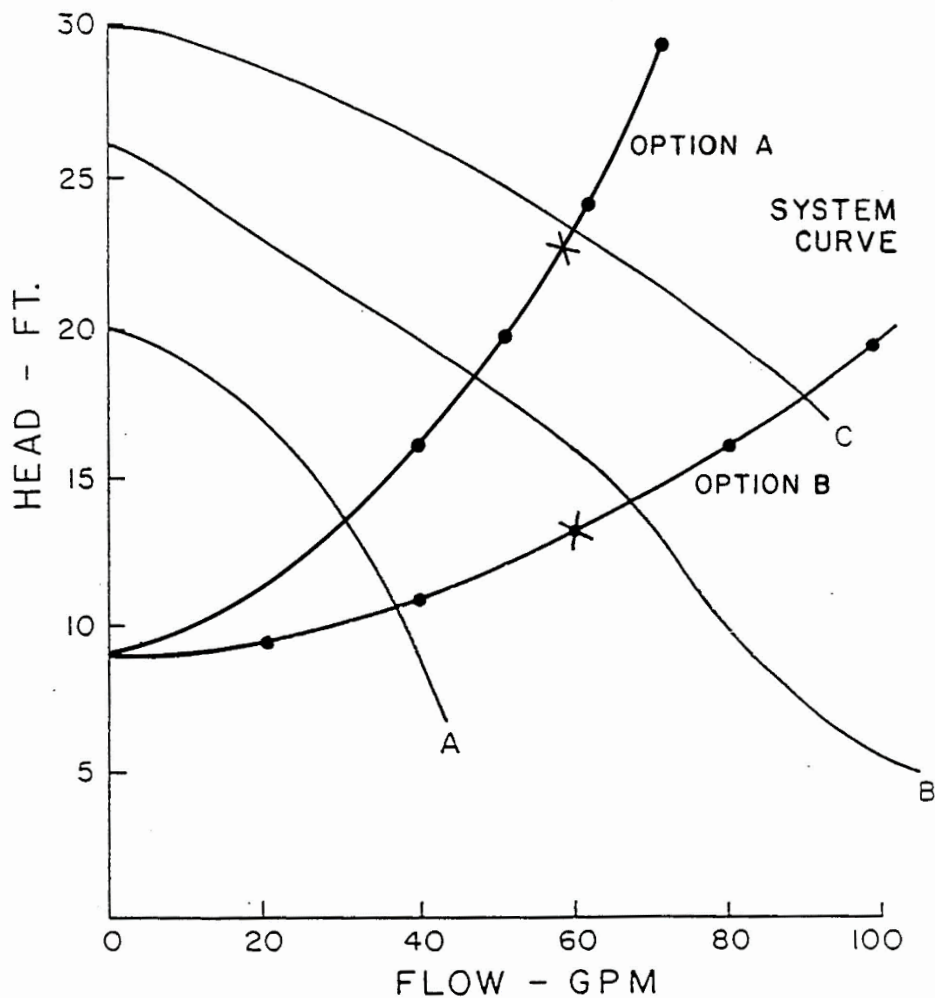

### Design Example System and Pump Performance Curves

Plot the performance curves of several effluent pumps and the system performance curve (Figure above from *Pressure Distribution Network Design*). For the system curve plot the flow rates vs. the total head. On the system curve, use an X where the flow rate intersects the curve (in this case 60 gpm). Select the pump, represented by the pump performance curve, located next along the system performance curve just after 60 gpm (Pump B) as that is where the pump will operate.

Pump C could be selected, but it is over sized for the unit.

4. Determine the dose volume.

More recent thinking is that dose volume should be reduced from the larger doses recommended earlier.

Use five times the lateral void volume. Use the void volume from Table A-4 in *Pressure Distribution Network Design*.

**Table A-4 Void Volume for Various Diameter Pipes.**

Nominal Pipe Size (In.)	Void Volume (gal./ft)
¾	0.023
1	0.041
1¼	0.064
1½	0.092
2	0.163
3	0.367
4	0.650
6	1.469

	Option 1:	Option 2:
Lateral diameter =	1.5"	2.0"
Lateral Length =	56'	56'
	Option 1:	Option 2:
No. of laterals =	4	2
Void volume =	0.092 gal/ft	0.163 gal/ft

Net dose volume

$$\text{Option 1} = 5 \times 56 \times 4 \times 0.092 = 103 \text{ gal/dose}$$

$$\text{Option 2} = 5 \times 56 \times 2 \times 0.163 = 91.3 \text{ gal/dose}$$

Flow back from force main

$$\text{Option A: } 2" \text{ force main @ } 125 \text{ feet @ } 0.163 \text{ gal/ft} = 20.4 \text{ gal/dose}$$

Option B: 3" force main@ 125 feet@ 0.0.367 gal/ft = 45.9 gal/dose

Set the floats to dose the combination selected:

Dose volume with Option 1 and Option A =  $103 + 20 = 123$  gal/dose

Dose volume with Option 1 and Option B =  $103 + 46 = 146$  gal/dose

Dose volume with Option 2 and Option A =  $91 + 20 = 111$  gal/dose

Dose volume with Option 2 and Option B =  $91 + 46 = 137$  gal/dose

The net dose volume to the mound will be 91 or 103 gal/dose with either 20 or 46 gallons flowing back into the pump chamber. No check valve is used to prevent flow back in cold climates due to freezing potential. If the dose is limited to 20 percent of the design flow, Option 1 with a net dose of 91.3 is very close to 90 gpd/dose ( $450 \text{ gpd} \times 20 \text{ percent}$ ). Option 2 does not meet the 20 percent criteria.

#### 5. Size the dose chamber.

Based on the dose volume, storage volume and room for a block beneath the pump and control space, a 500 to 750-gallon chamber will suffice. If timed dosing is implemented, a larger tank will be required to provide surge storage. Use the daily design flow for surge capacity.

#### 6. Select controls and alarm.

Demand Dosing: Controls include on-off float and alarm float. Installing an event recorder and running time meter would be appropriate. If the pump is calibrated and dose depth recorded, these two counters can be used to monitor flow to the soil unit.

Time Dosing: The advantage of time dosing is that it provides more frequent doses and levels out peak flows to the soil treatment/dispersal unit. In mounds with longer laterals and larger orifices, compared to shorter laterals and smaller orifices in sand filters, time dosing may not be as appropriate as it is in sand filters.

## 7. Select effluent filters.

Filters should be installed on the septic tank to minimize solids carry-over to the pump chamber. A second filter, located on the pump outlet, will keep any solids falling into the pump chamber from being carried over. Converse, J.C. (2000)<sup>62</sup> provides information relative to filters.

## 8. Construction and Maintenance

In addition to designing pressure distribution or dosing systems, a design professional should also supervise construction, prepare an operating manual, and implement start-up. Common sense should prevail when constructing and maintaining these systems. Quality components should be used, water tight construction practices should be employed for all tanks, and surface runoff should be diverted away from the system. Any settling around the tanks should be filled with the soil brought to grade or slightly above to divert surface waters. Provisions should be incorporated into the lateral design, such as turn-ups (Figure E-3 in these Design Standards) for easy flushing of laterals as solids will build up and clog the orifices. Do not enter tanks without proper safety equipment.

For specific pressure distribution design details, including development of a system performance curve, and lateral/orifice sizing Tables, Converse, J.C. (2000)<sup>62</sup> provides further information.

---

<sup>62</sup> Converse, J.C., 2000. *Pressure Distribution Network Design. Small Scale Waste Management Project Guidance Document #9.14*; University of Wisconsin – Madison

## Appendix E.2 Mound Design Example

Below is a University of Wisconsin Mound Design Example from *Wisconsin Mound Soil Absorption System: Siting, Design and Construction Manual (Wisconsin Mound Manual)*. A copy of the Wisconsin guidance document and some interpretation of the soils data are needed to assure concurrence with application rates in Table E-1 in these Design Standards.

Pressure distribution network is essential for distributing septic tank effluent. Gravity flow is unacceptable, as it will not distribute the effluent uniformly over the infiltrative surface or along the length of the mound (Converse, 1974, Machmeier and Anderson, 1988). Otis (1981) provides design criteria and examples for pressure distribution. *Pressure Distribution Network Design* by Converse (2000) discusses pressure distribution and Appendix E.1 of this Design Standard provides a design example.

---

### Effluent Distribution Network in a Mound System Design Example:

---

Design an on-site system based on the following soil profile description.

Site Criteria:

#### 1. Soil Profile Example - Summary of Three Soil Pit Evaluations (See Horizons in Figure E-12).

Horizon	Depth (in)	Munsell Color	Characteristics
A	0 to 6	10YR 6/4 & 10YR 2/1	silt loam (SiL); strong, moderate, angular blocky structure; friable consistence.
E	6 to 11	10YR 5/3	silt loam (SiL); moderate, fine platy structure; firm consistence.
B	11 to 20	10YR 6/3	silty clay loam (SiCL); moderate, fine, sub angular blocky structure; firm consistence; few, medium distinct mottles starting at 11".
C	20 to 36	10YR 5/3	silty clay (SiC); massive structure; very firm consistence; many, medium, prominent mottles.

#### 2. Slope 20 percent



3. The area available consists of 170 feet along the contour and 50 feet along the slope. There are three medium-size trees in the area.

4. The establishment generates 300 gallons of wastewater of domestic septic tank effluent per day based on water meter readings.

Procedure:

Step 1. Evaluate the quantity and quality of the wastewater generated.

For all on-site systems a careful evaluation must be done on the quantity of wastewater generated. As indicated earlier, most code values have a factor of safety built into flows generated daily. These are the values typically used for design. The designer should assess whether the code value is appropriate for the given facility and, if not, work with regulators on a suitable number. If metered values are used, a suitable factor of safety, such as 50 to 100 percent, should be added to the daily average flow. Average flow should be based on a realistic period-not, for example, an average of six months of very low daily flow rates and six months of very high flow rates. In that case, then the high flow rates should be used for design plus the factor of safety. It is best to over design rather than under design; even though the cost is greater, system performance and longevity should be better.

Effluent quality should also be assessed. If it is typical domestic septic tank effluent, these sizing criteria may be used. If it is commercial septic tank effluent, lower loading rates (gpd/ft<sup>2</sup>) should be used (Siegrist, et al., 1985<sup>63</sup>) or the effluent pretreated to acceptable BOD and TSS. Use a safety factor of 150 percent.

Design Flow Rate = 300 gpd × 1.5 = 450 gpd.

Step 2. Evaluate the soil profile and site description for designing linear loading rate and soil loading rate.

For this example and for convenience, the one given soil profile description is representative of the site. A minimum of three evaluations should be done on any actual site. More may be required depending on variability of the soil. The soil evaluator (i.e., design engineer, or a soil scientist employed by the design

---

<sup>63</sup> Siegrist, R.L., Andersen, D.L., and Converse, J.C., 1985. *Commercial wastewater on-site treatment and disposal*. - *Proceeding of the Fourth National Symposium on Individual and Small Community Sewage Systems* - American Society of Agricultural and Biological Engineers; St. Joseph, MI 49085.

engineer or engineering firm licensed in New York State) should do as many borings as required to assure the evaluation is representative of the site. Soil pits are better than borings, but a combination is satisfactory. In evaluating this soil profile, the following comments can be made:

Silt loam (A) horizon (0 to 6") is relatively permeable because of its texture, structure and consistence. Effluent flow through this horizon should be primarily vertical.

Silt loam (E) horizon (6 to 11") has a platy structure and firm consistence. This consistence slows the flow, and the platy structure impedes vertical flow and causes it to move horizontally. If this layer is tilled, platy structure is rearranged and the flow becomes primarily vertical. Thus, tillage needs to be at least 11 inches deep on this site to rearrange platy structure. If the structure in this horizon was not platy, then tillage would be limited to 5" to 6" in depth.

The silty clay loam (B) horizon (11" to 20") is slowly permeable because of the texture and firm consistence. Flow is a combination of vertical and horizontal in the upper portion and primarily horizontal in the lower portion due to the nature of the next lower horizon. During wet weather, the "B" horizon may be saturated, with all flow moving horizontally.

Silty clay (C) horizon (20" to 36") will accept some vertical flow as effluent moves horizontally down slope in the upper horizons. Flow through this profile will be similar to the cross section shown in Fig. 2c and during seasonal saturation as shown in Fig. 2b.

Experience shows a properly designed mound system should function on this site.

It meets the minimum site recommendations found in Table 1, *Wisconsin Mound Manual*.

Linear loading rates range from about 1 to 10 gpd/lf. Because this site has a very shallow seasonal saturation and a very slowly permeable horizon at about 20", with seasonal saturation at 11", the linear loading value should be 3 to 4 gpd/lf.

Linear Loading Rate = 4 gpd/lf

Note: LLR = 3 could be used for a more conservative design and less risk of toe leakage, especially during seasonal saturation.

A basal loading rate for the soil horizon in contact with sand (basal area) is selected based on the surface

horizon (A). Use Table 2 (below) of the *Wisconsin Mound Soil Absorption System: Siting, Design & Construction Manual* to determine the design basal loading rate.

**Table 2.** Design basal loading rates for mound systems for soil horizons with loose, very friable, friable and firm consistency. These values assume wastewater has been highly pretreated, with BOD < 25 mg/L and TSS < 25 mg/L, and is based on a daily flow rate of 150 gpd/bedroom.

Soil Texture	Soil Structure					
	0		pl		bk, pr or gr	
	sg	m	1	2 & 3	1	2 & 3
coarse sand	1.6					
sand	1.2					
fine sand	0.9					
very fine sand	0.6					
loamy coarse sand	1.4					
loamy sand	1.0					
loamy fine sand	0.9					
loamy very fine sand	0.6					
course sandy loam		0.6	0.5	0.0	0.7	1.0
sandy loam		0.5	0.4	0.0	0.6	0.9
fine sandy loam		0.5	0.4	0.0	0.6	0.8
very fine sandy loam		0.4	0.3	0.0	0.6	0.8
loam		0.5	0.5	0.0	0.6	0.8
Silt loam		0.2	0.3	0.0	0.3	0.8
silt		0.0	0.0	0.0	0.3	0.6
sandy clay loam		0.0	0.0	0.0	0.3	0.6
clay loam		0.0	0.0	0.0	0.3	0.6
silty clay loam		0.0	0.0	0.0	0.3	0.6
sandy clay		0.0	0.0	0.0	0.0	0.3
silty clay		0.0	0.0	0.0	0.0	0.3
clay		0.0	0.0	0.0	0.0	0.3

Basal Loading Rate = 0.8 gpd/ft<sup>2</sup>

Step 3. Select the sand fill loading rate.

The section entitled “Sand Fill Loading Rate” and Figure 6 of the *Wisconsin Mound Manual* give guidelines for selecting a suitable sand fill for the mound. Other fills may be used, but caution is advised, as performance data of other fills is very limited.

$$\text{Sand Loading Rate} = 1.0 \text{ gpd/ft}^2$$

Note: No absorption area credit is given for use of chambers in mounds.

Note: For Steps 4 through 13, see Figures E-11 and E-12 of these Design Standards for location of dimensions given.

Step 4. Determine the absorption area width (A).

$$\begin{aligned} A &= \text{Linear Loading Rate} / \text{Sand Loading Rate} \\ &= 4 \text{ gpd/ft} / 1.0 \text{ gpd/ft}^2 \\ &= 4 \text{ feet} \end{aligned}$$

(Because this appears to be the weak point in the mound, consider making it 6 feet wide. A 6-foot-wide absorption area would give a sand loading rate of 0.67 gpd/ft<sup>2</sup>. The linear loading rate will remain 4 gpd/lf. However, increasing the area requires more orifices in the pressure distribution network).

Step 5. Determine the absorption area length (B).

$$\begin{aligned} B &= \text{Design Flow Rate} / \text{Linear Loading Rate} \\ &= 450 \text{ gpd} / 4 \text{ gpd/lf} \\ &= 113 \text{ feet} \end{aligned}$$

Step 6. Determine the basal width (A + I).

The basal area required to absorb effluent into the natural soil is based on the soil at the sand/soil interface and not on lower horizons in the profile. An assessment of the lower horizons was done in Step 2 when the linear loading rate was estimated.

$A + I = \text{Linear Loading Rate} / \text{Basal Loading Rate}$

$$= 4 \text{ gpd/ft} / 0.8 \text{ gpd/ft}^2$$

$$= 5.0 \text{ feet (The effluent should be absorbed into the native soil, within about 5 feet.)}$$

Because  $A = 4$  feet

$$I = 5.0' - 4.0' = 1 \text{ feet. ("I" will also be calculated based on side slope)}$$

Step 7. Determine the mound fill depth (D).

Assuming the code requires three feet of suitable soil and soil profile indicates 11 inches of suitable soil, then:

$$D = 36" - 11" = 25 \text{ in.}$$

Step 8. Determine mound fill depth (E).

For a 20 percent slope with the bottom of the absorption area level then:

$$E = D + 0.20(A)$$

$$= 25" + 0.20(48")$$

$$= 35 \text{ in.}$$

Step 9. Determine mound depths (F), (G) and (H)

$$F = 9 \text{ in. (6 in. of aggregate, 2 in. for pipe and 1 in. for aggregate cover over pipe)}$$

$$G = 6 \text{ in.}; \text{ and } H = 12 \text{ in.}$$

Depths for G and H were reduced (in WI) from 12" and 18" to enable more oxygen to diffuse into and beneath the absorption area. Sand filters have only 6" of cover and freezing is not a problem as long as the distribution network drains after each dose. However, most sand filters are below grade which may be a factor.

Step 10. Determine the up slope width (J).

Using the recommended mound side slope of 3:1, then:

$$J = 3 (D + F + G) \text{ (Slope Correction Factor from Table 4 of the } \textit{Wisconsin Mound Manual})$$

$$= 3(25'' + 9'' + 6'') (0.625)$$

$$= 6.25 \text{ feet or 6 feet}$$

Table 4. Down Slope and Up Slope Correction Factors

Slope %	Down Slope Correction Factor	Up Slope Correction Factor
0	1.00	1.00
1	1.03	0.97
2	1.06	0.94
3	1.10	0.92
4	1.14	0.89
5	1.18	0.88
6	1.22	0.85
7	1.27	0.83
8	1.32	0.80
9	1.38	0.79
10	1.44	0.77
11	1.51	0.75
12	1.57	0.73
13	1.64	0.72
14	1.72	0.71
15	1.82	0.69
16	1.92	0.68
17	2.04	0.66
18	2.17	0.65
19	2.33	0.64
20	2.50	0.62
21	2.70	0.61
22	2.94	0.60
23	3.23	0.59
24	3.57	0.58
25	4.00	0.57

Step 11. Determine the end slope length (K).

Using the recommended mound end slope of 3:1, then:

$$\begin{aligned}
K &= 3((D + E)/2 + F + H) \\
&= 3((25" + 35")/2 + 9" + 12") \\
&= 12.75 \text{ feet or } 13 \text{ feet}
\end{aligned}$$

Step 12. Determine the down slope width (I).

Using the recommended mound side slope of 3:1, then:

$$\begin{aligned}
I &= 3 (E + F + G) \text{ (Slope Correction Factor from Table 4 of the } \textit{Wisconsin Mound Manual} \text{ - see above)} \\
&= 3 (35" + 9" + 6") (2.5) \\
&= 31.25 \text{ feet } \sim 31 \text{ feet.}
\end{aligned}$$

Because the "I" dimension becomes quite large on steeper slopes, it may be desirable to make the down slope steeper such as 2:1 and not mow the mound. If the natural slope is 6 percent instead of 20 percent, mound width would be 28 feet (9 + 4 + 15).

Step 13. Overall length and width (L + W)

$$\begin{aligned}
L &= B + 2K \\
&= 113 + 2(13) \\
&= 139 \text{ feet}
\end{aligned}$$

$$\begin{aligned}
W &= I + A + J \\
&= 31 + 4 + 6 \\
&= 41 \text{ feet}
\end{aligned}$$

Step 14. Design a pressure distribution network

A pressure distribution network, including distribution piping, dosing chamber and pump, should be designed. A design example is presented by J. Converse in *Pressure Distribution Network Design*, 2000 (see Appendix E.1 of this Design Standard). Items to consider when designing a pressure distribution network:

- Use 3/16" holes instead of 1/4" holes with an effluent filter in the tank.

- Use 6 ft<sup>2</sup>/orifice instead of the typical 15 to 20 ft<sup>2</sup>/orifice used in the past.
- Provide easy access to flush laterals such as turn-ups at end of laterals.
- Dose volume at five times the lateral pipe volume, not to exceed 20 percent of the design flow and not at the previously recommended dose of ¼the design flow or 10 times the lateral void volume.
- Timed dosing, which requires surge capacity in the septic tank/pump chamber. With the configuration of the mound (long and narrow), the dose volume is larger than for a sand filter, and timed dosing may not be appropriate if larger dose volumes are required due to there being five times the lateral volume.



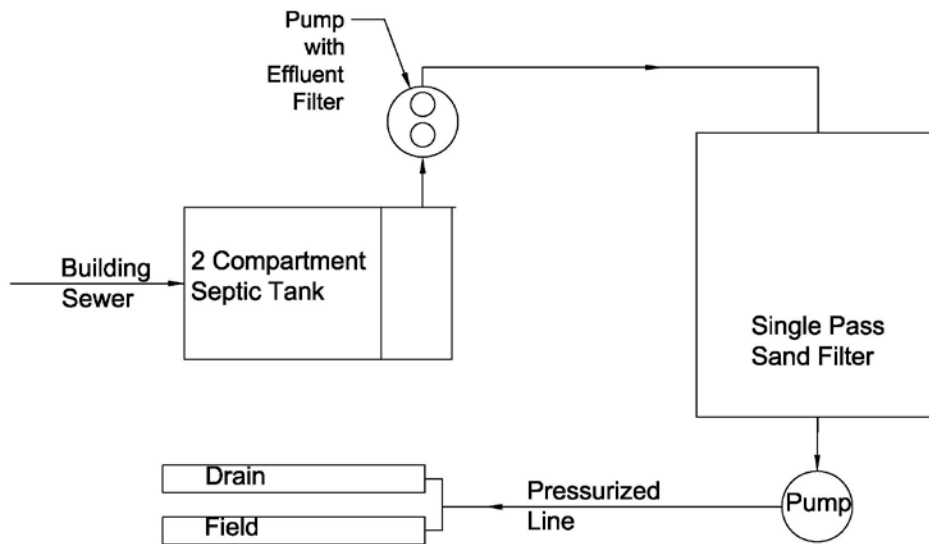

### Single Pass Sand Filter and Pressurized Discharge to Drainfield

#### Scope:

A PSND distributes wastewater that has received at least secondary treatment and pathogen reduction equivalent to a single-pass sand filter over an area of land for final polishing, or recharge of groundwater. This method of dispersal is capable of uniformly distributing wastewater effluent with a smaller footprint than a conventional trench system. It has been used in Rhode Island for dispersal of preconditioned wastewater onto soil infiltrative surfaces since the late 1990s. Other states that currently use similar low pressurized distribution systems with gravelless chambers in sand lined trenches include OR, WA, NC, CO and NM. This installation has some operational challenge in cold climate areas. However, it has been shown to function satisfactorily in these five states where cold climate conditions exist due to latitude or elevation.

#### Cold Climate Use:

PSND systems are usually installed at a depth of 12" to 18" to minimize potential human or animal contact and to ensure proper effluent dispersal into the biologically active soil layer. Cold climates may require deeper burial. Installing PSND systems below the soil's freeze depth is generally not necessary. However,

due to New York State's cold climate and potential lack of snow cover throughout winter, a burial depth of 18 inches is recommended statewide for this alternative technology. PSNDs placed in shallow soil horizons hold moisture at field capacity (thin film on soil particle surfaces). If a drainfield is not used for several days or weeks in the case of a winter start up, this moisture freezes. However, the soil is NOT saturated (not a solid block of ice), and infiltration still occurs. Because the pump chamber is below the frost line and insulated, two or three doses (typically two to six hours if time dosing) of relatively warm wastewater melts the remainder of the PSND. The chamber component of the system also traps some heat emitted from soil below.

#### Irrigation:

PSNDs are usually designed to maximize infiltration of water into the soil throughout the year. Some dispersed water evaporates, or is transpired by vegetation during the growing season, but most percolates into the soil and recharges the underlying groundwater. Shallow-rooted plantings can be incorporated into the design to maximize transpiration.

For purposes of these standards, a PSND system consists of a PVC distribution line/network installed within plastic chambers to uniformly distribute pre-conditioned wastewater for treatment in the shallow soil horizon.

These systems rely on electronic controllers to manage the frequency of wastewater doses (time dosing), preventing the hydraulic overloading of soil and also providing for subsequent reaeration of soil adjacent to the conduit. The pump chamber and gravelless domes or chambers both provide for internal storage of wastewater.

The following section describes appropriate design, installation, operation, monitoring, and maintenance practices necessary to ensure long term performance of PSND systems. Site-specific engineered designs should be used.

---

#### Design and Installation

---

- The typical PSND is designed with pipes or chambers on 30-inch centers.
- The PSND should be used only on sites with 5 percent slope or less.
- The percolation rate should be determined using the most restrictive soil horizon within 18 inches

below the proposed base of the pressurized shallow narrow drainfield.

- A perimeter area (or projected horizontal border area to prevent breakout) should project five feet from the walls of the outermost trenches.
- Preserving native soil between trenches and minimizing its disruption and compaction during construction is essential to maintaining soil structure and, therefore, water and gas movement in soil around the trenches. For this reason standard construction should be trench-by-trench.
- Keep the bottom bed shallow (18 inches below existing and finish grades).
- Keep the bottoms of individual trenches level.
- Do not over dig the width or depth of drainfield trenches to preserve soil structure.
- Provide access to lateral distribution pipes for maintenance purposes (including flushing valves protected by sub-grade valve enclosures).
- Avoid working in soils that are moist or wet because they can easily smear and compact (ribbon-test soil to ensure it is below its plastic limit).
- Scarify the drainfield base well before installing components.

When reviewing a construction site and developing a design, PSNDs should be positioned parallel to ground surface contours. This makes it easier to keep drainfield base elevations uniform.

Small frequent doses of effluent to a PSND are preferred over fewer larger doses. Drainfield pump basins/chambers should be designed with float switches or other level controllers for pump on/off, high water alarm, and low water alarm. An event counter and elapsed run time meter should also be used on the drainfield pump to assist with trouble shooting and maintenance.

Soil between dispersal trenches should remain undisturbed. If the presence of boulders or other obstacles make trench construction impractical, the entire leachfield area may be excavated as necessary, backfilled

with ASTM C33 sand to the design elevation of the bottom bed, and the PSND constructed and backfilled with native soil material.

Single pass sand filter effluent applied to PSNDs is typically done using small diameter pressure rated PVC pipe. The effluent transport line from the sand filter to the PSND is usually a 1¼ to 2-inch PVC (Class 200 minimum) pipe; the actual size depends upon such factors as distance, pump head, friction loss, and desired pressure at distal orifices.

This pipe should be sloped either back to the pump basin/chamber or towards the drain field to clear the line after each dose. In some cases, it may be better to slope the transport line in both directions. In all cases, sloping is done to prevent freezing in cold weather. Anti-siphoning devices or check valves should be installed to prevent backflow between treatment units. PSND distribution manifolds typically are 1¼ to 2-inch PVC (Class 200 minimum) and the distribution laterals are usually 1 to 1¼-inch Schedule 40 PVC. Size will vary depending on design and site conditions. (Note: Small lateral and orifice diameters are recommended to provide the highest possible scouring velocity in laterals, to minimize orifice clogging, and distribute wastewater as evenly as possible.)

In addition, the following criteria should also be observed: A series of 1/8-inch diameter holes (orifices) should be made in the top of distribution laterals (12 o'clock position) and spaced according to dosing requirements of the system. During construction/fabrication a new drill bit should be used to assure as smooth an orifice as possible. Generally, orifice spacing is every 18 to 24 inches to best distribute wastewater to the drain field surface. Designs should account for a minimum of two feet of head (pressure) at the distal end of each drainfield distribution lateral.

Along each lateral, at every fifth orifice, holes should be drilled downward through both the top and bottom of the pipe (12 and 6 o'clock positions) to allow drainage after a dose and to prevent lateral freezing in cold weather. Cold weather orifice shields used in sand filters are not used in shallow, narrow drainfield applications.

Schedule 40 PVC or equivalent sweep elbows (also called turn-ups) should be attached to the distal end of each drain field lateral to facilitate maintenance and inspection. A standard 90-degree elbow should not be used here because it will interfere with maintenance activities. The sweep elbow end should be closed off with either a ball valve or a male threaded adapter and threaded cap. The threaded end should accommodate attachment of a ten-foot length of clear PVC pipe to be used to determine initial head at the distal lateral ends and subsequent head measurement during routine inspection and maintenance visits (squirt test).

A difference in head relative to the initial reading signals maintenance requirements during subsequent visits. The sweep end is also the location through which lateral cleaning occurs (see Operation and Maintenance section). The ends of sweep elbows should be readily accessible by means of a 6 to 8-inch diameter box or port brought to ground surface. Monitoring ports for observation of possible ponding in the trench should also be placed at the halfway point along laterals longer than 20 feet. High-density plastic irrigation valve access boxes/ports are often used for this purpose. See Figure E-3 of these Design Standards, Monitoring Port Detail II.

The dome-like covering over the PSND should be made of 12-inch diameter PVC pipe, or high-density polyethylene (HDPE) pipe cut lengthwise down the middle, or an approved equivalent. One-inch diameter Schedule 40 PVC support pipes should be used to support the dome (and pressure pipe), to act as a support device for it, and to provide a greater bearing surface for the dome. These support pipes should be spaced approximately four feet apart or whenever a drainfield cover joint occurs. Notches should be cut into either end of support pipes for the dome/chamber/half-pipe to fit into. This helps provide greater structural strength for the cover.

Filter fabric should be placed over or wrapped around any joint or inspection port. This minimizes migration of fine soil particles into the drainfield trench. The ends of the drainfield dome should be wrapped with filter fabric or capped with a suitable end cap.

A minimum 2½'-on-center trench spacing (1½'-edge-to-edge) should be used. Maximum trench length should not exceed 50 feet. Actual lengths will vary between locations and be influenced by site conditions and the need to maintain the required minimum two feet of distal head pressure on drain field laterals (squirt test).

Smaller-sized pumps can be used on larger drainfields and still maintain distal head pressure by using automatic sequencing valves. These valves automatically direct flow to two or more final treatment and dispersal components, one or more at a time and, in a prescribed order, sequentially direct flow to separate zones within the drainfield.

Site conditions may not facilitate installing drainfield trenches at the same elevation. In these situations, gate valves installed in distribution pipes can be used to provide uniform wastewater distribution; gate valves also help facilitate cleaning of laterals. Monitoring ports should be installed for access to gate valves. Alternatively or in combination, orifice plates may be used to help equalize flow to trenches that are not at

the same elevation. Orifice plates or gate valves are inserted at the beginning of down-gradient laterals to compensate for differences in pressure. Orifice plate hole diameters are calculated as part of pressurized distribution system calculations. The difference in flow between any two orifices within the same lateral in the PSND or zone should be no more 10 percent.

Landscaping immediately above and adjacent to any soil-based treatment system should be protected from heavy vehicle traffic and excessive weight loads, before, during and after construction. This is especially important when using PSNDs, because they are located close to the ground surface and especially susceptible to damage after construction. It is recommended the proposed drain field location be staked and flagged/fenced to prevent encroachment during other site construction and staging of heavy construction materials and supplies. If vehicle encroachment is expected to be a problem after construction, some structure such as garden timbers, fences, or walls should be used to protect the drainfield area.

The drainfield area should be kept debris free and planted with grass or shallow-rooted vegetation. Impermeable materials should not be installed or stored over the PSND. Trees and shrubs should be kept a minimum distance of ten feet from the drainfield. Roots from nearby moisture-loving trees such as willows, black locust, and red maple, may cause problems with root clogging drainfield lateral orifices. Greater setback distances from these tree species are recommended.

---

#### Operation, Monitoring, and Maintenance

---

Sand filter effluent and other approved advanced treatment systems' effluent is low in BOD and TSS, so accumulation of bio-solids or slime material in PSND lateral pipes is fairly minimal. Over time, however, bio-solids accumulate, blocking orifices and creating uneven wastewater distribution along the trench. To unclog orifices locate the trench access port and open the lateral sweep end. Open each lateral end, manually engage the pump and purge any loose solids out the lateral end into the access port. A bottle brush (appropriately sized for the lateral) attached to a plumbers snake is then pushed down each lateral to unplug the orifices. With the bottle brush removed, the pump should be manually engaged and each lateral line can be flushed out through the lateral end onto the drain field surface. This minimal amount of bio-solids will usually decompose within two days. Alternatively, a pressure power washer with appropriately sized tubing can be sent down each lateral to flush accumulated solids.

Usually a PSND following a sand filter in continuous use requires lateral flushing/bottle brush treatment once a year or every two years. Systems operating above their daily design flow may require more frequent lateral flushing; frequency based upon the results of the distal lateral head pressure test. Seasonally used

systems may not need yearly lateral flushing, but their lateral head (pressure) should be checked once yearly, and maintenance performed as needed.

---

## Reference Documents

---

EPA. *Onsite Wastewater Treatment Systems Design Manual*, EPA/625/R-00/008. Office of Water, Office of Research and Development. Washington, D.C. February 2002. Pages 4-48 to 4-51 and TFS-55.

CIDWT. *Installation of Wastewater Treatment Systems*. Consortium of Institutes for Decentralized Wastewater Treatment (CIDWT), 2009. Pages 10-1 to 10-6, 11-4 and 11-5.

American Society for Testing and Materials (ASTM), West Conshohocken, Pennsylvania.

- *ASTM D5925-96. Standard Practice for Preliminary Sizing and Delineation of Soil Adsorption Field for On-site Septic Systems*. 1996.
- *ASTM D5879-95. Standard Practice for Surface Characterization for On-site Systems*. 1996.
- *ASTM D5921-96. Standard Practice for Subsurface Site Characterization of Test Pits for On-site Septic Systems*. 1996.

Rhode Island Department of Environmental Management (RIDEM), *Revised Sand Filter and Pressurized Shallow- Narrow Drainfield Guidance Document*, March 2010 (includes Addendums 1 and 2 dated September 14, 2010 and June 24, 2011 respectively).

## Appendix E.4 Drip and Low Profile Dispersal Systems

### Subsurface Drip Dispersal System

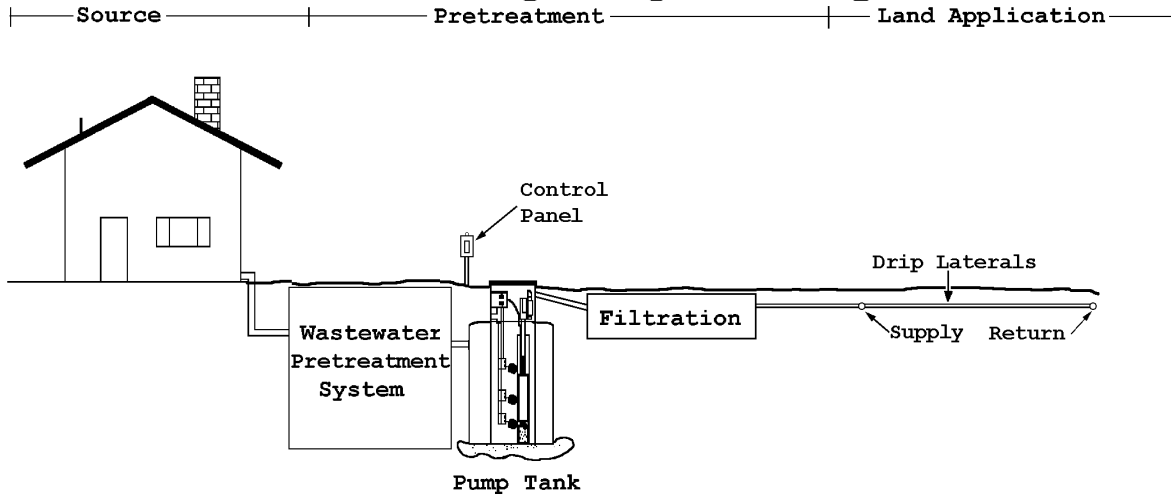

### Drip Dispersal Diagram Typical Section View

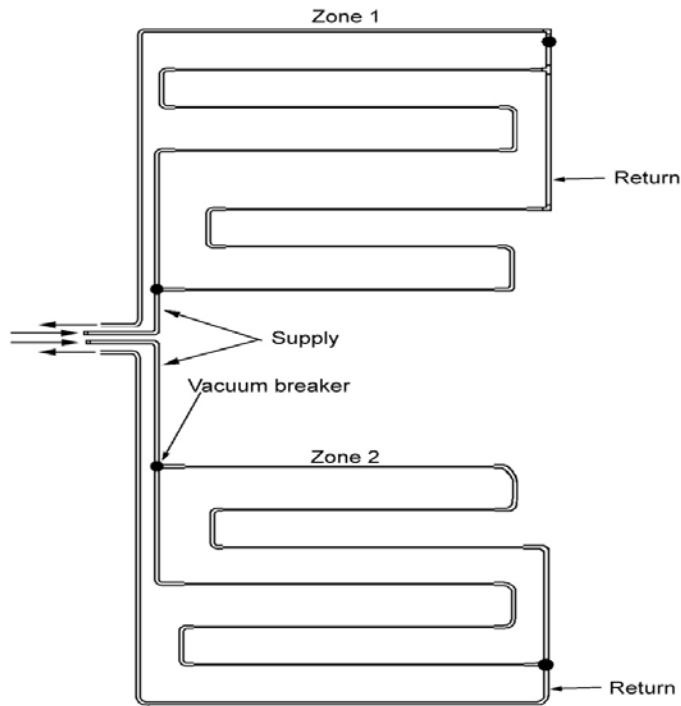

### Drip Dispersal Diagram Typical Plan View



---

## Scope

---

Drip dispersal is a method used to distribute wastewater that has received pretreatment over an area of land for final polishing, reuse, or recharge of groundwater. This method of dispersal is capable of uniformly distributing wastewater effluent over large areas. It has been used in the U.S. for dispersal of pretreated wastewater onto soil infiltrative surfaces since the late 1980s.

### Cold Climate Use:

Drip tubing is frequently installed at a depth of 6" at protected and temperate sites, and an 8" to 12" depth is recommended to minimize potential human or animal contact and to ensure proper effluent dispersal into the biologically active soil layer. However, due to New York State's cold climate, and potential lack of snow cover throughout winter, burial depth is 18 inches statewide for this alternative technology. For further design and installation techniques, see Design and Installation sections below.

### Irrigation:

Drip dispersal is frequently, but inappropriately, referred to as drip irrigation. Drip dispersal is seldom designed to meet the agronomic water requirements of a crop. Instead, it is usually designed to maximize infiltration of water into the soil throughout the year. Some of the dispersed water evaporates, or is transpired by vegetation during the growing season, but most percolates into the soil and recharges the underlying groundwater. However, subsurface plant irrigation can be incorporated into the drip dispersal design.

For purposes of these standards, drip dispersal consists of a dripper line or low-profile conduit installed for treating and uniformly distributing pre-treated wastewater into the shallow soil horizon. These systems rely on electronic controllers to manage the frequency of wastewater doses, preventing hydraulic overloading of soil and providing for subsequent reaeration of soil adjacent to the conduit. The typical dripper line or low profile conduit is ½" to 2" high and designed to fully infiltrate water into the soil before the next dose. The minimum drip dispersal tubing diameter is ½". Drip dispersal systems do not provide for internal storage of wastewater. Consequently, it is used in conjunction with other flow equalization devices.

---

## Design

---

All components of the drip arrangement should work together for the long-term, reliable operation of a drip dispersal system. Each function of the system design, regarding flow rates and pressures, should be appropriately integrated and designed to meet requirements. Additional components deemed appropriate by the manufacturer or designer may be used to treat and evenly disperse wastewater to prevent emitter or soil clogging or physical damage (including freezing), monitor operation, or otherwise enhance system performance.

It is highly recommended that drip and other low-profile dispersal systems be configured as a complete integrated package from a single source consisting of drip tubing or other low-profile conduit, any special field fittings, pump / pump chamber components, filtration unit (headworks), and control panel as described in this appendix.

A demand analysis of water use at the building(s) to be served should be conducted to estimate average daily flow, expected daily peak flows and diurnal and weekly variations. In addition to using Table B-3 of these Design Standards to estimate system design flow, local codes may dictate specific fixture values for estimating the design flows for wastewater systems. Determination of occupancy load in New York State is per the uniform codes. Drip dispersal systems are usually designed to distribute the average daily flow with peak flows controlled by flow equalization.

The dose or pump tank should provide sufficient storage for equalization of peak flows. Storage volume is calculated to hold any peak flows expected to routinely occur over a given period, typically a day or week depending on expected flow variations. The pump tank should provide at least one-quarter of a day's storage above the alarm level, and more storage is better. Equalization storage from one-half to one day between the pump-enable water level and the alarm water level is necessary for small flow systems. Local regulations may require a specific storage capacity. The design may increase or decrease this storage based on available redundancy of facilities.

The layout of dispersal system piping achieve discharge rates and volumes that vary no more than 10 percent among all emitters within a network should provide reasonably uniform distribution over the proposed soil treatment area. The hydraulic design should saturate a zone during a complete dosing event. Consideration should be given to any unequal distribution during flow pressurizing and flow depressurizing periods. The designer should be able to mathematically support the design for equal distribution and demonstrate it upon installation. Design of the soil treatment area (sizing, depth, geometry, and orientation) should be based on the vertical hydraulic application rates given in Table E-1, in Section E.2 of these Design

Standards, as well as the following manufacturers' requirements:

- The system designer should evaluate the compatibility of system components, e.g., valves, pressure regulators, and piping for wastewater application, per manufacturer's specifications.
- Drip or other low-profile dispersal field piping layouts should provide a sufficient number and density of emitters or other flow distribution devices to achieve reasonably uniform distribution and application of the pre-treated wastewater over the entire soil treatment area. The number of drip emitters (or low-profile system orifices) should be sufficient to maintain an instantaneous loading rate (gallons per dose) that maximizes use of the hydraulic and treatment capacities of the soil and prevents breakout of wastewater on the treatment area surface during dosing.
- Emitter and dripper line spacing should be based on the permeability of the soil. Horizontal movement of water in coarse-textured soils with high permeability is much less than it is in fine textured soils, so horizontal spacing of the dripper line should be adjusted accordingly to avoid exceeding the instantaneous hydraulic capacity of the infiltrative surface. A typical range of spacing from one to four feet between emitters is sufficient. A similar layout evaluation should be done for any low-profile dispersal systems.
- Dripper line should be placed on contour and laid out to drain itself through the emitters as evenly as possible to avoid localized overloading. Similarly, the provision for free drainage by any other low-profile dispersal system should also be demonstrated and properly installed.
- Dispersal systems are often divided into zones that can be loaded independently. This is done to better adapt dispersal of wastewater to the capacity of the receiving environment and to meet the hydraulic requirements for equal distribution, field flushing of the dripper line, and reduce localized overloading from the drain down related to pressurization of the dripper line. Multiple zones also can provide standby capacity for equipment maintenance and system repairs.
- Mechanical indexing valves are not permitted with drip dispersal systems. With mechanical

indexing valves, individual zones cannot be taken out of service, individual zone loading cannot be adjusted after installation, and flushing frequency cannot be assured or verified. Similarly, for other low profile dispersal systems, independently operating zones should be designed for purposes of redundancy and maintenance access.

- Lateral lengths within a zone should be close to equal to achieve efficient flushing of each lateral. To determine suitable flushing flow and pressure requirements at the proximal end necessary to achieve flushing velocity at the distal end, the designer should obtain dripper line head loss information relating dripper line diameter, emitter spacing, and emitter and flushing flow rates to lateral lengths. Computer programs are available to aid in evaluating hydraulic design of a dispersal system. Similarly, supporting documentation for other low-profile dispersal systems' hydraulic performance should be available from the manufacturer.
- Drip dispersal systems should be designed to operate in the pressure range for the emitter operation specified by the manufacturer. The dripper line should be placed within appropriate elevation tolerance limits in each zone to maintain equal distribution within the preferred range. It may be necessary to control inlet pressure with a pressure regulating valve to control emitter flow rate. Hydraulic analyses of all segments of the system should be performed to ensure appropriate pressure and flow is achieved for both dosing and flushing conditions. Similar analyses should also be performed for any other low-profile dispersal system.
- The system provider should make available head loss charts, tables and/or formulas for various drip tubing lateral lengths during a dosing and flushing cycle and other pertinent information such as minimum / maximum zone size. Similar supporting documentation for other low-profile dispersal systems' hydraulic performance should be available from the manufacturer.
- Air/vacuum release valves should be installed at the high points in each zone to provide a vacuum break as the dripper line drains after a dose event. Breaking the vacuum is critical to prevent aspiration of soil particulates back into the dripper line through the emitter. For other low-profile dispersal designs, recommendations of the manufacturer for vacuum-breaking devices should be considered.

The dripper line or other low-profile dispersal system conduit should typically be flushed from time to time to prevent emitter or orifice clogging. When a dedicated scour cycle is present, the process should be automated to occur once every one to two weeks, with flushed solids returned to the head of the wastewater treatment system. Filtration component washing also should be automated with residual solids returned to the head of the wastewater treatment system. Continuous filter and field flush designs are not recommended. Continuous flush (CF) systems increase the potential for overloading the pre-treatment unit, compromising effluent quality discharge to the soil-based treatment area, preventing the recording of usage per zone and monitoring of overall performance.

Flushing velocities should meet or exceed the recommendations of the manufacturer of the dripper line used. A minimum velocity of 2 feet/sec should be used for soil treatment system flushing.

The pump should be designed to handle pre-treated wastewater and to manage all hydraulic operations required for the system. The dosing capacity should be sufficient to apply a full dose at the design rate for the largest zone in the system and meet flushing rate requirements. If automatic particle separators (or inline filters) are used, the pump should also be capable of achieving the back flushing or washing rate and pressure requirements of the manufacturer of the separator. Particle separation is required to reduce the size of suspended particles in wastewater effluent to prevent emitter plugging. Separators should adhere to the manufacturer's recommendations and be suitable for wastewater applications. They should be accessible for maintenance and designed to match the maintenance frequency of the system. Filtration component washing should be automated with the residual solids materials returned to the head of the wastewater treatment system.

#### Monitoring Devices

A method for measuring the volume of wastewater dispersed against elapsed time should be provided. A means to measure flow rates and operating pressures is beneficial to diagnose hydraulic problems. Continuous data recording should be considered. Drip systems should provide the means to verify field dosing and flushing flow, provide a pump cycle counter, measure pump elapsed time, and count automated flushing and alarm events.

#### Controls

An integrated controller is necessary to manage the multi-function processes of drip dispersal systems. An integrated controller may be required for other low-profile dispersal systems as well. Run times and rest times should be adjustable to manage instantaneous loading rates to regulate the demand with the field

capacity. The control panel should be located where an operator can monitor and perform diagnostics on the system. Each major component should be located to perform properly and be accessible for operation and maintenance. Manual override switches for all automated mechanical functions should be provided. Manual operation of pump and valves should be provided for an operational interface. Visual indications of specific operations are recommended.

---

## Installation

---

Only trained and otherwise qualified contractors should install drip dispersal or low-profile systems.

The installer should pay particular attention to site protection and protection of the dripper line (e.g., to avoid freezing risk) because of shallow soil installations. Installation practices should provide site protection for.

- “Top feed” manifolds should be used on all sites with sufficient slope to facilitate quick drainage.
- The main transport (supply and return) lines should be insulated and installed below the frost line and designed to supply wastewater to the “top feed” manifold with a single vertical schedule 40 PVC pipe. Care should be taken to NOT over dig the transport trench; if it is, soil compaction is required to support the pipe and prevent it from deflecting vertically, allowing drainage.
- Eighteen inches of cover is required over the soil-based treatment area. The cover depth may be divided between in-situ soil burial depth and cover by soil fill.
- Maintain dense vegetated cover should be maintained at all times. In cold climates, when sufficient vegetation (4" to 6"high) cannot be established, a 6" minimum depth of hay, straw or mulch should be maintained for protection from extensive freezing of the dispersal field.
- Box-type components (valve housings, headworks, e.g.,) should be insulated by the contractor with “blue-board” polystyrene. Bagged foam “peanuts” may be used where board insulation is not practical. Additionally, plastic film and/or a gravel bed should be used to provide an added moisture barrier. Final grading should add soil insulation to a

total of 18".

- Use one of three methods to insulate pipe:
  - Install commercially available pre-insulated pipe.
  - Insert smaller pipe inside of larger diameter pipe to create air pocket (sleeve).
  - Install board insulation over piping.
- In cold climates, use board insulation in addition to either pre-insulated or sleeved pipe if recommended by the manufacturer.
- Properly bed and haunch pipe so bedding material supports insulating board. Keep moisture out of bedding material, by using polyethylene sheet plastic to line the sides of the transport trench and over foam insulation. In cold climates two-inch board insulation is used, and two layers of two-inch board insulation may be needed for windy, exposed sites. Follow manufacturer's recommendations for further insulation details.
- Do not use foam peanuts for this application (transport pipe trench); they are not effective. Fiberglass insulation is also a poor choice due to the extremely high risk of losing all insulating value from compression or collecting moisture.
- Elevate all end loops connecting the dripper line runs one to two inches above the dripper lines at the time of final backfill to provide free drainage and minimize effluent redistribution. Similarly, for other low-profile dispersal systems low spots or "dead zones" in the conduit should be eliminated. Construction inspection is critical.
- Seal all electrical conduits entering the control box on both ends to prevent condensation or any moisture from entering.
- Place air release valves below the ground surface, inside a valve box elevated above the highest drip line in the zone to allow total drainage.
- During installation, protect the dripper line or low profile wastewater conduit against entry of construction debris and soil materials by taping or otherwise tightly covering the ends

until connections are made to the manifolds.

Installation of the dispersal system should follow the designer's plans. All aspects of the design objectives should be tested, proven, and recorded at startup to confirm they have been met.

---

#### Operation, Monitoring and Maintenance

---

Drip dispersal systems should be designed such that system operation can be monitored for proper usage and performance. The monitoring frequency should be based on how frequently components of the system need either adjustment or maintenance.

Monitoring cumulative flow, dose and field flush flow rates and pressures is necessary to diagnose possible overuse, to prevent potential system damage.

Operational monitoring should determine whether wastewater has been or is surfacing as a result of operation of the drip system and that the system is in good repair.

Only trained and otherwise qualified operators or installers should operate and service drip dispersal and low-profile systems.

For more complete guidance, see reference documents below.

---

#### Reference Documents

---

EPA. *Onsite Wastewater Treatment Systems Design Manual*, EPA/625/R-00/008. Office of Water, Office of Research and Development. Washington, D.C. February 2002.

National Onsite Wastewater Recycling Association (NOWRA). *Subsurface Drip Dispersal Systems Workshop Manual*. National Onsite Wastewater Recycling Association, Edgewater, Maryland. 2001.

NOWRA - *Recommended Guidance for the Design of Wastewater Drip Dispersal Systems*. Approved and adopted by the NOWRA Board of Directors, March 23, 2006.

CIDWT. *Residential Onsite Wastewater Treatment Systems: An Operation and Maintenance Service Provider Program*. Consortium of Institutes for Decentralized Wastewater Treatment (CIDWT), 2005.



American Society for Testing and Materials (ASTM), West Conshohocken, Pennsylvania.

- ASTM D5925-96. *Standard Practice for Preliminary Sizing and Delineation of Soil Adsorption Field for On-site Septic Systems*. 1996.
- ASTM D5879-95. *Standard Practice for Surface Characterization for On-site Systems*. 1996.
- ASTM D5921-96. *Standard Practice for Subsurface Site Characterization of Test Pits for On-site Septic Systems*. 1996.

Texas Cooperative Extension, Texas A&M University System. *Drip Dispersal Systems for Land Application of Effluents*.

EPRI & TVA (Tennessee Valley Authority), *Wastewater Subsurface Drip Distribution, Peer Reviewed Guidelines for Design, Operation, and Maintenance*. Report #1007406, Revised Report, September 2004, Electric Power Research Institute and Tennessee Valley Authority, co-sponsors. Electric Power Research Institute (EPRI), Concord, California.

# Appendix F – Single Pass and Recirculating Filter Performance<sup>80</sup>

Reference	BOD			TSS			TKN			TN			Fecal Coliforms			Footnotes <sup>64,65</sup>
	Inf	Eff	%	Inf	Eff	%	Inf	Eff	%	Inf	Eff	%	Inf	Eff	%	
	(mg/L)		Rem.	(mg/L)		Rem.	(mg/L)		Rem.	(mg/L)		Rem.	(mg/L)		Rem.	
<b>Single Pass Filters</b>																
Cagle & Johnson (1994) <sup>66</sup> - California	160	2	98.75	73	16	78.08	61.8	5.9	90.45	61.8	37.4	39.48	1.14 <sup>67</sup>	111	99.90	<sup>68</sup>
Effert, et al. (1985) <sup>66</sup> - Ohio	127	4	96.85	53	17	67.92	-	-	-	41.5	37.5	9.64	2.19 <sup>67</sup>	1,600	99.27	<sup>69</sup>
Royanne, et al. (1982) <sup>66</sup> - Oregon	217	3	98.62	146	20	93.15	57.1	1.7	97.02	57.5	30.3	47.30	2.60 <sup>67</sup>	407	99.84	<sup>70</sup>
Sievers (1998) <sup>66</sup> - Missouri	297	3	98.99	44	3	93.18	37	0.5	98.65	37.1	27.5	25.88	4.56 <sup>67</sup>	73.0	99.98	<sup>71</sup>
<b>Recirculating Filters</b>																
Louden, et al. (1985) <sup>65</sup> - Michigan	150	6	96.00	42	6	85.71	55	2.3	95.82	55	26	52.73	.034 <sup>67</sup>	14.0	99.59	<sup>72</sup>
Piluk & Peters (1994) <sup>65</sup> - Maryland	235	5	97.87	75	8	89.33	-	-	-	57	20	64.91	18.0 <sup>67</sup>	9,200	99.49	<sup>73</sup>
Royanne, et al. (1982) <sup>66</sup> - Oregon	217	3	98.62	146	4	97.26	57.1	1.1	98.07	57.5	31.5	45.22	2.60 <sup>67</sup>	8,500	96.73	<sup>74</sup>
Roy & Dube (1994) <sup>66</sup> - Quebec	101	6	94.06	77	3	96.10	37.7	7.9	79.05	37.7	20.1	46.68	4.80 <sup>67</sup>	13,000	97.29	<sup>75</sup>
Ayres Assoc. (1998) <sup>76</sup> - Wisconsin	601	10	98.34	546	9	98.35	65.9	3	95.45	65.9	16	75.72	>2,500	62.0	>98	<sup>77</sup>
Owen & Bobb (1994) <sup>78</sup> - Wisconsin	80	8	90.00	36	6	83.33	-	-	>95	-	-	-	-	-	-	<sup>79</sup>

<sup>64</sup> 1 gpd/ft<sup>2</sup> = 4cm/day = 0.04m<sup>3</sup>/m<sup>2</sup>-day

<sup>65</sup> 1 lb BOD/1,000ft<sup>2</sup>-day = 0.00455 kg/m<sup>2</sup>-day

<sup>66</sup> Single-family home filters

<sup>67</sup> Value is multiplied by 10,000

<sup>68</sup> Sand Media: es=0.25-0.65 mm; uc=3-4. Design hydraulic loadings=1.2 gpd/ft<sup>2</sup> based on 150 gpd/bedroom. Actual flows not measured.

<sup>69</sup> Sand Media: es=0.4 mm; uc=2.5. Average loadings=0.4 gpd/ft<sup>2</sup> / 0.42lb BOD/1,000 ft<sup>2</sup>. Doses per day=3.3.

<sup>70</sup> Sand Media: es=0.14-0.30 mm; uc=1.5-4.0. Average loadings=0.33gpd/ft<sup>2</sup> / 0.6-1.27 lb BOD/1,000 ft<sup>2</sup> per day.

<sup>71</sup> Sand Media: not reported. uc=3-4. Design hydraulic loading = 1 gpd/ft<sup>2</sup>. Daily flows not reported.

<sup>72</sup> Sand Media: es=0.3 mm; uc=4.0; Average loadings=0.9 gpd/ft<sup>2</sup> (forward flow) / 1.13lb BOD/1,000 ft<sup>2</sup>-day. Recirculation ratio=3:1. Dosed 4 to 6 times per hour. Open surface.

<sup>73</sup> Sand Media: es=1 mm; uc≤ 2.5; Design hydraulic loadings=3.54 gpd/ft<sup>2</sup> (forward flow). Actual flow not measured. Recirculation ratio=3:1. Doses per day =24

<sup>74</sup> Sand Media: es=1.2 mm; uc= 2.0; Maximum hydraulic loadings=3.1 gpd/ft<sup>2</sup> (forward flow). Recirculation ratio=3:1 to 4:1. Doses per day =48

<sup>75</sup> Gravel Media: es=4.0; uc≤ 2.5; Design hydraulic loadings=23.4 gpd/ft<sup>2</sup> (forward flow); Recirculation ratio=5:1. Doses per day =48. Open surface, winter operation.

<sup>76</sup> Restaurant (grease and oil inf/eff = 119/<1 mg/L respectively)

<sup>77</sup> Gravel Media: pea-gravel (3/8 in. dia.); Design hydraulic loadings=15 gpd/ft<sup>2</sup> (forward flow); Recirculation ratio= 3:1 to 5:1. Doses per day =72. Open surface, seasonal operation.

<sup>78</sup> Small community treating average 15,000 gpd of septic tank effluent

<sup>79</sup> Sand Media: es=1.5 mm; uc=4. 5; Design hydraulic loadings=2.74 gpd/ft<sup>2</sup> (forward flow); Recirculation ratio=1:1 to 4:1. Open surface, winter operation.

<sup>80</sup> Table 4-16 of EPA/625/R-00/008

## Glossary

**Blackwater:** Wastewater from toilets (i.e., flush water carrying human excreta), urinals, or kitchen sinks that include integral garbage disposal units.

**Certified Tank:** A certified tank is a tank (of any material) that has been certified by a licensed professional engineer in accordance with a certification program established by a nationally recognized organization. It can also mean that the tank has been certified by a nationally recognized organization.

**Conventional Septic System:** A septic tank followed by gravity flow to a subsurface soil-based treatment system.

**Decentralized Wastewater System:** A wastewater treatment system used for collection, treatment, dispersal or reuse of wastewater from individual homes, clusters of homes, isolated communities, industries, or institutional facilities, at or near the point of waste generation (CIDWT Glossary, 2007).

**Design Engineer:** A person or firm licensed to practice professional engineering in NYS.

**Enhanced Treatment Unit:** A treatment unit that provides secondary or tertiary treatment of wastewater.

**Flood-prone areas:** Those areas identified as the one percent (1 percent) annual chance floodplain on FEMA's Flood Insurance Rate Map.

**FOG:** Animal fats, vegetable oils and petroleum greases.

**Galley system:** An effluent disposal system designed to function under impervious surfaces and support specified loads applied to the impervious surface.

**Gravity Grease Interceptor (Type II):** An exterior vessel (precast concrete, HDPE plastic, polypropylene, or fiberglass reinforced polyester [FRP]) used to separate by gravity, retain for disposal, and minimize short-circuiting and turbulence to facilitate FOG separation.

**Graywater:** Wastewater discharged from clothes washers, bathtubs, showers, dishwashers, and sinks (including kitchen sinks without garbage disposal units), but excluding “blackwater,” fats, oils and greases (FOG), and industrial wastewater containing toxic or hazardous materials. Note: For graywater irrigation systems (Section D.12) the discharged wastewater should be restricted from including high levels of pathogens from the washing of heavily soiled or potentially infectious laundry such as diapers, or similarly soiled garments unless the graywater is disinfected before irrigation.

**Horizon (Soil Horizon):** One of a few distinct layers of soil exposed in a percolation test hole, soil pit, or soil treatment area under construction, each having its own set of distinguishing soil characteristics.

**Hydro-mechanical Grease Interceptor (Type D):** (“Grease Trap” is a discontinued term as of 2007 national codes, and 2010 NYS codes.) An interior, under-sink, hydro-mechanical device or vessel used to help facilitate grease separation, collection and disposal. The brown grease collected from these devices cannot be recycled or reused for human or animal consumption or contact.

**Linear Loading Rate (LLR):** The hydraulic loading rate in gallons per day of applied wastewater per linear foot of distribution pipe/chamber length. It is based on the hydraulic conductivity and horizontal flow component of each soil horizon. See these design Standards Section E.12 Mound Systems, Mound Design – Large Systems, and *Wisconsin Mound Soil Absorption System: Siting, Design and Construction Manual* by James C. Converse and E. Jerry Tyler, January , 20002, SSWMP guidance document #15.24.

**Primary Treatment:** The first stage of wastewater treatment that removes settleable or floating solids only; generally removes 40 percent of the suspended solids and 30 to 40 percent of the BOD in the wastewater.

**Recirculation Ratio:** The Recirculation Ratio is defined as the ratio of the total flow through the sand filter to the forward (average design) wastewater flow in a recirculating sand filter design.

**Responsible Management Entity (RME):** A legal entity that has the managerial, financial, and technical capacity to ensure the long-term cost-effective operation of onsite or cluster wastewater treatment systems in accordance with applicable regulations and performance requirements (e.g.: a wastewater utility or wastewater management district).

**Reviewing Engineer:** An employee of NYSDEC, NYSDOH, a County or City Health Department, and licensed to practice professional engineering in NYS.

**Secondary Treatment:** A type of wastewater treatment used to convert dissolved and suspended pollutants into a form that can be removed. Secondary treatment normally utilizes biological treatment processes (activated sludge, trickling filters, etc.) followed by settling tanks and will remove approximately 85 percent of the BOD and TSS in wastewater.

**Significant Delivery Period:** The period of time during which wastewater daily flow occurs that is substantially less than 24 hours. This period of time may become a factor in design if the flow during the significant delivery period is such that it overwhelms treatment units that were otherwise designed to handle a more uniform flow.

**Snubber:** A restraining device used to control the movement of pipe (and equipment) during abnormal dynamic conditions such as earthquakes, safety/relief valve discharge and rapid valve closure.

**Soil Acceptance Rate (SAR) or Long -Term Acceptance Rate (LTAR):** The rate at which wastewater can be applied to a STS such that the soil microbiology consumption rate is in equilibrium with the wastewater loading being applied.

**Soil-based Treatment Area (STA):** The area devoted to the active subsurface wastewater infiltration system, or alternating and active system zones, plus any required tapered fill areas, slopes and setbacks.

**Soil-based Treatment System (STS):** The excavation and the piping components used to distribute and infiltrate the wastewater into the subsurface soil.

**Tertiary Treatment:** Tertiary wastewater treatment includes physical, biological, or chemical processes (or any combination of these processes) performed in a wastewater treatment facility. These processes remove pollutants that are not adequately removed by conventional secondary treatment processes. These pollutants may include toxic materials, nutrients, residual organics, soluble minerals, and other materials.

**Top of Embankment:** The highpoint of an embankment or steep slope where the slope on the far side of the slope or embankment is very steep, or where one or more soil horizons have been excavated or eroded away, and where the near side of the same landscape feature has slopes sufficiently gradual for system construction.